

BTS-101

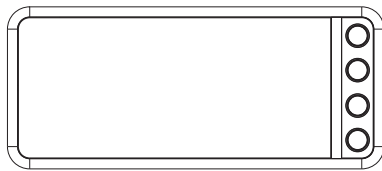

GB

Version 1

The Bluetooth® word mark and logos are registered trademarks owned by Bluetooth SIG, Inc. and any use of such marks by SANGHEAN ELECTRONICS INC. is under license.

© 2013 CSR plc and its group companies.

The aptX® mark and the aptX logo are trademarks of CSR plc or one of its group companies and may be registered in one or more jurisdictions.

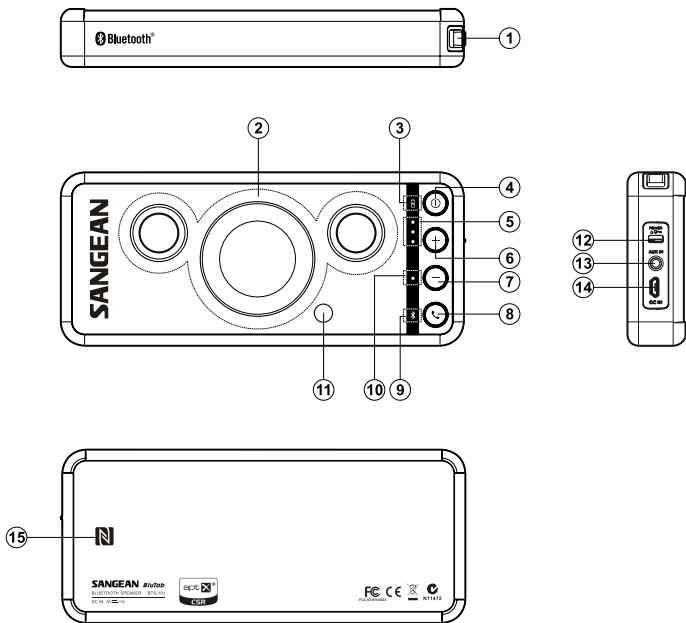

Control

- | | |
|---|------------------------------|
| ① Strap holder | ⑨ Bluetooth status indicator |
| ② Speaker | ⑩ Max volume indicator |
| ③ Battery charging indicator | ⑪ Microphone |
| ④ Power button | ⑫ Power lock |
| ⑤ Battery status indicator | ⑬ Aux in socket |
| ⑥ Volume up button | ⑭ DC In |
| ⑦ Volume down button | ⑮ NFC detection tag |
| ⑧ Bluetooth/Call answer-hangup button/Play and Pause button | |

Charging the unit

This unit operates on a built-in Li-ion battery that can be recharged either using the USB charging port or from a USB power adaptor (not included) with a rated output of DC 5V, 1000mA.

The first time using your BluTab (BTS-101) speaker, connect it to DC (mains) power and fully charge the battery. When the battery is charging in progress, battery charging indicator is in solid red. After the battery is charged fully, the red battery charging indicator will turn off.

Note:

You can begin using the speaker while charging. Please be aware that in this case make sure the USB power source can provide 5V 1A of electrical current. If not, it may damage the USB power source.

1. Connect the (supplied) micro USB plug to the micro USB charging port on the right hand side of the unit.
2. Connect the (supplied) standard USB plug end of the cable to a power USB port on a computer or other USB charging device. When the battery is charging, the battery indicator illuminates in steady red light. If the indicator fades away indicating the battery is fully charged and the battery charging is stopped.

Power on the speaker

Before power-on the speaker, make sure to set the power lock to its off position.

There are two ways to power on your speaker.

- You can press and hold the Power button to turn on the speaker.
- In addition, the speaker can be powered on via NFC: Turn on your NFC feature on your NFC-enabled device > Hold your NFC-enabled device directly against BluTab's NFC tag for 2 seconds. Once the speaker is powered on successfully, the speaker will make a sound to confirm.

Note:

some devices may ask for confirmation from the user.

Pairing and connecting a device to the speaker

Pairing and playing your Bluetooth device for the first time

You need to pair your Bluetooth device with your BluTab (BTS-101) before you can auto-link to play/stream Bluetooth music through your Bluetooth speaker. Pairing creates a 'bond' so two devices can recognize each other.

GB

1. Before turning on the speaker, make sure the power lock is switched off. The Bluetooth status indicator (📶) on the speaker flashes fast flashing blue to show the speaker is discoverable.
2. Activate Bluetooth on your device according to the device's user manual to link to the speaker. Locate the Bluetooth device list and select the device named 'SANGEAN BLUTAB.' With some mobiles (which are equipped with earlier versions than BT2.1 Bluetooth device), you may need to input the pass code "0000".
3. Once connected, there will be a beep sound and the Bluetooth icon will remain in solid blue. You can simply select and play any music from your source device. Volume control can be adjusted from your source device, or directly on BluTab.
(Note: If the maximum volume of the speaker has been reached, indicator for 'MAX VOL.' marked on the front panel stay solid red for 2 seconds.)
4. Use the controls on your device to play/pause and navigate tracks. In addition, you can press and release the Bluetooth/Call answer-hangup button to play/pause the tracks.
(Note: If you press the Bluetooth/Call answer-hangup button twice in quick succession, your BluTab will redial the last phone number made on your smartphone.)



Note:

- 1) If 2 Bluetooth devices, pairing for the first time, both search for BluTab (BTS-101), it will show its availability on both devices. However, if one device links with the speaker first, then the other Bluetooth device won't find the speaker on its list.

- 2) If your Bluetooth-enabled device is temporarily disconnected to your speaker. As long as the disconnection last within 10 minutes, your device can re-connect with your radio again automatically. If the disconnection last more than 10 minutes, then you need to manually reconnect your device again to the radio. Be aware that during the period of disconnection, no other Bluetooth device can pair or link with your radio.
- 3) If 'SANGEAN BLUTAB' shows in your Bluetooth device list but your device cannot connect with it, please delete the Sangean BluTab item from your list and pair the device with the speaker again following the steps described previously.
- 4) Bluetooth/NFC connectivity performance may vary depending on the connected Bluetooth devices. Please refer to the Bluetooth capabilities of your device before connecting to your radio. All features may not be supported on some paired Bluetooth devices.
- 5) The effective operation range between the system and the paired device is approximately 10 meters (30 feet).
- 6) Any obstacle between the system and the device can reduce the operational range.

Pairing additional devices

Before pairing another device to the speaker, you need to make the speaker discoverable.

1. Press and hold the Bluetooth/Call answer-hangup button () , so the Bluetooth status indicator () blinks fast flashing blue.
2. Activate Bluetooth on your device according to the device's user manual to link to the speaker. Locate the Bluetooth device list and select the device named 'SANGEAN BLUTAB.' With some mobiles which are equipped with earlier versions than BT2.1 Bluetooth device, you may need to input the pass code "0000".

- Once connected, there will be a beep sound and the Bluetooth icon will remain in solid blue. You can simply select and play any music from your source device.

Speaker memory and reconnecting a device

BluTab can memorize up to 8 sets of paired device, when the memory exceed this amount, the least-recently-paired device will be erased from the radio.

If your Bluetooth device already paired with the speaker previously, the unit will memorize your Bluetooth device and it attempts to reconnect with a device in memory which is last connected. If the last connected device is not available, the speaker will be discoverable.

Switching to a different device

BluTab can connect two Bluetooth devices at once. You can switch the speaker from your current connected device to another previously-paired device by pausing one and playing the other. Please note that the device you are switching to must be in the speaker memory.

Pairing and playing your device via NFC

Your speaker is equipped with wireless NFC (Near Field Communication) feature, allowing NFC-enabled devices to pair and play the music with your BluTab. For non-NFC devices, please refer to the above sections for standard Bluetooth pairing.

- Press and hold the Power button to turn on the speaker. The Bluetooth status indicator () on the speaker flashes fast flashing blue to show the speaker is discoverable.
- Turn on your NFC feature on your device.

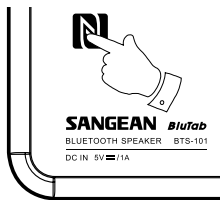

3. Touch the NFC area of your playing device directly against the NFC tag marked on the rear panel of your BluTab. The unit then automatically connected with your NFC-enabled device. (If you pair with BluTab for the first time, some NFC-enabled device will be asked the permission to link with the speaker). Once paired with a device, 'Connecting BluTab...' is shown on your NFC-enabled device. The speaker beeps and the Bluetooth icon will illuminate in solid blue.
(Important: Please make sure the screen of your playing device is on and unlocked to allow NFC to work.)
4. Use the controls on your device to play/pause and navigate tracks. In addition, you can press and release the Bluetooth/Call answer-hangup button to play/pause the tracks.

Note:

1. If you would like to link another Bluetooth device for the first time via NFC, disconnect the existing linked Bluetooth device first.
2. The location of the NFC detection area is not the same on all devices. When connecting with other Bluetooth device via NFC, refer to the User guide of the other device for more information.
3. Some of metallic case or cover for mobile phones may reduce the sensitivity of NFC. Make sure you remove it, before activating the NFC.

Disconnecting your NFC-enabled device

To disconnect your device, simply touch directly against the speaker's tag again on the back panel. The speaker will beep and the Bluetooth status indicator () on the speaker flashes fast flashing blue to show the speaker is discoverable.

Playing music via auxiliary input socket

A 3.5mm Auxiliary input socket is provided on the right hand side of the unit to permit an audio signal to be fed into the unit from any devices that features a headphone or audio output, such as an iPod, MP3 or CD player.

GB

1. Connect a stereo or mono audio source (for example, iPod, MP3 or CD player) to the Auxiliary input socket.
2. Adjust the Volume control on your iPod, MP3 or CD player to ensure an adequate signal and then adjust the volume on the speaker for comfortable listening.

Note:

When Aux in socket is connected an audio device, Bluetooth function will be disabled to minimize power consumption.



Using BluTab as handsfree speaker phone

Your speaker can be used as a speakerphone. When calls come in to your music source device while the music is playing, it will pause the music automatically to allow you to answer your phone.

1. Pair your device to the speaker via Bluetooth as described in the previous sections.
2. Press and release the Bluetooth/Call answer-hangup button to answer and hang up your phone call.
3. Press the Volume up/down buttons to adjust the volume to your liking.
4. To redial the last phone call made on your smartphone, double click the Bluetooth/Call answer-hangup button in quick succession.

Note:

If you cannot answer/hang up your phone via your speaker, it may be necessary to check whether the 'Phone audio' setting is activated on your Bluetooth-enabled device.

Power lock

The power lock function is used to prevent unintentional power-on of the speaker in order to minimize unnecessary battery drainage. When power lock is activated (slide-up), there is no power supply and all function keys will be disabled including NFC tag detection.

To disable the lock function, slide the power lock switch to its off position. The power lock function will then be disabled.

Battery management

To check the current battery charge level, press and hold the Power button to turn on the speaker and battery status indicator is shown in solid green indicating the current battery life:

(): battery is fully charged (more than 70% of battery capacity)

(): battery is medium charged (between 30%- 70% of battery capacity)

(): battery Charging is needed (less than 30% of battery capacity)



Safety information for internal rechargeable Lithium-ion battery

The internal rechargeable lithium-ion battery used in this device is able to supply power for a long period of time. However, even lithium-ion batteries reach a point where they cannot be recharged. If the battery does not recharge after several attempts, it may be drained (has a low charge), please contact info@sangean.com.tw for repair information.

However, if you do not want us to replace the battery, you will need to dispose of used batteries/device in accordance to the laws and regulations in your area. In addition, you can contact your local electronics retailers or recycling center for disposal.

User Safety Precautions

- Check the room temperature range is 0°C–45°C (32°-113°Fahrenheit) before charging the battery.
- Do not attempt to disassemble the plastic covering or any parts of the device, as the materials inside may be toxic and may damage skin and clothes.
- Do not puncture, crush, modify, throw or cause any unnecessary shock to your battery, as the battery used in this device may present a risk of fire, explosion, or chemical burn if mistreated.
- Do not leave, charge or use the battery in a car under direct sunlight, near fire or a heated source.
- Do not immerse, throw, wet the battery in water/seawater.
- Do not use or charge the battery if it appears to be abnormally hot, discoloration, deformation or abnormal conditions is detected during use, charge or storage.
- Do not leave a charging battery unattended. Keep the battery away from babies and children.

IMPORTANT NOTE:

To comply with the FCC RF exposure compliance requirements, no change to the antenna or the device is permitted. Any change to the antenna or the device could result in the device exceeding the RF exposure requirements and void user's authority to operate the device.

Notice : The changes or modifications not expressly approved by the party responsible for compliance could void the user ' s authority to operate the equipment.

Specifications

Amplifier

Output power	1.5W+1.5W
Frequency response	150Hz~20kHz

Aux In

Input sensitivity	250mVrms @100Hz
-------------------	-----------------

Speaker

Stereo speaker	28mm 4 ohm 3W Full range
----------------	--------------------------

Bluetooth

Bluetooth specification	Bluetooth® Ver 4.0
Profile Support	A2DP, AVRCP(Only Play&Pause), HFP V1.6, HSP V1.2
Bluetooth Audio CODEC	aptX, SBC, MP3
Transmitting Power	Specification Power Class 2
Line of sight range	10 meters/30 feet

Built-in Battery

Battery	Rechargeable Lithium-ion battery 18650 3.7V 2200mAH
---------	--

General

DC-IN	Micro USB jack 5V 1A
Power consumption	5V 0.5A (Charging in power OFF mode) 5V 1A (Charging in power ON mode)
Charging current	0.5A
Charging time	5 hours
Storage temperature	-20°C~ 60°C
Operating temperature	-10°C ~ 45°C
Weight	330g

The equipment has been tested and found to comply with the limits for a Class B Digital Device, pursuant to part 15 of the FCC Rules. These limits are designed to provide reasonable protection against harmful interference in a residential installation. This equipment generates, uses and can radiate radio frequency energy and, if not installed and used in accordance with the instruction, may cause harmful interference to radio communication.

However, there is no grantee that interference will not occur in a particular installation. If this equipment dose cause harmful interference to radio or television reception, which can be determined by turning the equipment off and on , the user is encouraged to try to correct the interference by one or more of the following measures:

- Reorient or relocate the receiving antenna.
- Increase the separation between the equipment and receiver.
- Connect the equipment into an outlet on a circuit different from that to which the receiver is connected.
- Consult the dealer or an experienced radio/TV technician for help.

The company reserves the right to amend the specification without notice.



If at any time in the future you should need to dispose of this product please note that: Waste electrical products should not be disposed of with household waste. Please recycle where facilities exist. Check with your Local Authority or retailer for recycling advice. (Waste Electrical and Electronic Equipment Directive)