

H200

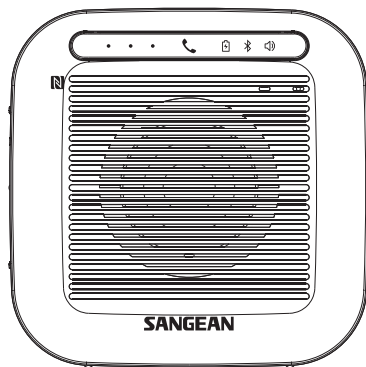

GB

Version 1



The Bluetooth® word mark and logos are registered trademarks owned by Bluetooth SIG, Inc. and any use of such marks by SANGEAN ELECTRONICS INC. is under license.

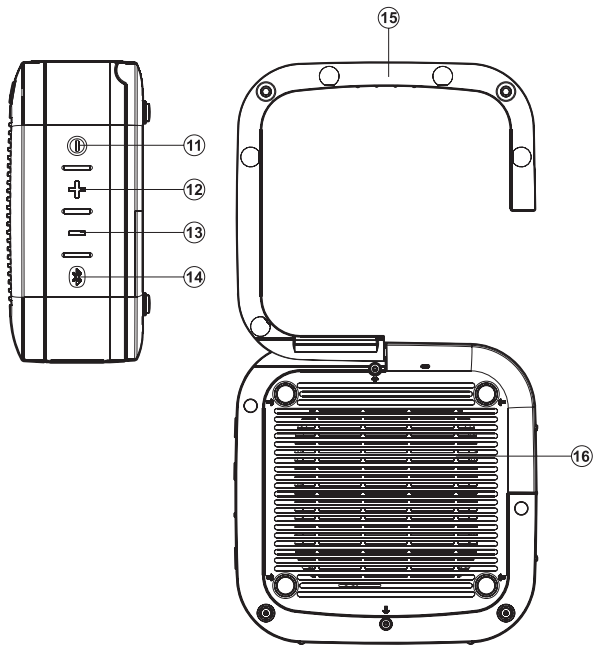
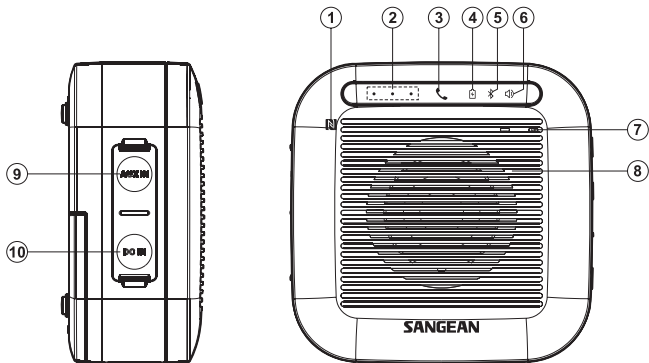

Controls

- ① NFC detection tag
- ② Battery status indicator
- ③ Call answer-hangup button/Call indicator
- ④ Battery charging indicator
- ⑤ Bluetooth status indicator
- ⑥ Max volume indicator
- ⑦ Microphone
- ⑧ Powered Speaker
- ⑨ Aux in socket
- ⑩ DC In
- ⑪ Power button
- ⑫ Volume up button
- ⑬ Volume down button
- ⑭ Bluetooth button
- ⑮ Folding handle
- ⑯ Passive speaker

GB

Charging the unit

This unit operates on a built-in Lithium-ion battery that can be recharged either using the USB charging port or from a USB power adaptor (not included) with a rated output of DC 5V, 1000mA.

The first time using your H200 speaker, connect it to DC (mains) power and fully charge the battery. When the battery is in charging mode, the battery charging indicator light will be in solid red. After the battery is fully charged, the red battery charging indicator will turn off.

Note:

You can begin using the speaker while charging. Please be aware that in this case make sure the USB power source can provide 5V 1A of electrical current. If not, it may damage the USB power source.

1. Connect the (supplied) micro USB plug to the micro USB charging port on the left hand side of the unit.
2. Connect the (supplied) standard USB plug end of the cable to a power USB port on a computer or other USB charging device. When the battery is charging, the battery indicator light will be solid red. If the indicator light fades away this indicates that the battery is fully charged and battery charging will be stopped.

Power on the speaker

There are two ways to power on your speaker.

- You can press and hold the Power button to turn on the speaker.
- In addition, the speaker can be powered on via NFC: Turn on the NFC feature on your NFC-enabled device > Hold your NFC-enabled device directly against the H200's NFC tag for 2 seconds. Once the speaker is powered on successfully, the speaker will make a sound to confirm the power is on.

Note:

Some devices may ask for confirmation from the user.

Pairing and connecting a device to the speaker

Pairing and playing your Bluetooth device for the first time

You need to pair your Bluetooth device with your H200 before you can auto-link to play/stream Bluetooth music through your Bluetooth speaker. Pairing creates a 'bond' so the two devices can recognize each other.

1. Turn on the speaker. The Bluetooth status indicator () on the speaker will flash a fast blue to show the speaker is discoverable.
2. Activate Bluetooth on your device according to the device's user manual to link to the speaker. Locate the Bluetooth device list and select the device named 'H200'. With some mobile devices (which are equipped with earlier versions than BT2.1 Bluetooth device), you may need to input the pass code "0000".
3. Once connected, there will be a confirmation tone sound and the Bluetooth icon will turn a solid blue. You can simply select and play any music from your source device. Volume control can be adjusted from your source device, or directly on H200. (**Note:** If the maximum volume of the speaker has been reached, the indicator for 'MAX VOL.' marked on the front panel will stay solid red for 2 seconds.)

4. Use the controls on your device to play/pause and navigate tracks.

Note:

1. If 2 Bluetooth devices are pairing for the first time, both will search for the H200, it will show its available on both devices. However, if one device links with the speaker first, then the other Bluetooth device will not find the speaker on its list.
2. If you take your source device out of range, the connection will be temporarily disconnected to your speaker. Your speaker will automatically reconnect if the source device is brought back in range within 1 minute. Otherwise you need to manually reconnect your device again to the speaker. Be aware that during the period of disconnection, no other Bluetooth device can pair or link with your speaker.
3. If 'H200' shows in your Bluetooth device list but your device cannot connect with it, please delete the H200 item from your list and pair the device with the speaker again following the steps described previously.
4. Bluetooth/NFC connectivity performance may vary depending on the connected Bluetooth devices. Please refer to the Bluetooth capabilities of your device before connecting to your speaker. All features may not be supported on some paired Bluetooth/NFC devices.
5. The effective operation range between the system and the paired device is approximately 10 meters (30 feet).
6. Any obstacles between the system and the device can reduce the operational range.

Pairing additional devices

Before pairing another device to the speaker, you need to make the speaker discoverable.

1. Press and release the Bluetooth button to disconnect from your Bluetooth device. The Bluetooth status indicator () blinks a fast flashing blue.
2. Activate Bluetooth on your device according to the device's user manual to link to the speaker. Locate the Bluetooth device list and select the device named 'H200'. With some mobile devices which are equipped with earlier versions than BT2.1 Bluetooth device, you may need to input the pass code "0000".
3. Once connected, there will be a confirmation tone sound and the Bluetooth icon will remain in solid blue. You can simply select and play any music from your source device.

Speaker memory and reconnecting a device

The H200 can memorize up to 2 paired devices. When the memory exceeds this amount, the earliest paired device will be erased from the speaker. If your Bluetooth device was already paired with the speaker previously, the unit will memorize your Bluetooth device and will attempt to reconnect with a device that is in the memory that was last connected. If the last connected device is not available, the speaker will be discoverable.

Disconnecting your Bluetooth device

Press and release the Bluetooth button on the H200 to disconnect with your Bluetooth device or turn off Bluetooth function on your Bluetooth device to disable the connection. There will be a confirmation tone sound and the Bluetooth status indicator () on the speaker will flash a fast blue to show the speaker is discoverable again for pairing.

Pairing and playing your device via NFC

GB

Your speaker is equipped with wireless NFC (Near Field Communication) feature, allowing NFC-enabled devices to pair and play the music with your H200. For non-NFC devices, please refer to the above sections for standard Bluetooth pairing.

1. Turn on the NFC feature on your device.
2. Touch the NFC area of your playing device directly against the NFC tag marked on the front panel of your H200. The speaker will automatically be switched on and connect your NFC-enabled device. (If you pair with the H200 for the first time, some NFC-enabled device will be asked permission to link with the speaker). Once paired with a device, 'Connecting H200...' or a similar message is shown on your NFC-enabled device. There will be a confirmation tone sound and the Bluetooth icon will illuminate in solid blue. (Important: Please make sure the screen of your playing device is on and unlocked to allow NFC to work.)
3. Use the controls on your device to play/pause and navigate tracks.

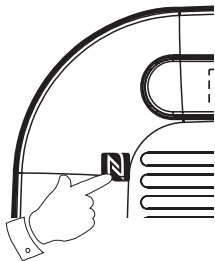

Note:

1. If you would like to link another Bluetooth device for the first time via NFC, disconnect the existing linked Bluetooth device first.
2. The location of the NFC detection area is not the same on all devices. When connecting with other Bluetooth devices via NFC, refer to the user guide of the device for more information and location of the NFC detection area.
3. Some metallic cases or covers for mobile phones may reduce the sensitivity of NFC. Make sure you remove it before activating the NFC function.

Disconnecting your NFC-enabled device

To disconnect your device, simply touch your device directly against the speaker's tag again on the front panel. There will be a confirmation tone sound and the Bluetooth status indicator (⌘) on the speaker will flash a fast blue to show the speaker is discoverable.

Playing music via auxiliary input socket

A 3.5mm Auxiliary input socket is provided on the left hand side of the unit to permit an audio signal to be fed into the unit from any devices that features a headphone or audio output, such as an iPod, MP3 or CD player.

1. Connect a stereo or mono audio source (for example, iPod, MP3 or CD player) to the Auxiliary input socket.
2. Adjust the Volume control on your iPod, MP3 or CD player to ensure you have an adequate signal and then adjust the volume on the speaker to your preferred listening level.

Note:

When the Aux in socket is connected to an audio device the Bluetooth function will be disabled to minimize power consumption.

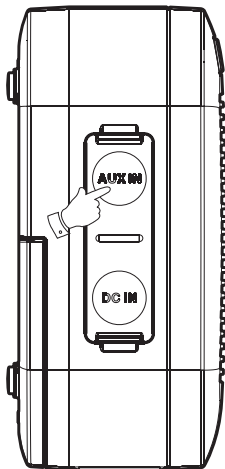

Using the H200 as a hands-free speaker phone

The H200 can be used as a hands-free accessory for your phone. When music is playing through your H200 and you receive a call on your phone it can pause the music automatically to allow you to answer your phone.

GB

1. Pair your device to the speaker via Bluetooth as described in the previous sections.
2. If you receive a call while playing music through your H200, the Call indicator (📞) will flash a fast yellow.
3. Press and release the Call answer-hangup button to answer your phone call and then the Call indicator (📞) will remain a solid yellow. Speak in the direction of the built-in microphone.
4. Press the Volume up/down buttons to adjust the volume to your liking. Note that a very high volume setting may decrease sound quality.
5. Press and release the Call answer-hangup button to end the phone call. The music on the speaker will continue to play.

Note:

If you cannot answer/hang up your phone via your H200, it may be necessary to check whether the 'Phone audio' setting is activated on your Bluetooth-enabled device.

Battery management

To check the current battery charge level, press and hold the Power button to turn on the speaker and battery status indicator is shown in solid green indicating the current battery life:

(): battery is fully charged (more than 70% of battery capacity)

(): battery is medium charged (between 30%- 70% of battery capacity)

(): battery Charging is needed (less than 30% of battery capacity)



Safety information for the internal rechargeable Lithium-ion battery

The internal rechargeable lithium-ion battery used in this device is able to supply power for a long period of time. However, even lithium-ion batteries reach a point where they cannot be recharged. If the battery does not recharge after several attempts, it may be drained (has a low charge), please contact info@sangean.com.tw for repair information.

However, if you do not want us to replace the battery, you will need to dispose of used batteries/device in accordance to the laws and regulations in your area. In addition, you can contact your local electronics retailers or recycling center for disposal.

User Safety Precautions

- Ensure that the room temperature range is 0°C–45°C (32°–113°Fahrenheit) before charging the battery.
- Do not attempt to disassemble the plastic covering or any parts of the device, as the materials inside may be toxic and may damage skin and clothes.
- Do not puncture, crush, modify, throw or cause any unnecessary shock to your battery, as the battery used in this device may present a risk of fire, explosion, or chemical burn if mistreated.
- Do not leave, charge or use the battery in a car under direct sunlight, near fire or a heated source.
- Do not immerse or throw the battery in water/seawater.
- Do not use or charge the battery if it appears to be abnormally hot, discolored, deformed or abnormal conditions are detected during use, charge or storage.
- Do not leave a charging battery unattended. Keep the battery away from babies and children.

For United States:**FCC Cautions to the user**

The changes or modifications not expressly approved by the party responsible for compliance could void the user's authority to operate the equipment.

RF exposure statements**IMPORTANT NOTE:**

To comply with the FCC RF exposure compliance requirements, the antenna(s) used for this transmitter must be installed to provide a separation distance of at least 20cm (8 inches) from all persons and must not be co-located or operating in conjunction with any other antenna or transmitter. No change to the antenna or the device is permitted. Any change to the antenna or the device could result in the device exceeding the RF exposure requirements and void user's authority to operate the device.

Note:

This equipment has been tested and found to comply with the limits for a Class B digital device, pursuant to part 15 of the FCC Rules. These limits are designed to provide reasonable protection against harmful interference in a residential installation. This equipment generates, uses and can radiate radio frequency energy and, if not installed and used in accordance with the instructions, may cause harmful interference to radio communications. However, there is no guaranty that interference will not occur in a particular installation. If this equipment does cause harmful interference to radio or television reception, which can be determined by turning the equipment off and on, the user is encouraged to try to correct the interference by one or more of the following measures:

- Reorient or relocate the receiving antenna.
- Increase the separation between the equipment and receiver.
- Connect the equipment into an outlet on a circuit different from that to which the receiver is connected.
- Consult the dealer or an experienced radio/TV technician for help.

CAUTION:

These servicing instructions are for use by qualified service personnel only. To reduce the risk of the electric shock, do not perform any servicing other than that contained in the operating instructions unless you are qualified to so.

Specifications

Amplifier

Output power	1.5W
Frequency response	100Hz~20kHz

Aux In

Input sensitivity	250mVrms @100Hz
-------------------	-----------------

Speaker

Speaker	57mm 4 ohm 3W Full range
Passive speaker	93x93mm

Bluetooth

Bluetooth specification	Bluetooth® Ver 4.1
Profile Support	A2DP, HFP,HSP

Bluetooth Audio CODEC	SBC, MP3
Transmitting Power	Specification Power Class 2
Line of sight range	10 meters/30 feet

Built-in Battery

Battery	Rechargeable Lithium-ion battery 18650 3.7V 2200mAh
---------	--

General

DC-IN	Micro USB jack 5V 1A
Power consumption	5V 0.5A (Charging in power OFF mode) 5V 1A (Charging in power ON mode)
Charging current	0.5A
Charging time	5 hours
Storage temperature	-20°C~ 60°C
Operating temperature	-10°C ~ 45°C
Weight	1.12 lbs (510g)

Sagean reserves the right to amend the specification without notice.



If at any time in the future you should need to dispose of this product please note that: Waste electrical products should not be disposed of with household waste. Please recycle where facilities exist. Check with your Local Authority or retailer for recycling advice. (Waste Electrical and Electronic Equipment Directive)