



INSTRUCTION MANUAL

CLT-W20

CLT-W25

2.4 GHz

**Digital Cordless Telephone with
Caller ID, Indoor / Outdoor Temperature**

Important

Charge the handset battery for 15 continuous hours prior to first use.

SANYO Canada Inc.
www.sanyocanada.com

TABLE OF CONTENTS

| | |
|---|-----------|
| INTRODUCTION | 5 |
| GETTING STARTED | 6 |
| Checking package contents..... | 6 |
| Modular jack..... | 6 |
| Choosing a location for the base unit and handset cradle..... | 7 |
| Connecting the base unit | 8 |
| Remote sensor setup..... | 9 |
| Changing the remote sensor channel..... | 10 |
| Attaching the remote sensor to a wall mount or table stand..... | 10 |
| Connecting the handset cradle | 10 |
| Batteries | 11 |
| Charging the handset batteries..... | 11 |
| Temperature unit..... | 11 |
| NAMES AND CONTROLS | 12 |
| Handset..... | 12 |
| Base unit | 13 |
| Remote sensor..... | 14 |
| INITIAL PROGRAMMING | 15 |
| Language | 15 |
| Handset name..... | 15 |
| Dial mode..... | 15 |
| Flash time | 16 |
| Key lock..... | 16 |
| Key tone..... | 16 |
| Handset ring tone..... | 17 |
| Handset ring volume level..... | 17 |
| Earpiece volume level..... | 17 |
| Auto answer on / off | 18 |
| Clear message waiting..... | 18 |
| BASICS | 18 |
| Standby mode..... | 18 |
| Receiving a call..... | 18 |
| Making a call | 19 |
| Correcting a dialing error..... | 19 |
| Redialing | 19 |
| Returning missed calls | 20 |
| Mute key "C" | 20 |

TABLE OF CONTENTS

| | |
|---|-----------|
| Handset locator (page key) | 20 |
| Low battery warning | 20 |
| Voice mail indicator | 20 |
| CALLER ID FEATURES | 21 |
| Caller ID with Call Waiting..... | 21 |
| Caller ID list..... | 21 |
| Reviewing Caller ID list | 22 |
| Deleting entries from the Caller ID list..... | 22 |
| DIRECTORY | 22 |
| Storing a name / number in the directory | 23 |
| Making calls from the directory | 24 |
| Deleting an entry | 24 |
| Changing a stored entry..... | 24 |
| Storing Caller ID entries in the directory | 25 |
| MULTI-HANSET CONFIGURATION | 25 |
| Registering a new handset..... | 25 |
| Identifying a handset on the network | 26 |
| Intercom (internal) call..... | 26 |
| Intercom ring tone | 26 |
| Call toggling | 26 |
| 3-way conference call | 27 |
| Call waiting..... | 27 |
| Transferring call between handsets | 27 |
| Call back | 28 |
| TEMPERATURE MONITORING | 28 |
| Temperature unit..... | 28 |
| Indoor temperature..... | 28 |
| Outdoor temperature..... | 29 |
| Sensor search | 29 |
| Change remote unit channel..... | 29 |
| CHANGING THE HANDSET BATTERY | 30 |
| RECYCLING NICKEL-METAL HYDRIDE BATTERIES | 30 |
| HEADSET JACK AND BELT CLIP | 31 |
| POWER FAILURE | 31 |
| LCD SCREEN MESSAGES | 31 |
| LIGHT SIGNALS | 33 |
| SOUND SIGNALS | 33 |

TABLE OF CONTENTS

| | |
|---|-----------|
| TROUBLESHOOTING | 34 |
| TELEPHONE | 34 |
| MULTI-HANDSET USE..... | 35 |
| CALLER ID..... | 36 |
| REMOTE SENSOR..... | 36 |
| CAUSES OF RECEPTION | 37 |
| MAINTENANCE | 37 |
| MAXIMIZE BATTERY PERFORMANCE | 38 |
| TECHNICAL INFORMATION | 39 |
| SANYO COMFORT WARRANTY | 40 |
| SOS HELP LINE | 42 |



The exclamation point within the triangle is a warning sign alerting you of important instructions accompanying the product.

INTRODUCTION

Congratulations on your purchase of this Sanyo digital cordless telephone. Your Sanyo 2.4 GHz digital cordless telephone is a fine-quality home communications product. It is carefully designed and produced by a world leader of consumer and industrial electronic equipment. With proper maintenance and care, it will provide you with years of enjoyment and convenience.

Main Features

2.4 GHz Technology

Superior Range – The use of 2.4 GHz frequency band for signal transmission between base and handset means greater communication range compared to conventional **43-49 MHz** cordless telephones.

Ultra-Low Noise – The high frequency communication also has significantly reduced noise level.

Hopping spread spectrum – Your new 2.4 GHz telephone with Digital frequency hopping spread spectrum technology (FHSS) automatically selects a clear channel every time you receive or place a call on the handset.

COMPANDER PLUS Noise Reduction

This fourth generation of the Sanyo's original noise reduction technology now filters out more background noise.

Other features

- Caller ID memory holds up to 30 numbers
- Electronic telephone book holds up to 70 numbers
- Recognition of up to 4 additional handset units for making intercom (handset to handset) and 3-way calls. Two handsets are shipped with this product (**CLT-W25 only**). Additional handsets sold separately.
- Microphone mute function
- Adjustable ring tones, volume levels, language display, handset IDs, and low battery / out of range warning signals
- Rechargeable batteries and up to 7-hours of talk time
- Indoor temperature display (Celsius or Fahrenheit)
- Outdoor temperature display (Celsius or Fahrenheit)
- Wireless / splash proof remote sensor
- Register up to 2 additional remote sensors for displaying individual room or outdoor temperature information

IMPORTANT: To use all of the features of this telephone, you must subscribe to either the standard Name/Number Caller ID Service or Caller ID with Call Waiting Service from your telephone company. To know who is calling while you are on the phone, you must subscribe to Caller ID with Call Waiting Service.

GETTING STARTED

Checking package contents

Make sure your package includes the items shown here.

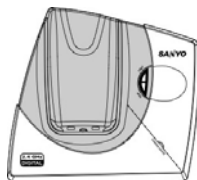

Base unit



Handset cradle
(For CLT-W25
only)



2 x Handsets
(CLT-W20 with
one handset)



2 x AC Adaptors
(CLT-W20 with
one adaptor)



2 x Belt clips
(CLT-W20 with one
belt clip)



Telephone line
cord

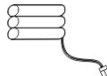

2 x Batteries
(CLT-W20 with
one battery)



Battery order
sheet



Remote sensor



Sensor table
stand



Sensor wall
mount



Sensor batteries

Modular jack

You need an RJ11 type modular phone jack. If you do not have a modular jack, call your local phone company to find out how to get one installed.

GETTING STARTED

Installation tips

Some cordless telephones operate at frequencies that may cause interference to nearby TVs, microwave ovens, and VCRs. To minimize or prevent such interference, the base of the cordless telephone should not be placed near or on top of a TV, microwave oven, or VCR. If such interference continues, move the cordless telephone farther away from these appliances.

Certain other communications devices may also use the 2.4 GHz frequency for communication and if not set properly these devices may interfere with each other and/or your new telephone. If you are concerned with interference, please refer to the owner's manual for these devices on how to properly set channels to avoid interference. Typical devices that may use the 2.4 GHz frequency for communication include wireless audio/video senders, wireless computer networks, multi-handset cordless telephone systems, and some long-range cordless telephone systems.

Choosing a location for the base unit and handset cradle

The base unit records and displays the indoor temperature, when selecting a location, observe the following guidelines:

- Choose a location that provides easy access to a 120-volt AC power source.
- Choose a location that will allow the telephone cable to reach a telephone jack. You can use an extension jack or cable if necessary.
- Place the base unit as high as possible to get a better radio frequency range with the handset. You may need to try several locations – such as upstairs, or near a first-floor landing – to find the best range. Solid structures such as walls and doors may reduce the signal strength.
- Do not place the base unit near a sink, bathtub, or shower.
- Do not place the base unit near objects that may cause radio interference, such as another telephone, large metal objects such as a mirror or filing cabinet, or electrical appliances such as an electric stove, washing machine, microwave oven, television, and fluorescent lights.
- Do not place the unit near heat sources such as radiators or air ducts, or in a place subject to direct sunlight.

GETTING STARTED

Connecting the base unit

1. Plug the AC adaptor into the power jack on the back of the base. Plug the other end into an electrical outlet.
2. Plug the telephone line cord into the tel. line jack on the back of the base. Plug the other end into a modular phone jack.

Note: Two adapters are shipped with **CLT-W25**. Please check the label on the adapter to make sure you are using the right one.

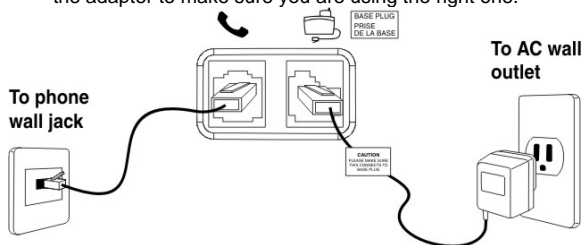

GETTING STARTED

Remote sensor setup

This product can receive and transmit the outdoor temperature then relay it back to the base unit. It can be used with up to 2 other remote sensors to transmit data back to the base unit. Additional remote sensors that measure temperature are sold separately. If you are using more than one remote sensor, be sure to select a different channel number for each unit.

1. Place the remote unit as close as possible to the base unit.
2. Remove the battery compartment lid by using a Philips screwdriver to loosen the screws, and then insert the batteries. Be sure to match polarities as shown.

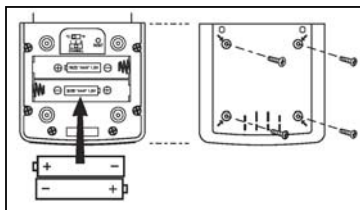

3. Assign a channel number 1, 2, or 3. If you are using more than one remote unit, select a different channel number for each unit.

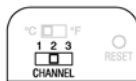

4. Select the temperature measurement unit °C or °F.
5. Press **RESET** with the point of a blunt object (such as a ball point pen).



6. Replace the battery compartment lid. Secure.
7. Position the remote unit using either the recess hole on the back of the unit or the included stand. For best results:
 - Place the unit away from electrical or mechanical objects.
 - Place the unit out of direct sunlight and moisture.
 - Do not place the remote unit more than 25 meters (82 feet) from the base unit.
 - Position the unit so that it faces the base unit. Minimize obstructions such as doors, walls, and furniture.
 - You may need to experiment with various locations to get the best reception.
8. Connect the adapter to the base unit, press and hold **TEMP** on the base until the **CH** icon blinks. It will take 3 minutes for the base to search for available remote sensors even if you only have one sensor.
9. Once the batteries are in place, the sensor will transmit signals every 40 seconds. The readings shown on the base unit depend on which remote sensor (1,2 or 3) is selected.

GETTING STARTED

Changing the remote sensor channel

Select a different channel number and then press **RESET** on the sensor.

Attaching the remote sensor to a wall mount or table stand

Wall mount

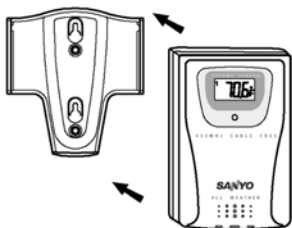
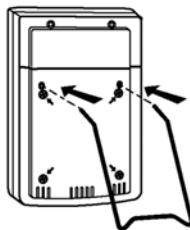
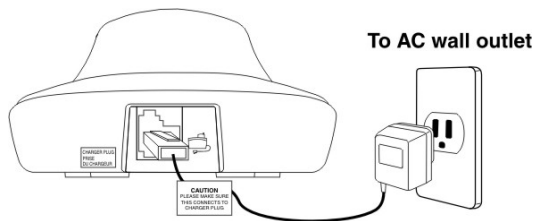

Table Stand



Connecting the handset cradle (Only for CLT-W25)



GETTING STARTED

Batteries

1. Open the battery compartment located at the back of the handset unit.
2. Plug the battery connector into the socket.
3. Replace the battery compartment by sliding it in the direction shown by the arrow in the diagram to the right. The lid clicks into place when it is secured.

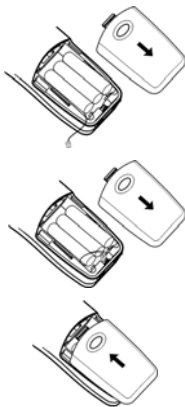

Charging the handset batteries

You must charge the handset batteries for 15 continuous hours the first time you use them. **NOTE:** When the icon appears empty  and "CHARGE BATTERY" shows on the LCD screen, or if you hear a warning beep during a call, please:

- End the call as soon as possible.
- Charge the handset by putting it back on the base cradle with the keypad facing outwards. The blue **CHARGE** LED on the base unit steadily lights to indicate that the handset is charging.
- It is normal for the handset and base to get warm when the handset is charging on the base.

Caution: Use only the Sanyo AC adaptor that is supplied with this phone. Using another AC adaptor may damage the phone.

Temperature unit

The temperature display unit switch is located on the bottom of the base unit. Use the tip of a pointed object such as an unfolded paperclip to switch between Celsius and Fahrenheit temperature display. The unit of measurement should match the unit you selected for the remote sensor.

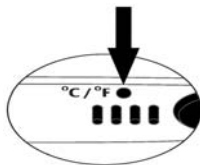

NAMES AND CONTROLS

Handset

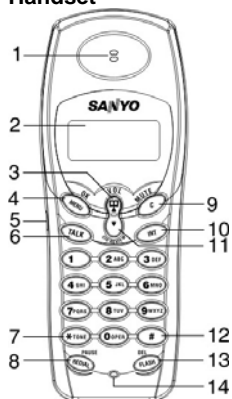

1. Earpiece
2. Display
3. Up (▲) / Volume up / phone book
4. MENU / OK
5. Headset jack (head set optional)
6. TALK
7. *TONE
8. REDIAL / PAUSE
9. (C) Cancel / MUTE
10. INT (intercom)
11. Down (▼)/CID REVIEW
12. #
13. FLASH / DEL
14. Microphone

NAMES AND CONTROLS

Base unit

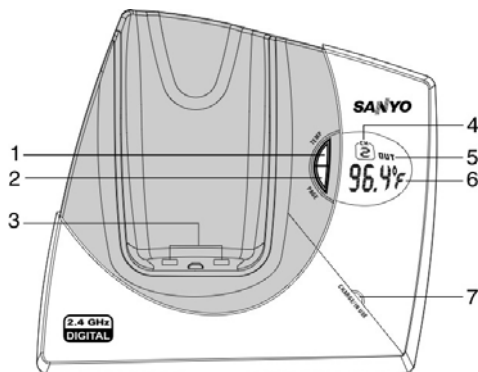

1. **TEMP** button: This allows you to toggle between the indoor temperature and the temperature at sensor channels 1,2, or 3. Press and hold for 3 minutes to search for available remote sensors.
2. **PAGE** button: Press to page handset.
3. Charging contacts.
4. Active channel indicator: Shows which channel (1,2 or 3) the temperature reading is being taken from.
5. Indoor (IN) / Outdoor (OUT) temperature reading: Displays the current indoor temperature in degrees Celsius or Fahrenheit or the temperature recorded at the remote sensor.
6. Temperature display: Displays the temperature in °C / °F for the chosen sensor.
7. **CHARGE/IN USE** LED:
 - Lights steadily when the handset is charging or the telephone line is in use.
 - Flashes (orange) if there is an incoming call or no telephone line is available.

Note: When the outdoor temperature reaches 60°C (104°F) or higher, the base unit will display "HI". When the outdoor temperature falls below -20°C, the base unit will display "LO".

NAMES AND CONTROLS

Remote sensor

Front view

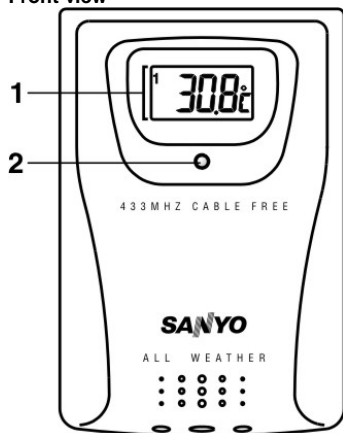

Back view

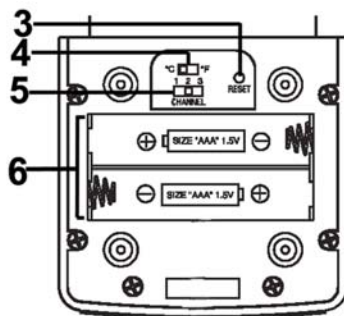





1. Temperature display
2. LED indicator (This blinks when the remote sensor transmits a reading)
3. **RESET** button
4. °C / °F Switch
5. Channel selection switch
6. Battery compartment

INITIAL PROGRAMMING



Before using this telephone, the following initial settings must be completed: volume level, ring volume, ring tone, auto answer, key tone, key lock, handset name, language, phone book, call log, message waiting, and dial mode. The last 4 settings are stored on the base unit and control all handsets. The other settings must be set for each handset individually.

Language

1. Press **MENU/OK** to enter the options menu.
2. Scroll  or  until you see "LANGUAGE."
3. Press **MENU/OK** to enter settings.
4. Press  or  to select the desired language (English, Spanish, or French). The default is English.
5. Press **MENU/OK** to confirm.

Handset name

You can use up to 16 characters to name a handset. The name will appear in the handset display screen in standby mode. To name your handset:







1. Press the **MENU/OK** key.
2. Press  or  to select "HANDSET NAME".
3. Press **MENU/OK** to begin settings, "NAME" will appear.
4. Enter a name for your handset.

Note: refer to the *Storing a name / number in the directory* section for details about how to input characters on page 23.

5. Press **MENU/OK** to save the name.

Dial mode







This phone is compatible with pulse-dialing (rotary) and tone-dialing (DTMF) systems. If you have a touch-tone service, do nothing as your phone has been set to touch-tone by default prior to shipment. If you do not know which type of service you have, contact your local telephone company. The default setting is DTMF.

1. Press the **MENU/OK** key.
2. Press  or  to select "DIALING" from the options.
3. Press the **MENU/OK** key.
4. Press  or  to select "DIAL METHOD" from the submenu.
5. Press **MENU/OK**.
6. Press  or  to select "PULSE" or "DTMF" mode.
7. Press **MENU/OK** to confirm your selection. To return to standby mode, press **C** repeatedly.

INITIAL PROGRAMMING





Flash time

Ask your telephone company before changing the Flash time setting. Changing this setting may cause your telephone company service such as call waiting to not work properly.

1. Press the **MENU/OK** key.
2. Press  or  to select "DIALING" from the options.
3. Press the **MENU/OK** key.
4. Press  or  to select "FLASH TIME" from the submenu.
5. Press **MENU/OK**.
6. Press  or  to select "LONG" or "SHORT". The default setting is LONG.
7. Press **MENU/OK** to confirm your selection.

Key lock

You can lock the keypad to prevent keys from accidentally being pressed. To lock the keypad:

1. Press **MENU/OK**.
2. Press  or  to scroll to "KEY LOCK".
3. Press **MENU/OK** to enter the "KEY LOCK" submenu.
4. Press  or  to select (ON).
5. Press **MENU/OK** to confirm settings. The default setting is OFF.





To unlock the keypad:

- Press 1,5,9 to unlock the keypad.
- Key lock is disabled in the event of an incoming call, but returns to key lock when the call ends.
- Key lock is disabled after an emergency call.

Note: To dial an emergency number while the keypad is locked, press **TALK**, followed by the emergency number (000,110,112,119,911,999).

Key tone







Turn this feature on to hear a click every time a key is pressed on the keypad. This option is not available when the keypad is locked. To activate the key click option:

1. Press **MENU/OK**.
2. Press  or  to scroll to "KEY CLICK".
3. Press **MENU/OK**.
4. Press  or  to select on or off.
5. Press **MENU/OK** to confirm settings. The default setting is ON.

INITIAL PROGRAMMING

Handset ring tone





You have a choice of 10 ring tones for internal or external incoming calls so you can tell from the sound of the ring whether the call is coming from an external or internal source. To select a ring tone:

1. Press the **MENU/OK** key.
2. Press  or  to select "RING PATTERN" from the options.
3. Press **MENU/OK** to select.
4. Select the ring tone you wish to change (internal or external) by pressing  or .
5. Press **MENU/OK** to enter the ring tone selection submenu.
6. Press  or  or number keys (0-9) to choose a ring tone sound (0-9).
7. Press **MENU/OK** to confirm settings. The external ring default setting is 0. The internal ring default setting is 1.

Tip: To return to standby mode, press **C** repeatedly.

Handset ring volume level





To change the ring volume level while the handset is in standby mode: (There are 7 volume levels)



1. Press the **MENU/OK** key.
2. Press  or  to select "RING VOLUME" from the options.
3. Press **MENU/OK** to enter settings.
4. Press  (to increase)  (to decrease) volume. Or press number keys (0-6) to select the desired ring level.
5. Press **MENU/OK** to confirm settings. The default setting is 4.

Tip: You can turn the ringer off by setting the volume level to zero, the  icon will be displayed on the handset display in standby mode.

Earpiece volume level

To change the volume level while the handset is in standby mode: (There are 8 volume levels)

1. Press the **MENU/OK** key.
2. Press  or  to select "HANDSET VOLUME" from the menu.
3. Press **MENU/OK** to enter settings.
4. Press  (to increase)  (to decrease) volume. Or press number keys (0-7) to select the desired volume level.
5. Press **MENU/OK** to confirm settings. The default setting is 4.

Tip: To change the volume while a call is in progress, press  or  until you reach the desired level.

INITIAL PROGRAMMING

Auto answer on / off

The auto-answer feature allows you to answer a telephone call as soon as you lift the handset from the cradle in the base unit.

1. Press the **MENU/OK** key.
2. Press **▲** or **▼** to find "AUTO ANSWER" from the options.
3. Press **MENU/OK** to enter settings.
4. Press **▲** or **▼** to select off or on.
5. Press **MENU/OK** to confirm your selection. The default setting is OFF.

Clear message waiting

1. Press the **MENU/OK** key.
2. Press **▲** or **▼** to select "CLEAR MSG WAIT".
3. Press **MENU/OK**. The screen will show "CONFIRM?".
4. Press **MENU/OK** again to confirm or press **C** repeatedly to return to standby mode.

BASICS

When you first set your unit up, you may hear a beeping tone and see "OUT OF SERVICE" on the handset display area. This is normal, and means that the handset needs to synchronize with the base unit before you can use it. Place the handset on the charger for a few seconds until "READY" appears on the handset display.

Note: You can assign a name to the handset, When you do this your name will appear instead of "READY". For instructions on how to assign a name to a handset, refer to the **Handset name** section on page 15 for more information.

Standby mode

If the handset is synchronized with the base unit and is not "in use" or in "programming mode", "READY" (or a name if entered) will appear on the LCD display.

Receiving a call

When an incoming call is received, the handset will ring, "EXTERNAL CALL" will show on the display and in use LED on the base will flash*. If you are already on the line, a beep will announce you have a call waiting.

* If you subscribe to a caller ID service from your phone company, caller ID information will be shown on the display instead of "EXTERNAL CALL".

1. Press **TALK** / any key (0-9) * or # to answer a call.

Note: If the handset is in the base cradle, remove it from base before pressing the **TALK** key.

BASICS

If "AUTO ANSWER" is enabled, you can accept an incoming call by simply lifting the handset off the base (see **Auto answer** section on page 18).

2. Press **TALK** again to hang up.

Note: If you place the handset back to the base cradle, the handset will automatically hang up.

Making a call

1. Press **TALK** to get a dial tone then enter the number, or dial the number first (up to 24 digits) then press **TALK**.
2. To end the call, press **TALK** again or place the handset on the base cradle so the handset automatically hangs up. "ENDED" will appear on the display to confirm that the call has ended.

Tip: The handset will display the total amount of time elapsed for each call.

Note: You can use this telephone with a PABX (Private Automatic Branch Exchange) or local telephone network. Use of your telephone with a modern system does not require special adjustment; however, with certain older systems, you may need to insert a pause between the prefix and the rest of the number. Enter a dial pause of 3 seconds by pressing **REDIAL/PAUSE**. A "P" will be entered after the number to show that a pause has been inserted.

Correcting a dialing error

You can correct a dialing error before the number has been dialed i.e. before pressing talk. To correct a dialing error you can do one of the following:

- Press the **FLASH/DEL** key to clear the digits one by one.
- Press and hold **FLASH/DEL** to clear all the digits at once.
- Press **C** to clear all the digits at once

Redialing (up to 24 digits)

To redial one of the last 5 numbers called, you can do one of the following:

1. Make sure the phone is OFF (not in TALK mode).
2. Press **REDIAL/PAUSE** repeatedly to select a desired last number, then press **TALK** to redial the last number.

OR

1. Make sure the phone is ON by pressing **TALK**.
2. Press **REDIAL/PAUSE** repeatedly to scroll through a list of numbers, then press **MENU/OK** to redial the last number.

BASICS

Returning missed calls

If you subscribe to a caller ID service through your local network provider this telephone can keep track of missed call information. When you miss a call, the handset will display “New Calls” along with the number of calls you missed. To review a call history with caller ID information, press ▼. Then press  or ▼ to review. To dial the selected number, press the **TALK** key.

MUTE key “C”

To have a private, off-line conversation, use the mute feature. The caller on the other end of the line cannot hear you, but you will be able to hear them. To mute the microphone:

1. While a call is in progress, press **C** on the handset “MIC MUTE” will appear on the handset display.
2. Press **C** again to return to your phone conversation, “EXTERNAL CALL” will be shown on the handset display.

Handset locator (page key)

To locate a misplaced handset, press the **PAGE** key on the base unit. All handsets will beep and the screen shows “BASE PAGING”. To end a page, do one of the following:

1. Press **TALK** or any key (0-9) * or # on the handset.
2. Press **PAGE** on the base unit.

Low battery warning

1. If the battery is low and the phone is in TALK mode, a warning tone consisting of 2 short beeps will sound from the handset earpiece every 15 seconds. “CHARGE BATTERY” shows on screen.
2. If the battery is low and the phone is in STANDBY mode, a warning tone consisting of 2 short beeps will sound from the handset every 15 seconds, and “CHARGE BATTERY” shows on screen.

Voice mail indicator

When you subscribe to a voice mail service offered by your phone company, the phone alerts you when voice mail has been received. “MESSAGE WAITING” appears on screen when a voice mail is received. The LED (orange) on the base flashes slow to indicate there is a voice mail waiting. After the voice mail has been reviewed, you can remove the message indicator. Please see **Clear message waiting** on page 18 for more information.

Note: The indicator does not work with your answering machine. The phone will only work with an FSK type of VMWI System. It will not work with the Stutter Dial Tone type of VMWI System.

CALLER ID FEATURES

This phone receives and displays incoming call information transmitted by your local phone company, provided you subscribe to Voice Mail, Caller ID, and / or Call Waiting services. This information can include the phone number and/or the name, date and time. The phone can store up to 30 calls for later review.

Caller ID with Call Waiting

When you subscribe to Caller ID with Call Waiting (Visual Call Waiting™) service from your phone company, you are able to see who is calling when you hear the Call Waiting tone. Caller identification information appears on screen after you hear the tone.

Press **FLASH/DEL** to put the current call on hold so that you can answer the incoming call. The following information is shown.

Tip: Do not use **TALK** key to activate custom calling services such as Call Waiting, or you will end the current call.

- Caller number (up to 16 digits).
- Caller name (up to 15 characters) - If this is stored in the phonebook or supplied by your telephone network provider.
- The date and time of the last call made from the number.
- To return to the call, press **FLASH/PROG** again.
- **IMPORTANT:** To use these features you must subscribe to either the standard Name/Number Caller ID Service or Caller ID with Call Waiting Service.



Caller ID list

The incoming caller information transmitted from the phone company is received by your phone between the first and second rings and stored in the Caller ID list. If you answer a call before the second ring, the caller information may not be stored.

When the Caller ID list memory is full, a new call automatically replaces the oldest call in memory. "!" appears on screen for calls received that have not been reviewed.

Note: Check with your local phone company regarding name service availability.

CALLER ID FEATURES

Reviewing Caller ID list

All incoming calls with valid Caller ID information are stored in a call log, an exclamation mark (!) to the far right of the name means that that number has not been reviewed. A call log number shown to the right of the telephone number marks the number of calls in the order that they are received, (1 = the most recent). Each time a new call is received, the call log will be resorted to display the most recent call. To review the Caller ID log:

1. Press **MENU/OK** to enter the menu.
2. Press **MENU/OK** to select "CALL LOG".
3. Press **▼** to scroll through the Caller ID list from the most recent to the oldest.
4. Press **▲** to scroll through the Caller ID list from the oldest to the most recent.
5. Press **C** to exit the call log.

Tip: 1. Press **▼** in standby mode to enter call log quickly.
2. Press **TALK** to dial the number currently displayed.

Note: "CALL LOG EMPTY" will show if there are no calls.

Deleting entries from the Caller ID list

All handsets share a common call log that is stored in the base station memory. When more than one handset is registered to a base unit, a call log deleted in one handset will affect all handsets.

Deleting the displayed entry:

1. Make sure the phone is OFF (not in TALK mode).
2. Press **▼** keys to find the entry you want to delete.
3. Press **FLASH/DEL** while the number you wish to delete is displayed. "DELETE?" shows on screen.
4. Press **MENU/OK** to confirm the deletion or **C** to cancel the deletion.

Deleting all entries

1. Make sure the phone is OFF (not in TALK mode).
2. Press **▼** keys to display any entry.
3. Press and hold **FLASH/DEL**. "DELETE ALL?" shows on screen.
4. Press **MENU/OK** to confirm the deletion or **C** to cancel the deletion.

DIRECTORY

This telephone can store up to 70 names and telephone numbers. Names are limited to 15 characters and 16-digit numbers (including pauses 'P') and all handsets share a common phone book that is stored in the base station memory.

When more than one handset is registered to a base unit, any entry stored or deleted in one handset will affect all handsets.

DIRECTORY

NOTE: Shared configurations are available where individual handsets are sold. Please check with your local distributor to find out if this option is available in your area.

Storing a name/number in the directory

1. Press **MENU/OK** in standby mode.
2. Press \square or \blacktriangledown select "PHONEBOOK", then press **MENU/OK**.
3. Press \square or \blacktriangledown select "STORE", then press **MENU/OK**.
4. At the "STORE NUMBER" display, enter number using the keypad, including any prefixes or country codes. If you make a mistake, press **FLASH/DEL** to delete a digit one at a time, then enter the correct digits. If you wish to add a pause, press **REDIAL/PAUSE** once at the desired location. Each pause counts as 1 digit in the dialing sequence.
5. Press **MENU/OK**.
6. At the "STORE NAME" display, enter the name using the keypad. The cursor advances 1 space after each key press. Within 1 second, you can press the same key again to select another character. If you make a mistake, press **FLASH/DEL** to delete a character one at a time, then enter the correct character. Use the chart below as a guide.
7. Press **MENU/OK** to confirm. A beep tone will confirm that the number has been saved.

| Key | key of times pressed | | | | | | | | |
|-----|----------------------|-----------------|-----------------|-----------------|-----------------|-----------------|-----------------|-----------------|-----------------|
| | 1 st | 2 nd | 3 rd | 4 th | 5 th | 6 th | 7 th | 8 th | 9 th |
| 1 | Space | 1 | | | | | | | |
| 2 | A | B | C | 2 | a | b | c | | |
| 3 | D | E | F | 3 | d | e | f | | |
| 4 | G | H | I | 4 | g | h | i | | |
| 5 | J | K | L | 5 | j | k | l | | |
| 6 | M | N | O | 6 | m | n | o | | |
| 7 | P | Q | R | S | 7 | p | q | r | s |
| 8 | T | U | V | 8 | t | u | v | | |
| 9 | W | X | Y | Z | 9 | w | x | y | z |
| 0 | 0 | | | | | | | | |
| * | * | ? | ! | / | (|) | | | |
| # | # | ' | , | - | . | & | | | |







Tip:

- Press **FLASH/DEL** to clear the last character, press and hold **FLASH/DEL** to clear all.
- To return to “STANDBY MODE”, press **C** repeatedly.

DIRECTORY

Note: If you try to store a new number in the phonebook when it is full, a message “PHONEBOOK FULL” is displayed and the phone returns to the phonebook menu after 5 seconds. You should delete some numbers to free up the phonebook memory so that you may store new numbers.







Making calls from the directory

1. Press **MENU/OK**, Press  or  to select “PHONEBOOK”, then press **MENU/OK**.
2. Press  or  to select “RECALL”, then press **MENU/OK**.
3. Press  or  or enter the first character of the desired name to select the desired phonebook entry.
4. Press **TALK** to call.

Tip: Press  in standby mode to enter phonebook log quickly.









Deleting an entry

To delete an entry from the telephone book:

1. Press **MENU/OK**, Press  or  to select “PHONEBOOK”, then press **MENU/OK**.
2. Press  or  to select “RECALL”, then press **MENU/OK**.
3. Press  or  or enter the first character of the desired name to select the desired phonebook entry.
4. Press **FLASH/DEL**. “DELETE?” shows on screen.
5. Press **MENU/OK** to confirm or **C** to go back. A confirmation tone can be heard and the menu steps to the next entry.

Changing a stored entry

To change an entry in the telephone book:

1. Press **MENU/OK** then select “PHONE BOOK” by pressing  or .
2. Press **MENU/OK**
3. Press  or  to select “RECALL”, then press **MENU/OK**.
4. Press  or  or enter the first character of the desired name to find the desired phonebook entry.
5. Press **MENU/OK** to edit the number, “STORE NUMBER” will appear.
6. Press **FLASH/DEL** or  to erase a digit. Press and hold **FLASH/DEL** to erase the entire number. Then enter the correct number.
7. Press **MENU/OK** to edit the name, “STORE NAME” will appear.
8. Press **FLASH/DEL** or  to erase a character. Press and hold **FLASH/DEL** to erase the entire name. Then enter the correct name.
9. Press **MENU/OK** to confirm the change.

Result: A beep will sound to confirm that the change has been saved.



DIRECTORY

Storing Caller ID entries in the directory

You can store received numbers into your phonebook memory. Before you save an entry, make sure the number appears in proper digits for your dialing area. If not, change it using the REDIAL/PAUSE key. For example, if the Caller ID number appears 1-416-222-5555, but it is not a long distance number, press REDIAL/PAUSE key until it shows 416-222-5555 (without 1).

The REDIAL/PAUSE key lets you select how many digits of the number are displayed:

- 7 7-digit telephone number.
- 10 3-digit area code + 7-digit telephone number.
- 11 Long distance code 1 + 3-digit area code + 7-digit telephone number.

1. Press  in standby mode to enter call log quickly.
2. Press  or  to select desired Caller ID entry.
3. Press **REDIAL/PAUSE** to rearrange the format of the number displayed.
4. Press **MENU/OK**, "STORE NUMBER" will appear.
5. Edit the number if necessary.
6. Press **MENU/OK** to edit the name, "STORE NAME" will appear.
7. Edit the name if necessary.
8. Press **MENU/OK** to confirm the change.

Result: A beep will sound to confirm the changes.

MULTI-HANSET CONFIGURATION



CLT-W25 is shipped with 2 handsets (**CLT-W20 is shipped with one handset only**) and can work with up to 4. To purchase additional handsets, please check the place of purchase or see page [42](#) for more information.

Registering a new handset

The original handsets received with your base unit and cradle are automatically registered the first time you set up the telephone. You can add up to [2 \(CLT-W25\)](#) or [3 \(CLT-W20\)](#) additional handsets by registering them with the base unit.

Note: If you register a handset to more than one base, you will need to rename the handset for that base. Otherwise, the base will recognize it as "Handset 1".

To register a new handset:

1. Press the **MENU/OK** key.
2. Press  or  to select "REGISTER" then press **MENU/OK** to choose it.
3. When the handset display shows "PLEASE WAIT", press and hold **PAGE** on the base unit until IN USE LED (orange) flashes quickly.

MULTI-HANSET CONFIGURATION

4. If the registration is successful "SUCCESS" will show on the handset display.



Note: If the registration is unsuccessful "FAIL" will show on the handset display. In this case, you should try again.

Identifying a handset on the network

If you have more than one handset registered to a base unit, you can identify each handset by assigning a name to it. Please see **Handset Name Setting** on page 15 for more information.

Intercom (internal) call

This feature only works if you have 2 or more handsets registered to the base unit.

1. Press **INT** on the first handset.
2. Press  or  to select the desired handset or choose "CALL ALL".
3. Press **TALK** to place the call. The selected handset will ring. If you select "CALL ALL", all other handsets registered to the base unit will ring. If the selected handset is not available (off hook, on another call), "BUSY" shows.
4. To accept the intercom call on the handset, press **TALK**.
5. To exit intercom mode on the first handset, press **TALK**.



Note: During the first handset calls the other handset, there may an incoming call in which the first handset will hear a call waiting tone and the other handset will return to normal incoming call tone.

Intercom ring tone

You can change the ring tone for an intercom call to differentiate internal from external calls. To change the ring tone, please see **Handset Ring Tone Setting** on page 17 for more information.

Call toggling

This feature only works if you have two or more handsets registered to the base unit. The feature allows you to put an external call on hold while you place an intercom call to another handset.

1. Establish contact with an external party by either placing a call or answering an incoming call.
2. Press **INT** to put the external call on hold and enter intercom mode.
3. Press the number (1-4) for the handset you wish to select, or use the  or  keys to select the handset.



4. Press **TALK** to place an intercom call to the selected handset. "H" shows on the display to indicate the external call is on hold.
5. Press **INT** key on the handset that initiates call toggling to place the intercom on hold and return to the external call.
6. Press **TALK** key on the selected handset to end the intercom call and return to the external call.

MULTI-HANDSET CONFIGURATION

Note: If the selected handset is not available, "BUSY" shows and then a callback is generated. "CALL BACK" is displayed on the handset display. You can press **TALK** to return to the caller.

3-way conference call

If you have more than one handset registered with the base unit, you can make 3-way conference calls between an external call party and two internal handset holders. To initiate a 3-way conference call:

1. Establish contact with the external party by either placing a call to that person, or answering an incoming call.
2. Press **INT** then press  or  to choose a handset name, press **TALK** to connect to the selected handset.
Result: The handset you paged rings. The internal party can answer the call by pressing the **TALK** key.
3. The caller who made the conference call should press and hold the **INT** key for approximately 2 seconds until "CONFERENCE CALL" shows on the display and you hear a confirmation beep from earpiece.

Result: All three parties are connected into the call, and can talk together.

Tip: You can end a 3-way conference call exactly as you would any other call. Just press **TALK**. The connection continues between the remaining handset and the external party.

Tip: If a handset is connected to the external line, you can initiate a conference call from another handset by simply picking up the handset and pressing **TALK**. **The first handset can hear a beeping sound and "CONFERENCE CALL" shows on the display.**



Call Waiting

If you receive an external call while you are talking to someone through the intercom, you will hear a call waiting tone. To end the intercom call and answer the external call, press **TALK** key on any handset. The other handset will beep and "BUSY" will [show on the screen](#). To end the intercom call without answering the external call, press and hold **INT** for several seconds.

See also **Caller ID with Call Waiting** on page 21 for more information.

Transferring calls between handsets



You can transfer an external call from one handset to another if you have registered more than one handset with the base unit. To transfer a call:

1. During a telephone conversation, press the **INT** key to place the caller on hold.
2. Press  or  to choose the handset name to which you wish to transfer the call.

MULTI-HANDSET CONFIGURATION

3. Press **TALK**. Then wait for the other handset to answer. The handset you paged will ring, with "INTERNAL CALL" showing on the LCD display. Another party can answer the call by pressing **TALK**.
4. Then press **TALK** key on the first handset, and another handset will connect the external line. If there is no answer, press **INT** again to return to the caller.

OR

1. During a telephone conversation, press the **INT** key to place the caller on hold.
2. Press  or  to choose the handset name to which you wish to forward the call.
3. Press **TALK** to connect to the selected handset. Then press **TALK** again or place the handset in the charger. You do not need to wait for the other handset to answer.
4. **The selected handset will ring and "FORWARDED CALL" will show on the LCD display. Another party can answer the call by pressing TALK.**

Note: If you forward call to all handsets, all handsets (including the one from which you are making the call) ring at the same time.

Call back

After a call forward function has been executed, a call back is generated in the forwarding handset if the forwarding call is not answered within 30 seconds. If no Caller ID information is available, "CALL BACK" is displayed on the handset display. You can press the **TALK** key to return to the caller.

Note: If the returned call isn't answered within 30 seconds, the phone automatically goes on hook.

TEMPERATURE MONITORING

The temperature is shown on the handset display area and base unit **LCD** display. You can choose to show the temperature in Celsius or Fahrenheit units of measurement.

Temperature unit

The temperature unit (Celsius or Fahrenheit) must be set on the remote sensor(s) and the base unit. Refer to the **Getting Started** section for instructions.

Indoor temperature

The handset and base unit LCD display indicate where the temperature reading is coming from. To select the Indoor Temperature, press **TEMP** (located on the base unit) repeatedly until "IN" appears on the base unit display.

Note: It may take a few seconds for the handset display to be updated.

TEMPERATURE MONITORING

Outdoor temperature

To monitor the outdoor temperature, press **TEMP** on the base unit repeatedly until "OUT" appears on the base. It may take a few seconds for the handset display to be updated. If no temperature reading displayed, press **TEMP** repeatedly until the temperature is displayed together with the "OUT" icon. When the outdoor temperature reaches 60 °C (104 °F) or higher, the base unit will show "HI". When the outdoor temperature falls below -20°C, the base unit will show "LO".

Note: This product supports up to 3 remote sensors. Each sensor must be assigned a different channel number (1, 2, or 3). If you cannot locate a sensor, refer to the **Sensor search** section below.

Tip: Place up to 3 remote sensors in important areas of your home such as the baby's room, wine cellar, greenhouse, etc. Additional remote sensors are sold separately.

Sensor search

Sometimes interference causes the base unit to lose connection with a handset. When this happens, press and hold **TEMP** for 5 seconds to initiate a remote sensor search. The **CH** icon will blink while the search is in progress.

Note:

- Batteries must be installed in the remote sensor and be in good working order.
- Under normal usage, the batteries should be replaced after one year.
- The search may take up to 3 minutes.
- The remote sensor should be no further than 25 meters (82 feet) from the base.

Change remote unit channel

The wireless remote sensor uses radio frequencies to communicate with the base. Channels can be assigned for up to three sensors so you can monitor the temperature in three different locations. To change the channels:

1. Remove the back cover.

2. Select the channel by sliding the channel selector switch located inside the battery compartment.
3. Press the **RESET** button with the tip of a ballpoint pen or unfolded paper clip.
4. Replace the cover.
5. Press and hold **TEMP** on the base unit for 5 seconds to search for the sensor.

CHANGING THE HANDSET BATTERY

Battery replacement and handling

When the handset operating time becomes short even after a battery has been recharged, please replace the battery.

With normal usage, your battery should last about one year.

For a replacement battery, please contact your place of purchase or fill out and mail the enclosed form.

Caution:

- Use only the specified battery type (3.6V, 750mAh).
- Do not remove the battery from the handset to charge it.
- Never throw the battery into a fire, disassemble it, or heat it.
- Do not remove or damage the battery casing.
- Remove the battery if you are storing the phone for more than 30 days.

Replacing the battery

1. Make sure the telephone is turned off.
2. Slide off the battery compartment cover.
3. Disconnect the battery plug from the jack in the compartment and remove the battery pack.
4. Insert the new battery pack and connect the cord into the jack.

Note: Please refer to the pictures in the **Getting started** section on page 11 for more information.

5. Put the battery compartment cover back on.
6. Place handset on the base to charge for 15 hours.

Note: Charge the handset battery for 15 continuous hours prior to first use. The initial battery charge is important to ensure best performance.

Caution: To reduce the risk of fire or personal injury, use a 3.6 V, 750mAh battery. Replacement part number: [3SN-AAA75H-S-J1](#).

RECYCLING NICKEL-METAL HYDRIDE BATTERIES

NICKEL-METAL HYDRIDE BATTERIES MUST BE DISPOSED OF PROPERLY.

Please take your used battery pack to a store that recycles Ni-MH batteries.



HEADSET JACK AND BELT CLIP

Headset connection (not included)

An optional headset can be used with your telephone for hands free conversation. To use a headset, plug it into the HEADSET jack located on the side of the handset. When the headset is connected, the handset earpiece and microphone are disabled. While the headset is connected, press **TALK** to answer or place a call.



Belt clip

To attach the belt clip to the back of the handset:

1. Slide the belt clip over the back of the handset until the ventilation holes are aligned.
2. Gently push the belt clip until it clicks into place.

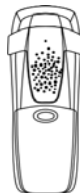

POWER FAILURE

During the period that the power is off, you will not be able to make or receive calls with the telephone.

After a power outage, it may take a few seconds for the handset to reconnect to the base unit.

LCD SCREEN MESSAGES

The following indicators show the status of a message or of the phone.

| | |
|---|---|
| BASE PAGING | Someone has pressed PAGE on the base unit |
| BUSY | The dialed number or handset is busy |
| CALL ALL | An intercom call has been placed to all registered handsets |
| CALL BACK | A forwarded call was not answered |
| CH | Remote sensor channel. The selected channel number will display. |
| CHARGING | Battery is charging |
| CONFERENCE CALL | 2 handsets are on a conference call |
| ENDED | The call has ended. The elapsed time for the call also shows. |
| EXT IN USE | Another handset is already on an external call |
| EXTERNAL CALL | A call was received with no Caller ID information provided |
| FAIL | Registration did not occur |
| H | A call has been placed on hold |
| HI | Temperature is over 60°C |
| IN | Indoor temperature is shown |
| INTERNAL CALL HANDSET # / HANDSET NAME | An intercom call has been placed from the displayed handset |
| MIC MUTE | The handset is in mute mode |
| OUT | Outdoor temperature is shown |
| PRIVATE # / NAME / CALLER | Some or all of the Caller ID information was blocked |
| READY | Phone is charged and ready to make or receive calls |
| TALK | Phone is in Talk mode (ready to place a call or on a call). If on a call, the duration of the call also shows |
| UNKNOWN # / NAME / CALLER | Some or all of the Caller ID information was not sent with the call |
| FORWARD CALL | A call is being forwarded |
| DELETE? | Prompt asking if you want to erase the current Caller ID entry or a directory entry that is shown on screen |
| DELETE ALL? | Prompt asking if you want to erase all Caller ID |

information

| | |
|------------------|---|
| MESSAGE WAITING | Caller has left a message (you must subscribe to a voice mail service offered by your local phone company for this to work) |
| STORE NUMBER | Prompt telling you to enter the telephone number for directory |
| STORE NAME | Prompt telling you to enter the name in directory |
| PHONEBOOK EMPTY | There is no record stored in the selected directory location |
| CALL LOG EMPTY | There is no record stored in the selected call log location |
| NO LINE | Telephone line is disconnected from base unit |
| KEY LOCKED | The keypad is locked |
| OUT OF SERVICE | When the handset is out of range or the base unit experiences power failure |
| CHARGE BATTERY | When the battery is low |
| PLACE IN CHARGER | The battery voltage is too low |
| RINGER OFF | The ringer is switched off |
| LO | Temperature falls below -20°C |

LIGHT SIGNALS

The charge / in use indicator will change under the following conditions:

CHARGE / IN USE LED on the base

| | |
|-------------------|--|
| Talking | Lit steadily (orange) |
| Charging | Lit steadily (blue) |
| Incoming call | Flashes in same pattern as telephone ring (orange) |
| Voice mail | Flashed every 2 seconds (orange) |
| No telephone line | Flashed every 1 second (orange) |

SOUND SIGNALS

| | |
|----------------------|--------------------------|
| A long warbling tone | Signals an incoming call |
| Single tone | A key is pressed |
| Two short beeps | Call waiting / MIC mute |

| | |
|----------------------------------|---|
| One long beep | Confirmation tone / Page signal / Call back |
| Three short beeps | Error tone / Out of range |
| Two short beeps every 15 seconds | Low battery warning |

TROUBLESHOOTING

TELEPHONE

No dial tone

Check installation:

- Is the base unit plugged into the telephone line and AC power source? If the telephone line is not properly connected to the base unit NO LINE will appear on the handset display.
- Is the AC power source turned on at the socket?
- Are the batteries properly installed in the handset?

Dial tone is OK, but cannot dial out

- Try moving the handset closer to the base unit.
- If this doesn't work, try a different position for the base unit. Typically, the higher you place the base unit, the better the reception.
- The battery charge level may be low. Check the LCD display for the low battery-warning signal. If the battery is low, place the handset in the base unit's charging cradle to charge.
- Check the power connection by switching off the power at the main socket, waiting a few seconds, then switching it back on.
- Check to make sure that the phone and base unit are within transmission range.
- The handset may be unable to find the base unit. Try moving the handset closer to the base unit. If the problem persists, try moving the base unit in a suitable position nearer to the handset.
- If you have registered additional handsets to the same base unit, make sure they are not already on a call. The LCD display on your handset will display the **EXT IN USE** symbol if the line is engaged.
- The dial mode setting may be incorrect. See **Dial mode** section for instructions on how to change the dial mode on page 15.

Handset does not ring

- Check that you have not turned off the ringer volume level. Refer to the **Handset ring volume level** section on page 17 for more information.

- You may have too many extension phones on your line. Try unplugging some phones.

Call was disconnected

Please move the handset closer to the base unit. You may want to consider moving the base unit to achieve a greater transmission range.

TROUBLESHOOTING

Keys do not work / shows on screen

The symbol means that the keypad lock feature has been activated. See the **Key lock** section for instructions on how to unlock the keypad on page 16 for more information.

Phone beeps

- The battery may need to be recharged. Put the handset into the charging cradle of the base unit. It may take up to 15 hours to fully recharge the battery.
- Your handset may temporarily lose its synchronization with the base unit due to radio interference in your area. When this happens, "OUT OF SERVICE" shows on handset LCD. You can move closer to the base unit to help reduce your telephone's susceptibility to radio interference. If you do not wish to hear the beep tone, you can turn it off following the instructions under the **Key tone** section on page 16 for more information.

Low battery warning

If you just recharged the batteries, but keep getting a low battery warning, the batteries may need to be replaced. Rechargeable batteries gradually lose their ability to store a charge the older they get. Replace the battery with a new one.

MULTI-HANSET USE

Cannot register new handset

- Sometimes it helps to unplug and then reconnect your base unit to its AC power source before you start the registration procedure.
- [You may have already registered 4 handsets to the base unit.](#)
- If you are replacing a faulty handset, make sure you have fully removed the faulty one before registering the new one. Refer to the **Registering a new handset** section on page 25 for more information.

- If you are still experiencing problems, you may need to reset all the registrations then start over. Refer to “REGISTERING A NEW HANDSET” for instructions.

TROUBLESHOOTING

Cannot dial out

Only one outside call and one intercom call can take place at the same time. Make sure no one else is already using the phone; if so, you will see the **EXT IN USE** symbol on the handset display area.

All handsets show “OUT OF SERVICE” and telephone will not work

Reset your telephone, and then try the registration process again. If you are still experiencing problems, reset and then re-register all your handsets one-by-one.

CALLER ID

No Caller ID display

- You must subscribe for Caller ID services through your telephone network provider for the Caller ID to display on this telephone. Please check with your provider.
- If the caller’s number does not exactly match what you have entered in your phone book, including the STD code and any prefixes, the phone book cannot match the name to the Caller ID. Check the phone book to make sure the full number is stored there in the correct sequence.
- Is the battery fully charged? If not, try recharging or replacing the battery.
- Make sure the base unit is connected to a non-switched AC outlet. Disconnect the base from the plug and plug it in again.

Caller ID error message

- The phone displays this message if it detects anything other than valid Caller ID information during the silent period after the first ring. This message indicates either the presence of noise on the line, or that an invalid message has been sent from the telephone company.

REMOTE SENSOR

Cannot find remote sensor

- Check the sensor batteries, channel number, and location.

TROUBLESHOOTING

- Make sure sensor low battery icon isn't being displayed. Make sure the sensor is within range of the base unit. Press **RESET** on sensor to initiate a sensor search or press and hold **TEMP** on base unit to search for sensors. See the **Search sensor** section on page 29 for more information.

“HI” shows on display

When the outdoor temperature reaches 60 °C (104 °F) or higher, the base unit will display “HI”.

“LO” shows on display

When the outdoor temperature falls below –20°C, the base unit will display “LO”.

CAUSES OF POOR RECEPTION

- Aluminum siding.
- Foil backing on insulation.
- Heating ducts and other metal construction can shield radio signals.
- You are too close to appliances such as microwaves, stoves, or computers.
- Atmospheric conditions, such as strong storms.
- Base unit is installed in the basement or lower floor of the house.
- Base unit is plugged into an AC outlet with other electronic devices.
- Baby monitor is using the same frequency.
- Handset battery is low.
- You are out of the base unit's transmission range.

MAINTENANCE

To keep your telephone working and looking good, following these guidelines:

- Avoid putting the phone near heating appliances and devices that generate electrical noise (for example, motors or fluorescent lamps).
- Do not expose to direct sunlight or moisture.
- Avoid dropping the phone, and other rough treatment to the phone.
- Clean the phone with a soft cloth.

MAINTENANCE

- Never use a strong cleaning agent or abrasive powder because this will damage the finish.
- Periodically clean the charge contacts on the handset and base with a clean pencil eraser.
- Retain the original packaging in case you need to ship the phone at a later date.

MAXIMIZE BATTERY PERFORMANCE

The freedom that your cordless telephone can offer is fully dependent on the performance of the rechargeable battery in the handset. To maximize the battery performance, follow these guidelines:

Charge it for a full 15 continuous hours

Before initial use of your new battery, charge it for 15 continuous hours. The proper initial charging is very important to maximize the battery performance.

Keep the contacts clean

You can never fully recharge the battery if the contacts are dirty. Clean all the contacts—two at the bottom of handset and two in the base cradle—periodically using a pencil eraser.

Do not replace the handset in the base after each call

Repeated short charging creates a memory effect in the battery. Once a rechargeable battery acquires this “short memory”, it sends a “CHARGE BATTERY” signal even when it is almost fully charged. The battery then needs to be charged frequently. To avoid this, leave the handset away from the cradle until it really needs recharging.

Refresh battery

If your battery seems to need recharging more often than usual, it may have lost part of its charging capacity because of premature recharges. To bring back its full capacity, try “refreshing” the battery:

1. First discharge the battery by leaving the handset in TALK mode until Battery Low indication turns on. (Disconnect the base from the telephone line, so that your line is not busy all the time.)
2. Then charge it for 15 continuous hours.
3. Repeat the above once more.

TECHNICAL INFORMATION

REN Number:

The Ringer Equivalence Number (REN) assigned to each terminal device provides an indication of the maximum number of terminal allowed to be connected to a telephone interface.

The REN number of this phone is located on the bottom of the base unit. The termination on an interface may consist of any combination of device subject only to the requirement that the sum of the Ringer Equivalence Numbers of all the devices does not exceed 5.

CAUTION

This product is intended for use in CANADA and US only. Sale or use in other countries may violate local laws.

Cordless telephones use radio frequencies to allow mobility. This affects the performance of your phone.

1. NOISE

Electrical pulse noise is present in most homes at one time or another. This is most intense during electrical storms. Certain kinds of electrical equipment, such as light dimmers, fluorescent bulbs, motors, fans, etc., also generate pulse noise.

Because radio frequencies are susceptible to this, you may on occasion hear pulse noise through the handset. This is usually only a minor annoyance and should not be interpreted as a defect of the phone.

2. RANGE

Because radio frequencies are used, the location of the base station can affect the operating range of the phone. Try several locations and choose the one that gives the clearest signal to the handset. (Turning in a circle while

holding the handset may also increase the operating range.)

3. INTERFERENCE

Electronic circuits activate a relay to connect the unit to your telephone line. These electronic circuits operate in the radio frequency spectrum. While several protection circuits are used to prevent unwanted signals, there may be periods when these unwanted signals enter the base station. You may hear click or hear the relay activate when you are not using the cordless handset. If this occurs frequently, you can minimize or eliminate the problem by lowering the height of the base station or relocating the base station. It may also be helpful to change the operating channel and/or the security code setting.

Operation is subject to the following two conditions: (1) this device may not cause interference, and (2) this device must accept any interference, including interference that may cause undesired operation of the device.

NOTICE:

Privacy of communications may not be ensured when using this telephone. Other devices, including other cordless telephones, may interfere with the operation of this cordless telephone or cause noise during operation. Units without coded access may be accessed by other radio communication systems. Cordless telephones must not cause interference to any licensed radio service.

The Industry Canada Label identifies certified equipment. This certification means that the equipment meets certain telecommunications network protective, operational and safety requirements. The ministry does not guarantee that the

equipment will operate to the user's satisfaction.

Before installing this equipment, users should ensure that it is permissible to be connected to the facilities of the local telecommunications company. The equipment must also be installed using an acceptable method of construction. In some cases, the company's inside wiring associated with single-line individual service may be extended by means of a certified connector assembly (telephone extension cord). The customer should be aware that compliance with the above conditions may not prevent degradation of service in some situations.

Repairs to certified equipment should be made by an authorized Canadian maintenance facility designated by the supplier. Any repairs or alterations made by the user to this equipment, or equipment malfunctions, may give the telecommunications company cause to request that the user disconnect the equipment.

The user should ensure for his own protection that the electrical ground connections of the power utility, telephone lines and internal metallic water pipe system, if present, are connected together. This precaution may be particularly important in rural areas.

CAUTION

Users should not attempt to make such connections themselves, but should contact the appropriate electrical inspection authority, or electrician, as appropriate.

The exclamation point within an equilateral triangle is intended to alert the user to the presence of important operating and maintenance (servicing)

instructions in the literature accompanying the product.

This symbol on the product is used to identify the following important information. Use only with specified SANYO power adaptor.

NOTICE: This equipment meets the applicable Industry Canada Terminal Equipment Technical Specifications. This is confirmed by the registration number. The abbreviation, IC, before the registration number signifies that registration was performed based on a Declaration of Conformity indicating that Industry Canada technical specifications were met. It does not imply that Industry Canada approved the equipment.

NOTE: This equipment has been tested and found to comply with the limits for a Class B digital device, pursuant to Part 15 of the FCC Rules. These limits are designed to provide reasonable protection against harmful interference in a residential installation. This equipment generates, uses and can radiate radio frequency energy and, if not installed and used in accordance with the instruction manual, may cause harmful interference to radio communications. However, there is no guarantee that interference will not occur in a particular installation.

If this equipment does cause harmful interference to radio or television reception, which can be determined by turning the equipment off and on, the user is encouraged to try to occur the interference by one of more of the following measures:

- * Reorient or relocate the receiver antenna.
- * Increase the separation between the equipment and receiver.
- * Connect the equipment into an outlet on a circuit different from that to which the receiver connected.
- * Consult the dealer or an experienced radio/TV technician for help.

RF Exposure Warning:

To comply with RF exposure requirements the base station must be installed and operated with its antenna located 20 cm or more between antenna and all person's body (excluding extremities of hands, wrist and feet). The handset may be carried and operated with only non-metallic belt-clips that provide a minimum of 0.5cm separation from the body. All other belt clips should be avoided and may not

comply with RF safety requirements. The base station and handset must not be co-located or operated in conjunction with any other antenna or transmitter.

Warning: Changes or modification not expressly approved by SANYO Canada Inc. could void the user's authority to operate the equipment.

SANYO COMFORT WARRANTY

WARRANTY APPLICATION

Sanyo Communications products purchased new, unused in Canada through a Sanyo Authorized Dealer are warranted against manufacturing defects in materials and workmanship for ONE YEAR covering parts and labour, from the date of purchase by the original retail purchaser. This warranty only applies in favour of the original retail purchaser of the warranted product.

SANYO CANADA INC.'S RESPONSIBILITY

During the warranty period, SANYO Canada Inc. will repair, or at our option, replace a Communications product which shows evidence of a manufacturing defect in materials or workmanship. Replacement PARTS are warranted for the remaining portion of the warranty period.

WHAT IS NOT COVERED

- a. Communications products purchased outside Canada.
- b. Communications products purchased in a used condition.
- c. Communications products purchased from non Sanyo-authorized dealer.

- d. Communications products not intended for Canadian usage or products without appropriate Canadian regulatory approvals.
- e. Problem due to product set-up and installation.
- f. Adjustments that are outlined in the Operating Manual.
- g. Accessory items including antenna, and batteries.
- h. Damage in or due to transportation.
- i. Damage due to improper maintenance, accident, abuse, misuse or negligence.
- j. Damage caused by lightning and power surges.

ORIGINAL RETAIL PURCHASER'S RESPONSIBILITY

You, the original retail purchaser, must present your original, dated bill-of-sale together with this warranty to SANYO Canada Inc. or to an authorized Sanyo Service Depot when you make a claim under this warranty.

You, the original retail purchaser, are responsible for any costs of TRANSPORTING the product to and from SANYO Canada Inc. or an authorized Sanyo Service Depot. You also are responsible for the cost of any

MAINTENANCE necessary in respect of the product.

(905) 760-9944
1-800-263-2244

WARRANTY BECOMES VOID

This warrant becomes void if the product's serial numbers are altered or removed or if any repair to the product is made other than by SANYO Canada Inc. or by an authorized Sanyo Service Depot.

LIMITATIONS

- a. SANYO Canada Inc. reserves the right to change or improve the design of the model of the product warranted hereunder without incurring any obligation to make any modifications to or to install any improvement in or on the product.
- b. In no event shall SANYO Canada Inc. or any of its Authorized Dealers be liable for special or consequential damage arising from the use of this product.

STATUTORY WARRANTIES

The above provisions do not preclude the operation of any applicable provincial statute which in certain circumstances may not allow some of the limitations and exclusions described in this Warranty. Where any terms of this Warranty are prohibited by such a statute, they shall be deemed null and void but the remainder of this warranty shall remain in effect.

HOW TO OBTAIN WARRANTY SERVICE

Please contact the Sanyo Authorized Dealer from whom the product whom the product was purchased, or contact us directly at:

SANYO Canada Inc.
1-300 Applewood Cres.
Concord, Ont. L4k 5C7

SOS HELP LINE

At Sanyo, fulfilling the needs of our customers is a priority. That's why we created our SOS customer service program that guarantees satisfaction.

NATIONWIDE CUSTOMER SUPPORT

SOS is there to help you. Our friendly and knowledgeable product specialists will quickly answer your questions about setup and use of Sanyo telephone products. Simply call toll free from anywhere in Canada to connect to our no-charge, SOS support and service network:

1-800-263-2244

between 8:30 am – 7:00 pm EST

Or visit our website at www.sanyoservice.com, and click the **Customer Relations** key to get access to our FAQ's (Frequently Asked Questions) and other helpful features.

STAY-AT-HOME CONVENIENCE

It's a nuisance making another trip to the store when you're stuck. Now with SOS, all that's necessary is a quick call for your home for product assistance.

HASSLE-FREE EXCHANGE

Should your Sanyo telephone require servicing due to a manufacturing defect during the warranty period, SANYO Canada will ship prepaid a replacement unit* within two business days after receiving your defective unit. **Consumers are responsible for the shipping costs of the unit back to Sanyo.**

- For older, non-current models, replacement units may not be available, in which case our regular warranty conditions will apply.

GUARANTEED QUALITY

All SOS replacement sets are checked and serviced by factory-authorized technicians before being sent out. SOS means you never have to worry.

C.O.D. and/or Collect shipments will not be accepted.

Unit must be returned to Sanyo in its original box with all accessories, i.e.: owner's manual, battery, adaptor, telephone cord, etc.