

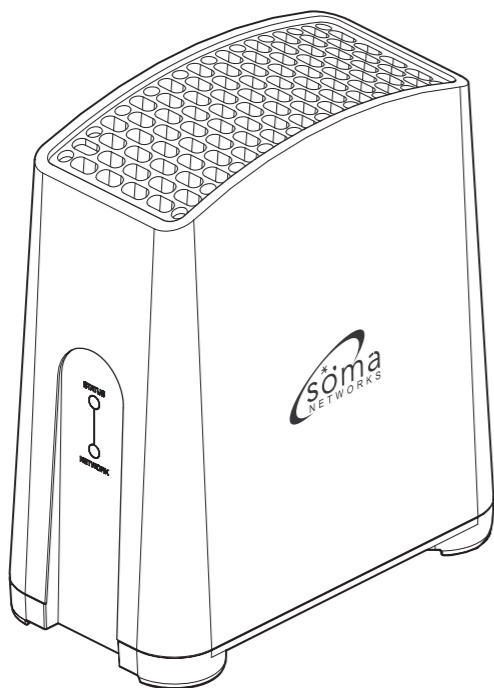

SOMApport™ 400

Quick Setup Guide



1 Getting to know the SOMApport Front and back panels

Before beginning the installation, familiarize yourself with the front and back panels of the SOMApport.

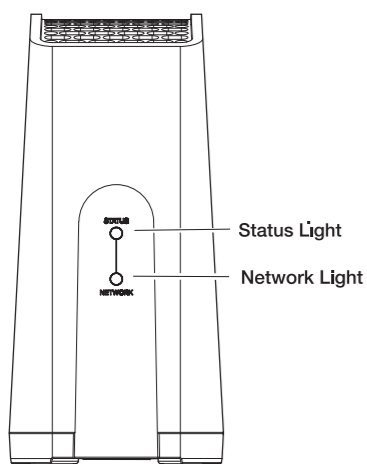

Front Panel

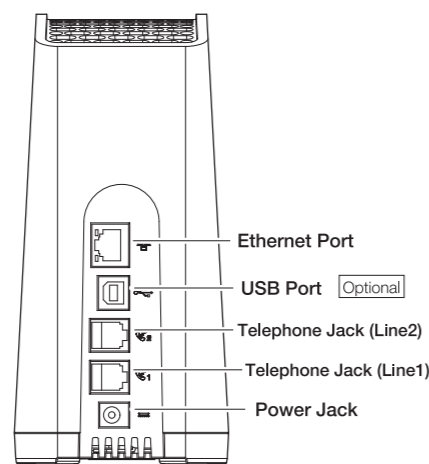

Back Panel

2 Getting to know the SOMApport Front panel lights

Status Light

Off	The SOMApport is not receiving power.
Amber	The SOMApport is booting and running its internal diagnostics.
Flashing Amber	The SOMApport is upgrading its firmware.
Green	The SOMApport is powered and operating normally.
Red	An error occurred. The SOMApport is not currently functional.

Network Light

Off	The SOMApport is not receiving power.
Amber	The SOMApport is attempting to locate a base station.
Flashing Amber	The SOMApport cannot locate a base station
Flashing Green	The SOMApport has located a base station and is attempting to establish a connection.
Green	The SOMApport has located a base station and has established connection
Red	An error occurred. The SOMApport is not currently functional.

3 Getting to know the SOMApport Ethernet status lights and cable

The Ethernet cable is supplied with the SOMApport.

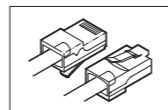

The Ethernet Status light is on the Ethernet port. This light works only if you use Ethernet to connect your computer to the SOMApport.

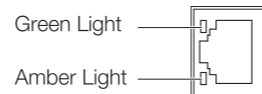

Ethernet Status Green Light

On	The computer is connected to the SOMApport.
Off	The computer is not connected to the SOMApport.

Ethernet Status Amber Light

Off	No data is being transmitted between the SOMApport and the computer
Flashing	Data is being transmitted between the SOMApport and the computer

4 Position the SOMApport

When choosing a location for the SOMApport, follow these guidelines to optimize the signal strength.

- Allow at least 46 cm (18 inches) of space around the SOMApport.
- Put the SOMApport on an upper floor of the building, if possible.
- Place the SOMApport higher up in a room, such as on a desk or a shelf, rather than on the floor.
- Place the SOMApport near a window.
- Avoid placing the SOMApport close to certain electronic devices, such as computer monitors, as this may cause interference.
- Avoid placing the SOMApport in a horizontal orientation to protect it from overheating.

5 Plug in the SOMApport

- 1 Insert the connector of the power cord that is attached to the power supply into the power jack on the SOMApport. **A**
- 2 Insert the socket end of the AC power cord into the power supply. **B**
- 3 Position and orient the SOMApport in the location in which you plan on keeping it.
- 4 Insert the plug end of the AC power cord into a power outlet.

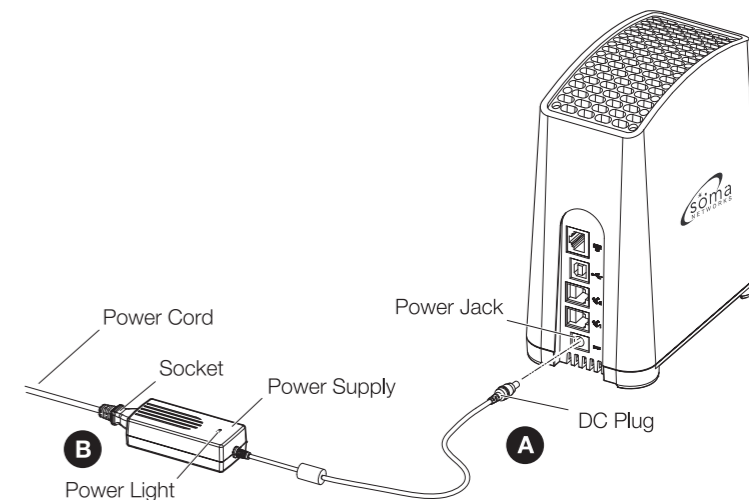

The SOMApport takes up to five minutes to start, connect to your service provider's network, and acquire a radio signal. The light on the power supply indicates whether or not it is receiving power. Wait until the Network light on the top of the SOMApport turns green before you begin connecting equipment to the SOMApport.

6 Connect your telephone

If your service provider does not offer telephone service, or if you are not connecting a telephone to the SOMApport, go to step 7 to connect your computer.

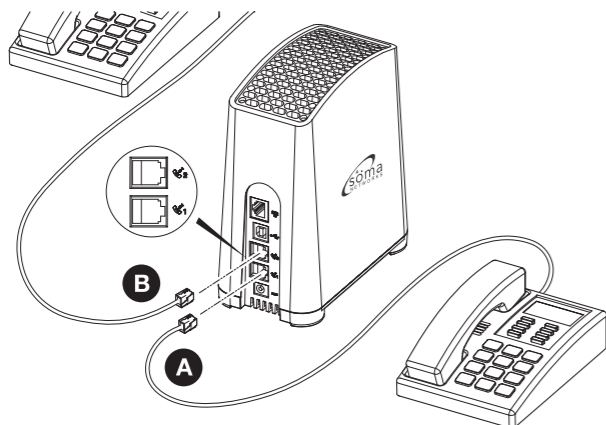

- 1 Insert the telephone cord into the lower jack (line1) on the back of the SOMApport. **A**
 - If your telephone service includes one telephone line only, use this jack
 - If your telephone service includes two telephone lines, the telephone you connect to this jack will be serviced by line 1.
- 2 To connect a second telephone, do one of the following:
 - If your telephone service includes two telephone lines, insert the cord of the second telephone into upper jack (line2) on the back of the SOMApport. **B**
 - If your telephone service includes one telephone line only, you must use a duplex adapter.

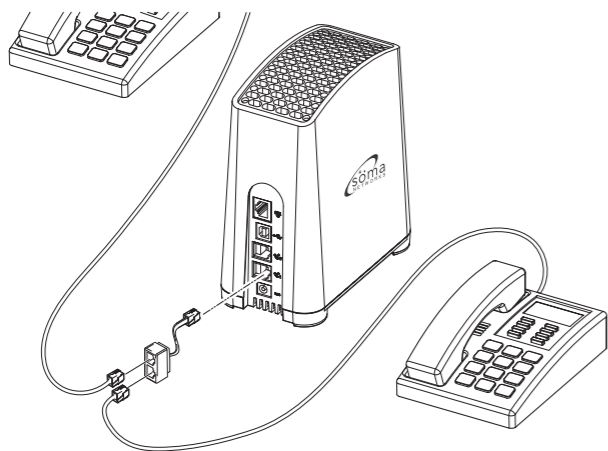

- 3 Pick up the handset and listen for a dial tone.
 - If you hear a series of tones (not a dial tone), the SOMApport is still booting. Hang up and try again when the status light turns green.
 - If you hear silence, make sure the cord is securely connected to the telephone and the SOMApport. See the SOMApport User Guide for troubleshooting information.

7 Connect your computer

Follow this procedure if you are using Ethernet. If you want to connect several computers to the SOMApport via a hub or a switch, see the SOMApport User Guide.

- 1 Insert one end of the Ethernet cable into the Ethernet port on the SOMApport. **A**
- 2 Insert the other end into the Ethernet port on the computer. **B**

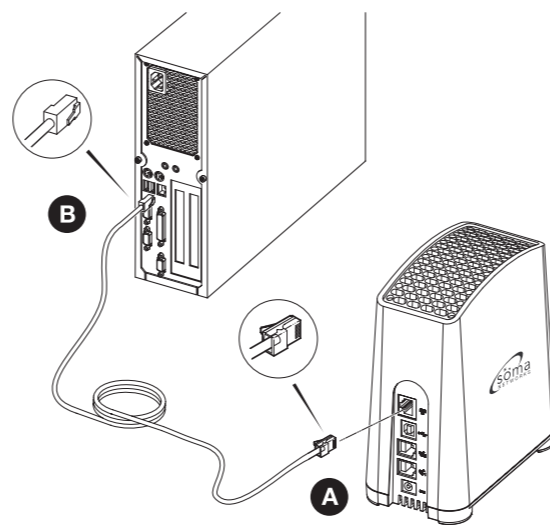

8 Activate full service

- 1 Restart your computer.
- 2 Launch a Web browser on the computer connected to the SOMApport.
- 3 Direct your browser to a known valid Internet address (such as www.google.com)
 - If the page opens, full service has already been activated and you can begin using your SOMApport for Internet service.
 - If you are redirected to your service provider's Web page, you must complete the sign-up procedure on the Web site to activate full service.
 - If you cannot open any Web pages at all:
 - a. Follow the procedure for running the Internet Connection Wizard if you used Ethernet to connect the computer to the SOMApport.
 - b. See the chapter "Troubleshooting" in the SOMA User Guide if you used USB option.

9 Run the connection wizard

If your operating system is Mac OS, see the SOMApport User Guide for information about changing network settings.

If your version of Windows 95 does not have the Get on the Internet option or if you previously had a dial-up connection, you cannot use the wizard. See the SOMApport User Guide for information about manually changing network settings.

- 1 Start the Windows Internet Connection Wizard:

Version	Choose
Windows 95	Start → Programs → Accessories → Internet Tools → Get on the Internet
Windows 98/ME/2000	Start → Programs → Accessories → Communications → Internet Connection Wizard
Windows XP	Start → Programs → Accessories → Communications → New Connection Wizard

- 2 Do the following to complete the Wizard:

Version	Choose
Windows 95 98/ME/2000	<ol style="list-style-type: none"> 1 Choose I want to set up my Internet connection manually, or I want to connect through a local area network (LAN). 2 Choose I connect through a local area network. 3 Leave all check boxes on the Local area network Internet configuration window blank. 4 Choose No when prompted to set up an Internet Mail Account. 5 Click Finish.
Windows XP	<ol style="list-style-type: none"> 1 Choose Connect to the Internet. 2 Choose Setup my connection manually. 3 Choose Connect using a broadband connection that is always on. 4 Click Finish.

- 3 Restart your computer.

- 4 Launch a Web browser on the computer connected to the SOMApport and direct the browser to a known valid Internet address (such as www.google.com).



Your product is designed and manufactured with high quality materials and components which can be recycled and reused. This symbol means that electrical and electronic equipment, at their end-of-life, should be disposed of separately from your household waste. Please dispose of this equipment at your local community waste collection/recycling centre. In the European Union there are separate collection systems for used electrical and electronic products. Please help us to conserve the environment we live in!

Copyright 2006 SOMA Networks, Inc. All Rights Reserved. SOMA, SOMA Networks and the star-and-circle logo are trademarks of SOMA Networks, Inc. All of SOMA Networks' product names are trademarks of SOMA Networks, Inc. All other company and product names may be trademarks or registered trademarks of their respective owners. Products and services of SOMA Networks, Inc. may be protected by one or more pending or issued U.S. or foreign patents.

See the Enduser Product License Agreement in the SOMApport User Guide.

Part S1AH6P1P0007-- Rev _