

Parts List



File No.

Air Conditioner

INDOOR UNIT
KMS0772

Model No.	Prod.Code	Volt-Phase-Hertz
KMS0772	1 852 099 87	230-208-1-60

REFERENCE No.PL 706284

KMS0772
INDOOR UNIT

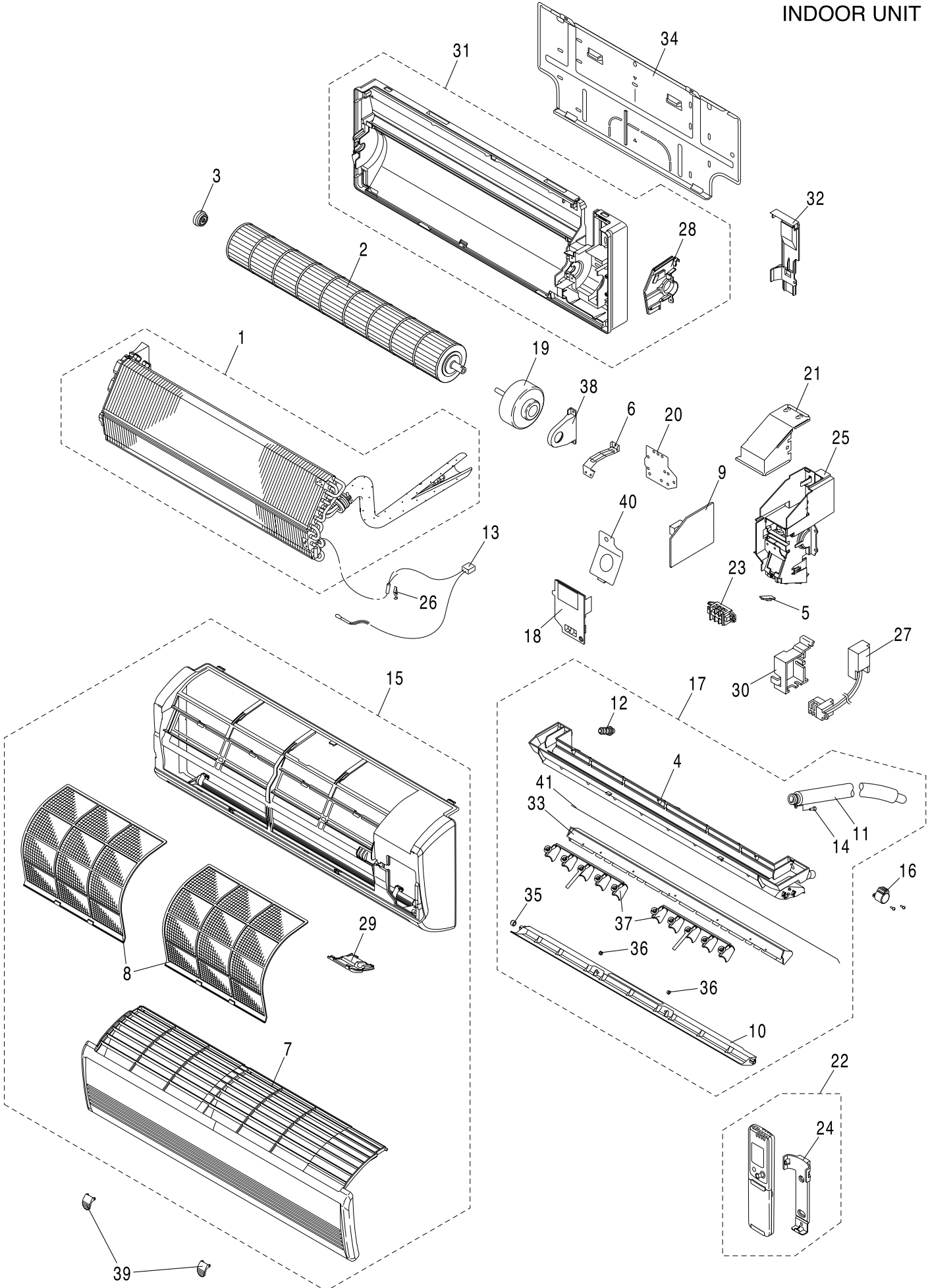

ATTENTION !

To ensure correct parts supply, please let us know followings,
when you make service parts order:

1.Part No. 2.Description 3.Q'ty 4.Volts-Hz-Ph 5.Product Model No.

KMS0772
INDOOR UNIT

Key No.	Part No.	Description	Q'ty	Reference No.	
1	623 190 8320	Evaporator Ass'y	1	852-0-4116-92800	
*	2	623 184 7018	Cross-Flow Fan Ass'y	1	852-0-2509-29300
*	3	623 171 8318	Bearing Housing Ass'y	1	852-0-2510-13200
4	623 190 8313	Air Outlet Frame	1	852-2-1531-20711	
*	5	623 190 8306	P.C.B. Ass'y IND-KHS1271	1	8FA-0-5178-55900
6	623 177 2150	Mounting Plate	1	852-2-2309-97501	
7	623 190 8290	Ornamental Plate	1	852-2-1516-38051	
8	623 190 8283	Air Filter Ass'y	2	852-0-2307-34002	
*	9	623 193 2387	Circuit Board Ass'y CB-KMS0772	1	8FA-0-5181-21000
10	623 190 8344	Flap	1	852-2-1523-29211	
11	623 177 2235	Drain Hose Ass'y	1	852-0-1303-29400	
12	623 171 8363	Cap, Drain Pan	1	852-2-2348-12401	
*	13	623 178 2456	Thermistor Ass'y PTM-D51H-S3	1	8FA-0-5259-05100
14	623 171 9001	Screw Special	1	852-2-2396-15901	
15	623 190 8337	Grille Ass'y	1	852-0-1501-74700	
*	16	623 177 2204	Step Motor MP24Z3-12V	1	1FA-4-M3A0-00900
17	623 190 8405	Air Outlet Ass'y	1	852-0-1531-30500	
18	623 193 2301	Terminal Cover Ass'y	1	852-0-5309-07800	
*	19	623 191 8220	Fan Motor SIC-39CVL-D847-4	1	1FA-4-M5B0-07500
20	623 190 8375	Mounting Plate	1	852-2-2385-14701	
21	623 184 2969	Plate,Elec.Component Box	1	852-2-5309-40901	
*	22	623 190 8542	Remote Control Switch RCS-4VPIS4U	1	8FA-0-0054-28900
23	623 003 2996	Terminal Base KTU15N-3J	1	4-2379-56159	
24	623 171 8400	Holder	1	851-2-5377-02001	
25	623 190 8467	Elec. Component Box	1	852-2-5307-70001	
26	623 148 5876	Mounting Thermostat	1	852-2-5303-22401	
*	27	623 185 8816	Minus Ion Generator ION-YU11-1S3	1	1FA-4-P1Z0-05900
28	623 190 8450	Mounting Plate	1	852-2-2309-78511	
29	623 190 8443	Sash ORN Ass'y	1	852-0-1301-31300	
30	623 190 8436	Mounting Plate	1	852-2-2385-12011	
31	623 190 8429	Frame Ass'y	1	852-0-2201-43500	
32	623 190 8412	Mounting, Tube	1	852-2-2362-29812	
33	623 190 8511	Guide Air Defl	1	852-2-2360-19411	
34	623 177 2433	Rear Panel	1	852-2-2230-22501	
35	623 146 9104	Mounting	1	852-2-1514-52001	
36	638 003 7209	Mounting	2	852-2-1514-44002	
37	623 190 8504	Blade	2	852-2-1519-34911	
38	623 193 2318	Mounting Plate, Fan Motor	1	852-2-2354-30211	
39	623 190 8481	Cap	2	852-2-2350-23811	
40	623 190 8474	Angle Terminal	1	852-2-5306-36101	
41	623 193 2325	Wire	1	852-2-1315-36001	

NOTE: Metal and plastic parts will be supplied basically with necessary heat insulation pads or packing.
Each key number with an asterisk (*) means the recommended service parts.

For Parts or Service Contact

SANYO Fisher Service Company
A Division of SANYO North America Corporation
1165 Allgood Road, Suite 22, Marietta, GA 30062 U.S.A.

Sanyo Canada Inc.
1-300 Applewood Crescent, Concord, Ontario, L4K 5C7, CANADA
-4- 3/06 Printed in Japan