

**SATELLINE-M3-TR8  
SATELLINE-M3-TR9  
TRANSCEIVER MODULES  
INTEGRATION GUIDE**

Version 1.7

## **IMPORTANT NOTICE**

All rights to this manual are owned solely by SATEL Oy (referred to in this user guide as SATEL). All rights reserved. The copying of this manual (without the written permission from the owner) by printing, copying, recording or by any other means, or the full or partial translation of the manual to any other language, including all programming languages, using any electrical, mechanical, magnetic, optical, manual or other methods or devices is forbidden.

SATEL reserves the right to change the technical specifications or functions of its products, or to discontinue the manufacture of any of its products or to discontinue the support of any of its products, without any written announcement and urges its customers to ensure, that the information at their disposal is valid.

SATEL software and programs are delivered "as is". The manufacturer does not grant any kind of warranty including guarantees on suitability and applicability to a certain application. Under no circumstances is the manufacturer or the developer of a program responsible for any possible damages caused by the use of a program. The names of the programs as well as all copyrights relating to the programs are the sole property of SATEL. Any transfer, licensing to a third party, leasing, renting, transportation, copying, editing, translating, modifying into another programming language or reverse engineering for any intent is forbidden without the written consent of SATEL.

**SATEL PRODUCTS HAVE NOT BEEN DESIGNED, INTENDED NOR INSPECTED TO BE USED IN ANY LIFE SUPPORT RELATED DEVICE OR SYSTEM RELATED FUNCTION NOR AS A PART OF ANY OTHER CRITICAL SYSTEM AND ARE GRANTED NO FUNCTIONAL WARRANTY IF THEY ARE USED IN ANY OF THE APPLICATIONS MENTIONED.**

Salo, FINLAND 2017

Copyright: 2017 SATEL Oy

No part of this document may be reproduced, transmitted or stored in a retrieval system in any form or by any means without the prior written permission of SATEL Oy.

## RESTRICTIONS ON USE – SATELLINE-M3-TR8

**SATELLINE-M3-TR8** radio transceiver module has been designed to operate on 868-870 MHz, the exact use of which differs from one region and/or country to another. The user of a radio transceiver module must take care that the said device is not operated without the permission of the local authorities on frequencies other than those specifically reserved and intended for use without a specific permit.

**SATELLINE-M3-TR8** is allowed to be used in the following countries, either on license free channels or on channels where the operation requires a license. More detailed information is available at the local frequency management authority.

Countries: AT, BE, BG, CH, CY, CZ, DE, DK, EE, ES, FI, FR, GB, GR, HU, IE, IN\*, IS, IT, LT, LU, LV, MT, NL, NO, PL, PT, RU, RO, SE, SI and SK.

\*) Own frequency variant for India.

### WARNING - RF Exposure

To comply with RF exposure compliance requirements, maximum antenna gain (in dB) must not exceed calculated signal loss (in dB) in antenna cable and separation distance of at least 25 cm must be maintained between the antenna of this device and all persons. This device must not be co-located or operating in conjunction with any other antenna or transmitter.

This integration guide applies to the combination of Firmware/Hardware version listed in the table below. See [www.satel.com](http://www.satel.com) for the newest firmware and Integration Guide version.

Firmware version	Hardware version	Note!
07.22.2.1.0.1	SPL0030e	First official release

## RESTRICTIONS ON USE – SATELLINE-M3-TR9

SATELLINE-M3-TR9 radio transceiver module has been designed to operate on 902-928 MHz, the exact use of which differs from one region and/or country to another. The user of a radio transceiver module must take care that the said device is not operated without the permission of the local authorities on frequencies other than those specifically reserved and intended for use without a specific permit.

SATELLINE-M3-TR9 is allowed to be used in the following countries. More detailed information is available at the local frequency management authority.

Countries: AU, CA and US.

### WARNING - RF Exposure

To satisfy FCC and ISED RF exposure requirements for mobile transmitting devices, a separation distance of 25 cm or more should be maintained between antenna of this device and persons during device operation. To ensure compliance, operations at closer than this distance is not recommended. The antenna used for this transmitter must not be co-located in conjunction with any other antenna or transmitter. FCC regulations allow up to 36 dBm equivalent isotropically radiated power (EIRP). Therefore, the sum of the transmitted power (in dBm), the cabling loss and the antenna gain cannot exceed 36 dBm.

This radio transmitter 2422A-SATELTA31 has been approved by Industry Canada to operate with the antenna types listed below with the maximum permissible gain indicated. Antenna types not included in this list, having a gain greater than the maximum gain indicated for that type, are strictly prohibited for use with this device.

Antenna type	Manufacturer	Antenna model	Maximum gain (dBi)
Omnidirectional	Oy CompleTech Ltd	CA915H	5
Directional (yagi)	Oy CompleTech Ltd	CA930Y	6

### NOTE!

According to the requirements of the FCC, the integrator should make sure that the SATELLINE-M3-TR9 is compliant to part 15C while integrated in the host device. Output power and spurious emissions should be verified.

## **PRODUCT CONFORMITY**

Hereby, SATEL Oy declares that SATELLINE-M3-TR8 radio transceiver module is in compliance with the essential requirements (radio performance, electromagnetic compatibility and electrical safety) and other relevant provisions of Directive 2014/53/EU. Therefore the equipment is labeled with the following CE-marking.



For SATELLINE-M3-TR9 only:

This device complies with Industry Canada licence-exempt RSS standard(s) and part 15 of the FCC Rules. Operation is subject to the following two conditions: (1) this device may not cause interference, and (2) this device must accept any interference, including interference that may cause undesired operation of the device. Changes or modifications not expressly approved by the party responsible for compliance could void the user's authority to operate the equipment.

Le présent appareil est conforme aux CNR d'Industrie Canada applicables aux appareils radio exempts de licence. L'exploitation est autorisée aux deux conditions suivantes : (1) l'appareil ne doit pas produire de brouillage, et (2) l'appareil doit accepter tout brouillage radioélectrique subi, même si le brouillage est susceptible d'en compromettre le fonctionnement.

## **WARRANTY AND SAFETY INSTRUCTIONS**

Read these safety instructions carefully before using the product:

-Warranty will be void, if the product is used in any way that is in contradiction with the instructions given in this manual

-The radio transceiver module is only to be operated at frequencies allocated by local authorities, and without exceeding the given maximum allowed output power ratings. SATEL and its distributors are not responsible, if any products manufactured by it are used in unlawful ways.

-The devices mentioned in this manual are to be used only according to the instructions described in this manual. Faultless and safe operation of the devices can be guaranteed only if the transport, storage, operation and handling of the device are appropriate. This also applies to the maintenance of the products.

## HOST INTEGRATION

To ensure compliance with all non-transmitter functions the host manufacturer is responsible for ensuring compliance with the module(s) installed and fully operational. For example, if a host was previously authorized as an unintentional radiator under the Declaration of Conformity procedure without a transmitter certified module and a module is added, the host manufacturer is responsible for ensuring that after the module is installed and operational the host continues to be compliant with the Part 15B unintentional radiator requirements. This module is certified for Fixed and Mobile Applications only, for portable applications you will require a new certification.

This device has been modularly approved. Model name, FCC and Industry Canada identifiers of this product must appear on the outside label of the end-user equipment.

Host labelling example:

**Model Name:** SATEL-TA31

**Contains** FCC ID: MRBSATEL-TA31

IC: 2422A-SATELTA31

This device complies with part 15 of the FCC rules. Operation is subject to the following two conditions: (1) This device may not cause harmful interference, and (2) this device must accept any interference received, including interference that

## TABLE OF CONTENTS

<b>IMPORTANT NOTICE .....</b>	<b>1</b>
<b>RESTRICTIONS ON USE – SATELLINE-M3-TR8 .....</b>	<b>2</b>
<b>RESTRICTIONS ON USE – SATELLINE-M3-TR9 .....</b>	<b>3</b>
<b>PRODUCT CONFORMITY.....</b>	<b>4</b>
<b>WARRANTY AND SAFETY INSTRUCTIONS .....</b>	<b>5</b>
<b>HOST INTEGRATION .....</b>	<b>6</b>
<b>TABLE OF CONTENTS .....</b>	<b>7</b>
<b>1 INTRODUCTION .....</b>	<b>10</b>
1.1 Terms and abbreviations.....	10
1.2 Description of the product .....	10
<b>2 TECHNICAL SPECIFICATIONS.....</b>	<b>11</b>
2.1 Absolute maximum ratings.....	11
2.2 DC electrical specifications.....	11
2.3 Specifications, SATELLINE-M3-TR8.....	12
2.4 Specifications, SATELLINE-M3-TR9.....	15
2.5 Specifications, SATELLINE-M3-TR9, Option 9.....	16
<b>3 TIME PARAMETERS FOR STARTUP AND SHUTDOWN SEQUENCES.....</b>	<b>17</b>
3.1 Startup sequence .....	17
3.2 Shutdown and ENA sequences .....	18
<b>4 ELECTRICAL INTERCONNECTION.....</b>	<b>19</b>
4.1 DTE connector.....	19
4.2 Pin order of the DTE connector .....	20



<b>4.3</b>	<b>Equivalent I/O Schematics .....</b>	<b>21</b>
<b>4.4</b>	<b>VCC_IO pin .....</b>	<b>22</b>
<b>4.5</b>	<b>Service pin.....</b>	<b>22</b>
<b>4.6</b>	<b>Stat pin .....</b>	<b>23</b>
<b>4.7</b>	<b>VCC pins .....</b>	<b>23</b>
<b>4.8</b>	<b>UART pins .....</b>	<b>23</b>
<b>4.9</b>	<b>GPIO pins .....</b>	<b>23</b>
<b>4.10</b>	<b>Antenna interface .....</b>	<b>24</b>
<b>5</b>	<b>MECHANICAL CONSIDERATIONS .....</b>	<b>25</b>
<b>5.1</b>	<b>Fixing device to host .....</b>	<b>25</b>
<b>5.2</b>	<b>Module dimensions.....</b>	<b>26</b>
<b>6</b>	<b>OPERATING MODES .....</b>	<b>27</b>
<b>6.1</b>	<b>Safe mode .....</b>	<b>27</b>
<b>6.2</b>	<b>Power up / power down scenarios.....</b>	<b>27</b>
<b>6.3</b>	<b>Sleep Mode .....</b>	<b>28</b>
<b>6.4</b>	<b>Power Save Mode.....</b>	<b>28</b>
<b>6.5</b>	<b>Restart .....</b>	<b>29</b>
<b>7</b>	<b>CHANGING PARAMETERS USING SL COMMANDS .....</b>	<b>30</b>
<b>7.1</b>	<b>SL Commands .....</b>	<b>30</b>
<b>7.2</b>	<b>SL Command Mode .....</b>	<b>30</b>
<b>8</b>	<b>DEFAULT DELIVERY VALUES – SATELLINE-M3-TR8.....</b>	<b>32</b>
<b>9</b>	<b>DEFAULT DELIVERY VALUES – SATELLINE-M3-TR9.....</b>	<b>33</b>
<b>10</b>	<b>CONSIDERATIONS.....</b>	<b>34</b>
<b>10.1</b>	<b>EMI Interferers .....</b>	<b>34</b>

<b>10.2</b>	<b>Electrostatic discharge .....</b>	<b>34</b>
<b>10.3</b>	<b>Using the device in unmanned high reliability applications .....</b>	<b>35</b>
<b>11</b>	<b>APPENDIX A .....</b>	<b>36</b>
<b>11.1</b>	<b>Sub-band Channel Assignment – SATELLINE-M3-TR8.....</b>	<b>36</b>
11.1.1	Sub-band .....	36
11.1.2	Duty cycle .....	36
11.1.3	Power level .....	36
11.1.4	Channel assignment .....	36
<b>12</b>	<b>APPENDIX B .....</b>	<b>37</b>
<b>12.1</b>	<b>SL COMMANDS – SATELLINE-M3-TR8 .....</b>	<b>37</b>
<b>13</b>	<b>APPENDIX C .....</b>	<b>43</b>
<b>13.1</b>	<b>SL COMMANDS – SATELLINE-M3-TR9, Freewave.....</b>	<b>43</b>
<b>13.2</b>	<b>COMMANDS - SATELLINE-M3-TR9, Option 9 .....</b>	<b>47</b>
<b>14</b>	<b>VERSION HISTORY .....</b>	<b>48</b>

# 1 INTRODUCTION

SATEL Oy is a Finnish electronics and Telecommunications company specializing in the design and manufacture of wireless data communication products. SATEL designs, manufactures and sells radio modems intended for use in applications ranging from data transfer to alarm relay systems. End users of SATEL products include both public organizations and private individuals.

SATEL Oy is the leading European manufacturer of radio modems. SATEL radio modems have been certified in most European countries and also in many non-European countries.

This document is the integration guide for the SATELLINE-M3-TR8 and –TR9 radio transceiver modules. It is intended to describe how to use the module and how to integrate it into a host device. There is available two versions of SATELLINE-M3-TR9: Standard Freewave version YM7900 and customer specific Option 9 version YM7905.

## 1.1 Terms and abbreviations

Abbreviation	Description
CTS	Clear To Send, handshaking signal used in asynchronous communication.
DTE	Data Terminal Equipment (typically computer, terminal...)
ESD	Electrostatic discharge
RD	Receive Data
TD	Transmit Data
RTS	Ready To Send, handshaking signal used in asynchronous communication.
RAM	Random Access Memory
LDO	Low dropout regulator
UHF	Ultra High Frequency
RF	Radio Frequency
CPU	Central processing unit

## 1.2 Description of the product

The SATELLINE-M3-TR8 and SATELLINE-M3-TR9 are UHF radio transceiver modules, which transmit and receive data from the UHF frequency band. The modules are designed to be as compact and power efficient as possible. They have been developed to be especially suitable for integration into battery powered and space constrained host applications benefiting from UHF communications.

The module transmits and receives data via the Air interface, modulates and demodulates, encodes and decodes the data and sends the received data payload to the DTE port. The DTE interface is used to provide power and communicate with the module.

## 2 TECHNICAL SPECIFICATIONS

### 2.1 Absolute maximum ratings

Absolute maximum ratings for voltages on different pins are listed in the following table. Exceeding these values will cause permanent damage to the module.

Parameter	Min	Max
Voltage at VCC_IN	0 V	+5 V (TR8), +6V (TR9)
Voltage at ENA_MOD	0 V	+6 V
Voltage at VCC_IO	0 V	3.75 V
Voltage at digital inputs (except ENA_MOD)	0 V	3.75 V
Voltage at digital outputs	0 V	3.75 V

Note. All voltages are referenced to GND.

### 2.2 DC electrical specifications

Recommended operating conditions:

Parameter	Condition	Min	Max	Units
VCC_IN (TR8)	4.0 V is considered nominal	4.0 <sup>1</sup>	Nominal +5%	V
VCC_IN (TR9)		3.5	5.5	V
ENA_MOD, Vlow		0	0.2	V
ENA_MOD, Vhigh		1.2	VCC_IN	V
VCC_IO		1.8	3.3	V
Logic input, Vlow	1.8 V < VCC_IO < 3.3V	0	0.3V	V
Logic input, Vhigh	1.8 V < VCC_IO < 3.3V	0.9*VCC_IO	VCCIO	V
Logic output, Vlow	1.8 V < VCC_IO < 3.3V	0	0.5	V
Logic output, Vhigh	1.8 V < VCC_IO < 3.3V	0.6*VCC_IO	VCCIO	V
Logic output, max current	All logic output except STAT pin.	-	4	mA
Logic output, max current, STAT pin		-	12	mA

<sup>1</sup> Meets the ETSI requirements on given operating voltage range. Exceeding the values might drive the module outside of the ETSI EN 300 220 requirements.

## 2.3 Specifications, SATELLINE-M3-TR8

SATELLINE-M3-TR8 complies with the following international standards:

Frequency variant 868...870 MHz: EN 300 220-1, -2, EN 301 489-1, -3 and EN 60950-1.

Frequency variant 865...867 MHz: EN 300 113-2.

	RECEIVER	TRANSMITTER	Note!
Frequency Range	868...870 MHz 865...867 MHz (for India)		See Appendix A
Tuning range	2 MHz		
Minimum RF Frequency Step	6.25 kHz		
Channel Bandwidth	25 kHz		
Frequency Stability	<1 kHz		
Maximum Receiver Input Power without Damage	+14 dBm		
Maximum Receiver Input Power without Transmission Errors	-10 dBm		FEC ON
Sensitivity <sup>1</sup>	typ. -107 dBm		FEC ON
Blocking <sup>1</sup>	> 82 dB @ 1 MHz offset > 83 dB @ 2 MHz offset > 85 dB @ 5 MHz offset		FEC ON
Intermodulation Attenuation	typ. > 64 dB		FEC ON
CO-Channel Rejection	typ. > -17 dB		FEC ON
Adjacent Channel Selectivity <sup>1</sup>	> 52 dB		FEC ON
Spurious Rejection	typ. > 45 dB		FEC ON
Transmitter Power (868...870 MHz)		10, 20, 50, 100, 200, 500 mW	
Transmitter Power (865...867 MHz)		10, 20, 50, 100, 200, 500, 1000 mW	
Communication Mode	Half-Duplex		
Frequency Change Time	typ. 40 ms		Time required for switching from one RF frequency to another
TX to RX time RX to TX time	typ. 4 ms		
Adjacent Channel Power		acc. to EN 300 220 -2	TX-mode
Transient Adjacent Channel Power		acc. to EN 300 220 -2	TX-mode
Carrier power stability		< ±1.5 dB	

	DATA MODULE	
Electrical Interface	CMOS-UART Inputs and outputs referred to IO Voltage processed by user (1.8-3.3V) RTS, CTS, RX, TX, +VCC, GND	
Interface Connector	1.27 mm pitch socket	Samtec 20-pin through hole, CLP-110-02-L-D-K-TR
Data speed of Serial interface	9600 – 115200 bps	
Data speed of Radio Air Interface	19200 bps	
Air Interface Encryption	AES128	
Data Format	Asynchronous data	
Modulation	4FSK	

	GENERAL	
Operating voltage	+4.0 VDC	min. <sup>4</sup> 4.0 V, max. Nominal +5%
Current consumption in Power Save mode	< 2 mA	ENA_MOD set to LOW
Maximum DC Ripple Voltage <sup>2</sup>	max. 100 mV <sub>pp</sub>	0 < f ≤ 15 kHz
	max. 130 mV <sub>pp</sub>	15 kHz < f ≤ 20 kHz
	max. 150 mV <sub>pp</sub>	f > 20 kHz
Typical Power Consumption 868...870 MHz	875 mW	RX-mode
	SLEEP1: 260 mW	RX-mode
	4.3 W @ 500 mW RF out	TX-mode, Continuous, 50 Ω
	3.3 W @ 200 mW RF out	
	3.0 W @ 100 mW RF out	
	2.8 W @ 50 mW RF out	
	2.7 W @ 20 mW RF out	
2.6 W @ 10 mW RF out		
Typical Power Consumption 865...867 MHz	1 W	RX-mode
	SLEEP: 300 mW	RX-mode
	5.6 W @ 500 mW RF out	TX-mode, Continuous, 50 Ω
	7.3 W @ 1 W RF out	
Inrush Current, power turned ON <sup>3</sup>	< 12 A, duration < 50 μs	RX-mode
Temperature Range	-20 °C ... +55 °C	Type Approval conditions
Temperature Ranges	-30 °C ... +60 °C	Functional
	-40 °C ... +80 °C	Storage
Vibration	≤ 5g	100 Hz ≤ f <sub>vibration</sub> ≤ 1,0 kHz
ESD <sup>4</sup>	± 10 kV	Antenna connector. Acc. to EN61000-4-2; 150pF/330Ω
	± 8 kV	DTE connector. Acc. to EN61000-4-2; 150pF/330Ω
Antenna Connector	50 Ω, HIROSE U.FL compatible	I-PEX 20279-001 -E-01
Construction	PWB with sheet metal EMI shields	
Size L x W x T	57 x 36 x 6.7 mm	
Weight	20 g	

Test condition  $V_{CC} = 4.0 \text{ V}$  and  $T_A = 25 \text{ }^\circ\text{C}$

<sup>1</sup> According to EN 300 220-2 V2.4.1 measurement setup.

<sup>2</sup> Higher values exceed the -36 dBm spurious limit at the antenna e.g. EN 300 220-2 requirement.

<sup>3</sup> Measured using Agilent 1147B current probe and TTI TSX1820P DC power supply.

<sup>4</sup> Measured under normal ambient conditions,  $T_A = 25 \text{ }^\circ\text{C}$ . When the device is used in different environment, the results may change significantly. It is recommended to use external ESD protection in demanding conditions.

## 2.4 Specifications, SATELLINE-M3-TR9

SATELLINE-M3-TR9 complies with the following international standards:  
FCC Parts 15.209 and 15.247 of Title 47  
IC RSS-247, ICC RSS-Gen  
AS/NZS 4268:2012, AS/NZS 4771:2000

	RECEIVER	TRANSMITTER	Note!
Frequency Range	902-928 MHz		
Spreading Method	Frequency Hopping		
Occupied Bandwidth	230 kHz		
Frequency Stability	<1 kHz		
Maximum Receiver Input Power without Damage	-3 dBm		
Maximum Receiver Input Power without Transmission Errors	-3 dBm		
Sensitivity	typ. -109 dBm for BER $10^{-4}$		
Blocking	TBD		
Intermodulation Attenuation	TBD		
Adjacent Channel Selectivity	TBD		
Transmitter Power		10, 20, 50, 100, 200, 500, 1000 mW	
Carrier power stability		< $\pm 1.5$ dB	
Data Rate	115.2 kbit/s		
Modulation Method	2-GFSK		
Hopping Bands	7, user selectable		
Hopping Patterns	15 per band, 105 total, user selectable		
Hopping Channels	50-112, user selectable		
Frequency Zones	16 Zones, 7 Channels per Zone		
Temperature Ranges	-40 °C ... +70 °C		Functional
	-40 °C ... +80 °C		Storage
Operating Voltage	3.5-5.5 VDC		
Power Consumption	300 mW (Receive mode) 3.2 W (Transmit Mode 1 W)		
Vibration	$\leq 25g$		$10 \text{ Hz} \leq f_{\text{vibration}} \leq 2,0 \text{ kHz}$
ESD <sup>4</sup>	$\pm 10 \text{ kV}$		Antenna connector. Acc. to EN61000-4-2; 150pF/330Ω
	$\pm 8 \text{ kV}$		DTE connector. Acc. to EN61000-4-2; 150pF/330Ω



Antenna Connector	50 $\Omega$ , HIROSE U.FL compatible	I-PEX 20279-001 - E-01
Construction	PWB with sheet metal EMI shields	
Size L x W x T	57 x 36 x 6.7 mm	
Weight	20 g	
Electrical Interface	CMOS-UART Inputs and outputs referred to IO Voltage processed by user (1.8-3.3V) RTS, CTS, RX, TX, +VCC, GND	
Interface Connector	1.27 mm pitch socket	
Data speed of Serial interface	9600 – 115200 bps	

<sup>4</sup> Measured under normal ambient conditions,  $T_A = 25\text{ }^\circ\text{C}$ . When the device is used in different environment, the results may change significantly. It is recommended to use external ESD protection in demanding conditions.

## **2.5 Specifications, SATELLINE-M3-TR9, Option 9**

Down below are mentioned specifications that vary from the standard version.

	RECEIVER	TRANSMITTER	Note!
Sensitivity	-108 dBm for BER $10^{-6}$		
Spreading Method	Frequency Hopping		
Occupied Bandwidth	120 kHz		
Transmitter Power		250 mW and 1 W	
Data Rate	64 kbit/s		
Modulation Method	2-FSK		
Hopping Bands	USA (902.2-927.6 MHz, 128 channels) Australia (915.2-927.6 MHz, 63 channels)		
Hopping Patterns	10 per band, user selectable		

## 3 TIME PARAMETERS FOR STARTUP AND SHUTDOWN SEQUENCES

The following table shows the recommend times for startup and shutdown sequences.

Parameter	Recom. Time <sup>(*)</sup>	Explanation
$t_{vccin-ena}$	>2 ms	VCC_IN must be high before ENA_MOD is high
$t_{enamod-io}$	>2 ms	ENA_MOD must be high before VCC_IO is high
$t_{enamod-cts}$	$100\text{ ms} < t_{enamod-cts} < 500\text{ ms}$	CTS ready settling time
$t_{vccio-cts}$	>2 ms	VCC_IO must be high before CTS is ready
$t_{vccio-gpio}$	>2 ms	VCC_IO must be high before GPIO PINS are active
$t_{gpio-cts}$	>0 ms	GPIOs must be active before CTS is ready
$t_{enamod-gpio}$	>80 ms	Input pins must be low after ENA MOD is low
$t_{gpio-vccio}$	>0 ms	GPIOs must be low before VCC_IO is low
$t_{vccio-vccin}$	>0 ms	VCC_IO must be low before VCC is low

### 3.1 Startup sequence

The following diagram will describe the startup sequence.

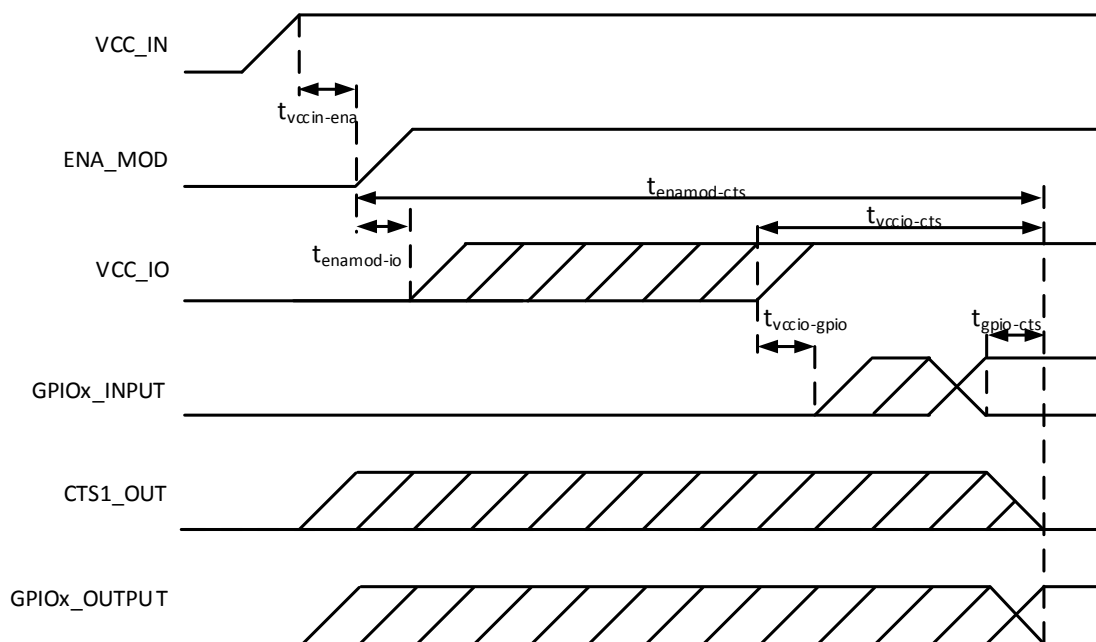

Figure 3.1 Startup sequence.

### 3.2 Shutdown and ENA sequences

The following diagrams will describe the shutdown and ENA sequences.

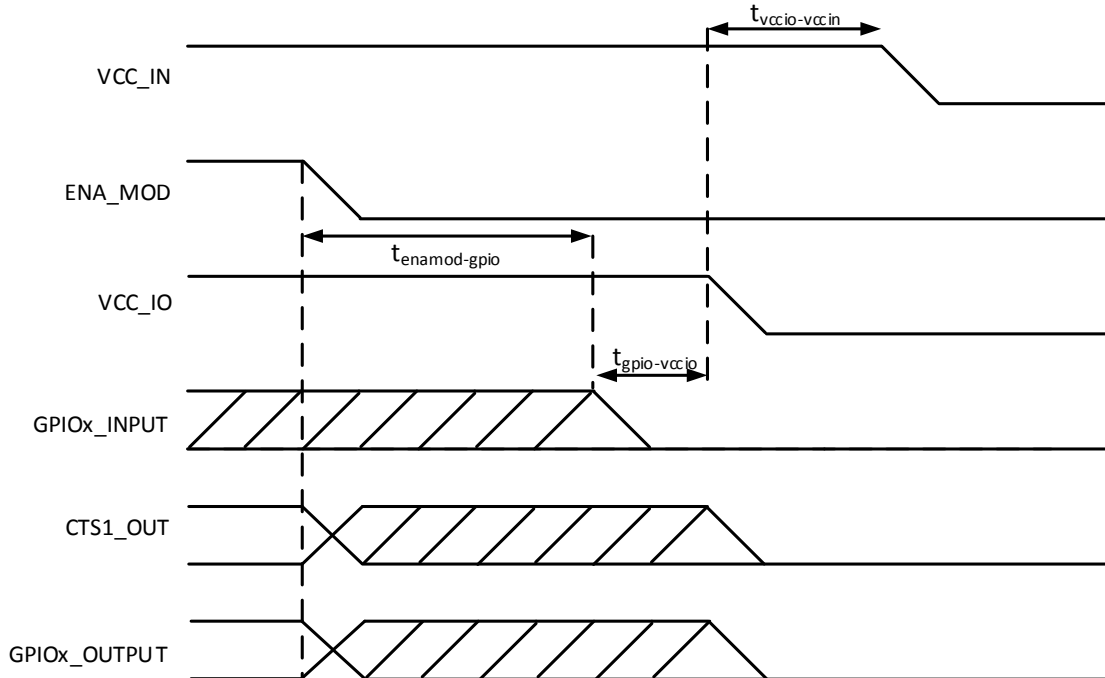

Figure 3.2 Shutdown sequence.

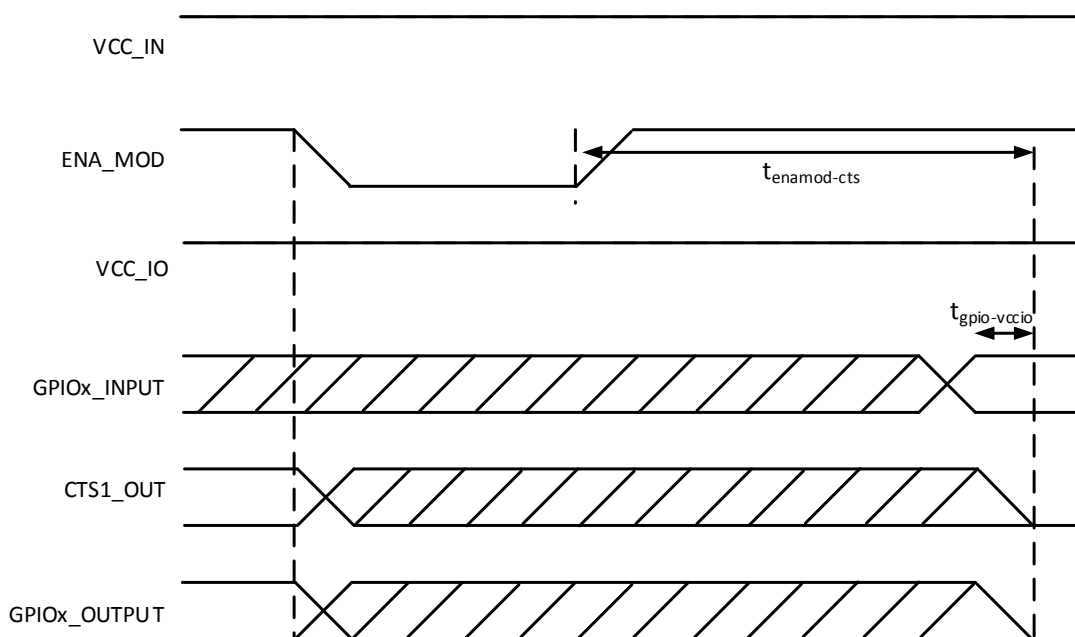

Figure 3.3 ENA sequence.

## 4 ELECTRICAL INTERCONNECTION

### 4.1 DTE connector

The DTE connector is a 20-pin pass-through connector which provides electrical connections to the module. Connector is female two row 1.27 mm pitch.

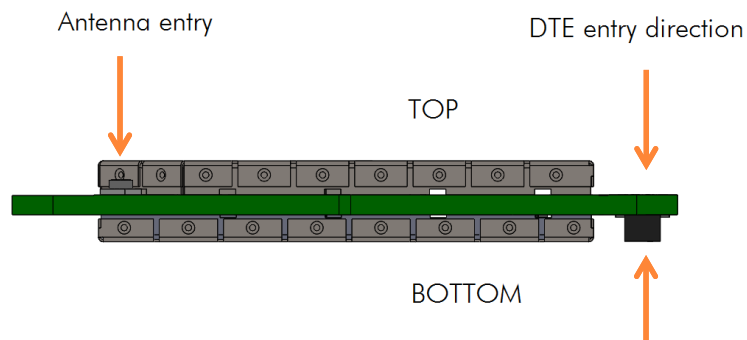

Figure 4.1 The side view of the module with connection directions.

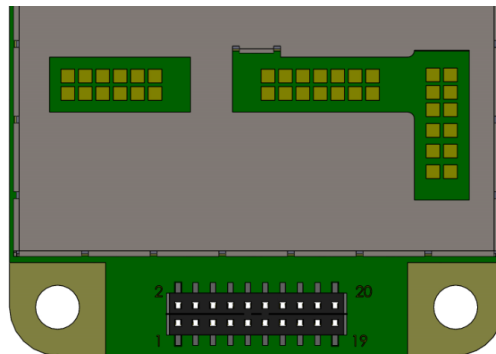

Figure 4.2 Pin numbering of 1.27 mm pitch DTE connector. View from bottom side of unit.

## 4.2 Pin order of the DTE connector

Direction **IN** is data from DTE (Data Terminal Equipment) to the radio transceiver module.  
Direction **OUT** is data from the radio module to the DTE.

The equivalent I/O schematic figures are shown in the next chapter.

Pin No.	Equivalent I/O Schematic	Signal name	Type	Direction	Pin State	Description
1,2	Figure 1	VCC_IN	POWER	IN	External Voltage	DC input
3,4	-	GND	GND	-	External Ground	Ground reference for power and signals
5	Figure 2	VCC_IO	POWER	IN	External Voltage	Device IO driver input
6	Figure 7	ENA_MOD	IO	IN	Internal Pull Down	Module ENA pin
7	Figure 3	RD1	CMOS	OUT	Output Driver	Receive data, active low.
8	Figure 3	CTS1	CMOS	OUT	Output Driver	Clear To Send, active low.
9	Figure 6	TD1	CMOS	IN	Internal Pull Up	Transmit Data, active low.
10	Figure 6	RTS1	CMOS	IN	Internal Pull Up	Ready to send, active low.
11	Figure 4	GPIO1	CMOS	OUT	Internal Pull Down	Reserved for future use.
12	Figure 4	GPIO2	CMOS	OUT	Internal Pull Down	Reserved for future use.
13	Figure 6	GPIO3	CMOS	IN	Internal Pull Up	Reserved for future use.
14	Figure 6	GPIO4	CMOS	IN	Internal Pull Up	Reserved for future use.
15	Figure 5	STAT	CMOS	OUT	Output Driver	Various sequences (section 4.6).
16	Figure 6	GPIO5	CMOS	IN	Internal Pull Up	Reserved for future use.
17	Figure 6	$\overline{\text{SERVICE}}$	CMOS	IN	Internal Pull Up	Input for service access, active low. See separate section of the manual (section 4.5).
18	Figure 4	GPIO6	CMOS	OUT	Internal Pull Down	Reserved for future use.
19	Figure 4	GPIO7	CMOS	OUT	Internal Pull Down	Reserved for future use.
20	Figure 4	GPIO8	CMOS	OUT	Internal Pull Down	Reserved for future use.

### 4.3 Equivalent I/O Schematics

The module input-output equivalent circuits are shown in the figure and the component values in the table below.

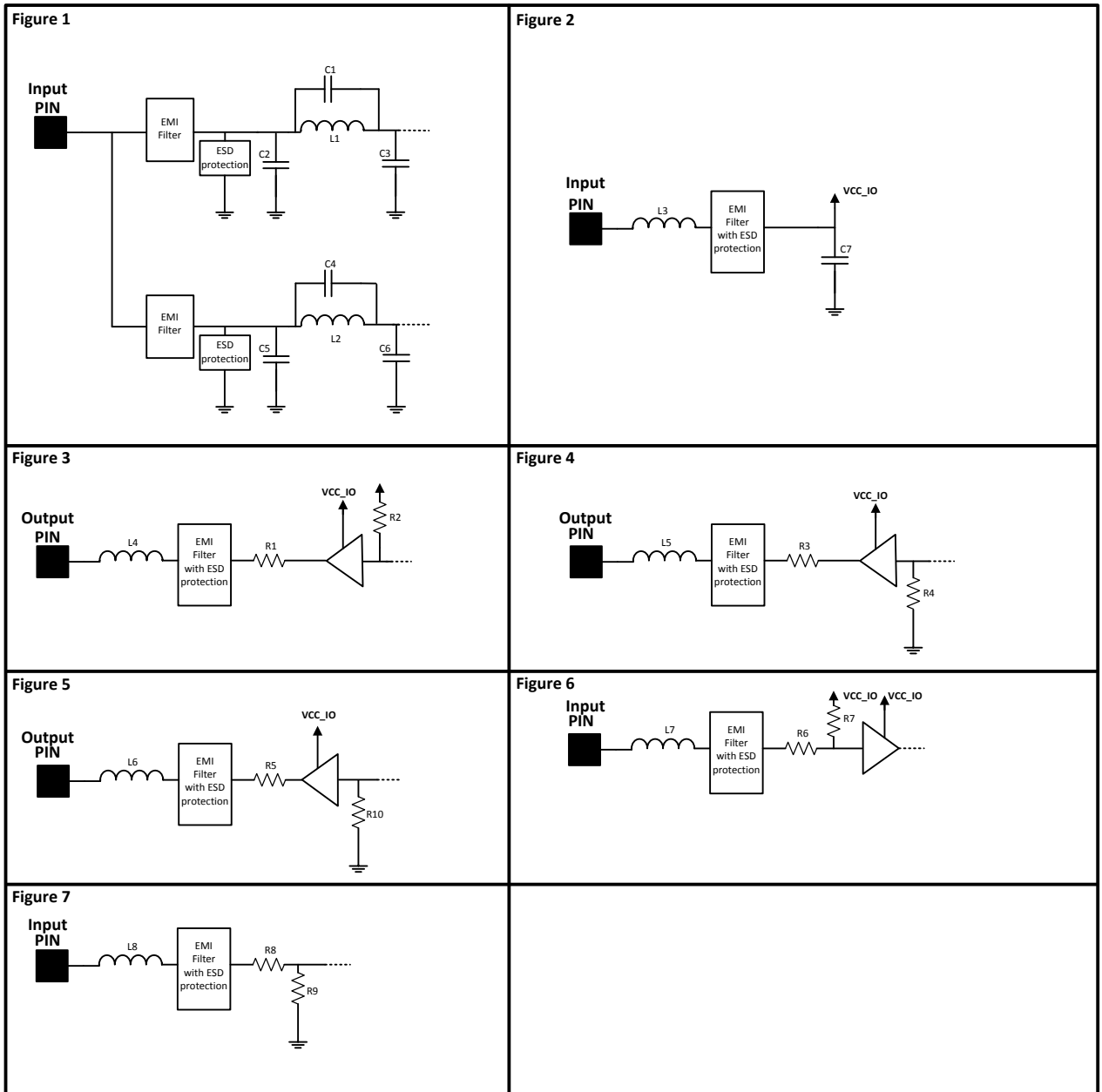

Figure 4.3 The module input-output equivalent circuits.

Component values of the equivalent schematics:

Component	Value	Note
C1	10 nF	
C2	1 nF	
C3	30 $\mu$ F	
L1	2.2 $\mu$ H	
C4	10 nF	
C5	1 nF	
C6	44 $\mu$ F	
L2	15 $\mu$ H	
L3	1000 $\Omega$ +/- 25%	Measured Impedance at 100MHz
C7	100 nF	
L4	1000 $\Omega$ +/- 25%	Measured Impedance at 100MHz
R1	330 $\Omega$	
R2	100 k $\Omega$	
L5	1000 $\Omega$ +/- 25%	Measured Impedance at 100 MHz
R3	330 $\Omega$	
R4	100 k $\Omega$	
L6	1000 $\Omega$ +/- 25%	Measured Impedance at 100 MHz
R5	330 $\Omega$	
L7	1000 $\Omega$ +/- 25%	Measured Impedance at 100 MHz
R6	330 $\Omega$	
R7	100 k $\Omega$	
L8	1000 $\Omega$ +/- 25%	Measured Impedance at 100MHz
R8	1 k $\Omega$	
R9	>1 M $\Omega$	
R10	100 k $\Omega$	

#### 4.4 VCC IO pin

VCC\_IO pin determines the voltage level of UART signals and the voltage level of GPIO output signals. VCC\_IO level also determines GPIO LOW/HIGH levels on each GPIO and UART input pins.

#### 4.5 Service pin

The SERVICE pin is used to set the UART1 into a known state. Pulling this pin LOW will activate the service mode and set the UART1 into 38400, 8, N, 1. This is intended for service access of the module, to have a known serial port setting in order to provide easy access to module settings.

The pin does not affect any permanent settings, nor does it change the mode of the module. It is recommended to pull high or pull up by resistor to VCC\_IO to return serial port 1 into the configured state. When service pin is LOW the SL Commands are temporary forced to be ON

## 4.6 Stat pin

The STAT-pin indicates the status of the device. It can be used to drive or sink a LED current using a proper series resistor. STAT-pin drive or sink capability is +/-10mA at 3.3 V. It is recommended to use VCC\_IO for LED current.

Notice that if STAT-pin is used to sink LED current, LED behavior is opposite to driving scheme. The behavior of the STAT pin is described down below.

Modes of STAT pin:

Blink cycle	Mode
"1" - statically	Module is operational "searching for a new frame"
"0" for the endurance of the received frame.	"0" when module is receiving data from air interface. In practical cases will toggle at the frequency of the data packets on the air interface.
"0" statically	Module is in sleep1 mode
The pin is toggled in transmission interval	Module is sending data Over the Air
Pin is toggled in 1 s interval	Module has the connection to Configuration Manager program.
Pin is toggled in 500 ms interval	SL command mode set to <b>OFF</b> and SL commands enabled using "+ + +" sequence, section 7.2.
Pin is toggled in 250 ms interval	Module has detected a fault, fault codes can be read via Configuration Manager program.

## 4.7 VCC pins

VCC pins are to feed operating voltage to the module. Limit for this voltage is mentioned in chapter 2.2 DC electrical specifications. User must take into consideration surge current and current consumption issues before using these pins. Also the user must be aware for any voltage drop on the feeding path.

## 4.8 UART pins

Pins 7, 8, 9, 10 are used for UART serial transmission between the module and the terminal. The UART signal level corresponds to the level in VCC\_IO pin. VCC\_IO pin must be fed with a correct voltage level to match the terminal device.

## 4.9 GPIO pins

GPIO pins are reserved pins for future use or special applications or special features. Unused pins should be left unconnected.



## **4.10 Antenna interface**

The antenna interface is a 50  $\Omega$  coaxial connector. Matching networks are not included on the module and should be placed in the host application if the antenna is not 50  $\Omega$ . The HIROSE U.FL compatible connector is located on the TOP side of the board.

**NOTE!** The used connector has gold plated contacts - whereas a standard HIROSE U-FL has silver plated contacts. If silver - gold joints are not allowed in your product, use gold plated cable-connector to mate to this device.

## 5 MECHANICAL CONSIDERATIONS

### 5.1 Fixing device to host

The M3-TR8 / M3-TR9 radio transceiver module can be mounted on to the host application by using spacers and screws. It is highly recommended to use conducting metal spacers and screws to create proper electrical conductivity between the module and the host application. Recommended materials for spacers include brass or aluminum and steel screws. User must take care that there is no excessive mechanical stress created to the DTE connector while inserting and attaching the module. Recommended maximum screw size is M3, minimum spacer height between the module and the host application is 3 mm.

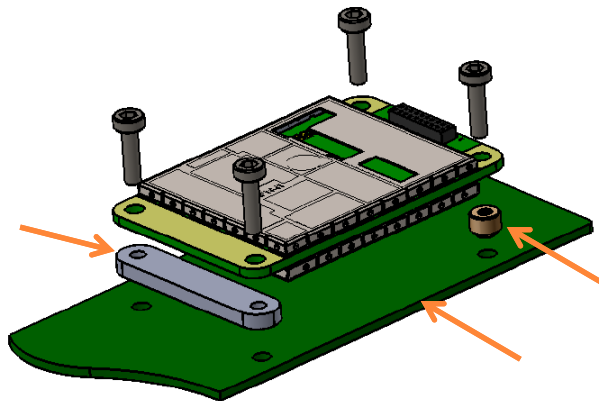

Figure 5.1 Example of module attachment to application PCB.

Since the module creates heat while operating, it must take into consideration to maximize the heat transfer from the module to an external heat sink. Proper heat sinking methods could be copper plated PCB, metal housing or a heat sink piece. The most recommended solution is to use a metal conductor to transfer heat from the module to an external heat sink which dimensions and location is adequate for a proper performance. To source the heat from the module is the plain area next to the antenna connector shown in a figure 5.2. Heat can be conducted from either side. To further improve the heat conductivity and reducing the heat transfer barriers, proper heat conducting paste or heat conducting tape should be used.

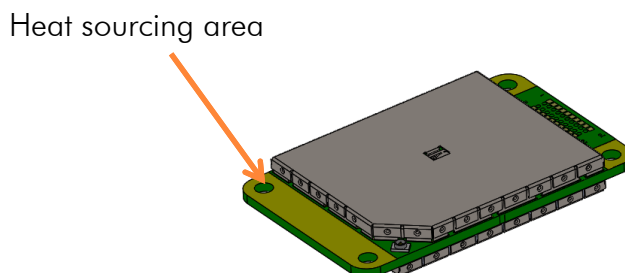

Figure 5.2 Heat sourcing area, both sides.

## 5.2 Module dimensions

In figure below is a module with dimensions as millimeters.

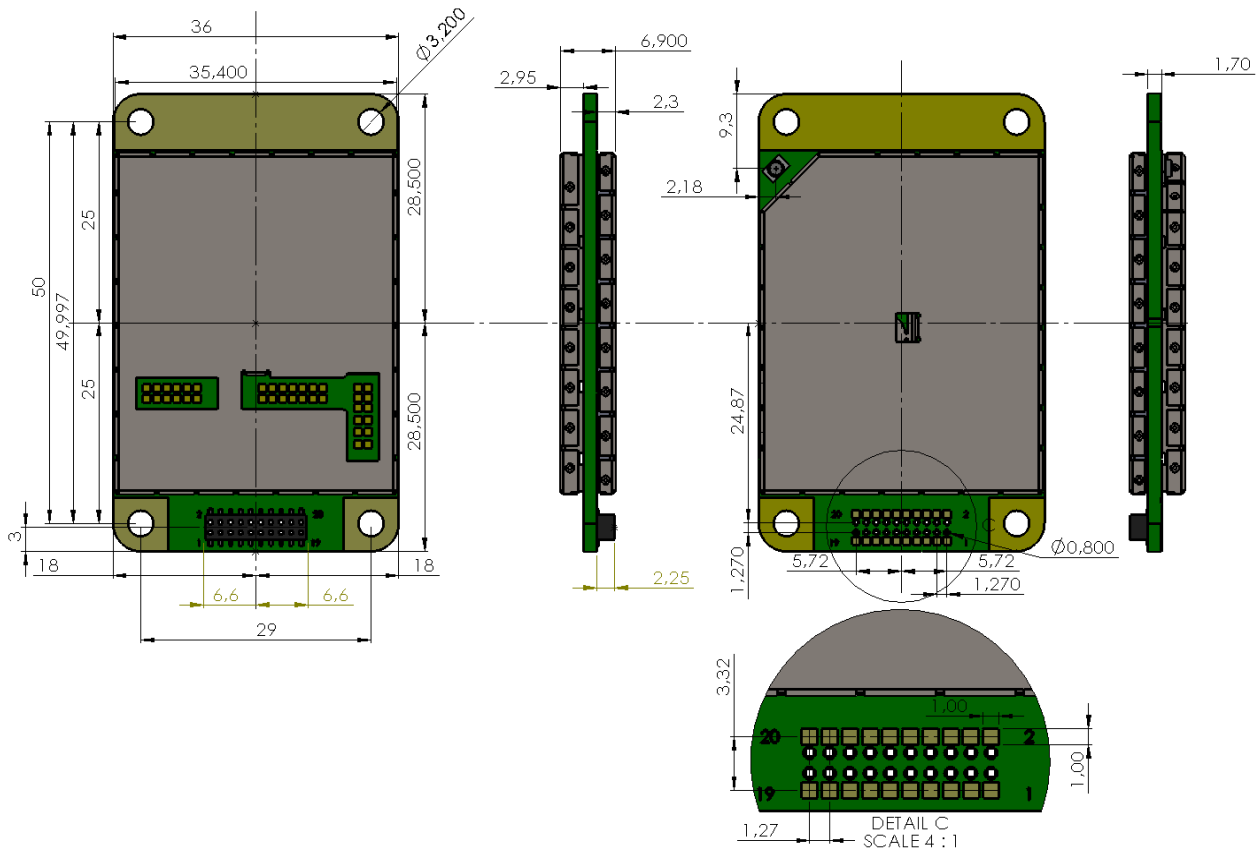

Figure 5.3 The module physical dimensions and the holes in millimeters.

## 6 OPERATING MODES

The radio transceiver module has the following modes of operation:

Mode	Function	Description
Ready to receive from RF	Search for sync	Module is searching for the start of a radio transmission from the RF signal.
	Receive data	The module has found a valid radio transmission and is receiving data.
TX	Transmit	The module transmits
Safe mode		Mode is entered when a fault has been detected and the device has been Rebooted. In safe mode fault codes can be read from the module (section 6.1).
Sleep mode	Sleep1	Will turn the module into a state where it will hold parts of the radio on, wakeup will take approx. 30 ms
Power Save mode	Power save	Automatic sleep/wake-up procedure where module sleeping time is dynamically adjusted to received data packets. Decreases the power consumption of complete receiving cycle approx. 30%.

### 6.1 Safe mode

When a fault has been detected by the Firmware, the module is set to Safe mode. In this mode the module toggle's the STAT pin in 250 ms interval indicating an Error and reboots the device after 5 s. Transmitting/Receiving is prohibited during malfunction. When connecting to the device with SATEL Configuration Manager the Error code is shown in pop up box. If the device does not recover after multiple reboots, please contact SATEL Oy.

SATEL Configuration Manager can be downloaded from website [www.satel.com/downloads](http://www.satel.com/downloads). The version 1.5.1 or newer is compatible with SATELLINE-M3-TR8 radio transceiver module.

### 6.2 Power up / power down scenarios

The transceiver module can be set in four (4) states, "ON", "OFF", "Sleep1" and "Power Save". When power is applied to the module, the module switches to ON state when voltage in ENA\_MOD is set to HIGH.

The module can be shut down by driving ENA\_MOD line to LOW state. In the "OFF" state current consumption is only that of leakage current from an LDO, section 2.3. In this state all non-essential parts off the module are powered down and all settings/state information that are not stored in nonvolatile memory are reset.

### **6.3 Sleep Mode**

When being in sleep mode, the radio part of the module is switched OFF while the serial interface communication related parts remain powered ON. The module will be automatically woken up after the CPU senses a state change in the TD1 pin. *Example:* The module is in Sleep1- mode. The module is woken up by sending a character or characters into the TD1 pin after which the module responses "OK". After "OK" the module is ready for normal communication.

To turn the module ON from Sleep1 mode:

- 1) Issue a state change to TD1 (toggle pin (minimum pulse duration time 10  $\mu$ s) or issue a byte on the UART (for example 0x00))
- 2) Wait for "OK" -response from the module. The wake-up time is approx. 30 ms.
- 3) Start communicating normally

Module will remain powered ON until a new sleep command is issued.

### **6.4 Power Save Mode**

The Power save mode performs an automatic, self-adjusting receiver wake-up/sleep cycle. It is designed for applications which base on one-way communication with relatively constant TX interval and, in which the data packet separation is  $> 200$  ms.

When enabled, the unit makes the *transmission interval study* basing on four (4) successfully received data packets. The shortest time between transmitted packets is measured ( $t_{min}$ ). Measured value is updated after each successfully received data packet, so that possible changes in the message length becomes noted.

Ensuring that the complete messages will be received even if there occur little variation in transmission interval, some safety margin ( $t_{marg}$ ) is left into Ready to receive from RF mode time.

Safety margin is calculated by dividing the shortest time between transmitted packets ( $t_{min}$  in ms) with 8 and by adding 60 ms to this result:

$$t_{marg} = \frac{t_{min}}{8} + 60 \text{ ms}$$

The length of the whole sleeping period ( $t_{sleep}$ ) is calculated by decreasing the shortest time between transmitted packets ( $t_{min}$ ) with safety margin ( $t_{marg}$ ) and transmission time of the original message ( $t_{TX}$ ):

$$t_{sleep} = t_{min} - t_{marg} - t_{TX}$$

Transmission interval study is started over always after 100 successful sleep/wake-up cycles and, if the expected receiving slot ( $t_{RX \text{ slot}}$ ) with enhanced overlap margin ( $t_{overlap}$ ) has been missed. In latter case the package is considered to be lost.

$$t_{overlap} = t_{marg} + 100 \text{ ms}$$

$$t_{RX \text{ slot}, min} = t_{min} - t_{marg}$$

$$t_{RX \text{ slot}, max} = t_{min} + t_{overlap}$$

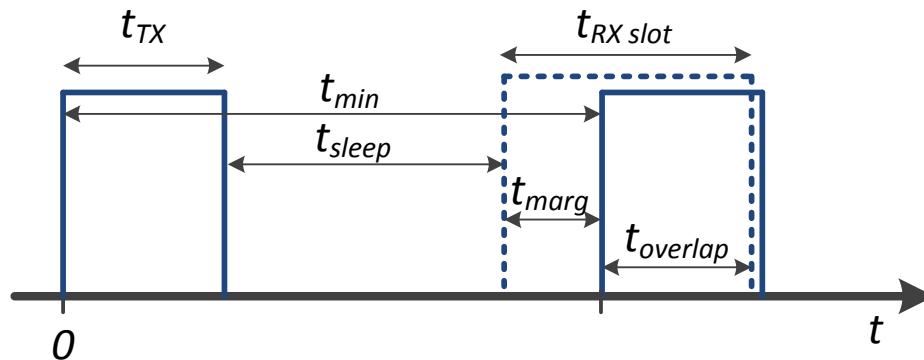

Figure 6.1 Power save mode timing factors.

E.g. In system with TX interval of 1 s, and with 300 ms (approx. 300B @ 9600 bps) transmission time:

$$t_{min} = 1000 \text{ ms}$$

$$t_{TX} = 300 \text{ ms}$$

$$t_{marg} = 125 \text{ ms} + 60 \text{ ms} = 185 \text{ ms}$$

$$t_{sleep} = 1000 \text{ ms} - (125 \text{ ms} + 60 \text{ ms}) - 300 \text{ ms} = 515 \text{ ms}$$

$$t_{RX \text{ slot}, min} = 1000 \text{ ms} - 185 \text{ ms} = 815 \text{ ms}$$

$$t_{RX \text{ slot}, max} = 1000 \text{ ms} + 285 \text{ ms} = 1285 \text{ ms}$$

## 6.5 Restart

After startup the module can be restarted by issuing a SL command, upon which the module will shut down all circuitry, and Reboot the CPU (see SL command list).

## 7 CHANGING PARAMETERS USING SL COMMANDS

The controlling terminal device can change the configuration settings of the module. This is accomplished with the help of SL commands. SL commands can be used to change the device settings e.g. the frequency, addresses etc. SL commands can also be used to request setting values from the module to the controlling terminal.

### 7.1 SL Commands

An SL command is a continuous string of characters, which is used to control the device and its settings for example from the terminal screen (similar to AT commands).

Serial interface settings are the same as in data transfer, however, if SERV pin is set to LOW, baud rate is fixed 38400, 8, N, 1. SL command is properly recognised also in the case when the command string is terminated by <CR> (<CR> = Carriage Return, ASCII character no. 13, Carriage Return, 0x0d in hex) or <CR><LF> (<LF> = Line Feed, ASCII char. no. 10, Line Feed, 0x0a in hex). No extra characters are allowed at the end of an SL command.

SL command is separated from other data by pauses which are equal or greater than time defined by Pause Length-parameter (default = 3 characters) in the settings. If multiple SL commands are sent to the module, the next command can be given after receiving the response ("OK" or "ERROR") of the proceeding command. In addition, it is recommended to implement a timeout to the terminal software for recovering the case when no response is received from the radio module.

The module will acknowledge all commands by returning an "OK" (command carried out or accepted) or the requested value, or an "ERROR" (command not carried out or interpreted as erroneous) message.

The SL commands are listed in appendix B.

### 7.2 SL Command Mode

The SL commands have always been enabled in the previous products like M3-R3. When the SL commands are enabled there are possibilities that the user data may start with the characters "SL" which is handled as the SL command. This has caused the firmware to go to the continuous SL command search mode and any data has not been sent or even an "ERROR" acknowledgment has been received. To avoid this kind of behavior the user can disable the SL commands. The SL commands can be disabled or enabled using the "SL Command mode" parameter. The user can do this via the *SATEL Configuration Manager*, version v1.5.1 or newer.

By default the *SL Command mode* is set to **ON**. If the *SL Command mode* is set to **OFF** then the SL commands can be enabled or disabled using the following procedures:

To enable the SL Commands:

- Send three "+" characters via serial port so that there is at least three bytes delay between each character. The response is "OK", when successfully set.

<+> <at least three bytes pause> <+> <at least three bytes pause> <+>

To disable the SL Commands:

- Send three "-" characters via serial port so that there is at least three bytes delay between each character. The response is "OK", when successfully set.

<-> <at least three bytes pause> <-> <at least three bytes pause> <->

**Note!**

The "+ + +" and "- - -" procedures are not allowed to be used, when radio is transmitting or receiving data (i.e. the application data occupies the TD or RD lines of the radio).



## 8 DEFAULT DELIVERY VALUES – SATELLINE-M3-TR8

DEFAULT VALUES OF THE ADJUSTABLE SETTINGS (the user can change these settings later on)		
Setting	Default value	Range
<b>Radio frequency</b>		
Operating TX and RX frequency	869.4125 MHz	868...870 MHz (See Appendix A)
Operating TX and RX frequency	866.0000 MHz	865...867 MHz
Channel Width	25 kHz	25 kHz
Transmitter Output Power	500 mW	10, 20, 50, 100, 200 and 500 mW
Transmitter Output Power	1000 mW	10, 20, 50, 100, 200, 500 and 1000 mW
<b>Radio settings</b>		
Radio Compatibility	SATEL 3AS	SATEL 3AS
<b>Addressing</b>		
RX Address	OFF	ON/OFF
TX Address	OFF	ON/OFF
<b>Serial port</b>		
Data speed	115200 bps	9600 - 115200 bps
Data bits	8	8
Parity bits	None	None, Even, Odd
Stop bits	1	1
<b>Handshaking</b>		
CTS	TX Buffer State	Handshaking lines apply to the DATA-port Clear to send, TX Buffer State
RTS	Ignored	Ignored, Flow Control
<b>Additional setup</b>		
Error Correction, FEC	OFF	ON/OFF
Error check	OFF	OFF, CRC8Partial, CRC8Full, CRC16Full
SL Command Mode	ON	ON/OFF
Repeater Mode	OFF	ON/OFF
TX Delay	0	0 .... 65535 ms
Over-the-Air-Encryption	OFF	ON/OFF
Use Channel List	OFF	ON/OFF
Power Save Mode	OFF	ON/OFF
Add RSSI to Data	OFF	ON/OFF

## 9 DEFAULT DELIVERY VALUES – SATELLINE-M3-TR9

DEFAULT VALUES OF THE ADJUSTABLE SETTINGS (the user can change these settings later on)		
Operation Mode	Default value	Note
Point-to-Multipoint Slave	3	
<b>Set Baud Rate</b>		
Baud Rate	115200	
Data Parity	0	
Modbus RTU	0	
RS232/485	0	
Setup Port	3	
TurnOffDelay/OnDelay	0/0	
FlowControl	0	
<b>Radio Parameters</b>		
FreqKey	5	
Hop Table Version	0	
Hop Table Size	112	
Hop Freq Offset	0	
Frequency Zone	All 1s (Enabled)	
Max Packet Size	8	
Min Packet Size	9	
Xmit Rate	1	
RF Date Rate	3	
RF Xmit Power	1000	
Slave Security	0	
RTS to CTS	0	
Retry Timeout	255	
Low Power Mode	0	
High Noise	0	
MCU Speed	0	
Remote LED	0	
<b>Multipoint Parameters</b>		
Number of Repeaters	1	
Master Packet Repeat	3	
Max Slave Retry	9	
Retry Odds	9	
DTR Connect	0	
Repeater Frequency	0	
Network ID	255	
Multimaster Sync	0	
Slave/Repeater	0	
Subnet ID	"Disabled"	

## 10 CONSIDERATIONS

### 10.1 EMI Interferers

The module is designed to be mounted inside a host device. The module is designed to withstand EMI even beyond type approval requirements. However, a small module which is integrated closely to modern high speed electronics is bound to receive some interference.

To make a working integration, consider the following: EMI can enter the module in four ways:

- 1) Via the antenna (radiation from enclosure enters the antenna)
- 2) Radiated disturbances to the coaxial cable
- 3) Radiation from other electronics / cabling directly to the module
- 4) Conducting through the DTE interface (power, control and data lines).

Because the module is shielded and the DTE interface is filtered, the usually worst method of disturbance is via the antenna port, which is easily overlooked in design. Keep in mind that the radio module has a sensitivity of approx. -107 dBm (depends on mode of operation and speed etc.). While the module has an approx. 10 dB S/N requirement, this constitutes, that any signal entering the radio antenna on receive frequency on a level of higher than -117 dBm (-107 dBm-10 dB), causes desensitization of the radio on that particular channel.

Example:

An interferer has a level of -100 dBm at the frequency 869 MHz. The radio will show an approximate sensitivity of -90 dB (-100 dBm + S/N requirement 10 dB) at 869 MHz.

Now consider that generic EMC requirements usually have pass/fail criteria of -57 dBm (if normalized to the surface of the device). **So there is almost a 60 dB gap between generic EMC requirements and co-existence requirements between a high sensitivity narrowband radios.**

To avoid problems of co-existence a good design should apply:

- 1) EMI shielding in enclosure – ambient air interface
- 2) Careful layout
- 3) Shielding of all digital high speed parts and cables
- 4) Have a clocking plan to avoid clock frequencies causing harmonics on the UHF band of interest.

### 10.2 Electrostatic discharge

As the module is intended to be embedded in a host application, in a typical use case, the antenna port is the only port of the module directly interface with a surface or contact area subjected to Electrostatic Discharge (ESD). Thus, the antenna port is the only interface with high level ESD protection. The DTE port also features ESD protection diodes, but is not designed to withstand similar performance as expected from standalone units with enclosures.

Consequently, the module should be subject to ESD handling precautions that typically apply to ESD sensitive components. Proper ESD handling and packaging procedures must be applied throughout the processing, handling and operation of any application that incorporates this module.

### **10.3 Using the device in unmanned high reliability applications**

The module features software and hardware watchdogs which are incorporated inside the CPU. While we believe that this is a reliable method of keeping the module in operational condition, there are parts of the module that can't be monitored for proper operation to 100%. For example the module chip has a firmware that resides in the chips RAM. The firmware can't be read back or reloaded, without interrupting reception. Hence the module can't reload this automatically by itself without causing breaks in communication. To avoid the module from ending up in a state where for example the module chip firmware is corrupted for example by ionizing radiation, it is recommended that the controlling system implements some form of watchdog function for the module. This can be done for example if the system knows that data should be received every second, and no data has been received for a minute – then do a module restart using the ENA\_MOD pin or by issuing a restart command, or a cold boot by toggling VCC\_IN low and high again.

## **11 APPENDIX A**

### **11.1 Sub-band Channel Assignment – SATELLINE-M3-TR8**

#### **11.1.1 Sub-band**

Each sub-band is defined by a start and stop frequency. Furthermore the maximum allowed power level and maximum duty cycle is defined separately for each sub-band.

#### **11.1.2 Duty cycle**

The purpose of the duty cycle limit is to ensure that no single application can occupy this license-free band for more than a certain percentage of time. The term duty cycle defines the percentage of a 1-hour period a single modem is allowed to transmit. The modem limits the duty cycle itself.

#### **11.1.3 Power level**

The power level limit is defined separately for each sub-band. The maximum power limit for each sub-band is pre-programmed into the SATELLINE-M3-TR8. The user can choose from 10, 20, 50, 100, 200 and 500 mW ERP\* output power for frequency variant 868...870 MHz and for Indian frequency variant 865...867 MHz following power levels: 10, 20, 50, 100, 200, 500 and 1000 mW ERP\*. No matter what power level the user has chosen the maximum allowed power level of the chosen sub-band cannot be exceeded.

\*ERP = The effective radiated power from the antenna relative to a half-wave dipole in a certain direction.

#### **11.1.4 Channel assignment**

Each sub-band is divided into 25 kHz channels according to a channel assignment scheme defined by the recommendation CEPT/ERC/REC 70-03.

## 12 APPENDIX B

### 12.1 SL COMMANDS – SATELLINE-M3-TR8

Category	Command	Description	Response
Addressing	SL#A?	Show all addresses (RX1, RX2, TX1, TX2)	"xxxx,yyyy,zzzz,vvvv"
Addressing	SL#A=xxxx, yyyy, zzzz,vvvv	Set RX/TX addresses (RX1, RX2, TX1, TX2)	"OK" or "ERROR"
Addressing	SL#I?	Get primary addresses (TX1, RX1)	"xxxx;yyyy"
Addressing	SL#I=xxxx	Set all addresses (RX1, RX2, TX1, TX2) to value xxxx [0000....ffff]	"OK" or "ERROR"
Addressing	SL#P?	Get primary transmit address (TX1) and primary receive address (RX1)	"xxxx;yyyy"
Addressing	SL#P=xxxx;yyyy	Set primary transmit address (TX1) to value xxxx and primary receive address (RX1) to value yyyy [0000....ffff]	"OK" or "ERROR"
Addressing	SL#Q?	Get TX address mode	"0" = TX address OFF "1" = TX address ON
Addressing	SL#Q=x	Set TX address ON/OFF. Values of x are: "0" = TX address OFF "1" = TX address ON	"OK" or "ERROR"
Addressing	SL#R?	Get primary receive address (RX1)	"yyyy"
Addressing	SL#R=xxxx	Set receive addresses (RX1, RX2) to value xxxx [0000....ffff]	"OK" or "ERROR"
Addressing	SL#S?	Get secondary transmit address (TX2) and secondary receive address (RX2)	"xxxx;yyyy"
Addressing	SL#S=xxxx;yyyy	Set secondary transmit address (TX2) to value xxxx and secondary receive address (RX2) to value yyyy [0000....ffff]	"OK" or "ERROR"
Addressing	SL#T?	Get primary transmit address (TX1)	"xxxx"
Addressing	SL#T=xxxx	Set transmit addresses (TX1, TX2) to value xxxx [0000....ffff]	"OK" or "ERROR"
Addressing	SL#W?	Get RX address mode	"0" = RX address OFF "1" = RX address ON
Addressing	SL#W=x	Set RX address ON/OFF. Values of x are: "0" = RX address OFF "1" = RX address ON	"OK" or "ERROR"
ChannelList	SL\$A=1	Go to channel list default channel	"OK" or "ERROR"
ChannelList	SL\$C?	Get number of channels in channel list	decimal number
ChannelList	SL\$C=nn	Set number of channels in channel list. nn = 0...40, 0 clears the whole list	"OK" or "ERROR"
ChannelList	SL\$D?	Get channel list default channel number	decimal number

ChannelList	SL\$D=n	Set channel list default channel, n is channel number	"OK" or "ERROR"
ChannelList	SL\$E=1	Search free channel Modem searches for next traffic-free channel. Listening time of traffic is about 2 seconds Modem shows next free channel by activating command again	"OK" followed by "channel n is free" Value of n is channel number of next free channel on channel list
ChannelList	SL\$F?	Get active channel number	decimal number
ChannelList	SL\$F=n	Set modem to channel number n in channel list	"OK" or "ERROR"
ChannelList	SL\$L?nn	Get channel info. Index nn=[0...(number of channels-1)]	Channel number, Frequency, Channel width, Tx Power For example: "CH 1, 869.412500 MHz, 25.0 kHz, 500 mW"
ChannelList	SL\$L=<info>	Set channel info. Format is SL\$L=laa,Nbbbbbb,Fccccccccc,Wdd dddd,Peeeeee<CR> or alternatively SL\$L=laa,Nbbbbbb,FTccc.cccccc,FRc cc.cccccc,Wdd.ddd,Peeeeee<CR> where capital letter marks parameter field and the following decimal number presents its value. aa = Index (0...39) bbbbbb = Channel number (-32767...32767) ccccccccc = Tx/Rx Frequency in MHz (only numbers or "." allowed, "," is not allowed) F field defines a common frequency value for Tx and Rx FT field defines Tx frequency FR field defines Rx frequency dddddd = Channel spacing/width in kHz (12.5, 20 or 25), trailing decimals are tolerated e.g. "25", "25.0", "25.00" and "25.000" are all valid) eeeeee = Transmitter power in mW (0...35000) (modem rounds the value to the closest applicable) Note: 0 means "don't care" value for power. <CR> = Carriage return character	"OK" or "ERROR"
ChannelList	SL\$M?	Get status of channel list. 0 = Not in use, 1 = Channel list in use	"0" or "1"
ChannelList	SL\$M=n	Set status of channel list. 0 = Not in use, 1 = Channel list in use	"OK" or "ERROR"
ChannelList	SL\$R?	Get listening time (seconds) of Search free channel function	decimal number
ChannelList	SL\$R=n	Set listening time (seconds) of Search free channel function	"OK" or "ERROR"

ChannelList	SL\$\$=<selection >	Set channel scanning mode. Selection: S0 = Stop scanning (supported only by TR3/TR4/TR8) S1 = Starts Scanning RSSI values of the channels in the Channel list (supported only by TR3/TR4/TR8) S2 = Start searching transmission (supported only by TR3/TR4/TR8) 1 = Scan channels one by one and save RSSI readings to memory (supported only by TR1 based products)	"OK" followed by channel/RSSI info See a separate description for more details
DataPort	SL%B?	Get serial data parameters	baud rate, character length, parity, number of stop bits (for example "38400, 8, N, 1")
DataPort	SL%B=a,b,c,d	Set serial data port parameters. a= "115200", "57600", "38400", "19200", "9600", "4800", "2400" or "1200" (defines baud rate) b="8" (defines character length) c= "N", "O" or "E" (defines parity) d= "1" (defines number_of_stop bits)	"OK" or "ERROR"
DataPort	SL%L?	Get Pause length	decimal number
DataPort	SL%L=n	Set Pause length	decimal number
Memory	SL**>	Save current settings as permanent settings	"OK" or "ERROR"
Memory	SL*R>	Restore settings to their factory set values	"Factory defaults restored!" or "ERROR"
ModemInfo	SLIH?	Get hardware info	"HW:nnnnn"
ModemInfo	SLIV?	Get product/variant info	Depending on variant, for example "SATELLINE-M3-TR8"
ModemInfo	SL%1?	Get arbitrary data stored in memory location 1	If empty data is stored, response = "Undefined", otherwise data and carriage return
ModemInfo	SL%1="data"	Set arbitrary data (max 25 characters) in memory location 1	"OK" or "ERROR"
ModemInfo	SL%2?	Get arbitrary data stored in memory location 2	If empty data is stored, response = "Undefined", otherwise data and carriage return
ModemInfo	SL%2="data"	Set arbitrary data (max 25 characters) in memory location 2	"OK" or "ERROR"
ModemInfo	SL%3?	Get arbitrary data stored in memory location 3	If empty data is stored, response = "Undefined", otherwise data and carriage return
ModemInfo	SL%3="data"	Set arbitrary data (max 25 characters) in memory location 3	"OK" or "ERROR"
ModemInfo	SL%4?	Get arbitrary data stored in memory location 4	If empty data is stored, response = "Undefined", otherwise data and carriage return



ModemInfo	SL%4="data"	Set arbitrary data (max 25 characters) in memory location 4	"OK" or "ERROR"
ModemInfo	SL%C?	Get product number (or other customer info)	Depends on setup
ModemInfo	SL%C="text string"	Sets p/n (or other customer info) if it is empty (command works only once). P/n must be stored to eeprom with command SL**> (Save settings). Otherwise it will be lost when power is turned off	"OK" or error message
ModemInfo	SL%D?	Get product type	Depends on model, for example "SATELLINE-M3-TR8"
ModemInfo	SL%H?	Get logic hardware version	Hardware info
ModemInfo	SL%I?	Get Firmware FlashID	Depends on model
ModemInfo	SL%R?	Get Regional Info	Region code number, Status of regional settings followed by CR character. Region code number 0=Default (=not set, or rest of the world), 1=US. Status of regional settings 0=Default(=undefined), 1=Valid, 2=Conflict Example: "1,2" means Region code US and the settings are in conflict to FCC
ModemInfo	SL%S?	Get Serial Number	Serial number of radio modem
ModemInfo	SL%V?	Get firmware revision information	For example "V07.22.2.3.0.2"
OperationMode	SL+S=x	Activate sleep mode. Value of n: "1" Turn the modem into a state where it will hold parts of the radio on, wakeup will take <5ms "5" Turns ON Power Save mode (TR3/TR4 specific command) "6" Turns OFF Power Save mode (TR3/TR4 specific command)	"OK" or "ERROR"
RadioFreq	SLID?	Get lower limit of frequency band 1	"nnn.nnnnn MHz"
RadioFreq	SLIU?	Get upper limit of frequency band 1	"nnn.nnnnn MHz"
RadioFreq	SLIW?	Get lower limit of frequency band 2	"nnn.nnnnn MHz"
RadioFreq	SLIY?	Get upper limit of frequency band 2	"nnn.nnnnn MHz"
RadioFreq	SL&+=nnnn	Set active frequency nnnn channels above center frequency. Frequency = Center frequency + nnnn*Channel spacing Value of nnnn is [0...number of channels/2] For conventional reasons, only 2 or 4 digit inputs are valid	"OK" or "ERROR"
RadioFreq	SL&- =nnnn	Set active frequency nnnn channels below center frequency. Frequency = Center frequency – nnnn*Channel spacing	"OK" or "ERROR"

		Value of nnnn is [0...number of channels/2] For conventional reasons, only 2 or 4 digit inputs are valid	
RadioFreq	SL&B?	Get active subband	Subband Number,Min Freq,Max Freq,Max Power,Duty cycle For example: "1, 869.40000 MHz, 869.65000 MHz, 500 mW, 10%"
RadioFreq	SL&B=z	Set frequency band. Value of z is: "1" 869.4-869.65MHz, 500mW, 10% "2" 869.65-869.7MHz, 25mW, 10% "3" 869.7-870MHz, 25mW, 1% "4" 868-868.6MHz, 25mW, 1% "5" 868.6-868.7MHz, 10mW, 1% "6" 869.3-869.4MHz, 10mW, 1%	"OK" or "ERROR"
RadioFreq	SL&C?	Get center/reference frequency	"nnn.nnnnn MHz"
RadioFreq	SL&X=nnn.nnnn	Set center/reference frequency	"OK" or "ERROR"
RadioFreq	SL&E?	Get Enabled Channel Widths	List of supported Channel widths e.g. "12.5 kHz, 20.0 kHz, 25.0 kHz"
RadioFreq	SL&F?	Get active frequency	TX nnn.nnnnn MHz, RX nnn.nnnnn MHz
RadioFreq	SL&F=nnn.nnnnn	Set active frequency to nnn.nnnnn MHz	"OK" or "ERROR"
RadioFreq	SL&FR?	Get Rx frequency	"nnn.nnnnn MHz"
RadioFreq	SL&FR=nnn.nnnnn	Set Rx frequency to nnn.nnnnn MHz	"OK" or "ERROR"
RadioFreq	SL&FT?	Get Tx frequency	"nnn.nnnnn MHz"
RadioFreq	SL&FT=nnn.nnnnn	Set Tx frequency to nnn.nnnnn MHz	"OK" or "ERROR"
RadioFreq	SL&N?	Get active channel calculated from center frequency ( = (active frequency – center frequency)/channel spacing )	decimal number "+nnnn", "-nnnn", "+nn" or "-nn"
RadioFreq	SL&W?	Get channel spacing/channel width	"25.0 kHz"
RadioFreq	SL&W=xxxx	Set channel spacing. Value of xxxx is: "2500" for 25 kHz Command is supported only by hardware variants with adjustable channel spacing.	"OK" or "ERROR"
RadioProperty	SL%F?	Get status of Error correction (FEC)	"0" = FEC OFF , "1" = FEC ON
RadioProperty	SL%F=x	Set Error correction (FEC). Value of x is: "1" Set FEC ON "0" Set FEC OFF	"OK" or "ERROR"
RadioProperty	SL%E?	Get status of Error check and Full CRC16 check modes	"0" Error check off "1" CRC8 Partial "2" CRC8 Full "3" CRC16 Full

RadioProperty	SL%E=x	Set Error check and Full CRC16 check modes. Value of x is: "0" Error check off "1" CRC8 Partial "2" CRC8 Full "3" CRC16 Full	"OK" or "ERROR"
RadioProperty	SL%R?	Get region code setting/status	0,0 = Default, 1,1 = US, 1,2 = US & Illegal radio setting combination (TX is disabled)
RadioProperty	SL@D?	Get Tx delay (ms)	For example "0 ms" or "50 ms"
RadioProperty	SL@D=n	Set Tx delay (ms), n is [0...65535]	"OK" or "ERROR"
RadioProperty	SL@E?	Get supported radio compatibility modes.	List of numbers, separated by commas, showing the supported modes: 0=SATELLINE-3AS.
RadioProperty	SL@F?	Get noise level of radio channel	"-xxx dBm"
RadioProperty	SL@M?	Get repeater function	"O" = Repeater OFF(character O) "R" = Repeater ON
RadioProperty	SL@M=x	Set repeater function. Values of x are: "O" = Repeater function OFF (character O) "R" = Repeater function ON	"OK" or "ERROR"
RadioProperty	SL@P?	Get transmitter output power	One of these values "10mW", "20mW", "50mW", "100mW", "200mW", "500mW"
RadioProperty	SL@P=nnnnn	Set RF output power (mW) Valid values for nnnnn: "10" for 10 mW TX power. "20" for 20 mW TX power. "50" for 50 mW TX power. "100" for 100 mW TX power. "200" for 200 mW TX power. "500" for 500 mW TX power.	"OK" or "ERROR"
RadioProperty	SL@R?	Get RSSI (Received Signal Strength Indication) of last received message (dBm)	"-nnn dBm", nnn is a decimal value of field strength between -80 dBm and -118 dBm. Value is available 7 s after reception, after that the response is "<-118 dBm".
RadioProperty	SL@S?	Get radio compatibility mode	"0" = SATELLINE-3AS
RadioProperty	SL@S=x	Set radio compatibility mode. Value of x is: 0 = SATELLINE-3AS	"OK" or "ERROR"
Reset	SL@X=n	Reset command. Values of n are: "9" Reset modem	"OK" or "ERROR", then modem resets required blocks.

## 13 APPENDIX C

### 13.1 SL COMMANDS – SATELLINE-M3-TR9, Freewave

				<p>General format of the Freewave related SL commands is:</p> <p>Set Emulation mode settings:        SL~E=M1,I&lt;index&gt;,A&lt;Attribute1&gt;,B&lt;Attribute2&gt;,C&lt;Attribute3&gt;,...</p> <p>prefix M indicates the emulation mode (M1 means Freewave, M2 means something else...)        prefix I is the index indicating the specific setting under the emulation mode        prefixes A, B, C, ... indicate the corresponding attributes</p> <p>Get Emulation setting: SL~E?M1,I&lt;index&gt;        Format of response is        M1,I&lt;index&gt;,A&lt;Attribute1&gt;,B&lt;Attribute2&gt;,C&lt;Attribute3&gt;,...</p> <p>Get Emulation settings summary: SL~E?        Response is reserved for the summary of the emulation settings (to be defined later)</p>
Setting name	Type	Values (Range)	Value descriptions	SL Command
Modem Mode	Uin8	0 - 7 , A-B	0: Point to Point Master 1: Point to Point Slave 2: Point to MultiPoint Master 3: Point to MultiPoint Slave 4: Point to Point Slave/Repeater 5: Point to Point Repeater 6: Point to Point Slave/Master Switchable 7: Point to Multipoint Repeater A: Mirrored Bit Master B: Mirrored Bit Slave	SL~E=M1,I1,A<Mode> <Mode> = [0-7,A-B] as presented on the left
Call Book Entry To Call	Uin8	0 - A	0 - 9: Call Book Entry Index A: All	SL~E=M1,I2,A<index> <index> = [0-9,A] as presented on the left

Call Book	Uint8, Uint8[3], Uint8[3], Uint8[3]	0 - 9, 0x0000 00 - 0xFFFF F, 0x0000 00 - 0xFFFF F, 0x0000 00 - 0xFFFF F	0 - 9: Call Book Entry Index 0x000000 - 0xFFFF: Address 0x000000 - 0xFFFF: Repeater1 Address 0x000000 - 0xFFFF: Repeater2 Address	SL~E=M1,I3,A<index>,B<Address>,C<Address> >,D<Address> A indicates Call Book Entry Index field <index> = [0-9] as presented on the left B indicates Address field C indicates Repeater1 Address field D indicates Repeater2 Address field <Address> = [000000-FFFFFF]
Frequency Key	Uint8	0 - E	0 - E: Key for frequency hop table	SL~E=M1,I4,A<Frequency Key> <Frequency Key> = [0-9,A-E]
Frequency Zone	Uint16	0x0000 - 0xFFFF	Used to enable/disable frequency bands Bit 0: 902.2464 - 903.8592 MHz Bit 1: 904.0896 - 905.4720 MHz Bit 2: 905.7024 - 907.0848 MHz Bit 3: 907.3152 - 908.6976 MHz Bit 4: 908.9280 - 910.3104 MHz Bit 5: 910.5408 - 911.9232 MHz Bit 6: 912.1536 - 913.5360 MHz Bit 7: 913.7664 - 915.1488 MHz Bit 8: 915.3792 - 916.7616 MHz Bit 9: 916.9920 - 918.6048 MHz Bit 10: 918.8352 - 920.2176 MHz Bit 11: 920.4480 - 921.8304 MHz Bit 12: 922.0608 - 923.4432 MHz Bit 13: 923.6736 - 925.0560 MHz Bit 14: 925.2864 - 926.6688 MHz Bit 15: 926.8992 - 927.8208 MHz	SL~E=M1,I5,A<Frequency Zone> <Frequency Zone> = [0000...FFFF], each bit enables (1) or disables (0) the corresponding frequency band as defined on the left

Hop Table Version	Uint8	0 - 6	0: 902 - 928 MHz 1: 915 - 928 MHz 2: 902 - 928 MHz, 16 fewer freqs 3: 916 - 920 MHz 4: 921 - 928 MHz 5: 902 - 911 & 919 - 928 MHz 6: 902 - 915 MHz	SL~E=M1,I16,A<Hop Table Version> <Hop Table Version> = [0-6] as presented on the left
Hop Table Size	Uint8	50 - 112	50 - 112: Number of different frequencies in hop table	SL~E=M1,I17,A<Number of different frequencies in hop table> <Number of different frequencies in hop table> = [50-112]
Max Packet Size	Uint8	0 - 9	0 - 9: Defines maximum packet size in transmit	SL~E=M1,I18,A<Max Packet Size> <Max Packet Size> = [0-9]
Min Packet Size	Uint8	0 - 9	0 - 9: Defines minimum packet size in transmit	SL~E=M1,I19,A<Max Packet Size> <Max Packet Size> = [0-9]
Transmit Rate	Boolean	0 - 1	0: Diagnostics 1: Normal	SL~E=M1,I10,A<Transmit Rate> <Transmit Rate> = 0 (=Diagnostics) or 1 (=Normal)
RF Data Rate	Uint8	2 - 3	2: High 3: Normal	SL~E=M1,I11,A<RF Data Rate> <RF Data Rate> = 2 (=High) or 3(=Normal)
Transmit Power	Uint8	10-1000	10 mW 20 mW 50 mW 100 mW 200 mW 500 mW 1000 mW	GET: SL@P? SET: SL@P=
Slave Security	Boolean	0 - 1	0: On 1: Off	SL~E=M1,I12,A<Slave Security> <RF Data Rate> = 2 (=High) or 3(=Normal)
RTS To CTS	Uint8	0 - 2	0: Disabled 1: Enabled 2: ???	SL~E=M1,I13,A<RTS To CTS> <RTS To CTS> = 0 (=Disabled), 1 (=Enabled) or 2 (don't care?)
Retry Timeout	Uint8	8 - 255	8 - 255: Counter value when connection is dropped off if data is not received.	SL~E=M1,I14,A<Retry Timeout> <Retry Timeout> = [8-255]
Repeaters	Boolean		0: Disabled 1: Enabled	SL~E=M1,I15,A<Repeaters> <Repeaters> = 0 (=Disabled), 1 (=Enabled) or 2 (don't care?)
Master Packet Repeat	Uint8	0 - 9	0 - 9: Defines how many times master will send packets	SL~E=M1,I16,A<Master Packet Repeat> <Master Packet Repeat> = [0-9]
Max Slave Retry	Uint8	0 - 9	0 - 9: Defines how many times slave try to transmit data if ack is not received	SL~E=M1,I17,A<Max Slave Retry> <Max Slave Retry> = [0-9]

Retry Odds	Uint8	0 - 9	0 - 9: Defines a random base when slave is trying to resend data to master if Max Slave Retry count is reached. Value 0 means that the slave's data buffer is purged after Max Slave Retry count is reached	SL~E=M1,I18,A<Retry Odds> <Retry Odds> = [0-9]
Repeater Frequency	Boolean	0 - 1	0: Disabled 1: Enabled	SL~E=M1,I19,A<Repeater Frequency> <Repeater Frequency> = 0 (=Disabled) or 1 (=Enabled)
Network ID	Uint16	0 - 4095	0 - 4095: Network ID for multipoint networks. Network ID 255 = Call Book Mode	SL~E=M1,I20,A<Network ID> <Network ID> = [0-4095] Note: Network ID 255 = Call Book Mode
Slave/Repeater	Boolean		0: Disabled 1: Enabled	SL~E=M1,I21,A<Slave/Repeater> <Slave/Repeater> = 0 (=Disabled) or 1 (=Enabled)
TX Subnet	Uint8	0 - 9, A - F	0: Roaming 1 - E: Subnet ID F: Disabled	SL~E=M1,I22,A<TX Subnet> <TX Subnet> = [0-9, A-F] as presented on the left
RX Subnet	Uint8	0 - 9, A - F	0: Roaming 1 - E: Subnet ID F: Disabled	SL~E=M1,I23,A<RX Subnet> <RX Subnet> = [0-9, A-F] as presented on the left
Serial port settings				GET: SL%B? SET: SL%B=

## 13.2 COMMANDS - SATELLINE-M3-TR9, Option 9

All commands are followed by carriage return + line feed (\r\n)

Example command to set channel number: %%set,modem/fh/base,7\r\n

Command	Value (range)	Value descriptions
++++\r\n		Enter Command mode
ATO\r\n		Return to Data mode
%%set,modem/fh/base,	0-9 (inclusive)	Pseudorandom seed for channel hopping
%%set,modem/fh/mode,	0 1 2 3	Normal (2FSK) No Modulation1 No Modulation 0 No Modulation Average
%%set,modem/fh/autofreq,	0 1 2	Automatic Frequency (Uses base number for hopping sequence) One Frequency Load (tuned frequency increments one sequential frequency at a time from low to high, then starts over) One Frequency Not Load ( Frequency stays constant)
%%set,modem/fh/freq,	0-127 (inclusive)	Transmit frequency for non-hopping mode (autofreq,2). Starts at 902.2 MHz for channel 0, increments 200 kHz per channel until channel 127 at 927.6 MHz
%%set,modem/fh/type,	0 1 2 3	OFF Receiver Transmitter Repeater
%%set,modem/fh/rlink,	0 1 2 3 4	Link rate 9600 baud Link rate 12000 baud Link rate 17000 baud Link rate 24000 baud Link rate 51000 baud
%%set,modem/fh/extrlink,	0 1 2 3 4	Link rate 3600 baud Link rate 4800 baud Link rate 6600 baud Link rate 9600 baud Link rate 19200 baud
%%set,modem/fh/power,	0 1	1 W 250 mW
%%set,modem/fh/gsmmode,	0 1 2 3 4	OFF (necessary for primary radio function) Slave Master Direct channel Test
%%set,modem/fh/brport,	1 2 3 4	57600 serial baud rate 38400 19200 9600
%%set,modem/fh/rcts,	0 1	RTS disabled RTS enabled
%%set,modem/fh/prot,	0 1	Protocol Protocol (for repeater mode)
%%set,modem/fh/loc,	0 1	USA / Canada (adjust power / frequency) Australia



## 14 VERSION HISTORY

Version history:

Version:	Date:	Remarks:
0.1	31.03.2015	First Draft.
0.2	20.05.2015	Updated 5.1 and 5.2 startup and shutdown sequences and 1.4 pin order of the DTE connector.
0.3	11.06.2015	Minor corrections and new performance values added.
0.4	11.10.2015	The document has been reorganized and a number of corrections have also been made.
1.0	15.01.2016	First official version.
1.1	11.02.2016	Updated 4.2 Pin order references to correct sections.
1.2	05.01.2017	Added Indian frequency variant infos.
1.3	09.02.2017	Added SATELLINE-M3-TR9
1.4	15.6.2017	Added usage restrictions for SATELLINE-M3-TR9
1.5	2.8.2017	Added permissible antenna types for Industry Canada. Updated RF exposure warning. Added host integration instructions.
1.6	13.09.2017	Added a note to SATELLINE-M3-TR9 integrators, page 3.
1.7	21.09.2017	Inserted chapters 13.2 and 2.5