

# DC POWER CEILING FAN REMOTE CONTROL MANUAL

## LEARNING PROCESS

**NOTE:** The Hand Held Remote Control System is equipped with a learning frequency function which has code combinations to prevent potential interference from other remote units. The frequency on your Receiver and Transmitter units have been preset at the factory. We recommend changing the frequency while installing your ceiling fan instead of using the initial frequency set by the factory (Fig. 1) Please use a small size tool to change the code switch setting.

Step: 1. Within 30 seconds of turning the Receivers AC power ON. Press the transmitter's "OFF" button.

Step: 2. Hold the "OFF" button for over 4 seconds, once the receiver has detected the frequency, the receiver will make one sound, Bi and light flicker twice and turn off, Meanwhile the fan be turn off. This will indicate the receiver has learned the frequency that was previously selected on the transmitter.

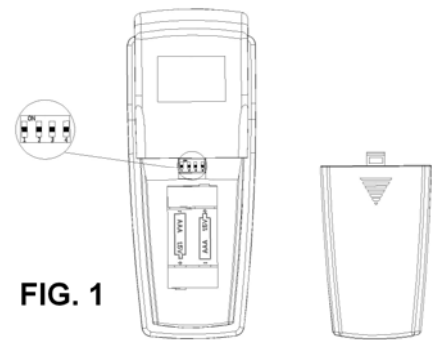

FIG. 1

A: If you would like that the receiver make sound when changing function, you could turn on the sound. The setting way is that you pressing "OFF" button about 4 seconds when you control the ceiling fan. please note that when you reboot power.on ,you need to wait after 30 seconds to perform this operation

B: If you don't need the receiver make sound, you can pressing "OFF" button about 4 seconds when you control the ceiling fan. please note that when you reboot power.on ,you need to wait after 30 seconds to perform this operation

Note: After the AC power is on, do not press any other button on the transmitter before pressing the "OFF" button doing so will cause the procedure to fail.

After completing the steps above, you should be able to operate the ceiling fan and light If the fan is not responding to the transmitter, please turn the power off to the receiver. And repeat step 1 and 2.

Install the DC1.5V/AAA 2PCS batteries. Remove the batteries if not used for long periods of time to prevent damage to the hand held remote.

## FUNCTIONS OF TRANSMITTER

### 1. F/R : "F/R" BUTTION

 shown on LCD : fan wind direction is up

 shown on LCD : fan wind direction is down

### 2. : "NATURAL FLOW" HI/LOW SPEED SWITCH

 shown on LCD : Fan automatically change fan speed to make the natural wind

### 3. FAN : 1~6 FAN SPEED (Press this button to select desired speed, there are 6 different fan speed, release the button after setting)



shown on LCD : This symbol is full when the fan in HI speed

### 4. OFF : To turn the fan off



shown on LCD : turn fan off

### 5. LIGHT : To turn on and turn off the light (Light function only for fans with light kit)

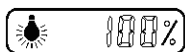

shown on LCD : turn light on



shown on LCD : turn light off

### 6. While Battery power is low as shown on LCD, please replace new DC1.5V/AAA batteries.

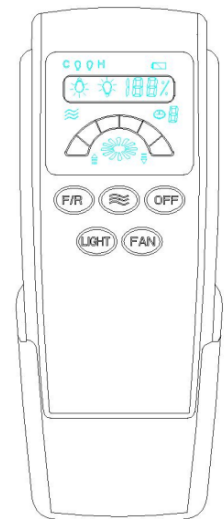

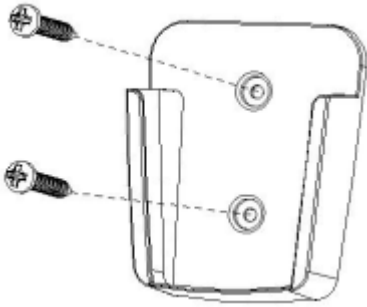

Installation of transmitter wall mount holder with two screws.

**To assure continued FCC compliance:**

**FEDERAL COMMUNICATIONS COMMISSION INTERFERENCE STATEMENT**

This equipment has been tested and found to comply with the limits for a Class B digital device, pursuant to Part 15 of the FCC Rules. These limits are designed to provide reasonable protection against harmful interference in a residential installation. This equipment generates, uses and can radiate radio frequency energy and, if not installed and used in accordance with the instructions, may cause harmful interference to radio communications. However, there is no guarantee that interference will not occur in a particular installation. If this equipment does cause harmful interference to radio or television reception, which can be determined by turning the equipment off and on, the user is encouraged to try to correct the interference by one or more of the following measures:

- Reorient or relocate the receiving antenna.
- Increase the separation between the equipment and receiver.
- Connect the equipment into an outlet on a circuit different from that to which the receiver is connected.
- Consult the dealer or an experienced radio/TV technician for help.

**CAUTION:**

**To assure continued FCC compliance:**

Any changes or modifications not expressly approved by the grantee of this device could void the user's authority to operate the equipment.

**FCC ID : 2AQZU-18002**

This device complies with Part 15 of the FCC Rules. Operation is subject to the following two conditions: (1) This device may not cause harmful interference, and (2) this device must accept any interference received, including interference that may cause undesired operation.