

SATO

CL408e/412e



Quick Guide

CL408e/412e Quick Guide

DECLARATION OF CONFORMITY

SATO America, Inc.
10350A Nations Ford Road, Charlotte, North Carolina 28273
TEL (704) 644-1650

declare under our sole responsibility that the product

CL408e, CL412e

complies with Part 15 of the FCC Rules. Operation is subject to the following two conditions: (1) this device may not cause harmful interference, and (2) this device must accept any interference received, including interference that may cause undesired operation.

FCC COMPLIANCE

This equipment has been tested and found to comply with the limits for a Class B digital device, pursuant to Part 15 of the FCC Rules. These limits are designed to provide reasonable protection against harmful interference in a residential installation. This equipment generates, uses, and can radiate radio frequency energy and, if not installed and used in accordance with the instructions, may cause harmful interference to radio communications. However, there is no guarantee that interference will not occur in a particular installation. If this equipment does cause harmful interference to radio or television reception, which can be determined by turning the equipment off and on, the user is encouraged to try and correct the interference by one or more of the following measures:

- Reorient or locate the receiving antenna.
- Increase the separation between the equipment and receiver.
- Connect the equipment into an outlet on a circuit different from that to which the receiver is connected.
- Consult the dealer or an experienced radio/TV technician for help.

CAUTION

Please maintain the distance at least 20 cm (7.9 in) in an uncontrolled environment from the antenna's surface when using the device.
See FCC OET Bulletin 56 "Hazards of radio frequency and electromagnetic fields" and Bulletin 65 "Human exposure to radio frequency electromagnetic fields."
This device shall not be co-located with any other transmitting antenna.

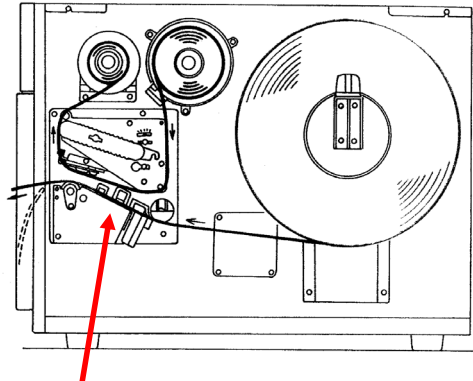

Antenna Position (Cover open view)

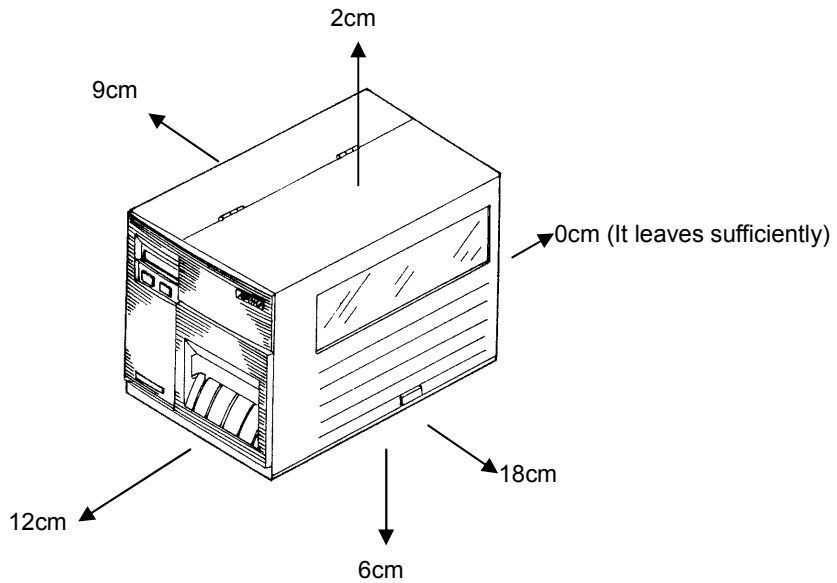

The distance from outside the case

CL408e/412e Quick Guide

Table of Contents

What You Get	3
Controls and Indicators	4
Operator Panel	4
LED Indicators	4
Adjustments	4
Keys	5
Rear Panel Connections	5
Initial Setup	6
Connecting the Printer	6
Printing a Test Label	7
Configuring the Printer	8
Computer Connections	8
CL408e/412e Software and Drivers	10
Label Wizard SE	10
Windows Drivers	11
What to do if it will not print	11
CL408e/412e Specifications	15
Media and Supplies	16
Options	16
Safety Considerations	17
Safety Information	18

This Quick Guide was prepared to get you up and running quickly. It will enable you to get your new SATO CL408e/412e installed and printing with a minimum of effort. However, it is recommended that you familiarize yourself with the contents of the CL408e/412e Operator and Technical Reference Manual for detailed descriptions so you will be able to properly use the printer to its full potential.

CL 408e/412e Quick Guide

What You Get

The CL 408e/412e Thermal Transfer printer comes packed in a protective carton. Included in the carton are the following items:

- CL 408e/412e Printer
- Quick Guide
- Operator and Technical Reference Manual
- Head Cleaning Sheet
- Sample Ribbons and Ribbon Take-Up Core
- Power Cable
- Test Printout Labels
- Label Wizard SE CD-ROM



After taking the CL 408e/412e from the carton and removing the protective plastic cover, it is ready for installation.

CL408e/412e Quick Guide

Controls and Indicators

Operator Panel



LED Indicators

Status: Dark when Off Line
 Green when printer is On Line.
 Red when an error condition exists.

LCD Display: Illuminated when power is applied.

Adjustments (controls behind front panel)

Print: Adjusts print darkness.

Offset: Adjusts amount of back/forward feed for dis-
 pense/cut/tear-off position.

Pitch: Adjusts home position of the label +/- 3.75 mm. Affects
 stop position of label, print position and dispense/cut po-
 sition.

DSW2-3: Sets printer configuration

CL408e/412e Quick Guide

Keys

- Line:** Toggles printer between On Line and Off Line mode. During printing it will pause the printer during a print job.
- Feed:** When Off Line, will feed one blank label. When On Line will print another copy of the last printed label.
- Display Panel:** 2-Line x 16 character LCD for setting operational parameters and displaying error conditions.
- DSW2-3:** DIP switches for configuring printer operation.
- Power:** Turns printer On and Off.

Rear Panel Connections

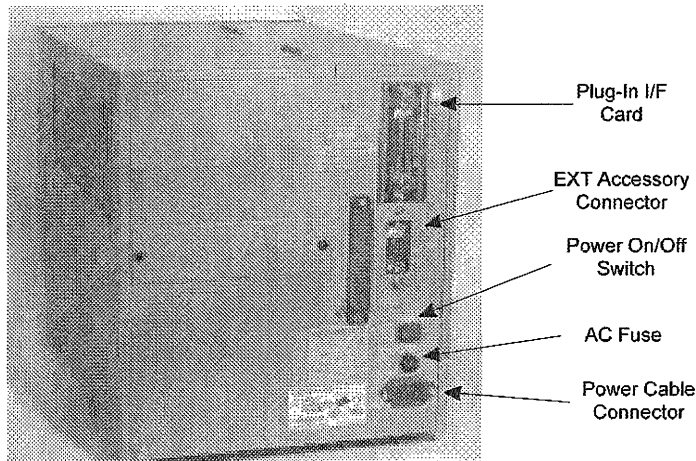

- AC Input:** 115V 50/60 Hz connector. Use the cable supplied.
- AC Fuse:** Input power protection. Type 3A/250V.
- Plug-In Interface:** Plug-In Interface Card. Type specified at time of order. See Operator and Technical Reference Manual for descriptions.
- EXT:** External signal connector, Amp 57-60140.

CL408e/412e Quick Guide

Initial Set-Up

Connecting the Printer

1. Locate a suitable spot for the printer. It should be within 6 ft. of the host if using an IEEE 1284 Parallel interface or within 35 ft. if using a High Speed RS232 interface. For other types of Plug-In interface cards, see the Operator and Technical Reference Manual. Make sure there is adequate room above and to the right of the printer for the label access door to swing open.
2. Plug the AC cable provided into the back of the printer and connect to a suitable 115VAC outlet.
3. Open the print head and load the ribbon using the ribbon routing guide located on the inside of the top cover. Be sure to position the ribbon roll correctly on the Ribbon Supply Spindle and place the spare take-up core on the Take-Up Spindle. Tape the free end of the ribbon to the take-up core so that it will take-up when rotating in a counter clockwise direction.
4. Place the label roll on the Label Supply Spindle and push the green Label Roll Retainer on the spindle until it pushes the label roll all the way to the inside of the printer. The labels should come off the bottom of the roll (labels wound face-in on the roll).
5. Route the labels as indicated by the label routing diagram on the inside of the top cover. The labels should go under the plastic guide, through the Label Sensor Assembly, under the print head and out the front of the printer. Position the Label Edge Guide toward the inside of the printer until it barely contacts the outside edge of the labels.
6. Close the Print Head Latch and then the side access door last.
7. Select the proper label sensing method using the front panel DIP switches. The DIP switch function chart is located on the inside of the front cover. The printer comes from the factory set for label gap detection (DSW2-2, DSW3-3 both OFF). Note that the OFF position for the DSW switches is down and the ON position up.
8. Apply power by placing the front panel Power switch in the "1" position.
9. The Power and On-Line LEDs should be illuminated and ONLINE should be displayed on the LCD.
10. Press the LINE key once. The On Line LED should go out and OFFLINE should be displayed on the LCD.
11. Press the FEED key once. The printer should feed out one label and stop.

CL408e/412e Quick Guide

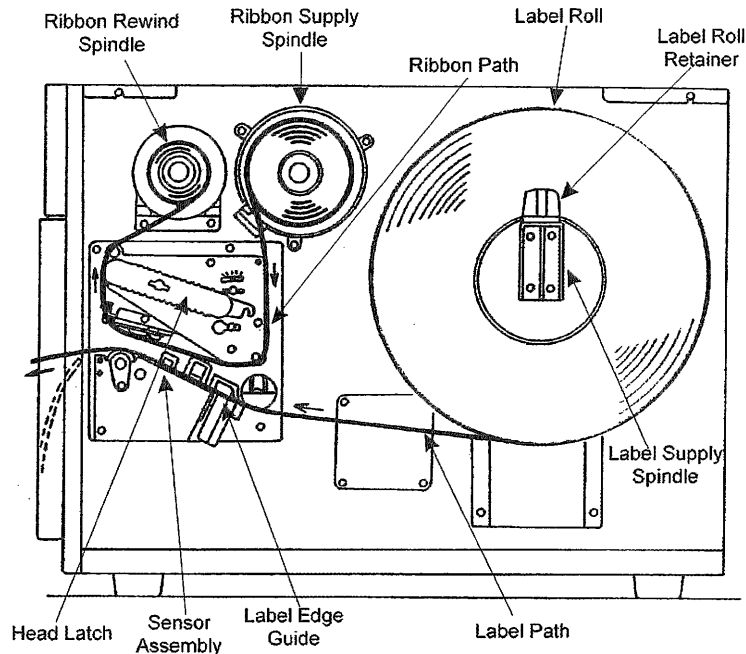

12. If the printer feeds 20" of blank labels and stops with a "SENSOR ERROR" on the LCD screen, check to make sure the labels are properly routed through the label sensor and not over the top of it.
13. Turn AC power off by placing the POWER switch in the "0" position.

Printing a Test Label

After labels and ribbon are loaded into the printer, a test label can be printed using the Front Panel Controls.

1. Apply power to the printer while simultaneously pressing the FEED key.
2. The printer will beep once and display a "TEST PRINT MODE" message on the top line of the LCD screen and "Configuration" on the bottom line. Press the FEED key to accept this test label type.
3. A "TEST PRINT SIZE" screen will appear. If you have labels loaded that are at least 4" wide, use the default 10 cm selection. If your labels are smaller than 4" wide, press the LINE key to toggle the cursor to the selection that is equal to or smaller than the label

CL408e/412e Quick Guide

stock loaded in the printer. Once the correct label size is selected, pressing the FEED key will initiate a test label print cycle.

4. The printer will continue to print test labels until the FEED key is pressed, placing the printer in the PAUSE mode. Pressing the FEED key again will continue the test label printing cycle.
5. To stop printing test labels, pause the printer by pressing the FEED key and then turn power off. Turning power back on will place the printer in the normal On-Line mode where it is waiting for print data.

Configuring the Printer

The CL408e/412e comes from the factory with all Front Panel and Interface DSW switches in the Off (or down) position. DSW-1 is located on the Serial RS232 Plug-In Interface card. This configures the printer for the following operation:

- Thermal transfer printing.
- If a High Speed RS232 Serial Interface is installed, it will be set for 9600 BPS, no parity, 8 data bits, 1 stop bit and Ready/Busy Flow Control. There are no interface settings for the Parallel or USB interfaces.
- Label sensing set to detect label gaps.
- Continuous label printing.

Other features can be enabled with different DSW switch combinations. The function of each DSW switch is listed on a chart on the inside of the front cover. A more detailed description is provided *Section 2 of the Operator and Technical Reference Manual* shipped with the printer. When changing configuration via the DSW switches, the power to the printer must be cycled before the new settings become activated.

Computer Connections

The CL408e/412e has a Plug-In Interface Module that plugs into the interface slot on the back panel. To complete the installation you will need the appropriate interface cable to connect the printer to the output port of the host computer. These can be purchased locally or from your SATO supplier. If you need additional information on interface types, connector types or cabling pin-outs, please refer to *Section 5 of the Operator Manual*.

The most popular interface modules are the IEEE1284 Parallel and the High Speed Serial. Other interface modules available are USB, 10/100BaseT Ethernet and Twinax/Coax.

CL408e/412e Quick Guide

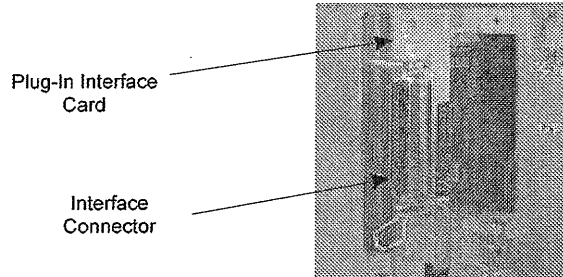

Parallel Interface

If you are using the IEEE1284 Parallel Interface Module, you must use an IEEE1284 compliant interface cable to utilize the full capabilities of the printer. Also the computer parallel (LPT) port should be set to an "ECP" type. The IEEE1284 interface connector is an AMP 57-40360 female 36 pin Centronics type.

The Parallel interface connector is an AMP 57-40360 female 36 pin Centronics type.

Pin #	Description
1	Strobe
2-9	Data bits 0-7
10	Acknowledge
11	Busy
12	Out of Paper
13	Select
14	Auto Feed
16	Logic Ground
17	Chassis Ground
18	+5VDC
31	Initialize
32	Fault
19-30	Signal Ground
36	Select Input

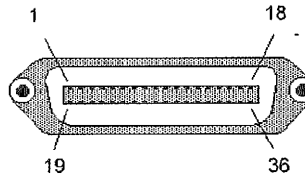

There are no DSW configuration switch settings required for the parallel interface.

CL408e/412e Quick Guide

Serial Interface

Pin #	Description
1	Frame Ground
2	Transmit Data
3	Receive Data
4	Request-To-Send
5	Clear-To-Send
6	Data Set Ready
7	Signal Ground
20	Data Terminal Ready

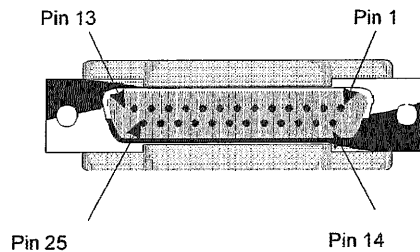

The High Speed RS232 Serial interface connector is a DB-25F. To correctly interface to a PC serial port requires a DB-25P/9P to DB-25F Null Modem Cable. The DSW1 configuration settings for the RS232 data format must match those of the host system. If they do not, the printer will beep when data is sent and display a FRAMING ERROR message on the display. If the Baud Rate selected by DSW1-5 and DSW1-6 does not match that of the host, the printer will ignore any data sent. The serial baud rate and word format settings can be changed on either the printer or the host to correct the condition, but they must match.

CL408e/412e Software and Drivers

Label Wizard SE

A copy of Label Wizard SE is included on the CD-ROM shipped with each printer. Label Wizard SE is an evaluation copy of SATO's Label Wizard Design and Production software for Windows 3.1/95/98/2K. It can be used with any SATO printer. The SE version is a fully functional label design software package but is limited to printing only one label at a time. It can be upgraded at any time to a full Label Wizard version, complete with sophisticated label production capabilities by purchasing an upgrade package from your SATO dealer. Any label design created in the SE version can be used in the upgraded package. The Label Wizard SE software is an excellent vehicle for experimenting with different label designs and demonstrating the features of SATO printers.

When loading the Label Wizard SE software on your PC, make sure that you also load the SATO Generic Printer Driver which is required for printing (this is not the same driver as the Windows drivers described below).

A complete set of Label Wizard documentations is provided on the CD-ROM.

CL408e/412e Quick Guide

Windows Drivers

Windows drivers for the IEEE1284, High Speed Serial, USB and 10/100BaseT interfaces are also provided on the CD-ROM. They let you print labels from virtually any Windows application program. The instructions for loading the drivers are located on the CD-ROM along with the drivers for Windows 3.1, Windows 95/98/2K and Windows NT operating systems. Please note that Windows 3.1, NT4 and early version of Windows 95 do not support USB communications.

After the driver is installed, you can send data to the CL408e/412e just like any other printer on your system: simply specify CL408e/412e in the Print dialog box of your Windows application. Printer configuration is managed using the Advanced dialog box. To print bar codes, you must first define a bar code font using the Barcodes dialog box. Documentation describing how to load, configure and use the Windows driver is contained on the CD-ROM.

Windows drivers are very convenient for printing limited numbers of labels or simple production jobs. However, they can also be very inefficient in the way they transfer data. For example, if you choose a printer resident font, the printer responds very quickly. However, if you specify a Windows TrueType font, it is transmitted to the printer in a graphics format that results in large data transfers to the printer, slowing down the printer response time unless you are using the high speed capabilities of the IEEE1284 interface. It is always best to use a Label Design program that supports all of the features of the SATO printer being used, thereby increasing the efficiency of the operation and ensuring optimum response time.

What to do if the printer won't function

Printer won't go On-Line

- Is the Power LED on? Check the power cable and AC Fuse.
- There is an error condition. Make sure the Head Latch is closed.

Printer beeps and refuses to print

- This is usually caused by an incorrect data stream. Try placing the printer in the Hex Dump mode and printing a copy of the data being sent to the printer. Examine the incoming data stream for incorrect command usage. Refer to the *Operator and Technical Reference Manual* for explanations of proper command usage.

Printer does not print when I send it data.

- Check the interface cable to make sure it is connected to the correct port on the PC.

CL408e/412e Quick Guide

- Make sure the correct Plug-In Interface Module is installed in the printer.
- If you are using the serial interface, verify that the baud rate of the host matches that of the printer.
- Place the printer in the Hex Dump mode and resend the data stream. A list of the received data characters will be printed out in hexadecimal format. See Section 2, Hex Dump Diagnostic Labels on page 35 of the *Operator and Technical Reference Manual* for information on how to place the printer in the hex dump mode. If the data cannot be printed in the Hex Dump mode, the printer is not receiving any data.
- Make sure your computer program is sending data to the correct printer. More than one printer can be assigned to the same port in the Windows Printer dialog box. Make sure the printer listed in the Print Setup window is the CL408e/412e. (Note: The correct printer driver to use for Label Wizard is labeled "SATO Generic")

The printer feeds a label, but does not print anything

- Is the label wide enough? The first dot print position is on the outside edge of the print head and narrow labels are justified toward the inside of the printer. You may have to configure the printer with an Offset value to correctly position the image on the label. Refer to the *Operator and Technical Manual, Section 2* for instructions on how to do this.
- If you are printing in the direct thermal mode, make sure you are using direct thermal paper.
- If you are printing in the thermal transfer mode, check to make sure the ribbon is loaded properly with the ink (dull side) in contact with the media.

Poor quality printing

- If the print has sections missing, visually inspect the print head to make sure it is clean and has no physical damage. If foreign matter is observed, clean the head using a cotton swab and the Thermal Print Head and Platen Cleaner from the SATO cleaning kit.
- If the print is too light, increase the heat setting using either software or the LCD panel. If the print is too dark and the bars in a bar code are fuzzy and run together, lower the heat setting. Fine adjustments can be made by adjusting the PRINT potentiometer on the front panel.

CL408e/412e Quick Guide

- If the print is too light, try varying the print speed using either the LCD panel or software commands.
- Is your ribbon/label combination compatible. Low quality paper labels may have a surface that is too rough for resin based ribbons to adhere. Wax based ribbons may not be able to adhere well to some synthetic label material.

LCD displays "SENSOR ERROR"

- Check to make sure the sensing method selected matches the media loaded. The CL408e/412e comes from the factory set for detecting a label gap (DSW2-2 = On) and there must be a gap of at least 1/8" between labels. If Eye-Mark (a black line across the underside of the label) labels are used, DSW-2 must be On to enable the reflective sensor.
- If continuous media is being used without any type of registration, the sensor must be turned off (DSW3-3=ON). Otherwise, the printer will feed approximately 20" of paper and then give a "SENSOR ERROR" message.
- If the label gap or eye-mark registration bar does not extend across the width of the label, you may have to adjust the position of Label Sensor Assembly. See the *Operator and Technical Reference Manual, Section 2* for information on adjusting the Label Sensor Assembly.
- Make sure the labels are routed *through* the Label Sensor, not over the top of it.

LCD displays "FRAMING ERROR"

- Communication format between the printer and host must be synchronized when using the serial interface. The CL408e/412e RS232 Serial Interface card comes from the factory set for no parity, 8 data bits, 1 stop bit (N,8,1) at 9600 bps and using a Ready/Busy data flow control handshake (DSW1-8 = Off). If the computer is sending data in a different format, the printer is not able to correctly interpret it and a FRAMING ERROR message will appear on the LCD screen.

The printer is receiving data and seems to print, but the labels come out blank

- Check the ribbon to make sure the ink-side (the dull side) of the ribbon is in contact with the label. Other manufacturers may wind their ribbons differently. If they are loaded according to the diagram,

CL408e/412e Quick Guide

it will place the ink-side of the ribbon up. If this happens, you should clean the ink from the print head before reloading the ribbon.

LCD displays a "PAPER END ERROR"

- Are the labels pushed all the way to the inside of the printer and held in position by the Label Edge Guide? The Paper Out switch is located near the inside edge of the label path. If it is not in contact with the media, a PAPER END ERROR results. Check to make sure a notch or hole in the label is not causing the Paper Out switch to give a false indication.

LCD displays a "RIBBON END ERROR"

- If the Ribbon Supply Spindle is not turning, a RIBBON END ERROR will be generated. Make sure the ribbon supply core is not oversize and spinning freely on the spindle.
- If the Darkeness setting is too high, it can sometimes make the ribbon "stick" to the label. The resulting interruption in the ribbon movement can give a false RIBBON END signal.
- Are you printing on direct thermal paper but have not configured the printer for direct thermal printing with DSW2-1=On? In the direct thermal mode, the ribbon motion sensor is disabled since ribbons are not used for direct thermal printing.

CL408e/412e Quick Guide

CL408e/412e Specifications

The following is an abbreviated list of the CL408e/412e specifications. For a complete listing, please refer to *Section 1 of the Operator and Technical Reference Manual*.

Model:	CL408e/412e	
Print Method:	Thermal Transfer or Direct Thermal	
Resolution:	203/305 dpi	8 dpmm/12dpmm
Max. Media Width:	5.0"	128 mm
Max. Print Width:	4.1"	104 mm
Max. Print Length:	49.2/32.8"	1249/833 mm
Max. Print Speed:	6 ips	150 mm/s
Physical Size:	10.7" W x 16.9" D x 12.6" H 271 mm W x 430 mm D x 321 mm H	
Weight:	28.7 lbs.	19 kg
Max. Media Roll OD:	8.6"	218 mm
Label Sensing:	Eye-Mark, Gap, Notch or None	
Min. Form Length:	0.24"	6 mm
Text Fonts:	15	
Ribbon	1475 ft	450 m
Graphics:	PCX, BMP and SATO Hex/Binary	
Bar Codes:	19 including 4 2-D bar codes	
Rotation:	Text and bar codes can be rotated in four 90° increments	
Power:	110/220 VAC +/- 10%, 50/60 Hz, +/- 1%	
Environmental:	Operating:	41° to 104° F (5° to 40° C)
	Storage:	0° to 104° F (-20° to 40°C)
	Relative Humidity:	25 to 85% non-condensing

CL408e/412e Quick Guide

Media and Supplies

The CL408e/412e comes from the factory set up to operate with high quality TechnoTherm thermal transfer media and ribbons. Sample premium quality SATO Standard wax and Premier II wax/resin ribbons are shipped with the printer.

Other media and supplies may or may not give acceptable results in the CL408e/412e. It is likely that you will have to experiment with the heat and speed settings to obtain quality printing. Instructions for adjusting the heat and speed for optimum print quality can be found in the *Operator and Technical Reference Manual* in Section 3.

Options

Plug-In Interface Modules

The CL408e/412e uses Plug-In Interface Modules. The available interface modules are:

- IEEE1284 Bi-Directional Parallel
- High Speed RS232

- 10/100BaseT Ethernet
- Wireless LAN(IEEE802.11b)

Label Dispenser

The CL408e/412e Label Dispense Option is an internal mechanism that provides the ability to print labels in the “demand” mode. When it is installed, the printer dispenses one label at a time, peeling the backing from the label. The excess label backing is taken up on an internal rewind spindle.

Label Cutter

The CL408e/412e Cutter Option is an internally mounted mechanism that will cut labels or tags as they exit from the printer.

PCMCIA Memory Expansion

The Memory Expansion option provides the connectors and interface for one PCMCIA Memory Card. It will accept SRAM memory cards up to 4 MB in size and Flash ROM Memory cards up to 16 MB in size.

CL408e/412e Quick Guide

Internal Memory Expansion

The internal printer memory can be expanded by adding an upgraded Flash Memory module. This adds 4 MB of additional Flash Memory.

Calendar Option

The Calendar Option allows the date and time to be maintained in the local printer where it can be recalled for label printing. The Calendar Option supports both standard and Julian dating.

Label Rewinder

The Label Rewinder is an external mechanism that allows labels to be re-wound on a roll as they are being printed. The maximum roll capacity is 10".

Cleaning Kit

The cleaning kit contains a cleaning sheet, head cleaning solution, cotton-tipped cleaning swabs and cleaning towels for ensuring your CL408e/412e is always capable of the highest quality printing.

Safety Considerations

WARNING - SHOCK HAZARD and STATIC

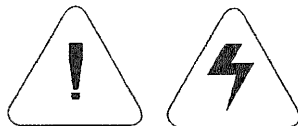

1. Never operate the printer in a location where it can get wet. Personal Injury could result.
2. The discharge of electrostatic energy that accumulates on the surface of the human body or other surfaces can damage the print head or electronic components used in this device. Do not touch the print head or the electronic components.

CAUTION - PRINTER SETUP AND HANDLING



1. When installing or modifying the printer setup or configuration, always turn power off before:
 - Connecting any cables
 - Performing any cleaning or maintenance operation.
 - Moving the printer.



CL408e/412e Quick Guide

Safety Information



The following provides a description of safety precautions relating to use of the printer. Please make sure to read these safety precautions before using the printer.

▲ Symbol Marks

Various symbols marks are used in this instruction manual and printer indications to ensure that the printer is used safely and correctly, and to prevent injuries to the operator or other persons as well as property damage before they occur. The indications and meanings of these symbol marks are shown below. Please read these explanations carefully to ensure an adequate understanding of their contents.

	This symbol mark indicates matters that have the potential to cause death or serious injury if the printer is used improperly as a result of ignoring this mark.
	This symbol mark indicates matters that have the potential to cause personal injury or property damage if the printer is used improperly as a result of ignoring this mark.

Examples of Symbol Marks

-  A triangle indicates that caution is required. Specific matters for which caution is required are shown inside the triangle (caution with respect to electrical shock is shown in the example at left).
-  A circle with a line through it indicates prohibited matters. Specific prohibited matters are either shown inside the circle or near to it (prohibition of disassembly is shown in the example at left).
-  A black circle indicates mandatory matters. Specific mandatory matters are shown inside the black circle (the example at left shows that the plug must be pulled out from an electrical outlet).

WARNING

■ Do not place the printer in an unstable location.

















-  Do not place the printer in an unstable location such as on an unsteady table, inclined location or location subject to vibrations. This may cause the printer to fall or tip over resulting in injury.

■ Do not place containers filled with water, etc. on the printer.

-  Do not place flower vases, drinking cups or other containers filled with water or chemicals as well as metal objects on or near the printer. If the contents should happen to spill and enter the printer, promptly turn off the power switch, unplug the power cable and contact the store where the printer was purchased, your dealer or the service center. Failure to correct this situation can cause a fire or electrical shock.



Safety Information

- **Do not place foreign objects inside the printer.**
 -  Do not allow metal objects or flammable materials to be inserted or fall into openings in the printer (such as the cable outlet or ventilation holes). If an object should happen to get inside the printer, promptly turn off the power switch, unplug the power cable and contact the store where the printer was purchased, your dealer or the service center.
 -  Failure to correct this situation can cause a fire or electrical shock.
 - 
- **Only use the designated voltage.**
 -  Only use the AC adapter provided or the designated power supply unit for this printer.
 - Use of another voltage can cause a fire or electrical shock.
- **Always make sure to ground the printer.**
 -  Always make sure to connect the ground wire of the power cable to ground. Failure to connect the ground wire can cause an electrical shock.
 - 
- **Handling of the Power Cable**
 -  Do not damage, break or process the power cable. In addition, placing heavy objects on the power cable, allowing it to become excessively hot or pulling on it can damage the cable and cause a fire or electrical shock.
 -  If the power cable has been damaged (including exposure or disconnection of the core wires), contact the store where the printer was purchased, your dealer or the service center. Failure to correct this situation can cause a fire or electrical shock.
 -  Do not attempt to process or excessively bend, twist or pull on the power cable. Leaving the power cable in this state can cause a fire or electrical shock.
- **When the printer has been dropped or become damaged**
 -  In the case the printer has been dropped or become damaged, promptly turn off the power switch, unplug the power cable and contact the store where the printer was purchased, your dealer or the service center. Failure to correct this situation can cause a fire or electrical shock.
 - 
 - 
- **Do not use the printer if it is operating abnormally.**
 -  Continuing to use the printer when it is generating smoke, produces an abnormal odor or other abnormality has occurred can cause a fire or electrical shock. Immediately turn off the power switch, unplug the power cable and request repairs to the store where the printer was purchased, your dealer or the service center. Repairs should never attempted to be performed by the customer since this is extremely dangerous.
 - 
- **Never attempt to disassemble the printer.**
 -  Never attempt to disassemble or modify the printer. This can cause a fire or electrical shock. Request internal inspections, adjustment and repairs to the store where the printer was purchased, your dealer or the service center.
 -  Changes or modifications not expressly approved by party responsible for compliance could void the user's authority to operate the equipment.
- **Cutter**
 -  Never place your hands or other objects in the cutter. This can result in the risk of injury.

CL408e/412e Quick Guide

Safety Information



CAUTION

■ **Do not place the printer in locations having high humidity.**



Do not place the printer in locations where there is high humidity or condensation of moisture. In the case moisture condenses on the printer, promptly turn off the power switch and wait for it to dry. Using the printer with moisture condensed on it can cause an electrical shock.

■ **Transport**



When transporting the printer, always make sure to unplug the power cable from the electrical outlet, and only transport the printer after confirming that all cables connecting the printer with outside equipment have been disconnected. Transporting the printer without disconnecting the cables can damage the cable or connection lines causing a fire or electrical shock.



Do not attempt to transport the printer with paper still in the paper tray. The paper can fall out resulting in the risk of injury.



When installing the printer on the floor or table, be careful so that your hands and feet are not pinched by the legs of the printer.

■ **Power supply**



Never operate the power switch, replace the fuse or plug in the power cable or AC adapter with wet hands. This can result in the risk of electrical shock.

■ **Power cable**



Do not place heating devices in close proximity to the power cable. Placing a heating device in close proximity to the power cable can cause the cable covering to melt and cause a fire or electrical shock.



When pulling out the power cable from an electrical outlet, always make sure to hold onto the plug only. Pulling out the cable by the cable can result in the core wires being exposed or disconnected and cause a fire or electrical shock.

■ **Replacing the fuse**



Always make sure to pull out the power cable from the electrical outlet when replacing the fuse.

■ **Cover**



Be careful not to pinch your fingers when opening and closing the cover. In addition, make sure to hold onto the cover securely so that it does not slip and drop down.

■ **Thermal head**



The thermal head becomes very hot after printing. Be careful when changing the carbon ribbon paper or printing paper immediately after printing so that you are not burned.



Touching the edge of the thermal head with your bare hands can result in injury. Be careful when changing the carbon ribbon paper or printing paper so that you are not injured.

The thermal head should not be replaced by the customer. This can result in the risk of injury, burns and electrical shock.

■ **Opening and closing the thermal head**



Be careful when opening and closing the thermal head so that foreign objects other than paper do not enter the thermal head. This can cause injury or damage to the printer.



Be careful not to pinch your fingers when opening and closing the thermal head.

CL408e/412e Quick Guide

Safety Information

■ Installation of paper



When installing paper, be careful not to pinch your fingers between the paper and the paper feeder.
Be careful so that you are not injured when removing the fan-folded paper feed cover.



■ Simple Cutter



This has the structure of a cutting blade. Please be careful not to cut your fingers.

■ When not using the printer for a long time



For safety reasons, unplug the power cable from the electrical outlet when not using the printer for a long time.

■ Care and cleaning



For safety reasons, unplug the power cable from the electrical outlet when performing care and cleaning of the printer.

Handling Precautions

■ Place the printer at a level location.

Placing the printer on an irregular or inclined surface can cause improper printing.

■ Do not place the printer at locations subject to vibrations.

Excessive external vibrations can cause a malfunction and prevent the printer from printing properly.

■ Do not subject the printer to strong impacts.

Subjecting the printer to strong impacts such as by transporting it with paper still installed or dropping the printer can cause a malfunction.

■ Avoid using in locations of high temperature and humidity.

Avoid using the printer in locations where there are high temperatures and high humidity.

■ Protect the printer from dust.

Accumulation of dust inside the printer can prevent the printer from printing properly.

■ Avoid direct sunlight.

Since the printer uses an optical sensor, use of the printer in direct sunlight can cause the printer to operate improperly.

■ Do not use near large machinery.

Use of the printer near large machinery using large capacity electrical power can cause it to operate improperly due to electrical noise and so forth.

■ Use a power source with minimal voltage fluctuations.

Using the printer while sharing the power source with equipment having high power consumption (such as heaters and refrigerators) can cause it to operate improperly due to voltage drops.

■ Connect the ground wire.

Always make sure to connect the ground wire to prevent current leakage. When grounding facilities are not available, have proper grounding facilities installed.