

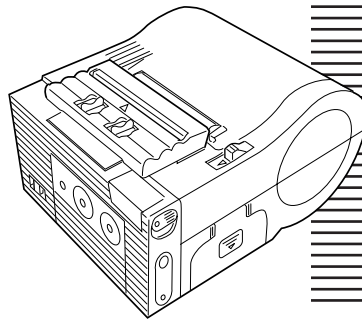

Barcode Printer MB200

MB200

Quick Guide





Warning!

This device complies with Part 15 of the FCC Rules. Operation is subject to the following two conditions:
(1) This device may not cause harmful interference, and
(2) This device must accept any interference received, including interference that may cause undesired operation.

NOTE : This equipment has been tested and found to comply with the limits for a Class B digital device, pursuant to Part 15 of the FCC Rules. These limits are designed to provide reasonable protection against harmful interference in a residential installation. This equipment generates use and can radiate radio frequency energy and, if not installed and used in accordance with instructions, may cause harmful interference to radio communications. However, there is no guarantee that interference will not occur in a particular installation. If this equipment does cause harmful interference to radio or television reception, which can be determined by turning the equipment off and on, the user is encouraged to try to correct the interference by one or more of the following measures:

- Reorient or relocate the receiving antenna.
- Increase the separation between the equipment and receiver.
- Connect the equipment into an outlet on a circuit different from that to which the receiver is connected.
- Consult the dealer or an experienced radio/TV technician for help.



2





Features of the MB200

With compact and lightweight body combined with high performances, this printer prints barcodes clearly on various types of thermal paper.

○Excellent Printing Performance

Not only does this printer print barcodes clearly, but it can also enlarge and print various types of fonts and Kanji characters in a free layout.

○Durable and Easy to Use

This printer is also superb in durability, as it has been designed with the premises of printing barcodes. Also, special consideration has been taken so that the printer can be easily cleaned everyday.

○Dispenser Function

As a portable printer, this printer can easily print and dispense labels to enable the application of labels at site.





Table of Contents

Preparation/Operation

- 1. Safety Precautions 5
 - Markings and Symbols 5
 - Precautions in Use 13
- 2. Unpacking 14
- 3. Parts Name 15
 - Name and Function of Operating Parts .. 17
- 4. Before Starting 18
 - Charging the Battery Pack 18
 - Installing and removing the Battery Pack .. 20
 - Setting Labels 22





1. Safety Precautions

In this section, safety precautions about printer operation are explained to ensure proper care and usage. Make sure to read these carefully before using your printer.

1

Safety Precautions

Markings and Symbols

The following symbols or markings are used in this quick guide and on the printer so that you can properly use the printer, and to prevent any damage to property, harm or injury to yourself and others. Make sure to read their explanations carefully to familiarize yourself with their meanings.



Warning

This symbol indicates information that, if ignored or applied incorrectly, creates the danger of death or serious personal injury.



Caution

This symbol indicates information that, if ignored or applied incorrectly, creates the possibility of personal injury or property damage.

5





Symbol example

Safety Precautions

1



The triangle (\triangle) indicates something you should take absolute care when doing. The cautions are indicated concretely within the symbol. The symbol on the left indicates caution with electric shock.



A diagonal line within a circle (\otimes) indicates something you should not do. The symbol on the left indicates you should not try to take the unit apart.



A black circle (\bullet) indicates something you need to do. The symbol on the left indicates you should unplug the unit from the wall outlet.



6





Warning!

Liquids



Do not place any containers with water or chemicals, such as flower vases or cups, as well as small metallic objects near the printer. If any of these should fall into the printer, immediately turn off the power and contact your nearest dealer or service center. Continued use creates the danger of fire or electrical shock.

Foreign Matter



Do not drop or insert metallic or flammable objects into the openings on the printer (such as outlets for cables). If any of these should fall into the printer, immediately turn off the power and contact your nearest dealer or service center. Continued use creates the danger of fire or electrical shock.

Dropping and Damage



Should the printer ever fall or otherwise become damaged, immediately turn off the power and contact your nearest dealer or service center. Continued use creates the danger of fire or electrical shock.

1

Safety Precautions



7





1

Safety Precautions

Warning!

Abnormal Conditions

 Continued use of the printer while it is emitting smoke or strange odor, creates the danger of fire or electrical shock. Immediately turn off the power and contact your nearest dealer or service center for repairs. Do not try to service the printer by yourself.





Disassembly

 Never try to take the unit apart or modify it in any way. Doing so creates the danger of fire or electrical shock. Contact your nearest dealer or service center for repairs.



Battery Pack

-  Never try to take apart the battery pack or modify it in any way such as with a solder.
-  Never expose the battery to direct flame, throw it into fire, or take any actions that may lead to shorting.
-  When charging the battery pack, make sure to use the specified battery charger.





8





Warning!

AC Adapter / Battery Charger (Optional)

-  Use only the specified voltage. Using a different voltage may create the danger of fire or electrical shock.
-  Never use the battery charger with any other battery pack except for the specified one. Doing so can rupture the battery, cause leakage, fire or electrical shock.
-  Never cut, damage or modify the power cord. Also, never place heavy objects on, set fire to or pull the power cord, as it can damage the cord and create the danger of fire or electrical shock.
- Should the power cord ever become seriously damaged (internal wiring exposed or shorted), contact your nearest dealer or service center. Continued use of such a cord creates the danger of fire or electrical shock.
- Never modify, excessively bend, twist, or pull the power cord. Doing so creates the danger of fire or electrical shock.

1
Safety Precautions





1

Safety Precautions

Caution!

Location



Do not locate the printer in areas subjected to high humidity or dew. If dew forms inside the printer, immediately turn off the power and do not use it until it has dried up. Continued use creates the danger of electrical shock.

Power



Never operate the power switch, replace the battery pack or unplug the AC adapter or battery charger with wet hands. Doing so creates the danger of electrical shock.

This product is intended to be supplied by a power supply (AC adapter) identified as both of the following:
A. Listed Power Unit marked "class2" or I.T.E Power Supply marked "LPS" or UL1950 Power Supply marked "LPS" and rated 7.2V to 9.0Vdc, 3000mA; and
B. CB certified AC adapter, Model SA130A-0930U-S rated 8.4Vdc or 9.0Vdc, or an alternate CB certified AC Adapter which will be added in the CB certification of the product.



10





Caution!

Thermal Head and Stepping Motor



- The thermal head gets very hot after printing. Take care when replacing labels after printed and when cleaning to avoid burn.
- Touching the edge of the thermal head with bare hands may cause injury. Take care when replacing labels or cleaning to avoid injury.
- Do not try to replace the thermal head by yourself. Doing so creates the danger of injury, burns or electric shock.

Easy Cutter



This part contains a blade. Take care to avoid cutting your hands.

1

Safety Precautions







Caution!

Safety Precautions

1

Replacing the Battery Pack

- Use only the specified battery pack.
-  When replacing the battery pack, make sure to install the pack with the poles (+) and (-) facing the correct direction. Incorrectly replacing the battery can rupture the battery and create the danger of injury or damage to surrounding areas due to leakage.
-  When disposing of old battery packs, make sure to contact your nearest dealer or service center.

Not using the printer for a long time

-  Remove the battery pack from the printer and unplug the AC adapter from the wall outlet if you do not plan to use the printer for a long time.

Maintenance and Cleaning

-  For safety during maintenance and cleaning, make sure to remove the battery pack and the AC adapter from the printer.

12





Precautions in Use

Do not place the printer in hot or cold places.
The operation temperature range is within 5°C to 40°C. Do not place it in areas with high humidity or temperature out of the operation range.

FCC Caution:

Changes or modifications not expressly approved by the manufacturer for compliance could void the user's authority to operate the equipment.

IC (Industry Canada) Caution:

The term "IC:" before the radio certification number only signifies that Industry Canada technical specifications were met.

"Operation of this device is subject to the following two conditions: (1) this device may not cause interference, and (2) this device must accept any interference, including interference that may cause undesired operation of the device."

"The installer of this radio equipment must ensure that the antenna is located or pointed such that it does not emit RF field in excess of Health Canada limits for the general population; consult Safety Code 6, obtainable from Health Canada's website www.hc-sc.gc.ca/rpb"

CE Caution:

Hereby, SATO CORPORATION, declares that this MB200 is in compliance with the essential requirements and other relevant provisions of Directive 1999/5/EC.

CE 05600

If you want to get a copy of the original Declaration of Conformity of our products which relates the R&TTE, please contact to web address: www.barcodesato.com

1
Safety Precautions





2. Unpacking

2

After opening the box, make sure that all the printer's accessories are included. If there are any accessories missing, contact your nearest dealer or service center.

Unpacking

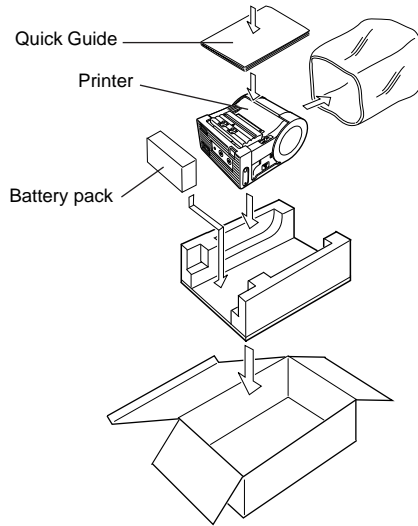

14





3. Parts Name

3

Parts Name

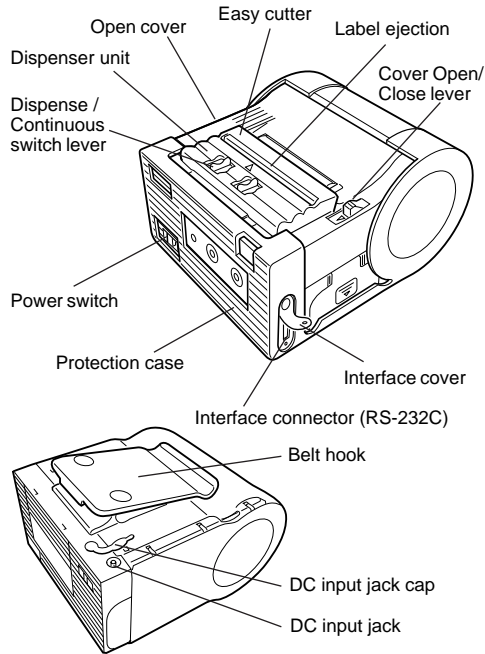



3

Parts Name

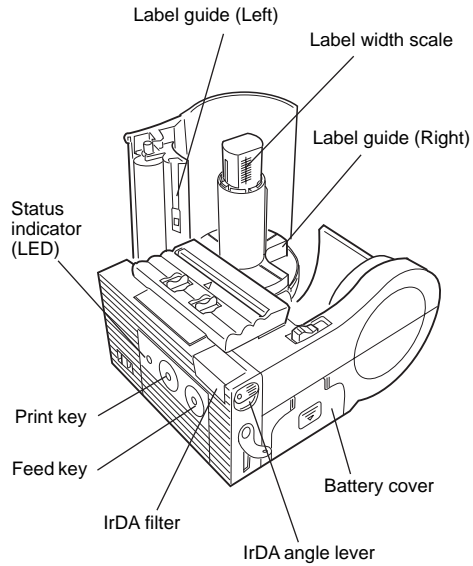

16





Name and Function of Operating Parts

Interface connector (RS-232C):

Used for connecting to a computer.

Interface cover:

Cover for the interface connector.

Open cover:

Opened for setting labels.

Cover Open/Close lever:

Used for opening and closing the cover.

Easy cutter:

Used for cutting printed labels.

IrDA adjustment lever:

Used for changing the angle of the IrDA receiving element.

IrDA filter:

The IrDA receiving element is located inside.

Dispenser unit:

Moved when the Dispense mode is selected.

Power switch:

Used for turning the power on and off.

Battery cover:

The battery pack is inserted here.

Belt hook:

Used when hanging the printer on the belt.

* Do not hang the printer on to anything else but a belt.

Label guide:

Adjusted to the label size being used.

Label ejection:

The printed label comes out from there.

Label width scale:

Scale for measuring the width of the label being used.

DC input jack:

Used for connecting the AC adapter.

DC input jack cap:

Cap for covering the DC input jack.

Feed key:

For feeding labels

Print key:

For setting the printer to online or offline.

Status indicator (LED)

For displaying the status of the printer.

3

Parts Name





4. Before Starting

4

Charging the Battery Pack

Before Starting

Place the battery pack on the battery charger (optional) to charge it.

- 1 Plug one end of the power cord into the battery charger and the other end into the wall outlet.

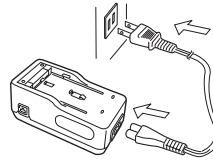

- 2 Place the battery pack on the battery charger and slide it in the direction of the arrow. When the battery pack starts charging, the charger indicator will light up in orange. When the battery pack is fully charged, the charger indicator will turn off. (Fully charged).

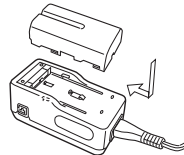

- 3 Remove the battery pack from the charger after it has finished charging. Slide the battery pack from the charger in the opposite direction to when placed on the charger.



18





Notice

- If the indicator on the charger does not light up, make sure that the battery pack is firmly attached to the charger. The battery may not charge, if not firmly attached.
- When an already charged battery pack has been attached on the charger, the indicator on the charger will turn on once and then off.
- If charging a battery pack that has not been used for a long period, the indicator on the charger may flash for a while. This does not indicate an error, and you can continue charging as it is.
- The battery pack can be charged up to 300 times (during use in regular temperatures). If the battery pack is fully charged but soon runs out, replace the battery pack with a new one.

4

Before Starting



Charging Time

The duration of the battery pack from empty until fully charged is about 2.5 hours.

Battery pack charge confirmation mark

When the battery pack is removed from the printer, the charge confirmation mark on the back of the battery pack is blank.

When attaching the battery pack on the charger once and then removing it, a green black box (■) will appear on the back of the pack.

By looking at the confirmation mark, you can check if the battery is charged or not.

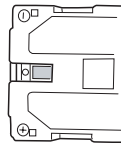

19





Installing and removing the Battery Pack

4

Before Starting

* Remove the Protection case.

- 1 Place your finger on the battery cover ribbed area, and slide it as far as it will move in the direction of the arrow.

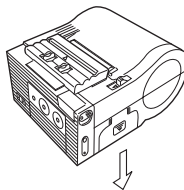

- 2 After releasing the battery cover lock, open the battery cover in the direction of the arrow.

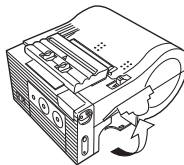

- 3 Insert the battery pack. After that, take the above procedure in reverse order to close the battery cover.

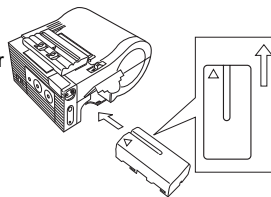

20





- 4** When removing the battery, place your finger into the notch on the battery and pull the battery out.

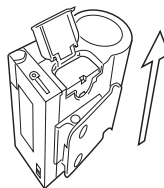

4

Before Starting

- * Make sure to turn the power off when removing or replacing the battery. When the power is turned off, the status indicator will light up in green. Do not remove the battery while the indicator lights up. After making sure that the status indicator is off, you may then remove the battery.
- * If, after turning the power off, you remove the battery pack while the status indicator is lit in green, the information stored in the printer may not be updated.





Setting Labels

4

The method of setting the labels may vary depending on the print mode.

Before Starting

Continuous mode

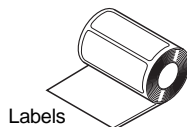

* Remove the Protection case.

1 Place your fingers on the open cover ribbed area, and slide the cover Open/Close lever in the direction of the arrow.

* Slide the Open/Close lever until the ▼ mark on the lever is covered.

Open cover

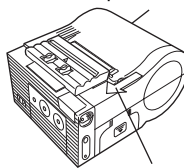

Cover Open/
Close lever

2 When the open cover pops open, fully open the cover in the direction of the arrow.

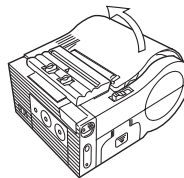

22





- 3 Place the label roll on the spindle on the open cover side.

* When inserting the label roll, make sure to press it down to prevent the labels from raveling out.

* When removing remaining labels, insert your finger in the label core and remove the label with the core to prevent the labels from raveling out.

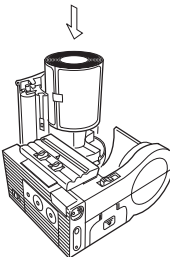

4

Before Starting

- 4 After peeling the leading tape on the roll, take the leading edge of the first label of the roll and pull it out from the label ejection via the platen roller. Then, adjust the label guide (left) to the label size, and pass the label underneath the label guides.

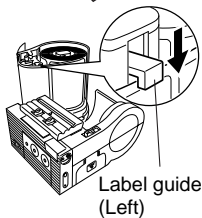

Label guide
(Left)

- 5 Place your fingers on the open cover ribbed area and close the open cover.

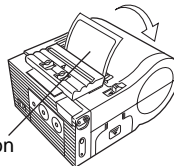

Label set position

This completes the setting of labels when using the Continuous mode.

23





SATO



Q00319002

