

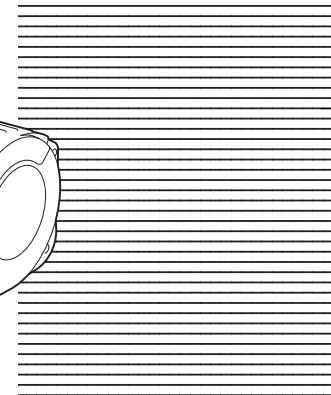

**Barcode Printer**  
*MB200i/MB201i*

---

**Quick Guide**

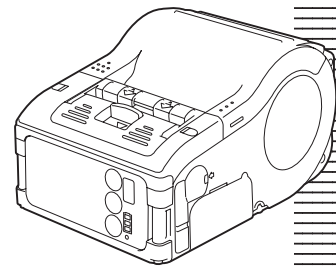

## Introduction

This manual is intended to help you become familiar with the basic operation of MB200i/MB201i the barcode printer in a short time.

Please read this manual carefully to make full use of the functions of MB200i/MB201i.

## Notes

1. Reproduction of all or part of this manual is prohibited without permission of the copyright owner.
2. The information in this manual is subject to change without notice.
3. If you find any ambiguous or erroneous information in this manual, please contact your nearest dealer or service center.

## Table of Contents

Preparation	1. Safety Precautions .....	4
	Markings and Symbols .....	4
	Precautions in Use .....	13
	2. Unpacking .....	15
Operation	3. Parts Name .....	16
	Name and Function of Controls .....	18
Reference	4. Before Starting .....	19
	Charging the Battery Pack .....	19
	Installing and removing the Battery Pack ..	23
	Using AC Adapter .....	25
	Setting Labels .....	26
	• Continuous mode .....	26
	5. Test Printing .....	28
	6. Reference .....	29
	Options .....	29
	DIP Switch .....	30
Basic Specifications of MB200i/MB201i ..	32	

# 1. Safety Precautions

1

In this section, safety precautions about printer operation are explained to ensure proper care and usage. Make sure to read these carefully before using your printer.

Safety Precautions

## Markings and Symbols

The following symbols or markings are used in this manual and on the printer so that you can properly use the printer, and to prevent any damage to property, harm or injury to yourself and others. Make sure to read their explanations carefully to familiarize yourself with their meanings.



**Warning**

This symbol indicates information that, if ignored or applied incorrectly, creates the danger of death or serious personal injury.



**Caution**

This symbol indicates information that, if ignored or applied incorrectly, creates the possibility of personal injury or property damage.

## Symbol examples



The triangle ( $\triangle$ ) indicates something you should take absolute care with. The cautions are indicated concretely within the symbol. The symbol on the left indicates a risk of electric shock.



A circle with a diagonal line ( $\otimes$ ) indicates something you should not do. The symbol on the left indicates that you should not try to take the unit apart.



A black circle with a picture inside ( $\bullet$ ) indicates something you need to do. The symbol on the left indicates that you should unplug the unit from the wall outlet.

1

Safety Precautions





4

5

 **Warning**
**Liquid**

-  Do not place any container with water or chemicals, such as flower vase or cup, as well as small metallic objects, near the printer. If any of these should fall into the printer, immediately turn off the power and contact your nearest dealer or service center. Continued use creates a damage of fire or electric shock.





**Foreign Matter**

-  Do not drop or insert metallic or flammable objects into the openings on the printer (such as outlets for cables). If any of these should fall into the printer, immediately turn off the power and contact your nearest dealer or service center. Continued use creates a danger of fire or electric shock.
-    immediately turn off the power and contact your nearest dealer or service center. Continued use creates a danger of fire or electric shock.



**Dropping and Damage**

-  Should the printer ever fall or otherwise become damaged, immediately turn off the power and contact your nearest dealer or service center. Continued use creates a danger of fire or electric shock.





 **Warning**
**Abnormal Conditions**

-  Continued use of the printer while it is emitting smoke or strange odors creates the danger of fire or electric shock. Immediately turn off the power and contact your nearest dealer or service center. Do not try to service the printer by yourself.
-   



**Disassembly**

-  Never try to take the unit apart or modify it in any way. Doing so creates the danger of fire or electric shock. Contact your nearest dealer or service center for repair.
- 

**Battery Pack**

-  Never try to take apart the battery pack or modify it in any way such as with a solder iron.
  -  Never expose the battery to direct flame, throw it into fire, or take any actions that may lead to shorting.
  -   When charging the battery pack, make sure to use the printer or the specified battery charger.
- 

**Warning****AC Adapter/Battery Charger (Option)**

-  • Use only the specified voltage. Using a different voltage may create the danger of fire or electric shock.
-  • Use only the specified battery charger. Using a different battery charger may create the danger of fire or electric shock.
-  • Never use the battery charger with any other battery pack except for the specified one. Doing so can rupture the battery, cause leakage, fire or electric shock.
- Never cut, damage or modify the power cord. Also, never place heavy objects on the power cord or heat or pull the power cord. Doing so may damage the cord and create the danger of fire or electric shock.
- Should the power cord ever become seriously damaged (internal wiring exposed or shorted), contact your nearest dealer or service center for repair. Continued use of such a cord creates the danger of fire or electric shock.
- Never modify, excessively bend, twist, or pull the power cord. Doing so creates the danger of fire or electric shock.



**Caution****Location**

-  Do not locate the printer in the area subjected to high humidity or dew. If dew forms inside the printer, immediately turn off the printer and do not use it until it has been dried up. Continued use creates the danger of electric shock or the printer damage.

**Power**

-  Do not use wet hands to operate the power switch, replace the battery pack or unplug the AC adapter or battery charger. Doing so creates the danger of electric shock.

**Thermal Head and Stepping Motor**

-  • The thermal head gets very hot after printing. Take care when replacing paper or cleaning the printer just after printing to avoid burn.
-  • Touching the end of the thermal head with bare hands may cause injury. Take care when replacing paper or cleaning the printer to avoid injury.
- Do not try to replace the thermal head by yourself. Doing so creates the danger of injury, burn, or electric shock.

**Easy Cutter**

-  This part contains a blade. Take care to avoid cutting your hands.

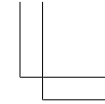
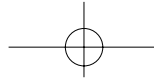
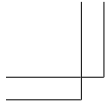

1

Safety Precautions

### Warning

This device complies with Part 15 of the FCC Rules. Operation is subject to the following two conditions:

- (1) This device may not cause harmful interference, and
- (2) This device must accept any interference received, including interference that may cause undesired operation.

#### **FCC Caution:**

Changes or modifications not expressly approved by the manufacturer for compliance could void the user's authority to operate the equipment. NOTE : This equipment has been tested and found to comply with the limits for a Class B digital device, pursuant to Part 15 of the FCC Rules. These limits are designed to provide reasonable protection against harmful interference in a residential installation. This equipment generates and can radiate radio frequency energy and, if not installed and used in accordance with instructions, may cause harmful interference to radio communications. However, there is no guarantee that interference will not occur in a particular installation. If this equipment does cause harmful interference to radio or television reception, which can be determined by turning the equipment off and on, the user is encouraged to try to correct the interference by one or more of the following measures:

- Reorient or relocate the receiving antenna.
- Increase the separation between the equipment and receiver.
- Connect the equipment into an outlet on a circuit different from that to which the receiver is connected.
- Consult the dealer or an experienced radio/TV technician for help.

10

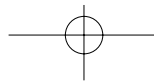
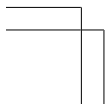

### Warning

This manual show that both the specification of Bluetooth and wireless LAN. Please refer to the corresponding section which shows specification of Bluetooth or wireless LAN.

#### **Wireless LAN specification.**

The available scientific evidence does not show that any health problems are associated with using low power wireless devices. There is no proof, however, that these low power wireless devices are absolutely safe. Low power Wireless devices emit low levels of radio frequency energy (RF) in the microwave range while being used. Whereas high levels of RF can produce health effects (by heating tissue), exposure to low level RF that does not produce heating effects causes no known adverse health effects. Many studies of low level RF exposures have not found any biological effects. Some studies have suggested that same biological effects might occur, but such findings have not been confirmed by additional research. The (Wireless LAN Module (WM-B-AG-02)) has been tested and found to comply with the Federal Communications Commission (FCC) guidelines on radio frequency energy (RF) exposures. The maximum SAR levels tested for the (Wireless LAN Module (WM-B-AG-02))has been shown to be (0.449)W/kg at (Body). This device should not be co-located or operated with any other antenna transmitter.

1

Safety Precautions

11

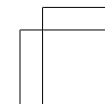

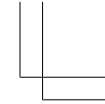
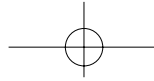
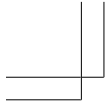

1

Safety Precautions

### Caution



#### Replacing the Battery Pack

- Use only the specified battery pack.
- When replacing the battery pack, make sure to install the pack with the correct direction. Incorrectly replacing the battery create the danger of injury or damage to surrounding areas.
- Replacing a small-size rechargeable battery (Lithium ion battery) Apply insulation treatment for the old battery pack by sealing the contact with tape or the like and ask our sales representative or service center for the measure to be taken for effective use of scarce resource. Do not place the battery pack together with other batteries such as dry batteries.

#### Leaving the printer unused for a long time



If you have no plan to use the print for a long time, remove the battery pack from the printer and unplug the AC adapter from the wall outlet.

#### Maintenance and Cleaning



For safe maintenance or cleaning of the printer, make sure to remove the battery pack and the AC adapter from the printer.

12

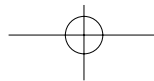
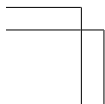

### Precautions in Use

1

Safety Precautions

#### Do not place the printer in a hot or cold place.

The operation temperature range is -15°C to 50°C. Do not place the printer in an area with high humidity or at the temperature outside the specified range.

#### Do not drop or give shock to the printer.

The printer is given a protection against vibration possibly caused during normal transportation. However, do not apply extreme vibration or shock by dropping to the printer.

#### Do not disassemble or modify the printer.

The printer has high-precision components inside requiring fine adjustment. Do not disassemble the printer.

#### Connect the specified cables to the external input terminals.

Special cables are required to connect to the external equipment through the external input terminals. Contact your nearest dealer or service center if necessary.

#### Use a specified option.

Do not use a device not specified as option. Otherwise a fault may occur.

#### Use the specified paper.

Use the specified paper. Otherwise, broken head or faulty printing may occur.

13

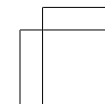

### Bluetooth Specification

This transmitter must not be co-located or operated in conjunction with any other antenna or transmitter.

This equipment complies with FCC radiation exposure limits set forth for uncontrolled equipment and meets the FCC radio frequency (RF) Exposure Guidelines in Supplement C to OET65. This equipment has very low levels of RF energy that it is deemed to comply without testing of specific absorption ratio (SAR).

### Wireless LAN & Bluetooth specification.

IC (Industry Canada) Caution:

"The installer of this radio equipment must ensure that the antenna is located or pointed such that it does not emit RF field in excess of Health Canada limits for the general population; consult Safety Code 6, obtainable from Health Canada's website [www.hc-sc.gc.ca/rpb](http://www.hc-sc.gc.ca/rpb)"

CE Caution:

Hereby, SATO CORPORATION declares that this WM-B-AG-02 is in compliance with the essential requirements and other relevant provisions of Directive 1999/5/EC.

Bluetooth Specification



Wireless LAN specification.



If you want to get a copy of the original Declaration of Conformity of our products which relates the R&TTE, please contact to web address: [www.barcodesato.com](http://www.barcodesato.com)

## 2. Unpacking

After unpacking, make sure that all the printer components are present. If any component or part is missing, contact your nearest dealer or service center.

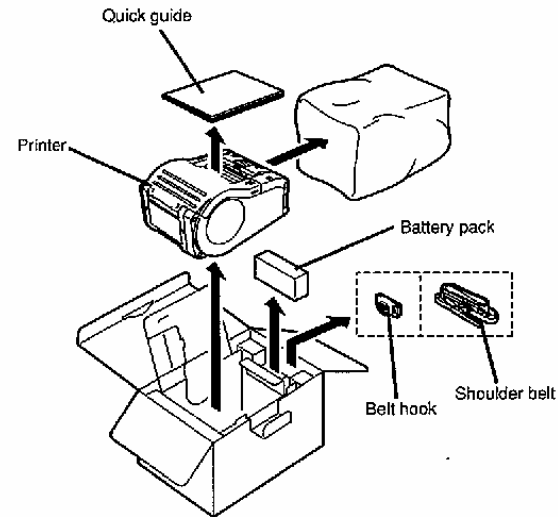

\* Belt holder has already installed on the printer when shipping.  
Shape of cushioning material (protecting pad, etc. for supporting printer) may partly differ by the lot.



### 3. Parts Name

3

Parts Name

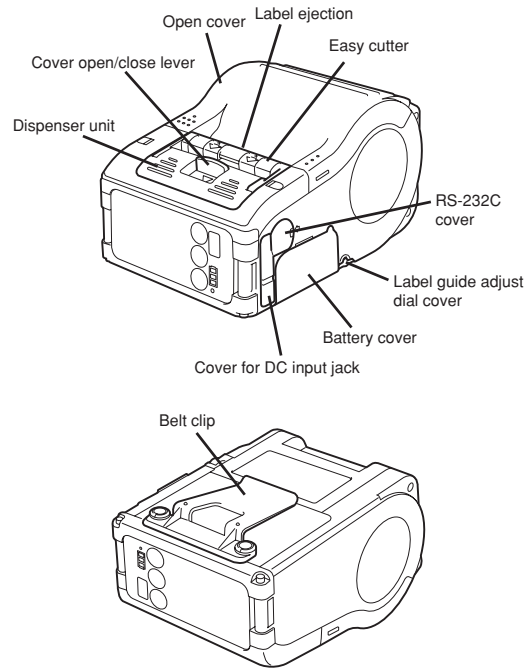

16

3

Parts Name

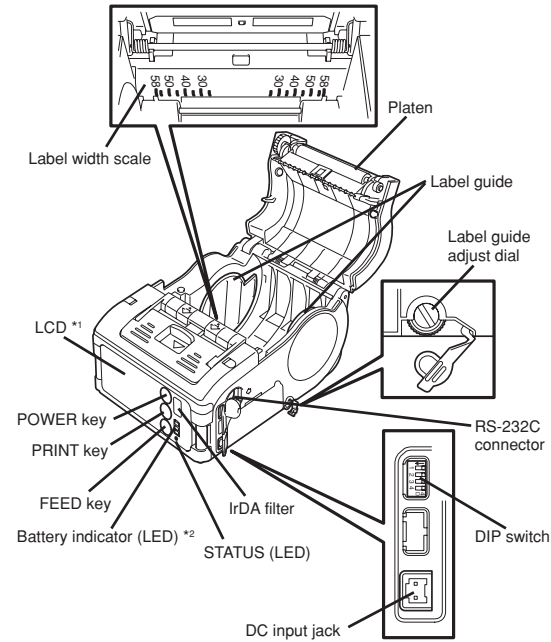

\*1 Operation panel with LCD is built in the wireless LAN interface model only (for manufacture option). For other option information, see "Reference" on page 29.

\*2 Operation panel with LCD for the wireless LAN interface model has CHARGE LED (for manufacture option).

17

## Name and Function of Controls

**RS-232C Interface:** Connects to PC or handy terminal. Used for connecting to a computer.  
Signal: Low level -6.6 to +6.6 V  
High level -6.6 to +6.6 V

**RS-232C cover:** Cover for RS-232C connector.

**Open cover:** Opened for setting labels.

**Cover Open/Close lever:** Used to open or close the cover.

**Easy cutter:** Cuts printed labels.

**IrDA filter:** Contains IrDA sensor and emitter.

**DIP switch:** Sets the operation mode of the printer. (See page 30.)

**Dispenser unit:** Moved to select Dispense mode.

**POWER key:** Turns on/off the printer.

**Battery cover:** Cover for special battery pack.

**Battery indicator (LED):** Indicates the remaining amount of battery of the printer.

**Belt clip:** Used when hanging the printer on your belt.  
\* Do not hang the printer on anything but a belt.

**Label guide:** Set to meet the size of the label used.

**Label guide adjust dial:** Adjusts the label guide to the width of the label used.

**Label guide adjust dial cover:** Cover for label guide adjust dial.

**Label ejection:** Ejects the printed label.

**Label width scale:** Indicates the width of label used.

**DC input jack:** Connects to AC adapter.

**Cover for DC input jack:** Cover for DC input terminal and DIP switch.

**FEED key:** Press to feed label.

**PRINT key:** Sets the printer online or offline.

**STATUS (LED):** Indicates the status of the printer.

## 4. Before Starting

### Charging the Battery Pack

#### • Using the battery charger (option) to charge the battery pack

Follow the steps below to charge the battery pack using the battery charger.

- Use Battery pack Model No. PT/MB200-BAT
- Use Battery charger (Battery pack Model No. PT/MB200-BAT only)
  - ① Single-socket type: Model No. PT/MB200-CHG
  - ② Five-socket type: Model No. PT/MB200-CHG5

**1** Plug one end of the power cord to the battery charger and the other to the wall outlet. (POWER lamp lights red.)

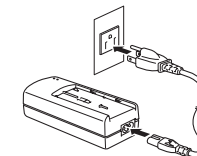

**2** Put the battery pack on the battery charger and then slide it in the direction of the arrow.

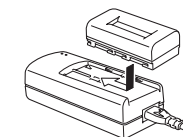

Charging starts and the CHARGE lamp lights orange. When charging is

completed (fully charged), the CHARGE lamp goes off. In case of five-socket charger, charging starts and the CHARGE lamp lights orange. When charging is completed (fully charged), the CHARGE lamp lights green.



- 3 After charging, remove the battery pack from the charger.

Slide the battery pack in the opposite direction of step (2) to remove the battery back.

### Charging Time

It takes about 2.5 hours for the battery pack to reach full charge from a fully discharged state.

### Notice

- If the POWER lamp does not light at the start of charging, check the power cord connection.
- If the CHARGE lamp does not light at the start of charging, make sure the battery pack is firmly mounted to the battery charger. Poor mounting of the battery pack may result in poor charging.
- When the fully charged battery pack is placed on the battery charger, the CHARGE lamp goes on and then off.  
In case of five-socket charger, the CHARGE lamp lights green.
- When charging a battery pack that has not been used for a long time, the

CHARGE lamp may blink for a while. This does not indicate an error. You can continue charging.

- The battery pack can be recharged by about 300 times (when used in normal temperature). If the battery is fully charged but runs out very soon, renew the battery pack.

### • Using the AC adapter (option) to charge the battery pack

The battery pack can be charged while it is mounted in the printer.

- Use AC adapter Model No. PT/MB200-ADP (Sunfone Electronics Co., Ltd. Model No. ACML-06)

- 1 Open the cover for DC input jack and insert the DC output terminal.

- 2 Plug the AC adapter to the wall outlet.

Charging starts and the battery indicator lights red. When charging is completed (fully charged), the battery indicator goes off.

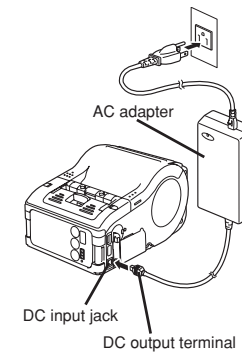

4

Before Starting

In the case of the LCD built-in wireless LAN interface model, CHARGE LED lights red when charging starts and is completed (fully charged), the CHARGE LED goes off.

### Charging Time

It takes about 5 hours for the battery pack to reach full charge from a fully discharged state.

22

## Installing and removing the Battery Pack

1 Open the battery cover.

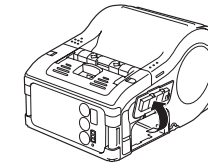

2 Insert the battery pack while pressing and holding the gray hook and close the battery cover.

Insert the battery pack with the terminal side toward the printer.

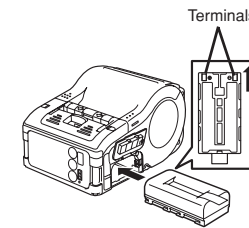

3 When removing the battery, press and hold the gray hook and then pull the tape.

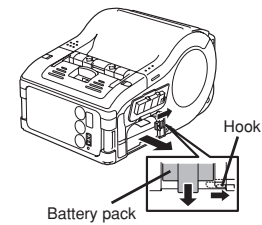

4

Before Starting

23

4

Before Starting

\* Make sure to turn the printer power off when removing or replacing the battery.

When the printer is turned off, the STATUS LED goes off. Do not remove the battery while the STATUS LED is on. Remove the battery when the STATUS LED is off.

\* If you turning off the printer otherwise, the information stored in the printer may not be updated.

24

## Using AC Adapter

Follow the procedure below to use the printer with the AC adapter (option).

- 1 Open the cover for DC input jack and insert the DC output terminal.
- 2 Plug the AC adapter to the wall outlet.

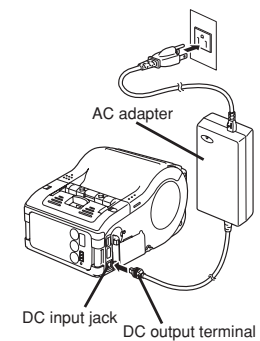

4

Before Starting

\* Be sure to turn the printer power off when removing the DC output terminal of AC adapter or disconnecting the power source.

If you turning off the printer otherwise, the information stored in the printer may not be updated.

A battery pack is unnecessary when an AC adapter is used. If a battery pack and an AC adapter are being used at the same time, the printer starts charging (when a battery is not fully charged) or the battery indicator goes off (when a battery is fully charged).

25

## Setting Labels

4

The method of setting label may vary depending on the print mode.

Before Starting

### Continuous mode

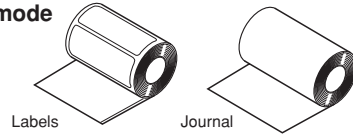

- 1 Slide the Cover Open/Close lever in the direction of arrow to open the cover.

If you are using the printer in Dispense mode, lifting the change lever, slide the dispenser unit until stops.

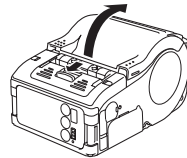

- 2 Place the label to the printer. Pay attention to the direction of the label roll.

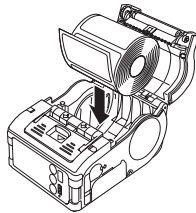

26

- 3 Open the label guide adjust dial cover and turn the dial till the label guide fits with label roll.

Turn the label roll lightly by the hand and confirm that it rotates smoothly.

If a drags is felt, paper may not be fed correctly. Return the dial for adjustment. When using the paper of the same width as that used previously, adjustment of the label guide is not necessary.

- 4 Close the cover after confirming that the leading edge of the label is outside the printer.

This completes the label setting in continuous mode.

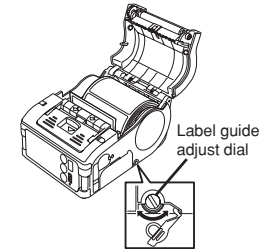

4

Before Starting

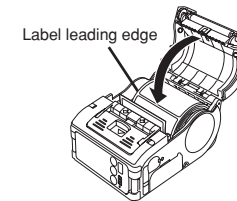
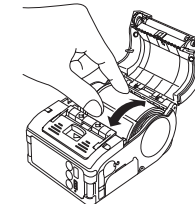

27

## 5. Test Printing

5

Test Printing

- 1 Pressing and holding the FEED key, set the POWER key. The printer enters the test mode. Press the FEED key again to start test printing.

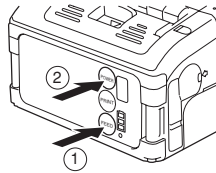

- 2 Verify the following using the output of the test printing.

- There is no chipped character.
- Print condition is good.

In the test printing, the battery residual is indicated by ■■■ (■■■ for full charge).

When the battery indicates ■■■, charge the battery.

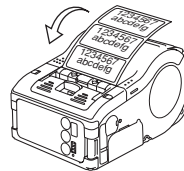

\* If any fault is detected, contact the store you bought the printer, dealer, or service center.

28

## 6. Reference

### Options

6

Reference

#### User Option

##### Battery Pack (Supplied with the printer)

Preparing a spare battery pack will insure uninterrupted operation due to Low Battery.

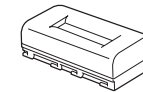

Model No. PT/MB200-BAT

##### Battery Charger (Single-socket)

Charges the battery pack.

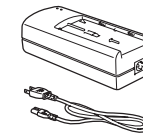

Model No. PT/MB200-CHG

##### Battery Charger (Five-socket)

Charges the battery pack (up to five packs).

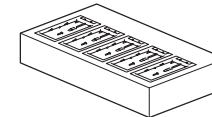

Model No. PT/MB200-CHG5  
Rated Input: DC19 V, 3.2A  
Output: DC8.4 V, 1.1A

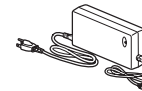

Use AC Adapter Model No. ACH400  
Rated Input: AC100 to 240 V,  
1.2A 50/60Hz  
Output: DC19 V, 3.2A

29

### AC Adapter

Used to supply power from domestic power supply. The DC output terminal of the AC adapter is connected to the printer.

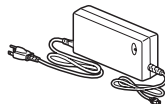

Model No. PT/MB200-ADP  
(Sunfone Electronics Co., Ltd.)  
Model No. ACML-06



- Be sure to use the specified AC adapter.
- Plug or unplug the AC adapter while holding its body.
- Pay attention not to injure the cord.
- Keep the AC adapter unplugged when not in use.

## DIP Switch

### Setting DIP switch

- 1 Turn the printer power off.
- 2 Open the DIP switch cover.
- 3 Change the position of the switch you want to change using a pointed tool such as the tip of ball-point pen.

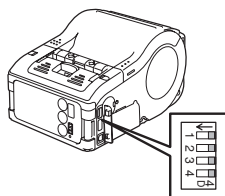

### DIP Switch Setting

DIP switch				Cover	Key		Starting mode	
1	2	3	4		PRINT	FEED	Interface	Description
OFF	OFF	OFF	OFF	Close	OFF	OFF	RS-232C	Normal print mode
				Close	OFF	ON	—	User test print mode
OFF	OFF	ON	ON	Close	OFF	OFF	RS-232C	HEX dump mode
OFF	OFF	OFF	ON	Open	ON	OFF	—	Auto peeling mode
				Open	OFF	ON	—	Manual print mode
OFF	ON	OFF	OFF	Close	OFF	ON	—	User test print mode
OFF	ON	OFF	ON	Open	ON	OFF	—	Head check (print area) designation
				Open	OFF	ON	—	Head check designation clear
OFF	ON	ON	ON	Open	ON	OFF	—	CRC check enable designation
				Open	OFF	ON	—	CRC check disable designation
ON	OFF	OFF	OFF	Close	OFF	OFF	IrDA interface	Normal print mode
				Close	OFF	ON	—	Test print mode
ON	OFF	ON	ON	Close	OFF	OFF	IrDA interface	HEX dump mode
ON	OFF	OFF	ON	Open	ON	OFF	—	Head check (Barcode print area) designation
				Open	OFF	ON	—	Head check clear
ON	ON	ON	ON	Open	ON	OFF	—	Online command designation (Petit lapin compatible)
				Open	OFF	ON	—	Online command designation (SBPL command)



## Basic Specifications of MB200i/MB201i

Item	Description
Printing system	Thermal printing system
Head density	8 dots/mm (203 dpi)
Maximum print area	48 mm (width) x 160 mm (pitch)
Print speed	103 mm/s max. (The speed varies depending on print duty and environment of use.)
Dimensions	Printer: 119 mm (width) x 64 mm (depth) x 88 mm (height) (excluding belt clip)
Weight	390 g (Standard model, including battery pack)
Power supply	AC adapter or Battery pack
AC adapter	Input: AC100 to 240 V, 1.5 A 50/60Hz Output: DC9 V, 5A
Battery pack	Lithium-ion DC7.4 V, 2400 mAh Prints 1.5 rolls of thermal labels with full charge (equivalent of 48 m). Continuous printing is permitted (provided print duty is 16% or less.)
Paper	Be sure to use specified paper.
Paper thickness	0.064 to 0.190 mm
Shape of paper	Roll paper: Wound with surface out Maximum diameter: f58 mm
Label size (Liner sheet and eye mark pitch)	Width: 25.4 to 55 mm (28.4 to 58 mm) Pitch: 13 to 160 mm (16 to 163 mm)
Label printing	Continuous, Dispense
Self-diagnosis	Head check/Cover open/Paper end/Battery check/Test print
Power saving feature	Enters Sleep mode after no operation for 5 minutes. Auto power off after no operation for 5 minutes. With Bluetooth or wireless LAN specifications, no auto power off is defaulted. Auto power off time can be changed by the printer operation register command <PG>. For details of command, refer to Programming Guide.
Interface	Mini DIN
• RS-232C	IrDA communication (Complies with IrDA standard Ver. 1.2. Communication range: 15 to 20 cm max.)
• Photo coupling	

Item	Description
• Bluetooth	Bluetooth Specification Ver. 1.1 Class 2
• Wireless LAN	Wireless LAN interface (IEEE802.11b) TCP/IP (FTP, LPR, SOCKET)
Paper sensor	Reflection type (eye mark), Transmission type (gap)
Character magnification	1 to 6 times
Rotation of character	0°, 90°, 180°, 270°
Character type	SATO standard font: X20, X21, X22, X23, X24, OCR-A, OCR-B, POP character Kanji: 16 x 16, 22 x 22, 24 x 24 Square Gothic (JIS Level 1, Level 2)
Barcode	JAN8/13, UPC-E/UPC-A, NW-7, CODE39, CODE93, CODE128, INTERLEAVED2of5, Customer barcode, RSS-14 However, barcode shall be used with the following. Parallel barcode: Thin bar width of 2 dots or more Serial barcode: Thin bar width of 3 dots or more
2-dimensional code	Any one of PDF417, QR code (including micro QR), Data matrix code (ECC200), MAXI code, Composite symbol can be used by downloading.
Switch	POWER key, PRINT key, FEED key
Indicator	STATUS LED: One (Lights in three color: Green, Red and Orange) Battery LED: Three
Application standards	FCC 15 ClassB, EN55022, EN55024, EN61000-3-2, EN61000-3-3, UL60950-1, CSA C22.2 No.60950, GB9243, GB9254, GB17625.1, EN60950
Protective feature	Overcharge protection Head overheat protection Detection of Low Battery.
Waterproof feature	Rainproof type (JIS protection class 3), Shoulder rainproof cover (option) installed. * Removed when communication cable is connected.
Environmental condition (including battery pack)	Operating ambient temperature: -15 to 50°C Humidity: 20 to 80% without condensation Storage ambient temperature: -25 to 60°C Humidity: 20 to 80% without condensation Environment for paper is excepted.

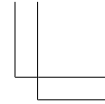
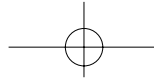
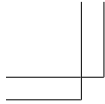

**6**

Reference

Item	Description
Options	Battery pack, AC adapter, Battery charger (Single-socket), Battery charger (5-socket), Rainproof case, Shoulder belt, Belt hook (one-touch type), Waist case, RS-232C cable

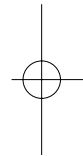
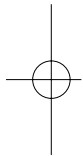

**34**

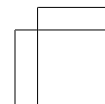
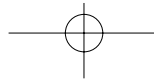
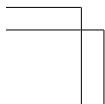

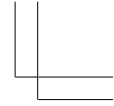
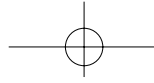
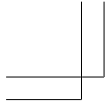

**AVTO**  
DCS & Labeling Worldwide

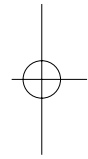
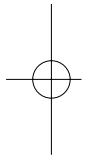

\*Q01147000\*

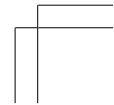
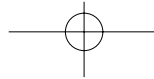
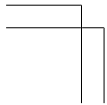

## Additional Page User Option

### 1. RS232C Cable (for MODEL MB200i,MB201i)



### 2. Ferrite Core (for RS232C Cable) Type : RFC-8 KITAGAWA Ind

2pcs



### 3. Ferrite Core (for AC Adapter) 1pcs Type : ZCAT2035-0930A TDK CORP.



## How to attach a ferrite core

When using AC adapter and RS232C cable, it closes like a photograph.

#### • AC adapter



Cable is rolled 2 time and inserted.



#### • RS232C cable



Cable is rolled 1 time and inserted. (Two places)

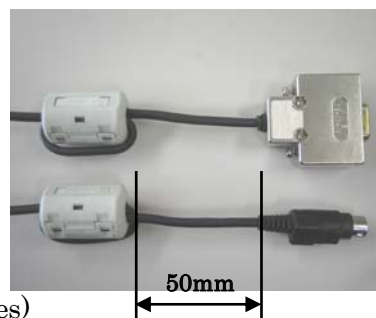

- \* Please be sure to attach a ferrite core by prevention of electromagnetic wave disturbance.
- \* AC adapter and RS232C cable should be used the specification article of our company.