

Savi MobileReader 410R Quick Reference Guide

Version 1.0

First edition January, 1999
Order number DOC-2003
Part number 805-01467-001 Rev. A

Copyright © Savi Technology Incorporated 1999. All rights reserved. First edition published in January, 1999. Printed in the United States of America.

Copyright protection claimed includes all forms and matters of copyrightable material and information, now allowed by statutory or judicial law or hereinafter granted, including without limitation, material generated from the software programs which are displayed on the screen such as icons, screen display looks, etc.

Information in this manual is subject to change without notice and does not represent a commitment from the vendor. The software and/or databases described in this document are furnished under a license agreement or nondisclosure agreement. The software and/or databases may be used or copied only in accordance with the terms of the agreement. It is against the law to copy the software on any medium except as specifically allowed in the license or nondisclosure agreement.

Savi, Batch Collection, TagOS, and TyTag are registered trademarks and Adaptive Routing, Hand Held Interrogator (HHI), ITV, Savi Asset Manager, Savi Interrogator, Savi Retriever, Savi SDK, Savi System, SaviTag, Savi Tools, SealTag, SINC, TAV, and TyTag are trademarks of Savi Technology Incorporated.

Other product names mentioned in this guide may be trademarks or registered trademarks of their respective owners and are hereby acknowledged.

Federal Communications Commission (FCC) Notice

The Federal Communications Commission has established technical standards regarding radio frequency energy emitted by computer devices. This equipment has been tested and found to comply with the limits for a Class A digital device, pursuant to Part 15 of the FCC Rules. These limits are designed to provide reasonable protection against harmful interference when the equipment is operated in a commercial environment. This equipment generates, uses, and can radiate radio frequency energy and, if not installed and used in accordance with the instruction manual, may cause harmful interference with radio/TV reception. Operation of this equipment in a residential area is likely to cause harmful interference in which case the user will be required to correct the interference at his own expense.



Warning

Changes or modifications to this equipment that are not expressly approved by Savi Technology could void the authority to operate this equipment.

Using this equipment in a manner not specified by the manufacturer may impair the protection that the equipment provides.

Savi Technology is not responsible for radio/TV interference caused by using unauthorized cable or by making unauthorized changes to this equipment.

Use of controls or adjustments or procedures other than those specified herein may result in hazardous exposure to laser light up to 205 mw at 670 nm. Technical assistance for the operation and maintenance of the Savi MobileReader 410R can be obtained from Savi Technology Inc, 450 National Avenue, Mountain View, CA 94043. The phone number is 650-428-0550

Software License Agreement

This is an agreement between you, the purchaser, and SAVI Technology Inc. (SAVI). The SAVI software program (the “SOFTWARE”) described in this manual is licensed by SAVI for use only according to the terms set forth herein. Starting the SOFTWARE constitutes your agreement to these terms. If you do not agree to these terms, please do not start the SOFTWARE and instead, return the complete product to SAVI.

LICENSE

SAVI grants you a SINGLE USER LICENSE to use only one copy of the enclosed SOFTWARE on a single Computer. Multiple concurrent use is prohibited. The SOFTWARE is in “use” on a Computer when it is executed in the Computer or is loaded into the operating memory or installed into the permanent memory (e.g., hard disk, CD-ROM, or other storage device) of the Computer.

NETWORK LICENSE

If the SOFTWARE is acquired for network use, the SOFTWARE may only be installed on one Computer functioning as a server and a NETWORK LICENSE must be purchased. The number of computers and terminals capable of accessing or operating the SOFTWARE on the network must not exceed the number of users authorized by the NETWORK LICENSE.

DERIVATIVE PRODUCTS

You are hereby granted permission to develop derivative products that use or incorporate all or part of the SOFTWARE and to use the derivative products on one computer. Permission to use derivative products on more than one computer, or to distribute any derivative products, may be obtained by either purchase of additional copies of the SOFTWARE or by separate written agreement between you and SAVI covering such use or distribution.

COPYRIGHT

The SOFTWARE is copyrighted under United States and international copyright laws. Except as provided herein, you may not make copies, electronically or by any other means, of the SOFTWARE without written permission from SAVI. You may not copy the written materials accompanying the SOFTWARE.

TERMINATION

This LICENSE shall remain in force from date of purchase unless terminated. You may terminate the LICENSE by destroying the SOFTWARE including documentation and all copies made thereof. This LICENSE may also be terminated by SAVI if you fail to comply with the terms of this agreement. You agree, upon termination, to destroy the SOFTWARE including documentation and all copies made thereof.

NO OTHER WARRANTIES

WITH RESPECT TO THE SOFTWARE AND THE ACCOMPANYING WRITTEN MATERIALS, SAVI AND ITS DEALERS AND SUPPLIERS DISCLAIM ALL OTHER WARRANTIES AND CONDITIONS, EITHER EXPRESSED OR IMPLIED, INCLUDING BUT NOT LIMITED TO IMPLIED WARRANTIES AND CONDITIONS OF MERCHANTABILITY AND FITNESS FOR A PARTICULAR PURPOSE.

NO LIABILITY FOR CONSEQUENTIAL DAMAGES

IN NO EVENT SHALL SAVI OR ITS DEALERS OR SUPPLIERS BE LIABLE FOR ANY DAMAGES WHATSOEVER (INCLUDING, WITHOUT LIMITATION, DAMAGES FOR LOSS OF BUSINESS PROFITS, BUSINESS INTERRUPTION, LOSS OF BUSINESS INFORMATION, OR OTHER PECUNIARY LOSS OR INDIRECT, SPECIAL, INCIDENTAL, OR CONSEQUENTIAL DAMAGES OF ANY KIND) ARISING OUT OF THE USE OF OR INABILITY TO USE THE SAVI PRODUCT, EVEN IF SAVI HAS BEEN ADVISED OF THE POSSIBILITY OF SUCH DAMAGES.

Some states do not allow limitations on duration of an implied warranty or limitations of liability for consequential or incidental damages. You may have other legal rights.

GOVERNING LAW

This LICENSE shall be construed, interpreted, and governed by the laws of the United States of America and the laws of the State of California. In the event of any conflicting interpretation between the two, the laws of the United States shall prevail.

U.S. GOVERNMENT RESTRICTED RIGHTS

The SOFTWARE and documentation are provided with RESTRICTED RIGHTS. Use, duplication, or disclosure by the Government is subject to restrictions as set forth in subparagraph (c)(1)(ii) of the Rights in Technical Data and Computer Software clause at DFARS 252.227-7013 or in subparagraphs (c)(1) and (c)(2) of the Commercial Computer

Software-Restricted rights at FAR 52.227-19 as applicable. The contractor and manufacturer is Savi Technology Incorporated, 450 National Avenue, Mountain View, CA 94043-2238.

REGULATORY APPROVALS

The SMR-410R is UL listed (UL 1950), when powered by the NiCad battery or the external AC adapter (P/N 042684) operating through the Interface Adapter.

LASER COMPLIANCE AND CAUTION

This device is a Class II laser product (CFR 21, Subpart J) and has a maximum output of 2-5 mw at 670 nm.

NONINCENDIVE INFORMATION

This product is UL Listed as Nonincendive (UL-1604) for use in the following Division 2 hazardous locations:

- Class I - Groups A, B, C and D
- Class II - Groups F and G
- Class III
- Temperature Code: T4A
- Maximum operating Ambient: 50 °C

The SMR410R is considered nonincendive only when used alone and powered by the NiCad battery pack. Make no other connections while in Division 2 hazardous locations.

There are no restrictions on the type of PC card that can be used in a Division 2 location. However, this card may only be changed while in an area known to be non-hazardous.

WARNING: This product is rated Nonincendive as long as it is not abused or damaged, and is used according to its operating instructions. If these conditions are not met, this device must not be operated in a Division 2 environment.

Contents

Checking the Contents	1
Using the SMR-410R	2
Using The Keypad	2
Installing the SMR-410R	4
Charging the battery	4
Inserting the Battery	4
Installing the Optical Interface Adapter	5
Starting the SMR-410R	5
Setting the Time and Date	6
Using The RFID Software, HHIM.EXE	6
Starting HHIM.EXE	7
Collecting Tags	7
Entering Current Tag ID	8
Selecting the Current Tag	8
Locating Tags	9
Checking Status of the SMR-410R	9
Exiting HHIM.EXE	10
Checking the Batteries	10
Maximizing Battery Life	10
Placing the SMR-410R in Suspend Mode	12
Placing the SMR-410R in Storage Mode	12
Removing the NiCad battery	12
Cold Booting the SMR-410R	13
Transferring Files between the SMR-410R and a PC	13

Savi MobileReader 410R Quick

Reference Guide

The Savi MobileReader 410R (SMR-410R) is a hand-held computer that communicates with Savi RF tags (SealTag II and SaviTag 410) and functions as a Radio Frequency Identification (RFID) Hand Held Interrogator (HHI). This guide includes installation and usage of the SMR-410R, the features of SMR-410R, and the RFID software application.

The SMR-410R is a combination hand-held bar code reader, computer and RFID interrogator. It has a 386 microprocessor, contains Microsoft MS-DOS, and is PC compatible.

Checking the Contents

Verify that you have the following parts:

- Savi MobileReader 410R
- Nickel-Cadmium (NiCad) battery
- Optical Interface Adapter
- AC adapter

The following items are included only with optional configurations.

- PCMCIA card containing RFID software application

- RS232 null modem cable

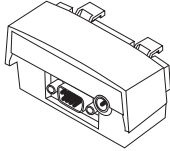

Optical Interface Adapter

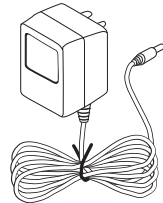

AC adapter

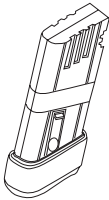

NiCad battery

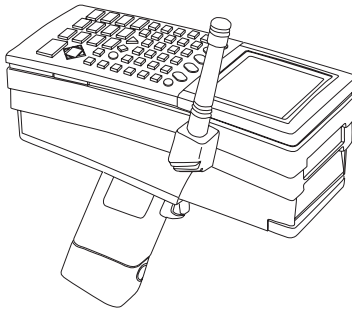

Savi MobileReader 410R

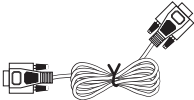

**RS232 cable
(optional)**

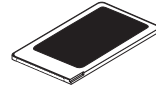

**PCMCIA card
(optional)**

Using the SMR-410R

Using The Keypad

The following figure shows the alphanumeric keypad for the SMR-410R. The keys generate characters and perform functions similar to a standard PC keyboard.

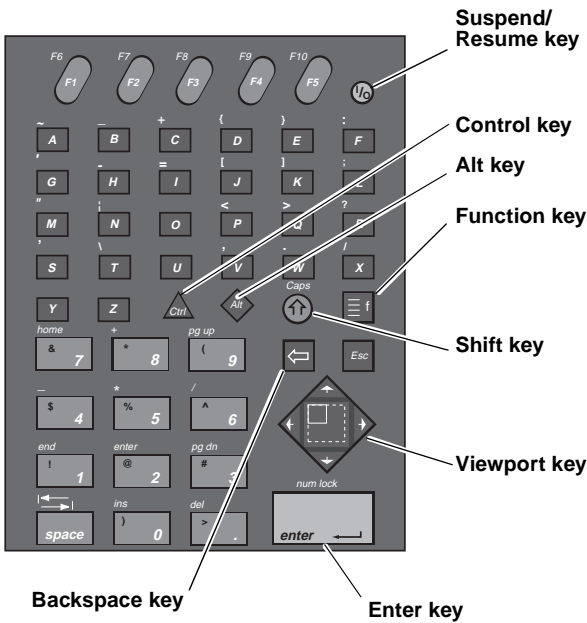

The following paragraphs describe the functions of the Suspend/Resume, Function, Viewport and Backspace keys.

Suspend/Resume key

This key activates and deactivates the SMR-410R.

Function key

This key provides access to alternate key codes that are printed in the light blue color above each key. Press  and then press the key to generate the alternate code.

Viewport key

In conjunction with the **f** function key, this key moves the cursor up, right, down and left, corresponding with the direction of the arrows.

Backspace key

This key deletes the character to the left of the cursor.

Installing the SMR-410R

Charging the battery

Use either of the following methods to charge the NiCad battery.

- Optical Link Method

1. Place the battery in the reader.
2. Attach the Optical Interface Adapter to the reader as described in the section Installing the Optical Interface Adapter, later on this page.
3. Connect the AC adapter to the Optical Interface Adapter.
4. Wait at least 15 hours for the battery to charge.

- Battery Charger Method

1. Place the battery in battery charger (available separately).
2. Wait at least 2.5 hours for the battery to charge.

Inserting the Battery

1. Hold the reader so that the handle points down.
2. Hold the battery under the reader handle.
3. Slide battery into the reader handle and push firmly in.

Installing the Optical Interface Adapter

The following figure shows the Optical Interface Adapter and its connectors. Use the RS-232 connector to connect devices that communicate with the SMR-410R. Attach the AC adapter to the AC adapter connector.

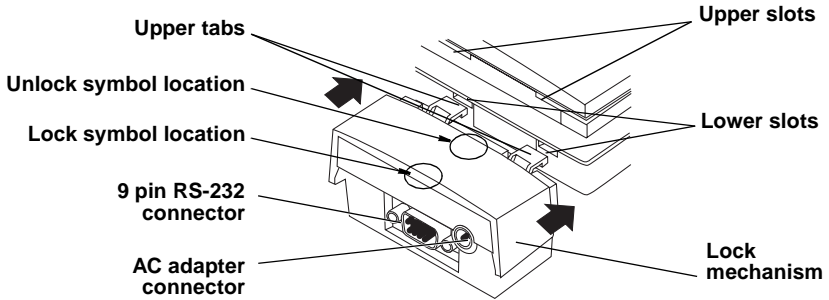

Installing the Optical Interface Adapter

1. Verify that the reader is turned off.
2. Insert the two lower tabs of the adapter into the lower slots on the back of the SMR-410R.
3. Place the two upper tabs into the upper slots.
4. Slide the locking mechanism towards the SMR-410R until the closed lock symbol  is completely visible.

Starting the SMR-410R

Before you can use the SMR410R you need to follow these steps:

1. Turn on the SMR-410R by pressing the yellow  key on the keypad.
The Boot Loader menu appears and highlights the **Reboot** command.

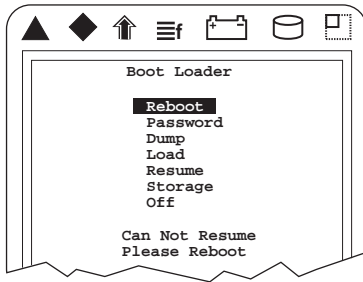





2. Press **enter** to cold boot the SMR-410R. For further information, see the section “Cold Booting the SMR-410R” on page 13.

Note: If after 60 seconds no key is pressed, the SMR-410R enters Suspend Mode and the display disappears. Press  to resume booting. The DOS prompt (C:) appears when the SMR-410R finishes booting. Type **G:** and press **enter** after the DOS prompt to get to the correct directory.

Setting the Time and Date

To set the time and date:

1. Enter the word **time** at the prompt.
2. Press **enter**.
3. Enter the current time (HH:MM:SS) and press **enter**.
To type a colon on the keypad, press  .
4. Enter the word **date** at the prompt.
5. Press **enter**.
6. Enter the current date (MM-DD-YY) and press **enter**.
To type a dash on the keypad, press  .

Using The RFID Software, HHIM.EXE

The SMR-410R communicates with Savi Technology’s SaviTag 410 and SealTag II. With the SMR-410R you can move anywhere within range of these tags and communicate with them.

Demonstration software, called HHIM.EXE comes with the SMR-410R and with it you can verify that the reader works properly.

Starting HHIM.EXE

To start the program:

1. Enter **HHIM** at the C: prompt.
2. Press **enter**.

The main menu screen appears which contains the following commands:

- **Collect Tags**
- **Enter Current Tag**
- **Select Current Tag**
- **MobileReader Status**
- **Background Noise**
- **Exit**

To select a command, press  to move the cursor to the desired command.

To activate a command press **enter**.

Collecting Tags

The SMR-410R “wakes” all tags within its range and reads the tag ID number. This is a pre-assigned, non-changeable 7-digit number. The SMR-410R collects the tags and status, stores the information and puts the tags back to “sleep”.

To collect the tags:

1. Select **Collect Tags** from the main menu.
2. Press **enter**.

During this process, the following message displays:

Collecting tags...

When the process is finished, the screen shows the number of tags collected and the IDs of each tag. An asterisk (*) to the left of a tag indicates a low battery. The symbol * to the right of a tag identifies a SaviTag 410; others are SealTags. Press **Esc** to return to the main menu.

Entering Current Tag ID

A current tag designation chooses the tag to which tag-specific operations are directed, such as turning the audible beeper on or off, reading or writing data, or setting the tag clock. The current tag is designated either by entering a tag ID or by selecting an ID from a list of tag IDs.

To enter the current tag:

1. Select **Enter Current Tag** from the menu.
2. Enter the 7-digit ID number from the label from the front of the tag.
3. Press **enter** to make this tag the current tag. The tag menu appears with the current tag at the top of the display.

Selecting the Current Tag

This command selects the current tag from the tags listed in the previous tag collection.

To select a current tag:

1. Move the cursor to **Select Current Tag**.
2. Press **enter**. The screen displays the last collection file name as **Lastcoll.lst**. This list contains tag IDs from the collection from which you choose a new current tag.
3. Press **enter**. The collection list displays and lists the tags by ID number.
4. Place the cursor at the desired tag ID and press **enter** to select the new current tag. The main menu appears with the current tag at the top of the display.

Locating Tags

To find a specific tag you might need to activate its beeper. The beeper emits a sound that can be used to locate an individual tag. Follow the sound to the tag's location and deactivate the beeper.

Activating the Beeper

The **Beeper On** command remotely activates a tag's beeper. The beeper remains on for 90 seconds or until deactivated by the **Beeper Off** command.

To activate a beeper:

1. Select a current tag.
2. Select **Beeper On** from the Tag menu.
3. Press **enter** to activate the beeper and return to the Tag menu.

Deactivating the Beeper

The **Beeper Off** command remotely deactivates a tag's beeper.

To deactivate a beeper:

1. Select **Beeper Off** from the Tag menu.
2. Press **enter** to deactivate the beeper and return to the Tag menu.

Checking Status of the SMR-410R

This command shows the current status of the SMR-410R including the model number and version, available memory, tag batteries, and date and time.

To check the status:

1. Scroll to **MobileReader Status** in the main menu using the Viewport key.
2. Press **enter**.

Exiting HHIM.EXE

To exit the program:

1. Scroll to **Exit** in the main menu using the Viewport key.
2. Press **enter**. This ends the current session.

Checking the Batteries

There are two batteries in the SMR-410R, the NiCad battery and the internal Lithium Bridge Battery.

The NiCad battery is the main power source for the SMR-410R. The lithium battery supplies keep-alive power to the SMR-410R when the main battery is removed. When you remove or replace the NiCad battery the Lithium Bridge Battery backs up the reader's RAM and clock.

Both batteries are rechargeable. The NiCad battery is recharged by attaching the AC adapter to the SMR-410R and plugging it into an external power source, such as a wall socket. The Lithium Bridge battery is recharged by the NiCad battery.

Maximizing Battery Life



To maximize the life of the SMR-410R's Lithium Bridge Battery and NiCad battery, choose from the following options.

NOTE: The internal Lithium bridge battery is NOT user serviceable. The SMR410R must be returned to Savi Technology for replacement of this battery.

Usage	Action	Explanation
The SMR-410R is used at least once a week.	Place the SMR-410R in Suspend Mode (see “Placing the SMR-410R in Suspend Mode” on page 12).	Suspend Mode saves the NiCad battery’s power. Press  to put the SMR-410R in Suspend Mode. Check that the low battery icon is not on.
The SMR-410R is not used for a week or longer.	<ul style="list-style-type: none">• Place the SMR-410R in Storage Mode (see “Placing the SMR-410R in Storage Mode” on page 12) and remove the NiCad battery.• Remove any PC cards.	Storage Mode conserves the Lithium Bridge Battery’s power. You must remove the NiCad battery for Storage Mode to activate.
The SMR-410R has been in use and the NiCad battery has a low charge.	<ul style="list-style-type: none">• Remove the battery and insert another charged battery. or• Attach an external power supply (AC adapter) to charge the installed battery. or• Place the SMR-410R in Storage Mode.	A charged battery is necessary to conserve the Lithium Bridge Battery power.

CAUTION: If you do not use the SMR-410R for more than one week, you **must** put the SMR-410R in Storage Mode.







Placing the SMR-410R in Suspend Mode

To place the SMR-410R in Suspend Mode, press . Once in the Suspend Mode the SMR-410R saves all memory and cuts power to the hardware. When you want to use the unit again, press  and the unit begins functioning from the point from exactly where it was when placed in Suspend Mode.

Placing the SMR-410R in Storage Mode

If you do not plan to use the SMR-410R for seven days or longer, place the unit in Storage Mode.

To place the SMR-410R in Storage Mode (these instructions are also printed on the side of the unit below the antenna):

1. Press  to place the unit in Suspend Mode.
2. Press and hold   and the  symbol on the cursor key, in that order. Then release the keys.
3. Press  a second time.
4. Press  and then  to highlight Storage on the Boot Loader menu.
5. Press **enter**.
6. Remove the NiCad battery.

Removing the NiCad battery







1. Hold the reader with the handle pointing right or left.
2. Push battery inward slightly while at the same time pressing the dot on the base of the battery. Pull the battery out about a half inch.
3. Squeeze the two yellow buttons with your thumb and forefinger to release the latches in the handle.
4. Slide the battery out of the handle.

Note: Do not remove the NiCad battery for more than 10 minutes without first placing the SMR-410R in Storage Mode. Otherwise the Lithium Bridge battery discharges.

Cold Booting the SMR-410R

Before setting up the unit for the first time or after having system problems you should cold boot the SMR-410R.

To cold boot the unit:

1. Press  to turn off the SMR-410R.
2. Press and hold   and  in that order. Then release the keys.
3. Press  a second time.
4. Press  and then . The Boot Loader menu displays.
5. Press **enter**. The Boot Loader menu appears.
6. Press **enter** to activate the Reboot command, and the SMR-410R reboots.
7. Press **enter** at the intermediate prompt that appears before the final C:> prompt.

Transferring Files between the SMR-410R and a PC

File transfers between a PC and a Savi Mobile Reader 410R (SMR) are executed by software operating in a client–server mode in which the PC functions as the server and the SMR-410R functions as the client (all commands are entered from the SMR-410R).

For further information see the PC—Savi MobileReader 410R File Transfer User Guide, Savi part number 805-01867-001.

A Savi MobileReader410 R Specifications

The following table shows specifications of the 433.92 MHz SMR410R.

Integrated radio module	Frequency: 433.92 MHz Output Power: 4mW Data Speed: 9600 bps/27.7 kbps Radio Type: Frequency Modulating Transceiver Independent channels: 1 Range: up to 300 feet
Environment	Operating: -4° to +122°F Storage: (-40° to 140° F) Humidity: 0 to 95% relative non-condensing
Hardware	386S microprocessor PC-AT compatible Emulates full PC-AT 101 keyboard
Software	Microsoft ROM DOS 6.2 Microsoft Basic User-friendly configuration screen Microsoft Interlink/Interserver communications package Virtual Wedge™
Bar codes supported	Autodiscriminates among Code 39, 2 of 5, Interleaved 2 of 5, Codabar, UPC/EAN, UCC/EAN, Code 128, Code 11, Code 93, Plessay, MSI, Code 16K, Code 49
Display	16 line, 20 column backlit CGA compatible virtual 25x80 display with viewport

A

Memory size	4 MB battery-backed RAM 512 Flash Drive 2 MB Drive D
Physical Characteristics	Width: 3.3" (8.4 cm) Length: 8.0" (20.3 cm) Depth: 3.25 "(8.25 cm) Weight: 2 lb. 2.7 oz. (excluding battery pack)
Data communications	Infrared serial communications interface RS-232C, RS-422, RS-485 Protocols: PC Standard, Point-to-Point, Polling D mode, Multi-drop, User-defined
Interfaces	Infrared D89 via optical link adapter
Power	Primary: 6.0VDC, 1500 mAhr NiCad battery pack Backup: 3.6 VDC lithium cell Charging: 2 hours to charge NiCad with JZ2010 charger
Regulatory approvals	UL Listed (UL1950), FCC Part 15
Optional Accessories	Hardware: Intelligent four-pack battery charger Optical link AC Adapter 1500mAhr NiCad battery pack Holster Power Supply 512 Kb, 1Mb, 2 Mb, 4Mb SRAM PCMCIA memory card Software: Programmer's software kit (PSK) Operating Software: Savi Mobile Manager Model SMRS-1001 Manuals: User's Guide Power supplies

Optical parameters	Depth of Field: 7.5 mil code (3 to 7.5") 10 mil code (2 to 10 " 20 mil code (3 to 16") 40 mil code (4 to 25")
--------------------	---
