

# **Installation Guide**

---

## **Savi ST-656 Data Rich Tag with Container Door Mount**



---

Published February 2009

Part number 805-05827-901 Rev B

Documentation for SaviTag ST-656

Copyright © 2009 Savi Technology, Inc. All rights reserved. Unpublished - rights reserved under the Copyright Laws of the United States.

EchoPoint, Savi, Savi SensorTag, Savi SmartChain, Savi SmartStart, Savi Technology, Savi's Nested Visibility, SaviTag, SmartChain, the EchoPoint Logo, and the Savi Logo are trademarks or registered trademarks of Savi Technology, Inc. in the United States and other countries.

Information in this manual is subject to change without notice and does not represent a commitment from the vendor. The software and/or databases described in this document are furnished under a license agreement or nondisclosure agreement. The software and/or databases may be used or copied only in accordance with the terms of the agreement. It is against the law to copy the software on any medium except as specifically allowed in the license or nondisclosure agreement.

THIS DOCUMENTATION CONTAINS CONFIDENTIAL INFORMATION AND TRADE SECRETS OF SAVI TECHNOLOGY, INC. USE, DISCLOSURE OR REPRODUCTION IS PROHIBITED WITHOUT THE PRIOR EXPRESS WRITTEN PERMISSION OF SAVI TECHNOLOGY, INC.

#### U.S. GOVERNMENT RIGHTS

Use, duplication or disclosure by the U.S. government is subject to restrictions set forth in the Savi Technology, Inc. license agreement and as provided in DFARS 227.7202-1(a) and 227.7202-3(a) (1995), DFARS 252.227-7013(c)(1)(ii) (OCT 1988), FAR 12.212(a) (1995), FAR 52.227-19 or FAR 52.227-14 (ALT III), as applicable. Savi Technology, Inc.

Other product names mentioned in this guide may be trademarks or registered trademarks of their respective owners and are hereby acknowledged.

Savi Technology.

351 E. Evelyn Avenue

Mountain View, CA 94041-1530

Phone: 1-650-316-4700

Facsimile: 1-650-316-4750

[www.savi.com](http://www.savi.com)

---

---

# Contents

Savi ST-656 Data-Rich Tag Description . . . . .	5
Features . . . . .	7
Activating the Tag . . . . .	7
Initializing the Tag. . . . .	9
Placing the Tag for Best Performance . . . . .	10
Mounting the Tag. . . . .	12
Replacing the Battery. . . . .	13
Contacting Savi Support . . . . .	14
Specifications. . . . .	15



---

# Savi ST-656 Data-Rich Tag Description

The Savi ST-656 tag is an active RFID tag for shipping containers that enables shippers, carriers, and logistics service providers to monitor shipments in real time as they move through the global supply chain. The ST-656 tag's unique C-clamp door-mount design places the sensitive RFID components inside the shipping container. Only the low profile, external antenna casing is on the outside of the container, which significantly reduces the risk of tag damage during the loading, unloading, and transportation of shipping containers.

**Figure 1:** Savi ST-656 Container Security Tag (Front view)

Antenna

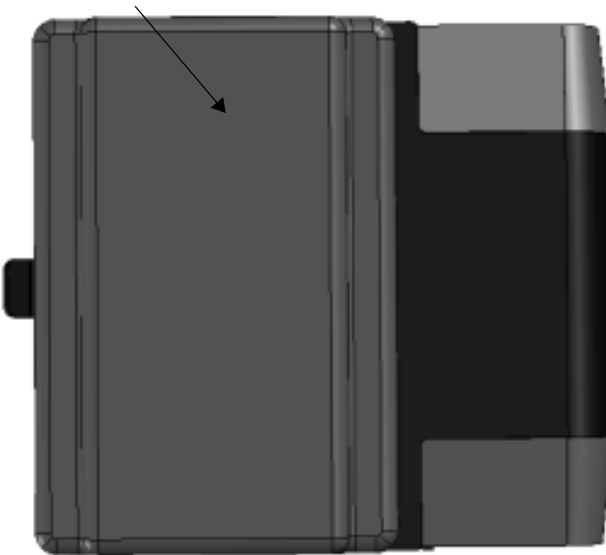

# Savi ST-656 Container Tag Installation Guide

---

Figure 2: Top view

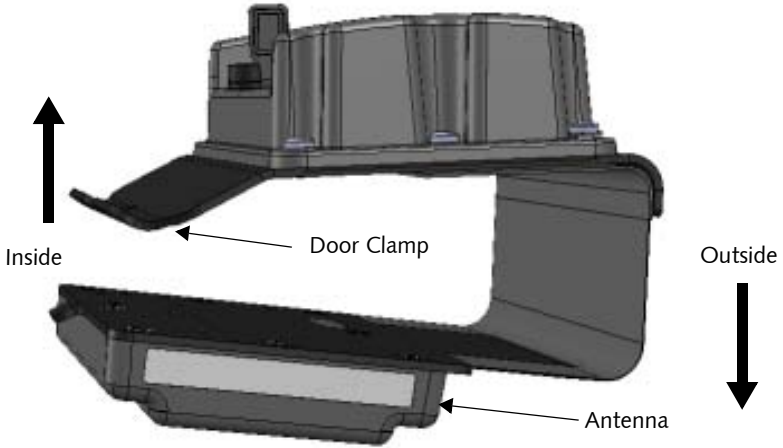

Figure 3: Rear view



# Features

- ISO 18000-7 compliant active RFID tag for tracking shipping containers
- Unique C-clamp door-mounted design greatly reduces risk of damage to the tag
- 128 Kbytes of programmable database memory enables tag to support multiple applications
- 400-foot (122m) omnidirectional, line-of-sight range
- Replaceable battery with typical life of five years
- Supports low-frequency technology for more precise locating capabilities
- Supports USB operation for reading and writing
- FCC, HERO, ETSI, RoHS (Directive 2002/95/EC) certified

## Activating the Tag

The tag is shipped in sleep mode. You must remove and re-insert the battery to wake the tag. After you re-insert the battery, you can initialize the tag.

1. Remove the battery cap.

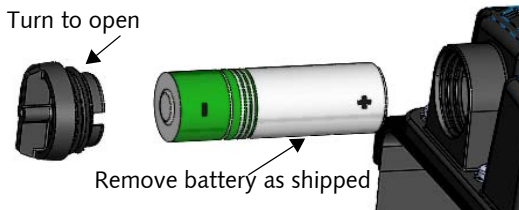

## Savi ST-656 Container Tag Installation Guide

---

2. Remove the battery. Wait a few seconds and then reinsert the battery, matching the negative (-) and positive (+) terminals to the symbols shown on the tag housing. The tag will not work if you install the battery in the wrong direction (reversed).

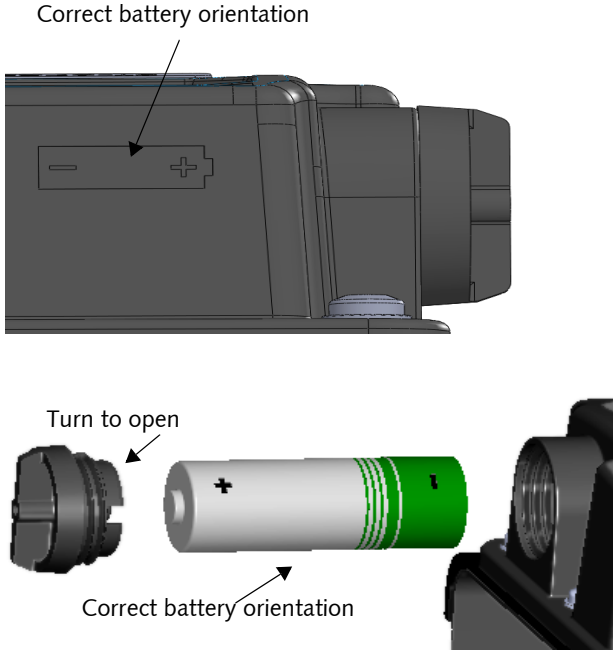

Whenever a battery is inserted into a tag, the tag will emit 5 beeps.

Then, if the tag emits a long (1/2 second beep), that means it has an internal sensor failure.

Then, the tag will emit 2 short beeps to indicate adequate battery voltage or 3 short beeps if a fresh battery is required.

Whenever a battery is inserted into a tag, the tag assumes that it is a fresh battery. Inserting a used battery into a tag may result in what appears to be a premature battery failure.



## Initializing the Tag

---

3. Replace the battery cap on the tag. **Continue tightening the cap until it is secure.**

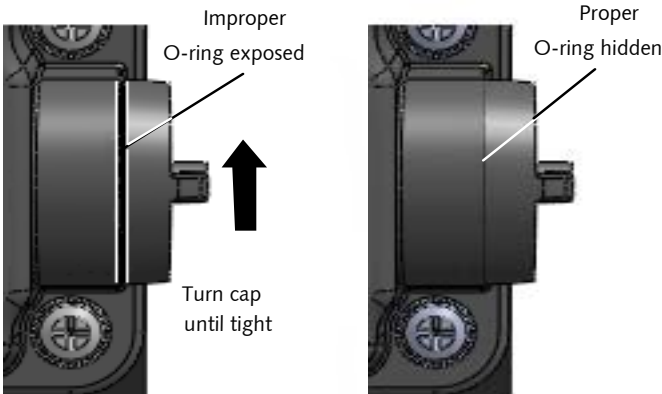

If the O-ring is not properly compressed by the cap, water leakage and damage may occur.

**Note:** When the tag is not in use, disable the tag by removing, reversing, and re-inserting the battery. Store the battery at room temperature (50-80 °F or 10-27 °C ).

## Initializing the Tag

Once you activate the tag, you can initialize it for immediate use.

1. Unplug the USB port cover.
2. Insert the USB cable into the USB port on the tag and connect the other end to the USB port on the computer.

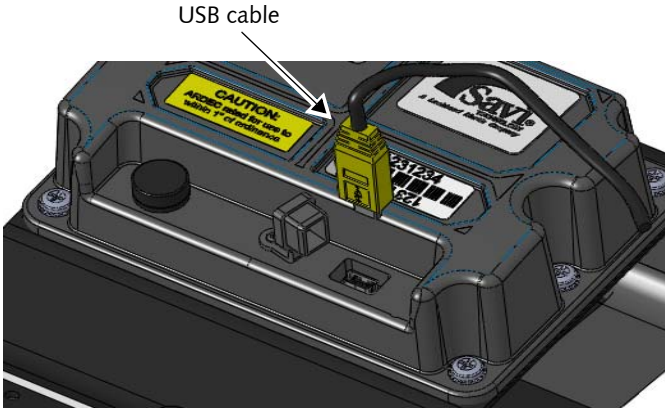

3. Refer to the *Savi SmartChain Mobile User Guide* or the *Savi SmartChain WorkStation User Guide* for instructions on the initialization process.

## Placing the Tag for Best Performance

Savi Technology recommends that you mount the tag on a flat surface, with the tag aligned vertically. For best performance, place the tag as high as possible, safe from impact (for example, between the ribs of an ISO-type shipping container), and away from obstructions on the asset.

For best performance, make sure the tag is:

- Mounted on a metal surface.
- Mounted at no less than a 6 foot (1.8m) elevation.
- Mounted vertically.
- Not mounted behind or between metal objects

## Placing the Tag for Best Performance

---

- Mounted on the container door higher than the closing and locking mechanism.

The next figure shows an example of a security tag mounted on an ISO container door.

**Figure 4:** Security tag mounted on an ISO container door

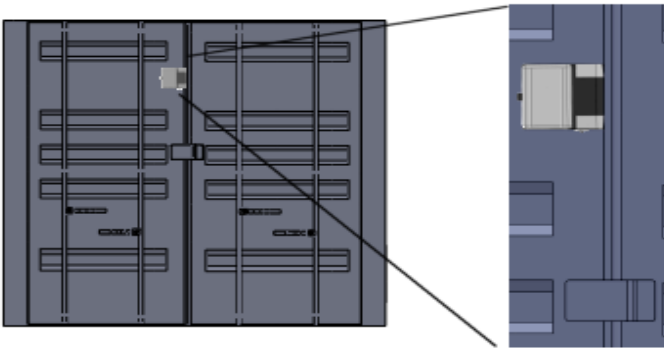

**Note:** Make sure you clean the surface of the container or other asset before attaching the tag.

The tag will have 400-foot (122m) read/write range to Savi SR-650 Fixed Readers. For the most consistent communications with the tag, the Fixed Readers must be mounted:

- to have an unobstructed line-of-sight to the tag
- at 20 feet (6m) or higher

Follow the instructions in the Savi Fixed Reader documentation to locate and position the Savi Fixed Reader for best performance.

# Mounting the Tag

1. Open the right door of the container.
2. Using both hands, push the C-clamp on the tag onto the edge of the *left* door until it is on as far as it can go.

Left door outside view

Left door inside view

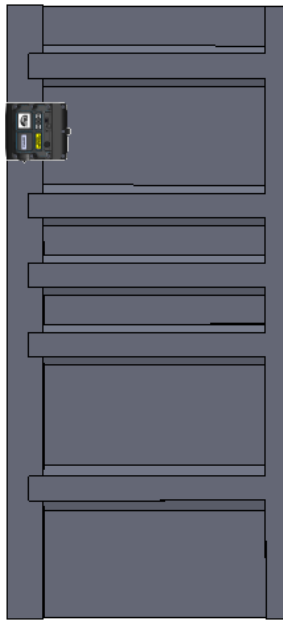
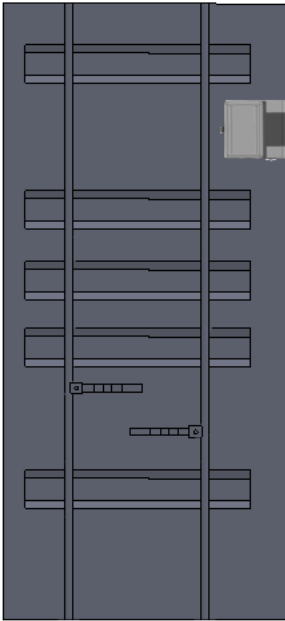

3. Close the right door.

# Replacing the Battery

The tag is equipped with non-volatile memory, which means stored data is not lost when you replace the battery.

1. Remove the battery cap.
2. Remove the discharged battery from its compartment.

For more information, see “Activating the Tag” on page 7. The lithium battery can be harmful to the environment. Follow current procedures for safely disposing of lithium batteries. The battery cannot be reused or recharged.

3. Install a 3.6V lithium "A" battery, matching the negative (–) and positive (+) terminals to the symbols shown on the tag housing. The tag will not work if you install the battery in the wrong direction (reversed).
4. Replace the battery cap on the tag.

Whenever a battery is inserted into a tag, the tag will emit 5 short beeps, one second apart.

Then, if the tag emits a long (1/2 second beep), that means it has an internal sensor failure. Remove the battery and insert it again. If the tag emits the same long (1/2 second) beep, do not use the tag.

Then, the tag will emit 2 short beeps to indicate adequate battery voltage or 3 beeps to indicate inadequate battery voltage. 3 short beeps means the tag needs a fresh battery.

Whenever a battery is inserted into a tag, the tag assumes that it is a fresh battery. Inserting a used battery into a tag may result in what appears to be a premature battery failure.

**After the beep, continue tightening the cap until it is secure.**

# **Contacting Savi Support**

If you cannot find the information you need, contact Savi Support Services.

- Check <http://supportcenter.savi.com> for contact information.
- Send an email to [help@savi.com](mailto:help@savi.com).
- Call 1-888-994-SAVI (North America only) or 1-650-316-4760 between 5 a.m. and 5 p.m. Pacific time.

When you contact Savi Support Services by telephone or email, have the following information available:

- Contact information (company name, your name, email, and phone number)
- Problem description
- Software version
- Product type
- Serial number or license information

## Specifications

---

# Specifications

---

Model Numbers	ST-656-030: Data-rich tag with shipping container door mount ST-656-030-NSN: Data-rich tag with shipping container door mount with label
Physical Characteristics	Rear case: 4.7 in. (12 cm) x 4.5 in. (11.4 cm) x 1.5 in. (3.8 cm) Front case: 4.6 in. (11.6 cm) x 3.2 in. (8.1 cm) x 0.5 in. (1.2 cm) C-clamp: 4.7 in. (12 cm) x 5.2 in. (13.3 cm) x 2 in. (5 cm) Container: ISO 668: 1995(E) Series 1 Freight Containers Color: Black
Environmental	Temperature: -32°C to +70°C operating; -40°C to +85°C storage Humidity: 95% non-condensing Vibration and shock: MIL-STD-810F Weatherproofing: IP64 Manufacturing: RoHS Directive 2002/95/EC
Wireless (UHF Transceiver)	Frequency: 433 MHz Range: 400 ft. (122-m) operating read/write range (outdoors, non-obstructed) from Savi SR-650 reader Protocols: ISO 18000-7, EchoPoint
Wireless (LF Receiver)	Frequency: 123 kHz Range: Greater than 20 ft. (6m) from Savi SP-651-211 Signpost or Savi SP-652-211 Signpost Reader Protocol: EchoPoint

---

# Savi ST-656 Container Tag Installation Guide

---

Power	Battery type: 3.6 volt lithium, replaceable by user without tools Battery life: Approximately 5 years at 2 collections per day. Over-polling protection algorithm to extend battery life
Digital	Database memory: On-board non-volatile memory: 128 Kb Wired interface: USB 1.1, USB 2.0
Mounting	C-clamp: Clamps easily onto shipping container left door edge (frame) - C-clamp to left door. Mount tag anywhere on the edge of the left-hand container rectangular doorframe measuring 2 in. (50 mm) x 4 in. (100 mm).
Approvals	Radio Type Approval: FCC Part 15, EN 300 220 (433 MHz) EMC and immunity: EN 301 489 Ordnance: HERO Certified, ARDEC rating of 1 in. (2.5 cm)

---