

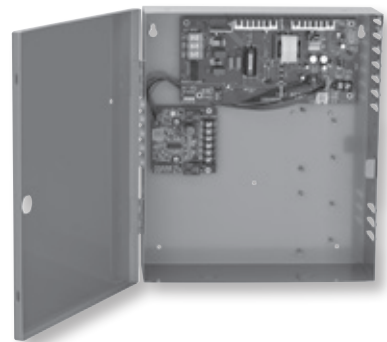

Electronic security price book 7

Effective May 4, 2019 • Rev. 05/19
Schlage



This price list supersedes and cancels all previous price lists. Prices shown are subject to change without notice.

Administrative Offices

Allegion Administrative Office
11819 N. Pennsylvania St. • Carmel, IN 46032
allegion.com/us

Placing orders

You can place orders with Allegion via the fax numbers or emails listed below:

Electronic Products

(Schlage, Electronic Locks, Electromagnetic Locks, Power Supplies and System Accessories)

Fax#: 1-800-452-0665

Email: Order_Entry_Schlage_Commercial@allegion.com

Von Duprin Electronic Products

(Power Supplies, Electric Strikes, Delayed Exit System and Electrical Power Transfer)

Fax#: 1-800-999-0328

Email: Order_VonDuprin@allegion.com

Biometric Readers

Fax#: 1-800-452-0665

Email: Sbsom@allegion.com

Readers, Credentials & Keypads

Fax#: 1-866-954-1779

Email: Readers.Credentials.Orders@allegion.com

Customer Care

Our Customer Care Representatives are available for questions or assistance.

You can reach them at **877-671-7011** (Press 1 for Sales Support | Press 2 for Product Support | Press 3 for RSO) or through the email addresses listed below:

Sales Support

support@allegion.com

Technical Product Support

Schlage Electronic Locks & System Components (Electromagnetic Locks, Power Supplies and System Accessories)

Electronic_Lock_TechProdSupport@allegion.com

Readers, Credentials & Biometrics

Readers_Credentials_Biometrics_TechProdSupport@allegion.com

Von Duprin Electronics (Power Supplies, Electric Strikes, Delayed Exit System, Electrical Power Transfer)

Phone#: 1-866-422-5547

Exits_TechProdSupport@allegion.com

Request for Quote

Carolinas

(North Carolina, South Carolina, Virginia)
Carolinas.Quotes@allegion.com

Central

(Arkansas, Illinois, Iowa, Kansas, Missouri, Nebraska, Oklahoma)
Central.Quotes@allegion.com

Chicago

(Illinois-Northern, Wisconsin)
Chicago.Quotes@allegion.com

Florida

Florida.Quotes@allegion.com

Great Lakes

(New York, Pennsylvania)
GreatLakes.Quotes@allegion.com

Metro New York

Metro.Quotes@allegion.com

Michigan

Michigan.Quotes@allegion.com

Mid Atlantic North

(New York, Pennsylvania)
Mid.Atlantics.north.quotes@allegion.com

Mid Atlantic South

(Delaware, Maryland, New Jersey)
Mid.Atlantics.south.quotes@allegion.com

Midwest

(Indiana, Kentucky, Ohio, West Virginia)
Midwest.Quotes@allegion.com

Mountain States

(Colorado, Idaho, Montana, Nevada, Utah, Wyoming)
Mtn.States.Quotes@allegion.com

New England

(Connecticut, Main, Massachusetts, New Hampshire, Rhode Island, Vermont)
NewEngland.Quotes@allegion.com

North Central

(Minnesota, North Dakota, South Dakota)
NorthCentral.Quotes@allegion.com

Northern California

NoCal.Quotes@allegion.com

Northwest

(Alaska, Oregon, Washington)
Northwest.Quotes@allegion.com

South

(Alabama, Georgia, Louisiana, Mississippi, Tennessee)
South.Quotes@allegion.com

Southern California

(California-Southern, Hawaii)
SoCal.Quotes@allegion.com

Southwest

(Arizona, New Mexico)
Southwest.Quotes@allegion.com

Texas

Texas.Quotes@allegion.com

Contents		CO Series Accessories	200
Contact Information	2	CT5000 Offline Controller	202
Table of Contents	3		
TERMS AND CONDITIONS	4	PARTS	205
Allegion General Terms & Conditions	4	AD Series Parts	205
Product Warranties	10	CO Series Parts	219
Keyway and Cylinder Policies	14	ELECTROMAGNETIC LOCKS	233
Distribution Policy	19	M490 Max Security	234
Finish Information	19	M450 High Security	235
SOLUTIONS OVERVIEW	21	M420 Traffic Control Series	236
CREDENTIALS	23	M490DE Delayed Egress Series	237
SmartCard Credentials	26	M390RFK Retrofit Lock	238
Proximity Credentials	30	Filler Plates and Angle Brackets	239
Magnetic Stripe Credentials	31	M490G Gate Lock	240
NETWORKED READERS	33	320M Mini Mortise Mount	240
Multi-Technology Readers	36	GF3000 Shear Lock Mortise Series	241
Magnetic Stripe Readers	36	GF-3000 Shear Lock Surface Series	242
Contactless Smart Card Readers	36	Electromagnetic Lock Parts	243
Proximity Readers	36	POWER SUPPLIES	245
Schlage Magnetic Stripe Readers	39	PS902 Power Supplies + Option Boards	246
iButton Readers	39	PS904 Power Supplies + Option Boards	247
Scramble Keypads from Schlage	40	PS906 Power Supplies + Option Boards	248
Electronic Keypads	40	SYSTEM ACCESSORIES	249
Offline Keypads	40	8200 Series Consoles	250
ENGAGE™ TECHNOLOGY LOCKS	41	800 Series Remote and Local Monitoring Stations	250
LE How to Order	43	672 TouchBar	251
LE Greenwich Sectional with Rose	52	692 SmartBar	252
LE Addison Escutcheon	54	672 TouchBar / 692 SmartBar Parts	253
LE Parts	56	600 Series Heavy Duty Pushbuttons	254
LE Accessories	60	600 Series Heavy Duty Pushbutton Parts	255
NDE with ENGAGE Technology	61	700 Series Entry Level Pushbutton	256
NDE How to Order	62	650 Series Heavy Duty Keyswitches	257
NDE Wireless Lock Cylindrical	68	650 Series Heavy Duty Keyswitch Parts	258
NDE Wireless Lock Parts	70	Door Position Switches	259
CTE ENGAGE Single Door Controller	74	Door Cords	259
AD SERIES NETWORKED LOCKS	75	Electronic Horns	260
AD Series How to Order	76	Scanners/PIRs	260
AD-300 Networked Hardwired	90	740 Series Emergency Break Glass	260
AD-302 Networked Hardwired (FIPS 201-2 Compliant)	96	660 Series Surface Mini Box	260
AD-400 Networked Wireless	102	442S Series Cabinet Lock	261
AD-402 Networked Wireless (FIPS 201-2 Compliant)	108	PB405/PB405S PowerBolts	261
AD Series 993 Dummy Trim	114	VON DUPRIN ACCESS CONTROL PRODUCTS	263
AD Series Networked Accessories	116	4200/6400 Series Electric Strikes	264
AD SERIES STANDALONE LOCKS	121	5100/6100/6200 Series Electric Strikes	265
AD Series Standalone Locks How to Order	122	6300 Series Electric Strike	266
AD-201/AD-302/AD-402 Overview	123	PS914 Power Supply	266
AD-200 Standalone; Rights on Locks	134	Delayed Exit System	266
AD-201 Standalone (FIPS Compliant)	140	Electric Power Transfer	266
AD-250 Standalone; Rights on Card	146	BIOMETRICS	267
AD Series 993 Dummy Trim	152	General Ordering Information	269
CT5000 Offline Controller	154	Biometric Readers	270
AD Series Standalone Accessories	156	Biometric Options	271
CO SERIES STANDALONE LOCKS	159	Biometric Accessories	272
CO Series How to Order	160	Biometric Parts	273
CO Series Overview	161	MISCELLANEOUS	275
CO-100 Standalone; Manually Programmable	172	Agency Listing	276
CO-200 Standalone; Computer or Manually Programmable with user Rights on Locks	178	Door & Frame Handing Chart	278
CO-220 Standalone; Classroom Lockdown Solution	184	System Design Guide	281
CO-220 Classroom Lockdown Solution - Exit Trim	188	Key Systems Summary	283
CO-993DT - Non-Functioning Dummy Trim for Exit	190	Wiring Diagrams	297
CO-250 Standalone; Computer Programmable with user Rights on Magnetic Stripe Card	192	BAA Order Transmittal Cover Letter	301
CO-993DT Non-functioning Dummy Trim for Exit	198		

Terms & Conditions

Allegion General Terms and Conditions of Sale and Service

1. GENERAL/ACCEPTANCE. (a) This Agreement contains the only terms and conditions by which Company will quote and sell Deliverables to Customer; (b) The terms "purchase order" or "order" for the purposes of this Agreement include the term "request for quotation," as appropriate; (c) This Agreement supersedes all pre-printed or boilerplate terms and conditions set forth in any purchase order issued by Customer; (d) No reference herein to Customer's purchase order will in any way incorporate different or additional terms and conditions, all of which Company hereby expressly objects to; (e) **ANY ACCEPTANCE BY COMPANY OF CUSTOMER'S PURCHASE ORDER IS EXPRESSLY CONDITIONED ON THE CUSTOMER'S ASSENT TO AND ACCEPTANCE OF THE TERMS AND CONDITIONS CONTAINED IN THIS AGREEMENT;** (f) Company reserves the right to decline any order, in whole or in part, for any reason.

2. ORDERS.

a. **Order Processing.** When Customer wishes to place an order for Deliverables, it will deliver to Company a purchase order. All such purchase orders must (i) be in a written format acceptable to Company, (ii) be legible, (iii) include a purchase order number, (iv) include Customer's account number, invoice address, ship to address, shipping method, shipper's letter of instruction for international shipments, part number, pricing, and designated contact information, (v) include, if applicable, any special configuration ID numbers, necessary programming information, special factory instructions, and requested specifications regarding a particular finish, handing, design, backset, or strike, (vi) reference any applicable pricing discounts under an ongoing buying program or based on a written quote from Company, along with the applicable buying program number or quotation number, and (vii) not combine buying program and quoted product on the same order.

b. **Minimum Orders.** In the event the order value does not meet any required minimum net Deliverable value, Company may, at its sole discretion, (i) increase the quantity of items in the order to meet the minimum net Deliverable value requirement; (ii) apply a minimum order charge; (iii) reject the order, or (iv) waive the requirement, provided that the waiver of a requirement for one order shall not constitute a waiver of the requirement for any future orders.

c. **Acceptance of Purchase Orders.** Company will endeavor to (i) acknowledge receipt of each purchase order issued in accordance with this Agreement, and (ii) notify Customer whether Company accepts or rejects the purchase order. If Company fails to accept or reject a purchase order within a reasonable time period, such failure to respond will be deemed a rejection of the entire order. Orders that combine buying program and quoted product on the same order will be routed back to your local RSO office in order to review subject purchase order.

d. **Changes to Order/ Cancellation of Orders.** Additional terms and conditions regarding order changes and cancellations are available on the Allegion customer website, **WHICH TERMS ARE EXPRESSLY INCORPORATED HEREIN BY REFERENCE.** Unless otherwise provided herein, Customer acknowledges that (i) requesting a Change Order may cause a delay in the scheduled shipment date, a longer lead time or result in a new scheduled shipment date; (ii) Orders may not be changed after 48 hours of Company's order acknowledgment; (iii) After 48 hours of Company's order acknowledgment, all changes to an accepted purchase order will be subject to a Change Order charge of 25% of the net Deliverable value, plus the cost of labor and fabrication or raw material that Company incurred prior to the receipt of the Change Order from Customer, or that may be required due to the Change Order; (iv) the requested change may result in additional charges for labor, fabrication, and raw material, and (v) if Customer cancels an order or portion of an order that includes Deliverables that have been manufactured and prepped for shipping, a 45% restocking fee will apply. Notwithstanding the foregoing, Customer cannot change or cancel credential orders, reader orders, biometrics orders or any non-cataloged, special, Custom or nonstandard items once they have been placed. All cancelled orders for a Non Recurring Expense (NRE), credential orders, reader orders, biometrics orders, and/or Custom orders will be subject to a cancellation charge of 100% of the acknowledged price.

e. **Add-ons.** Add-on orders will not be accepted. Additions to orders will be entered as separate stand-alone orders and must qualify for all terms of sale, including discounts, on an individual basis.

f. **Fast-Track Orders.** No changes or cancellations will be accepted on the 24-Hour Fast Track Program. For 3-day Fast Track orders, changes and cancellations may only be requested by Customer within 24 hours of Company's order acknowledgment if the order has not shipped. For 5-Day Fast Track orders, changes and cancellations may only be requested by Customer if the order has not shipped and if the request is made to Company within 48 hours of Company's order acknowledgment. Return Material Authorization (RMA) for Deliverables must be processed through Fast Track Customer Service.

g. **Steelcraft Orders.** For all Steelcraft orders, changes or cancellations are allowed without penalty only if made within 48 hours of Company's order acknowledgment, and provided that the order has not shipped. Some exceptions do apply – please consult the factory. Changes are not allowed on Rapid Program orders after the order has been entered and acknowledged. After 48 hours of Company's order acknowledgment, all changes or cancellations are subject to a charge of 25% of the order. Unless otherwise specified by Company in writing, any changes to orders acknowledged by Company that affect the delivery date will be deemed a new order and will require acknowledgment by Company as provided in this Section. Additional products, features, terms and conditions regarding the Rapid Program are available on the Allegion customer website, **WHICH TERMS ARE EXPRESSLY INCORPORATED HEREIN BY REFERENCE.**

3. PRICES, INVOICES AND PAYMENT.

a. **Prices.** The prices in Company's Price Book are subject to change at any time, without notice to Customer. Company may charge Customer additional amounts if Customer requests special packing, marking, shipment, product modification, or engineering services. Oral prices specified by Company are null and void. Quote numbers must be referenced on Customer's purchase order in order for the Company's quoted pricing to apply. Orders that do not reference a quote number will receive buy program pricing or book net pricing. Quoted prices are for those specific products quoted for a specified job, and are subject to the Price Book in effect at the time Company receives the order.

b. **Taxes.** Prices do not include any present or future federal, state or local property, license, privilege, sales, use, excise, gross receipts or other like taxes or assessments which may result from transactions or any services performed in connection therewith. Any taxes, charges, or duties imposed by any governmental authority on the sale of Deliverables will be paid by Customer, in addition to the selling price specified by Company. Credits for U.S. sales tax applied to invoices will only be granted if valid exemption documentation is provided within 30-days of the invoice date and a case is initiated by customer service. Exemption documentation may be emailed to sales.tax.certificates@allegion.com, this e-mail address cannot be used to request a credit for sales tax charged all such requests must be made with customer service. All certificates sent to the e-mail address must include the following information: (1) Customer account number(s); (2) Customer name; and (3) Allegion brand(s) the certificate should be applied to.

c. **Payment Terms.** Company will deliver to Customer an invoice with each shipment of Deliverables hereunder. Customer will pay all invoiced amounts within 35 days of the invoice date (subject to any early pay discounts that may be offered to Customer by Company in its sole discretion). Customer will make all payments in United States dollars. Past due invoices will be subject to a late payment service charge of 1.5% per month on any overdue unpaid balance, equivalent to 18% per annum, or the maximum rate permitted by law, whichever is less. Customer shall reimburse Company for all costs of collection, including, without limitation, reasonable attorneys' fees, for any overdue amount owed by Customer to Company, and such collection costs shall also be subject to interest charges.

4. QUOTATIONS.

a. **Project Quotations.** Project or new construction quotes are restricted to the specific project quoted for the quantities, finishes, and series of Deliverables referenced on the quote. Company reserves the right to require proof of sale of Company products for any quoted project.

b. **Stock Quotations.** Deliverables fulfilling stock quotations may only be used for the following: i) Stocking of the Customer's shelves for small, quick-turn, discretionary projects, or ii) Sale to a general contractor or installer for new construction. Stock quotations may not be used for any project containing any Company no-substitution, specified products. Deliverables purchased under Stock Quotations cannot be redistributed to other Customer branch locations or re-sold to other resellers or used for aftermarket sales, end-user annual contracts or sold over the counter to any walk in trade.

c. **General.** All quotes are subject to this Agreement, unless otherwise specified by Company, and are subject to change at any time prior to Company's acceptance of a purchase order referencing the applicable quote number. Company, its representatives and employees reserve the right, in their sole discretion and for any reason, to refuse a Customer's request to quote a price other than the standard list price, regardless of whether Company or its representatives or employees have previously quoted discounted prices to the Customer on some or all of its orders. Customer's failure to comply with this Section 4 will be considered a material breach of this Agreement, and will entitle Company to immediately terminate any purchase orders and/or Customer's ability to distribute Company's products.

5. SECURITY INTEREST. Customer grants Company, and Company retains, a purchase money security interest and lien on any and all of Customer's rights, title and interest in each Deliverable sold by Company to Customer, wherever located, until the invoice for the applicable Deliverable(s) is paid in full, including any late charges and costs of collection. Customer authorizes Company to, and will assist Company in, taking all necessary steps to perfect and maintain Company's interest in such Deliverables.

6. CREDIT TERMS. Unless Customer pre-pays all of its purchase orders in advance, its purchase orders will be subject to the credit limit and other terms of credit ("Credit Terms") set forth in Company's credit application, which Credit Terms Customer acknowledges are subject to change by Company at any time. Company reserves the right to request payment in advance of shipment or any order or to request adequate assurances for Customer's payment of an order and may withhold or stop shipment, without any liability to Company, until Customer submits payment or adequate assurance of payment.

7. RESALE OF DELIVERABLES. Customer agrees and warrants that it will offer Company products in support of Company-written specifications and will maintain sufficient inventory to adequately support End Users, installers, and/or general contractors' needs. Company may implement an MSRP or a resale pricing programs at any time in its sole discretion. Failure to comply with such program(s) will be considered a material breach of this Agreement, and will entitle Company to immediately terminate any purchase order and/or Customer's ability to distribute Company's products. Customer shall, at its own expense, gain and maintain sufficient knowledge of the industry and products competitive with Deliverables so as to be able to (a) explain in detail to End Users, installers, and/or general contractors the differences between the Deliverables and competing products, (b) ensure that an adequate number of trained, capable and qualified technical personnel with sufficient knowledge of the Deliverables and who have obtained all necessary licenses and permits are available to assist End Users, installers, and/or general contractors, and (c) respond to such End Users, installers, and/or general contractors with respect to the general operation and use of the Deliverables including, but not limited to, (1) acting as a liaison between the End Users, installers and/or general contractors and Company in matters requiring Company participation, (2) providing general product information and configuration support on standard protocols and features, (3) collecting relevant technical problem identification information, and (4) posting and distributing any warranty information concerning the Products in accordance with Company's instructions. Customer is responsible for all service and support resulting from the re-sale of any Deliverable to End-Users, installers and/or general contractors, examples of which may include, but are not limited to, support activities such as installation, initialization, software set-up, training, trouble-shooting, technical support and field service. In the event Customer is unwilling or unable to perform said support activities, Company reserves the right to recover from Customer any and all expenses incurred by Company to resolve the aforementioned End-User, installer and/or general contractor issues. Technical product training is recommended for Customer in order to fully service and support Deliverables purchased from Company that are resold to End-Users, installers and/or general contractors.

8. DEFAULT. If Customer is in default of payment or otherwise with respect to any purchase order or other contract with Company, Company shall have the right, in addition to all other legal remedies and without prejudice to any of its right hereunder, to defer further shipments under that or any other purchase order until such default is corrected and to declare all outstanding bills of Customer to be immediately due and payable.

9. INSPECTION AND DELIVERY.

a. **Inspection.** Customer will inspect all Deliverables immediately after receiving them. Customer will be deemed to have accepted the Deliverables unless Customer notifies Company in writing of any nonconformance within 10 days of delivery and provides Company written evidence reasonably documenting that nonconformance. Inspection of Deliverables at Company's facility is not permitted.

b. **Delivery.** Delivery schedules for Deliverables are based upon current production capacities, material or component availability, and inventory, and may be changed by Company as conditions require. Delivery schedules for services are based upon Company's prompt receipt of, and prompt access to, Customer's equipment and all information necessary to complete the services. In no event will any delivery date be construed as falling within the meaning of "time is of the essence." Partial delivery shall be accepted by Customer and paid for at the price and on the terms stated herein. Any partial delivery shall constitute a separate sale, and payment shall be separately made when due. If any part of a delivery hereunder is not delivered by Company in accordance with Customer's purchase order, this Agreement shall not be affected thereby.

10. TITLE & RISK OF LOSS. Unless otherwise specified by Company, (i) where the Customer is located in the United States, all Deliverables will be sold "Uniform Commercial Code, FOB Origin, Company's factory"; and (ii) where the Customer is located outside of the United States, all Products will be sold "Ex-works, Company's factory (Incoterms 2010)." In either instance, title and risk of loss will pass to Customer upon delivery to the carrier at Company's factory, provided, however, as set forth herein, Company shall retain a security interest in the Deliverables until full payment has been made therefore, and Customer agrees, upon request, to do all things and acts necessary to protect Company's interest by adequately insuring the Deliverables against loss or damage from any cause and to have Company named as an additional insured. Customer will promptly provide Company with a copy of the relevant certificate of insurance upon Company's request.

11. SHIPPING.

a. **Freight Charges.** Company will ship all Deliverables in accordance with Company's freight shipment guidelines, which are set forth on the My Allegion Portal ("Freight Shipping Guidelines"). **WHICH TERMS ARE EXPRESSLY INCORPORATED HEREIN.**

b. **Rush Charges.** Expedited order options are available as set forth in Company's Freight Shipping Guidelines.

c. **Packing and Marking.** Company will pack, mark, and ship Deliverables according to its standard procedures for shipment, unless the parties agree, in writing, that Company will comply with any special instructions provided by Customer. Special instructions may result in an increased price.

d. **International Shipments.** For all international orders, a Shipper's letter of instruction must be submitted in writing with the order. Failure to do so will result in the order being rejected. Complete adherence to this order requirement will be strictly enforced. Company will not be held liable for any charges resulting from delays due to lack of complete required information being supplied.

e. Once received by the Company, a purchase order cannot be combined with any other order to increase average order size as it relates to Company's Freight Shipping Guidelines. However, for orders placed under Company's FastTrack 24 Hour/5 Day Program (available for Schlage, Von Duprin, LCN and Glynn-Johnson products); ii) FastTrack 24 Hour/3 Day Program (available for Ives products); or ProExpress (available for specific product lines stated in the ProExpress price book for Falcon, Ives, Glynn Johnson, LCN, Schlage and Von Duprin products), the applicable brands or product categories may, subject to certain order requirements identified by Company, be combined on a single order to increase average order size used in Company's Freight Shipping Guidelines.

12. CLAIMS. All claims must be submitted in writing to Company as follows: (i) All claims for prices must be submitted within thirty (30) days from the date of invoice; (ii) All claims regarding Deliverable quantity or incorrect orders must be submitted within ten (10) days from the date of delivery; (iii) All claims for damage to Deliverables (while in the care, custody, and control of Company) must be submitted within thirty (30) days from the date of invoice; (iv) All claims for loss or damage to Deliverables while in the care, custody, and/or control of a carrier will be the responsibility of Customer, unless otherwise agreed by the parties.

13. PRODUCT CHANGES. Company's product policy is one of ongoing update and revision, and accordingly, Company reserves the right to change, without notice, the design of, or the process of manufacturing, the Deliverables covered by this Agreement.

14. PRODUCT USAGE LIMITATION. Customer agrees: (i) not to sell or use a Deliverable in any manner contrary to the manner in which the Deliverable is intended to be used; and/or (ii) not to modify the design of any Deliverable for use with another product without the prior written consent of Company.

15. PRODUCT RETURNS. Unless otherwise agreed by the parties in writing, Deliverables that are correctly furnished by Company per the purchase order may not be returned unless Customer receives written authorization from Company. If returns are authorized by Company, a return merchandise authorization ("RMA") number must be provided by Company. Deliverables identified under such RMA must be returned to Company within 90 days of issuance of the RMA. Such RMA number and any accompanying RMA documents, the original invoice number, and a written explanation for the return must be included with the returned Deliverables in order for Company to inspect and approve a credit for the return. **For warranty returns,** a credit in the amount of the original purchase price will only be issued if, after Company's receipt and inspection of the returned Deliverables, Company confirms, in its sole discretion, the defect is valid and approves the return. **For non-warranty returns/convenience returns,** in the event Company approves such a return, in its sole discretion, the following shall apply: (a) the total amount of Deliverables requested to be returned shall be a minimum of \$250.00; (b) a credit will be made to Customer's account in the amount of the original purchase price less freight and a handling charge of 45% of the net material on the original invoice; and (c) only Deliverables that are new, current, standard, non-obsolete, non-specially manufactured, unused, in their original condition as at the time of sale by Company to Customer, in their original packaging and in Customer's inventory less than 180 days from the date of shipment by the Company, and not ordered as part of a master key solution may be considered by Company for return. Such credit will only be issued if, after Company's receipt and inspection of Deliverables, Company approves the return. The amount of final credit will be determined upon receipt at the factory and following Company's inspection and analysis of the condition of the returned material. Company retains the right to deny credit to anyone for any reason.

16. CONFIDENTIAL INFORMATION.

a. **Non-Use And Non-Disclosure.** Customer shall not use the Confidential Information of the Company except for the purpose of performing its obligations under this Agreement or exercising the rights granted herein (the "Purpose"). Customer shall protect Confidential Information of the Company from disclosure and unauthorized use in the same manner that it protects its own Confidential Information, but in no event shall such standard of care be less than reasonable care. Customer may disclose Confidential Information of the Company only to its employees who require such information for the Purpose and who are subject to confidentiality obligations at least as protective as those set forth herein.

b. **Proprietary Information and Advice.** (a) All designs, data, and specifications provided by Company are proprietary and may not be disclosed or reused by Customer without the prior written consent of Company; (b) Company assumes no obligation or liability for any advice given by Company, the results obtained, or damages incurred as a result of such advice, and all such advice is given and accepted at Customer's risk.

c. **Return.** Upon the termination or expiration of a purchase order or this Agreement or upon the request of the Company, the Customer agrees to end all further use of, to immediately return to the Company the original version of, and to delete or destroy all copies of, any and all Confidential Information of the Company.

17. TRADEMARKS. Except as agreed to by Company in writing, Customer agrees not to (a) use Company's name in any form of publicity; or (b) use, create, register or market, directly or indirectly, in whole or in part, Company's names, logos, brands, or any other trademarks, or names that are now or may hereafter be owned by Company, as part of Customer's corporate or business name, as part of an internet domain name, uniform resource locator (URL), or in any way connected with Customer's business, trade address or other designations. Upon termination of this Agreement or upon the request of company for any reason, any use of Company's trademarks or names will be immediately discontinued.

18. LIMITED WARRANTY.

COMPANY MAKES NO OTHER WARRANTIES EXCEPT THOSE STATED IN COMPANY'S LIMITED WARRANTY IN EFFECT ON THE DATE COMPANY ACCEPTS EACH APPLICABLE PURCHASE ORDER ("LIMITED WARRANTY"). THE LIMITED WARRANTY MAY BE FOUND IN THE APPLICABLE PRICE BOOK AND ON THE ALLEGION CUSTOMER WEBSITE, WHICH TERMS ARE EXPRESSLY INCORPORATED HEREIN BY REFERENCE. COMPANY WILL MAIL CUSTOMER A HARD COPY OF THIS WARRANTY UPON CUSTOMER'S WRITTEN REQUEST. IN THE EVENT THAT CERTAIN DELIVERABLE WARRANTIES ARE NOT FURNISHED BY THE COMPANY TO CUSTOMER, COMPANY WARRANTS ONLY TO CUSTOMER THAT THE DELIVERABLES WILL BE FREE FROM DEFECTS IN MATERIAL AND WORKMANSHIP FOR A PERIOD OF 12 MONTHS FROM THE DATE OF SHIPMENT OF THE DELIVERABLES. COMPANY'S SOLE OBLIGATION UNDER THIS WARRANTY IS LIMITED TO REPAIRING OR REPLACING, AT COMPANY'S OPTION, THE DEFECTIVE DELIVERABLE, PROVIDED WRITTEN NOTICE OF THE DEFECT OR NONCONFORMANCE IS PROVIDED BY CUSTOMER WITHIN 30 DAYS OF DISCOVERY OF THE DEFECT OR NONCONFORMANCE. COMPANY DISCLAIMS ALL OTHER WARRANTIES, EXPRESS OR IMPLIED, WITH RESPECT TO THE DELIVERABLES, INCLUDING BUT NOT LIMITED TO, ANY IMPLIED WARRANTIES OF NON-INFRINGEMENT, MERCHANTABILITY, OR FITNESS FOR A PARTICULAR PURPOSE.

a. **Exclusions.** The provisions of this Limited Warranty do not apply to Deliverables that: (A) are not the proper size for the application; (B) are not installed in accordance with Company's published installation instructions; (C) are installed with improper or incorrect parts and/or are used for purposes for which they are not designed or intended; (D) have been repaired or altered without the Company's prior written consent; (E) have been subjected to misuse, abuse, negligence or accident; (F) have been improperly stored, installed, maintained or operated; (G) have been used in violation of written instructions provided by Company to Customer; (H) have been subjected to improper temperature, humidity, or other environmental conditions, or (I) have been affected by normal wear and tear. In addition, the provisions of this Limited Warranty do not apply to any defects or issues with the design or performance of equipment or products not manufactured by Company, nor does it apply to any code compliance or permit requirements for the assembly, installation, erection or construction of any goods. Company is not responsible for loss or damage resulting from use of Deliverables in conjunction with parts or systems not manufactured by Company. Accessories or products furnished by the Company, but manufactured by others, shall carry whatever warranty the manufacturers have conveyed to the Company and which can be passed to Customer.

b. **Services.** Company warrants that its services will be free from defects in material and workmanship for a period of 12 months from the date of completion of the particular items of service. Company's sole obligation under this service warranty is limited to repair or reperformance, at its option of the service, provided however, if repair or reperformance is either impractical or impossible, the Company will refund to Customer that portion of the price paid to Company for any defective service, provided written notice of the defect or nonconformance is provided by Customer within 30 days of discovery of the nonconformance.

c. **Notification.** Customer agrees to immediately notify Company in writing if any claim is made against Customer for any damages caused by any modules, parts, products, service or other Deliverables which may be the direct result of any defect in the manufacture of such aforementioned products. Customer agrees to cooperate with Company and its counsel in the defense of such claim and Customer agrees not to settle such claim without Company's written consent. If Customer fails to notify Company of such claim or fails to cooperate in such defense as aforesaid, then Company shall be discharged from any obligations under this Section and shall have no further liability to Customer.

d. **Exceptions.** The following costs and expenses are not covered by the provisions of these limited warranties: (i) labor costs for the removal and reinstallation of Deliverables or other manufacturer's products; (ii) shipping and freight expenses required to return Deliverables to Company; (iii) normal maintenance; and (iv) economic losses. In addition, the provisions of this warranty are not applicable to anything other than defects in Company's material (products only) or workmanship.

19. LIMITATION OF REMEDIES.

CUSTOMER'S EXCLUSIVE AND SOLE REMEDY ON ACCOUNT OF, OR IN RESPECT OF, THE FURNISHING OF NON-CONFORMING DELIVERABLES, SHALL BE TO (A) SECURE REPAIR OR REPLACEMENT OF THE PRODUCTS; OR (B) SECURE REPAIR OR RE-PERFORMANCE OF THE SERVICES OR TO OBTAIN A REFUND OF THE PRICE PAID FOR THE DEFECTIVE SERVICE, ALL AT COMPANY'S OPTION. IN NO EVENT WILL THE COMPANY'S MAXIMUM LIABILITY EXCEED THE SELLING PRICE FOR THE DELIVERABLE. THE WARRANTY, OBLIGATIONS AND LIABILITIES OF COMPANY (INCLUDING ITS SUPPLIERS) AND THE RIGHTS AND REMEDIES OF CUSTOMER ARE EXCLUSIVE AND ARE IN LIEU OF AND CUSTOMER HEREBY WAIVES AND RELEASES ALL OTHER WARRANTIES, OBLIGATIONS, REPRESENTATIONS OR LIABILITIES EXPRESS OR IMPLIED ARISING BY LAW, IN CONTRACT, TORT (INCLUDING NEGLIGENCE OR STRICT LIABILITY) OR OTHERWISE, INCLUDING BUT NOT LIMITED TO (I) ANY IMPLIED WARRANTY OF MERCHANTABILITY OR FITNESS FOR A PARTICULAR PURPOSE OR ANY WARRANTY IMPLIED THROUGH COURSE OF PERFORMANCE, COURSE OF DEALING, OR USAGE OF TRADE OR (II) CLAIMS ARISING OUT OF THE NEGLIGENCE OF COMPANY OR COMPANY'S SUPPLIERS OR (III) ANY OTHER CLAIM ARISING OUT OF, CONNECTED WITH, OR RESULTING FROM THE PERFORMANCE OF COMPANY OR FROM THE DESIGN, MANUFACTURE, SALE, REPAIR, LEASE OR USE OF THE DELIVERABLE, OR ANY COMPONENT THEREOF, DELIVERED OR RENDERED HEREUNDER OR OTHERWISE.

20. INDEMNIFICATION AND LIMITATION OF LIABILITY.

a. Customer shall indemnify, defend and hold Company, and its officers, directors, employees, customers, Affiliates, suppliers, users and agents, (collectively the "Indemnitees") harmless from and against any and all damages, claims, losses, expenses, costs, obligations, liabilities, including without limiting the generality of the foregoing, liabilities for court costs and attorneys' fees, suffered directly or indirectly by an Indemnitee by reason of, or arising out of any injury, death or loss to any person, or injury to any property (collectively, "Damages"), received or sustained by any person(s) or property, arising out of, occasioned by, attributable or related to i) any breach of any representation or warranty made by Customer, its officers, directors, employees, affiliates, users, agents, representatives or customers to Company or any third party, (ii) any failure by

Terms & Conditions

Customer to perform or fulfill any of its covenants, acts and/or omissions to Company or to any third party, or (iii) any litigation, proceeding or claim by any third party relating in any way to the obligations of Customer and/or the Deliverables sold by Company to Customer hereunder. Customer shall not consummate any settlement of any indemnified claim without the Indemnitees' prior written consent. Customer's obligation to indemnify Indemnitees will continue in full force and effect notwithstanding the termination or expiration of any order under this Agreement. In any claim against an Indemnitee by an employee of Customer or any subcontractor or anyone directly or indirectly employed by any of them or anyone for whose acts they may be liable, the indemnification obligations set forth in this Section shall not be limited in any way by or for Customer or any subcontractor under any applicable worker's compensation act, disability or other employee benefit act, or insurance coverage. This provision shall survive termination of any order or Agreement. **IN NO EVENT WILL COMPANY, ITS OFFICERS, DIRECTORS, EMPLOYEES, CUSTOMERS, AFFILIATES, USERS AND AGENTS, (NOR COMPANY'S SUPPLIERS) BE LIABLE FOR ANY INCIDENTAL, CONSEQUENTIAL, INDIRECT, SPECIAL, OR PUNITIVE DAMAGES OF ANY KIND OR NATURE UNDER ANY CIRCUMSTANCES INCLUDING, BUT NOT LIMITED TO, LOSS OF USE OF THE PRODUCTS, SERVICE INTERRUPTION, LOSS OF PROFITS, LOSS OF REVENUE, LOSS OF INTEREST, LOST GOODWILL, LOSS OF DATA, WORK STOPPAGE, IMPAIRMENT OF OTHER GOODS, LOSS BY REASON OF SHUTDOWN OR NON-OPERATION, INCREASED EXPENSES OF OPERATION, OR CLAIMS OF CUSTOMER'S CUSTOMERS, OR ANY OTHER LOSSES OR DAMAGES ARISING OUT OF ANY LACK OR LOSS OF USE OF THE DELIVERABLES WHETHER BASED ON CONTRACT, WARRANTY, TORT (INCLUDING, BUT NOT LIMITED TO, STRICT LIABILITY OR NEGLIGENCE), PATENT INFRINGEMENT, OR OTHERWISE, EVEN IF ADVISED OF THE POSSIBILITY OF SUCH DAMAGES.**

b) **INTELLECTUAL PROPERTY INDEMNITY.** Company makes no representation or warranty to the Customer that the Deliverables shall not infringe any intellectual property rights including, without limitations, claims arising from patent, copyright, trademark, trade secret, or other intellectual property infringement. Customer agrees to hold Company harmless from and defend the Company against any such claim of intellectual property infringement, including any Damages resulting from that claim, the cost of complying with any preliminary or permanent injunction, and all other costs of defense (including the attorneys' fees and costs), in connection with the foregoing.

c) To the extent that applicable law does not permit any limitations set out in this Agreement, such limitation shall not be applied or invoked. Nothing in this Agreement will be interpreted to disclaim liability of Company or the Indemnitees for gross negligence or willful misconduct. The limitations of remedy and liability herein shall not be interpreted to affect Company's obligations, if any, for claims for (i) property damage, (ii) personal injury, or (iii) wrongful death asserted by persons who are not parties to or beneficiaries of this Agreement. Further, the limitations of remedy and liability herein shall not be interpreted to limit Company's or Customer's right, if permitted by applicable law, to assert a claim for contribution among joint tortfeasors in connection with a claim by a person who is not a party to this Agreement.

21. CERTIFICATIONS. Certification of Deliverables for compliance with UL and ANSI standards are tested and performed by third-party independent laboratories. Any field modification or alteration of certified Deliverables will void certification and Company is not liable to Customer to certify any modified or altered Deliverable.

22. TERM FOR CLAIMS. NO ACTION ARISING OUT OF ANY CLAIMED BREACH OF THIS AGREEMENT BY COMPANY MAY BE BROUGHT BY CUSTOMER MORE THAN ONE (1) YEAR AFTER THE CAUSE OF ACTION HAS ARISEN.

23. CONSUMER PRODUCTS WITH RESPECT TO "CONSUMER PRODUCTS" AS DEFINED UNDER THE MAGNUSON-MOSS WARRANTY ACT ("MMWA"), THE FOLLOWING STATEMENTS ARE MADE. (A) SOME STATES OR LOCAL LAWS DO NOT ALLOW LIMITATIONS ON HOW LONG AN IMPLIED WARRANTY LASTS, SO THE ABOVE LIMITATION MAY NOT APPLY TO YOU; (B) IF ANY IMPLIED WARRANTY IS PROVIDED UNDER THE MMWA, IT IS LIMITED TO THE DURATION OF THE WARRANTY PROVIDED IN SECTION 18 ABOVE. (C) SOME STATES OR LOCAL LAWS DO NOT ALLOW THE EXCLUSION OR LIMITATION OF INCIDENTAL OR CONSEQUENTIAL DAMAGES, SO THE ABOVE LIMITATION OR EXCLUSION MAY NOT APPLY TO YOU; AND (D) THIS WARRANTY GIVES YOU SPECIFIC LEGAL RIGHTS AND YOU MAY ALSO HAVE OTHER RIGHTS WHICH VARY FROM STATE TO STATE OR LOCATION TO LOCATION.

24. FORCE MAJEURE/EXCUSABLE DELAY. Any delay or failure of Company to perform its obligations hereunder will be excused to the extent that it is caused by an event or occurrence beyond Company's control such as, by way of example and not by way of limitation, acts of God, acts by any governmental authority (whether valid or invalid), governmental laws and regulations not presently in effect, fires, floods, windstorms, explosions, riots, natural disasters, wars, sabotage, accidents, labor problems (including, without limitation, lockouts, strikes, and slowdowns) at Company's facility, its source plant or their suppliers, inability to obtain power, material, labor equipment, or transportation, or court injunction or order. The delivery date will be extended for a time equal to that of the delay and the schedule for Company's performance will be deemed adjusted to that effect.

25. ENTIRE AGREEMENT AND AMENDMENT. This Agreement, together with the attachments, exhibits, webpages, or supplements specifically referenced and incorporated herein, constitute the entire agreement between Company and Customer with respect to the matters contained herein and supersede all previous communications, representations, or agreements, either oral or written between Company and Customer. No agreement or understanding varying or expanding this Agreement will be binding upon either party unless it is in writing and signed by a duly authorized representative of each party hereto.

26. CONFLICTS. In the event of any conflict or inconsistency between the terms of any agreement, or any part of an agreement or the various documents (including, but not limited to, electronic documents) between Company and Customer, unless the parties agree otherwise in writing, the various components of the agreements shall be given the following precedence (in descending order of precedence): a) any master agreement or long term agreement between Company and Customer; b) any specific terms, conditions and/or warranties of the individual products or Deliverables; c) the terms and conditions of this Agreement, and d) any purchase order.

27. UNSATISFACTORY CREDIT/TERMINATION FOR INSOLVENCY OR DEFAULT. Customer shall furnish Company with statements evidencing Customer's financial condition as Company may, from time to time, reasonably request, and shall notify Company immediately of any and all events that may have a material adverse effect on Customer's business or financial

condition. If Company determines, in its sole discretion, that Customer's financial condition or creditworthiness is inadequate or unsatisfactory, then in addition to Company's other rights, Company may without liability or penalty, take any of the following actions: (i) modify the payment terms for any outstanding and/or future purchases; (ii) cancel any previously accepted orders; (iii) delay any further shipment of Deliverables to Customer; or (iv) any combination of the above.

Company may immediately terminate an order from Customer by giving written notice to Customer in the event of the happening of any of the following or any other comparable event: (i) insolvency of the Customer; (ii) filing of a petition in bankruptcy by or against the Customer; (iii) appointment of a receiver or trustee for the Customer; (iv) execution of an assignment for the benefit of creditors by the Customer, all of which will allow Company to demand reclamation of all affected orders; (v) Customer ceases or threatens to cease to trade; (vi) Company determines that Customer does not meet or no longer meets the credit requirements of Company or Customer's credit account is closed; (vii) any Customer violation of law, specifically including, without limitation, those laws set forth in this Agreement.

In the event of termination in accordance with this section, Company will not be obligated to accept any existing or additional orders from Customer and Company will be released from its obligation to deliver under orders accepted prior to such termination. The rejection or termination of any order by Company will not entitle Customer to any termination or severance compensation, or to any payment in respect to any goodwill established by Customer, or render Company liable for damages on account of the loss of prospective profits, or on account of any loss, expenditure, investment or obligation incurred or made by Customer.

No action taken under this Section 27 by Company (nor any failure of Company to act under this Section 27) will constitute a waiver by Company of any of its rights to enforce Customer's obligations, including the obligation of Customer to make payments as required under this Agreement. Upon termination of any order, all amounts owed by Customer to Company will become immediately due and payable, whether or not otherwise then due or payable.

28. CREDIT RISK ON RESALE OF DELIVERABLES. Customer is responsible for all credit risks with respect to, and for collecting payment for, all Deliverables sold to third parties (including End Users, installers, and/or general contractors) whether or not Customer has made full payment to Company for such Deliverables. The inability of Customer to collect payment for any Deliverable shall not affect Customer's obligation to pay Company for any Deliverable.

29. GOVERNING LAW; VENUE; AND EXPENSES. Any dispute or claim relating to this Agreement shall be governed by and construed according to the laws of the State of Indiana (excluding its conflict of laws principles); and not by the provisions of the 1980 United Nations Convention on the International Sale of Goods. Any disputes or claims shall be instituted and maintained in the courts of the State of Indiana. Customer consents to the exercise of jurisdiction over it by such courts and agrees that Indiana is not an inconvenient forum for any action arising from or relating to this Agreement. Customer agrees to pay for all expenses (including, but not limited to, collection costs, court costs and attorneys' fees) incurred by Company in enforcing the obligations of Customer under this Agreement.

30. RELATIONSHIP OF THE PARTIES. Nothing in this Agreement or any other document creates an employment, partnership, joint venture, or agency relationship between Company and Customer, including that of franchisee/franchisor. No party will have any power or authority to enter into any commitment on behalf of or otherwise bind the any other party on any matter. No employee of Customer will be deemed to be an employee of Company. If any provision of this Agreement is deemed to create a franchise relationship or business opportunity between the Parties, then Company may terminate any purchase order or this Agreement or the Parties shall negotiate in good faith to modify this Agreement so as to effect the original intent of the Parties as closely as possible in a mutually acceptable manner in order that the transactions contemplated hereby are consummated as a reseller agreement and not a franchise or business opportunity agreement.

31. SETOFF. Customer does not have the right to setoff or to back charge against any amounts which become payable to Company under this Agreement or otherwise. Company will not accept responsibility for backcharges for the cost of material or labor by Customer or any third party.

32. ELECTRONIC COMMUNICATIONS AND ELECTRONIC SIGNATURES. Both parties expressly agree to electronic transactions and acknowledge that documents they sign electronically will bind them to the same extent as a paper signature. Customer represents and warrants to Company that only employees authorized to bind Customer legally shall electronically sign any document under this Agreement. Customer shall comply with any method of electronic communication/payment processing specified by Company, including electronic funds transfer, pay-on-receipt processes/systems, order transmission, releases, electronic signature, and electronic communication systems, including, without limitation, the use of electronic data interchange ("EDI") portals. Notwithstanding the foregoing, e-mails, even those containing a signature block of one of Company's representatives, shall not constitute a signed writing.

33. COMPLIANCE WITH APPLICABLE LAWS.

a. **General.** Company and Customer will comply with all applicable federal, state and municipal laws, regulations, codes, ordinances and orders that pertain to the Deliverables, including but not limited to full compliance with any applicable provisions of The Health Insurance Portability and Accountability Act. Where the Customer is located outside the United States, or where the customer intends to ship the product outside the United States, the Customer shall be responsible for compliance with all U.S. export laws, and for filing all U.S. Electronic Export Information, as applicable.

b. The Customer acknowledges and agrees that: (i) it shall not violate applicable laws and regulations in performing its duties under this Agreement; (ii) it does not and shall not engage in any conduct that shall violate any applicable anti-bribery or anti-corruption laws or regulations; (iii) it (and its owners, officers, directors, employees and agents) shall not pay, offer, promise or authorize the payment of, either directly or indirectly, anything of value (including but not limited to cash, gifts and entertainment) to (a) any government official or employee of any government; (b) any official or employee of any department, agency, or instrumentality of a government; (c) any employee of any corporation or entity owned or controlled by a government; (d) any family member of such officials or employees; (e) any political party, party official, or political candidate; or (f) any other persons, owners, officers, directors, employees and agents of any corporation or entity; to improperly or illegally assist in obtaining or retaining business (including but not limited to any contracts, avoidance of duties or reduction of tariffs, reduction of taxes or

to obtain money owed, or to obtain regulatory approval) or for the purpose of causing, soliciting or inducing the sale and purchase of the Deliverables by any party, and (iv) it has full knowledge of and will comply with the Company's Code of Conduct for Business Partners as set forth on the Allegion customer website, **WHICH IS HEREBY INCORPORATED BY REFERENCE.**

c. The Customer shall indemnify and hold the Company harmless from any claim, demand, expense or cost arising from any breach of this Article.

d. The Customer shall permit the Company to conduct an audit or review of the Customer's financial books and records and business operations at such other times that the Company considers it necessary to confirm compliance with this provision. Such audit may be conducted by representatives of the Company or, at the Company's sole discretion, by a certified public accounting firm selected by the Company. The Customer shall cooperate with any inquiries from the Company's Ethics & Compliance Group.

e. A violation of this provision constitutes a material breach of this Agreement and the Company may terminate any purchase order or this Agreement immediately, with no opportunity to cure, in accordance with Section 27 of this Agreement.

f. Notwithstanding the foregoing provisions of this Section 33, (i) Company is not responsible for obtaining or maintaining any permits for the performance of services or the verification or compliance with any code requirements relative to the performance of services, (ii) to the extent any sale of Deliverables pursuant to this Agreement may require approval of the U.S. Government, Company's obligations under this Agreement are conditioned upon the grant of such approval and upon compliance by Customer with any restrictions imposed by the U.S. Government in connection with such approval, and (iii) in the event the Deliverables are to be used in a nuclear facility, the Customer shall, prior to such use, arrange for insurance or governmental indemnity protecting Company against liability. The Customer hereby releases and agrees to indemnify Company and its suppliers for any nuclear damage including, but not limited to, loss of use, in any manner arising out of the nuclear incident, whether alleged to be due, in whole or in part by Company or its suppliers.

g. **No Inducements.** Each party represents to each other that neither it nor any person acting on its behalf has, in contravention of any applicable law, given or offered to give or will give or offer to give, any sum of money or other material consideration to any person, directly or indirectly, as an inducement to obtain business hereunder or to influence the granting of licenses or other governmental permissions to enter into this Agreement or perform obligations hereunder.

h. **Equal Employment Opportunity.** Company is a U.S. federal contractor that complies with Executive Order 11246, as amended, and applicable regulations in 41 CFR Parts 60-1 through 60-60, 29 U.S.C. § 793 and applicable regulations in 41 CFR § 60-741; and 38 U.S.C. § 4212 and applicable regulations in 41 CFR Part 60-250 and 60-300. **THE FOLLOWING PROVISIONS ARE INCORPORATED HEREIN BY REFERENCE:** Executive Order 11246, as amended by Executive Order 13672, and 41 CFR § 60-4.3(a); Executive Order 11701 and 41 CFR §§ 60-250.5(a), 60-300.5; Executive Order 11758 and 41 CFR § 60-741.5(a); U.S. immigration laws, including the L-1 Visa Reform Act of 2004 and the H-1B Visa Reform Act of 2004; and Executive Order 13496.

i. **Ethical Business Conduct.** Customer shall adopt and comply with Company's Business Partner Code of Conduct which is **EXPRESSLY INCORPORATED HEREIN BY REFERENCE.**

34. REPRESENTATIONS AND WARRANTIES. Customer represents, warrants and covenants to Company that: (a) it has the right, power, and authority to enter into this Agreement and fully perform its obligations hereunder; (b) it has all necessary rights in and to its respective Content and Marks for use within the scope of this Agreement, including the licenses granted herein; and (c) it complies, and at all times shall comply, with all laws, rules, and regulations in effect that are applicable to its performance under this Agreement, including obtaining all such approvals and/or permits as may be required hereunder.

35. NO THIRD-PARTY BENEFICIARY. Each party is entering into this Agreement solely based on the representations contained herein for its own purposes and not for the benefit of any third party.

36. NOTICES AND CHANGE OF ADDRESS. All notices or other communications under this Agreement shall be in writing and delivered in person, or sent by receipted courier, express mail, e-mail, or postage prepaid certified or registered mail, addressed to the party for whom it is intended, at the addresses set forth in this Agreement. Either party may change its address for notice by giving written notice to the other party. Any notice or other communication shall be deemed given no later than the date actually received. Notice by courier, express mail, certified mail, or registered mail shall be deemed given on the date it is officially recorded as delivered and, in the absence of such record of delivery, it shall be rebuttably presumed to have been delivered on the third Business Day after it was deposited. Notices sent by e-mail require tangible confirmation of receipt from addressee.

37. ASSIGNMENT. Customer may not assign this Agreement without the prior written consent of Company. Company may assign its rights and delegate its duties under this Agreement, without the prior consent of Customer, to an Affiliate, or to a third party in the event of a spin-off, merger, business combination, consolidation or sale of all, or substantially all, of its assets or business that are related to this Agreement. The rights and duties in this Agreement shall bind and inure to the benefit of any such assignee.

38. SEVERABILITY. If any provision of this Agreement is held to be invalid, illegal, or unenforceable under any statute, regulation, ordinance, executive order, or other rule of law, that provision will be deemed severed to the extent necessary to comply with such statute, regulation, ordinance, order, or rule. In the event such provision is deemed severed, the parties will negotiate in good faith to arrive at an alternative arrangement approximating the original business objective of the parties. The remaining terms and conditions of this Agreement will remain in effect.

39. NO IMPLIED WAIVER. The failure of either party at any time to require performance by the other party of any provision of this Agreement will in no way affect the right to require such performance at any time thereafter, nor will the waiver of either party of a breach of any provision of this Agreement constitute a waiver of any succeeding breach of the same or any other provision.

40. MISCELLANEOUS. (a) This Agreement does not make either party the agent or legal representative of the other party. Neither party is authorized to create any obligation on behalf of the other party including, but not limited to, the obligation for payment of any service or warranty obligation hereunder; (b) The rights and remedies herein reserved to Company are cumulative and additional to any other rights and remedies provided at law or equity; (c) The official text of this Agreement is in the English language. If this Agreement is translated into another language, the English text will govern any question with respect to interpretation;

(d) The headings in this Agreement are for convenience of reference only and do not affect the meaning of this Agreement in any manner.

DEFINITIONS.

Capitalized terms have the meanings set forth in this Section, or in the Section in which they first appear in this Agreement.

"Agreement" means these Allegion Terms and Conditions of Sale and Service, together with any applicable Country Supplement or Region Supplement provided by Company, and all of the documents referenced herein or therein.

"Affiliate" means any Person that directly or indirectly, through one or more intermediaries, controls, is controlled by, or is under common control with, the Company. The term "control" (including the terms "controlled by" and "under common control with") means the possession, directly or indirectly, of the power to direct or cause the direction of the management and policies of a Person, whether through the ownership of voting securities, by contract or otherwise.

"Business Day" means any day except Saturday, Sunday or any other day on which commercial banks located in the United States are authorized or required by Law to be closed for business.

"Company" means Schlage Lock Company, LLC or any subsidiary or affiliate thereof selling products that are part of the Allegion product portfolio. Schlage Lock Company and/or its subsidiary or affiliates will be severally but not jointly liable under the Agreement.

"Company Marks" refers to the Marks of Company.

"Confidential Information" shall mean any and all information provided by either party to the other party pertaining to the disclosing party's business. Confidential Information shall include, but not be limited to, any bitting lists, formulae for products, manufacturing processes, production techniques, packaging processes, methods, research materials, ideas, marketing plans and related materials, quality standards, test results and data, apparatus, engineering drawings, contract documents, computer software, hardware, or firmware, business activities information such as financial information, reports, projections, books and records, customer and supplier information, and operations, customer and supplier lists and data, specifications, know how, and other Proprietary Information or Trade Secrets (as defined herein) that either party may furnish to the other party. Confidential Information shall not include information that: (a) is or becomes publicly known if such public knowledge or disclosure is not the result of any act or failure to act on the part of the receiving party; (b) is, at the time of disclosure, already known to the Receiving Party without utilizing the Confidential Information; (c) is information disclosed to the Receiving Party by a third party which is not to the Receiving Party's knowledge, after inquiry of the third party, under a duty of confidentiality to the Disclosing Party; or (d) is independently developed by the Receiving Party without the use of Confidential Information.

The Receiving Party shall have the burden of proof as to prior knowledge and absence of breach. Confidential Information may be furnished in any tangible or intangible form including, but not limited to, writings, drawings, computer and other electronic media, logic diagrams, component specifications, graphs, prototypes, samples, or verbal communications and regardless of whether such information is marked or designated as "confidential." For the avoidance of doubt, all information, knowledge or data disclosed by Company to Customer, regardless of whether disclosed in written, tangible, oral, visual or other form, including, without limitation, sample products, equipment, software, or other objects or material, provided by Company to Customer, and all information, knowledge or data which was obtained by Customer from visits to Company's facilities, shall be considered "Confidential Information" under this Agreement.

"Content" means all information (including without limitation any text, music, sound, photographs, video, graphics, data or software), in any medium, on a particular Company Web page or Website or in Marketing Materials.

"Customer" means the purchaser of Deliverables from Company.

"Deliverables" means any good or service or both purchased by Customer from Company under these General Terms and Conditions of Sale and Service.

"End Users" means the purchaser that (a) has acquired a Deliverable from Customer for (i) its own and its Affiliate's/Affiliates' internal use and not for resale, remarketing or distribution or (ii) incorporation into its own products and (b) is an individual or entity, other than any federal, state or local agency, office or division.

"IP" means all intellectual property and industrial property rights comprising or relating to/ of the following: (a) Patents; (b) Trademarks; (c) internet domain names, whether or not Trademarks, registered by any authorized private registrar or Governmental Authority, web addresses, web pages, website and URLs; (d) works of authorship, expressions, designs and design registrations, whether or not copyrightable, including copyrights and copyrightable works, software and firmware, application programming interfaces, architecture, files, records, schematics, data, data files, and databases and other specifications and documentation; (e) Trade Secrets; and (f) all other intellectual property and industrial property rights, and all rights, interests and protections that are associated with, equivalent or similar to, or required for the exercise of, any of the foregoing, however arising, in each case whether registered or unregistered and including all registrations and applications for, and renewals or extensions of, such rights or forms of protection pursuant to the Laws of any jurisdiction throughout in any part of the world.

"Marketing Materials" means all marketing brochures, buckslips, pamphlets, emails, text, call scripts or other material, whether in printed format, audio or audiovisual format, or in any other format, that contain any (i) Content relating to the Company Deliverables or (ii) Company Marks.

"Marks" means collectively the domain names, trademarks, trade names, service marks, trade dress, logos, and the like used or provided by either party for use in connection with this Agreement.

"Patents" means all patents (including all reissues, divisionals, provisionals, continuations and continuations-in-part, re-examinations, renewals, substitutions and extensions thereof), patent applications, and other patent rights and any other Governmental Authority-issued indicia of invention ownership (including inventor's certificates, petty patents and patent utility models).

"Person" means a person or entity.

"Price Books" mean Company's current Price Book in effect for the applicable Deliverable being purchased by Customer.

"Trade Secrets" means and includes business or technical information of either party, including processes, formulas, devices, techniques, compilations and other material that a party attempts to maintain in secret and that derive commercial value for such party from not being generally known to the public or readily ascertainable through independent development or reverse engineering.

Additional Terms & Conditions

Commercial

The following specific product terms and conditions are applicable only to the extent provided herein. All other terms and conditions contained in the General Terms and Conditions of Sale and Service provided in this Price Book will govern the sale of products identified in this Price Book.

Prices:

This price list supersedes and cancels all previous price lists. Prices shown are subject to change without notice. All prices may be subject to discount.

Minimum Order Size for Channel Discount:

All orders less than \$500.00 list shall be discounted at book net.

Claims and Returns:

Due to Schlage error:

- Claims for shortages and/or incorrectly filled orders must be filed with Customer Service within 30-days of receipt of material.
- Incorrect order acknowledgments must be changed by emailing request to Customer Care territory email box upon receipt of acknowledgment. Refer to inside cover of this book.
- Invoice adjustments must be faxed to Credit Adjustments @ (317) 810-3048 within 30-days of receipt of invoice.
- Returned goods will not be accepted without prior written approval from Schlage. Credit will be based upon the Return Material Authorization (RMA) issued by Customer Service or the Allegion Consultant and final acceptance by Schlage. Returns must be prominently marked with the RMA number and follow return guidelines on the RMA form.
- Product considered being defective after review by the Allegion Consultant must be returned to the Schlage Lock Company facility in Security, Colorado accompanied by an RMA. Replacement orders for defective product will be entered by Customer Service at the time of notification.

Claims and Returns:

Due to Customer error:

- It is the policy of the Schlage Lock Company to not accept returns of any materials that are correctly furnished as per the dealer's purchase order.
- Return of product due to customer order error or accommodation must be pre-arranged with the Allegion Consultant and approved by Business Unit Manager.
- Returns are subject to a minimum restocking charge of 35% for unopened cases.
- Materials are not returnable.
- Product must be received in original factory condition and certified as such by Schlage Receiving.

Charge-backs will not be allowed.

Commercial

Delivery:

For the following:

Non-Master Keyed orders

Master Keyed orders
or

Non-Master Keyed orders prominently marked on the order to "Ship Complete"

Claims and Returns:

Expect this delivery:

Factory items will individually be assigned ship dates based on current lead times.

The entire order will be assigned ship dates grouped by factory location. Items with longest current lead times determine ship date for other items from that location.

All orders will be acknowledged with scheduled ship dates. Specific scheduled ship dates are not guaranteed by Schlage because of the nature of product, labor, availability of product or manufacturing conditions that might be beyond our control. Schlage will not be liable for back charges incurred based on availability of product in accordance with acknowledged ship dates. Selected Products are available to specific channels of distribution for 1 and 5-day delivery through the Allegion FastTrack Program. The Allegion FastTrack Program is subject to separate terms and conditions.

Order Changes or Cancellations:

Type of Change	Type of Product		
	- Primus® Keys	Normal Factory Lead Time items	⌚ Extended Factory Lead Time items
1. Change to: - Product, creating a different SKU number - Keying	Not Accepted	<ul style="list-style-type: none"> OK within first 2-days from receipt of order. If after 2-days, item must be deleted from order (see 3, 25% handling charge will apply) and entered as a new order (see 2). 	<ul style="list-style-type: none"> OK within first 10-days from receipt of order. If after 10-days, item must be deleted from order (see 3, 50% handling charge will apply) and entered as a new order (see 2).
2. Change to: - Increase quantity of existing item(s) - Add new item(s)	Not Accepted	<ul style="list-style-type: none"> New order with normal lead-time must be generated for additions. Same terms & conditions will be applied if requested so long as the original order has not been shipped. Additions received after the original order ships must be entered as a new order and will stand-alone for lead-time and terms & conditions. 	
3. Change to: - Delete item(s) - Reduce quantity of existing item(s) - Cancel order	Not Accepted	<ul style="list-style-type: none"> OK within first 2-days from receipt of order. If after 2-days, subject o handling charge of 25% of the net price of the deleted item(s).** 	<ul style="list-style-type: none"> OK within first 10-days from receipt of order. If after 10-days, subject o handling charge of 50% of the net price of the deleted item(s).**

* Includes any change to key symbol, door identification and/or cylinder pinning.

** Handling charges are billed on the original order.

- Notes:**
- 1) Change orders must be emailed to your Customer Care territory email box. Please state change order request in subject line. For questions call (877) 671-7011.
 - 2) Customer Care will acknowledge receipt of change orders and action taken.
 - 3) Change orders resulting in handling charges require customer review prior to change being made.

WARRANTY

Schlage Electromagnetic Locks

Limited Lifetime Warranty:

Magnetic Coil Assembly. Schlage warrants only to the End User of electromagnetic locks that the magnetic coil assembly of the electromagnetic locks will be free from defects in material and workmanship for the lifetime of such electromagnetic lock.

Limited 12 Month or 18 Month Warranty:

Electronic Module. Schlage warrants only to the End User of electromagnetic locks that the electronic module of the electromagnetic locks will be free from defects in material and workmanship for a period of 12 months from the date of shipment of the electromagnetic locks from an authorized seller to the End User or a period of 18 months from the date of shipment of such electromagnetic locks from Schlage to an authorized seller, whichever period is shorter.

Limitations:

Schlage's sole obligation under this warranty is limited to repairing and replacing, at its option, the defective electromagnetic locks. If Schlage chooses to replace a defective electromagnetic lock as provided herein, Schlage may replace the defective electromagnetic lock with an equal or upgraded electromagnetic lock, at its option.

NO OTHER WARRANTIES, EXPRESS OR IMPLIED, ARE MADE WITH RESPECT TO THE ELECTROMAGNETIC LOCKS INCLUDING, BUT NOT LIMITED TO, ANY IMPLIED WARRANTY OF MERCHANTABILITY OR FITNESS FOR A PARTICULAR PURPOSE. SCHLAGE DOES NOT AUTHORIZE ANY PERSON TO CREATE FOR IT ANY OBLIGATION OR LIABILITY IN CONNECTION WITH ELECTROMAGNETIC LOCKS.

This warranty is exclusive and limited to the End User of the electromagnetic locks, and terminates upon the sale or transfer of the electromagnetic locks or the structure for which the electromagnetic locks are attached.

"End User" is defined in this limited warranty as the initial user of the products.

Exclusions to Warranty:

The provisions of this limited warranty do not apply to electromagnetic locks: (i) used for purposes for which they are not designed or intended; (ii) which have been repaired or altered without Schlage's prior written consent; (iii) which have been subjected to misuse, abuse, negligence, or accident; (iv) which have been improperly stored, installed, maintained, or operated; (v) which have been used in violation of written instructions provided by Schlage to an authorized seller and/or End User; (vi) which have been subjected to improper temperature, humidity, or other environmental conditions; (vii) which have been affected by normal wear and tear; or (viii) which, based on Schlage's or authorized seller's examination, do not disclose to Schlage's or an authorized seller's satisfaction nonconformance to the warranty.

The following costs and expenses are not covered by the provisions of this limited warranty: (i) labor costs for the removal and reinstallation of electromagnetic locks; (ii) shipping and freight expenses required to return electromagnetic locks to Schlage or an authorized seller; (iii) normal maintenance; and (iv) economic losses.

THE PROVISIONS OF THIS LIMITED WARRANTY ARE NOT APPLICABLE TO ANYTHING OTHER THAN DEFECTS IN SCHLAGE'S MATERIAL OR WORKMANSHIP.

End User's Remedies:

END USER'S EXCLUSIVE AND SOLE REMEDY ON ACCOUNT OF, OR IN RESPECT OF, THE FURNISHING OF ELECTROMAGNETIC LOCKS THAT DO NOT CONFORM TO THIS AGREEMENT WILL BE TO SECURE REPAIR OR REPLACEMENT OF THE ELECTROMAGNETIC LOCKS, AT SCHLAGE'S OPTION. IN NO EVENT WILL SCHLAGE'S MAXIMUM LIABILITY EXCEED THE SELLING PRICE FOR THE NON-CONFORMING ELECTROMAGNETIC LOCKS.

Limitation of Liability:

IN NO EVENT WILL SCHLAGE BE LIABLE FOR INCIDENTAL, CONSEQUENTIAL, INDIRECT, SPECIAL, OR PUNITIVE DAMAGES INCLUDING, BUT NOT LIMITED TO, LOSS OF USE OF THE ELECTROMAGNETIC LOCKS, LOSS OF PROFIT, LOSS OF REVENUE, INTEREST, LOST GOODWILL, WORK STOPPAGE, IMPAIRMENT OF OTHER GOODS, LOSS BY REASON OF SHUTDOWN OR NON-OPERATION, INCREASED EXPENSES OR OPERATION, OR CLAIMS OF END USERS, WHETHER BASED ON CONTRACT, WARRANTY, TORT (INCLUDING, BUT NOT LIMITED TO, STRICT LIABILITY OR NEGLIGENCE), PATENT INFRINGEMENT, OR OTHERWISE, EVEN IF ADVISED OF THE POSSIBILITY OF SUCH DAMAGES.

Statute of Limitations:

NO ACTION ARISING OUT OF ANY CLAIMED BREACH OF THIS AGREEMENT BY SCHLAGE MAY BE BROUGHT BY END USER MORE THAN ONE (1) YEAR AFTER THE CAUSE OF ACTION HAS ARISEN.

Consumer Products:

With respect to "customer products" as defined under the Magnuson-Moss Warranty Act ("MMWA"), the following statements are made.

(a) Some states do not allow the exclusion of limitation of incidental or consequential damages, so the above limitation or exclusion may not apply to the End User. (b) This warranty gives the End User specific legal rights and the End User may also have other rights which vary from state to state.

WARRANTY

Limited Warranty - Networked Readers & Credentials

Limited Lifetime Warranty – Credentials

Schlage Lock Company, LLC (hereinafter referred to as “Company”) extends a limited lifetime warranty to the original end-user purchaser (“Original Purchaser”) of our Credential, against defects in materials and workmanship under normal use and service.

Limited Lifetime Warranty – Networked Readers

Company extends a limited lifetime warranty to the original end-user purchaser (“Original Purchaser”) of our Networked Reader, against defects in materials and workmanship under normal use and service.

5-Year Limited Warranty – Networked Reader Keypads

Company extends a five year limited warranty on the Networked Reader Keypad, from the date of shipment, to the original purchaser (“Original Purchaser”) of our Networked Reader, against defects in materials and workmanship under normal use and service.

1-Year Limited Warranty – Networked Magnetic Stripe Read Head

Company extends a one year limited warranty on the Networked Magnetic Stripe Read Head, from the date of installation (not to exceed two years from the date of shipment from the factory), to the original purchaser (“Original Purchaser”) of our Networked Reader, against defects in materials and workmanship under normal use and service.

1-Year Limited Warranty – Magnetic Stripe Credentials

Company extends a one year limited warranty on our magnetic stripe credentials, from the date of shipment, to the original purchaser (“Original Purchaser”) of our Magnetic Stripe Credential, against defects in materials and workmanship under normal use and service.

“Credential,” “Networked Reader,” “Networked Reader Keypad,” and “Networked Magnetic Stripe Read Head” are collectively referred herein as “Product.” “Credential” shall not include credentials made of only PVC material.

What Company Will Do:

If a defect arises and a valid claim is determined by Company sole obligation, at its option, is to either repair or replace the Product covered under this warranty with a new or remanufactured Product. The repair or replacement of the Product, as provided herein, is Original Purchaser’s exclusive remedy.

Original Purchaser:

This limited warranty only applies to the Original Purchaser of the Products. It is non transferable and does not apply to any subsequent purchaser.

How to Submit a Claim:

In order to recover under this limited warranty, Original Purchaser must make a claim to Company and, if necessary, present acceptable proof of purchase. To start a claim submission, the Original Purchaser should contact Product Support at 1-877-671-7011 or 1-512-712-1316.

What Is Not Covered:

The following costs, expenses and damages are NOT COVERED by the provisions of this limited warranty: (1) back charges, labor costs or removal or re-installation of said products; (2) shipping and freight expenses required to return product to Company; (3) failures, defects, or damage (including, but not limited to, any security failure or loss of data) caused by any third party product, service, or system connected or used in conjunction with the Products; and (4) any other incidental, consequential, indirect, special, or punitive damages including, but not limited to, loss of use of the control panel or video recorder, loss of profit, loss of revenue, loss of interest, lost goodwill, work stoppage, impairment of other goods, loss by reason of shutdown or non-operation, damage to property, increased expenses or operation, or third-party claims, arising out of any theory of recovery, including warranty, contract, statutory or tort (including, but not limited to, strict liability or negligence), patent infringement, or otherwise, even if advised of the possibility of such damages. Credentials made only of PVC material are not covered under this warranty.

Exclusions to Warranty:

The provisions of this warranty do not apply to any Product which has been damaged due to conditions in which Company has no control including, but not limited to, catastrophe, improper installation or maintenance, accidents, modification, misuse, abuse, negligence, alteration, tampering or disassembly, undue electrical discharge or lightning strike, improper storage or use outside its intended and normal manner.

LIMITATION OF LIABILITY:

COMPANY MAKES NO OTHER WARRANTY, CONDITION OR REPRESENTATION OF ANY KIND WHATSOEVER, EXPRESSED OR IMPLIED, STATUTORY OR OTHERWISE, EXCEPT THAT OF TITLE, AND ALL IMPLIED WARRANTIES AND CONDITIONS RELATING TO THE MERCHANTABILITY AND FITNESS FOR A PARTICULAR PURPOSE ARE HEREBY DISCLAIMED, WHERE ALLOWED BY LAW. IN NO EVENT WILL COMPANY BE LIABLE FOR INCIDENTAL, CONSEQUENTIAL, INDIRECT, SPECIAL OR PUNITIVE DAMAGES OF ANY KIND.

Additional Terms:

Company does not authorize any person to create for it any obligation or liability in connection with the Product. Company’s maximum liability hereunder is limited to the original purchase price of the Product. No action arising out of any claimed breach of this warranty by Company may be brought by the Original Purchaser more than one year after the cause of action has arisen.

Applicability of Local Laws:

This warranty gives you specific legal rights, and you may also have other rights, permitted by law, which vary from state to state. If this Product is considered a consumer product, please be advised that some local laws do not allow limitations on incidental or consequential damages or how long an implied warranty lasts, so that the above limitations may not fully apply. Refer to your local laws for your specific rights under this warranty.

WARRANTY

Schlage Electric Strikes, System Accessories and Power Supplies

5-Year Limited Warranty – Electric Strikes:

Schlage Lock Company, LLC (the "Company") extends a five-year limited warranty to the original end-user purchaser ("Original Purchaser") of our electric strikes, against defects in materials and workmanship of the mechanical components under normal use and service and, a one-year limited warranty on the electrical components including the solenoid and wiring.

12-18 Month Limited Warranty:

The Company extends a 12-month limited warranty from date of installation on system accessories and power supplies (not to exceed 18 months from the date of shipment from factory), to the original end-user purchaser ("Original Purchaser") of the products manufactured by the Company against defects in material and workmanship under normal use and service.

What The Company Will Do:

Upon return of the defective Product to the Company or its authorized distributor for inspection, free and clear of all liens and encumbrances and accompanied by the statement of defects and proof of purchase, the Company will repair or replace, at its option, the defective Product.

Original User:

These warranties only apply to the Original User of Products. These warranties are not transferable.

What Is Not Covered:

The following costs, expenses and damages are not covered by the provisions of these limited warranties: (i) labor costs including, but not limited to, such costs for the removal and reinstallation of Products; (ii) shipping and freight expenses required to return the Products to the Company; or (iii) any other incidental, consequential, indirect, special and/or punitive damages, whether based on contract, warranty, tort (including, but not limited to strict liability or negligence), patent infringement, or otherwise, even if advised of the possibility of such damages. Some states do not allow the exclusion or limitation of incidental or consequential damages, so the above exclusion or limitation may not apply to you.

The provisions of these limited warranties do not apply to Products: (i) used for purposes for which they are not designed or intended; (ii) which have been subjected to alteration, misuse, abuse, negligence, or accident; (iii) which have been improperly stored, installed, maintained, repaired or operated; (iv) which have been used in violation of written instructions provided by Schlage; (v) which have been subjected to improper temperature, humidity, or other environmental conditions (i.e., corrosion); or (vi) which, based on the Company's examination, do not prove to the Company's satisfaction non-conformance to the warranties.

- (a) THE WARRANTY, OBLIGATIONS AND LIABILITIES OF COMPANY (INCLUDING ITS SUPPLIERS) AND THE RIGHTS AND REMEDIES OF BUYER SET FORTH HEREIN ARE EXCLUSIVE AND ARE IN LIEU OF ALL OTHER WARRANTIES, OBLIGATIONS, REPRESENTATIONS OR LIABILITIES EXPRESS OR IMPLIED ARISING BY LAW, IN CONTRACT, TORT (INCLUDING NEGLIGENCE OR STRICT LIABILITY) OR OTHERWISE, INCLUDING BUT NOT LIMITED TO (I) ANY IMPLIED WARRANTY OF MERCHANTABILITY OR FITNESS FOR A PARTICULAR PURPOSE OR ANY WARRANTY IMPLIED THROUGH COURSE OF PERFORMANCE, COURSE OF DEALING, OR USAGE OF TRADE OR (II) CLAIMS ARISING OUT OF THE NEGLIGENCE OF COMPANY OR COMPANY'S SUPPLIERS OR (III) ANY OTHER CLAIM ARISING OUT OF, CONNECTED WITH, OR RESULTING FROM THE DESIGN, MANUFACTURE, SALE, REPAIR, LEASE OR USE OF THE PRODUCT, ANY COMPONENT THEREOF. **Additional Terms:** The Company does not authorize any person to create for it any obligation or liability in connection with the Products. **The Company's maximum liability under these warranties is limited to the purchase price of the Product that gives rise to the claim.** No action arising out of any claimed breach of these warranties by the Company may be brought by the Original User more than one (1) year after the cause of action has arisen.

CONSUMER PRODUCTS: WITH RESPECT TO "CONSUMER PRODUCTS" AS DEFINED UNDER THE MAGNUSON-MOSS WARRANTY ACT ("MMWA"), THE FOLLOWING STATEMENTS ARE MADE. (A) SOME STATES DO NOT ALLOW LIMITATIONS ON HOW LONG AN IMPLIED WARRANTY LASTS, SO THE ABOVE LIMITATION MAY NOT APPLY TO YOU; (B) IF ANY IMPLIED WARRANTY IS PROVIDED UNDER THE MMWA, IT IS LIMITED TO THE DURATION OF THE WARRANTY PROVIDED ABOVE. (C) SOME STATES DO NOT ALLOW THE EXCLUSION OR LIMITATION OF INCIDENTAL OR CONSEQUENTIAL DAMAGES, SO THE ABOVE LIMITATION OR EXCLUSION MAY NOT APPLY TO YOU; AND (D) THIS WARRANTY GIVES YOU SPECIFIC LEGAL RIGHTS AND YOU MAY ALSO HAVE OTHER RIGHTS WHICH VARY FROM STATE TO STATE.

WARRANTY

Schlage Electronic Locks

12-24 Month Limited Warranty:

Schlage Lock Company, LLC (the "Company") extends a 12 month limited warranty from date of installation, not to exceed 24 months from the date of shipment from factory, for LE, NDE, CO and AD Series locks and reader modules; GWE wireless gateway; and WPR400, WRI400, TK400, CT5000, PIB300, and PIM400 wireless accessories to the original user of the products manufactured by the Company (the "Products") against defects in material and workmanship from the date of purchase.

What The Company Will Do:

Upon return of the defective Product to the Company or its authorized distributor for inspection, free and clear of all liens and encumbrances and accompanied by the statement of defects and proof of purchase, the Company will repair or replace, at its option, the defective Product.

Original User:

These warranties only apply to the Original User of Products. These warranties are not transferable.

What Is Not Covered:

The following costs, expenses and damages are not covered by the provisions of these limited warranties: (i) labor costs including, but not limited to, such costs for the removal and reinstallation of Products; (ii) shipping and freight expenses required to return the Products to the Company; or (iii) any other incidental, consequential, indirect, special and/or punitive damages, whether based on contract, warranty, tort (including, but not limited to strict liability or negligence), patent infringement, or otherwise, even if advised of the possibility of such damages. Some states do not allow the exclusion or limitation of incidental or consequential damages, so the above exclusion or limitation may not apply to you.

The provisions of these limited warranties do not apply to Products: (i) used for purposes for which they are not designed or intended; (ii) which have been subjected to alteration, misuse, abuse, negligence, or accident; (iii) which have been improperly stored, installed, maintained, repaired or operated; (iv) which have been used in violation of written instructions provided by Schlage; (v) which have been subjected to improper temperature, humidity, or other environmental conditions (i.e., corrosion); or (vi) which, based on the Company's examination, do not prove to the Company's satisfaction non-conformance to the warranties.

- (a) THE WARRANTY, OBLIGATIONS AND LIABILITIES OF COMPANY (INCLUDING ITS SUPPLIERS) AND THE RIGHTS AND REMEDIES OF BUYER SET FORTH HEREIN ARE EXCLUSIVE AND ARE IN LIEU OF ALL OTHER WARRANTIES, OBLIGATIONS, REPRESENTATIONS OR LIABILITIES EXPRESS OR IMPLIED ARISING BY LAW, IN CONTRACT, TORT (INCLUDING NEGLIGENCE OR STRICT LIABILITY) OR OTHERWISE, INCLUDING BUT NOT LIMITED TO (I) ANY IMPLIED WARRANTY OF MERCHANTABILITY OR FITNESS FOR A PARTICULAR PURPOSE OR ANY WARRANTY IMPLIED THROUGH COURSE OF PERFORMANCE, COURSE OF DEALING, OR USAGE OF TRADE OR (II) CLAIMS ARISING OUT OF THE NEGLIGENCE OF COMPANY OR COMPANY'S SUPPLIERS OR (III) ANY OTHER CLAIM ARISING OUT OF, CONNECTED WITH, OR RESULTING FROM THE DESIGN, MANUFACTURE, SALE, REPAIR, LEASE OR USE OF THE PRODUCT, ANY COMPONENT THEREOF. **Additional Terms:** The Company does not authorize any person to create for it any obligation or liability in connection with the Products. **The Company's maximum liability under these warranties is limited to the purchase price of the Product that gives rise to the claim.** No action arising out of any claimed breach of these warranties by the Company may be brought by the Original User more than one (1) year after the cause of action has arisen.

CONSUMER PRODUCTS: WITH RESPECT TO "CONSUMER PRODUCTS" AS DEFINED UNDER THE MAGNUSON-MOSS WARRANTY ACT ("MMWA"), THE FOLLOWING STATEMENTS ARE MADE. (A) SOME STATES DO NOT ALLOW LIMITATIONS ON HOW LONG AN IMPLIED WARRANTY LASTS, SO THE ABOVE LIMITATION MAY NOT APPLY TO YOU; (B) IF ANY IMPLIED WARRANTY IS PROVIDED UNDER THE MMWA, IT IS LIMITED TO THE DURATION OF THE WARRANTY PROVIDED ABOVE. (C) SOME STATES DO NOT ALLOW THE EXCLUSION OR LIMITATION OF INCIDENTAL OR CONSEQUENTIAL DAMAGES, SO THE ABOVE LIMITATION OR EXCLUSION MAY NOT APPLY TO YOU; AND (D) THIS WARRANTY GIVES YOU SPECIFIC LEGAL RIGHTS AND YOU MAY ALSO HAVE OTHER RIGHTS WHICH VARY FROM STATE TO STATE.

Terms & Conditions · Schlage Key Systems Sales Policy

Schlage Key Systems Sales Policy

The following specific product terms and conditions are applicable only to the extent provided herein. All other terms and conditions contained in the General Terms and Conditions of Sale and Service provided in this Price Book will govern the sale of products identified in this Price Book.

Definition-

Standard keyways are C, CE, E, EF, F, FG, G, H, J, K, L. All other keyways are considered restricted.

Everest, Everest Primus, Classic Primus and all other restricted keyway products (Quad, Reversed, Numbered) manufactured by the Schlage Lock Company are offered for sale by policies set forth per product type and security levels through specific channels of distribution.

Possession of this price book or any other Schlage price book does not constitute "the right to purchase" these products. Please refer to the sales policy below for terms and condition. The term keyway(s) refer(s) to keyway, key sections or side bit milling.

Standard Classic (Obverse) Key Sections- no restriction

Standard keyways are Classic (Obverse) C, CE, E, EF, F, FG, G, H, J, K, L.

Everest and Everest 29 Open (C and S Key Sections)

Everest and Everest 29 Open (C & S keyways) include non-Primus products with Everest C and Everest 29 S keyways and key sections. Schlage only sells Everest and Everest 29 Open products to commercial security professionals. Commercial security professionals purchasing Everest and Everest 29 Open products from Schlage are permitted to stock and to originate or duplicate keys without signature verification.

Purchasers of Everest and Everest 29 open (C & S) are permitted to resell the products in accordance with their distribution agreement to end users and to other commercial security dealers who have a professional locksmith on staff but are expressly prohibited from selling to:

- i) Any residential retail outlet.
- ii) Any individual or entity purchasing or selling products through any method of auction.

End User Keyways - Primus / Primus XP levels 3, 4 & 9, Everest D, Everest B, Everest 29 T, Everest 29 R, Quad, Reversed, Numbered.

End user restricted keyways are manufactured and sold by Schlage for use within the end user facilities only and are not for dealer or locksmith's use or distribution. The facilities are described as the "ship-to" address pre-authorized by the end user via a letter of authorization (LOA) or face sheet (depending upon the key system type).

End user keyway products may be stocked at the end user location only, unless authorized otherwise in writing by the end user. Every new end user system, using these restricted keyways, requires prior approval from the local RSO sales office management.

Restricted end user keyways may not be sold to any contract hardware dealer or wholesale distributor not open as a direct Schlage account as the time of the sale, unless authorization has been granted in writing by the local RSO sales office management where the end user reside.

Locksmiths/ dealers' keyways - Primus/ Primus XP levels 1, 1+, 2, 7, 8, Everest B234 & B235, Everest 29 R234 & R235.

Locksmith/ dealer key section can be sold to commercial locksmiths/ dealers only.

Right to stock and sell locksmiths/ dealers restricted keyways requires the appropriate written agreement with Schlage and approval by the local RSO sale office management. Please contact your local RSO sale office for a copy of these contracts and additional information.

Schlage hereby reserves the right to terminate or take any other legal action against any party that violates this policy.

Restricted Keyway Policy

Everest B, Everest 29 R

All Everest and Everest 29 SFIC (B and R Families) keyways are restricted.

When ordering a new keying system, include the following:

- Job (end-user) name, city, state and zip code.
- Letter of Authorization (LOA) – Authorized ship-to address for key blanks, cores and cut keys on end-user's official stationery. See **Forms & Examples** for sample letter of authorization.
- Numerically defined specifications for expansion of all branches of the key system.

The factory will assign a "facility code" which will appear on all keys and blanks for this job. When ordering additions to an existing keying system, include the following:

- Job (end-user) name, city, state and zip code.
- Facility code previously assigned by Schlage and stamped on all existing keys and blanks.
- Registry number of the keying system as established by Schlage.
- Letter of authorization on end-user's official stationery is required when:
 - End-user places order with new dealer.
 - Order is to be drop shipped to a different ship-to address than originally authorized by the end-user.
 See **Forms & Examples** for sample letter of authorization.

Bitting list (transcript) orders require a letter of authorization on the end-user's official stationery. Prevailing prices apply.

Everest D, Everest 29 T

All Everest D and Everest 29 T keyways are restricted.

When ordering a new keying system, include the following:

- Job (end-user) name, city, state and zip code.
- Letter of Authorization (LOA) – Authorized ship-to address for all products on end-user's official stationery. See **Forms & Examples** for sample letter of authorization.
- Numerically defined specifications for expansion of all branches of the key system.

The factory will assign a "facility code" which will appear on all keys and blanks for this job. When ordering additions to an existing keying system, include the following:

- Job (end-user) name, city, state and zip code.
- Facility code previously assigned by Schlage and stamped on all existing keys and blanks.
- Registry number of the keying system as established by Schlage.
- Letter of authorization on end-user's official stationery is required when:
 - End-user places order with new dealer.
 - Order is to be drop shipped to a different ship-to address than originally authorized by the end-user.
 See **Forms & Examples** for sample letter of authorization.

Quad, Numbered ("Paracentric") and Reverse Keyway Family Policy

A letter of authorization from the end-user is required for all orders for restricted keyway plugs, 0-bitted and 1-bitted products and all key blanks. Restricted keyway products are not available keyed random. The letter of authorization must include the address in which the materials will be shipped. Keyway or keyway family must be referenced in the letter. Letters must be dated and signed by the end user. Letters dated more than 6 months prior to the order submission date will not be accepted. Letters for projects that are ongoing may be older than six months if effective dates are referenced in the letter. With the exception of the signature, all other information must be typed.

Allowable End User Authorizations for Restricted Keyways:

The end user can authorize a dealer or distributor to order and inventory products if they so choose. This authorization requires the submission of a fully completed "Letter of Authorization" or "Signature Card", depending on the product type requirements, by the end user to Schlage.

Construction Core Program Policy

Full size and small format construction cores will be invoiced under standard payment terms. Credit for these cores, less the handling charge, will be issued upon their return to the factory. Please contact customer service for return authorization. Customers may not deduct payment for construction cores prior to completion of their authorized return.

Control Keys for Interchangeable Cores

A single control key will be added to orders containing interchangeable cores where a new masterkey system, master key system expansions requiring a different control key and all construction core orders are placed and does not include a control key on the purchase order. Construction core orders will include both a control and user key.

Terms & Conditions - Cylinder Policies

Primus® / Primus XP Sales Policy

Primus High Security cylinder products manufactured by the Schlage Lock Company are offered for sale through specific channels of distribution, based on stocking requirements and security levels. Possession of this price book or any other Schlage price book does not constitute “the right to purchase” Primus products.

Important: In stocking levels where purchase agreements are required, a fully executed purchase agreement, including initial minimum inventory order, must be in place before any Primus products may be quoted or purchased. Contact your RSO Consultant for specific details.

The prices contained herein apply to Primus Levels 1 through 9 with respect to the actual product. Availability of product is subject to additional conditions as follows:

Classic Keyways

PRIMUS/PRIMUS XP LEVEL 1: For retail locksmiths and Schlage dealers. Standard nationwide side biting by keyway. Stocking level requires a separate Primus/Primus XP agreement. Initial inventory commitment required for distributors but not for participating locksmiths. Obverse keyways only. HP, JP and LP section keys are not available.

PRIMUS LEVEL 1 PLUS: For retail locksmiths. A side biting is assigned on a nationwide exclusive basis to a specific Schlage wholesale distributor. Stocking level which requires a separate Primus purchase agreement and an initial minimum inventory purchase by the wholesaler and the locksmith. Obverse keyways only. HP, JP and LP section keys are not available. Cylinders are always furnished less key blanks (LKB).

PRIMUS XP LEVEL 1 PLUS: For retail locksmiths. An exclusive side biting is assigned to dealer within the first three digits of the dealer physical location zip-code. Distribution through direct Schlage dealers. Stocking level which requires a separate Primus purchase agreement and an initial minimum inventory purchase. Obverse keyways only. Cylinders can be ordered LKB, KD, KA or MK.

PRIMUS/PRIMUS XP LEVEL 2: For Schlage dealers and large commercial locksmith businesses. Exclusive side biting is assigned to dealer by time zone. Distribution through direct Schlage dealers. Stocking level which requires a separate Primus purchase agreement and an initial minimum inventory purchase. Obverse keyways only.

PRIMUS/PRIMUS XP LEVEL 3: End user level not stocked by dealers. Key systems are assigned a side biting exclusive within 2-digit zip code (Level 3G) for orders of 60 - 1,999 Primus cylinders. Orders of fewer than 60 Primus cylinders are randomly assigned a side biting from a small nationwide pool of side bittings (Level 3U). Distribution through Schlage dealers and Schlage wholesale distributors. Obverse and Quad keyways only.

PRIMUS/PRIMUS XP LEVEL 4: End user level not stocked by dealers. Key systems are assigned a side biting exclusive within a time zone (Level 4Z) for orders of 2,000 - 3,999 Primus cylinders. A nationwide exclusive side biting (Level 4N) is assigned to key systems of 4,000 or more Primus cylinders. This exclusivity can be purchased for a separate fee for smaller quantities of cylinders. This price book does not contain the fee schedule. Contact your RSO Consultant for specific information. Distribution through Schlage dealers and Schlage wholesale distributors. Obverse and Quad keyways only.

PRIMUS LEVEL 7: For retail locksmiths. Side biting is assigned on a nationwide exclusive basis to a specific Schlage wholesale distributor. Stocking level which requires a separate Primus purchase agreement and an initial minimum inventory purchase by the Schlage wholesaler and the locksmith. Same as Level 1 PLUS above, but with Everest S Family keyways only.

Everest® Keyways

PRIMUS XP LEVEL 7: For retail locksmiths. An exclusive side biting is assigned to dealer within the first three digits of the dealer physical location zip-code. Distribution through direct Schlage dealers. Stocking level which requires a separate Primus purchase agreement and an initial minimum inventory purchase. All Everest 29 key sections. Cylinders can be ordered MK, KA, KD or LKB.

PRIMUS/PRIMUS XP LEVEL 8: For Schlage dealers and large commercial locksmith businesses. Exclusive side biting is assigned to dealer by time zone. Distribution through direct Schlage dealers. Stocking level which requires a separate Primus purchase agreement and an initial minimum inventory purchase. Equivalent to Level 2 above, but with Everest S Family keyways only.

PRIMUS/PRIMUS XP LEVEL 9: End user level not stocked by dealers. Key systems are assigned varying degrees of geographically exclusive side bittings based on a sliding scale of purchase commitment or separate fees. This price book does not contain the fee schedule. Contact your RSO Consultant for specific information. Distribution through Schlage dealers and Schlage wholesale distributors. Level 9U, 9G, 9Z, and 9N are equivalent to Levels 3U, 3G, 4Z, and 4N above, but with Everest S and T Family keyways.

The following side bit milling exclusivity criteria apply to both levels 3, 4 & 9:

- 1- 60 cylinders-Random assignment
- 61-1999 cylinders-First two digits of zip-code
- 2000-3999 cylinders-Time-Zone Exclusivity (also available for \$10,000 fee for an organization who would like this exclusivity and doesn't meet cylinders quantity requirement).
- 4000 + cylinders-Nation Wide Exclusivity.(also available for \$40,000 fee for an organization who would like this exclusivity and doesn't meet cylinders quantity requirement).

Important Ordering Information

See Forms & Examples: Primus and Everest 29 Primus Ordering Checklist for a checklist of information required to process a Primus order. Note that, for security reasons, all end user Primus levels (Level 3, 4 and 9) require a Facesheet (MS-EI20) bearing an original signature. Opening orders for end user Primus levels also require a Signature Card (MS-EI30) bearing original signatures. Facesheets and signature cards are used to authenticate the end user request for product, therefore orders received without the correct supporting documents (or without original signatures) are subject to delays or cancellations. Blank Facesheets and Signature Cards are included in the Forms & Examples section of this price book for your reference. Additionally, electronic version of these forms are available at allegion.com/us.

The Schlage Lock Company reserves the right to make changes in designs and specifications, to make additions or improvements on its products, or to discontinue products without incurring any obligation. The Schlage Lock Company is not responsible for any modification, addition, or alteration to our products by others.

Inventory commitment Requirements-Commercial Locksmiths Levels			
Primus XP		Everest 29 Primus XP	
Level 1	None	N/A	N/A
Level 1+	\$7,500	Level 7 XP	\$7,500
Level 2	25,000	Level 8	\$25,000

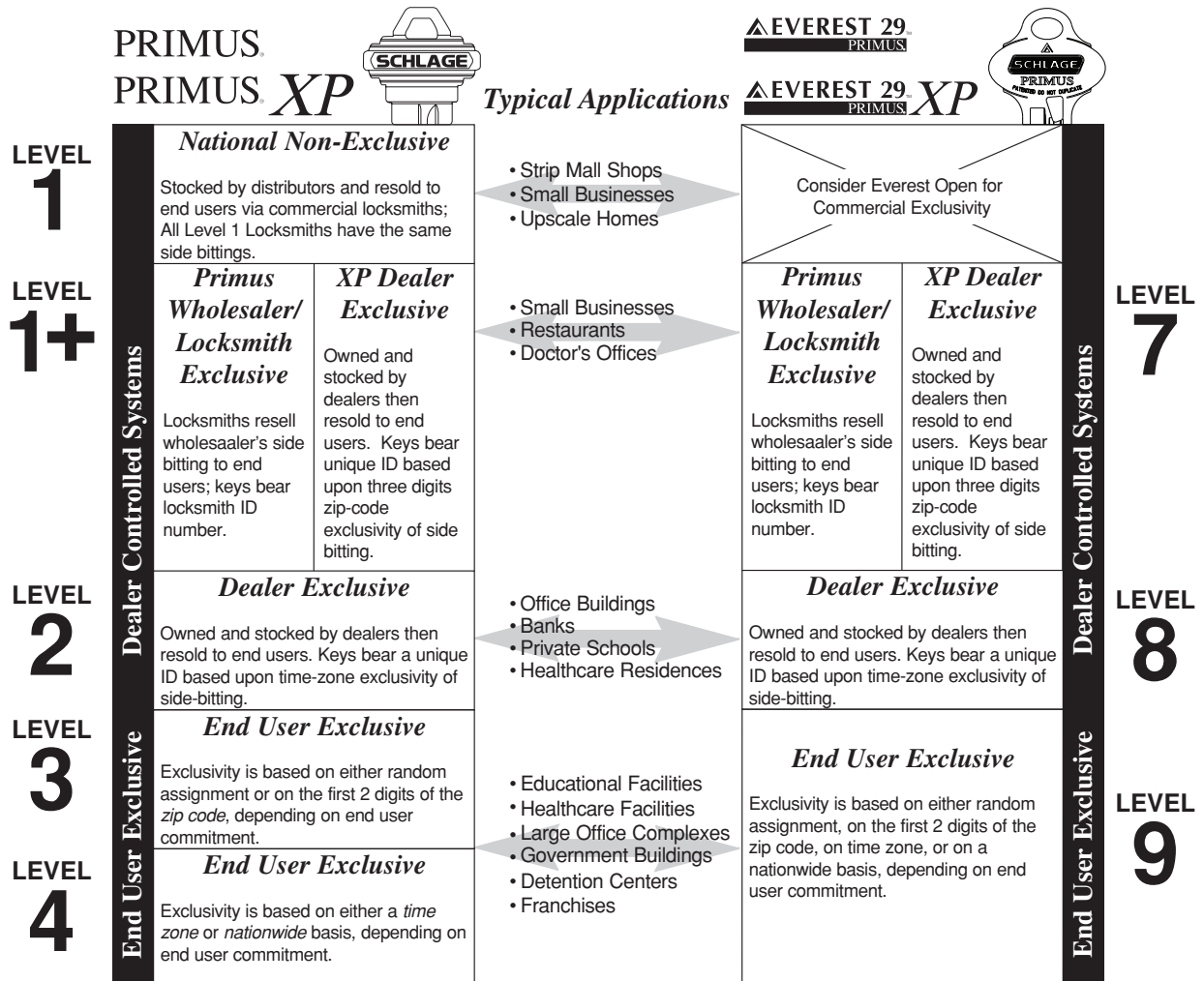

Electronic Validation from Schlage

Electronic Validation (e-validation) is an online system for the use of the end user to create electronic authorizations replacing the letter of authorization (LOA) and Primus Facesheet processes. This online validation system is designed to ease the burden of an end user providing authorizations for ordering restricted key and cylinder products on their behalf. Through this system, the end user can register for an online account with Schlage that will allow them to manage their shipping addresses, shipping contacts and additional authorized users for their restricted products. Through this system, they can then generate an electronic Facesheet that they can provide to the distributor of their choice to allow an order for restricted products to proceed. Enrolling in and using this feature will reduce the overall time for an order to be processed from the time that the end user has determined the need for product. The electronic Facesheet provided by the e-validation system can be faxed or emailed along with a distributors order reducing the time and energy required for original copies of Facesheets previously required. The system is for both new and existing restricted key system owners. For new restricted systems, a registration process will provide the ability to create the initiating Facesheet for the project.

Products/key systems eligible for e-validation:

- Everest** – B and D restricted family of keyways
- Everest 29** – R and T restricted family of keyways
- Primus** – All keyway families that include the Primus feature
- Primus XP** – All keyway families that include the Primus XP feature

E-validation can be accessed at the following web address: [HTTPS://mycredentials.allegion.com](https://mycredentials.allegion.com)

Keyway Family of Master Key System	Standard Method of Shipment
<ul style="list-style-type: none"> • Classic Restricted (Numbered, Quad and Reverse) • Classic Primus (Obverse and Quad) • Everest Restricted (B and D Family) • Everest 29 Restricted (R and T Family) • Everest Primus (C and D Family) • Everest 29 Primus and Primus XP (S and T Family) • Classic Open (Obverse) • Everest Open (C Family) • Everest 29 Open (S Family) 	<p>2-Day Air</p> <ul style="list-style-type: none"> • Tracking number is assigned to shipment • Recipient's signature is required upon delivery

All goods are shipped F.O.B. factory and become the customer's property when they pass into the hands of the transportation company. Schlage reserves the right to use our choice of carrier.

Schlage Default Keyways

<p>Schlage Commercial products (excluding Portable Security) Default keyway is Everest 29 S123 For other optional keyways, please specify</p>
<p>Schlage Electronics Default keyway is Everest 29 S123 For other optional keyways, please specify</p>
<p>Portable Security - Kryptonite: default to C keyway KD For made to order products, please specify the keying and keyway</p>
<p>Schlage Residential: (F, B60, Dexter) Default keyway is C</p>

Distribution Function and Location Policy

The Schlage customer relationship includes the nonexclusive area of primary sales responsibility and the channel of distribution assigned by Schlage. It is vital to our success and for the effective management of the distribution of our products that the Schlage customer relationship, once it is satisfactorily established between us, should not be changed without our approval. Therefore, after selection by Schlage as a distributor of one or more of Schlage products, a customer should continue to perform that distribution function from the location of its business at the place or places utilized at the time of selection. A customer should not change its Schlage distribution function or establish a different or additional location without the prior written consent of Schlage.

Schlage reserves the right to discontinue, after appropriate notice, sale of its products to any customer which refuses to adhere to this policy. Schlage also reserves the right to change, in its sole discretion, the number and locations of the distributors authorized to distribute its products in any area. This determination will be based upon, among other considerations, the success or failure in developing the market for Schlage products.

Hardware Finishes

Schlage Lock finishes are durable, top quality finishes obtained by the careful processing of solid brass, bronze, stainless steel or other materials. Where required, a protective clear coating is applied and cured under high temperature. It is important that climatic conditions and usage be taken under consideration when selecting finishes. This is especially true in areas subjected to strong corrosive vapors, humid climate or sea air which, in a short time, may have a damaging effect on metal finishes. The longevity and preservation of the finish appearance is determined by base metal and finishing process. Clear protective coating or other organic finishing applications may require different methods of cleaning and care. As an example, non-clear coated finishes should not be cleaned with soaps or any solvents; organically coated surfaces should periodically be cleaned with a mild, nonabrasive soap and buffed lightly with a clean cloth. The type of base metal and finishing techniques must be considered when applying any cleaning or preservative method. Contact the Schlage Technical Services Department for further information on the care of finished hardware.

In some instances, for customer convenience, the most appropriate BHMA finish symbols are used to indicate similarity of appearance, regardless of base metal of finishing process. A, AL, CS, D, ND, F, FA, H, S, S200-Series and Dexter by Schlage levers are zinc-based material and are plated to match finishes indicated. L-Series will utilize a brass material for 612 and 613 finishes. Finishes of latches, strikes, cylinders/cores, and visible mounting screws, though similar in appearance, may differ from the finish of the trim. Finish numbers in the 600-Series are the BHMA (Builders Hardware Manufacturers Association) industry standard.

Commercial Finish Codes and Descriptions:

The nearest old U.S. equivalent code designations are shown in parenthesis ().

Symbol	Description	Symbol	Description
605 (3)	BRIGHT BRASS, Clear Coated	622 (19)	MATTE BLACK, Coated
606 (4)	SATIN BRASS, Clear Coated	625 (26)	BRIGHT CHROMIUM PLATED, No Coating
609 (5)	ANTIQUÉ BRASS, Satin Brass, Blackened, Satin Relieved, Clear Coated	626 (26D)	SATIN CHROMIUM PLATED, No Coating
612 (10)	SATIN BRONZE, Clear Coated	629 (32)	BRIGHT STAINLESS STEEL, No Coating
613* (10B)	OIL RUBBED BRONZE, Oxidized Satin Bronze, Oil Rubbed, No Coating	630 (32D)	SATIN STAINLESS STEEL, No Coating
619 (15)	SATIN NICKEL, Satin Nickel Plated, Clear Coated	643e	AGED BRONZE, Clear Coated

**Oil rubbed bronze (613) is considered a category "B" finish by ANSI/BHMA and will vary in color when applied to different alloys and forms of base material. 613 will also vary from production lot and additionally from one manufacturer to another. Oil rubbed bronze will wear off over time due to the "rubbed" finishing method that has no protective coating or plating.*

Notes

For more than 100 years Allegion brands have been providing innovative access control solutions. We are at the forefront of access control innovation, including contactless smart credentials, wireless security products and biometrics.

Allegion electronic security offers the most extensive range of access control and security management solution on the market today. This comprehensive line of products allow you to build a complete access control system from the ground up. For facilities with existing access control systems, the open architecture design of Allegion electronic security products facilitates easy integration into your existing system. Because Allegion understands that your needs will evolve over time, Allegion also provides the opportunity for an easy migration path as technology advances.

At Allegion, we understand that each facility has unique security requirements. Our extensive line of products, flexible options and ability to adapt to your existing environment make it easy to find a solution that will fit your security needs...whatever they may be.

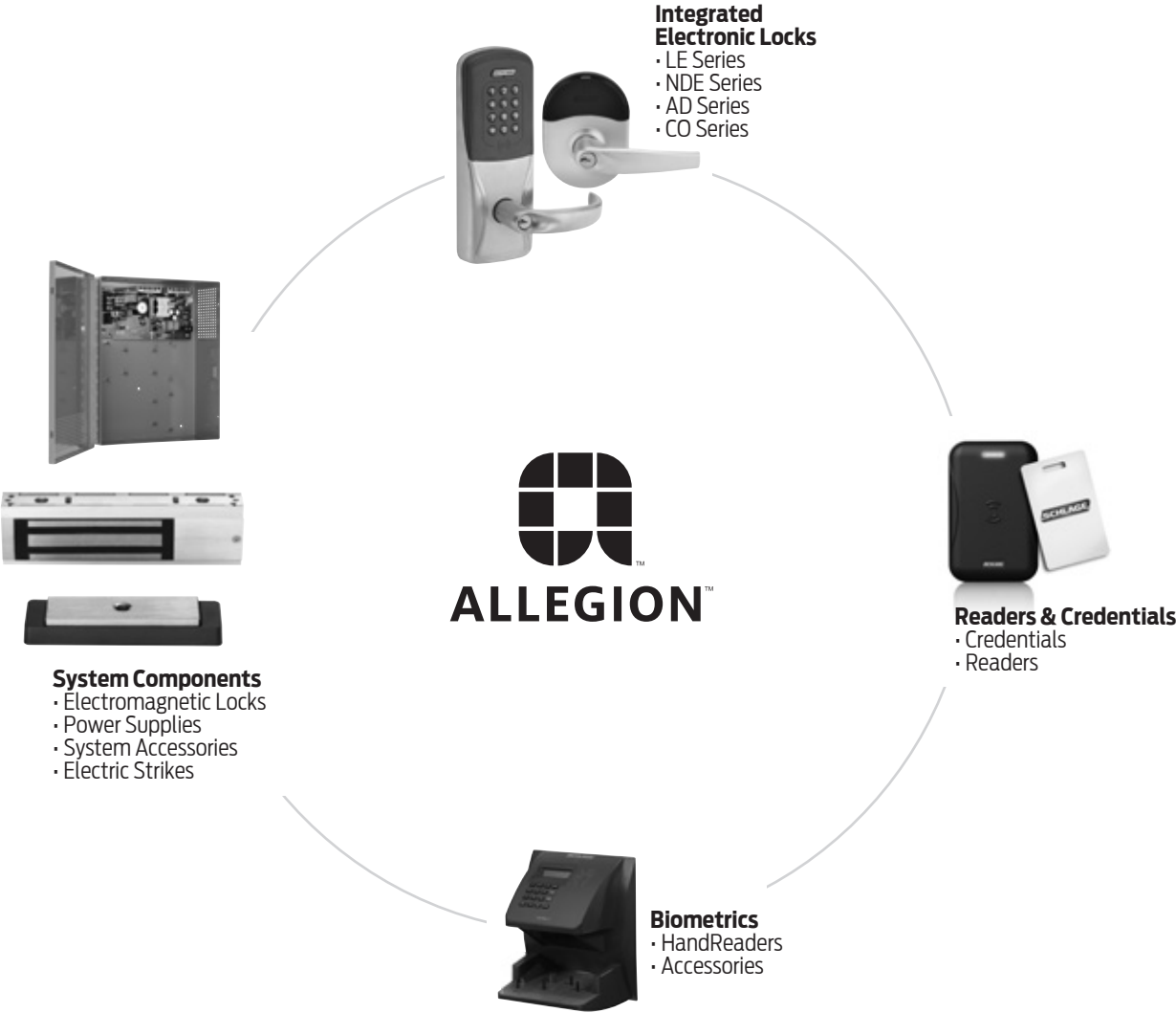

Allegion Solutions Overview

Allegion offers comprehensive security solutions for each facility. To help you identify which solution is right for your facility, here are some reader technologies with their compatible credential technologies. Allegion readers and credentials are designed on an open architecture platform. For more details on compatibility, please refer to the data sheets.

		Credential Compatibility						
		PIN	Magnetic Stripe (1,2,3 Track)	Proximity Card (125 kHz)	Smart Card (13.56 MHz)	iButton	Biometric (Hand Geometry)	FIPS 201-2 Compliant
LE/NDE Series Readers	Multi-Technology Reader			X	X			
AD Series Readers	AD Series Keypad Reader (KP)	X						
	AD Series Magnetic Stripe + Keypad Reader (MGK (Insert) or MSK (Swipe))	X	X					
	AD Series Magnetic Stripe Reader (MG (Insert) or MS (Swipe))		X					
	AD Series Multi-Technology + Keypad Reader (MTK)	X		X	X			
	AD Series Multi-Technology Reader (MT)			X	X			
	AD Series Multi-Technology FIPS 201-2 Compliant Reader (FMK)	X		X	X			X
CO Series Readers	CO Series Keypad Reader (KP)	X						
	CO Series Magnetic Stripe (Swipe) + Keypad Reader (MSK)	X	X					
	CO Series Magnetic Stripe (Swipe) Reader (MS)		X					
	CO Series Proximity + Keypad Reader (PRK)	X		X				
	CO Series Proximity Reader (PR)			X				
Networked Readers	PR10 Proximity Reader - Mini Mullion			X				
	SM10 Contactless Smart Reader - Mini Mullion				X			X
	MT11 Multi-Technology Reader - Mullion			X	X			X
	MT15 Multi-Technology Reader - Wall Mount			X	X			X
	MTK15 Multi-Technology Reader with Keypad - Wall Mount	X		X	X			X
	MTMS15 Multi-Technology Magnetic Stripe Reader - Wall Mount		X	X	X			X
	MTMSK15 Multi-Technology Magnetic Stripe Reader with Keypad - Wall Mount	X	X	X	X			X
	SMR5 Magnetic Stripe Card Reader		X					
	SMR10 Magnetic Stripe Card Reader		X					
	SMR20 Magnetic Stripe Card Reader + Keypad	X	X					
	SRT-100 iButton Mullion Mount Reader					X		
	SERIII-W Scramble Keypad	X						
	SERII-WB Scramble Keypad	X						
	SEKPDMWG Electronic Keypad - Mullion Mount	X						
	SEKPDWG Electronic Keypad	X						
	SEKPD8B Electronic Keypad	X						
Biometrics	HandKey-2 (F Series)	X	X	X	X		X	

CREREDENTIALS - TABLE OF CONTENTS	
CREREDENTIALS OVERVIEW	24
CREREDENTIAL OPTIONS	24
HOW TO ORDER	25
SCHLAGE SMART CREREDENTIALS	26
Schlage Smart Credentials using MIFARE® DESFire® EV2 Technology	26
Multi-Technology: Proximity and Schlage Smart Credentials using MIFARE® DESFire® EV2	26
Schlage Smart Credentials using MIFARE® DESFire® EV1	27
Multi-Technology: Proximity and Schlage Smart Credentials using MIFARE DESFire EV1	27
Schlage Smart Credentials using MIFARE Plus®	28
Multi-Technology: Proximity and Schlage Smart Credentials using MIFARE Plus	28
Schlage Smart Credentials using MIFARE Plus®	29
Multi-Technology: Proximity and Schlage Smart Credentials using MIFARE Plus	29
Schlage Smart Credentials using MIFARE Classic®	29
Multi-Technology: Proximity and Schlage Smart Credentials using MIFARE Classic	29
Schlage Smart Wristband using MIFARE Classic	29
SCHLAGE MOBILE CREREDENTIALS	29
SCHLAGE PROXIMITY CREREDENTIALS	30
SCHLAGE CREREDENTIALS - OTHER	31
PRX Offering - discontinued effective May 6, 2019)	31
Magnetic Stripe Credentials	31
iButton Credentials	31
SLOT PUNCH OPTIONS	32

877-671-7011	
Customer Service:	Technical Support:
Order Status, Credit Returns of Non-Defective Products, General Sales Questions	Technical Questions/Issues, Returns of Defective Products, Repairs
Email Requests to: Sales Support contact information on Page 2.	Contact For Technical Assistance: Readers_Credentials_Biometrics_TechProdSupport@allegion.com
Inside Sales 855-248-0302	
General Sales Questions, Pre-printed cards, CardTrax Accounts ElectronicInsideSales@allegion.com	

For Credentials Warranty Information please see page 11.

Pricing/product description subject to change without notice.

With the latest in smart card technology and traditional proximity technology, we have an option for every budget and business need.

Smart Credentials

Ideal for facilities with moderate to high security needs, Schlage smart credentials put you in control by delivering smarter solutions. Through the use of MIFARE Classic®, MIFARE Plus® or MIFARE® DESFire® EV1 technology, these credentials protect your most sensitive data by utilizing extra layers of security protection. Smart credentials can be used for many applications beyond access control including transit, cashless vending, and cafeteria point of sale.

Proximity Credentials

Schlage proximity credentials are an excellent solution for facilities with less demanding security needs. Utilizing 125 kHz proximity technology, these credentials are a cost effective solution and are able to interface with many industry leading proximity readers.

Multi-Technology Credentials

Schlage multi-technology credentials are extremely flexible. Particularly useful during a transition from proximity technology to smart technology, these cards can be read by both proximity readers and smart readers. This allows your customers to economically migrate to the latest smart technology at their own pace.

Schlage Mobile™ Credentials

Schlage offers a new way of delivering mobile credentials to your students' and employees' phones. Through the use of near field communication (NFC), a smartphone app works just like an ID card, providing more for your students and employees while enhancing the security of their credential. Easily assign credentials today using the access control software of one of our developer network partners or use our web-based portal. Schlage mobile credentials offer a much higher level of security, based on encrypted smart card technology, featuring a 128 bit AES encrypted credential and utilizing patent-pending anti-playback technology.

Custom Artwork

How Does it Work?

- 1) Contact Inside Sales at 855-248-0302 or customartwork@allegion.com to get started. Art requirements will be provided to start the process.
- 2) Once your team has reviewed the requirements and designed its artwork, submit your order request and artwork to customartwork@allegion.com. Include reference to CMYK in the art template. The artwork should be submitted as an AI, EPS or PDF file.
- 3) The order request information should include the quantity, base card technology and any special requirements (external marking, magstripe programming, etc). The initial order must be for 1,000 cards or more after that a recurring minimum quantity of 500 cards per order.
- 4) A quote and proof will be created and emailed for your review and approval. Upon customer approval, a custom artwork number to be included on your PO will be assigned (CA-xxxx).
- 5) This CA number will be valid for one year. If no additional orders are placed within 12 months, there will be a minimum artwork charge of \$450 for the second year for standard printing.
- 6) Next, simply submit your PO with the assigned custom artwork number and our team will begin producing your cards.
- 7) There is a 6 week and 2-day lead time on all orders from when the PO (not the order request) gets submitted.

Notes: Available for all ISO and clamshell cards

Design must fit within space allotted

Contact Inside Sales at 855-248-0302 or customartwork@allegion.com with any questions throughout the process.

CardTrax

How Does it Work?

- 1) Contact Inside Sales at 855-248-0302 or ElectronicInsideSales@allegion.com to enroll in CardTrax

Notes: The CardTrax program is available to an end-user facility, integrator or other business partner and is available for new and existing customers.*

Minimum annual order quantity: 2000 cards/year or 10 orders per year

No upcharge for CardTrax

**35C and 40X are for CardTrax Restricted members only and reserved for end users only*

Laser Engraving

How Does it Work?

- 1) Contact Inside Sales at 855-248-0302 or ElectronicInsideSales@allegion.com for more information. Laser Engraving is available for all ISO and Clamshell cards.

Note: If there is a specific card combination that you do not see listed in the price book, please contact your sales representative for information on special orders.

Specify Programming Information^{1,2}

Part Number	Bit Format	Facility Code	Start Number		Quantity	CardTrax™ Number	Special Instructions
			Internal	External			
Please submit orders to Readers.Credentials.Orders@allegion.com with purchase order.							

Important Notes:

- 1) It is highly recommended that programming be specified on all credential orders. If programming is not specified a generic default programming will be provided. The default programming is a 26A bit format and a randomly generated facility code and badge ID range.
- 2) When ordering combo credentials, programming for both the smart and proximity technology must be specified. The same programming will automatically be used for both technologies if two different lines of programming are not specified.

Programming Information	Part number – Refer to pages 26-31
	Bit Format – Example 26 bit; See bit format chart below. If you have questions, contact your sales representative.
	Facility code – See bit format chart below. If you have questions, contact your sales representative
	Start Number – Specify the internal and external start numbers. By default, the internal number matches the external number; please specify if this is not your desired option.
	No Programming – If you would like your smart cards blank, please make sure you include NP in special instructions. Prox cards cannot be ordered unprogrammed. If you are using a legacy Allegion programmer and need initialized-only cards, please include "88i-initialized" in special instructions.
	Slot Punch – Punch mark guides are on all ISO cards. Please specify slot punch orientation if desired (vertical or horizontal). There is a per card cost for factory slot punching of ISO cards. Clamshells are punched on the landscape profile at no charge.
	Custom Artwork – Please note any custom artwork requests, and contact Inside Sales at 855-248-0302 for further instruction.
	CardTrax™ – CardTrax format is a program designed to keep track of card ID numbers to eliminate confusion in ordering sequential numbering and/or programming details, and ensures duplicate cards are not issued. Cards will automatically be provided as "next in line" unless otherwise specified.
CardTrax™ Restricted – An exclusive CardTrax program for qualified end-user customers that provides global programming protection.	

Available Bit Formats:

Bit formats	Facility Code Range	Number Range	Prox	Smart
26A (125 kHz Standard)	0-255	0-65,535	Y	Y
26A PSK Format* Specify Config ID 00030000	0 - 255	0 - 65,535	Y	N
32X	N/A	0-1,073,741,823	Y	Y
34N	0-255	0-65,535	Y	Y
34S	0-4,095	0-1,048,575	Y	Y
35C **	0-4,095	0-1,048,575	Y	Y
36X	0-4,095	0-2,097,151	Y	Y
37H	Not Applicable	0-34,359,738,367	Y	Y
37X	0-65,535	0-524,288	Y	Y
40X ** (13.56 MHz Standard)	0-1,023	0-268,435,455	N	Y
48X	0 - 1,048,575	0-1,048,575	N	Y

*Compatible with HID's 26-A bit Indala brand proximity readers

** For CardTrax™ Restricted program members only

Available Form Factors:

	Clamshell	ISO – Glossy White	Keyfob	Thin Keyfob	Wristband	PVC Adhesive Disk PVC Adhesive Patch
Dimensions (HWT in inches)	3.37x2.125 x0.075	3.37x2.125x0.033	2x1.24x0.038	1.77x1.18x0.06	0.63x7.68x0.295	35mm 3.37x2.125x0.033

Schlage Mobile Credentials Ordering Instructions

The ordering process and channels through which mobile credentials are ordered is identical to physical cards. Be sure to include the customer name on the PO. Credential programming information is not needed on the PO.

Allegion, the Allegion logo, Schlage and the Schlage logo, are trademarks of Allegion plc, its subsidiaries and/or affiliates in the United States and other countries. All other trademarks are the property of their respective owners.

HID and Indala are both ® registered.

Pricing/product description subject to change without notice.

Smart Credentials



Schlage Smart Credentials using MIFARE® DESFire® EV2 Technology

Officially available May 2019

- 13.56 MHz smart technology
- Uses MIFARE DESFire EV2 Technology
- Meets ISO standard 14443A

(Minimum order is 100)

2420	Schlage MIFARE DESfire EV2 2K byte/16K bit Clamshell Card	\$7.80
2440	Schlage MIFARE DESfire EV2 4K byte/32K bit Clamshell Card	\$8.80
2480	Schlage MIFARE DESfire EV2 8K byte/64K bit Clamshell Card	\$10.70
2520	Schlage MIFARE DESfire EV2 2K byte/16k bit ISO Glossy White	\$8.40
2540	Schlage MIFARE DESfire EV2 4K byte/32k bit ISO Glossy White	\$9.50
2580	Schlage MIFARE DESfire EV2 8K byte/64k bit ISO Glossy White	\$11.40
2520M1	Schlage MIFARE DESfire EV2 2K byte/16k bit with Magnetic Stripe ISO Glossy White	\$9.20
2540M1	Schlage MIFARE DESfire EV2 4K byte/32k bit with Magnetic Stripe ISO Glossy White	\$10.20
2580M1	Schlage MIFARE DESfire EV2 8K byte/64k bit with Magnetic Stripe ISO Glossy White	\$12.20
2620T	Schlage MIFARE DESfire EV2 2K Thin Fob (minimum order of 50)	\$8.80

Multi-Technology: Proximity and Schlage Smart Credentials using MIFARE® DESFire® EV2

(Minimum order is 100)

2692T	Schlage MIFARE MIFARE DESfire EV2 2K + HID COMPATIBLE PROX THIN FOB (minimum order of 50)	\$13.30
2920	Proximity and Schlage MIFARE DESfire EV2 2K byte/16k bit ISO Glossy White	\$12.40
2940	Proximity and Schlage MIFARE DESfire EV2 4K byte/32k bit ISO Glossy White	\$13.50
2980	Proximity and Schlage MIFARE DESfire EV2 8K byte/64k bit ISO Glossy White	\$15.60
2920M1	Proximity and Schlage MIFARE DESfire EV2 2K byte/16k bit with Magnetic Stripe ISO Glossy White	\$12.90
2940M1	Proximity and Schlage MIFARE DESfire EV2 4K byte/32k bit with Magnetic Stripe ISO Glossy White	\$13.90
2980M1	Proximity and Schlage MIFARE DESfire EV2 8K byte/64k bit with Magnetic Stripe ISO Glossy White	\$16.00

Please note lead times for DESFire EV2 is 6 - 8 weeks

Schlage Smart Credentials using MIFARE® DESFire® EV1 Technology

- 13.56 MHz smart technology
- Uses MIFARE DESFire EV1 Technology
- Meets ISO standard 14443A

(Minimum order is 100)

8420	Schlage MIFARE DESFire EV1 Smart Card 2K byte/16k bit Clamshell	\$7.80
8440*	Schlage MIFARE DESFire EV1 Smart Card 4K byte/32k bit Clamshell	\$8.80
8480*	Schlage MIFARE DESFire EV1 Smart Card 8K byte/64k bit Clamshell	\$10.70
8520	Schlage MIFARE DESFire EV1 Smart Card 2K byte/16k bit ISO Glossy White	\$8.40
8540	Schlage MIFARE DESFire EV1 Smart Card 4K byte/32k bit ISO Glossy White	\$9.50
8580	Schlage MIFARE DESFire EV1 Smart Card 8K byte/64k bit ISO Glossy White	\$11.40
8520M1	Schlage MIFARE DESFire EV1 Smart Card 2K byte/16k bit with Magnetic Stripe ISO Glossy White	\$9.20
8540M1	Schlage MIFARE DESFire EV1 Smart Card 4K byte/32k bit with Magnetic Stripe ISO Glossy White	\$10.20
8580M1*	Schlage MIFARE DESFire EV1 Smart Card 8K byte/64k bit with Magnetic Stripe ISO Glossy White	\$12.20
8620	Schlage MIFARE DESFire EV1 Smart 2K byte/16K bit Keyfob (minimum order of 50)	\$8.80
8640**	Schlage MIFARE DESFire EV1 Smart 4K byte/32k bit Keyfob (minimum order of 50)	\$9.80
8680**	Schlage MIFARE DESFire EV1 Smart 8K byte/64K bit Keyfob (minimum order of 50)	\$11.50
8720*	Schlage MIFARE DESFire EV1 Smart 2K byte/16k bit PVC Adhesive Patch	\$7.70
8740*	Schlage MIFARE DESFire EV1 Smart 4K byte/32k bit PVC Adhesive Patch	\$8.70
8780*	Schlage MIFARE DESFire EV1 Smart 8K byte/64k bit PVC Adhesive Patch	\$10.50

Multi-Technology: Proximity and Schlage Smart Cards using MIFARE® DESFire® EV1
(Minimum order is 100)

8920*	Proximity and Schlage Smart Card Combo 2K byte/16k bit ISO Glossy White	\$12.40
8940*	Proximity and Schlage Smart Card Combo 4K byte/32k bit ISO Glossy White	\$13.50
8980*	Proximity and Schlage Smart Card Combo 8K byte/64k bit ISO Glossy White	\$15.60
8920M1*	Proximity and Schlage Smart Card Combo 2K byte/16k bit with Magnetic Stripe ISO Glossy White	\$12.90
8940M1*	Proximity and Schlage Smart Card Combo 4K byte/32k bit with Magnetic Stripe ISO Glossy White	\$13.90
8980M1*	Proximity and Schlage Smart Card Combo 8K byte/64k bit with Magnetic Stripe ISO Glossy White	\$16.00

** Lead Time: 4-6 weeks*
*** Lead Time: 6-8 weeks*

Smart Credentials



Schlage Smart Credentials using MIFARE Plus® Technology

- 13.56 MHz smart technology
- Uses MIFARE Plus Technology
- Meets ISO standard 14443A

(Minimum order is 100)

5451	Schlage MIFARE Plus SE Smart Card 1K byte/8k bit Clamshell	\$7.50
5551	Schlage MIFARE Plus SE Smart Card 1K byte/8k bit ISO Glossy White	\$7.70
5551M1	Schlage MIFARE Plus SE Smart Card 1K byte/8k bit with Magnetic Stripe ISO Glossy White	\$8.30
5540	Schlage MIFARE Plus S Smart Card 4K byte/32k bit ISO Glossy White	\$11.00
5540M1	Schlage MIFARE Plus S Smart Card 4K byte/32k bit with Magnetic Stripe ISO Glossy White	\$11.60
5951	Proximity and Schlage MIFARE Plus SE Smart Card Combo 1K byte/8k bit ISO Glossy White	\$11.10
5951M1	Proximity and Schlage MIFARE Plus SE Smart Card Combo 1K byte/8k bit with Magnetic stripe ISO Glossy White	\$11.70
5940	Proximity and Schlage MIFARE Plus S Smart Card Combo 4K byte/32k bit ISO Glossy White	\$12.60
5940M1	Proximity and Schlage MIFARE Plus S Smart Card Combo 4K byte/32k bit with Magnetic Stripe ISO Glossy White	\$13.30
5652T	Schlage MIFARE Plus EV1 2K byte/16k bit Thin Keyfob	\$8.00
5692T	Proximity and Schlage MIFARE Plus EV1 2K byte/16k bit Thin	\$11.60
5751	Schlage MIFARE Plus SE Smart 1K byte/8k bit PVC Adhesive Patch	\$7.40

Pricing/product description subject to change without notice.

Schlage Smart Credentials using MIFARE Classic®

- 13.56 MHz smart technology
- Uses MIFARE Technology
- Meets ISO standard 14443A

(Minimum order is 100)

9420	Schlage MIFARE Classic Smart Card 2.5k bit Clamshell	\$4.70
9451	Schlage MIFARE Classic Smart Card 1K byte/8k bit Clamshell	\$7.20
9520	Schlage MIFARE Classic Smart Card 2.5k bit ISO Glossy White	\$5.80
9551	Schlage MIFARE Classic Smart Card 1K byte/8k bit ISO Glossy White	\$7.10
9558	Schlage MIFARE Classic Smart Card 4K byte/32k bit ISO Glossy White	\$10.00
9520M1	Schlage MIFARE Classic Smart Card 2.5k bit with Magnetic Stripe ISO Glossy White	\$6.50
9551M1	Schlage MIFARE Classic Smart Card 1K byte/8k bit and Magnetic Stripe ISO Glossy White	\$7.80
9558M1	Schlage MIFARE Classic Smart Card 4K byte/32k bit and Magnetic Stripe ISO Glossy White	\$10.70
9651	Schlage MIFARE Classic Smart 1K byte/8k bit Keyfob (minimum order is 50)	\$8.10
9651T	Schlage MIFARE Classic Smart 1K byte/8k bit Thin Keyfob (minimum order is 50)	\$8.30
9751*	Schlage MIFARE Classic Smart 1K byte/8k bit PVC Adhesive Patch	\$7.30
9758*	Schlage MIFARE Classic Smart 4K byte/32k bit PVC Adhesive Patch	\$11.00

Multi-Technology: Proximity and Schlage Smart Credentials using MIFARE Classic®
(Minimum order is 100)

9691T	Proximity and Schlage Smart Combo 1K byte/8k bit Thin Keyfob (minimum order is 50)	\$10.90
9951*	Proximity and Schlage Smart Card Combo 1K byte/8k bit ISO Glossy White	\$9.80
9958*	Proximity and Schlage Smart Card Combo 4K byte/32k bit ISO Glossy White	\$11.60
9951M1*	Proximity and Schlage Smart Card Combo 1K byte/8k bit with Magnetic Stripe ISO Glossy White	\$10.10
9958M1*	Proximity and Schlage Smart Card Combo 4K byte/32k bit with Magnetic Stripe ISO Glossy White	\$12.10

** Lead Time: 4-6 weeks*
iButton Keyfobs using MIFARE Classic® Technology
(Minimum order is 50)

IBF-151	Combo Keyfob, 13.56 MHz MIFARE Classic (1K byte/8k bit) and iButton (minimum order is 50)	\$17.90
IBWB-151	Combo Keyfob, 13.56 MHz MIFARE Classic (1K byte/8k bit) without iButton (minimum order is 50)	\$10.30

Schlage Wristbands Using MIFARE Classic® Technology
(Minimum order is 100)

9351-XXX	Schlage MIFARE Classic 1K byte/8k bit Silicone Wristband (minimum order is 100) Available in eleven colors	\$10.50
	BLK = Black BLU = Blue PNK = Pink PLE = Purple CYN = Light Blue ONG = Orange GRN = Green YEL = Yellow RED = Red LME = Lime WHI = White	

Schlage Mobile Credentials

- Uses 13.56 MHz smart technology via near field communication (NFC)
- For a list of compatible phones, visit aptiQmobile.com
- For a list of available bit formats, contact your sales representative.
- Standardized discount structure to align with electronic credentials

(Minimum order is 25)

9100*	Schlage Mobile Credential	\$9.90
--------------	---------------------------	---------------

Pricing/product description subject to change without notice.

Proximity Credentials



Schlage Proximity Credentials

- 125 kHz proximity technology
- Compatible with most HID Proximity formats up to 37 bits
- Compatible with most HID readers

(Minimum order is 100)

7410	Proximity Card Clamshell	\$3.50
7510	Proximity Card ISO Glossy White	\$5.90
7510M1	Proximity and Magnetic Stripe Card ISO Glossy White	\$6.60
7610	Proximity Keyfob (minimum order is 50)	\$6.10
7610T	Proximity Thin Keyfob (minimum order is 50)	\$6.50
7010	Proximity PVC Adhesive Disk (35 mm Disk) (minimum order is 50)	\$5.60
IBF-110	Combo Keyfob, 125 kHz Proximity and iButton (minimum order is 50)	\$14.60
IBF-120	Combo Key FOB, 125kHz Proximity and iButton, user Blue (minimum order is 50)	\$20.30
IBWB-110	Combo Keyfob, 125 kHz Proximity without iButton (minimum order 50)	\$7.30

Proximity Credentials Comparison Guide

Schlage Product Number	HID Product Number
125 kHz Proximity Cards	
7410	1326
7510M1	1336/1536
7610	1346
7510	1386/1586
7010	1391

Please Note:

This chart offers comparable part numbers, these are not direct replacements. Please use this chart as a guide and reference the spec sheet for the part specified to determine compatibility.

Allegion, the Allegion logo, and XceedID are trademarks of Allegion plc, its subsidiaries and/or affiliates in the United States and other countries. All other trademarks are the property of their respective owners.

HID and Indala are both ® registered.

Pricing/product description subject to change without notice.

PRX Offering has been discontinued effective May 6, 2019
Credential Transition Guide

PRX #	Schlage Product #	Description
PRX1	7410	Proximity Card - .075" thick Clamshell
PRX3	7510	Proximity Card - Credit card size and .033" thick ISO Glossy White
PRX4	7510M1	Proximity Card - Dual Technologies - Magnetic Stripe and Prox .033" thick
PRX5	7710	Proximity PVC Adhesive Disk, .042" thick
PFI	7610	Proximity Keyfob

See Schlage Proximity Credentials page for pricing

Reference CardTrax Account: CTP01462, (37 bit, Facility Code 1462) to receive the same programming information as the old PRX#

Magnetic Stripe Credentials

MAG1	Magnetic Stripe Card - not encoded, no logo. (minimum order is 100)	\$2.80
MAG2	Magnetic Stripe Card - Encoded (track 2 and track 3) with Schlage Logo. (minimum order is 100)	\$3.70
MAG3	Magnetic Stripe Card - Encoded, no printing. Must have an enrollment reader to use this credential. (minimum order is 100)	\$3.70

iButton Credentials

IBA	iButton (Adhesive Back)	\$8.10
IBF	iButton on Fob - Black	\$12.50
IBF-100	100 pack - iButton on keyfob - black	\$1,023.00

Pricing/product description subject to change without notice.

Slot Punch Options

Slot Punch Options

SPV	Vertical Slot Punch for ISO Cards (not available for magnetic stripe cards) MUST BE ORDERED WITH CARDS.	\$0.46 per card
SPH	Horizontal Slot Punch for ISO Cards, including those with Magnetic Stripe MUST BE ORDERED WITH CARDS.	\$0.46 per card

NETWORKED READERS - TABLE OF CONTENTS	
READERS OVERVIEW	34
HOW TO ORDER	35
READERS	
Multi-Technology Readers	36
Multi-Technology Magnetic Strip Readers	36
Smart Card Readers	36
Proximity Readers	36
READER PARTS	
Reader Replacement Parts	37
Reader Covers	37
ENROLLMENT READERS	38
READER AND KEYPADS - OTHER	
Magnetic Strip Readers	39
Enrollment Readers for Schlage Express	39
iButton Readers	39
Screamble Keypads	40
Electronic Keypads	40
Offline Keypads	40

CONTACT INFORMATION FOR SCHLAGE READERS AND CREDENTIALS

Email Order To: Readers.Credentials.Orders@allegion.com
 Fax Order To: 866-954-1779
 Payment Address: XceedID Corporation
 15934 Collections Center Drive
 Chicago, IL 60693

877-671-7011	
Customer Service:	Technical Support:
Order Status, Credit Returns of Non-Defective Products, General Sales Questions	Technical Questions/Issues, Returns of Defective Products, Repairs
Email Requests to: Sales Support contact information on Page 2.	Contact For Technical Assistance: Readers_Credentials_Biometrics_TechProdSupport@allegion.com
Inside Sales 855-248-0302	
General Sales Questions, Pre-printed cards, CardTrax Accounts ElectronicInsideSales@allegion.com	

For Credentials Warranty Information please see page 11.

Pricing/product description subject to change without notice.

With our versatile multi-technology, smart and proximity reader options, we have a solution for any physical access control need. Our comprehensive, yet simple reader line-up is suitable for any new smart or proximity installation.

Schlage Multi-Technology Readers

Schlage multi-technology readers are ideal for any new smart, proximity, or magnetic stripe installation—or as a cost effective way to migrate from existing magnetic stripe or proximity to smart technology.

- 125 kHz proximity and 13.56 MHz contactless smart card technology in one reader
- Magnetic stripe option, reads track 2 default, tracks 1 and 3 configurable
- Reads ISO 14443 A/B and 15693 credentials
- Compatible with:
 - Schlage smart credentials using MIFARE Classic®, MIFARE Plus® and MIFARE® DESFire® EV1
 - Schlage mobile credentials using NFC technology
 - Most popular proximity credentials including Schlage, XceedID, HID®, GE/Casi ProxLite®, AWID®, and LenelProx®
 - CSN of most existing 13.56 MHz credentials
 - Magnetic stripe
- Wiegand interface (RS-485 available)
- FIPS 201-2 compliant
- Tri-state LED (red, green, amber) and audible status alert
- Standard color is black. Gray, brown and cream colors are available, longer lead times may apply.

Schlage Smart Readers

The Schlage smart mini-mullion reader is an excellent option for a smart-only installation.

- 13.56 MHz single frequency contactless smart card technology
- Reads ISO 14443 A/B and 15693 credentials
- Compatible with:
 - Schlage smart credentials using MIFARE Classic®, MIFARE Plus® and MIFARE® DESFire® EV1
 - Schlage mobile credentials using NFC technology
 - CSN of most existing 13.56 MHz credentials
- Wiegand interface
- FIPS 201-2 compliant
- Tri-state LED (red, green, amber) and audible status alert
- Standard color is black. Gray, brown and cream colors are available, longer lead times may apply.

Schlage Proximity Readers

This mini-mullion reader is a great solution for proximity-only facilities.

- 125 kHz single frequency proximity technology
- Compatible with:
 - Most popular proximity credentials including Schlage, XceedID, HID®, GE/Casi ProxLite®, AWID®, and LenelProx®
- Tri-state LED (red, green, amber) and audible status alert
- Wiegand interface
- Standard color is black. Gray, brown, and cream colors are available, longer lead times may apply.

Allegion, the Allegion logo, and Schlage are trademarks of Allegion plc, its subsidiaries and/or affiliates in the United States and other countries. All other trademarks are the property of their respective owners.

How to Order:

Follow the steps below to build the full part number for the reader you wish to order. Use the sample below to determine how to write your part number on your PO.

Sample Part Number: **MTK15 - 485 - C - PIV8**

1. Reader Model Number

2. RS-485

(optional – Multi-Tech Readers Only)

3. Color Option

Black (standard) – leave blank
 Cream – add “C”
 Warm Tone Brown – add “BN”
 Cool Tone Gray – add “G”

4. PIV Format

(optional; see chart below for formats)

1. Choose Your Reader Model

See page 34 for available models.

2. RS-485 Capability

Schlage readers (multi-technology only) have been designed with an option to interface directly with controllers that utilize RS-485 protocol. RS-485 is a communication protocol that allows a two way communication between the reader and the panel, for example OSDP protocol.

To order readers with RS-485 capability, add “-485” after the reader model number. If you are using the standard Wiegand protocol, do not add a suffix (leave blank).

3. Reader Color Options

Schlage Readers are available in four color options. Add the appropriate suffix after the reader model number and RS-485 option (if applicable).

Black (standard) – do not add a color suffix, **leave blank**
 Cream – **add “C”**
 Warm Tone Brown – **add “BN”**
 Cool Tone Gray – **add “G”**

If the RS-485 option is chosen, add the color suffix after “-485.” If the RS-485 option is not chosen, add the color suffix after the reader part number (ex: MT11BN).

4. PIV Format

75-bit PIV is the default format for all Schlage readers. Other format requirements are determined by the access control system, agency requirements, and customer specifications. The other available formatting options are listed below. Add “PIV” and the format number after the reader model number, RS-485 option (if applicable), and color suffix (if applicable).

Format Number	Bit Information
1	75-bit PIV
2	58-bit TWIC/CAC
3	200-bit FASC-N
4	64-bit (BCD) TWIC/CAC
5	83-bit TWIC/CAC
6	66-bit (58-bit format + TSM) TWIC/CAC
7	64-bit (58-bit format (no parity) + TSM) TWIC/CAC
8	91-bit (83 bit format + TSM) TWIC/CAC
9	40-bit BCD
10	40-bit reversed BCD
11	64-bit BCD
12	64-bit reversed BCD
13	128-bit BCD
14	128-bit reversed BCD
15	58-bit HSE

If you need assistance in determining the PIV format for your facility, please contact your Allegion sales representative directly.

5. Special Instructions

Please specify any other special instructions directly on your PO.

Pricing/product description subject to change without notice.

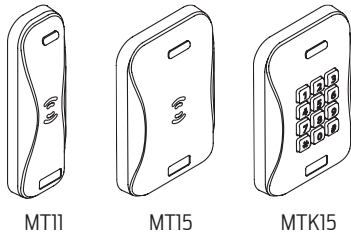

Schlage Multi-Technology Readers

MT11	Multi-Technology Reader – Mullion Mount Dimensions: 5.91" x 1.72" x 0.81". Power required: 5-16 VDC	\$358.00
MT15	Multi-Technology Reader – Wall Mount Dimensions: 5.1" x 3.25" x 0.76". Power required: 5-16 VDC	\$358.00
MTK15	Multi-Technology Reader – Wall Mount with Keypad Dimensions: 5.1" x 3.25" x 0.76". Power required: 5-16 VDC	\$574.00

For RS-485 capability add -485 to part number.

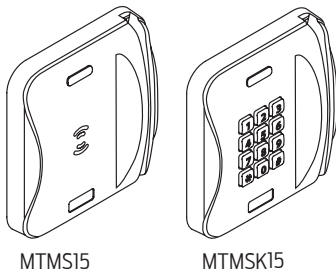

Schlage Multi-Technology Magnetic Stripe Readers

MTMS15	Multi-Technology Magnetic Stripe Reader – Wall Mount Dimensions: 4.43" x 5.17" x 1.15". Power required: 5-16 VDC	\$649.00
MTMSK15	Multi-Technology Magnetic Stripe Reader – Wall Mount with Keypad Dimensions: 4.43" x 5.17" x 1.15". Power required: 5-16 VDC	\$877.00

For RS-485 capability add -485 to part number.



Schlage Contactless Smart Card Readers

SM10	Schlage Contactless Smart Card Reader – Mini-Mullion Mount Dimensions: 4.26" x 1.72" x 0.81". Power required: 5-16 VDC	\$174.00
-------------	--	-----------------



Schlage Proximity Readers

PR10	Proximity Reader – Mini-Mullion Mount Dimensions: 4.26" x 1.72" x 0.81". Power required: 5-16 VDC	\$174.00
-------------	---	-----------------

Reader Replacement Parts

23846462	Pigtail – 18 inch	\$43.40
23933104	Screw pack	\$12.40
47252693	Magnetic Stripe Read Head	\$124.00
23846355	Mini-Mullion Backplate	\$25.90
23846439	Single Gang Backplate	\$25.90
23846397	Mullion Backplate	\$25.90
24152654	Magnetic Stripe Backplate	\$52.00
CP-11	Cosmetic Backplate Cover – Mini Mullion /Mullion (6.70" x 2.50")	\$32.40
CP-15	Cosmetic Backplate Cover – Single Gang (5.65" x 3.85")	\$32.40
CP-21	Cosmetic Backplate Cover – Mid-Range (6.45" x 5.50")	\$32.40

Reader Covers

Standard color for readers is black. Gray, brown and cream colors are available, longer lead times may apply.

23846520	Mini-Mullion – Black	\$25.90
23846546	Mini-Mullion – Warm-Tone Brown	\$25.90
23846538	Mini-Mullion – Cool-Tone Gray	\$25.90
23920648	Mini-Mullion – Cream	\$25.90
23846553	Mullion – Black	\$25.90
23846579	Mullion – Warm-Tone Brown	\$25.90
23846561	Mullion – Cool-Tone Gray	\$25.90
23920655	Mullion – Cream	\$25.90
23846587	Single Gang – Black	\$25.90
23846603	Single Gang – Warm-Tone Brown	\$25.90
23846595	Single Gang – Cool-Tone Gray	\$25.90
23920598	Single Gang – Cream	\$25.90
23846611	Single Gang with Keypad – Black	\$25.90
23846637	Single Gang with Keypad – Warm-Tone Brown	\$25.90
23846629	Single Gang with Keypad – Cool-Tone Gray	\$25.90
23920606	Single Gang with Keypad – Cream	\$25.90
24064149	Magnetic Stripe – Black	\$52.00
24064156	Magnetic Stripe – Warm-Tone Brown	\$52.00
24064172	Magnetic Stripe – Cool-Tone Gray	\$52.00
24064164	Magnetic Stripe – Cream	\$52.00
24064198	Magnetic Stripe with Keypad – Black	\$52.00
24064206	Magnetic Stripe with Keypad – Warm-Tone Brown	\$52.00
24064222	Magnetic Stripe with Keypad – Gray	\$52.00
24064214	Magnetic Stripe with Keypad – Cream	\$52.00

Pricing/product description subject to change without notice.

Enrollment Readers

Enrollment Readers

MT20	USB/MIFARE/EV1 Enrollment Reader	\$600.00
-------------	----------------------------------	-----------------

Pricing/product description subject to change without notice.

Magnetic Stripe Readers

SMR5	Magnetic Stripe Card Reader Weatherized for outdoor use with a cast metal housing and optional wall plate. The SMR5 has one LED. Standard color is black, also available in Beige. Standard is 5 VDC. Must specify for 12 VDC.	\$460.00
SMR10	Magnetic Stripe Card Reader Weatherized for outdoor use with a cast metal housing and optional wall plate. The SMR10 has two LED's. Standard color is black, also available in Beige. Standard is 5 VDC. Must specify for 12 VDC.	\$618.00
SMR20	Magnetic Stripe Card Reader with Keypad Weatherized for outdoor use with a cast metal housing and optional wall plate. The SMR20 has integrated membrane keypad. AVAILABLE IN BEIGE ONLY. Standard is 5 VDC. Must specify for 12 VDC.	\$897.00
SWP10	Wall Plate for Mercury Magnetic Stripe Card Reader Metal Wall Plate (Beige or Black) for MR5, MR10 and MR20 magnetic card readers.	\$26.80
SWS10	Weather Shield for SMR5, SMR10 and SMR20 Readers Brushed Stainless vertical mount.	\$101.00

Enrollment Readers for Schlage Express

CRM2	Magstripe Enrollment Reader for Schlage Express	\$709.00
CRP2	Proximity Enrollment Reader for Schlage Express	\$572.00

iButton Readers

SRT-100	iButton Mullion Mount Reader The SRT100 iButton Mullion-Mount Reader provides solid construction with a 1/4" thick brushed anodized aluminum face plate and stainless steel read head. Bi-color LED and Sonalert provide users with both visual and audible indicators. 26 bit Wiegand output.	\$931.00
----------------	--	-----------------

Keypads



Scramble Keypads

SERIII-W-GR	Scramble Keypad (Gray) The keypad is designed to prevent onlookers from detecting the code being entered. Each key is lighted by an LED with a different set of numbers every time the keypad is used. Weatherized for outdoor applications with a Wiegand output. Power requirements: 8-14 VDC. Standard color is gray. Also available in black (SERIII-W-BLK).	\$2,229.00
SMK-2-GR	Scramble Keypad Surface Mount Kit (Gray) Surface Mount Kit and tamper proof screws. Standard color is gray. Also available in black (SMK-2-BLK).	\$290.00
SSMK-2-ADA	Scramble Keypad Surface Mount Kit (ADA Compliant) Surface Mount Kit and tamper proof screws. ADA compliant.	\$558.00
PMK-2-GR	Panel Mount Kit (Gray) Standard color is gray. Also available in black (PMK-2-BLK).	\$235.00
SPMK-2-GR	Panel Mount Kit w/ Steel Back Box (Gray) Steel back box with tamper proof screws. Standard color is gray. Also available in black (SPMK-2-BLK).	\$254.00

Note: Mounting Kits are sold separately and required for usage with Scramble Keypads.

Electronic Keypads

SEKPDWGW	Electronic Keypad (Mullion Mount) Stainless faceplate with keypad. Weatherized for outdoor use - 2x6 Matrix (5 or 12 VDC) Wiegand output.	\$586.00
SEKPDWG	Electronic Keypad Stainless faceplate with keypad. Weatherized for outdoor use - 3x4 Matrix (5 or 12 VDC) Wiegand output.	\$850.00
SEKPD8B	Electronic Keypad Stainless faceplate with keypad. Weatherized for outdoor use - 3x4 Matrix (5 or 12 VDC) Wiegand output, 8 bit word.	\$831.00

Offline Keypads

KP232	Mullion-mount Keypad Mullion style, back lighted hard plastic keys, weather resistant; indoor/outdoor, doorbell key, main relay and three independent outputs, secured installation, aluminum finish.	\$867.00
KP212	Mullion-mount Keypad Back lighted hard plastic keys, weather resistant; indoor/outdoor, doorbell key and relay, secured installation, aluminum finish.	\$755.00
KP2000E	Flush-mount Backlit Access Control Keypad Indoor/outdoor design, single gang, illuminated backlit keys, and sounder, Wiegand and Secured Series outputs, for stand-alone applications, 5 year warranty.	\$495.00
KP2000EM	Flush-mount Durable Metal Access Control Keypad Indoor/outdoor single gang, durable metal trim, heavy duty metal keys with Braille, and sounder, Wiegand and Secured Series outputs, for stand-alone applications, 5 year warranty.	\$691.00

Pricing/product description subject to change without notice.

LE with ENGAGE Technology - TABLE OF CONTENTS

FINISH CODES AND DESCRIPTIONS	41
EXPLODED VIEW	42
HOW TO ORDER	43
STANDARD FEATURES	44
LE FUNCTIONS	45
LEVER DESIGNS	47
LEVER SUITING	48
CYLINDER COMPATIBILITY	49
ORDERING GUIDE	51
LE GREENWICH SECTIONAL	52
LE ADDISON	54
LE PARTS	56
LE ACCESSORIES	60

Finish Codes and Descriptions

Code		Description
605	(US 3)	Bright Brass
606	(US 4)	Satin Brass
612	(US 10)	Satin Bronze
619	(US 15)	Satin Nickel
622	(US19)	Matte Black
625	(US 26)	Bright Chromium Plated
626	(US 26D)	Satin Chrome
626AM	▲	Antimicrobial Coating on Satin Chromium
643e	(US 11)	Aged Bronze

CONTACT INFORMATION FOR LE SERIES LOCKS & DEVICES

Payment Address: Schlage Electronic Security
 15934 Collections Center Drive
 Chicago, IL 60693

877-671-7011	
Customer Service:	Technical Support:
Order Status, Credit Returns of Non-Defective Products, General Sales Questions	Technical Questions/Issues, Returns of Defective Products, Repairs
Email Orders To: Order_Entry_Schlage_Commercial@allegion.com	Contact For Technical Assistance: Electronic_Lock_TechProdSupport@allegion.com

Pricing/product description subject to change without notice.

GRADE 1 MORTISE LEVERED LOCK

LE Series

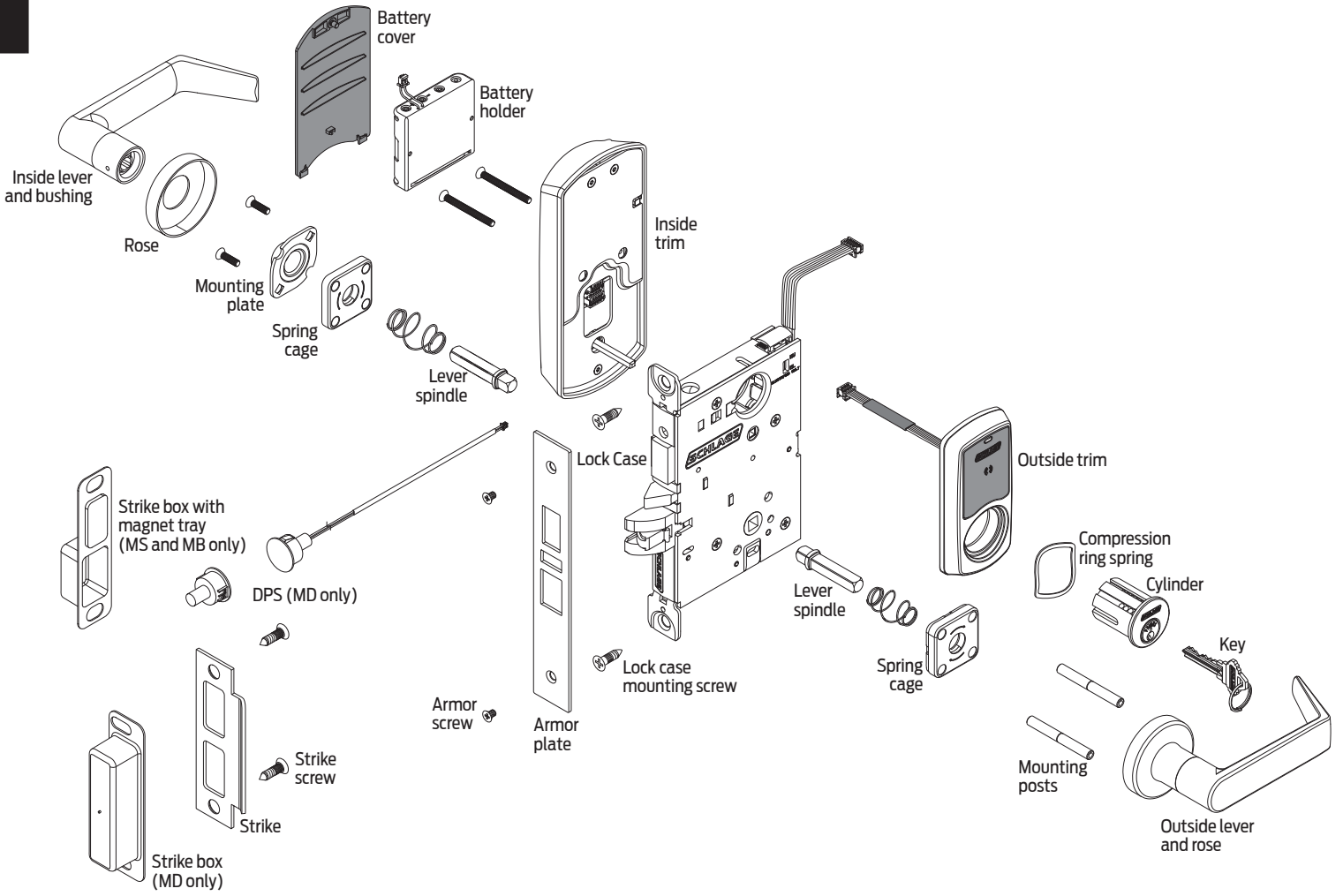

Pricing/product description subject to change without notice.

How to Order:

REQUIRED FIELDS **FACTORY DEFAULT AND OPTIONS**

LE - MS - GRW - P - 03 - 626 - 00A - - - 612 - - - LH - 10-136 - 134 - S123 - -

1. Series:

2. Chassis/Function:

- MS Mortise with LED indicator
- MB Mortise with push button and LED
- MD Mortise Deadbolt with LED

3. Style:

- GRW Greenwich sectional with rose
- ADD Addison escutcheon

4. Cylinder Type:

- P Mortise cylinder, Schlage 6-pin
- For all options see LE ordering pages

5. Outside Lever:*

- 03 Suites with Tubular style
- LAT Latitude

For all options see LE ordering pages

*To add tactile warning, use prefix 8. Example: 803

6. Outside Finish:

- 626 Satin Chrome
- 605 Bright Brass
- 606 Satin Brass
- 612 Satin Bronze
- 619 Satin Nickel
- 622 Matte Black
- 625 Bright Chrome
- 643e Aged Bronze
- 626AM Satin Chrome (Antimicrobial Coating)

7. Outside Rose: Specify only for Greenwich Trim

- 00A 2-1/8" (54 mm) diameter (Standard)
- 00B 2-9/16" (65 mm) diameter
- 00C 2-5/8" (66 mm) diameter with bevel
- AVA Decorative rose 2-5/8" (66 mm) diameter, supports ACC lever only
- MER Decorative rose 2-5/8" (66 mm) diameter, supports MER lever only

8. Inside Lever: Specify only if different from outside lever

- 3 Suites with Tubular style
- LAT Latitude

For all options see LE ordering pages

9. Inside Finish: Specify only if different from outside finish

See options under 6 above

10. Inside Rose: Specify only for Greenwich Trim and only if different from Outside Rose

See options under 7 above

11. Handing:

- RH Right Handed (Standard)
- LH Left Handed
- RHR Right Handed Reverse
- LHR Left Handed Reverse

12. Strike Plate Lip Length:

- 10-136 1-3/16" lip length (Standard for MS/MB)
- 10-136-112 1-1/2" lip length
- For all options see LE ordering pages

13. Door Thickness

134 1-3/4" (Standard)

Options available up to 2-1/4" thickness - see LE ordering pages

14. Keyway Type

- S123 Everest 29 S (Standard)
- For all options see LE ordering pages



15. Additional Options



Standard Features

Certification	ANSI/BHMA Certified A156.25-2013 (Indoor/Outdoor), ANSI/BHMA Certified A156.13-2012, Series 1000, Grade 1 UL 294, ULC S319, UL 10C 3-hour rated
Case Size	4-7/16" x 6-1/16" x 1"
Armor Front	1-1/4" x 8"
Deadbolt	1" throw stainless steel
Latchbolt	3/4" throw stainless steel with anti-friction tongue
Strike	1-1/4" x 4-7/8", square corner, 1-3/16" lip with box and DPS
Backset	2-3/4"
Cylinder	6-Pin solid brass, keyed 6-pin, S123 keyway, keyed different (KD)
Door Range	1-3/4" door thickness standard (can be ordered to accommodate doors 1-3/4" to 2-1/4" thick)
Keys	Two nickel silver cut keys per lock, 6-pin, S123 section

Common Pricing Information

1.	Locks are furnished with standard features unless otherwise specified.
2.	Door thickness is 1 3/4"
3.	Split finishes and designs will be priced at the highest list price of the design and/or finish.
4.	Engineering specials are denoted by a part number beginning with "X" and are not subject to standard discounting.
5.	 denotes a lock or part that requires an extended lead time.
6.	 denotes a handed product and requires handing to be specified.
7.	For all restricted keyways (Everest B, D, 29R, and 29T, also, Quad, Numbered, and Reversed) add \$17.50. This does not apply to Primus cylinders. See Terms and Conditions for ordering information and requirements.
8.	Locks, keys and cylinders containing restricted keyways require additional documentation to order. Please see Terms and Conditions for the specific requirements.
9.	Keyway must be specified for keyed functions and cylinders. If not specified, default keyway will be S123 for KA (keyed alike), KD (keyed different) and 0-bitted product and S145 for factory managed masterkey systems.
10.	Multiple keying options are available. Locks and cylinders are furnished KD unless otherwise specified or excepted by notation.
11.	Control Keys for permanent and construction cores are not included with the lock or cylinder and must be ordered separately.
12.	Locks specified with "C" keyway and KD or 0-bitted will receive 6-pin cylinders (keyed 5) with 5-pin keys.
13.	Full Size Interchangeable Cores (FSIC) are furnished 1-bitted unless otherwise specified. If 0-bitted is selected, the order will be entered as 1-bitted. This does not apply to FSIC Primus® cores.
14.	Conventional cylinders, Primus cylinders (conventional and FSIC) can be supplied 0-bitted. If 1-bitted is selected, the order will be entered as 0-bitted.
15.	Available plug face finishes are 606, 622, 626 and 643e

Pricing/product description subject to change without notice.

Function

Addison Escutcheon Shown

MS - Mortise with LED Indicator	
Storeroom	<p>Lockset is normally secure. Inside lever always allows free egress. Valid toggle credentials on the exterior may be used to change to a passage or secured status. A mechanical key will momentarily unlock the door.</p>
MB - Mortise with Interior Push Button and LED	
Office	<p>Lockset is normally secure. Inside lever always allows free egress. Interior pushbutton on inside housing may be used to select a passage or secured status. Meets need for lockdown function for safety and security. NOTE: Valid toggle credentials on the exterior may also be used to change status. Has interior pushbutton (IPB).</p>
Privacy	<p>Lockset is normally secure. Inside lever always allows free egress. Interior pushbutton on inside housing may be used to select a privacy status. The interior pushbutton will disable normal electronic access from the exterior. Opening the door or pressing the interior pushbutton a second time on the inside housing deactivates the privacy status. Has interior pushbutton (IPB).</p>
Apartment	<p>Lockset is normally secure. Inside lever always allows free egress. Interior pushbutton on inside housing may be used to select a passage or secured status. Opening the door or pressing the interior pushbutton causes the lockset to toggle unsecured. While toggled unsecured, the lockset can only be secured while the door is closed by pressing the interior pushbutton or using a normal credential on the exterior. Normal electronic access from the exterior is always allowed. Has interior pushbutton (IPB).</p>
MD - Mortise Deadbolt with LED	
Privacy	<p>Lockset is normally secure from exterior. Inside lever always allows free egress (if deadbolt is extended, inside knob/lever will simultaneously retract latchbolt and deadbolt). The deadbolt may be used to select a privacy status. With deadbolt extended, normal electronic access from the exterior will be disabled. Opening the door or retracting deadbolt deactivates the privacy status.</p>
Apartment	<p>Lockset is normally secure from exterior. Inside lever always allows free egress (if deadbolt is extended, inside knob/lever will simultaneously retract latchbolt and deadbolt). The deadbolt may be used to select a passage or secured status. Opening the door or retracting the deadbolt causes the lockset to toggle unsecured. While toggled unsecured, the lockset can only be secured while the door is closed by extending the deadbolt from inside or using a normal credential on the exterior reader. Normal electronic access from the exterior is always allowed.</p>

Handing

RH	Right Handed: Hinges on Right Opens Inward	
LH	Left Handed: Hinges on left Opens Inward	
RHR	Right Handed Reverse: Hinges on Right Opens Outward	
LHR	Left Handed Reverse: Hinges on Left Opens Outward	

Pricing/product description subject to change without notice.

Forged Lever Designs

<p>01</p>	<p>02</p>	<p>03 Tubular</p>	<p>05</p>
<p>06 Rhodes</p> <p>Not available with C Rose</p>	<p>07 Athens</p>	<p>12</p> <p>☞ specify hand</p>	<p>17 Sparta</p>
<p>18</p>	<p>Latitude (LAT)</p>	<p>Longitude (LON)</p>	<p>Omega (OME)</p>
<p>Accent (ACC)</p> <p>☞ specify hand</p>	<p>Asti (AST)</p> <p>☞ specify hand</p>	<p>Merano (MER)</p> <p>☞ specify hand</p>	
<p>41</p>	<p>42</p>		

Wrought Rose Designs

<p>00A</p> <p>2 1/8" (54 mm) diameter</p>	<p>00B</p> <p>2 9/16" (65mm) diameter</p>	<p>00C (not available in 612 finish)</p> <p>2 5/8" (66mm) diameter</p>	<p>AVA (ACC lever only)</p> <p>2 5/8" (66mm) diameter</p>	<p>MER (MER lever only)</p> <p>2 5/8" (66mm) diameter</p>
--	--	---	--	--

Pricing/product description subject to change without notice.

Forged Lever Designs

<p>M51</p>	<p>M52</p>	<p>M53</p>	<p>M54</p>
<p>M55</p>	<p>M56</p>	<p>M61</p>	<p>M63</p>
<p>M81</p>	<p>M82</p>	<p>M83</p>	<p>M84</p>
<p>M85</p>	<p>ME1</p>	<p>ME2</p>	<p>ME3</p>

Wrought Escutcheon Design

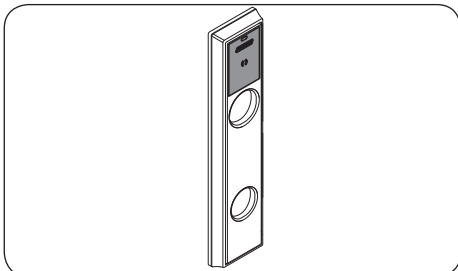

Tactile Options

O6 lever shown
(See LE ordering pages for availability)

Pricing/product description subject to change without notice.

Commercial Lever Suiting

Standard Levers

L /LE Mortise	LT Tubular	ND /NDE Cylindrical	AD/CO Series	AL Cylindrical	S Tubular	33A/35A, 94/95, 98/99 Exit Devices (Von Duprin)
01	01					01
02	02					02
03	03	Tubular*	Tubular			03
05	05					05
06	06	Rhodes	Rhodes	Saturn	Saturn	06
07	07	Athens	Athens	Jupiter	Jupiter	07
12	12					12
17	17	Sparta	Sparta	Neptune	Neptune	17
18	18					18
Latitude	Latitude	Latitude				Latitude
Longitude	Longitude	Longitude				Longitude
Omega	Omega	Omega*		Omega		16
Asti	Asti				Flair	Asti
Merano	Merano					Merano
Accent	Accent					Accent
M52*	M52*	Broadway				
M81*	M81*	Boardwalk				

* Not available on NDE Series locks. M52 is equivalent to the Broadway lever and M81 to the Boardwalk lever.

M Collection Levers

L /LE Mortise	LT Tubular	33A/35A, 94/95, 98/99 Exit Devices (Von Duprin)
M51	M51	M51
M52	M52	M52
M53	M53	M53
M54	M54	M54
M55	M55	M55
M56	M56	M56
M57*	M57	M57
M61	M61	M61
M62*	M62	M62
M63	M63	M63
M81	M81	M81
M82	M82	M82
M83	M83	M83
M84	M84	M84
M85	M85	M85
ME1	ME1	ME1
ME2	ME2	ME2
ME3	ME3	ME3

* Not available on LE Series locks.

Pricing/product description subject to change without notice.

Cylinder

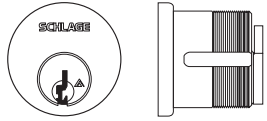
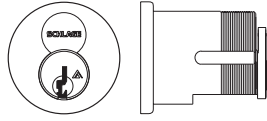
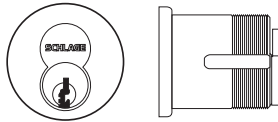
P	With mortise cylinder Schlage Everest 29 S123 6-Pin Keyed different as standard with two keys For master keying, additional charge applies Specify line item 50-210 per master-keyed lock	
Z	With mortise cylinder Schlage Everest SL 7-pin - factory master keyed only	
L	Less mortise cylinder	
R	With cylinder Schlage Everest 29 S123 6-Pin Full Size Interchangeable Core (FSIC) Keyway one bitted as standard with two keys	
J	Less cylinder Schlage 6-Pin Full Size Interchangeable Core (FSIC)	
T	T Construction core Full Size Interchangeable Core (FSIC)	
G	With cylinder Schlage Everest 29 R 7-Pin Small Format Interchangeable Core (SFIC) Factory master keyed with two keys as standard, master keying must be specified	
B	Less cylinder Schlage, Falcon, Competitive OEM's 7-Pin Small Format Interchangeable Core (SFIC)	
H	Construction core Small Format Interchangeable core (SFIC) A non-refundable handling charge applies	
BDC	Disposable core Small Format Interchangeable core (SFIC)	

- Notes:**
1. For P, R, Z and GD, master keyed cylinders can be specified and will be shipped in lock packaging.
 2. For Master Key System Summary form which should accompany the master keyed order, see Electronic Security price book pages 253-263.
 3. Control Keys for installation/removal of interchangeable cores are not furnished and must be ordered separate.
 4. For additional assistance on Master Keying as well as restricted keyways please contact your local sales representative.

Cylinder and Length Requirements, LE

Cylinder Type	Cylinder	Door Thickness (+/- 1/8")		
		1-3/4"	2"	2-1/4"
Mortise Cylinder	30-021*	1-1/4" (114), 1-3/8" (138), 1-1/2" (112)	1-3/8" (138), 1-1/2" (112) , 1-5/8" (158)	1-1/2" (112) , 1-5/8" (158), 1-3/4" (134)
	FSIC	1-1/2" (112)		
	SFIC	1-3/8" (138)		N/A

*112 Standard length will ship with lock

**Product is LESS CORE, see page 58 for pricing

Notes

1. Cylinders include compression spring
2. Assumes EE (equally extended)
3. Door thickness range supported: minimum 1-5/8" to maximum 2-3/8"
4. Supports all functions (MS, MB, and MD) for both ADD and GRW

Pricing/product description subject to change without notice.

Customer Name:

Customer Address:

Ship To:

Account #:

Quote #:

PO # & Date:

Price book #:

Shipping Instructions:

Requested Ship Date:

Order Written By:

For Further Information Contact
(Name, Phone, Fax)

	Quantity	1. Series	2. Chassis/Function	3. Style	4. Cylinder	5. Outside Lever	6. Outside Finish	7. Outside Rose ¹	8. Inside Lever ²	9. Inside Finish ²	10. Inside Rose ^{1,2}	11. Handing ³	12. Strike ⁴	13. Door Thickness ⁵	14. Keyway	15. Options
Ex.	1	LE	MS	GRW	P	03	626	00A				RH	10-136	1-3/4	S123	

Please complete all information above and email order to:
Order_Entry_Schlage_Commercial@allegion.com

- 1. Applicable only to Greenwich sectional with rose design.
- 2. Specify only if different from outside.
- 3. Required if selecting one of the handed lever styles.
- 4. Strike Plate: 10-072 standard for MD and 10-136 standard for MS/MB if no selection is made.
- 5. Door Thickness: 1-3/4" standard if no selection is made.

Pricing/product description subject to change without notice.



1-3. Select Chassis/Function/Style **Note:** Check with access control software provider to verify function is supported by software.

LEMS-GRW	Mortise with LED indicator: Storeroom function	\$1,185.00
LEMB-GRW	Mortise with push button and LED: Privacy, Office, Apartment functions	\$1,215.00
LEMD-GRW	Mortise Deadbolt with LED: Privacy, Apartment functions	\$1,284.00

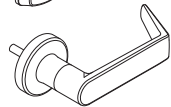

Outside

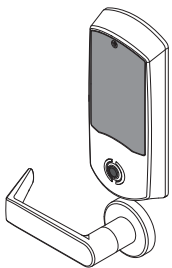

MS with LED

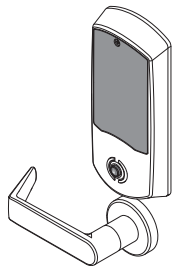

MB with interior push button and LED

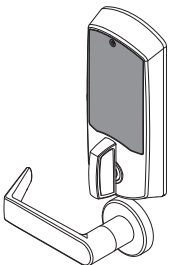

MD - Deadbolt with LED

4. Select Cylinder Type **Note:** Maximum door thickness with SFIC Cylinder is 2"; otherwise compatible with 1-3/4" to 2-1/4" doors.

P ●△	Mortise cylinder, Schlage 6-Pin (Everest 29 S123 standard) Also available in formats to support residential customers (5-Pin cylinder with C keyways).	N/C
Z ●	Mortise cylinder, Schlage Everest SL, 7-Pin (factory master keyed only)	N/C
L	Less mortise cylinder	DEDUCT \$85.00
R ●□	FSIC with cylinder, Schlage 6-Pin (Everest 29 S123 standard)	\$73.00
J	Less FSIC, Schlage, 6-Pin	N/C
T	FSIC construction core	\$73.00
GD ●□	SFIC with cylinder, Schlage 7-Pin (Everest 29R standard) (factory master keyed only)	\$84.00
BD	Less SFIC, Schlage, Falcon, competitive OEM's, 7-Pin	N/C
HD	SFIC construction core	\$44.00
BDC	SFIC disposable	N/C
50-231	Construction core handling charge (non-refundable)	\$10.40

● Master keyed cylinders will be shipped in lock package. To specify, send Master Keying System Summary form (page 295 of SES price book) with order or go to kss.allegion.com.

△ For master keying, an additional charge of \$20.10 each applies. Specify line item 50-210.

□ Control keys for installation/removal of interchangeable cores are not furnished and must be ordered separate.

For additional assistance on Master Keying as well as restricted keyways please contact customer service.

5. Select Outside Lever **Note:** Reference pages 6 and 7 to see style option images.

03	Suites with Tubular style	N/C
06	Suites with Rhodes style	N/C
07	Suites with Athens style	N/C
17	Suites with Sparta style	N/C
LAT	Latitude	N/C
Standard options	01, 02, 05, 12, 18, LON, OME, ACC, AST, MER, 41, and 42 (also 03, 06, 07, 17, and LAT)	N/C
M Collection options	M51, M52, M53, M54, M55, M56, M61, M63, M81, M82, M83, M84, M85, ME1, ME2, ME3	\$30.00
8xx*	Tactile Warning on standard levers available for 01, 02, 03, 05, 06, 07, 12, 17, and 18	\$47.80
8xx*	Tactile Warning on M collection levers available for M51, M52, and M81	\$77.80

* Ordering instructions: Preface lever design code with 8. Example: 803 for 03, 851 for M51, etc.

Applied to exterior lever only unless otherwise specified. Not available with 643e finish.

6. Select Outside Finish

626	Satin Chrome	N/C
605	Bright Brass	\$63.00
606	Satin Brass	\$63.00
612	Satin Bronze (00C rose not available in 612 finish)	\$63.00
619	Satin Nickel	\$63.00
622	Matte Black	\$63.00
625	Bright Chrome	\$63.00
643e	Aged Bronze	\$63.00
626AM	Satin Chrome Antimicrobial	\$85.00

7. Select Outside Rose

00A	2-1/8" (54 mm) diameter	STANDARD
00B	2-9/16" (65 mm) diameter	N/C
00C	2-5/8" (66 mm) diameter with bevel (Not available in 612 finish)	N/C
AVA	Decorative rose 2-5/8" (66 mm) diameter, supports ACC lever only	N/C
MER	Decorative rose 2-5/8" (66 mm) diameter, supports MER lever only	N/C

8. Select Inside Lever **Note:** Specify only if different from Outside Lever.

Standard options	01, 02, 03, 05, 06, 07, 12, 17, 18, LAT, LON, OME, ACC, AST, MER, 41, and 42	N/C
M Collection options*	M51, M52, M53, M54, M55, M56, M61, M63, M81, M82, M83, M84, and M85	\$30.00

* \$30 price adder for M Collection levers only applies if outside lever is Standard.

9. Select Inside Finish **Note:** Specify only if different from Outside Finish.

See options in section 6.	\$63.00-\$85.00*
---------------------------	------------------

* Upcharge only applies if outside finish is 626 and you are specifying a different inside finish.

10. Select Inside Rose **Note:** Specify only if different from Outside Rose.

See options in section 7.	N/C
---------------------------	-----

11. Select Handing (Field reversible)

RH	Right Handed	STANDARD
LH	Left Handed	N/C
RHR	Right Handed Reverse	N/C
LHR	Left Handed Reverse	N/C

12. Select Strike Lip Length

10-136	1-3/16" lip length (MS and MB only)	STANDARD
10-136-112	1-1/2" lip length (MS and MB only)	N/C
10-136-134	1-3/4" lip length (MS and MB only)	\$27.10
10-072	1-3/16" lip length (MD only)	STANDARD
10-072-112	1-1/2" lip length (MD only)	N/C
10-072-134	1-3/4" lip length (MD only)	\$31.30

13. Select Door Thickness

134	1-3/4"	STANDARD
200	2"	\$51.10
214	2-1/4"	\$51.10

14. Select Keying Type

Open Keyway Families (Mortise cylinder or FSIC)²		
S123	Everest 29 S (Key in Lever or FSIC)	STANDARD
C123	Everest C	N/C
C/CE/E/EF/F/FG/G	Classic Obverse	N/C
Restricted Keyway Families (Mortise cylinder or FSIC)^{1,2,3}		
29T	Everest 29 T	\$17.50
D	Everest D	\$17.50
29R	Everest 29 R (Everest SL)	\$17.50
B	Everest 29 B (Everest SL)	\$17.50
Classic Restricted	Quad, Numbered, Reverse	\$17.50
Restricted Keyway Families (SFIC)³		
29R	Everest 29 R	N/C
B	Everest B	N/C

1. Everest Restricted Keyways require a Letter of Authorization submitted with the order. See sample Letter of Authorization, page 297 of SES price book.

2. Full size key systems (Everest 29 S & T, Everest C & D, Obverse & Quad) are available in Primus and Primus XP key system and must be ordered separately. Lock should be ordered less cylinder and Primus cylinder should be a separate line item.

3. For restricted keyways please see terms and conditions.

LE Wireless Lock - Addison Mortise/Mortise Deadbolt



1-3. Select Chassis/Function **Note:** Check with access control software provider to verify function is supported by software.

LEMS-ADD	Mortise with LED indicator: Storeroom function	\$1,225.00
LEMB-ADD	Mortise with push button and LED: Privacy, Office, Apartment functions	\$1,255.00
LEMD-ADD	Mortise Deadbolt with LED: Privacy, Apartment functions	\$1,324.00

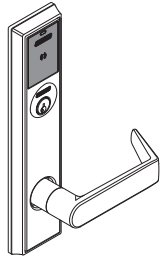

Outside

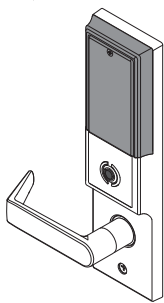

MS with LED Indicator

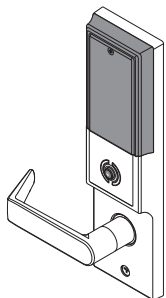

MB with interior push button and LED

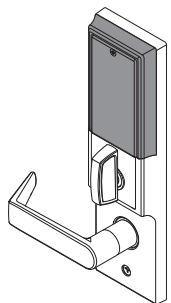

MD - Deadbolt with LED

4. Select Cylinder Type **Note:** Maximum door thickness with SFIC Cylinder is 2", otherwise compatible with 1-3/4" to 2-1/4" doors.

P ● △	Mortise cylinder, Schlage 6-Pin (Everest 29 S123 standard) <i>Also available in formats to support residential customers (5-Pin cylinder with C keyways).</i>	N/C
Z ●	Mortise cylinder, Schlage 7-Pin (Everest SL standard) (factory master keyed only)	N/C
L	Less mortise cylinder	DEDUCT \$119.00
R ● □	FSIC with cylinder, Schlage 6-Pin (Everest 29 S123 standard)	\$73.00
J	Less FSIC, Schlage, 6-Pin FSIC	N/C
T	FSIC construction core	\$73.00
G ● □	SFIC with cylinder, Schlage 7-Pin (Everest 29R standard) (factory master keyed only)	\$84.00
B	Less SFIC, Schlage, Falcon, competitive OEM's, 7-Pin	N/C
H	SFIC construction core	\$44.00
BDC	SFIC disposable	N/C
50-231	Construction core handling charge (non-refundable)	\$10.40

● Master keyed cylinders will be shipped in lock package. To specify, send Master Keying System Summary form (page 295 of SES price book) with order or go to kss.allegion.com.

△ For master keying, an additional charge of \$20.10 each applies. Specify line item 50-210.

□ Control keys for installation/removal of interchangeable cores are not furnished and must be ordered separate.

For additional assistance on Master Keying as well as restricted keyways please contact customer service.

5. Select Outside Lever* **Note:** Reference pages 6 and 7 to see style option images.

03	Suites with Tubular style	N/C
06	Suites with Rhodes style	N/C
07	Suites with Athens style	N/C
17	Suites with Sparta style	N/C
LAT	Latitude	N/C
Standard options	01, 02, 05, 12, 18, LON, OME, ACC, AST, MER, 41, and 42 (also 03, 06, 07, 17, and LAT)	N/C
M Collection options	M51, M52, M53, M54, M55, M56, M61, M63, M81, M82, M83, M84, M85, ME1, ME2, ME3	\$30.00
8xx*	Tactile Warning on standard levers available for 01, 02, 03, 05, 06, 07, 12, 17, and 18	\$47.80
8xx*	Tactile Warning on M collection levers available for M51, M52, and M81	\$77.80

* Ordering instructions: Preface lever design code with 8. Example: 803 for 03, 851 for M51, etc.

Applied to exterior lever only unless otherwise specified. Not available with 643e finish.

6. Select Outside Finish

626	Satin Chrome	N/C
605	Bright Brass	\$63.00
606	Satin Brass	\$63.00
612	Satin Bronze	\$63.00
619	Satin Nickel	\$63.00
622	Matte Black	\$63.00
625	Bright Chrome	\$63.00
643e	Aged Bronze	\$63.00
626AM	Satin Chrome Antimicrobial	\$85.00

7. Select Outside Rose (Not applicable to Addison)

8. Select Inside Lever **Note:** Specify only if different from Outside Lever.

Standard options	01, 02, 03, 05, 06, 07, 12, 17, 18, LAT, LON, OME, ACC, AST, MER, 41, and 42	N/C
M Collection options*	M51, M52, M53, M54, M55, M56, M61, M63, M81, M82, M83, M84, and M85	\$30.00

* \$30 price adder for M Collection levers only applies if outside lever is Standard.

Pricing/product description subject to change without notice.

9. Select Inside Finish Note: Specify only if different from Outside Finish.

See options in section 6. **\$63.00-\$85.00***

** Upcharge only applies if outside finish is 626 and you are specifying a different inside finish.*

10. Select Inside Rose (Not applicable to Addison)

11. Select Handing (Field reversible)

RH	Right Handed	STANDARD
LH	Left Handed	N/C
RHR	Right Handed Reverse	N/C
LHR	Left Handed Reverse	N/C

12. Select Strike Lip Length

10-136	1-3/16" lip length (MS and MB only)	STANDARD
10-136-112	1-1/2" lip length (MS and MB only)	N/C
10-136-134	1-3/4" lip length (MS and MB only)	\$27.10
10-072	1-3/16" lip length (MD only)	STANDARD
10-072-112	1-1/2" lip length (MD only)	N/C
10-072-134	1-3/4" lip length (MD only)	\$31.30

13. Select Door Thickness

134	1-3/4"	STANDARD
200	2"	\$51.10
214	2-1/4"	\$51.10

14. Select Keying Type

Open Keyway Families (Mortise cylinder or FSIC)²		
S123	Everest 29 S (Key in Lever or FSIC)	STANDARD
C123	Everest C	N/C
C/CE/E/EF/F/FG/G	Classic Obverse	N/C
Restricted Keyway Families (Mortise cylinder or FSIC)^{1,2,3}		
29T	Everest 29 T	\$17.50
D	Everest D	\$17.50
29R	Everest 29 R (Everest SL)	\$17.50
B	Everest 29 B (Everest SL)	\$17.50
Classic Restricted	Quad, Numbered, Reverse	\$17.50
Restricted Keyway Families (SFIC)³		
29R	Everest 29 R	N/C
B	Everest B	N/C

1. Everest Restricted Keyways require a Letter of Authorization submitted with the order. See sample Letter of Authorization, page 297.

2. Full size key systems (Everest 29 S & T, Everest C & D, Obverse & Quad) are available in Primus and Primus XP key system and must be ordered separately. Lock should be ordered less cylinder and Primus cylinder should be a separate line item.

3. For restricted keyways please see terms and conditions.

Lever & Knob Kits										
Style	Design Option	605	606	612	619	622	625	626	643e	626AM
Standard	01, 02, 03, 05, 06, 07, 12, 17, 18, 41, 42, OME	▪	▪	▪	▪	▪	▪	▪	▪	▪
	ACC, AST, MER, LAT, LON	▪	▪		▪	▪	▪	▪	▪	▪
Decorative	M51, M52, M53, M54, M55, M56, M61, M63, M81, M82, M83, M84, and M85, ME1, ME2 and ME3	▪	▪		▪	▪	▪	▪	▪	▪
Extended Factory Lead Time Specify handing										
Part Number	Description	Standard levers/knobs				Decorative levers				
09-401	Outside lever/knob, retaining clip, insertion tool	\$181.00				\$196.00				
09-402	Inside lever + bushing, mounting plate, screw pack, spanner wrench									
Note: Knobs and levers standard default is for 1-3/4" door. 2" and 2-1/4" door widths also available.										

ORDERING INSTRUCTIONS: Specify part number, lever design, and finish. Also specify door thickness when other than 1-3/4". (Example: 09-401 03 626 214)

Rose Kits (Greenwich)										
Style	Design Option	605	606	612	619	622	625	626	643e	626AM
Standard	00A, 00B, 00C	▪	▪	▪	▪	▪	▪	▪	▪	▪
Decorative	MER, AVA	▪	▪		▪	▪	▪	▪	▪	▪
Part Number	Description	Price Each								
09-403	Inside rose (includes mounting plate and screws)	\$102.00								
09-404	Outside rose + bushing									
09-508	Blank outside rose (not available MER or AVA)									

ORDERING INSTRUCTIONS: Specify part number, lever design + rose, and finish. (Example: 09-404 03A 626. Lever design must be specified for proper bushing)

Outside Greenwich Lever/Knob and Rose Subassemblies										
Style	Design Option	605	606	612	619	622	625	626	643e	626AM
Standard	01, 02, 03, 05, 06, 07, 12, 17, 18, 41, 42, OME	▪	▪	▪	▪	▪	▪	▪	▪	▪
	ACC, AST, MER, LAT, LON	▪	▪		▪	▪	▪	▪	▪	▪
Decorative	M51, M52, M53, M54, M55, M56, M61, M63, M81, M82, M83, M84, and M85, ME1, ME2 and ME3	▪	▪		▪	▪	▪	▪	▪	▪
Extended Factory Lead Time Specify handing										
Part Number	Description	Standard levers/knobs				Decorative levers				
09-506	Outside lever/knob assembly for 00A, 00B or 00C rose	\$201.00				\$216.00				
09-655	Outside lever assembly for AST w/Avanti rose or MER w/Merano rose only	\$201.00				N/A				

ORDERING INSTRUCTIONS: Specify part number, lever design, rose, and finish. (Example: 09-506 M53A 626)

Inside Subassemblies										
Available Finishes - Specify for Listed Parts		605	606	612	619	622	625	626	643e	626AM
Part Number	Description	Contents	▪	▪	▪	▪	▪	▪	▪	▪
Greenwich inside trim assembly without battery cover										
L483-033	Mortise deadbolt (MD)	Complete trim minus battery cover, battery holder and mounting screws	\$465.00							
L483-034	Mortise with push button (MB)									
L483-035	Mortise with LED (MS)									
Addison inside escutcheon assembly without battery cover										
L483-036	Mortise deadbolt (MD)	Complete escutcheon minus battery cover, battery holder and mounting screws	\$510.00							
L483-037	Mortise with push button (MB)									
L483-038	Mortise with LED (MS)									

ORDERING INSTRUCTIONS: Specify finish. (Example: L483-036 626)

Outside Subassemblies

Available Finishes - Specify for Listed Parts			605	606	612	619	622	625	626	643e	626AM
Part Number	Description	Contents	▪	▪	▪	▪	▪	▪	▪	▪	▪
L483-016	Greenwich Trim	1) Outside reader (electronics & trim) 2) Harness 3) Cover 4) Grounding spring 5) Back plate 6) Two screws	\$400.00								
Part Number	Description	Contents	Standard Levers/Knobs				Decorative Levers				
L483-017	Addison Escutcheon	1) Outside reader (electronics & escutcheon) 2) Harness 3) Lever	\$600.00				\$615.00				
L483-051	Addison Escutcheon	1) Outside reader (electronics & escutcheon) 2) Harness Lever NOT included	\$460.00				\$460.00				

ORDERING INSTRUCTIONS: Specify finish (GRW or ADD). For Addison, also specify lever style. (Example: L483-017 03 626)

Battery Parts

Part Number	Description	Price Each
L483-039	Battery Harness	\$9.00
N623-006	Battery Holder	\$18.00
L483-025	Greenwich battery cover with screw, washer & magnet	\$35.20
L483-031	Addison battery cover with screw, washer & magnet	\$38.00

Armor Fronts

Available Finishes - Specify for Listed Parts			605	606	612	619	622	625	626	643e	626AM
Part Number	Description	Price Each	▪	▪	▪	▪	▪	▪	▪	▪	▪
09-666	1-1/4" wide for 1-3/4" and larger door thicknesses (for MS, MB, MD)	\$37.00									

Strikes

Available Finishes - Specify for Listed Parts			605	606	612	619	622	625	626	643e	626AM
Part Number	Description	Contents	▪	▪	▪	▪	▪	▪	▪	▪	▪
10-136	1-1/4" x 4-7/8" strike, 1-3/16" lip length, standard (MS and MB)*	(1) square corner strike (2) screws (1) strike box (includes DPS magnet)	\$37.40								
10-136-112	1-1/4" x 4-7/8" strike, 1-1/2" lip length (MS and MB)*		\$37.40								
10-136-134	1-1/4" x 4-7/8" strike, 1-3/4" lip length (MS and MB)*		\$63.50								
L583-761	Strike box with magnet tray only (finish not applicable) - MS and MB		\$15.20								
L583-760	DPS magnet for L583-761 only (finish not applicable)		\$15.20								
10-072	1-1/4" x 4-7/8" strike, 1-3/16" lip length, standard (MD only)*	(1) square corner strike (2) screws (1) strike box	\$22.50								
10-072-112	1-1/4" x 4-7/8" strike, 1-1/2" lip length (MD only)*		\$22.50								
10-072-134	1-1/4" x 4-7/8" strike, 1-3/4" lip length (MD only)*		\$57.50								
K510-066	Strike box only (finish not applicable) - MD only		\$6.80								

*ORDERING INSTRUCTIONS: Specify finish.

Pricing/product description subject to change without notice.

Mortise Cylinders

Available Finishes - Specify for Listed Parts		605	606	612	619	622	625	626	643e	626AM
		▪	▪	▪	▪	▪	▪	▪	▪	▪
Part Number	Cylinder only	Price Each								
		Open					Restricted			
30-021-112	Conventional (non-Everest, non-Primus) - 1-1/2" length	\$119.00					\$136.50			
20-793-112	Primus controlled access- 1-1/2" length	\$199.00								
20-793-112-XP	Primus XP controlled access- 1-1/2" length									
20-593-112	Primus UL 437- 1-1/2" length	\$232.00								
20-593-112-XP	Primus XP UL 437- 1-1/2" length									

ORDERING INSTRUCTIONS: Specify finish and Cylinder Length. (Reference Cylinder and length requirement table on page 49. (ex 30-021-138-626)

Note: 1 1/2" cylinders support 1 3/4" through 2 1/4" door thickness.

If 1 3/4" thick door a 1 3/8" cylinder can be used by designating 138 in place of 112 in table above. If this is done deduct \$45.00 from list price in table.

Cylinder Housing Without Core, LE-Series

Cylinder Type	Cylinder	Finishes Available: 605, 606, 609, 612, 613, 619, 625, 626, 643e			16' Price Each
		Door Thickness (+/- 1/8")			
		1-3/4"	2"	2-1/4"	
FSIC	30-016	1-1/2" (112)			\$61.00
SFIC	80-108*	1-3/8" (138)		N/A	\$72.00

ORDERING INSTRUCTIONS: Specify finish (30-016-112-626)

*Cylinders include compression spring

Mortise Chassis and Wire Harnesses

Part Number	Description	Price Each
L483-000	Chassis with harness (MS and MB only)	\$780.00
L483-001	Chassis with harness (MD only)	\$940.00
L483-018	Reader harness	\$30.00
L483-007	Chassis harness with RX module switch	\$100.00
L483-055	DPS kit (external, MD only) Contains: magnet, switch, and harness	\$6.30

Door Parts

Part Number	Description	Price Each
L283-029	(2) Spacers for ANSI A115.1 metal door preparations	\$37.00

Knob Parts

Part Number	Description	Price Each
K110-550	Pack of truarc ring (1), spacer (2), knobs	\$8.70
L583-321	Mounting plate, inside knob	\$7.40

Lever Parts

Part Number	Description	Price Each
L283-030	Pack of 20 truarc rings, levers	\$21.90
L583-212	(1) Mounting post (ferrule) for 1-3/4" door thickness	\$11.70
L583-213	(1) Mounting post (ferrule) for 2" door thickness	\$11.70
L583-214	(1) Mounting post (ferrule) for 2-1/4" door thickness	\$11.70
L283-031	Mounting plate, inside lever	\$20.10
L283-040	Spring cage (1 required per lever)	\$9.90
L583-066	Mounting plate screw (2 required per lock)	\$1.40
L283-198	Spindles and springs for 1-3/4" to 1-7/8" doors (2 each)	\$16.00
L283-199	Spindles and springs for 2" to 2-1/4" doors (2 each)	\$18.80
L283-060	Spindle and spring for 1-3/4" to 1-7/8" doors (qty: 1 – 2 required per lock)	\$8.00
L283-061	Spindle and spring for 2" to 2-1/4" doors (qty: 1 – 2 required per lock)	\$9.90

Pricing/product description subject to change without notice.

Screw Packs

Part Number	Description	Contains	Price Each
L483-047	Greenwich screw pack	(2) Reader- mount screws (not finished) (1) Tamper-resistant battery screw (1) Battery cover washer	\$13.00
L483-048	Addison screw pack specify finish	(1) Each Phillips and tamper-resistant bottom screw - specify finish (2) Reader- mount screws (not finished) (1) Tamper-resistant battery screw (1) Battery cover washer	\$21.00
C203-736	Lock Case Screws	(2) C603-256, #12-24 WMS PFH	\$6.60
C203-736	Strike Screws	(2) C603-256, #12-24 WMS PFH.	\$6.60
K110-020	Armor Front Screws	(2) K510-210, #8-32 x 1/4" MS PFH	\$0.90
L483-066	Battery cover screw (10 pack)	(10) 24361818 battery cover screw, #4-40 x 1/4" PH (10) L783-036 battery cover captive washer	\$20.00

* Consult Customer Care.

Chassis Torx Screw Packs

Part Number	Description	Contains	Price Each
L283-121	Tamper-resistant Torx screw pack for standard L screws - specify finish	(2) Armor screws, #8-32 x 1/4" (T-15) (2) Strike screws, #12-24 x 1/2" (T-20) (1) Each T-15 and T-20 installation tool	\$22.10
L483-065	Backplate screw pack w/grounding spring - specify finish	(1) L783-029, grounding spring (6) F605-416, #6-32 x 3/8" TFH	\$5.00

Pricing/product description subject to change without notice.

Installation Tools

Part Number	Description	Price Each
40-286	Universal Clamp	\$462.00
40-248	L/LE Series installation template	\$390.00
40-291	Universal mortise door position switch (DPS) installation template (For use with only LE-MD lock)	\$126.00
40-158	Mortise pocket filler (edge)	\$174.00

Note: *The universal clamp above is necessary when using the remaining products to ensure hole placement accuracy. These installation tools function together and form a complete LE installation kit. The "Universal" (Clamp & DPS) products are for use in all CO, AD and LE product installations.*

Wood Mounts

Part Number	Description	Price Each
44-212	LE Series mortise mount (for display)	\$405.00

NDE WITH ENGAGE TECHNOLOGY - TABLE OF CONTENTS

FINISH CODES AND DESCRIPTIONS 61

HOW TO ORDER 62

STANDARD FEATURES 63

NDE FUNCTIONS 64

NSE WIRELESS LOCK 65

NDE WIRELESS LOCK - CYLINDRICAL 66

ORDERING GUIDE 67

NDE PARTS 70

- Outside Escutcheon Subassembly 70
- Reader PCBA 70
- Battery Holder Kit 70
- Levers and Related Components 70
- Inside Escutcheon Subassembly 71
- Latches and Related Components 71
- Strikes 71
- Competitor Core/Compatibility Parts 72
- Reinforcements 72
- Motorized Chassis Assembly 72
- Main Wire Harness 72
- Miscellaneous Parts 72
- Conversion Kits 73
- Screws 73
- Screw Packs 73
- Torx Screw Packs 73
- Cylinder Reference Table 73

CTW ENGAGE SINGLE DOOR CONTROLLER 74

Finish Codes and Descriptions

Code		Description
605	(US 3)	Bright Brass
606	(US 4)	Satin Brass
612	(US 10)	Satin Bronze
619	(US 15)	Satin Nickel
622	(US19)	Matte Black
625	(US 26)	Bright Chromium Plated
626	(US 26D)	Satin Chrome
626AM	▲	Antimicrobial Coating on Satin Chromium
643e	(US 11)	Aged Bronze

CONTACT INFORMATION FOR NDE SERIES LOCKS & DEVICES

Payment Address: Schlage Electronic Security
 15934 Collections Center Drive
 Chicago, IL 60693

877-671-7011	
Customer Service:	Technical Support:
Order Status, Credit Returns of Non-Defective Products, General Sales Questions	Technical Questions/Issues, Returns of Defective Products, Repairs
Email Orders To: Order_Entry_Schlage_Commercial@allegion.com	Contact For Technical Assistance: Electronic_Lock_TechProdSupport@allegion.com

Pricing/product description subject to change without notice.

How to Order:

REQUIRED FIELDS

FACTORY DEFAULT AND OPTIONS

NDE - 80 - PD - ATH - 626 - SPA - - - 13-047 - 10-130 - 138 - S123 - -

1. Series:

2. Function:

80 Storeroom with Vandlgard

3. Cylinder Type:

P Schlage KIL format (see ordering pages for options)
For options see NDE ordering pages

Latch Type:

D Dead-latch (only option available)

4. Outside Lever:

- LLL Less interior and exterior levers
- SPA Sparta
- RHO Rhodes
- ATH Athens*
- TLR Tubular*
- OME Omega
- LAT Latitude*
- LON Longitude*
- BRW Broadway*
- BRK Boardwalk*

*To add tactile warning, use prefix 8. Example: 8SPA

5. Outside Finish:

- 626 Satin Chrome
- 605 Bright Brass
- 606 Satin Brass
- 612 Satin Bronze
- 619 Satin Nickel
- 622 Matte Black
- 625 Bright Chrome
- 643e Aged Bronze
- 626AM Satin Chrome (Antimicrobial Coating)

6. Inside Lever:* Specify only if different from outside lever

- LLL Less interior and exterior levers
- SPA Sparta
- RHO Rhodes
- ATH Athens*
- TLR Tubular*
- OME Omega
- LAT Latitude*
- LON Longitude*
- BRW Broadway*
- BRK Boardwalk*

*To add tactile warning, use prefix 8. Example: 8SPA

7. Inside Finish: Specify only if different from outside finish

- 626 Satin Chrome
- 605 Bright Brass
- 606 Satin Brass
- 612 Satin Bronze
- 619 Satin Nickel
- 622 Matte Black
- 625 Bright Chrome
- 643e Aged Bronze
- 626AM Satin Chrome (Antimicrobial Coating)

8. Backset and Latchbolt:

13-247 2-3/4" Backset, Deadlatch, Square Corner, 1-1/8" x 2-1/4" (Standard)
For options see individual Class/Chassis page

9. Strike Plate:

10-130 1-3/16" Lip, ANSI, DPS magnets, no box, 1-1/4" x 4-7/8" (Standard)
For options see individual Class/Chassis page

10. Strike Lip Dimension: Specify only if different from options 10-130 or 10-132 dimensions

- 138 1-3/8" lip length option available on 10-130 and 10-131 strike plates (normally 1-3/16")
- 112 1-1/2" lip length option available on 10-132 strike plate (normally 1-1/8")

11. Keyway Type:

S123 Everest 29 S (Standard)
For options see individual Class/Chassis page

12. Additional Options

Pricing/product description subject to change without notice.



Standard Features

Certification	ANSI/BHMA Certified A156.25-2013, A156.2-2011, Series 4000, Grade 1, UL 294, UL 10C
Latch	1 1/8" x 2 1/4", Square corner faceplate, 1" housing diameter, 1/2" throw
Strike	1 1/4" x 4 7/8", ANSI Square corner, with DPS magnets, no box
Backset	2 3/4"
Cylinder	6-Pin solid brass, keyed 6-pin, S123 keyway, keyed different (KD)
Door Range	Comes set for 1-3/4" thick doors. Can be field adjusted for doors 1-5/8"-2" thick.
Keys	Two nickel silver cut keys per lock, 6-pin, S123 section

Common Pricing Information

1.	Locks are furnished with standard features unless otherwise specified.
2.	Door thickness is 1 3/4"
3.	Split finishes and designs will be priced at the highest list price of the design and/or finish.
4.	Engineering specials are denoted by a part number beginning with "X" and are not subject to standard discounting.
5.	denotes a lock or part that requires an extended lead time.
6.	For all restricted keyways (Everest D, Everest 29 T, Quad, Numbered, Reversed) add \$17.50. This does not apply to Primus cylinders. See Terms and Conditions for ordering information and requirements.
7.	Locks, keys and cylinders containing restricted keyways require additional documentation to order. Please see Terms and Conditions for the specific requirements.
8.	Keyway must be specified for keyed functions and cylinders. If not specified, default keyway will be S123 for KA, KD and 0-bitted product and S145 for Factory managed masterkey systems.
9.	Multiple keying options are available. Locks and cylinders are furnished KD unless otherwise specified or excepted by notation.
10.	Control Keys for permanent and construction cores are not included with the lock or cylinder and must be ordered separately.
11.	Locks specified with "C" keyway and KD or 0-bitted will receive 6 pin cylinders (keyed 5) with 5 pin keys.
12.	Full Size Interchangeable Cores (FSIC) are furnished 1-bitted unless otherwise specified. If 0-bitted is selected, the order will be entered as 1-bitted. This does not apply to FSIC Primus® cores.
13.	Conventional cylinders, Primus cylinders (conventional and FSIC) can be supplied 0-bitted. If 1-bitted is selected, the order will be entered as 0-bitted.
14.	Available plug face finishes are 606, 622, 626 and 643e

Pricing/product description subject to change without notice.

ANSI/BHMA Certified A156.25-2013, A156.2-2011, Series 4000, Grade 1, UL 294, UL 10C

Keyed Locks



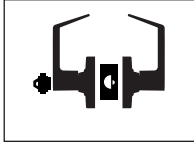

SCHLAGE ANSI

NDE80PD F86

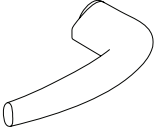

Storeroom Lock with Vandlgard

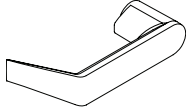
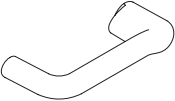
Lockset is normally secure with outside lever disengaged. Valid credential or key momentarily unlocks door. Valid credential may be used to change to a passage or secured state. Inside lever always allows free egress.

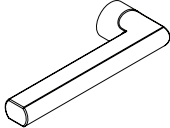
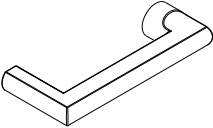
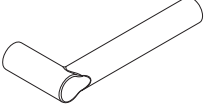
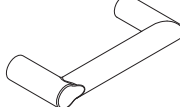
Athens (ATH) 	Sparta (SPA) 	Rhodes (RHO) 	Tubular (TLR) 	Omega (OME) 
Latitude (LAT) 	Longitude (LON) 	Broadway (BRW) 	Boardwalk (BRK) 	

Commercial Lever Suite

NDE Levers	AD/CO Levers	ND Levers	L Lock Levers	98/99 Exit	AL Lock	S Lock	F Lock
Athens	Athens	Athens	07	07	Jupiter	Jupiter	
Sparta	Sparta	Sparta	17	17	Neptune	Neptune	Jazz
Rhodes	Rhodes	Rhodes	06	06	Saturn	Saturn	Elan
Tubular		Tubular					
Omega		Omega					
Latitude		Latitude	Latitude	Latitude			Latitude
Longitude		Longitude	Longitude	Longitude			
Broadway		Broadway					
Boardwalk		Boardwalk					



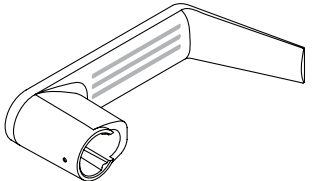
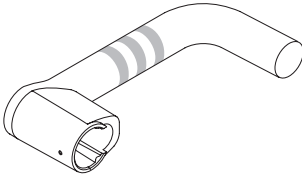

Tactile Options

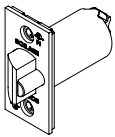
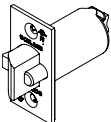
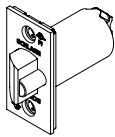
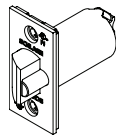
 Typical pattern for 8AT, 8LT, 8LN, 8RO, 8SP	 Typical pattern for 8BK, 8BW, 8TR
---	---

Latches

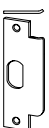
Deadlatch, 13-247 	Anti-Friction Fire Door Deadlatch, 14-042 	Deadlatch, 14-047 	Deadlatch, 14-048 
---	---	--	---

Strikes

ANSI Strike, 10-130 	ANSI Strike, standard box 10-131 	T Strike, 10-132 	Square corner, T-strike, deep box, fire door latch, 10-133 
---	--	---	--

Pricing/product description subject to change without notice.

Cylinder

Core Callout	Description	Levers
P	6-Pin KIL Cylinder	ATH OME RHO SPA TLR LAT LON BRW BRK
L	Less 6-Pin KIL Cylinder	
Z	Everest SL 7 pin KIL Cylinder	
R	Full Size Interchangeable Core	
J	Less Full Size Interchangeable Core	
T	Full Size Construction Core	
B	Less Small Format Interchangeable Core	
BDC	Disposable Small Format Interchangeable Core	
G	7 Pin Small Format Interchangeable Core	
50-231	Construction Core Handling Charge (non-refundable)	
L SAR	Less cylinder: Sargent KIL Core - 10L & 11L	ATH RHO SPA TLR
L COR	Less cylinder: Corbin KIL Core - 8000	
J SAR	Less cylinder: Sargent FSIC 6-pin Core - 6300	
J CO6	Less cylinder: Corbin FSIC 6-pin Core - 8000	
J YA6	Less cylinder: Yale FSIC 6-pin Core - 1210 or Medesco FSIC 6-pin Core - 31-0100	
J MED	Less cylinder: Medesco FSIC 6-pin Core - 32-0101	
J CO7	Less cylinder: Corbin FSIC 7 pin Core - 8000-7	RHO
J YA7	Less cylinder: Yale FSIC 7-pin Core - 1211	

- Notes:**
1. Competitor lever designs come in finishes 626 standard, and 605, 606, 612, 619, 625, 643e, and 626AM with extended lead-times.
 2. For P, R and G -Master Keyed cylinders can be specified and will be shipped in lock packaging.
 3. For Master Key System Summary form which should accompany the master keyed order, see pages 283-293.
 4. For Master Keying, additional line item 50-210 is required for Classic and Everest cylinders.
 5. Control Keys for installation/removal of interchangeable cores are not furnished and must be ordered separate.
 6. Spring cages & tail pieces are different based on the type of cylinder and chassis selected. Please see the NDE-Series parts guide for more information.
 7. The NDE-Series accepts many popular models of standard, SFIC, and FSIC cylinders. See pricebook for specific configurations.
 8. For additional assistance on Master Keying as well as restricted keyways please contact your local sales representative.

Customer Name:

Customer Address:

Ship To:

Account #:

Quote #:

PO # & Date:

Price book #:

Shipping Instructions:

Requested Ship Date:

Order Written By:

For Further Information Contact
(Name, Phone, Fax)

	Quantity	1. Series	2. Function 80	3. Cylinder	4. Outside Lever	5. Outside Finish	6. Inside Lever ¹	7. Inside Finish ¹	8. Backset & Latch ²	9. Strike ³	10. Keyway
Ex.	1	NDE	80	PD	SPA	626			13-047	10-130	SI23

Please complete all information above and email order to:
Order_Entry_Schlage_Commercial@allegion.com

1. Specify only if different from outside
 2. Backset & Latch: 13-247 standard for cylindrical if no selection is made
 3. Strike Plate: 10-025 standard for cylindrical if no selection is made

Pricing/product description subject to change without notice.

1-2. Select Chassis/Function

NDE-80	Cylindrical Storeroom Lock with Vandlgard	\$943.00
---------------	---	-----------------



NDE-80

KIL Format
P L Z L-SAR L-CO6

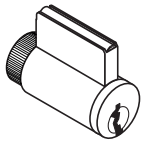

FSIC Format
R J T J-SAR J-CO6 J-CO7
J-YA6 J-YA7 J-MED

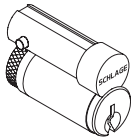

SFIC Format
B BDC G H

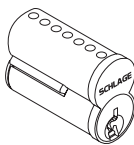

3. Select Cylinder Type

PD ●	With Cylinder, Schlage- (Everest 29 S123, 6 Pin KIL standard)	N/C
ZD ●	With Cylinder, Schlage- Everest SL, 6 Pin KIL (factory master keyed only)	N/C
LD	Less Cylinder, Schlage, Falcon, 6 Pin KIL	DEDUCT \$64.00
RD ● □	With Cylinder, Schlage 6-Pin (Everest 29 S123 standard) FSIC	\$38.00
JD	Less Cylinder, Schlage, 6 Pin FSIC	DEDUCT \$35.00
T	FSIC construction core	\$38.00
G ● □	With Cylinder, Schlage 7-Pin (Everest 29R standard) (factory master keyed only)	\$84.00
B	Less Cylinder, Schlage, Falcon, Competitive OEM's, 7 Pin (SFIC)	N/C
L CO6 ⊕	Less Cylinder, Corbin Russwin KIL, 6 Pin KIL	DEDUCT \$64.00
L SAR ⊗ ⊕	Less Cylinder, Sargent (10L + 11L), 6 Pin KIL	DEDUCT \$64.00
J SAR ⊗ ⊕	Less Cylinder, Sargent 6300, 6 Pin FSIC	DEDUCT \$35.00
J CO6 ⊗ ⊕	Less Cylinder, Corbin 8000, 6 Pin FSIC	DEDUCT \$35.00
J CO7 ⊕	Less Cylinder, Corbin 8000-7, 7 Pin FSIC. (Only RHO, 8RO, SPA, 8SP)	DEDUCT \$35.00
J MED ⊕	Less Cylinder, Medeco 32*0201, 6 Pin FSIC (Only RHO, 8RO, SPA, 8SP lever styles)	DEDUCT \$35.00
J YA6 ⊗ ⊕	Less Cylinder, Yale 1210 or Medeco 31*0100, 6 Pin FSIC	DEDUCT \$35.00
J YA7 ⊕	Less Cylinder, Yale 1220, 7 Pin FSIC (Only RHO, 8RO, SPA, 8SP lever styles)	DEDUCT \$35.00
H	SFIC construction core	\$44.00
BDC	SFIC disposable	N/C
50-231	Construction core handling charge (non-refundable)	\$10.40

● Master Keyed cylinders can be specified and will be shipped in lock packaging. For Master Keying System Summary form which should accompany the master keyed order, see page 283.

△ For Master Keying, additional line item 50-210 is required \$20.10 each.

□ Control Keys for installation/removal of interchangeable cores are not furnished and must be ordered separate.

For additional assistance on Master Keying as well as restricted keyways please contact customer service.

⊗ Extended lead time on all finishes except 626

⊕ Not available on LAT, LON, BRW and BRK

4. Select Outside Lever*

LLL	Less interior and exterior levers	DEDUCT \$48.00
SPA	Sparta	N/C
RHO	Rhodes	N/C
ATH	Athens	N/C
TLR	Tubular	N/C
OME	Omega	N/C
LAT	Latitude	N/C
LON	Longitude	N/C
BRW	Broadway	N/C
BRK	Boardwalk	N/C
Tactile options (8AT, 8LT, 8LN, 8RO, 8SP, 8BK, 8BW, 8TR)		\$45.90

5. Select Outside Finish

626	Satin Chrome	N/C
605	Bright Brass	\$70.00
606	Satin Brass	\$70.00
612	Satin Bronze	\$70.00
619	Satin Nickel	\$70.00
622	Matte Black	\$70.00
625	Bright Chrome	\$70.00
643e	Aged Bronze	\$70.00
626AM	Satin Chrome Antimicrobial	\$100.00

6. Select Inside Lever* (Specify only if different from Outside Lever)

LLL	Less interior and exterior levers	DEDUCT \$48.00
SPA	Sparta	N/C
RHO	Rhodes	N/C
ATH	Athens	N/C
TLR	Tubular	N/C
OME	Omega	N/C
LAT	Latitude	N/C
LON	Longitude	N/C
BRW	Broadway	N/C
BRK	Boardwalk	N/C
Tactile options (8AT, 8LT, 8LN, 8RO, 8SP, 8BK, 8BW, 8TR)		\$44.60

Credentials available, see pages 26-31.

Pricing/product description subject to change without notice.

7. Select Inside Finish (Specify only if different from Outside Finish)

626	Satin Chrome	N/C
605	Bright Brass	\$70.00*
606	Satin Brass	\$70.00*
612	Satin Bronze	\$70.00*
619	Satin Nickel	\$70.00*
622	Matte Black	\$70.00*
625	Bright Chrome	\$70.00*
643e	Aged Bronze	\$70.00*
626AM	Satin Chrome Antimicrobial	\$100.00*

* Charge only applies if outside finish is 626 and you are specifying a different inside finish.

8. Select Backset & Latchbolt

LLL	Less Latch	DEDUCT \$35.20
13-247	2-3/4" Backset, Deadlatch, Square corner, 1-1/8" x 2-1/4"	STANDARD
14-042	2-3/4" Backset, Deadlatch Anti-friction fire door latch, Square corner,	\$181.00
14-047	2-3/8" Backset, Deadlatch Square corner, 1-1/8" x 2-1/4"	N/C
14-048	2-3/8" Backset, Deadlatch Square corner, 1" x 2-1/4"	N/C

9-10. Select Strike Plate and Strike Lip Length

10-130*	1-3/16" Lip, ANSI, DPS magnets, no box, 1-1/4" x 4-7/8"	STANDARD
10-131*	1-3/16" ANSI, DPS magnets, Standard box, 1-1/4" x 4-7/8"	N/C
10-132**†	1-1/8" Lip, Square Corner, T-strike, DPS magnets, box, 1-1/8" - 2-3/4"	N/C
10-133†	1-1/8" Lip, Square Corner, T-strike, DPS magnets, deep box, fire door latch	\$17.50
K510-066	Box for ANSI strike (Must be specific)	N/C

* 1-3/8" Lip available, must specify 1-3/8" Lip \$15.00, 1-1/2" Lip available, must specify 1-1/2" Lip \$15.00

** 1-1/2" Lip available, must specify 1-1/2" Lip \$8.20

† DPS magnet requires prep and install beneath strike

11. Select Keying Type

Open Keyway Families: KIL or FSIC²		
S123	Everest 29 S (Key in Lever or FSIC)	STANDARD
C123	Everest C	N/C
C/CE/E/EF/ F/ FG/ G	Classic Obverse	N/C
Restricted Keyway Families: KIL or FSIC^{1,2}		
29 T	Everest 29 T	\$17.50
D	Everest D	\$17.50
29R	Everest 29 R (Everest SL)	\$17.50
B	Everest B (Everest SL)	\$17.50
Classic Restricted	Quad, Numbered, Reverse	\$17.50
Restricted Keyway Families: SFIC³		
29R	Everest 29 R	N/C
B	Everest B	N/C

¹ Everest Restricted Keyways require a Letter of Authorization to be submitted with the order. See sample Letter of Authorization, see page 295.

² Full Size key systems (Everest 29 S & T, Everest C & D, Obverse & Quad) are available in Primus and Primus XP key system and must be ordered separately. Lock should be ordered less cylinder and Primus cylinder should be a separate line.

³ Master Keyed cylinders can be specified and will be shipped in lock packaging. For Master Keying System Summary form which should accompany the master keyed order, see page 283.

Outside Escutcheon Subassembly

Available Finishes - Specify for Listed Parts			605	606	612	619	625	626	643e	626AM
Part Number	Description	Contents	Price Each							
N223-045	Outside Escutcheon Subassembly (without reader PCBA)	(3) #6-32 x .25 FH PD TC Screw (1) Outside Escutcheon (1) Outside RF Window Assembly (1) Adjustment Spring (1) Outside Backplate	\$105.00							

Reader PCBA

Part Number	Description	Price Each
N223-046	Reader PCBA	\$355.00

Battery Holder Kit

Part Number	Description	Contents	Price Each
N223-044	Battery Holder Kit	(1) Battery Tray Assembly (1) Battery Strap	\$25.50

Levers and Related Components

Available Finishes - Specify for Listed Parts		605	606	612	619	625	626	643e	626AM
Part Number	Description	Price Each							
N523-127	FSIC Core Driver	\$2.70							
N523-091	SFIC Core Driver	\$12.20							
09-774	SFIC Core Driver and Spacer	\$15.00							
D500-000	SFIC Core Spacer - Spacer required for 6-pin, no spacer required for 7-pin	\$1.60							
New product manufactured on or after February 1, 2017 (reference serial number label on product)									
03-230*	Lever - Closed; ATH, 8AT, RHO, 8RO, SPA, 8SP, OME, TLR, 8TR	\$136.00							
03-231*	Lever - Cylinder - Schlage KIL; ATH, RHO, SPA								
03-232*	Lever - Cylinder - Schlage FSIC; ATH, RHO, SPA								
03-200*	Lever - Cylinder - Schlage SFIC; ATH, RHO, SPA								
47258039	Lever - Cylinder - Schlage SFIC - BRW								
47258040	Lever - Cylinder - Schlage SFIC - BRK								
47258041	Lever - Cylinder - Schlage SFIC - LAT								
47258042	Lever - Cylinder - Schlage SFIC - LON								
47260537	Lever - Cylinder - Schlage SFIC - 8BY								
47260538	Lever - Cylinder - Schlage SFIC - 8BK								
47260539	Lever - Cylinder - Schlage SFIC - 8LT	\$182.00							
47260540	Lever - Cylinder - Schlage SFIC - 8LN								
47258043	Lever - Closed - BRW	\$136.00							
47258044	Lever - Closed - BRK								
47258045	Lever - Closed - LAT								
47258046	Lever - Closed - LON								
47260541	Lever - Closed - 8BY								
47260542	Lever - Closed - 8BK								
47260543	Lever - Closed - 8LT								
47260544	Lever - Closed - 8LN								
47258047	Lever - PD, ZD, LD - BRW								
47258048	Lever - PD, ZD, LD - BRK								
47258049	Lever - PD, ZD, LD - LAT	\$136.00							
47258050	Lever - PD, ZD, LD - LON								
47260545	Lever - PD, ZD, LD - 8BY	\$182.00							
47260546	Lever - PD, ZD, LD - 8BK								
47260547	Lever - PD, ZD, LD - 8LT								
47260548	Lever - PD, ZD, LD - 8LN								
47258051	Lever FSIC RD, JD, TD - BRW								
47258052	Lever FSIC RD, JD, TD - BRK								
47258053	Lever FSIC RD, JD, TD - LAT								
47258054	Lever FSIC RD, JD, TD - LON								
47260549	Lever FSIC RD, JD, TD - 8BY								
47260550	Lever FSIC RD, JD, TD - 8BK								
47260551	Lever FSIC RD, JD, TD - 8LT	\$182.00							
47260552	Lever FSIC RD, JD, TD - 8LN								
Original product manufactured before February 1, 2017 (reference serial number label on product)									
03-030*	Lever - Closed; ATH, RHO, SPA	\$136.00							
03-031*	Lever - Cylinder - Schlage KIL; ATH, RHO, SPA								
03-032*	Lever - Cylinder - Schlage FSIC; ATH, RHO, SPA								
03-000*	Lever - Cylinder - Schlage SFIC; ATH, RHO, SPA								
*	Specify part number, lever style, finish. Ex: 03-031 ATH 626 (open lever, Athens design, 626 finish)								

Pricing/product description subject to change without notice.

Inside Escutcheon Subassembly

Available Finishes - Specify for Listed Parts			605	606	612	619	625	626	643e	626AM
Part Number	Description	Contents	Price Each							
N223-047	Inside Escutcheon Subassembly (without Main PCBA)	(3) #4-40 x .25 PH PD Taptite Screw (1) Inside Escutcheon (1) RF Window (1) Inside Battery Cover	\$129.00							
N223-048	Inside Escutcheon Assembly (with Main PCBA)	(3) #4-40 x .25 PH PD Taptite Screw (1) Inside Escutcheon (1) RF Window (1) Inside Battery Cover (1) Main PCB Module (1) Inside Label	\$501.00							

Latches and Related Components

Available Finishes - Specify for Listed Parts		605	606	612	619	625	626	643e	626AM
Part Number	Backset - Description	Price Each							
Dead Latch***									
14-047	2 3/8" - Square corner, 1 1/8" x 2 1/4"	\$117.00							
14-048	2 3/8" - Square corner, 1" x 2 1/4"	\$117.00							
13-247	2 3/4" - Square corner, 1 1/8" x 2 1/4"	\$90.10							
14-042	2 3/4" - Anti-friction Fire Door Latch 1" Square corner, 1 1/8" x 2 1/4", 3/4" Throw	\$358.00							
***	All latches require reinforcement when used in hollow metal door applications								

Strikes

Available Finishes - Specify for Listed Parts			605	606	612	619	625	626	643e	626AM
Part Number	Description	Contents	Price Each							
10-130-1316	1 3/16" - ANSI, no box, 1 1/4" x 4 7/8"	(1) ANSI strike (2) C603-256 screws (1) ANSI strike magnet tray (2) DPS magnet	\$29.70							
10-130-138	1 3/8" - ANSI, no box, 1 1/4" x 4 7/8"	1) ANSI strike (2) C603-256 screws (1) ANSI strike magnet tray (2) DPS magnet	\$57.80							
10-130-112	1 1/2" - ANSI, no box, 1 1/4" x 4 7/8"	(1) ANSI strike (2) C603-256 screws (1) ANSI strike magnet tray (2) DPS magnet	\$57.80							
10-131-1316	1 3/16" - ANSI, standard box, 1 1/4" x 4 7/8"	(1) ANSI strike (2) C603-256 screws (1) Standard box (1) ANSI strike magnet tray (2) DPS magnet	\$38.30							
10-131-138	1 3/8" - ANSI, standard box, 1 1/4" x 4 7/8"	(1) ANSI strike (2) C603-256 screws (1) Standard box (1) ANSI strike magnet tray (2) DPS magnet	\$65.20							
10-131-112	1 1/2" - ANSI, standard box, 1 1/4" x 4 7/8"	(1) ANSI strike (2) C603-256 screws (1) Standard box (1) ANSI strike magnet tray (2) DPS magnet	\$65.20							
10-132-118	1 1/8" - Square corner, T-strike, box, 1 1/8" x 2 3/4"	(1) T-strike (1) Standard box (1) Door position magnet	\$27.00							
10-132-112	1 1/2" - Square corner, T-strike, box, 1 1/8" x 2 3/4"	(1) T-strike (1) Standard box (1) Door position magnet	\$31.70							
10-133-118	1 1/8" - Square corner, T-strike, deep box, 1 1/8" x 2 3/4" Use with fire door latch	(1) T-strike (1) Deep box (1) Door position magnet	\$31.70							
10-133-112	1 1/2" - Square corner, T-strike, deep box, 1 1/8" x 2 3/4" Use with fire door latch	(1) T-strike (1) Deep box (1) Door position magnet	\$31.60							
K510-066	Box for ANSI strike	(1) Standard box	\$6.80							

Pricing/product description subject to change without notice.

Competitor Core/Compatability Parts

Available Finishes - Specify for Listed Parts		605	606	612	619	625	626	643e	626AM
		⌘	⌘	⌘	⌘	⌘	▪	⌘	
Part Number	Description	Price Each							
New product manufactured on or after February 1, 2017 (reference serial number label on product)									
03-234*	Lever - Cylinder - Corbin Russwin KIL (L-CO6); ATH, RHO, SPA, TLR	\$252.00							
03-235*	Lever - Cylinder - Corbin Russwin 7-pin FSIC (J-CO7); RHO								
03-236*	Lever - Cylinder - Yale 7-pin FSIC (J-YA7); RHO								
03-237*	Lever - Cylinder - Medeco 32 (J-MED); ATH, RHO, SPA, TLR								
03-244*	Lever - Cylinder - Sargent KIL (L-SAR); ATH, RHO, SPA, TLR								
03-255*	Lever - Cylinder - Medeco 31 or Yale 1210 6-pin FSIC (J-YA6); ATH, RHO, SPA, TLR								
03-266*	Lever - Cylinder - Corbin Russwin 6-pin FSIC (J-CO6); ATH, RHO, SPA, TLR								
03-277*	Lever - Cylinder - Sargent FSIC (J-SAR); ATH, RHO, SPA, TLR								
N523-218	Springcage & Lever Catch Assy. - Outside Standard (PD, LD, ZD, RD, JD, TD, BD, BDC, GD, HD, LD SAR, LD CO6, JD CO6, JD SAR, JD CO7)	\$67.40							
N523-224	Springcage & Lever Catch Assy. - Outside Competitor Cores (JD YA6, JD YA7, JD MED)	\$140.00							
XN12-292	Tail piece Sargent XC FSIC	\$12.60							
* Specify part number, lever style, finish. Ex: 03-055 RHO 613 (Yale lever, Athens design, 613 finish)									

Tailpieces

Part Number	Description	Price Each
N523-127	Core Driver - SCH FSIC	\$2.70
N523-091	Core Driver - SCH SFIC	12.20
09-060	Core Driver - LD SAR	2.90
09-061	Core Driver - JD YA6	24.00
09-062	Core Driver - JD CO6	13.00
09-063	Core Driver - JD SAR	10.70
10-140	Core Driver - LD CO6	5.80
10-141	Core Driver - JD CO7	23.00
10-142	Core Driver - JD YA7	23.00
10-143	Core Driver - JD MED	15.00
09-774	SFIC Core Driver and Spacer	1.60
D500-000	SFIC Core Spacer - Spacer required for 6-pin, no spacer required for 7-pin	13.00
XN12-292	Tail piece Sargent XC SFIC	

Reinforcements — Must be used for hollow metal doors

Part Number	Description	Price Each
37-001	Metal door reinforcer kit, fits both 7/8" and 1" diameter housings. Specify door thickness, includes A501-567 and A501-565 or A501-566.	\$38.20
24483760	Latch Spacer - fits 1" diameter latch housing and 1-3/4" hollow metal doors (steel & aluminum)	\$5.20
A501-566	Reinforcer for 1 3/4" thick non-reinforced metal doors. Fits both 7/8" and 1" diameter housings.	\$19.20

Motorized Chassis Assembly

Part Number	Description	Contents	Price Each
N223-007	Motorized Chassis Assembly	(1) NDE Chassis Subassembly (1) Motor Actuator Subassembly (1) Main Wire Harness	\$242.00

Main Wire Harness

Part Number	Description	Price Each
N223-019	Main Wire Harness	\$37.20

Miscellaneous Parts

Part Number	Description	Price Each
Inside Baseplate		
N623-000	Inside Baseplate	\$25.50
New product manufactured on or after February 1, 2017 (reference serial number label on product)		
Spring Cages		
N523-218	Springcage & Lever Catch Assy. - Outside Standard (PD, LD, ZD, RD, JD, TD, BD, BDC, GD, HD, LD SAR, LD CO6, JD CO6, JD SAR, JD CO7)	\$69.40
N523-221	Springcage & Lever Catch Assy. - Inside Less Cylinder	\$48.80
N523-224	Springcage & Lever Catchy Assy. - Outside Standard (JD YA7, JD YA6, JD MED)	\$144.00
Original product manufactured before February 1, 2017 (reference serial number label on product)		
Spring Cages		
N123-022	Outside spring cage for all functions except SFIC	\$69.40
N123-032	Inside Spring Cage	\$50.10
N123-056	Outside spring cage for all SFIC functions	\$72.60
24341463	SDS O-Ring - 50 pack	\$20.70

Pricing/product description subject to change without notice.

Conversion Kits

Available Finishes		605	606	612	613	619	622	625	626	643e	626AM
		▪	▪	▪	▪	▪	▪	▪	▪	▪	▪
Part Number	Backset - Description	Price Each									
40-400	Inside Spring Cage / Lever Conversion Kit	\$221.00									
40-600	Outside Spring Cage / Lever Conversion Kit										
Notes:		<p>All kits will contain a spring cage and lever. Some kits will contain a button or tailpiece</p> <p>Kits are limited to previously offered product - KIL, FSIC, SFIC, L-SAR, J-SAR, J-CO6, J-YA6</p> <p>When ordering specify: Function, Trim, Finish and Core (if applicable)</p>									

Screws

Available Finishes - Specify for Listed Parts					605	606	612	619	625	626	643e	626AM
A501-171, N523-092, L583-133, C603-256, C603-897					▪	▪	▪	▪	▪	▪	▪	▪
Part Number	Description	Door Thickness	Type	Size	Price Each							
C603-256*	ANSI strike	—	PFH Combo	12-24 x 1"	\$1.00							
C603-897*	Latch and strike	—	PFH Combo	#8 x 3/4"	\$0.90							
N523-021*	Spring cage screws	1 3/8" - 2"	PFH Machine	#10 x 32 x 2 1/8"	\$1.90							
* Order in multiples of 100												

Screw Packs

Available Finishes - Specify for Listed Parts					605	606	612	619	625	626	643e	626AM
B202-517, C203-736, N123-020					▪	▪	▪	▪	▪	▪	▪	▪
Part Number	Description	Contents		Price Each								
B202-517	Latch and strike	(4) C603-897		\$8.30								
C203-736	ANSI strike	(2) C603-256		\$6.60								
N223-049	Mounting kit	(4) C603-897 (1) N523-108 (2) 96954557 (1) N623-048 (1) N623-049		\$13.50								

Torx Screw Packs

Available Finishes - Specify for Listed Parts					605	606	612	613	619	625	626	643e	626AM
C203-311, C203-312					▪	▪	▪	▪	▪	▪	▪	▪	▪
Part Number	Description	Contents		Price Each									
C203-311**	Latch and strike	(4) C503-766 (T-15)		\$21.30									
C203-312**	Latch and ANSI strike	(2) C503-766 (T-15) (2) L583-371 (T-20)											
** Torx screw packs are furnished with appropriate T-xx installation tool(s)													

Cylinder Reference Table

Available Finishes - Specify for Listed Parts				606		626	
23-065, 20-765/XP, 20-565/XP, 21-000				Price Each			
Part Number	Cylinder Mechanism	Function	Design	Open		Restricted	
23-065	Conventional	Standard Functions	All	\$64.00		\$81.50	
20-765	Primus			\$141.00			
20-765-XP	Primus XP			\$174.00			
20-565	Primus UL437						
20-565-XP	Primus UL437 XP						

Wood Mounts

Part Number	Description	Price Each
44-184	NDE Series cylindrical mount	\$411.00

Pricing/product description subject to change without notice.

CTE ENGAGE Single Door Controller



The CTE is an ENGAGE™ enabled single opening controller that allows perimeter and common area openings to be managed in a single system along with Schlage Control™ smart deadbolts, NDE cylindrical and LE mortise wireless locks. It is ideal for multi-family, commercial mixed use, and retail store front applications.

The CTE is designed to work with a Schlage® Multi-Technology credential reader and interface with an electrified lock, electromagnetic lock, electric strike, automatic operator or exit device to control an opening.

The CTE single door controller with multi-technology reader kit can be used in a variety of applications; below are a few examples.

Please note; all components are sold separately.

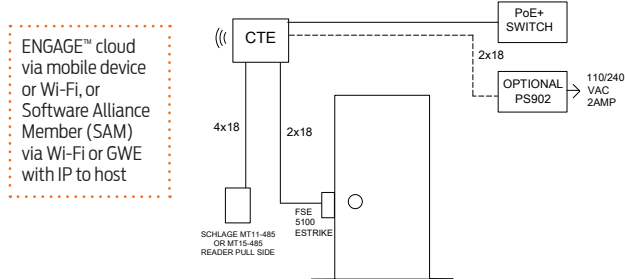

Operation: Presenting a valid credential to Schlage MT XX-485 reader will cause fail secure 5100 electric strike to release for authorized entrance. Free egress always.

Products: We offer a variety of electric strikes from Locknetics™ and Von Duprin®, as well as Schlage Power Supplies to meet the specific needs of the opening.

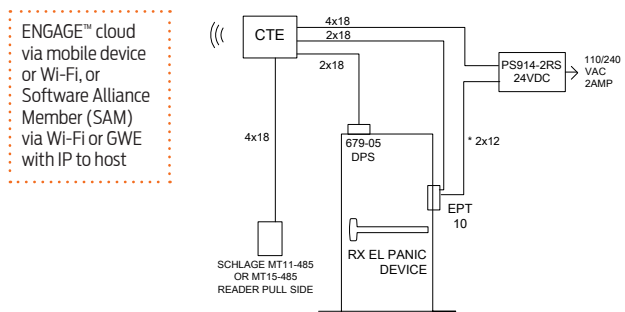

Operation: Presenting a valid credential to Schlage MT XX-485 will cause EL panic device to retract for authorized entrance. Free non-alarmed egress at all times.

Products: We offer a variety of Falcon® and Von Duprin exit devices, and Von Duprin power supplies to meet the specific needs of the opening.

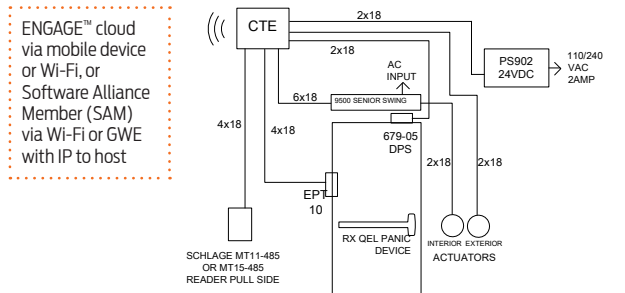

Operation: Presenting a valid credential to Schlage MT XX-485 will cause QEL panic device to retract for authorized entrance and enable exterior actuator. Free non-alarmed egress at all times. Interior actuator always active to retract QEL panic and open door.

Products: We offer a variety of hardware and accessories from Von Duprin, LCN®, Schlage and Locknetics to meet the specific needs of the opening.

Certifications: UL 294 Indoor, FCC Part 15, NEMA Enclosure Indoor (Type 1, 4, and 4X), ULC S319 Indoor, RoHS

CTE Series - How to Order:

		REQUIRED FIELDS		Options		
		CTE	-	MT15-485	-	B
1. CTE						
2. Reader Type						
MT11-485	Multi-Technology Mullion Mount					
MT15-485	Multi-Technology Single Gang Wall Mount					
3. Cover Color (optional)						
B	Black - default					
G	Grey					
BN	Brown					
C	Cream					

1-2. Select CTE Kit Reader Option

CTE-MT11-485	CTE with Multi-Technology Mullion Reader Kit.....	\$1230.00
CTE-MT15-485.....	CTE with Multi-Technology Single Reader Kit.....	\$1230.00

3. Select Color

B	Black – Default	N/C
G	Grey	N/C
BN	Brown	N/C
C	Cream	N/C

Pricing/product description subject to change without notice.

AD-SERIES NETWORKED - TABLE OF CONTENTS	
HOW TO ORDER	76
AD-SERIES NETWORKED LOCKS & DEVICES OVERVIEW	77
AD-300 NETWORKED HARDWIRED	90
Cylindrical	91
Mortise/Mortise Deadbolt	92
Exit Trim	94
AD-302 NETWORKED HARDWIRED (FIPS 201-COMPLIANT)	96
Cylindrical	96
Mortise/Mortise Deadbolt	98
Exit Trim	100
AD-400 NETWORKED WIRELESS	102
Cylindrical	102
Mortise/Mortise Deadbolt	104
Exit Trim	106
AD-402 NETWORKED WIRELESS (FIPS 201-2 COMPLIANT)	108
Cylindrical	108
Mortise/Mortise Deadbolt	110
Exit Trim	112
AD-SERIES 993 NON-FUNCTIONING "DUMMY" TRIM	114
AD-SERIES NETWORKED ACCESSORIES	116

CONTACT INFORMATION FOR AD-SERIES NETWORKED LOCKS & DEVICES

Payment Address: Schlage Electronic Security
 15934 Collections Center Drive
 Chicago, IL 60693

877-671-7011	
Customer Service:	Technical Support:
Order Status, Credit Returns of Non-Defective Products, General Sales Questions	Technical Questions/Issues, Returns of Defective Products, Repairs
Email Orders To: Order_Entry_Schlage_Commercial@allegion.com	Contact For Technical Assistance: Electronic_Lock_TechProdSupport@allegion.com

For AD-Series Networked Locks & Devices Warranty Information please see page 13.

Pricing/product description subject to change without notice.

How to Order:

REQUIRED FIELDS

FACTORY DEFAULT AND OPTIONS

AD - 400 - CY - 70 - MG - SPA - 626 - PD - SI23 - RH - 4B - 13-247 - 10-025 - 1-3/4 - BAA

1. Series

2. Class

- 300 Networked Hardwired
- 302 Networked Hardwired
- 400 Networked Wireless
- 402 Networked Wireless

3. Chassis:

- CY Cylindrical
- MS Mortise
- MD Mortise Deadbolt
- 993R Exit Trim - Rim/CVR/CVC
- 993S Exit Trim - SVR
- 993M Exit Trim - Mortise
- 993DT "Dummy" Exit Trim

4. Function:

- 70 Classroom/Storeroom
- 50 Office
- 40 Privacy
- 60 Apartment

5. Reader:

- KP Keypad
- MGK Magnetic Stripe + Keypad (Insert)
- MG Magnetic Stripe (Insert)
- MSK Magnetic Stripe + Keypad (Swipe)
- MS Magnetic Stripe (Swipe)
- MTK Multi-Technology + Keypad
- MT Multi-Technology
- FMK FIPS 201-2 Compliant Multi-Technology + Keypad

6. Lever: △

- | | | | |
|-----|-----------|-----|-----------|
| SPA | Sparta | ATH | Athens |
| RHO | Rhodes | TLR | Tubular |
| BRW | Broadway | LAT | Latitude |
| BRK | Boardwalk | LON | Longitude |

△ To add tactile warning, use prefix 8. Example 8SPA

7. Finish:

- 626 Satin Chrome
- 605 Bright Brass
- 606 Satin Brass
- 612 Satin Bronze
- 619 Satin Nickel
- 625 Bright Chrome
- 643e Aged Bronze
- 626AM Satin Chrome (Antimicrobial Coating)

8. Cylinder Type:

- PD Schlage 6-pin Full Cylinder (For options see individual Class/Chassis page)

9. Keyway Type:

- SI23 Everest 29 (For options see individual Class/Chassis page)

10. Handing:

- RH Right Handed
- LH Left Handed
- RHR Right Handed Reverse
- LHR Left Handed Reverse

11. Battery Holder:

- 4B - 4AA Battery Kit
- 8B - 8AA Battery Kit

12. Backset and Latch or Armor Front:

- 13-247 2-3/4" Backset, Deadlatch, Square Corner, 1-1/8" x 2-1/4" (Standard on CY Chassis)
 - 09-663 Armor Front, 1-1/4" Wide, Square Corner (Standard on MS Chassis)
- For options see individual Class/Chassis page

13. Strike:

- 10-025 1-3/16" Lip, ANSI, no box, 1-1/4" x 4-7/8" (Standard on CY Chassis)
 - 10-072 1-3/16" Lip, 1-1/4" x 4-7/8" square corner, box (Standard on MS Chassis)
- For options see individual Class/Chassis page

14. Door Thickness:

- 1-3/4" (Standard)
- For options see individual Class/Chassis page

15. Additional Options

Pricing/product description subject to change without notice.

AD-Series Networked Locks

With the AD-Series, one platform translates to an endless number of adaptable solutions. You can choose the features and functions that are right for the application today, and upgrade to meet your evolving needs in the future.

Class

AD-300	Networked/Hardwired; Direct RS-485 connection or Wiegand or Clock & Data	
AD-302	FIPS 201-2 Compliant, Networked Hardwired; Direct RS-485 connection or Wiegand or Clock & Data	
AD-400	Networked/Wireless; 900 MHz, Secure encrypted data transmission	
AD-402	FIPS 201-2 Compliant, Networked Wireless; 900 MHz, Secure encrypted data transmission	

Note: 1. AD-Series locks are upgradable from standalone to networked by applying a communication module available in the accessories section and new firmware available on www.schlage.com/support.

Chassis

CY: Cylindrical	Bored lock installed into round hole in the door	
MS: Mortise	Lock case installed into a mortise rectangular "pocket" in the door	
MD: Mortise Deadbolt	Mortise lock with built-in interconnected auxiliary deadbolt	
993R: Exit Trim	Rim/Concealed Vertical Rod* (CVR) & Concealed Vertical Cable* (CVC) *Metal door only	
993M: Exit Trim	Mortise	
993S: Exit Trim	Surface Vertical Rod (SVR)	
993DT: Exit Trim	Non-Functioning "Dummy" Exit Trim	

Notes: 2. Mortise deadbolt requires RS-485 connection to the ACP. See pages 87-88 for system diagram. Check with access control software provider to verify function is enabled.
3. Exit trim utilizes universal hardware to simplify installation to a variety of exit device. AD-Series networked locks require a request to exit switch, please see compatibility chart below.

Exit Device Compatibility

Exit trim utilizes universal hardware to simplify installation to a variety of exit devices*.

Exit Device Compatibility		Rim	SVR	CVR/CVC	Mortise
Von Duprin	98/99 and 98/99XP	●	●	● [†]	●
Von Duprin	22/22F	●	●		
Falcon	25	●			









* Low current request-to-exit switch is required. Part Number for Von Duprin request to exit switch: 050281. Part Number for Falcon AE switch: 650359.

[†] Metal door only.

Pricing/product description subject to change without notice.

Function		AD-300/302	AD-400/402
70: Classroom/ Storeroom	Lockset is normally secure. Inside lever always allows free egress. Valid toggle credentials on the exterior may be used to change to a passage or secured status.		
50: Office	Lockset is normally secure. Inside lever always allows free egress. Interior pushbutton on inside housing may be used to select a passage or secured status. Meets need for lockdown function for safety and security. NOTE: Valid toggle credentials on the exterior may also be used to change status. Has interior pushbutton (IPB).		
40: Privacy	Lockset is normally secure. Inside lever always allows free egress. Interior pushbutton on inside housing may be used to select a privacy status. The interior pushbutton will disable normal electronic access from the exterior. Opening the door or pressing the interior pushbutton a second time on the inside housing deactivates the privacy status. Has interior pushbutton (IPB).		
60: Apartment	Lockset is normally secure. Inside lever always allows free egress. Interior pushbutton on inside housing may be used to select a passage or secured status. Opening the door or pressing the interior pushbutton causes the lockset to toggle unsecured. While toggled unsecured, the lockset can only be secured while the door is closed by pressing the interior pushbutton or using a normal credential on the exterior. Normal electronic access from the exterior is always allowed. Has interior pushbutton.		

Reader

<p>KP: Keypad</p>	<p>12 button design</p>	
<p>MGK: Magnetic Stripe + Keypad (Insert)</p>		
<p>MG: Magnetic Stripe (Insert)</p>		
<p>MSK: Magnetic Stripe + Keypad (Swipe)</p>	<p>Configurable to read the complete Track 1, 2 or 3. Available with and without 12 button keypad.</p>	
<p>MS: Magnetic Stripe (Swipe)</p>		
<p>MTK: Multi-Technology + Keypad</p>		
<p>FMK: FIPS 201-2 Compliant Multi-Technology + Keypad</p>	<p>Single solution that reads 125 kHz proximity and 13.56 MHz smart credentials. Available with and without 12-button keypad</p>	
<p>MT: Multi-Technology</p>		
<p>Si/SiK: Smart iClass Compatible Reader</p>	<p>13.56 MHz smart card credential solution compatible with Schlage MIFARE, HID iClass, iClass SE, and SEOS technologies. Available with and without 12-button keypad.</p>	

Notes: 5. Please refer to AD-Series data sheets and solution sheets prior to ordering to verify credential compatibility.

6. FMK reader now sold separately for field upgrades.

7. Must specify finish when ordering reader separately. KP, MGK, MG, MSK & MS readers available in 626, 605, 606, 612, 619, 625 & 643e. MT, MTK & FMK readers are available in Grey (for 619, 626, 626AM & 625) and available in Brown (for 605, 606, 612 & 643e).

Pricing/product description subject to change without notice.

Lever

RHO	Rhodes		
SPA	Sparta		
TLR	Tubular		
ATH	Athens		
BRW	Broadway		
BRK	Boardwalk		
LAT	Latitude		
LON	Longitude		

- Notes:**
8. All lever designs are available in finishes 605, 606, 612, 619, 625, 626, 643E and 626AM.
 9. SPA, TLR & ATH Meet California Fire Code for 1/2" or less return to the door.
 10. Changing Lever Cylinder Compatibility on a device typically requires replacement of existing spring cage and tailpiece.
 11. To order tactile warning levers use 8AT for Athens, 8RO for Rhodes, 8SP for Sparta and 8TR for Tubular. Applied to exterior lever only unless otherwise specified. Not available with 643e finish.
 12. AD Series, CO Series & ND Series levers may be interchangeable in some cases depending whether it is an interior or exterior lever, the type of chassis and the type of cylinder/ spring cage/ tail piece. Please consult the AD Series Parts guide for more information.



Finish

626	Satin Chrome	BHMA # 626E, Government # US26D
605	Bright Brass	BHMA # 605E, Government # US3
606	Satin Brass	BHMA # 606E, Government # US4
612	Satin Bronze	BHMA # 612E, Government # US10
619	Satin Nickel	
625	Bright Chrome	BHMA # 625E, Government # US26
643e	Aged Bronze	
626AM	Satin Chrome Antimicrobial	

Note: 13. Please refer to the Electronic Access Control catalog or online product information at us.allegion.com to view each finish.

Pricing/product description subject to change without notice.

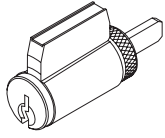
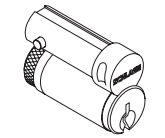
Cylinder

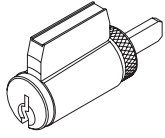
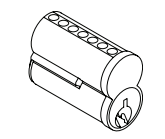
P	With cylinder Schlage- Everest 29 S123 6 Pin Key-in-Lever (KIL) Keyed different as standard with two keys	
L	Less cylinder Schlage, Falcon 6 Pin Key-in-Lever (KIL)	
R	With cylinder Schlage- Everest 29 S123 6 Pin Full Size Interchangeable Core (FSIC) Keyway one bitted as standard with two keys	
J	Less cylinder Schlage 6 Pin Full Size Interchangeable Core (FSIC)	
G	With cylinder Schlage Everest 29 R 7 Pin Small Format Interchangeable Core (SFIC) Factory master keyed with two keys as standard, master keying must be specified	
B	Less cylinder Schlage, Falcon, Competitive OEM's 7 Pin Small Format Interchangeable Core (SFIC)	
L SAR	Less cylinder Sargent (10L+11L) 6 Pin Key-in-Lever (KIL)	
LC06	Less cylinder Corbin 8000 6 Pin Key-in-Lever (KIL)	
JSAR	Less cylinder Sargent 6300 6 Pin Full Size Interchangeable Core (FSIC)	
JC06	Less cylinder Corbin 8000 6 Pin Full Size Interchangeable Core (FSIC)	
JC07	Less cylinder Corbin 8000-7 7 Pin Full Size Interchangeable Core (FSIC) (Only RHO, 8RO, SPA, BSP, TLR, 8TR)	
JMED	Less cylinder Medeco 32*0201 6 Pin Full Size Interchangeable Core (FSIC)	
JYA6	Less cylinder Yale 1210 or Medeco 31*0100 6 Pin Full Size Interchangeable Core (FSIC)	
JYA7	Less cylinder Yale 1220 7 Pin Full Size Interchangeable Core (FSIC)	
L FA7	Less cylinder Falcon 7 Pin Key-in-Lever (KIL) (Only RHO, 8RO, SPA, BSP lever styles)	

*Less Core

*Less Core

*Less Core

*Less Core

- Notes:**
- 14. Competitor lever designs come in finishes 626 standard, and 605, 606, 612, 619, 625, 643e, and 626AM with extended lead-times.
 - 15. For P, R and G -Master Keyed cylinders can be specified and will be shipped in lock packaging.
 - 16. For Master Key System Summary form which should accompany the master keyed order, see pages 283-293.
 - 17. For Master Keying, additional line item 50-210 is required for Classic and Everest cylinders.
 - 18. Control Keys for installation/removal of interchangeable cores are not furnished and must be ordered separate.
 - 19. For additional assistance on Master Keying as well as restricted keyways please contact your local sales representative.
 - 20. Spring cages & tail pieces are different based on the type of cylinder and chassis selected. Please see the AD-Series parts guide for more information.
 - 21. The AD-Series accepts many popular models of standard, SFIC, and FSIC cylinders. Consult the Keyway/Cylinder compatibility datasheet (010432) for details. See pricebook for specific configurations.

Pricing/product description subject to change without notice.

Key Systems Available Through Schlage

Everest 29™ S Keyway Family	Patent protected open keyways that are available in full size key in lever and full size interchangeable core (FSIC) formats. Patent protection through 2029.
Everest 29 T Keyway Family	Patent protected restricted keyways that are available in full size key in lever and full size interchangeable core (FSIC) formats. Patent protection through 2029.
Everest D Keyway Family	Restricted keyways that are available in full size key in lever and full size interchangeable core (FSIC) formats.
Everest C Keyway Family	Open keyways that are available in full size key in lever and full size interchangeable core (FSIC) formats.
Schlage Classic Open Keyways	Classic (C/E/F): Open keyways available in key in lever and full size interchangeable core designs
Everest B Keyway Family	Restricted keyways that are available on small format interchangeable core (SFIC).
Everest 29 R Keyway Family	Patent protected restricted keyways that are available on small format interchangeable core (SFIC). Patent protection through 2029.

- Notes:** 22. Everest Restricted Keyways require a Letter of Authorization to be submitted with the order.
 23. See sample Letter of Authorization page 295.
 24. Full Size key systems (Everest 29 S & T, Everest C & D, Obverse & Quad) are available in Primus and Primus XP key system and must be ordered separately. Lock should be ordered less cylinder and Primus cylinder should be a separate line..
 25. Contact your local RSO representative for assistance in determining which format and level of exclusivity best suits your needs.

Handing

RH	Right Handed: Hinges on Right Opens Inward	
LH	Left Handed: Hinges on left Opens Inward	
RHR	Right Handed Reverse: Hinges on Right Opens Outward	
LHR	Left Handed Reverse: Hinges on Left Opens Outward	

- Notes:** 26. Exit trim 993 chassis available only with RHR or LHR option.
 27. Handing is field reversible, but requires removal of the exterior escutcheon cover. Please see AD-Series installation instructions for details.

Battery

4B	4AA Battery Holder and Cover Kit	
8B	8AA Battery Holder and Cover Kit	

- Notes:** 28. AD-300/AD-302 are hardwired and therefore do not require battery power and ship standard with a cover only and no batteries.
 29. AD-Series locks use standard off the shelf AA batteries.

Pricing/product description subject to change without notice.

Backset & Latchbolt (Cylindrical Chassis)

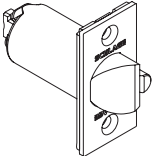
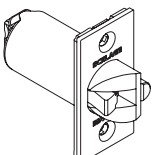
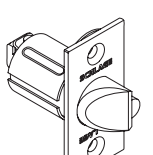
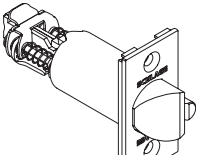
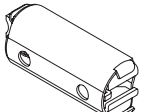
<p>13-247</p>	<p>2-3/4" Backset, Deadlatch, Square corner, 1-1/8" x 2-1/4"</p>	
<p>14-049</p>	<p>2-3/4" Backset, Deadlatch Anti-friction fire door latch, Square corner, 1-1/8" x 2-1/4", 3/4" throw</p>	
<p>14-051</p>	<p>2-3/8" Backset, Deadlatch Square corner, 1-1/8" x 2-1/4"</p>	
<p>14-050</p>	<p>3-3/4" Backset, Deadlatch Square corner, 1-1/8" x 2-1/4"</p>	
<p>43-001</p>	<p>5" Backset extension link, Deadlatch</p>	
<p>39-030</p>	<p>Rabbeted latch and strike kit, 605 and 626 only. Adapts square corner latch and 2-3/4" square corner strike to 1/2" rabbeted door and frame.</p>	<p>no image available</p>

Pricing/product description subject to change without notice.

Mortise Lock Armor Front (Mortise/Mortise Deadbolt Chassis)

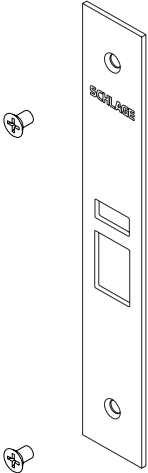
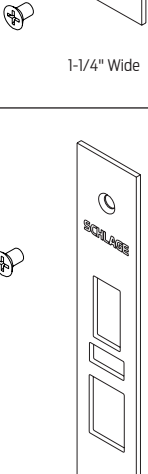
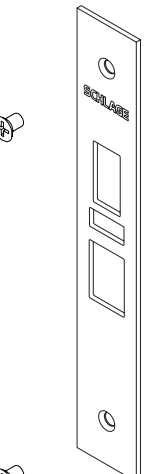
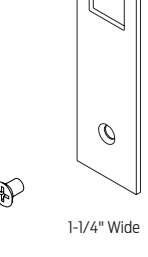
<p>09-663</p>	<p>1-1/4" Wide Square Corner, Latch for MS</p>	
<p>09-669</p>	<p>1-1/16" Wide Square Corner, Latch, options for MS</p>	
<p>09-666</p>	<p>1-1/4" Wide Square Corner, Latch x Deadbolt for MD</p>	
<p>09-672</p>	<p>1-1/16" Wide Square Corner, Latch x Deadbolt, Options for MD</p>	

Notes: 30. For 1-3/4" thick doors, use wide armor front. For over 1-3/4" thick door extended equally (EE), use 1-1/4" wide armor front
 31. Available finishes are 605, 606, 612, 619, 625, and 626.
 32. Images not shown to scale. Consult AD-Series Parts Guide for more information.

Strike Plate (Cylindrical Chassis)

10-025	1-3/16" Lip, ANSI, no box, 1-1/4" x 4-7/8",	
10-013	1-1/8" Lip, Square Corner, T-strike, box, 1-1/8" - 2-3/4", 1-1/2" Lip available, must specify 1-1/2" Lip	
10-016	1-1/8" Lip, Square Corner, T-strike, deep box, fire door latch	
K510-066	Box for ANSI strike (Must be specific)	
10-072	1-3/16" Lip, 1-1/4" x 4-7/8", Square Corner, box	
10-072	7/8", 1", 1-1/2", 1-3/4", or 2" Lip, 1-1/4" x 4-7/8", Square Corner, box	
10-075	1/2" Rabbeted, For 1-3/4" thick doors, use wide armor front. For over 1-3/4" thick door extended equally (EE) use 1-1/4" wide armor front.	
37-015	Strike Frame Reinforcer, specify 37-015	
XL11-820	One hole for latching functions, RH & LHR doors Lip 1-3/16"	
XL11-821	One hole for latching functions, LH & RHR doors Lip 1-3/16"	
XQ07-351-134	Strike, ANSI, No Box, 1-1/4" x 4-7/8", 1-3/4" Lip Length	Image not available
XQ03-494-134	Strike, Square Corner, T-strike, Box, 1-1/8" x 2-3/4", 1-3/4" Lip	Image not available

Note: 33. XL11-820 & XL11-821 Extended lead time; contact customer service.

Door Thickness

1-3/4"	1-3/4"
1-3/8"	1-3/8" to 2-3/4", Shims included (Specify in 1/8" increments)

- Notes:**
- 34. *Door Thickness Kits are available on page 215 to install a lock on a door that is thicker or thinner than 1-3/4". See AD-Series Parts guide for details. Locks cannot be installed on doors thicker than 2-3/4" or thinner than 1-3/8".*
 - 35. *Thin Door Shims are available on page 215 to install a lock on a door that is thinner than 1-3/4".*
 - 36. *Decorative Plates are used to cover exposed holes when retrofitting from existing locks to AD-Series locks. The size of plate required will vary based on the size and location of holes being covered. Retrofit information can be found at www.schlage.com/support.*
 - 37. *If under the lock decorative plates are on both sides of device, then door will become 1/8" thicker. A Door Thickness Kit of an incremental 1/8" must be ordered to accommodate under the lock plates.*

System Architecture for AD-300 & AD-400

The AD-Series combines all the hardware components required at the door for a complete access control system into one integrated design to simplify installation. This includes the electrified lock, credential reader, request-to-exit and -enter sensors, door position switch, tamper guard and more.

The AD-Series is available with flexible hardwired and wireless networked options and can accommodate Wiegand, Clock & Data or RS485 connections to the access control panel or reader interface board.

The following system configurations should be utilized as a guideline for specifying the AD-Series. Datasheets with technical specifications are available for download on www.schlage.com/support. We suggest that you consult with your Access Control Provider to verify the specific features, functions and capabilities of the AD-Series.

AD-300 Networked Hardwired Solution:

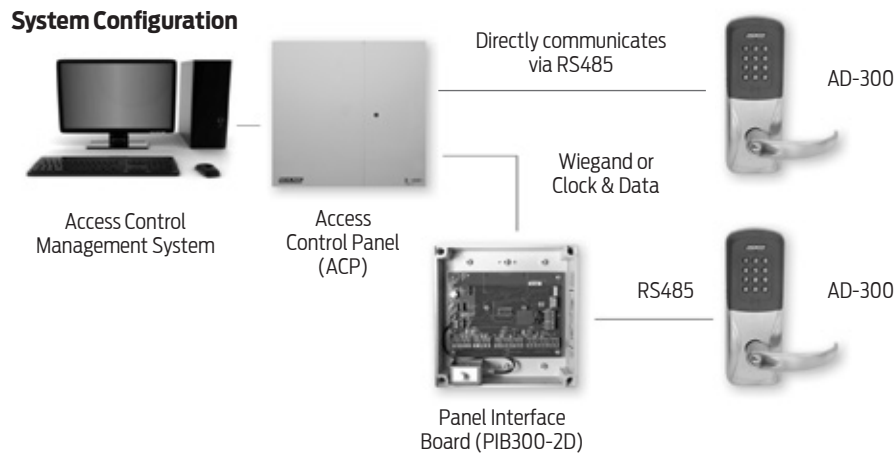

- Connections other than Wiegand or Clock & Data may incur an additional fee. Consult access control software provides for details.
- PIB300-2D required for Wiegand or Clock & Data connection; supports up to 2 AD-300 devices

AD-400 Networked Wireless Solution:

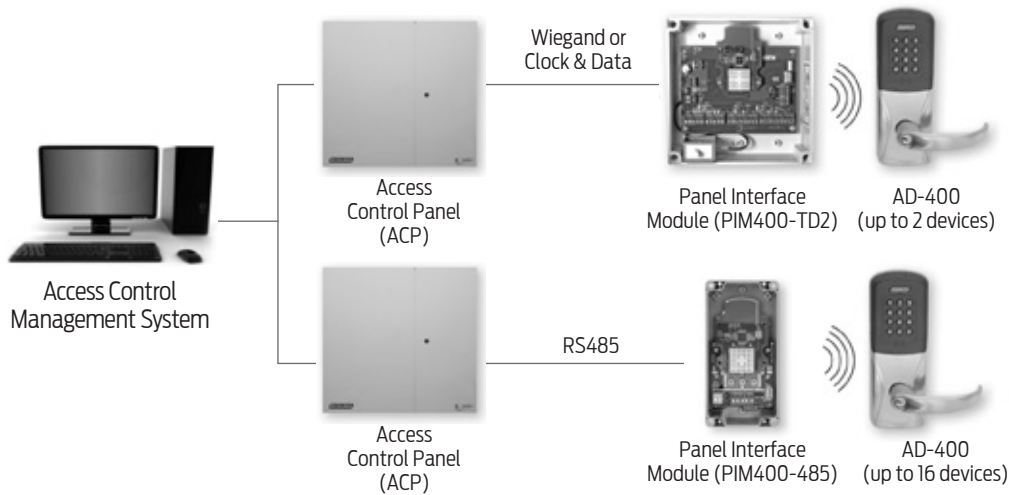

- Connections other than Wiegand or Clock & Data may incur an additional fee. Consult access control software provides for details.
- PIM400-TD2 required for Wiegand or Clock & Data connection; supports up to 2 AD-400 devices
- If RS485 connection to other ACP is required, contact software provider

System Architecture for AD-302 & AD-402

FIPS 201 Overview

- Federal Government Standard for secure and reliable form of identification
- Mandated by Homeland Security Presidential Directive 12 (HSPD 12)
- Required for all Federal Government employees and contractors
- Mandates the type of Smart Card and Card Reader per application
- The WPR401 (wireless portable reader) is available for remote credential verification

In order to meet requirements, the AD-Series can either be:

- 1.) Sold as a complete unit with the FMK Multi-Technology + Keypad Reader
- 2.) Field upgraded to a FIPS 201-2 compliant solution by adding the FMK reader (sold separately) and by utilizing the most current firmware available.

AD-302 Hardwired FIPS 201-2 compliant solution

- RS-485 or Wiegand communication to access control panel (ACP must be FIPS 201-2 compliant)
- FIPS 201-2 Multi-Technology Reader (FMK)

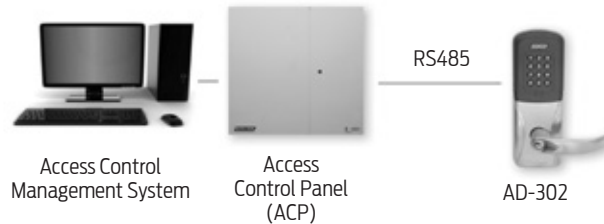

AD-402 Wireless FIPS 201-2 compliant solution

- 900 MHz communication between lock and PIM400-TD2
- FIPS Multi-Technology Reader (FMK)
- Connections other than Wiegand or Clock & Data may incur an additional fee. Consult access control software provider for details.
- f RS485 connection to ACP is required, contact software provider

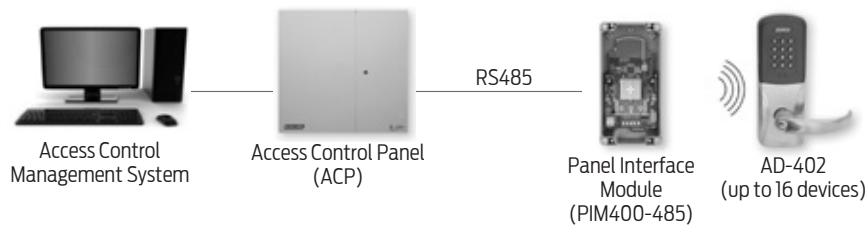

Customer Name: _____

Customer Address: _____

Ship To: _____

Account #: _____

Quote #: _____

PO # & Date: _____

Price book #: _____

Shipping Instructions: _____

Requested Ship Date: _____

Order Written By: _____

**For Further Information Contact
(Name, Phone, Fax)** _____

	Quantity	1. Series	2. Class	3. Chassis ¹	4. Function ²	5. Reader ³	6. Lever	7. Finish	8. Cylinder	9. Keyway	10. Handing	11. Battery ⁴	12. Backset & Latch ⁵ or Armor Front ⁶	13. Strike ⁷	14. Door Thickness ⁸	15. Options
Ex.	1	AD	400	CY	70	KP	SPA	626	PD	SI23	RH	4B	13-247	10-025	1-3/4	BAA

Please complete all information above and email order to:
Order_Entry_Schlage_Commercial@allegion.com

¹ If Exit trim is chosen, no selections are required for options #12 & #13
² Function: 70 classroom storeroom is standard if no selection is made
³ Reader: KP keypad is standard if no selection is made
⁴ Battery: Cover only standard for AD-300, 4B standard if no selection is made for AD-400
⁵ Backset & Latch: 13-247 standard for cylindrical if no selection is made
⁶ Armor Front: 09-663 standard for mortise if no selection is made, 09-666 standard for mortise deadbolt if no selection is made
⁷ Strike Plate: 10-025 standard for cylindrical if no selection is made, 10-072 standard for mortise/mortise deadbolt if no selection is made
⁸ Door Thickness: 1-3/4" standard if no selection is made

Pricing/product description subject to change without notice.

AD-300 Networked Hardwired - Cylindrical



1-4. Select Chassis/Function Note: Locking function capabilities are determined by users access control system

AD-300-CY-70*	Classroom/Storeroom	\$1,847.00
AD-300-CY-50*	Office △	\$1,857.00
AD-300-CY-40	Privacy △	\$1,857.00
AD-300-CY-60	Apartment △	\$1,857.00

* Less Door Position Switch, use suffix LDP. Deduct \$19.50

△ Requires RS485 connection to ACP. See page 87 for system diagram. Check with access control software provider to verify function is enabled.



AD-300-CY-70-MT



KP



MG



MGK



MS



MSK



MTK/SIK/FMK



MT/SI

5. Select Reader Note: Reflects list price adder to base keypad reader price of \$537.00.

LLL	Less Reader (For reader module accessories sold separately, see page 156)	DEDUCT \$537.00
KP	Keypad	STANDARD
MS	Magnetic Stripe (Swipe)	\$100.00
MSK	Magnetic Stripe (Swipe) + Keypad	\$166.00
MG	Magnetic Stripe (Insert)	\$116.00
MGK	Magnetic Stripe (Insert) + Keypad	\$184.00
MT	Multi-Technology Proximity and Smart Card	\$199.00
MTK	Multi-Technology + Keypad Proximity and Smart Card	\$264.00
SI	Smart Technology iClass Compatible Reader	\$348.00
SIK	Smart Technology iClass Compatible Reader + Keypad	\$410.00

FIPS 201-2 Compliant when applied with the FIPS Multi-Technology plus keypad reader module (FMK) and by utilizing the most current firmware available. See page 156 for the FMK reader module.

6. Select Lever*

LLL	Less interior and exterior levers	DEDUCT \$46.40
Standard Options	SPA (Sparta), RHO (Rhodes), ATH (Athens), TLR (Tubular), BRW, (Broadway), BRK (Boardwalk), LAT (Latitude), LON (Longitude)	N/C

* Tactile Warning use 8AT for Athens, 8RO for Rhodes, 8SP for Sparta and 8TR for Tubular. \$45.60 per lever. Applied to exterior lever only unless otherwise specified. Not available with 643e finish.

7. Select Finish

626	Satin Chrome	N/C
605	Bright Brass	\$139.00
606	Satin Brass	\$139.00
612	Satin Bronze	\$139.00
619	Satin Nickel	\$139.00
625	Bright Chrome	\$139.00
643e	Aged Bronze	\$139.00
626AM	Satin Chrome Antimicrobial	\$179.00

8. Select Cylinder Type

P ● △	With Cylinder, Schlage- (Everest 29 S123, 6 Pin KIL standard)	N/C
L	Less Cylinder, Schlage, Falcon, 6 Pin KIL	DEDUCT \$64.00
R ● □	With Cylinder, Schlage 6-Pin (Everest 29 S123 standard) FSIC	\$38.00
J	Less Cylinder, Schlage, 6 Pin FSIC	DEDUCT \$35.00
G ● □	With Cylinder, Schlage 7-Pin (Everest 29R standard) (factory master keyed only) SFIC	\$84.00
B	Less Cylinder, Schlage, Falcon, Competitive OEM's, 7 Pin (SFIC)	N/C
L SAR	Less Cylinder, Sargent (10L + 11L), 6 Pin KIL	DEDUCT \$64.00
L CO6	Less Cylinder, Corbin 8000, 6 Pin KIL	DEDUCT \$64.00
J SAR	Less Cylinder, Sargent 6300, 6 Pin FSIC	DEDUCT \$35.00
J CO6	Less Cylinder, Corbin 8000, 6 Pin FSIC	DEDUCT \$35.00
J CO7	Less Cylinder, Corbin 8000-7, 7 Pin FSIC, (Only RHO, 8RO, SPA, 8SP, TLR and 8TR)	DEDUCT \$35.00
J MED	Less Cylinder, Medeco 32*0201, 6 Pin FSIC (Only RHO, 8RO, SPA, 8SP lever styles)	DEDUCT \$35.00
J YA6	Less Cylinder, Yale 1210 or Medeco 31*0100, 6 Pin FSIC	DEDUCT \$35.00
J YA7	Less Cylinder, Yale 1220, 7 Pin FSIC (Only RHO, 8RO, SPA, 8SP lever styles)	DEDUCT \$35.00
L FA7	Less Cylinder, Falcon, 7 Pin, KIL (Only RHO, 8RO, SPA, 8SP lever styles)	DEDUCT \$35.00

● Master Keyed cylinders can be specified and will be shipped in lock packaging. For Master Keying System Summary form which should accompany the master keyed order, see page 283.

△ For Master Keying, additional line item 50-210 is required, \$20.10 each.

□ Control Keys for installation/removal of interchangeable cores are not furnished and must be ordered separate.

For additional assistance on Master Keying as well as restricted keyways please contact customer service.

Pricing/product description subject to change without notice.

Full Cylinder
PD LD LDSAR LDFA7

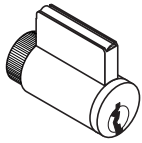

Full Size
Interchangeable Core
RD JD JD SAR JD CO6 JD YA6
JD CO7

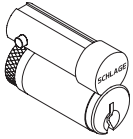

Small Format
Interchangeable Core
GD BD

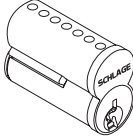

9. Select Keying Type

Open Keyway Families: KIL or FSIC ²		
S123	Everest 29 S (Key in Lever or FSIC)	STANDARD
C123	Everest C	N/C
C/CE/E/EF/ F/ FG/ G	Classic Obverse	N/C
Restricted Keyway Families: KIL or FSIC ^{1,2}		
29 T	Everest 29 T	\$17.50
D	Everest D	\$17.50
Classic Restricted	Quad, Numbered, Reverse	\$17.50
Restricted Keyway Families: SFIC ³		
29 R	Everest 29 R	N/C
B	Everest B	N/C

¹ Everest Restricted Keyways require a Letter of Authorization to be submitted with the order. See sample Letter of Authorization, see page 295.

² Full Size key systems (Everest 29 S & T, Everest C & D, Obverse & Quad) are available in Primus and Primus XP key system and must be ordered separately. Lock should be ordered less cylinder and Primus cylinder should be a separate line.

³ Master Keyed cylinders can be specified and will be shipped in lock packaging. For Master Keying System Summary form which should accompany the master keyed order, see page 283.

10. Select Handing (Field Reversible)

RH	Right Handed	N/C
LH	Left Handed	N/C
RHR	Right Handed Reverse	N/C
LHR	Left Handed Reverse	N/C

11. Select Battery

Cover Only	No batteries or holder	STANDARD
-------------------	------------------------	-----------------

12. Select Backset & Latchbolt

LLL	Less Latch	DEDUCT \$34.20
13-247	2-3/4" Backset, Deadlatch, Square corner, 1-1/8" x 2-1/4"	STANDARD
14-049	2-3/4" Backset, Deadlatch Anti-friction fire door latch, Square corner, 1-1/8" x 2-1/4", 3/4" throw	\$181.00
14-051	2-3/8" Backset, Deadlatch Square corner, 1-1/8" x 2-1/4"	N/C
14-050	3-3/4" Backset, Deadlatch Square corner, 1-1/8" x 2-1/4"	\$10.70
43-001	5" Backset extension link, Deadlatch	\$33.10
39-030*	Rabbeted latch and strike kit, 605 and 626 only	\$59.10

* Adapts square corner latch and 2-3/4" square corner strike to 1/2" rabbeted door and frame.

13. Select Strike Plate

LLL	Less Strike Plate	DEDUCT \$4.50
10-025	1-3/16" Lip, ANSI, no box, 1-1/14" x 4-7/8"	STANDARD
10-013*	1-1/8" Lip, Square Corner, T-strike, box, 1-1/8" - 2-3/4"	N/C
10-016	1-1/8" Lip, Square Corner, T-strike, deep box, fire door latch	\$15.70
K510-066	Box for ANSI strike (Must be specific)	N/C

* 1-1/2" Lip available, must specify 1-1/2" Lip \$8.00

14. Select Door Thickness

134	1-3/4"	STANDARD
Example 138	1-3/8" to 2-3/4", Shims included (Specify in 1/8" increments)	\$58.90

15. Select Options

BAA	BAA Compliant Product	\$115.00
------------	-----------------------	-----------------

BAA compliant products must have the cover letter on page 301 included with the order. Failure to use this cover letter will result in the customer receiving non-BAA compliant product with no recourse for an RMA or refund. BAA compliant product requires a longer lead time, please contact customer service for details.

Notes: 1) Connections other than Wiegand or Clock & Data may incur additional fee. Consult access control software provider for details.

2) Add PIB300-2D if Wiegand or Clock and Data connection to ACP is required. Sold Separately. See page 118 for details.

Accessories available, see pages 116-119.

Accessories include Panel Interface Board (PIB300-2D) Decorative Plates, Handheld Device, etc.

Credentials available, see pages 26-31.

Pricing/product description subject to change without notice.

AD-300 Networked Hardwired - Mortise/Mortise Deadbolt



1-3. Select Chassis

AD-300-MS	Mortise	\$2,121.00
AD-300-MD	Mortise Deadbolt Δ	\$2,156.00



AD-300-MS-70-MTK



KP



MG



MGK



MS



MSK



MT/SI



MTK/SIK/FMK

4. Select Function **Note:** Locking function capabilities are determined by users access control system

70*	Classroom/Storeroom (Not available on mortise deadbolt)	STANDARD
50*	Office Δ (Not available on mortise deadbolt)	\$10.00
40	Privacy Δ \blacksquare	\$10.00
60	Apartment Δ \blacksquare	\$10.00

* Less Door Position Switch, use suffix LDP. Deduct \$19.50

Δ Requires RS485 connection to ACP. See page 87 for system diagram. Check with access control software provider to verify function is enabled.

\blacksquare Inside Push Button (IPB) only included with Mortise (MS) chassis. Mortise deadbolt (MD) chassis comes with LED indicator only. \$10 charge does not apply to mortise deadbolt (MD) chassis.

5. Select Reader **Note:** Reflects list price adder to base keypad reader price of \$537.00.

LLL	Less Reader (For reader module accessories sold separately, see page 156)	DEDUCT \$537.00
KP	Keypad	STANDARD
MS	Magnetic Stripe (Swipe)	\$100.00
MSK	Magnetic Stripe (Swipe) + Keypad	\$166.00
MG	Magnetic Stripe (Insert)	\$116.00
MGK	Magnetic Stripe (Insert) + Keypad	\$184.00
MT	Multi-Technology Proximity and Smart Card	\$199.00
MTK	Multi-Technology + Keypad Proximity and Smart Card	\$264.00
SI	Smart Technology iClass Compatible Reader	\$348.00
SIK	Smart Technology iClass Compatible Reader + Keypad	\$410.00

FIPS 201-2 Compliant when applied with the FIPS Multi-Technology plus keypad reader module (FMK) and by utilizing the most current firmware available. See page 156 for the FMK reader module.

6. Select Lever*

LLL	Less interior and exterior levers	DEDUCT \$65.00
Standard Options	SPA (Sparta), RHO (Rhodes), ATH (Athens), TLR (Tubular), BRW, (Broadway), BRK (Boardwalk), LAT (Latitude), LON (Longitude)	N/C

* Tactile Warning use 8AT for Athens, 8RO for Rhodes, 8SP for Sparta and 8TR for Tubular. \$45.60 per lever. Applied to exterior lever only unless otherwise specified. Not available with 643e finish.

7. Select Finish

626	Satin Chrome	N/C
605	Bright Brass	\$139.00
606	Satin Brass	\$139.00
612	Satin Bronze	\$139.00
619	Satin Nickel	\$139.00
625	Bright Chrome	\$139.00
643e	Aged Bronze	\$139.00
626AM	Satin Chrome Antimicrobial	\$179.00

8. Select Cylinder Type

P \bullet Δ	With Cylinder, Schlage- (Everest 29 S123, 6 Pin KIL standard)	N/C
L	Less Cylinder, Schlage, Falcon, 6 Pin KIL	DEDUCT \$64.00
R \bullet \square	With Cylinder, Schlage 6-Pin (Everest 29 S123 standard) FSIC	\$38.00
J	Less Cylinder, Schlage, 6 Pin FSIC	DEDUCT \$35.00
G \bullet \square	With Cylinder, Schlage 7-Pin (Everest 29R standard) (factory master keyed only) SFIC	\$84.00
B	Less Cylinder, Schlage, Falcon, Competitive OEM's, 7 Pin (SFIC)	N/C
LSAR	Less Cylinder, Sargent (10L + 11L), 6 Pin KIL	DEDUCT \$64.00
L CO6	Less Cylinder, Corbin 8000, 6 Pin KIL	DEDUCT \$64.00
JSAR	Less Cylinder, Sargent 6300, 6 Pin FSIC	DEDUCT \$35.00
J CO6	Less Cylinder, Corbin 8000, 6 Pin FSIC	DEDUCT \$35.00
J CO7	Less Cylinder, Corbin 8000-7, 7 Pin FSIC, (Only RHO, 8RO, SPA, 8SP, TLR and 8TR)	DEDUCT \$35.00
J MED	Less Cylinder, Medeco 32*0201, 6 Pin FSIC (Only RHO, 8RO, SPA, 8SP lever styles)	DEDUCT \$35.00
J YA6	Less Cylinder, Yale 1210 or Medeco 31*0100, 6 Pin FSIC	DEDUCT \$35.00
J YA7	Less Cylinder, Yale 1220, 7 Pin FSIC (Only RHO, 8RO, SPA, 8SP lever styles)	DEDUCT \$35.00
L FA7	Less Cylinder, Falcon, 7 Pin, KIL (Only RHO, 8RO, SPA, 8SP lever styles)	DEDUCT \$35.00

\bullet Master Keyed cylinders can be specified and will be shipped in lock packaging. For Master Keying System Summary form which should accompany the master keyed order, see page 283.

Δ For Master Keying, additional line item 50-210 is required, \$20.10 each.

\square Control Keys for installation/removal of interchangeable cores are not furnished and must be ordered separate.

For additional assistance on Master Keying as well as restricted keyways please contact customer service.

Pricing/product description subject to change without notice.

Full Cylinder
PD LD LDSAR LDFA7

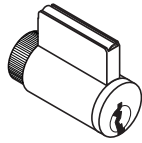

Full Size
Interchangeable Core
RD JD JD SAR JD CO6 JD YA6
JD CO7

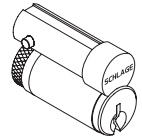

Small Format
Interchangeable Core
GD BD

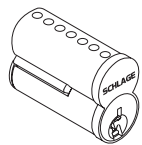

9. Select Keying Type

Open Keyway Families: KIL or FSIC ²		
S123	Everest 29 S (Key in Lever or FSIC)	STANDARD
C123	Everest C	N/C
C/CE/E/EF/F/FG/G	Classic Obverse	N/C
Restricted Keyway Families: KIL or FSIC ^{1,2}		
29 T	Everest 29 T	\$17.50
D	Everest D	\$17.50
Classic Restricted	Quad, Numbered, Reverse	\$17.50
Restricted Keyway Families: SFIC ³		
29 R	Everest 29 R	N/C
B	Everest B	N/C

¹ Everest Restricted Keyways require a Letter of Authorization to be submitted with the order. See sample Letter of Authorization, see page 295.

² Full Size key systems (Everest 29 S & T, Everest C & D, Obverse & Quad) are available in Primus and Primus XP key system and must be ordered separately. Lock should be ordered less cylinder and Primus cylinder should be a separate line.

³ Master Keyed cylinders can be specified and will be shipped in lock packaging. For Master Keying System Summary form which should accompany the master keyed order, see page 283.

10. Select Handing (Field Reversible)

RH	Right Handed	N/C
LH	Left Handed	N/C
RHR	Right Handed Reverse	N/C
LHR	Left Handed Reverse	N/C

11. Select Battery

Cover Only	No batteries or holder	STANDARD
-------------------	------------------------	-----------------

12. Select Mortise Lock Armor Front

LLL	Less Armor Front	DEDUCT \$16.80
09-663	1-1/4" Wide Square Corner, Latch for MS	STANDARD
09-669	1-1/16" Wide Square Corner, Latch, options for MS	N/C
09-666	1-1/4" Wide Square Corner, Latch x Deadbolt for MD	STANDARD
09-672	1-1/16" Wide Square Corner, Latch x Deadbolt, Options for MD	N/C

13. Select Strike Plate

LLL	Less Strike	DEDUCT \$13.20
10-072	1-1/4" x 4-7/8" Square Corner + box; 1-3/16" lip length	STANDARD
10-072xx	1-1/4" x 4-7/8" Square Corner + box; specify lip length (xx) as 1" or 1-1/2"	N/C
10-072xx	1-1/4" x 4-7/8" Square Corner + box; specify lip length (xx) as 1-3/4"	\$31.30
10-075 ●	1/2" Rabbeted	\$108.00
37-015	Strike Frame Reinforcer, specify 37-015	N/C
XL11-820 △	One hole for latching functions, RH & LHR doors Lip 1-3/16"	\$13.40
XL11-821 △	One hole for latching functions, LH & RHR doors Lip 1-3/16"	\$13.40

● For 1-3/4" thick doors, use wide armor front. For over 1-3/4" thick door extended equally (EE) use 1-1/4" wide armor front.

△ Extended leadtime, consult customer service.

14. Select Door Thickness

134	1-3/4"	STANDARD
Example 138	1-3/8" to 2-3/4", Shims included (Specify in 1/8" increments)	\$58.90

15. Select Options

BAA	BAA Compliant Product	\$115.00
------------	-----------------------	-----------------

BAA compliant products must have the cover letter on page 301 included with the order. Failure to use this cover letter will result in the customer receiving non-BAA compliant product with no recourse for an RMA or refund. BAA compliant product requires a longer lead time, please contact customer service for details.

Notes: 1) Connections other than Wiegand or Clock & Data may incur additional fee. Consult access control software provider for details.

2) Add PIB300-2D if Wiegand or Clock and Data connection to ACP is required. Sold Separately. See page 118 for details.

Accessories available, see pages 116-119.

Accessories include Panel Interface Board (PIB300-2D) Decorative Plates, Handheld Device, etc.

Credentials available, see pages 26-31.

Pricing/product description subject to change without notice.

1-3. Select Chassis/Trim Type *Note: See page 77 for exit device compatibility*

AD-300-993R	Exit Rim/Concealed Vertical Rod (Metal Door)/Concealed Vertical Cable (Metal Door)	\$2,172.00
AD-300-993S	Exit Surface Vertical Rod	\$2,201.00
AD-300-993M	Exit Mortise Lock	\$2,201.00

4. Select Function *Note: Locking function capabilities are determined by users access control system*

70*	Classroom/Storeroom	STANDARD
50*	Office \triangle	\$10.00
40	Privacy $\triangle \blacksquare$	\$10.00
60	Apartment $\triangle \blacksquare$	\$10.00

* Less Door Position Switch, use suffix LDP. Deduct \$18.90

\triangle Requires RS485 connection to ACP. See page 87 for system diagram. Check with access control software provider to verify function is enabled.

\blacksquare Inside Push Button (IPB) only included with Mortise (MS) chassis. Mortise deadbolt (MD) chassis comes with LED indicator only. \$10 charge does not apply to mortise deadbolt (MD) chassis.

5. Select Reader *Note: Reflects list price adder to base keypad reader price of \$537.00.*

LLL	Less Reader (For reader module accessories sold separately, see page 156)	DEDUCT \$537.00
KP	Keypad	STANDARD
MS	Magnetic Stripe (Swipe)	\$100.00
MSK	Magnetic Stripe (Swipe) + Keypad	\$166.00
MG	Magnetic Stripe (Insert)	\$116.00
MGK	Magnetic Stripe (Insert) + Keypad	\$184.00
MT	Multi-Technology Proximity and Smart Card	\$199.00
MTK	Multi-Technology + Keypad Proximity and Smart Card	\$264.00
SI	Smart Technology iClass Compatible Reader	\$348.00
SIK	Smart Technology iClass Compatible Reader + Keypad	\$410.00

FIPS 201-2 Compliant when applied with the FIPS Multi-Technology plus keypad reader module (FMK) and by utilizing the most current firmware available. See page 156 for the FMK reader module.

6. Select Lever*

LLL	Less interior and exterior levers	DEDUCT \$23.20
Standard Options	SPA (Sparta), RHO (Rhodes), ATH (Athens), TLR (Tubular), BRW, (Broadway), BRK (Boardwalk), LAT (Latitude), LON (Longitude)	N/C

* Tactile Warning use BAT for Athens, 8RO for Rhodes, 8SP for Sparta and 8TR for Tubular. \$45.60 per lever. Applied to exterior lever only unless otherwise specified. Not available with 643e finish.

7. Select Finish

626	Satin Chrome	N/C
605	Bright Brass	\$139.00
606	Satin Brass	\$139.00
612	Satin Bronze	\$139.00
619	Satin Nickel	\$139.00
625	Bright Chrome	\$139.00
643e	Aged Bronze	\$139.00
626AM	Satin Chrome Antimicrobial	\$179.00

8. Select Cylinder Type

P $\bullet \triangle$	With Cylinder, Schlage- (Everest 29 S123, 6 Pin KIL standard)	N/C
L	Less Cylinder, Schlage, Falcon, 6 Pin KIL	DEDUCT \$64.00
R $\bullet \square$	With Cylinder, Schlage 6-Pin (Everest 29 S123 standard) FSIC	\$38.00
J	Less Cylinder, Schlage, 6 Pin FSIC	DEDUCT \$35.00
G $\bullet \square$	With Cylinder, Schlage 7-Pin (Everest 29R standard) (factory master keyed only) SFIC	\$84.00
B	Less Cylinder, Schlage, Falcon, Competitive OEM's, 7 Pin (SFIC)	N/C
L SAR	Less Cylinder, Sargent (10L + 11L), 6 Pin KIL	DEDUCT \$64.00
L CO6	Less Cylinder, Corbin 8000, 6 Pin KIL	DEDUCT \$64.00
J SAR	Less Cylinder, Sargent 6300, 6 Pin FSIC	DEDUCT \$35.00
J CO6	Less Cylinder, Corbin 8000, 6 Pin FSIC	DEDUCT \$35.00
J CO7	Less Cylinder, Corbin 8000-7, 7 Pin FSIC, (Only RHO, 8RO, SPA, 8SP, TLR and 8TR)	DEDUCT \$35.00
J MED	Less Cylinder, Medeco 32*0201, 6 Pin FSIC (Only RHO, 8RO, SPA, 8SP lever styles)	DEDUCT \$35.00
J YA6	Less Cylinder, Yale 1210 or Medeco 31*0100, 6 Pin FSIC	DEDUCT \$35.00
J YA7	Less Cylinder, Yale 1220, 7 Pin FSIC (Only RHO, 8RO, SPA, 8SP lever styles)	DEDUCT \$35.00
L FA7	Less Cylinder, Falcon, 7 Pin, KIL (Only RHO, 8RO, SPA, 8SP lever styles)	DEDUCT \$35.00

\bullet Master Keyed cylinders can be specified and will be shipped in lock packaging. For Master Keying System Summary form which should accompany the master keyed order, see page 283.

\triangle For Master Keying, additional line item 50-210 is required, \$20.10 each.

\square Control Keys for installation/removal of interchangeable cores are not furnished and must be ordered separate.

For additional assistance on Master Keying as well as restricted keyways please contact customer service.



AD-300-993R-70-MTK



MG



MGK



MS



MSK



MT/SI



MTK/SIK/FMK

Full Cylinder
PD LD LDSAR LDA7

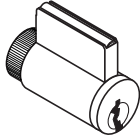

Full Size Interchangeable Core
RD JD JD SAR JD CO6 JD YA6 JD CO7

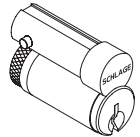

Small Format Interchangeable Core
GD BD

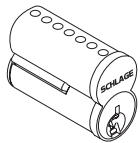

9. Select Keying Type

Open Keyway Families: KIL or FSIC ²		
S123	Everest 29 S (Key in Lever or FSIC)	STANDARD
C123	Everest C	N/C
C/CE/E/EF/ F/ FG/ G	Classic Obverse	N/C
Restricted Keyway Families: KIL or FSIC ^{1,2}		
29 T	Everest 29 T	\$17.50
D	Everest D	\$17.50
Classic Restricted	Quad, Numbered, Reverse	\$17.50
Restricted Keyway Families: SFIC ³		
29 R	Everest 29 R	N/C
B	Everest B	N/C

¹ Everest Restricted Keyways require a Letter of Authorization to be submitted with the order. See sample Letter of Authorization, see page 295.

² Full Size key systems (Everest 29 S & T, Everest C & D, Obverse & Quad) are available in Primus and Primus XP key system and must be ordered separately. Lock should be ordered less cylinder and Primus cylinder should be a separate line.

³ Master Keyed cylinders can be specified and will be shipped in lock packaging. For Master Keying System Summary form which should accompany the master keyed order, see page 283.

10. Select Handing (Field Reversible)

RHR	Right Handed Reverse	N/C
LHR	Left Handed Reverse	N/C

11. Select Battery

Cover Only	No batteries or holder	STANDARD
-------------------	------------------------	-----------------

12.-13. No Selection Required

14. Select Door Thickness

134	1-3/4"	STANDARD
Example 138	1-3/8" to 2-3/4", (Specify in 1/8" increments)	\$58.90

15. Select Options

LRX	Less Von Duprin low current Request-To-Exit switch	DEDUCT \$52.00
BAA	BAA Compliant Product	\$115.00

BAA compliant products must have the cover letter on page 301 included with the order. Failure to use this cover letter will result in the customer receiving non-BAA compliant product with no recourse for an RMA or refund. BAA compliant product requires a longer lead time, please contact customer service for details.

AD-300 Exit Trim comes with a universal mounting plate and is compatible with Von Duprin Series 98/99, 98/99XP, 22/22F exit devices and Falcon 25 rim exit devices with proper low current Request-To-Exit switch (RX-LC). Concealed Vertical Rod and Concealed Vertical Cable trim on metal door only. **When Request-to-exit is required, the Von Duprin RX-LC switch (part #050281) or Falcon AE switch (part #650359) must be used or the Warranty is void.**

Note: AD-Series Non-Functioning "Dummy" Exit Trim now available. Please see pages 114-115 for details

Notes: 1) Connections other than Wiegand or Clock & Data may incur additional fee. Consult access control software provider for details.

2) Add PIB300-2D if Wiegand or Clock and Data connection to ACP is required. Sold Separately. See page 118 for details.

Accessories available, see pages 116-119.

Accessories include Panel Interface Board (PIB300-2D) Decorative Plates, Handheld Device, etc.

Credentials available, see pages 26-31.

1-4. Select Chassis/Function

Note: Locking function capabilities are determined by users access control system

AD-302-CY-70*	Classroom/Storeroom	\$1,847.00
AD-302-CY-50*	Office	\$1,857.00
AD-302-CY-40	Privacy△	\$1,857.00
AD-302-CY-60	Apartment△	\$1,857.00

* Less Door Position Switch, use suffix LDP. Deduct \$19.50

△ Requires RS485 connection to ACP. See page 88 for system diagram. Check with Access Control software provider to verify function is enabled.

AD-SERIES

Networked

Standalone



AD-302-CY-70-FMK

5. Select Reader

FMK	FIPS 201-2 Multi-Technology + Keypad Proximity and Smart Card (PIV & PIV-I Card)	\$473.00
------------	--	-----------------

Note: The AD-300 lock can be field upgraded to a FIPS 201-2 compliant solution simply by adding the FMK reader (sold separately) and by using the most current firmware revision.

Note: Verify compatibility of PIV & PIV-I credentials with access control software provider.

6. Select Lever*

LLL	Less interior and exterior levers	\$46.40
SPA	Sparta	N/C
RHO	Rhodes	N/C
ATH	Athens	N/C
TLR	Tubular	N/C
BRW	Broadway	N/C
BRK	Boardwalk	N/C
LAT	Latitude	N/C
LON	Longitude	N/C

* Tactile Warning use BAT for Athens, BRO for Rhodes, BSP for Sparta and BTR for Tubular. \$45.60 per lever. Applied to exterior lever only unless otherwise specified. Not available with 643e finish.

7. Select Finish

626	Satin Chrome	N/C
605	Bright Brass	\$139.00
606	Satin Brass	\$139.00
612	Satin Bronze	\$139.00
619	Satin Nickel	\$139.00
625	Bright Chrome	\$139.00
643e	Aged Bronze	\$139.00
626AM	Satin Chrome Antimicrobial	\$179.00

8. Select Cylinder Type

P ●△	With Cylinder, Schlage- (Everest 29 S123, 6 Pin KIL standard)	N/C
L	Less Cylinder, Schlage, Falcon, 6 Pin KIL	DEDUCT \$64.00
R ●□	With Cylinder, Schlage 6-Pin (Everest 29 S123 standard) FSIC	\$38.00
J	Less Cylinder, Schlage, 6 Pin FSIC	DEDUCT \$35.00
G ●□	With Cylinder, Schlage 7-Pin (Everest 29R standard) (factory master keyed only) SFIC	\$84.00
B	Less Cylinder, Schlage, Falcon, Competitive OEM's, 7 Pin (SFIC)	N/C
LSAR	Less Cylinder, Sargent (10L + 11L), 6 Pin KIL	DEDUCT \$64.00
LCO6	Less Cylinder, Corbin 8000, 6 Pin KIL	DEDUCT \$64.00
JSAR	Less Cylinder, Sargent 6300, 6 Pin FSIC	DEDUCT \$35.00
JCO6	Less Cylinder, Corbin 8000, 6 Pin FSIC	DEDUCT \$35.00
JCO7	Less Cylinder, Corbin 8000-7, 7 Pin FSIC, (Only RHO, 8RO, SPA, 8SP, TLR and 8TR)	DEDUCT \$35.00
JMED	Less Cylinder, Medeco 32*0201, 6 Pin FSIC (Only RHO, 8RO, SPA, 8SP lever styles)	DEDUCT \$35.00
JYA6	Less Cylinder, Yale 1210 or Medeco 31*0100, 6 Pin FSIC	DEDUCT \$35.00
JYA7	Less Cylinder, Yale 1220, 7 Pin FSIC (Only RHO, 8RO, SPA, 8SP lever styles)	DEDUCT \$35.00
LFA7	Less Cylinder, Falcon, 7 Pin, KIL (Only RHO, 8RO, SPA, 8SP lever styles)	DEDUCT \$35.00

● Master Keyed cylinders can be specified and will be shipped in lock packaging. For Master Keying System Summary form which should accompany the master keyed order, see page 283.

△ For Master Keying, additional line item 50-210 is required, \$20.10 each.

□ Control Keys for installation/removal of interchangeable cores are not furnished and must be ordered separate.

For additional assistance on Master Keying as well as restricted keyways please contact customer service.

Full Cylinder
PD LD LDSAR LDFA7

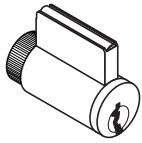

Full Size Interchangeable Core
RD JD JD SAR JD CO6 JD YA6 JD CO7

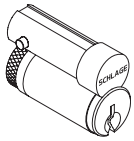

Small Format Interchangeable Core
GD BD

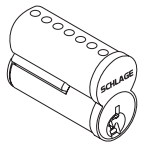

9. Select Keying Type

Open Keyway Families: KIL or FSIC ²		
S123	Everest 29 S (Key in Lever or FSIC)	STANDARD
C123	Everest C	N/C
C/CE/E/EF/ F/ FG/ G	Classic Obverse	N/C
Restricted Keyway Families: KIL or FSIC ^{1,2}		
29 T	Everest 29 T	\$17.50
D	Everest D	\$17.50
Classic Restricted	Quad, Numbered, Reverse	\$17.50
Restricted Keyway Families: SFIC ³		
29 R	Everest 29 R	N/C
B	Everest B	N/C

¹ Everest Restricted Keyways require a Letter of Authorization to be submitted with the order. See sample Letter of Authorization, see page 295.

² Full Size key systems (Everest 29 S & T, Everest C & D, Obverse & Quad) are available in Primus and Primus XP key system and must be ordered separately. Lock should be ordered less cylinder and Primus cylinder should be a separate line.

³ Master Keyed cylinders can be specified and will be shipped in lock packaging. For Master Keying System Summary form which should accompany the master keyed order, see page 283.

10. Select Handing (Field Reversible)

RH	Right Handed	N/C
LH	Left Handed	N/C
RHR	Right Handed Reverse	N/C
LHR	Left Handed Reverse	N/C

11. Select Battery

Cover Only	No batteries or holder	STANDARD
-------------------	------------------------	-----------------

12. Select Backset & Latchbolt

LLL	Less Latch	DEDUCT \$34.20
13-247	2-3/4" Backset, Deadlatch, Square corner, 1-1/8" x 2-1/4"	STANDARD
14-049	2-3/4" Backset, Deadlatch Anti-friction fire door latch, Square corner, 1-1/8" x 2-1/4", 3/4" throw	\$181.00
14-051	2-3/8" Backset, Deadlatch Square corner, 1-1/8" x 2-1/4"	N/C
14-050	3-3/4" Backset, Deadlatch Square corner, 1-1/8" x 2-1/4"	\$10.70
43-001	5" Backset extension link, Deadlatch	\$33.10
39-030*	Rabbeted latch and strike kit, 605 and 626 only	\$58.10

* Adapts square corner latch and 2-3/4" square corner strike to 1/2" rabbeted door and frame.

13. Select Strike Plate

LLL	Less Strike Plate	DEDUCT \$4.50
10-025	1-3/16" Lip, ANSI, no box, 1-1/14" x 4-7/8"	STANDARD
10-013**	1-1/8" Lip, Square Corner, T-strike, box, 1-1/8" - 2-3/4"	N/C
10-016	1-1/8" Lip, Square Corner, T-strike, deep box, fire door latch	\$15.70
K510-066	Box for ANSI strike (Must be specific)	N/C

** 1-1/2" Lip available, must specify 1-1/2" Lip \$8.00

14. Select Door Thickness

134	1-3/4"	STANDARD
Example 138	1-3/8" to 2-3/4", Shims included (Specify in 1/8" increments)	\$58.90

15. Select Options

BAA	BAA Compliant Product	\$115.00
------------	-----------------------	-----------------

BAA compliant products must have the cover letter on page 301 included with the order. Failure to use this cover letter will result in the customer receiving non-BAA compliant product with no recourse for an RMA or refund. BAA compliant product requires a longer lead time, please contact customer service for details.

Notes: 1) Connections other than Wiegand or Clock & Data may incur additional fee. Consult access control software provider for details.

2) Add PIB300-2D if Wiegand or Clock and Data connection to ACP is required. Sold Separately. See page 118 for details.

Standard accessories available, see pages 116-119.

Standard accessories sold separately include Decorative Plates, Handheld Device, Dry Contact Board (RLBD), etc.

Pricing/product description subject to change without notice.



1-3. Select Chassis

AD-302-MS	Mortise	\$2,121.00
AD-302-MD	Mortise Deadbolt Δ	\$2,156.00



AD-302-MS-70-FMK

4. Select Function

Note: Locking function capabilities are determined by users access control system

70*	Classroom/Storeroom (Not available on mortise deadbolt)	STANDARD
50*	Office Δ (Not available on mortise deadbolt)	\$10.00
40	Privacy Δ	\$10.00
60	Apartment Δ	\$10.00

* Less Door Position Switch, use suffix LDP. Deduct \$19.50

Δ Requires RS485 connection to ACP. See page 88 for system diagram. Check with access control software provider to verify function is enabled.

5. Select Reader

FMK	FIPS 201-2 Multi-Technology + Keypad Proximity and Smart Card (PIV & PIV-I Card)	\$473.00
------------	--	-----------------

Note: The AD-300 lock can be field upgraded to a FIPS 201-2 compliant solution simply by adding the FMK reader (sold separately) and by using the most current firmware revision.

Note: Verify compatibility of PIV & PIV-I credentials with access control software provider.

6. Select Lever*

LLL	Less interior and exterior levers	DEDUCT \$64.90
SPA	Sparta	N/C
RHO	Rhodes	N/C
ATH	Athens	N/C
TLR	Tubular	N/C
BRW	Broadway	N/C
BRK	Boardwalk	N/C
LAT	Latitude	N/C
LON	Longitude	N/C

* Tactile Warning use 8AT for Athens, 8RO for Rhodes, 8SP for Sparta and 8TR for Tubular. \$45.60 per lever. Applied to exterior lever only unless otherwise specified. Not available with 643e finish.

7. Select Finish

626	Satin Chrome	N/C
605	Bright Brass	\$139.00
606	Satin Brass	\$139.00
612	Satin Bronze	\$139.00
619	Satin Nickel	\$139.00
625	Bright Chrome	\$139.00
643e	Aged Bronze	\$139.00
626AM	Satin Chrome Antimicrobial	\$179.00

8. Select Cylinder Type

P $\bullet \Delta$	With Cylinder, Schlage- (Everest 29 S123, 6 Pin KIL standard)	N/C
L	Less Cylinder, Schlage, Falcon, 6 Pin KIL	DEDUCT \$64.00
R $\bullet \square$	With Cylinder, Schlage 6-Pin (Everest 29 S123 standard) FSIC	\$38.00
J	Less Cylinder, Schlage, 6 Pin FSIC	DEDUCT \$35.00
G $\bullet \square$	With Cylinder, Schlage 7-Pin (Everest 29R standard) (factory master keyed only) SFIC	\$84.00
B	Less Cylinder, Schlage, Falcon, Competitive OEM's, 7 Pin (SFIC)	N/C
L SAR	Less Cylinder, Sargent (10L + 11L), 6 Pin KIL	DEDUCT \$64.00
L CO6	Less Cylinder, Corbin 8000, 6 Pin KIL	DEDUCT \$64.00
J SAR	Less Cylinder, Sargent 6300, 6 Pin FSIC	DEDUCT \$35.00
J CO6	Less Cylinder, Corbin 8000, 6 Pin FSIC	DEDUCT \$35.00
J CO7	Less Cylinder, Corbin 8000-7, 7 Pin FSIC. (Only RHO, 8RO, SPA, 8SP, TLR and 8TR)	DEDUCT \$35.00
J MED	Less Cylinder, Medeco 32*0201, 6 Pin FSIC (Only RHO, 8RO, SPA, 8SP lever styles)	DEDUCT \$35.00
J YA6	Less Cylinder, Yale 1210 or Medeco 31*0100, 6 Pin FSIC	DEDUCT \$35.00
J YA7	Less Cylinder, Yale 1220, 7 Pin FSIC (Only RHO, 8RO, SPA, 8SP lever styles)	DEDUCT \$35.00
L FA7	Less Cylinder, Falcon, 7 Pin, KIL (Only RHO, 8RO, SPA, 8SP lever styles)	DEDUCT \$35.00

\bullet Master Keyed cylinders can be specified and will be shipped in lock packaging. For Master Keying System Summary form which should accompany the master keyed order, see page 283.

Δ For Master Keying, additional line item 50-210 is required, \$20.10 each.

\square Control Keys for installation/removal of interchangeable cores are not furnished and must be ordered separate.

For additional assistance on Master Keying as well as restricted keyways please contact customer service.

Pricing/product description subject to change without notice.

Full Cylinder
PD LD LDSAR LDA7

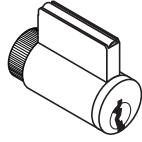

Full Size
Interchangeable Core
RD JD JD SAR JD CO6 JD YA6
JD C07

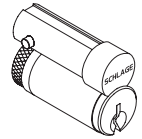

Small Format
Interchangeable Core
GD BD

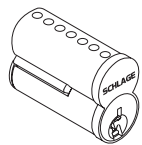

9. Select Keying Type

Open Keyway Families: KIL or FSIC ²		
S123	Everest 29 S (Key in Lever or FSIC)	STANDARD
C123	Everest C	N/C
C/CE/E/EF/ F/ FG/ G	Classic Obverse	N/C
Restricted Keyway Families: KIL or FSIC ^{1,2}		
29 T	Everest 29 T	\$17.50
D	Everest D	\$17.50
Classic Restricted	Quad, Numbered, Reverse	\$17.50
Restricted Keyway Families: SFIC ³		
29 R	Everest 29 R	N/C
B	Everest B	N/C

¹ Everest Restricted Keyways require a Letter of Authorization to be submitted with the order. See sample Letter of Authorization, see page 295.

² Full Size key systems (Everest 29 S & T, Everest C & D, Obverse & Quad) are available in Primus and Primus XP key system and must be ordered separately. Lock should be ordered less cylinder and Primus cylinder should be a separate line.

³ Master Keyed cylinders can be specified and will be shipped in lock packaging. For Master Keying System Summary form which should accompany the master keyed order, see page 283.

10. Select Handing (Field Reversible)

RH	Right Handed	N/C
LH	Left Handed	N/C
RHR	Right Handed Reverse	N/C
LHR	Left Handed Reverse	N/C

11. Select Battery

Cover Only	No batteries or holder	STANDARD
-------------------	------------------------	-----------------

12. Select Mortise Lock Armor Front

LLL	Less Armor Front	DEDUCT \$16.80
09-663	1-1/4" Wide Square Corner, Latch for MS	STANDARD
09-669	1-1/16" Wide Square Corner, Latch, options for MS	N/C
09-666	1-1/4" Wide Square Corner, Latch x Deadbolt for MD	STANDARD
09-672	1-1/16" Wide Square Corner, Latch x Deadbolt, Options for MD	N/C

13. Select Strike Plate

LLL	Less Strike	DEDUCT \$13.20
10-072	1-1/4" x 4-7/8" Square Corner + box; 1-3/16" lip length	STANDARD
10-072xx	1-1/4" x 4-7/8" Square Corner + box; specify lip length (xx) as 1" or 1-1/2"	N/C
10-072xx	1-1/4" x 4-7/8" Square Corner + box; specify lip length (xx) as 1-3/4"	\$31.30
10-075 ●	1/2" Rabbeted	\$108.00
37-015	Strike Frame Reinforcer, specify 37-015	N/C
XL11-820 △	One hole for latching functions, RH & LHR doors Lip 1-3/16"	\$13.40
XL11-821 △	One hole for latching functions, LH & RHR doors Lip 1-3/16"	\$13.40

● For 1-3/4" thick doors, use wide armor front. For over 1-3/4" thick door extended equally (EE) use 1-1/4" wide armor front.

△ Extended leadtime, consult customer service.

14. Select Door Thickness

134	1-3/4"	STANDARD
Example 138	1-3/8" to 2-3/4", Shims included (Specify in 1/8" increments)	\$58.90

15. Select Options

BAA	BAA Compliant Product	\$115.00
------------	-----------------------	-----------------

BAA compliant products must have the cover letter on page 301 included with the order. Failure to use this cover letter will result in the customer receiving non-BAA compliant product with no recourse for an RMA or refund. BAA compliant product requires a longer lead time, please contact customer service for details.

Notes: 1) Connections other than Wiegand or Clock & Data may incur additional fee. Consult access control software provider for details.
2) Add PIB300-2D if Wiegand or Clock and Data connection to ACP is required. Sold Separately. See page 118 for details.

Standard accessories available, see pages 116-119.

Standard accessories sold separately include Decorative Plates, Handheld Device, Dry Contact Board (RLBD), etc.

Pricing/product description subject to change without notice.

1-3. Select Chassis/Exit Trim Type*

AD-302-993R	Exit Rim/ ¹ Concealed Vertical Rod/ ¹ Concealed Vertical Cable	\$2,172.00
AD-302-993S	Exit Surface Vertical Rod	\$2,197.00
AD-302-993M	Exit Mortise Lock	\$2,197.00

* See page 77 for exit device compatibility. ¹ Metal door only.



AD-302-993R-70-FMK

4. Select Function Note: Locking function capabilities are determined by users access control system

70*	Classroom/Storeroom	STANDARD
50*	Office △	\$10.00
40	Privacy △	\$10.00
60	Apartment △	\$10.00

* Less Door Position Switch, use suffix LDP. Deduct \$19.50

△ Requires RS485 connection to ACP. See page 88 for system diagram. Ensure function is enabled through access control software provider.

5. Select Reader

FMK	FIPS 201-2 Multi-Technology + Keypad Proximity and Smart Card (PIV & PIV-I Card)	\$473.00
------------	--	-----------------

Note: The AD-300 lock can be field upgraded to a FIPS 201-2 compliant solution simply by adding the FMK reader (sold separately) and by using the most current firmware revision.

Note: Verify compatibility of PIV & PIV-I credentials with access control software provider.

6. Select Lever*

LLL	Less interior and exterior levers	\$23.20
SPA	Sparta	N/C
RHO	Rhodes	N/C
ATH	Athens	N/C
TLR	Tubular	N/C
BRW	Broadway	N/C
BRK	Boardwalk	N/C
LAT	Latitude	N/C
LON	Longitude	N/C

* Tactile Warning use 8AT for Athens, 8RO for Rhodes, 8SP for Sparta and 8TR for Tubular. \$45.60 per lever. Applied to exterior lever only unless otherwise specified. Not available with 643e finish.

7. Select Finish

626	Satin Chrome	N/C
605	Bright Brass	\$139.00
606	Satin Brass	\$139.00
612	Satin Bronze	\$139.00
619	Satin Nickel	\$139.00
625	Bright Chrome	\$139.00
643e	Aged Bronze	\$139.00
626AM	Satin Chrome Antimicrobial	\$179.00

8. Select Cylinder Type

P ●△	With Cylinder, Schlage- (Everest 29 S123, 6 Pin KIL standard)	N/C
L	Less Cylinder, Schlage, Falcon, 6 Pin KIL	DEDUCT \$64.00
R ●□	With Cylinder, Schlage 6-Pin (Everest 29 S123 standard) FSIC	\$38.00
J	Less Cylinder, Schlage, 6 Pin FSIC	DEDUCT \$35.00
G ●□	With Cylinder, Schlage 7-Pin (Everest 29R standard) (factory master keyed only) SFIC	\$84.00
B	Less Cylinder, Schlage, Falcon, Competitive OEM's, 7 Pin (SFIC)	N/C
L SAR	Less Cylinder, Sargent (10L + 11L), 6 Pin KIL	DEDUCT \$64.00
LC06	Less Cylinder, Corbin 8000, 6 Pin KIL	DEDUCT \$64.00
J SAR	Less Cylinder, Sargent 6300, 6 Pin FSIC	DEDUCT \$35.00
JC06	Less Cylinder, Corbin 8000, 6 Pin FSIC	DEDUCT \$35.00
JC07	Less Cylinder, Corbin 8000-7, 7 Pin FSIC, (Only RHO, 8RO, SPA, 8SP, TLR and 8TR)	DEDUCT \$35.00
JMED	Less Cylinder, Medeco 32*0201, 6 Pin FSIC (Only RHO, 8RO, SPA, 8SP lever styles)	DEDUCT \$35.00
JYA6	Less Cylinder, Yale 1210 or Medeco 31*0100, 6 Pin FSIC	DEDUCT \$35.00
JYA7	Less Cylinder, Yale 1220, 7 Pin FSIC (Only RHO, 8RO, SPA, 8SP lever styles)	DEDUCT \$35.00
LFA7	Less Cylinder, Falcon, 7 Pin, KIL (Only RHO, 8RO, SPA, 8SP lever styles)	DEDUCT \$35.00

● Master Keyed cylinders can be specified and will be shipped in lock packaging. For Master Keying System Summary form which should accompany the master keyed order, see page 283.

△ For Master Keying, additional line item 50-210 is required, \$20.10 each.

□ Control Keys for installation/removal of interchangeable cores are not furnished and must be ordered separate.

For additional assistance on Master Keying as well as restricted keyways please contact customer service.

Pricing/product description subject to change without notice.

Full Cylinder
PD LD LDSAR LDA7

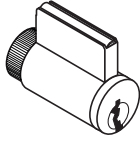

Full Size Interchangeable Core
RD JD JD SAR JD CO6 JD YA6 JD CO7

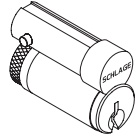

Small Format Interchangeable Core
GD BD

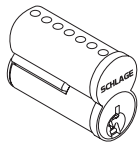

9. Select Keying Type

Open Keyway Families: KIL or FSIC ²		
S123	Everest 29 S (Key in Lever or FSIC)	STANDARD
C123	Everest C	N/C
C/CE/E/EF/ F/ FG/ G	Classic Obverse	N/C
Restricted Keyway Families: KIL or FSIC ^{1,2}		
29 T	Everest 29 T	\$17.50
D	Everest D	\$17.50
Classic Restricted	Quad, Numbered, Reverse	\$17.50
Restricted Keyway Families: SFIC ³		
29 R	Everest 29 R	N/C
B	Everest B	N/C

¹ Everest Restricted Keyways require a Letter of Authorization to be submitted with the order. See sample Letter of Authorization, see page 295.
² Full Size key systems (Everest 29 S & T, Everest C & D, Obverse & Quad) are available in Primus and Primus XP key system and must be ordered separately. Lock should be ordered less cylinder and Primus cylinder should be a separate line.
³ Master Keyed cylinders can be specified and will be shipped in lock packaging. For Master Keying System Summary form which should accompany the master keyed order, see page 283.

10. Select Handing (Field Reversible)

RHR	Right Handed Reverse	N/C
LHR	Left Handed Reverse	N/C

11. Select Battery

Cover Only	No batteries or holder	STANDARD
-------------------	------------------------	-----------------

12. -13. No Selection Required

14. Select Door Thickness

134	1-3/4"	STANDARD
Example 138	1-3/8" to 2-3/4", (Specify in 1/8" increments)	\$58.90

15. Select Options

LRX	Less Von Duprin low current Request-To-Exit switch	DEDUCT \$50.50
BAA	BAA Compliant Product	\$115.00

BAA compliant products must have the cover letter on page 301 included with the order. Failure to use this cover letter will result in the customer receiving non-BAA compliant product with no recourse for an RMA or refund. BAA compliant product requires a longer lead time, please contact customer service for details.

AD-302 Exit Trim comes with a universal mounting plate and is compatible with Von Duprin Series 98/99, 98/99XP, 22/22F exit devices and Falcon 25 rim exit devices . RX-LC switch is included unless lock is ordered as LRX, Less Request to Exit switch. Please specify if Von Duprin or Falcon RX-LC switch is required. Concealed Vertical Rod and Concealed Vertical Cable trim on metal door only. **When Request-to-exit is required, the Von Duprin RX-LC switch (part #050281) or Falcon AE switch (part #650359) must be used or the Warranty is void.**

Notes: 1) Connections other than Wiegand or Clock & Data may incur additional fee. Consult access control software provider for details.
 2) Add PIB300-2D if Wiegand or Clock and Data connection to ACP is required. Sold Separately. See page 118 for details.

Standard accessories available, see pages 116-119.
 Standard accessories sold separately include Decorative Plates, Handheld Device, Dry Contact Board (RLBD), etc.

1-4. Select Chassis/Function *Note: Locking function capabilities are determined by users access control system*

AD-400-CY-70*	Classroom/Storeroom	\$2,057.00
AD-400-CY-50*	Office	\$2,067.00
AD-400-CY-40	Privacy△	\$2,067.00
AD-400-CY-60	Apartment△	\$2,067.00

* Less Door Position Switch, use suffix LDP. Deduct \$19.50

△ Requires RS485 connection to ACP. See page 87 for system diagram. Check with access control software provider to verify function is enabled.



AD-400-CY-70-MG



KP



MGK



MS



MSK



MT/SI



MTK/SIK/FMK

5. Select Reader *Note: Reflects list price adder to base keypad reader price of \$537.00.*

LLL	Less Reader (For reader module accessories sold separately, see page 156)	DEDUCT \$537.00
KP	Keypad	STANDARD
MS	Magnetic Stripe (Swipe)	\$100.00
MSK	Magnetic Stripe (Swipe) + Keypad	\$166.00
MG	Magnetic Stripe (Insert)	\$116.00
MGK	Magnetic Stripe (Insert) + Keypad	\$184.00
MT	Multi-Technology Proximity and Smart Card	\$199.00
MTK	Multi-Technology + Keypad Proximity and Smart Card	\$264.00
SI	Smart Technology iClass Compatible Reader	\$348.00
SIK	Smart Technology iClass Compatible Reader + Keypad	\$410.00

FIPS 201-2 Compliant when applied with the FIPS Multi-Technology plus keypad reader module (FMK) and by utilizing the most current firmware available. See page 156 for the FMK reader module.

6. Select Lever*

LLL	Less interior and exterior levers	DEDUCT \$46.40
Standard Options	SPA (Sparta), RHO (Rhodes), ATH (Athens), TLR (Tubular), BRW, (Broadway), BRK (Boardwalk), LAT (Latitude), LON (Longitude)	N/C

* Tactile Warning use BAT for Athens, 8RO for Rhodes, 8SP for Sparta and 8TR for Tubular. \$45.60 per lever. Applied to exterior lever only unless otherwise specified. Not available with 643e finish.

7. Select Finish

626	Satin Chrome	N/C
605	Bright Brass	\$139.00
606	Satin Brass	\$139.00
612	Satin Bronze	\$139.00
619	Satin Nickel	\$139.00
625	Bright Chrome	\$139.00
643e	Aged Bronze	\$139.00
626AM	Satin Chrome Antimicrobial	\$179.00

8. Select Cylinder Type

P ●△	With Cylinder, Schlage- (Everest 29 S123, 6 Pin KIL standard)	N/C
L	Less Cylinder, Schlage, Falcon, 6 Pin KIL	DEDUCT \$64.00
R ●□	With Cylinder, Schlage 6-Pin (Everest 29 S123 standard) FSIC	\$38.00
J	Less Cylinder, Schlage, 6 Pin FSIC	DEDUCT \$35.00
G ●□	With Cylinder, Schlage 7-Pin (Everest 29R standard) (factory master keyed only) SFIC	\$84.00
B	Less Cylinder, Schlage, Falcon, Competitive OEM's, 7 Pin (SFIC)	N/C
L SAR	Less Cylinder, Sargent (10L + 11L), 6 Pin KIL	DEDUCT \$64.00
L CO6	Less Cylinder, Corbin 8000, 6 Pin KIL	DEDUCT \$64.00
J SAR	Less Cylinder, Sargent 6300, 6 Pin FSIC	DEDUCT \$35.00
J CO6	Less Cylinder, Corbin 8000, 6 Pin FSIC	DEDUCT \$35.00
J CO7	Less Cylinder, Corbin 8000-7, 7 Pin FSIC, (Only RHO, 8RO, SPA, 8SP, TLR and 8TR)	DEDUCT \$35.00
J MED	Less Cylinder, Medeco 32*0201, 6 Pin FSIC (Only RHO, 8RO, SPA, 8SP lever styles)	DEDUCT \$35.00
J YA6	Less Cylinder, Yale 1210 or Medeco 31*0100, 6 Pin FSIC	DEDUCT \$35.00
J YA7	Less Cylinder, Yale 1220, 7 Pin FSIC (Only RHO, 8RO, SPA, 8SP lever styles)	DEDUCT \$35.00
L FA7	Less Cylinder, Falcon, 7 Pin, KIL (Only RHO, 8RO, SPA, 8SP lever styles)	DEDUCT \$35.00

● Master Keyed cylinders can be specified and will be shipped in lock packaging. For Master Keying System Summary form which should accompany the master keyed order, see page 283.

△ For Master Keying, additional line item 50-210 is required, \$20.10 each.

□ Control Keys for installation/removal of interchangeable cores are not furnished and must be ordered separate.

For additional assistance on Master Keying as well as restricted keyways please contact customer service.

Pricing/product description subject to change without notice.

Full Cylinder
PD LD LDSAR LDA7

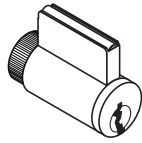

Full Size Interchangeable Core
RD JD JD SAR JD CO6 JD YA6 JD C07

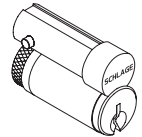

Small Format Interchangeable Core
GD BD

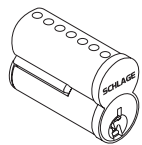

9. Select Keying Type

Open Keyway Families: KIL or FSIC ²		
S123	Everest 29 S (Key in Lever or FSIC)	STANDARD
C123	Everest C	N/C
C/CE/E/EF/F/FG/G	Classic Obverse	N/C
Restricted Keyway Families: KIL or FSIC ^{1,2}		
29 T	Everest 29 T	\$17.50
D	Everest D	\$17.50
Classic Restricted	Quad, Numbered, Reverse	\$17.50
Restricted Keyway Families: SFIC ³		
29 R	Everest 29 R	N/C
B	Everest B	N/C

¹ Everest Restricted Keyways require a Letter of Authorization to be submitted with the order. See sample Letter of Authorization, see page 295.

² Full Size key systems (Everest 29 S & T, Everest C & D, Obverse & Quad) are available in Primus and Primus XP key system and must be ordered separately. Lock should be ordered less cylinder and Primus cylinder should be a separate line.

³ Master Keyed cylinders can be specified and will be shipped in lock packaging. For Master Keying System Summary form which should accompany the master keyed order, see page 283.

10. Select Handing (Field Reversible)

RH	Right Handed	N/C
LH	Left Handed	N/C
RHR	Right Handed Reverse	N/C
LHR	Left Handed Reverse	N/C

11. Select Battery

LLL	Less Battery Holder, Batteries, and Cover	DEDUCT \$25.90
4B	4AA Battery Kit	STANDARD
8B	8AA Battery Kit	\$33.20

12. Select Backset & Latchbolt

LLL	Less Latch	DEDUCT \$34.20
13-247	2-3/4" Backset, Deadlatch, Square corner, 1-1/8" x 2-1/4"	STANDARD
14-049	2-3/4" Backset, Deadlatch Anti-friction fire door latch, Square corner, 1-1/8" x 2-1/4", 3/4" throw	\$181.00
14-051	2-3/8" Backset, Deadlatch Square corner, 1-1/8" x 2-1/4"	N/C
14-050	3-3/4" Backset, Deadlatch Square corner, 1-1/8" x 2-1/4"	\$10.70
43-001	5" Backset extension link, Deadlatch	\$33.10
39-030*	Rabbeted latch and strike kit, 605 and 626 only	\$58.10

* Adapts square corner latch and 2-3/4" square corner strike to 1/2" rabbeted door and frame.

13. Select Strike Plate

LLL	Less Strike Plate	DEDUCT \$4.50
10-025	1-3/16" Lip, ANSI, no box, 1-1/4" x 4-7/8"	STANDARD
10-013*	1-1/8" Lip, Square Corner, T-strike, box, 1-1/8" - 2-3/4"	N/C
10-016	1-1/8" Lip, Square Corner, T-strike, deep box, fire door latch	\$15.70
K510-066	Box for ANSI strike (Must be specific)	N/C

* 1-1/2" Lip available, must specify 1-1/2" Lip \$8.00

14. Select Door Thickness

134	1-3/4"	STANDARD
Example 138	1-3/8" to 2-3/4", Shims included (Specify in 1/8" increments)	\$58.90

15. Select Options

BAA	BAA Compliant Product	\$115.00
------------	-----------------------	-----------------

BAA compliant products must have the cover letter on page 301 included with the order. Failure to use this cover letter will result in the customer receiving non-BAA compliant product with no recourse for an RMA or refund. BAA compliant product requires a longer lead time, please contact customer service for details.

- Notes:** 1) Connections other than Wiegand or Clock & Data may incur additional fee. Consult access control software provider for details.
 2) PIM400 required for connection to ACP; sold separately.
 a) PIM400-TD2 required for Wiegand or Clock and Data connection, see page 118.
 b) If RS485 connection to other ACP is required, contact software provider.

Accessories available, see pages 116-119. Accessories include Panel Interface Module (PIM400) Decorative Plates, Handheld Device, etc. Credentials available, see pages 26-31.

Pricing/product description subject to change without notice.

1-3. Select Chassis

AD-400-MS	Mortise	\$2,330.00
AD-400-MD	Mortise Deadbolt Δ	\$2,367.00



AD-400-MS-70-MGK



KP



MG



MS



MSK



MT/SI



MTK/SIK/FMK

4. Select Function **Note:** Locking function capabilities are determined by users access control system

70*	Classroom/Storeroom (Not available on mortise deadbolt)	STANDARD
50*	Office Δ (Not available on mortise deadbolt)	\$10.00
40	Privacy Δ \blacksquare	\$10.00
60	Apartment Δ \blacksquare	\$10.00

* Less Door Position Switch, use suffix LDP. Deduct \$19.50

Δ Requires RS485 connection to ACP. See page 87 for system diagram. Check with access control software provider to verify function is enabled.

\blacksquare Inside Push Button (IPB) only included with Mortise (MS) chassis. Mortise deadbolt (MD) chassis comes with LED indicator only. \$10 charge does not apply to mortise deadbolt (MD) chassis.

5. Select Reader **Note:** Reflects list price adder to base keypad reader price of \$537.00.

LLL	Less Reader (For reader module accessories sold separately, see page 156)	DEDUCT \$537.00
KP	Keypad	STANDARD
MS	Magnetic Stripe (Swipe)	\$100.00
MSK	Magnetic Stripe (Swipe) + Keypad	\$166.00
MG	Magnetic Stripe (Insert)	\$116.00
MGK	Magnetic Stripe (Insert) + Keypad	\$184.00
MT	Multi-Technology Proximity and Smart Card	\$199.00
MTK	Multi-Technology + Keypad Proximity and Smart Card	\$264.00
SI	Smart Technology iClass Compatible Reader	\$348.00
SIK	Smart Technology iClass Compatible Reader + Keypad	\$410.00

FIPS 201-2 Compliant when applied with the FIPS Multi-Technology plus keypad reader module (FMK) and by utilizing the most current firmware available. See page 156 for the FMK reader module.

6. Select Lever*

LLL	Less interior and exterior levers	DEDUCT \$64.90
Standard	SPA (Sparta), RHO (Rhodes), ATH (Athens), TLR (Tubular), BRW, (Broadway),	N/C
Options	BRK (Boardwalk), LAT (Latitude), LON (Longitude)	

* Tactile Warning use BAT for Athens, BRO for Rhodes, BSP for Sparta and BTR for Tubular. \$45.60 per lever. Applied to exterior lever only unless otherwise specified. Not available with 643e finish.

7. Select Finish

626	Satin Chrome	N/C
605	Bright Brass	\$139.00
606	Satin Brass	\$139.00
612	Satin Bronze	\$139.00
619	Satin Nickel	\$139.00
625	Bright Chrome	\$139.00
643e	Aged Bronze	\$139.00
626AM	Satin Chrome Antimicrobial	\$179.00

8. Select Cylinder Type

P \bullet Δ	With Cylinder, Schlage- (Everest 29 S123, 6 Pin KIL standard)	N/C
L	Less Cylinder, Schlage, Falcon, 6 Pin KIL	DEDUCT \$64.00
R \bullet \square	With Cylinder, Schlage 6-Pin (Everest 29 S123 standard) FSIC	\$38.00
J	Less Cylinder, Schlage, 6 Pin FSIC	DEDUCT \$35.00
G \bullet \square	With Cylinder, Schlage 7-Pin (Everest 29R standard) (factory master keyed only) SFIC	\$84.00
B	Less Cylinder, Schlage, Falcon, Competitive OEM's, 7 Pin (SFIC)	N/C
L SAR	Less Cylinder, Sargent (10L + 11L), 6 Pin KIL	DEDUCT \$64.00
L CO6	Less Cylinder, Corbin 8000, 6 Pin KIL	DEDUCT \$64.00
J SAR	Less Cylinder, Sargent 6300, 6 Pin FSIC	DEDUCT \$35.00
J CO6	Less Cylinder, Corbin 8000, 6 Pin FSIC	DEDUCT \$35.00
J CO7	Less Cylinder, Corbin 8000-7, 7 Pin FSIC, (Only RHO, BRO, SPA, BSP, TLR and BTR)	DEDUCT \$35.00
J MED	Less Cylinder, Medeco 32*0201, 6 Pin FSIC (Only RHO, BRO, SPA, BSP lever styles)	DEDUCT \$35.00
J YA6	Less Cylinder, Yale 1210 or Medeco 31*0100, 6 Pin FSIC	DEDUCT \$35.00
J YA7	Less Cylinder, Yale 1220, 7 Pin FSIC (Only RHO, BRO, SPA, BSP lever styles)	DEDUCT \$35.00
L FA7	Less Cylinder, Falcon, 7 Pin, KIL (Only RHO, BRO, SPA, BSP lever styles)	DEDUCT \$35.00

\bullet Master Keyed cylinders can be specified and will be shipped in lock packaging. For Master Keying System Summary form which should accompany the master keyed order, see page 283.

Δ For Master Keying, additional line item 50-210 is required, \$20.10 each.

\square Control Keys for installation/removal of interchangeable cores are not furnished and must be ordered separate.

For additional assistance on Master Keying as well as restricted keyways please contact customer service.

Pricing/product description subject to change without notice.

Full Cylinder
PD LD LDSAR LDF A7

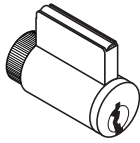

Full Size
Interchangeable Core
RD JD JD SAR JD CO6 JD YA6
JD CO7

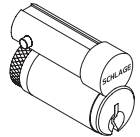

Small Format
Interchangeable Core
GD BD

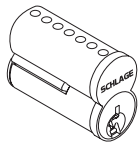

9. Select Keying Type

Open Keyway Families: KIL or FSIC ²		
S123	Everest 29 S (Key in Lever or FSIC)	STANDARD
C123	Everest C	N/C
C/CE/E/EF/ F/ FG/ G	Classic Obverse	N/C
Restricted Keyway Families: KIL or FSIC ^{1,2}		
29 T	Everest 29 T	\$17.50
D	Everest D	\$17.50
Classic Restricted	Quad, Numbered, Reverse	\$17.50
Restricted Keyway Families: SFIC ³		
29 R	Everest 29 R	N/C
B	Everest B	N/C

¹ Everest Restricted Keyways require a Letter of Authorization to be submitted with the order. See sample Letter of Authorization, see page 295.

² Full Size key systems (Everest 29 S & T, Everest C & D, Obverse & Quad) are available in Primus and Primus XP key system and must be ordered separately. Lock should be ordered less cylinder and Primus cylinder should be a separate line.

³ Master Keyed cylinders can be specified and will be shipped in lock packaging. For Master Keying System Summary form which should accompany the master keyed order, see page 283.

10. Select Handing (Field Reversible)

RH	Right Handed	N/C
LH	Left Handed	N/C
RHR	Right Handed Reverse	N/C
LHR	Left Handed Reverse	N/C

11. Select Battery

LLL	Less Battery Holder, Batteries, and Cover	DEDUCT \$25.90
4B	4AA Battery Kit	STANDARD
8B	8AA Battery Kit	\$39.00

12. Select Mortise Lock Armor Front

LLL	Less Armor Front	DEDUCT \$16.80
09-663	1-1/4" Wide Square Corner, Latch for MS	STANDARD
09-669	1-1/16" Wide Square Corner, Latch, options for MS	N/C
09-666	1-1/4" Wide Square Corner, Latch x Deadbolt for MD	STANDARD
09-672	1-1/16" Wide Square Corner, Latch x Deadbolt, Options for MD	N/C

13. Select Strike Plate

LLL	Less Strike	DEDUCT \$13.20
10-072	1-1/4" x 4-7/8" Square Corner + box; 1-3/16" lip length	STANDARD
10-072xx	1-1/4" x 4-7/8" Square Corner + box; specify lip length (xx) as 1" or 1-1/2"	N/C
10-072xx	1-1/4" x 4-7/8" Square Corner + box; specify lip length (xx) as 1-3/4"	\$31.30
10-075 ●	1/2" Rabbeted	\$108.00
37-015	Strike Frame Reinforcer, specify 37-015	N/C
XL11-820 △	One hole for latching functions, RH & LHR doors Lip 1-3/16"	\$13.40
XL11-821 △	One hole for latching functions, LH & RHR doors Lip 1-3/16"	\$13.40

● For 1-3/4" thick doors, use wide armor front. For over 1-3/4" thick door extended equally (EE) use 1-1/4" wide armor front.

△ Extended leadtime, consult customer service.

14. Select Door Thickness

134	1-3/4"	STANDARD
Example 138	1-3/8" to 2-3/4", Shims included (Specify in 1/8" increments)	\$58.90

15. Select Options

BAA	BAA Compliant Product	\$115.00
------------	-----------------------	-----------------

BAA compliant products must have the cover letter on page 301 included with the order. Failure to use this cover letter will result in the customer receiving non-BAA compliant product with no recourse for an RMA or refund. BAA compliant product requires a longer lead time, please contact customer service for details.

Notes: 1) Connections other than Wiegand or Clock & Data may incur additional fee. Consult access control software provider for details.

2) PIM400 required for connection to ACP; sold separately.

a) PIM400-TD2 required for Wiegand or Clock and Data connection, see page 118.

b) If RS485 connection to other ACP is required, contact software provider.

Accessories available, see pages 116-119. Accessories include Panel Interface Module (PIM400) Decorative Plates, Handheld Device, etc.

Credentials available, see pages 26-31.

Pricing/product description subject to change without notice.

1-3. Select Chassis/Exit Trim Type *Note: See page 77 for exit device compatibility*

AD-400-993R	Exit Rim/Concealed Vertical Rod (Metal Door)/Concealed Vertical Cable (Metal Door)	\$2,400.00
AD-400-993S	Exit Surface Vertical Rod	\$2,430.00
AD-400-993M	Exit Mortise Lock	\$2,430.00



AD-400-993R-70-MTK



KP



MG



MGK



MS



MSK



MTK/SI/FMK



MT/SI

4. Select Function *Note: Locking function capabilities are determined by users access control system*

70*	Classroom/Storeroom	STANDARD
50*	Office Δ	\$10.00
40	Privacy Δ	\$10.00
60	Apartment Δ	\$10.00

* Less Door Position Switch, use suffix LDP. Deduct \$19.50

Δ Requires RS485 connection to ACP. See page 87 for system diagram. Ensure function is enabled through access control software provider.

5. Select Reader *Note: Reflects list price adder to base keypad reader price of \$537.00.*

LLL	Less Reader (For reader module accessories sold separately, see page 156)	DEDUCT \$537.00
KP	Keypad	STANDARD
MS	Magnetic Stripe (Swipe)	\$100.00
MSK	Magnetic Stripe (Swipe) + Keypad	\$166.00
MG	Magnetic Stripe (Insert)	\$116.00
MGK	Magnetic Stripe (Insert) + Keypad	\$184.00
MT	Multi-Technology Proximity and Smart Card	\$199.00
MTK	Multi-Technology + Keypad Proximity and Smart Card	\$264.00
SI	Smart Technology iClass Compatible Reader	\$348.00
SIK	Smart Technology iClass Compatible Reader + Keypad	\$410.00

6. Select Lever*

LLL	Less interior and exterior levers	DEDUCT \$23.20
Standard Options	SPA (Sparta), RHO (Rhodes), ATH (Athens), TLR (Tubular), BRW, (Broadway), BRK (Boardwalk), LAT (Latitude), LON (Longitude)	N/C

* Tactile Warning use 8AT for Athens, 8RO for Rhodes, 8SP for Sparta and 8TR for Tubular. \$45.60 per lever. Applied to exterior lever only unless otherwise specified. Not available with 643e finish.

7. Select Finish

626	Satin Chrome	N/C
605	Bright Brass	\$139.00
606	Satin Brass	\$139.00
612	Satin Bronze	\$139.00
619	Satin Nickel	\$139.00
625	Bright Chrome	\$139.00
643e	Aged Bronze	\$139.00
626AM	Satin Chrome Antimicrobial	\$179.00

8. Select Cylinder Type

P ● Δ	With Cylinder, Schlage- (Everest 29 S123, 6 Pin KIL standard)	N/C
L	Less Cylinder, Schlage, Falcon, 6 Pin KIL	DEDUCT \$64.00
R ● \square	With Cylinder, Schlage 6-Pin (Everest 29 S123 standard) FSIC	\$38.00
J	Less Cylinder, Schlage, 6 Pin FSIC	DEDUCT \$35.00
G ● \square	With Cylinder, Schlage 7-Pin (Everest 29R standard) (factory master keyed only) SFIC	\$84.00
B	Less Cylinder, Schlage, Falcon, Competitive OEM's, 7 Pin (SFIC)	N/C
L SAR	Less Cylinder, Sargent (10L + 11L), 6 Pin KIL	DEDUCT \$64.00
L CO6	Less Cylinder, Corbin 8000, 6 Pin KIL	DEDUCT \$64.00
J SAR	Less Cylinder, Sargent 6300, 6 Pin FSIC	DEDUCT \$35.00
J CO6	Less Cylinder, Corbin 8000, 6 Pin FSIC	DEDUCT \$35.00
J CO7	Less Cylinder, Corbin 8000-7, 7 Pin FSIC, (Only RHO, 8RO, SPA, 8SP, TLR and 8TR)	DEDUCT \$35.00
J MED	Less Cylinder, Medeco 32*0201, 6 Pin FSIC (Only RHO, 8RO, SPA, 8SP lever styles)	DEDUCT \$35.00
J YA6	Less Cylinder, Yale 1210 or Medeco 31*0100, 6 Pin FSIC	DEDUCT \$35.00
J YA7	Less Cylinder, Yale 1220, 7 Pin FSIC (Only RHO, 8RO, SPA, 8SP lever styles)	DEDUCT \$35.00
L FA7	Less Cylinder, Falcon, 7 Pin, KIL (Only RHO, 8RO, SPA, 8SP lever styles)	DEDUCT \$35.00

● Master Keyed cylinders can be specified and will be shipped in lock packaging. For Master Keying System Summary form which should accompany the master keyed order, see page 283.

Δ For Master Keying, additional line item 50-210 is required, \$20.10 each.

\square Control Keys for installation/removal of interchangeable cores are not furnished and must be ordered separate. For additional assistance on Master Keying as well as restricted keyways please contact customer service.

Pricing/product description subject to change without notice.

Full Cylinder
PD LD LDSAR LDFA7

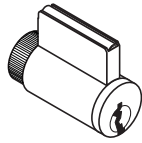

Full Size Interchangeable Core
RD JD JD SAR JD CO6 JD YA6 JD CO7

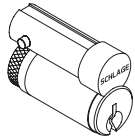

Small Format Interchangeable Core
GD BD

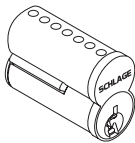

9. Select Keying Type

Open Keyway Families: KIL or FSIC ²		
S123	Everest 29 S (Key in Lever or FSIC)	STANDARD
C123	Everest C	N/C
C/CE/E/EF/ F/ FG/ G	Classic Obverse	N/C
Restricted Keyway Families: KIL or FSIC ^{1,2}		
29 T	Everest 29 T	\$17.50
D	Everest D	\$17.50
Classic Restricted	Quad, Numbered, Reverse	\$17.50
Restricted Keyway Families: SFIC ³		
29 R	Everest 29 R	N/C
B	Everest B	N/C

¹ Everest Restricted Keyways require a Letter of Authorization to be submitted with the order. See sample Letter of Authorization, see page 295.

² Full Size key systems (Everest 29 S & T, Everest C & D, Obverse & Quad) are available in Primus and Primus XP key system and must be ordered separately. Lock should be ordered less cylinder and Primus cylinder should be a separate line.

³ Master Keyed cylinders can be specified and will be shipped in lock packaging. For Master Keying System Summary form which should accompany the master keyed order, see page 283.

10. Select Handing (Field Reversible)

RHR	Right Handed Reverse	N/C
LHR	Left Handed Reverse	N/C

11. Select Battery

LLL	Less Battery Holder, Batteries, and Cover	DEDUCT \$25.90
4B	4AA Battery Kit	STANDARD
8B	8AA Battery Kit	\$39.00

12. - 13. No Selection Required

14. Select Door Thickness

134	1-3/4"	STANDARD
Example 138	1-3/8" to 2-3/4", (Specify in 1/8" increments)	\$58.90

15. Select Options

LRX	Less Von Duprin low current Request-To-Exit switch	DEDUCT \$52.00
BAA	BAA Compliant Product	\$115.00

BAA compliant products must have the cover letter on page 301 included with the order. Failure to use this cover letter will result in the customer receiving non-BAA compliant product with no recourse for an RMA or refund. BAA compliant product requires a longer lead time, please contact customer service for details.

AD-300 Exit Trim comes with a universal mounting plate and is compatible with Von Duprin Series 98/99, 98/99XP, 22/22F exit devices and Falcon 25 rim exit devices. RX-LC switch is included unless lock is ordered as LRX, Less Request to Exit switch. Please specify if Von Duprin or Falcon RX-LC switch is required. Concealed Vertical Rod and Concealed Vertical Cable trim on metal door only. **When Request-to-exit is required, the Von Duprin RX-LC switch (part #050281) or Falcon AE switch (part #650359) must be used or the Warranty is void.**

Note: AD-Series Non-Functioning "Dummy" Exit Trim now available. Please see pages 114-115 for details

- Notes:** 1) Connections other than Wiegand or Clock & Data may incur additional fee. Consult access control software provider for details.
 2) PIM400 required for connection to ACP; sold separately.
 a) PIM400-TD2 required for Wiegand or Clock and Data connection, see page 118.
 b) If RS485 connection to other ACP is required, contact software provider.

Accessories available, see pages 116-119.
 Accessories include Panel Interface Mobile (PIM400) Decorative Plates, Handheld Device, etc.
 Credentials available, see pages 26-31.

1-4. Select Chassis/Function

Note: Locking function capabilities are determined by users access control system

AD-402-CY-70*	Classroom/Storeroom	\$2,057.00
AD-402-CY-50*	Office	\$2,067.00
AD-402-CY-40	Privacy△	\$2,067.00
AD-402-CY-60	Apartment△	\$2,067.00

* Less Door Position Switch, use suffix LDP. Deduct \$19.50

△ Requires RS485 connection to ACP. See page 88 for system diagram. Check with Access Control software provider to verify function is enabled.



AD-402-CY-70-FMK

5. Select Reader

FMK	FIPS 201-2 Multi-Technology + Keypad Proximity and Smart Card (PIV & PIV-I Card)	\$473.00
------------	--	-----------------

Note: The AD-400 lock can be field upgraded to a FIPS 201-2 compliant solution simply by adding the FMK reader (sold separately) and by using the most current firmware revision.

Note: Verify compatibility of PIV & PIV-I credentials with access control software provider.

6. Select Lever*

LLL	Less interior and exterior levers	DEDUCT \$46.40
SPA	Sparta	N/C
RHO	Rhodes	N/C
ATH	Athens	N/C
TLR	Tubular	N/C
BRW	Broadway	N/C
BRK	Boardwalk	N/C
LAT	Latitude	N/C
LON	Longitude	N/C

* Tactile Warning use 8AT for Athens, 8RO for Rhodes, 8SP for Sparta and 8TR for Tubular. \$45.60 per lever. Applied to exterior lever only unless otherwise specified. Not available with 643e finish.

7. Select Finish

626	Satin Chrome	N/C
605	Bright Brass	\$139.00
606	Satin Brass	\$139.00
612	Satin Bronze	\$139.00
619	Satin Nickel	\$139.00
625	Bright Chrome	\$139.00
643e	Aged Bronze	\$139.00
626AM	Satin Chrome Antimicrobial	\$179.00

8. Select Cylinder Type

P ● △	With Cylinder, Schlage- (Everest 29 S123, 6 Pin KIL standard)	N/C
L	Less Cylinder, Schlage, Falcon, 6 Pin KIL	DEDUCT \$64.00
R ● □	With Cylinder, Schlage 6-Pin (Everest 29 S123 standard) FSIC	\$38.00
J	Less Cylinder, Schlage, 6 Pin FSIC	DEDUCT \$35.00
G ● □	With Cylinder, Schlage 7-Pin (Everest 29R standard) (factory master keyed only) SFIC	\$84.00
B	Less Cylinder, Schlage, Falcon, Competitive OEM's, 7 Pin (SFIC)	N/C
L SAR	Less Cylinder, Sargent (10L + 11L), 6 Pin KIL	DEDUCT \$64.00
L CO6	Less Cylinder, Corbin 8000, 6 Pin KIL	DEDUCT \$64.00
J SAR	Less Cylinder, Sargent 6300, 6 Pin FSIC	DEDUCT \$35.00
J CO6	Less Cylinder, Corbin 8000, 6 Pin FSIC	DEDUCT \$35.00
J CO7	Less Cylinder, Corbin 8000-7, 7 Pin FSIC, (Only RHO, 8RO, SPA, 8SP, TLR and 8TR)	DEDUCT \$35.00
J MED	Less Cylinder, Medeco 32*0201, 6 Pin FSIC (Only RHO, 8RO, SPA, 8SP lever styles)	DEDUCT \$35.00
J YA6	Less Cylinder, Yale 1210 or Medeco 31*0100, 6 Pin FSIC	DEDUCT \$35.00
J YA7	Less Cylinder, Yale 1220, 7 Pin FSIC (Only RHO, 8RO, SPA, 8SP lever styles)	DEDUCT \$35.00
L FA7	Less Cylinder, Falcon, 7 Pin, KIL (Only RHO, 8RO, SPA, 8SP lever styles)	DEDUCT \$35.00

● Master Keyed cylinders can be specified and will be shipped in lock packaging. For Master Keying System Summary form which should accompany the master keyed order, see page 283.

△ For Master Keying, additional line item 50-210 is required, \$20.10 each.

□ Control Keys for installation/removal of interchangeable cores are not furnished and must be ordered separate.

For additional assistance on Master Keying as well as restricted keyways please contact customer service.

Full Cylinder
PD LD LDSAR LDFA7

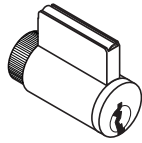

Full Size
Interchangeable Core
RD JD JD SAR JD CO6 JD YA6
JD CO7

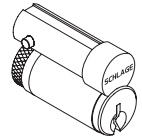

Small Format
Interchangeable Core
GD BD

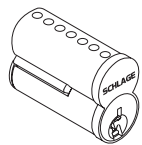

9. Select Keying Type

Open Keyway Families: KIL or FSIC ²		
S123	Everest 29 S (Key in Lever or FSIC)	STANDARD
C123	Everest C	N/C
C/CE/E/EF/F/FG/G	Classic Obverse	N/C
Restricted Keyway Families: KIL or FSIC ^{1,2}		
29 T	Everest 29 T	\$17.50
D	Everest D	\$17.50
Classic Restricted	Quad, Numbered, Reverse	\$17.50
Restricted Keyway Families: SFIC ³		
29 R	Everest 29 R	N/C
B	Everest B	N/C

¹ Everest Restricted Keyways require a Letter of Authorization to be submitted with the order. See sample Letter of Authorization, see page 295.

² Full Size key systems (Everest 29 S & T, Everest C & D, Obverse & Quad) are available in Primus and Primus XP key system and must be ordered separately. Lock should be ordered less cylinder and Primus cylinder should be a separate line.

³ Master Keyed cylinders can be specified and will be shipped in lock packaging. For Master Keying System Summary form which should accompany the master keyed order, see page 283.

10. Select Handing (Field Reversible)

RH	Right Handed	N/C
LH	Left Handed	N/C
RHR	Right Handed Reverse	N/C
LHR	Left Handed Reverse	N/C

11. Select Battery

LLL	Less Battery Holder, Batteries, and Cover	DEDUCT \$25.90
4B	4AA Battery Kit	STANDARD
8B	8AA Battery Kit	\$39.00

12. Select Backset & Latchbolt

LLL	Less Latch	DEDUCT \$34.20
13-247	2-3/4" Backset, Deadlatch, Square corner, 1-1/8" x 2-1/4"	STANDARD
14-049	2-3/4" Backset, Deadlatch Anti-friction fire door latch, Square corner, 1-1/8" x 2-1/4", 3/4" throw	\$181.00
14-051	2-3/8" Backset, Deadlatch Square corner, 1-1/8" x 2-1/4"	N/C
14-050	3-3/4" Backset, Deadlatch Square corner, 1-1/8" x 2-1/4"	\$10.70
43-001	5" Backset extension link, Deadlatch	\$33.10
39-030*	Rabbeted latch and strike kit, 605 and 626 only	\$58.10

* Adapts square corner latch and 2-3/4" square corner strike to 1/2" rabbeted door and frame.

13. Select Strike Plate

LLL	Less Strike Plate	DEDUCT \$4.50
10-025	1-3/16" Lip, ANSI, no box, 1-1/14" x 4-7/8"	STANDARD
10-013*	1-1/8" Lip, Square Corner, T-strike, box, 1-1/8" - 2-3/4"	N/C
10-016	1-1/8" Lip, Square Corner, T-strike, deep box, fire door latch	\$15.70
K510-066	Box for ANSI strike (Must be specific)	N/C

* 1-1/2" Lip available, must specify 1-1/2" Lip \$8.00

14. Select Door Thickness

134	1-3/4"	STANDARD
Example 138	1-3/8" to 2-3/4", Shims included (Specify in 1/8" increments)	\$58.90

15. Select Options

BAA	BAA Compliant Product	\$115.00
------------	-----------------------	-----------------

BAA compliant products must have the cover letter on page 301 included with the order. Failure to use this cover letter will result in the customer receiving non-BAA compliant product with no recourse for an RMA or refund. BAA compliant product requires a longer lead time, please contact customer service for details.

Notes: 1) Connections other than Wiegand or Clock & Data may incur additional fee. Consult access control software provider for details.

2) PIM400 required for connection to ACP; sold separately.

a) PIM400-TD2 required for Wiegand or Clock and Data connection, see page 118.

b) If RS485 connection to other ACP is required, contact software provider.

Standard accessories available, see pages 116-119.

Standard accessories sold separately include Decorative Plates, Handheld Device, Dry Contact Board (RLBD), etc.

Pricing/product description subject to change without notice.



1-3. Select Chassis

AD-402-MS	Mortise	\$2,330.00
AD-402-MD	Mortise Deadbolt Δ	\$2,365.00



AD-402-MS-70-FMK

4. Select Function

Note: Locking function capabilities are determined by users' access control system

70*	Classroom/Storeroom (Not available on mortise deadbolt)	STANDARD
50*	Office Δ (Not available on mortise deadbolt)	\$10.00
40	Privacy Δ ■	\$10.00
60	Apartment Δ ■	\$10.00

* Less Door Position Switch, use suffix LDP. Deduct \$19.50

Δ Requires RS485 connection to ACP. See page 88 for system diagram. Check with access control software provider to verify function is enabled.

■ Inside Push Button (IPB) only included with Mortise (MS) chassis. Mortise deadbolt (MD) chassis comes with LED indicator only. \$10 charge does not apply to mortise deadbolt (MD) chassis.

5. Select Reader

FMK	FIPS 201-2 Multi-Technology + Keypad Proximity and Smart Card (PIV & PIV-I Card)	\$473.00
------------	--	-----------------

Note: The AD-400 lock can be field upgraded to a FIPS 201-2 compliant solution simply by adding the FMK reader (sold separately) and by using the most current firmware revision.

Note: Verify compatibility of PIV & PIV-I credentials with access control software provider.

6. Select Lever*

LLL	Less interior and exterior levers	DEDUCT \$64.90
SPA	Sparta	N/C
RHO	Rhodes	N/C
ATH	Athens	N/C
TLR	Tubular	N/C
BRW	Broadway	N/C
BRK	Boardwalk	N/C
LAT	Latitude	N/C
LON	Longitude	N/C

* Tactile Warning use BAT for Athens, 8RO for Rhodes, 8SP for Sparta and 8TR for Tubular. \$45.60 per lever. Applied to exterior lever only unless otherwise specified. Not available with 643e finish.

7. Select Finish

626	Satin Chrome	N/C
605	Bright Brass	\$139.00
606	Satin Brass	\$139.00
612	Satin Bronze	\$139.00
619	Satin Nickel	\$139.00
625	Bright Chrome	\$139.00
643e	Aged Bronze	\$139.00
626AM	Satin Chrome Antimicrobial	\$179.00

8. Select Cylinder Type

P ● Δ	With Cylinder, Schlage- (Everest 29 S123, 6 Pin KIL standard)	N/C
L	Less Cylinder, Schlage, Falcon, 6 Pin KIL	DEDUCT \$64.00
R ● □	With Cylinder, Schlage 6-Pin (Everest 29 S123 standard) FSIC	\$38.00
J	Less Cylinder, Schlage, 6 Pin FSIC	DEDUCT \$35.00
G ● □	With Cylinder, Schlage 7-Pin (Everest 29R standard) (factory master keyed only) SFIC	\$84.00
B	Less Cylinder, Schlage, Falcon, Competitive OEM's, 7 Pin (SFIC)	N/C
L SAR	Less Cylinder, Sargent (10L + 11L), 6 Pin KIL	DEDUCT \$64.00
LC06	Less Cylinder, Corbin 8000, 6 Pin KIL	DEDUCT \$64.00
JSAR	Less Cylinder, Sargent 6300, 6 Pin FSIC	DEDUCT \$35.00
JCO6	Less Cylinder, Corbin 8000, 6 Pin FSIC	DEDUCT \$35.00
JCO7	Less Cylinder, Corbin 8000-7, 7 Pin FSIC, (Only RHO, 8RO, SPA, 8SP, TLR and 8TR)	DEDUCT \$35.00
JMED	Less Cylinder, Medeco 32*0201, 6 Pin FSIC (Only RHO, 8RO, SPA, 8SP lever styles)	DEDUCT \$35.00
JYA6	Less Cylinder, Yale 1210 or Medeco 31*0100, 6 Pin FSIC	DEDUCT \$35.00
JYA7	Less Cylinder, Yale 1220, 7 Pin FSIC (Only RHO, 8RO, SPA, 8SP lever styles)	DEDUCT \$35.00
LFA7	Less Cylinder, Falcon, 7 Pin, KIL (Only RHO, 8RO, SPA, 8SP lever styles)	DEDUCT \$35.00

● Master Keyed cylinders can be specified and will be shipped in lock packaging. For Master Keying System Summary form which should accompany the master keyed order, see page 283.

Δ For Master Keying, additional line item 50-210 is required, \$20.10 each.

□ Control Keys for installation/removal of interchangeable cores are not furnished and must be ordered separate.

For additional assistance on Master Keying as well as restricted keyways please contact customer service.

Pricing/product description subject to change without notice.

Full Cylinder
PD LD LDSAR LDFA7

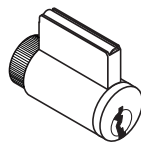

Full Size Interchangeable Core
RD JD JD SAR JD CO6 JD YA6 JD CO7

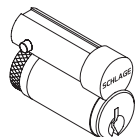

Small Format Interchangeable Core
GD BD

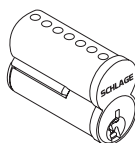

9. Select Keying Type

Open Keyway Families: KIL or FSIC ²		
S123	Everest 29 S (Key in Lever or FSIC)	STANDARD
C123	Everest C	N/C
C/CE/E/EF/ F/ FG/ G	Classic Obverse	N/C
Restricted Keyway Families: KIL or FSIC ^{1,2}		
29 T	Everest 29 T	\$17.50
D	Everest D	\$17.50
Classic Restricted	Quad, Numbered, Reverse	\$17.50
Restricted Keyway Families: SFIC ³		
29 R	Everest 29 R	N/C
B	Everest B	N/C

¹ Everest Restricted Keyways require a Letter of Authorization to be submitted with the order. See sample Letter of Authorization, see page 295.

² Full Size key systems (Everest 29 S & T, Everest C & D, Obverse & Quad) are available in Primus and Primus XP key system and must be ordered separately. Lock should be ordered less cylinder and Primus cylinder should be a separate line.

³ Master Keyed cylinders can be specified and will be shipped in lock packaging. For Master Keying System Summary form which should accompany the master keyed order, see page 283.

10. Select Handing (Field Reversible)

RH	Right Handed	N/C
LH	Left Handed	N/C
RHR	Right Handed Reverse	N/C
LHR	Left Handed Reverse	N/C

11. Select Battery

LLL	Less Battery Holder, Batteries, and Cover	DEDUCT \$25.90
4B	4AA Battery Kit	STANDARD
8B	8AA Battery Kit	\$39.00

12. Select Mortise Lock Armor Front

LLL	Less Armor Front	DEDUCT \$17.90
09-663	1-1/4" Wide Square Corner, Latch for MS	STANDARD
09-669	1-1/16" Wide Square Corner, Latch, options for MS	N/C
09-666	1-1/4" Wide Square Corner, Latch x Deadbolt for MD	STANDARD
09-672	1-1/16" Wide Square Corner, Latch x Deadbolt, Options for MD	N/C

13. Select Strike Plate

LLL	Less Strike	DEDUCT \$13.20
10-072	1-1/4" x 4-7/8" Square Corner + box; 1-3/16" lip length	STANDARD
10-072xx	1-1/4" x 4-7/8" Square Corner + box; specify lip length (xx) as 1" or 1-1/2"	N/C
10-072xx	1-1/4" x 4-7/8" Square Corner + box; specify lip length (xx) as 1-3/4"	\$31.30
10-075 ●	1/2" Rabbeted	\$108.00
37-015	Strike Frame Reinforcer, specify 37-015	N/C
XL11-820 △	One hole for latching functions, RH & LHR doors Lip 1-3/16"	\$13.40
XL11-821 △	One hole for latching functions, LH & RHR doors Lip 1-3/16"	\$13.40

● For 1-3/4" thick doors, use wide armor front. For over 1-3/4" thick door extended equally (EE) use 1-1/4" wide armor front.

△ Extended leadtime, consult customer service.

14. Select Door Thickness

134	1-3/4"	STANDARD
Example 138	1-3/8" to 2-3/4", Shims included (Specify in 1/8" increments)	\$58.90

15. Select Options

BAA	BAA Compliant Product	\$115.00
------------	-----------------------	-----------------

BAA compliant products must have the cover letter on page 301 included with the order. Failure to use this cover letter will result in the customer receiving non-BAA compliant product with no recourse for an RMA or refund. BAA compliant product requires a longer lead time, please contact customer service for details.

Notes: 1) Connections other than Wiegand or Clock & Data may incur additional fee. Consult access control software provider for details.

2) PIM400 required for connection to ACP; sold separately.

a) PIM400-TD2 required for Wiegand or Clock and Data connection, see page 118

b) If RS485 connection to other ACP is required, contact software provider.

Accessories available, see pages 116-119. Accessories include Panel Interface Module (PIM400) Decorative Plates, Handheld Device, etc. Credentials available, see pages 26-31.

1-3. Select Chassis/Exit Trim Type*

AD-402-993R	Exit Rim/ ¹ Concealed Vertical Rod/ ¹ Concealed Vertical Cable	\$2,400.00
AD-402-993S	Exit Surface Vertical Rod	\$2,430.00
AD-402-993M	Exit Mortise Lock	\$2,430.00

* See page 77 for exit device compatibility. ¹ Metal door only.



AD-402-993R-70-FMK

4. Select Function Note: Locking function capabilities are determined by users access control system

70*	Classroom/Storeroom	STANDARD
50*	Office △	\$10.00
40	Privacy △	\$10.00
60	Apartment △	\$10.00

* Less Door Position Switch, use suffix LDP. Deduct \$19.50

△ Requires RS485 connection to ACP. See page 88 for system diagram. Ensure function is enabled through access control software provider.

5. Select Reader

FMK	FIPS 201-2 Multi-Technology + Keypad Proximity and Smart Card (PIV & PIV-I Card)	\$473.00
-----	--	----------

Note: The AD-400 lock can be field upgraded to a FIPS 201-2 compliant solution simply by adding the FMK reader (sold separately) and by using the most current firmware revision.

Note: Verify compatibility of PIV & PIV-I credentials with access control software provider.

6. Select Lever*

LLL	Less interior and exterior levers	DEDUCT \$23.20
SPA	Sparta	N/C
RHO	Rhodes	N/C
ATH	Athens	N/C
TLR	Tubular	N/C
BRW	Broadway	N/C
BRK	Boardwalk	N/C
LAT	Latitude	N/C
LON	Longitude	N/C

* Tactile Warning use 8AT for Athens, 8RO for Rhodes, 8SP for Sparta and 8TR for Tubular. \$45.60 per lever. Applied to exterior lever only unless otherwise specified. Not available with 643e finish.

7. Select Finish

626	Satin Chrome	N/C
605	Bright Brass	\$139.00
606	Satin Brass	\$139.00
612	Satin Bronze	\$139.00
619	Satin Nickel	\$139.00
625	Bright Chrome	\$139.00
643e	Aged Bronze	\$139.00
626AM	Satin Chrome Antimicrobial	\$179.00

8. Select Cylinder Type

P ●△	With Cylinder, Schlage- (Everest 29 S123, 6 Pin KIL standard)	N/C
L	Less Cylinder, Schlage, Falcon, 6 Pin KIL	DEDUCT \$64.00
R ●□	With Cylinder, Schlage 6-Pin (Everest 29 S123 standard) FSIC	\$38.00
J	Less Cylinder, Schlage, 6 Pin FSIC	DEDUCT \$35.00
G ●□	With Cylinder, Schlage 7-Pin (Everest 29R standard) (factory master keyed only) SFIC	\$84.00
B	Less Cylinder, Schlage, Falcon, Competitive OEM's, 7 Pin (SFIC)	N/C
LSAR	Less Cylinder, Sargent (10L + 11L), 6 Pin KIL	DEDUCT \$64.00
LC06	Less Cylinder, Corbin 8000, 6 Pin KIL	DEDUCT \$64.00
JSAR	Less Cylinder, Sargent 6300, 6 Pin FSIC	DEDUCT \$35.00
JC06	Less Cylinder, Corbin 8000, 6 Pin FSIC	DEDUCT \$35.00
JC07	Less Cylinder, Corbin 8000-7, 7 Pin FSIC, (Only RHO, 8RO, SPA, BSP, TLR and 8TR)	DEDUCT \$35.00
JMED	Less Cylinder, Medeco 32*0201, 6 Pin FSIC (Only RHO, 8RO, SPA, BSP lever styles)	DEDUCT \$35.00
JYA6	Less Cylinder, Yale 1210 or Medeco 31*0100, 6 Pin FSIC	DEDUCT \$35.00
JYA7	Less Cylinder, Yale 1220, 7 Pin FSIC (Only RHO, 8RO, SPA, BSP lever styles)	DEDUCT \$35.00
LFA7	Less Cylinder, Falcon, 7 Pin, KIL (Only RHO, 8RO, SPA, BSP lever styles)	DEDUCT \$35.00

● Master Keyed cylinders can be specified and will be shipped in lock packaging. For Master Keying System Summary form which should accompany the master keyed order, see page 283.

△ For Master Keying, additional line item 50-210 is required, \$20.10 each.

□ Control Keys for installation/removal of interchangeable cores are not furnished and must be ordered separate.

For additional assistance on Master Keying as well as restricted keyways please contact customer service.

Pricing/product description subject to change without notice.

Full Cylinder
PD LD LDSAR LDFA7

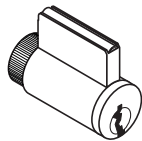

Full Size Interchangeable Core
RD JD JD SAR JD CO6 JD YA6 JD CO7

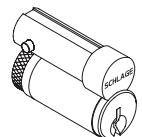

Small Format Interchangeable Core
GD BD

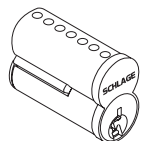

9. Select Keying Type

Open Keyway Families: KIL or FSIC ²		
S123	Everest 29 S (Key in Lever or FSIC)	STANDARD
C123	Everest C	N/C
C/CE/E/EF/ F/ FG/ G	Classic Obverse	N/C
Restricted Keyway Families: KIL or FSIC ^{1,2}		
29 T	Everest 29 T	\$17.50
D	Everest D	\$17.50
Classic Restricted	Quad, Numbered, Reverse	\$17.50
Restricted Keyway Families: SFIC ³		
29 R	Everest 29 R	N/C
B	Everest B	N/C

¹ Everest Restricted Keyways require a Letter of Authorization to be submitted with the order. See sample Letter of Authorization, see page 295.
² Full Size key systems (Everest 29 S & T, Everest C & D, Obverse & Quad) are available in Primus and Primus XP key system and must be ordered separately. Lock should be ordered less cylinder and Primus cylinder should be a separate line.
³ Master Keyed cylinders can be specified and will be shipped in lock packaging. For Master Keying System Summary form which should accompany the master keyed order, see page 283.

10. Select Handing (Field Reversible)

RHR	Right Handed Reverse	N/C
LHR	Left Handed Reverse	N/C

11. Select Battery

LLL	Less Battery Holder, Batteries, and Cover	DEDUCT \$25.90
4B	4AA Battery Kit	STANDARD
8B	8AA Battery Kit	\$39.00

12. -13. No Selection Required

14. Select Door Thickness

134	1-3/4"	STANDARD
Example 138	1-3/8" to 2-3/4", (Specify in 1/8" increments)	\$58.90

15. Select Options

LRX	Less Von Duprin low current Request-To-Exit switch	DEDUCT \$52.00
BAA	BAA Compliant Product	\$115.00

BAA compliant products must have the cover letter on page 301 included with the order. Failure to use this cover letter will result in the customer receiving non-BAA compliant product with no recourse for an RMA or refund. BAA compliant product requires a longer lead time, please contact customer service for details.

AD-402 Exit Trim comes with a universal mounting plate and is compatible with Von Duprin Series 98/99, 98/99XP, 22/22F exit devices and Falcon 25 rim exit devices with proper low current Request-To-Exit switch (RX-LC). Concealed Vertical Rod and Concealed Vertical Cable trim on metal door only.
When Request-to-exit is required, the Von Duprin RX-LC switch (part #050281) or Falcon AE switch (part #650359) must be used or the Warranty is void.
Note: AD-Series Non-Functioning "Dummy" Exit Trim now available. Please see pages 114-115 for details

- Notes:** 1) Connections other than Wiegand or Clock & Data may incur additional fee. Consult access control software provider for details.
 2) PIM400 required for connection to ACP; sold separately.
 a) PIM400-TD2 required for Wiegand or Clock and Data connection, see page 118.
 b) If RS485 connection to other ACP is required, contact software provider.

Standard accessories available, see pages 116-119.
 Standard accessories sold separately include Decorative Plates, Handheld Device, Dry Contact Board (RLBD), etc.

1-4. Select Chassis/ Exit Trim Type* /Reader

AD-993LLL	“Dummy” Trim Less Reader for Exit Rim/ ¹ Concealed Vertical Rod/ ¹ Concealed Vertical Cable /Surface Vertical Rod/Mortise Lock	See page 152
AD-993DT	“Dummy” Trim with “Dummy” Reader Cover for Exit Rim/ ¹ Concealed Vertical Rod/Surface Vertical Rod/Mortise Lock	See page 152

* See page 77 for exit device compatibility. ¹ Metal door only.



AD993DT

5. Select Lever*

LLL	Less interior and exterior levers	See page 152
SPA	Sparta	See page 152
RHO	Rhodes	See page 152
ATH	Athens	See page 152
TLR	Tubular	See page 152
BRW	Broadway	N/C
BRK	Boardwalk	N/C
LAT	Latitude	N/C
LON	Longitude	N/C

* Tactile Warning use 8AT for Athens, 8RO for Rhodes, 8SP for Sparta and 8TR for Tubular. \$45.60 per lever. Applied to exterior lever only unless otherwise specified. Not available with 643e finish.

6. Select Finish

626	Satin Chrome	See page 152
605	Bright Brass	See page 152
606	Satin Brass	See page 152
612	Satin Bronze	See page 152
619	Satin Nickel	See page 152
625	Bright Chrome	See page 152
643e	Aged Bronze	See page 152
626AM	Satin Chrome Antimicrobial	See page 152

7. Select Cylinder Type

P ●△	With Cylinder, Schlage- (Everest 29 S123, 6 Pin KIL standard)	See page 152
L	With Cylinder, Schlage- Everest 29 S123, 6 Pin KIL	See page 152
R ●□	With Cylinder, Schlage 6-Pin (Everest 29 S123 standard) FSIC	See page 152
J	Less cylinder, Schlage, 6 Pin SFIC	See page 152
G ●□	With Cylinder, Schlage 7-Pin (Everest 29R standard) (factory master keyed only) SFIC	See page 152
B	Less cylinder, Schlage, Falcon, Competitive OEM's, 7 Pin (SFIC)	See page 152
L SAR	Less cylinder, Sargent (10L + 11L), 6 Pin KIL	See page 152
L CO6	Less Cylinder, Corbin 8000, 6 Pin KIL	See Page 152
J SAR	Less Cylinder, Sargent 6300, 6 Pin FSIC	See page 152
J CO6	Less Cylinder, Corbin 8000, 6 Pin FSIC	See page 152
J CO7	Less Cylinder, Corbin 8000-7, 7 Pin FSIC, (Only RHO, 8RO, SPA, 8SP, TLR and 8TR)	See page 152
J MED	Less Cylinder, Medeco 32*0201, 6 Pin FSIC (Only RHO, 8RO, SPA, 8SP lever styles)	See page 152
J YA6	Less Cylinder, Yale 1210 or Medeco 31*0100, 6 Pin FSIC	See page 152
J YA7	Less Cylinder, Yale 1220, 7 Pin FSIC (Only RHO, 8RO, SPA, 8SP lever styles)	See page 152
L FA7	Less Cylinder, Falcon, 7 Pin, KIL (Only RHO, 8RO, SPA, 8SP lever styles)	See page 152

● Master Keyed cylinders can be specified and will be shipped in lock packaging. For Master Keying System Summary form which should accompany the master keyed order, see page 283.

△ For Master Keying, additional line item 50-210 is required, \$20.10 each.

□ Control Keys for installation/removal of interchangeable cores are not furnished and must be ordered separate. For additional assistance on Master Keying as well as restricted keyways please contact customer service.

Full Cylinder
PD LD LDSAR LDF A7

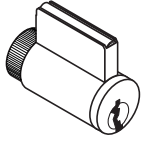

Full Size Interchangeable Core
RD JD JD SAR JD CO6 JD YA6 JD CO7

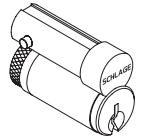

Small Format Interchangeable Core
GD BD

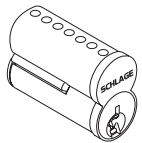

8. Select Keying Type

Open Keyway Families: KIL or FSIC ²		
S123	Everest 29 S (Key in Lever or FSIC)	See page 153
C/CE/E/EF/ F/ FG/ G	Classic Obverse	See page 153
Restricted Keyway Families: KIL or FSIC ^{1,2}		
29 T	Everest 29 T	See page 153
D	Everest D	See page 153
Classic Restricted	Quad, Numbered, Reverse	See page 153
Restricted Keyway Families: SFIC ³		
29R	Everest 29 R	See page 153
B	Everest B	See page 153

¹ Everest Restricted Keyways require a Letter of Authorization to be submitted with the order. See sample Letter of Authorization, see page 295.
² Full Size key systems (Everest 29 S & T, Everest C & D, Obverse & Quad) are available in Primus and Primus XP key system and must be ordered separately. Lock should be ordered less cylinder and Primus cylinder should be a separate line.
³ Master Keyed cylinders can be specified and will be shipped in lock packaging. For Master Keying System Summary form which should accompany the master keyed order, see page 283.

9. Select Handing (Field Reversible)

RHR	Right Handed Reverse	See page 153
LHR	Left Handed Reverse	See page 153

10. - 12. No Selection Required

13. Select Door Thickness

134	1-3/4"	See page 153
Example 178	1-7/8" to 2-3/4", (Specify in 1/8" increments)	See page 153

14. Select Options

BAA	BAA Compliant Product	See page 153
------------	-----------------------	--------------

BAA compliant products must have the cover letter on page 301 included with the order. Failure to use this cover letter will result in the customer receiving non-BAA compliant product with no recourse for an RMA or refund. BAA compliant product requires a longer lead time, please contact customer service for details.

AD-Series Exit Trim

The AD993DT Non-Functioning “Dummy” Trim comes with a universal mounting plate and is compatible with the following exit devices:

Von Duprin 98/99 and 98/99XP

Rim, Concealed Vertical Rod (metal door only), Concealed Vertical Cable (metal door only), Surface Vertical Rod, Mortise. Low current Request-to-Exit Switch optional for future network migration.

Von Duprin 22/22F

Rim, Surface Vertical Rod

Falcon 25 - Rim

Sargent 80 Series (Narrow design & reversible rim exits not compatible) - Rim

Corbin Russwin 5000 Series - Rim

Yale 7000 - Rim

Dorma 9300 - Rim

Precision 21 - Rim (2100 converts to 21 with Precision’s BP21 Kit)

Accessories available, see pages 116-119. Accessories include Panel Interface Mobile (PIM400) Decorative Plates, Handheld Device, etc. Credentials available, see pages 26-31.

Product ID	Product Description	Product Specification	Price
Handheld Device			
HHD KIT-USB	Handheld Device Kit	Includes Handheld Device pre-loaded with SUS Application, and HHD-USB Cable. Used to initialize, manage, and test AD and CO Series devices	See page 156
HH-USB	USB Replacement Cable	Used to connect Handheld Device to USB locks and accessories.	See page 156
Handheld Device Accessories (Legacy Product Support)			
HH-2PIN SERIAL	Serial Cable	Used to connect current model HHD (BM170) directly to legacy serial products without the need of a CIP	See page 156
HH-SERIAL	Serial Cable *	Used to connect previous model HHD (BM150) with CIP to program serial products.	See page 156
PIMWA-CV	Null Converter	Used to connect Handheld Device to WA Series PIM, using HH-SERIAL Serial Cable. (compatible to current and previous model HHDs)	See page 156
P512112	Computer Interface Module (CIP)*	Used to program serial products using HH-SERIAL Serial Cable.	See page 156
P101203	CIP with iButton Reader*	Used to program serial products using HH-SERIAL Serial Cable.	See page 156

* Not compatible to current HHD (BM170)

Reader Modules - (Select by Technology) - (Please specify FINISH - Example: KP-626)

KP	Keypad Only Reader Module	See page 156
MG	Magnetic Stripe (Insert) Reader Module - (Track 1, 2, or 3)	See page 156
MGK	Magnetic Stripe (Insert) with Keypad Reader Module - (Track 1, 2, or 3)	See page 156
MS	Magnetic Stripe (Swipe) Reader Module - (Track 1, 2, or 3)	See page 156
MSK	Magnetic Stripe (Swipe) with Keypad Reader Module - (Track 1, 2, or 3)	See page 156
MT	Multi-Technology Reader Module - (125 kHz Proximity and 13.56 MHz Smart)	See page 156
MTK	Multi-Technology with Keypad Reader Module - (125 kHz Proximity and 13.56 MHz Smart)	See page 156
SI	Smart Technology iClass Compatible Reader	See page 156
SIK	Smart Technology iClass Compatible Reader + Keypad	See page 156
FMK	FIPS Multi-Technology with Keypad Reader Module - (125 kHz Proximity and 13.56 MHz Smart)	See page 156
DT	Dummy Trim Reader Cover	See page 156

Reader Module Accessories

510310	Magnetic Stripe Cleaning Cards	See page 156
---------------	--------------------------------	--------------

Communication Module Kits - (Please specify FINISH - Example: COM200C-626)

COM200C	AD-200/AD-250 Offline Communication Kit (Cover)	Classroom/Storeroom Functions (Cylindrical and Exit Chassis)	See page 156
COM200L◆	AD-200/AD-250 Offline Communication Kit (Cover with Indicator Lens)	Privacy/Apartment Functions (Mortise Deadbolt Chassis)	See page 156
COM200P◆	AD-200/AD-250 Offline Communication Kit (Cover with Push Button)	Privacy/Apartment/Office Functions (Cylindrical and Mortise Chassis)	See page 156
COM300L◆■	AD-300 Hardwired Communication Kit (Cover with Indicator Lens, RS485 Communication PCB)	Classroom/Storeroom Functions (Cylindrical, Mortise and Exit Chassis) Privacy/Apartment Functions (Mortise Deadbolt Chassis)	See page 156
COM300P◆■	AD-300 Hardwired Communication Kit (Cover with Push Button, RS485 Communication PCB)	Privacy/Apartment/Office Functions (Cylindrical and Mortise Chassis)	See page 156
COM400L◆■	AD-400 Wireless Communication Kit (Cover with Indicator Lens, 900MHz Communication PCB)	Classroom/Storeroom Functions (Cylindrical, Mortise and Exit Chassis) Privacy/Apartment Functions (Mortise Deadbolt Chassis)	See page 156
COM400P◆■	AD-400 Wireless Communication Kit (Cover with Push Button, 900MHz Communication PCB)	Privacy/Apartment/Office Functions (Cylindrical and Mortise Chassis)	See page 156

◆ Must order and install Door Position Switch #46929121 for proper operation

■ Must order and install Pigtail Exit Adapter #23536774 for RX-LC switch if retrofitting AD-200-993 to AD-300-993 or AD-400-993

	Class	Chassis	Type	Classroom/ Storeroom (70)	Office (50)	Apartment (60)	Privacy (40)
OFFLINE	AD-200 & AD-250	CY	Cylindrical	COM200C	COM200P	COM200P	COM200P
	AD-200 & AD-250	MS	Mortise	COM200C	COM200P	COM200P	COM200P
	AD-200 & AD-250	MD	Mortise Deadbolt	N/A	N/A	COM200L	COM200L
	AD-200 & AD-250	993	Exit Trim	COM200C	N/A	N/A	N/A
NETWORKED	AD-300	CY	Cylindrical	COM300L	COM300P	COM300P	COM300P
	AD-300	MS	Mortise	COM300L	COM300P	COM300P	COM300P
	AD-300	MD	Mortise Deadbolt	N/A	N/A	COM300L	COM300L
	AD-300	993	Exit Trim	COM300L	N/A	N/A	N/A
	AD-400	CY	Cylindrical	COM400L	COM400P	COM400P	COM400P
	AD-400	MS	Mortise	COM400L	COM400P	COM400P	COM400P
	AD-400	MD	Mortise Deadbolt	N/A	N/A	COM400L	COM400L
	AD-400	993	Exit Trim	COM400L	N/A	N/A	N/A

Suffixes: C= Cover L= LED Only P= Pushbutton

Note: Connections other than Wiegand or Clock & Data may incur additional fee. Consult access control provider for details.

Pricing/product description subject to change without notice.

Product ID	Product Description	Price
------------	---------------------	-------

Door Position Switch

46929121	Door Position Switch	See page 215
----------	----------------------	--------------

Battery Cover - (Select by Battery Quantity) - (Please specify FINISH - Example: 4C-626)

4C (46929071)	4AA Battery Cover (with Screw)	See page 216
---------------	--------------------------------	--------------

8C (46929105)	8AA Battery Cover (with Screw)	See page 216
---------------	--------------------------------	--------------

Battery Holder & Cover Kit - (Select by Battery Quantity) - (Please specify FINISH - Example: 4B-626)

4B (46929055)	4AA Battery Holder & Cover Kit (Includes 4AA Battery Holder with Cable, 4AA Battery Strap, Battery Strap Screws, 4AA Battery Cover, Cover Screw, Torx Cover Screw)	See page 216
---------------	--	--------------

8B (46929089)	8AA Battery Holder & Cover Kit (Includes 8AA Battery Holder with Cable, 8AA Battery Strap, Battery Strap Screws, 8AA Battery Cover, Cover Screw, Torx Cover Screw, Mylar)	See page 216
---------------	---	--------------

Torx Tamper Screw Pack - (Select by Chassis Type) - (Please specify FINISH - Example: 23538812-626)

Cylindrical		
23538812	Torx Tamper Screw Pack	See page 216

Mortise		
23538820	Torx Tamper Screw Pack	See page 216

Exit		
23538838	Torx Tamper Screw Pack	See page 216

Decorative Plate - (Select by Size) - (Please specify FINISH - Example: 23760283-626)

23631823	1.5" x 3.25" x .105" Decorative Plate (with Screws) - (Exit Trim)	See page 215
----------	---	--------------

23760267	1.7" x 3.5" x .075" Decorative Plate (with Screws)	See page 215
----------	--	--------------

23760283	3.2" x 3.5" x .075" Decorative Plate (with Screws)	See page 215
----------	--	--------------

23760317	6.0" x 3.5" x .075" Decorative Plate (with Screws)	See page 215
----------	--	--------------

23760325	6.6" x 3.5" x .075" Decorative Plate (with Screws)	See page 215
----------	--	--------------

23760309	8.0" x 3.5" x .075" Decorative Plate (with Screws)	See page 215
----------	--	--------------

23760291	8.0" x 3.5" x .075" Decorative Plate (with Screws and Welded Standoff)	See page 215
----------	--	--------------

23760259*	10.5" x 3.5" x .075" Decorative Plate (no Screws necessary) - (Under Lock)	See page 215
-----------	--	--------------

23760275*	12.0" x 3.5" x .075" Decorative Plate (no Screws necessary) - (Under Lock)	See page 215
-----------	--	--------------

*Please consider overall Door Thickness when ordering

Note: Single Decorative Plate. Interior and Exterior Decorative Plates may be required.

Note: Decorative Plates may have multiple applications. Please refer to AD-Series Retrofit Template Overlay guide at www.schlage.com/support for more information.

Available Finishes: 626 Satin Chrome Standard. Please consult Customer Care for 605 Bright Brass or 643E Aged Bronze.

Shim Plates

23458607	Interior Shim Plate - (for AD-200/250/300)	See page 215
----------	--	--------------

23458565	Interior Shim Plate - (for AD-400)	See page 215
----------	------------------------------------	--------------

23458599	Exterior Shim Plate	See page 215
----------	---------------------	--------------

Note: Device is 0.063" thick

Wood Mounts

44-169	AD-Series Cylindrical Mount	See page 157
--------	-----------------------------	--------------

23740251	AD-Series Mortise Mount	See page 157
----------	-------------------------	--------------

23740269	AD-Series & CO Series Exit Trim Mount	See page 157
----------	---------------------------------------	--------------

Installation Tools

40-286	Universal Clamp	See page 157
--------	-----------------	--------------

40-288	AD Series cylindrical lock installation template	See page 157
--------	--	--------------

40-292	Universal cylindrical door position switch (DPS) installation template	See page 157
--------	--	--------------

40-287	AD Series mortise lock installation template	See page 157
--------	--	--------------

40-291	Universal mortise door position switch (DPS) installation template	See page 157
--------	--	--------------

IRDORCOR	3/8" Door Coring Fixture (Cores 3/8" bore in door from hinge side to lock)	See page 157
----------	--	--------------

Note: The universal clamp above is necessary when using the remaining products to ensure hole placement accuracy.

The "Universal" (Clamp & DPS) products are for use in all CO, AD and LE product installations.

AD-Series Networked Accessories



AD-SERIES

Networked

Standalone

Product ID	Product Description	Product Specification	Price
AD-300/302 Hardwired Accessories			
Panel Interface Board			
PIB300-2D*	Panel Interface Board (supports 2 doors)	Supports up to two AD-300 Locks. Wiegand or Clock & Data output. Includes Weatherproof Enclosure (7.1" x 7.1"), RS485 input. Requires 12 or 24 VDC Power Supply.	\$499.00
RLBD	Relay Board (for PIB300-2D or PIM400-TD2)	Optionally used with PIM300-2D or PIM400-TD2 to simplify installation with Access Control Panels that require relays. Configurable for Normally Open or Normally Closed.	\$253.00

Miscellaneous

798-12	Armored Door Cord	12" x 1/2"	\$77.00
798-18	Armored Door Cord	18" x 1/2"	\$97.00

AD-400/402 Wireless Accessories

Panel Interface Module			
PIM400-TD2*	Panel Interface Module (supports 2 doors)	Wiegand or Clock & Data output. Includes Weatherproof Enclosure (7.1" x 7.1"), Internal Antenna with ability to add Remote Antenna. Requires 12 or 24 VDC power supply. Relay Board sold separately.	\$879.00
RLBD	Relay Board (for PIB300-2D or PIM400-TD2)	Optionally used with PIM300-2D or PIM400-TD2 to simplify installation with Access Control Panels that require relays. Configurable for Normally Open or Normally Closed.	\$253.00

Wireless Portable Readers

WPR400-DT	Wireless Portable Signal Tester (with Dummy Trim Reader Cover)	Handheld, battery-operated signal tester with non-functioning Dummy Trim Reader Cover.	\$1,345.00
WPR400-KP	Wireless Portable Reader (with Keypad Only Reader Module)	Handheld, battery-operated unit with Keypad Only Reader Module.	\$1,852.00
WPR400-MG	Wireless Portable Reader (with Magnetic Stripe (Insert) Reader Module)	Handheld, battery-operated unit with Magnetic Stripe (Insert) Reader Module.	\$1,962.00
WPR400-MGK	Wireless Portable Reader (with Magnetic Stripe (Insert) with Keypad Reader Module)	Handheld, battery-operated unit with Magnetic Stripe (Insert) with Keypad Reader Module.	\$2,035.00
WPR400-MS	Wireless Portable Reader (with Magnetic Stripe (Swipe) Reader Module)	Handheld, battery-operated unit with Magnetic Stripe (Swipe) Reader Module.	\$1,953.00
WPR400-MSK	Wireless Portable Reader (with Magnetic Stripe (Swipe) with Keypad Reader Module)	Handheld, battery-operated unit with Magnetic Stripe (Swipe) with Keypad Reader Module.	\$2,019.00
WPR400-MT	Wireless Portable Reader (with Multi-Technology Reader Module)	Handheld, battery-operated unit with Multi-Technology Reader Module.	\$2,052.00
WPR400-MTK	Wireless Portable Reader (with Multi-Technology with Keypad Reader Module)	Handheld, battery-operated unit with Multi-Technology with Keypad Reader Module.	\$2,117.00
WPR400-SI	Wireless Portable Reader (with Smart-Technology iClass Reader Module)	Handheld, battery-operated unit with Smart-Technology iClass Compatible Reader Module.	\$2,088.00
WPR400-SIK	Wireless Portable Reader (with Smart-Technology iClass Keypad Reader Module)	Handheld, battery-operated unit with Smart-Technology iClass Compatible with Keypad Reader Module.	\$2,150.00
WPR402-FMK	Wireless Portable Reader (with FIPS Multi-Technology with Keypad Reader Module)	Handheld, battery-operated unit with FIPS Multi-Technology with Keypad Reader Module.	\$2,324.00
24885600	WPR400/TK400 Battery Conversion Kit (includes 8AA Batteries, 8AA Battery Holder with appropriate mounting hardware pre-mounted in a new base)	Converts from the Proprietary battery pack to 8 Off-the-Shelf AA batteries	\$100.00

Note: Connections other than Wiegand or Clock & Data may incur additional fee. Consult access control provider for details.

* For BAA compliant PIB300-2D or PIM400-TD2 add \$25.00. Use suffix BAA.

BAA compliant products must have the cover letter on page 301 included with the order. Failure to use this cover letter will result in the customer receiving non-BAA compliant product with no recourse for an RMA or refund. BAA compliant product requires a longer lead time, please contact customer service for details.

Pricing/product description subject to change without notice.

Product ID	Product Description	Product Specification	Price
AD-400 Wireless Accessories (continued)			
Control Kits			
ECK400	Elevator Control Kit	Includes WRI400, PIM400-TD2, ANT400-REM-I/O, 12 VDC Power Supply.	\$2,922.00
GCK400	Gate Control Kit	Includes WRI400, PIM400-TD2, ANT400-REM-I/O, MGB+MCA5, 12 VDC Power Supply.	\$3,053.00
Wireless Reader Interface - (Outdoor)			
WRI400	Outdoor Wireless Reader Interface	Compatible with Wiegand or Clock & Data. Includes Weatherproof Enclosure, inputs for two parallel readers. Requires 12 or 24 VDC power supply.	\$1,035.00
Wireless Test Kit			
TK400	Wireless Test Kit	Pre-Installed Test Kit; Complete with WPR400-DT, PIM400-TD2, 593PI Power Supply, Charger, Carrying Case.	\$1,720.00
Wireless Repeater Kit			
REPTR400	Wireless Repeater Kit	Complete with PIM400-TD2 and WRI400.	\$1,913.00
Remote Antennas			
ANT400-REM-I/O	Omni-Directional Remote Indoor/Outdoor Antenna Module	Includes Antenna, 15' Coax, Coax Whip, Articulated Wall/Post Mounting Hardware. For indoor use with PIM400 and/or WRI400. Requires MGB+MCA5 Antenna Grounding Kit for outdoor applications.	\$564.00
ANT400-REM-I/O+6DB	Directional Remote Indoor/Outdoor Antenna Module with 6dB Gain	Includes Antenna, 15' Coax, Coax Whip, Articulated Wall/Post Mounting Hardware. For indoor use with PIM400 and/or WRI400. Requires MGB+MCA5 Antenna Grounding Kit for outdoor applications.	\$545.00
ANT400-REM-CEILING	Omni-Directional Remote Indoor/Outdoor Antenna Module	Includes Antenna, 15' Coax, Coax Whip. For indoor use with PIM400 and/or WRI400.	\$415.00
ANT400-REM-HALL	Bi-Directional Remote Indoor Antenna Module	Includes Antenna, 15' Coax, Coax Whip. For indoor use with PIM400 and/or WRI400.	\$591.00
Antenna Grounding Kit			
MGB+MCA5	Antenna Grounding Kit (for outdoor mounting)	May be used with ANT400-REM-I/O, ANT400-REM-I/O+6DB, ANT400-REM-CEILING, ANT400-REM-HALL.	\$195.00
Power Supply			
593PI-12DC	120 VAC to 12 VDC Power Supply	Used to power PIM-TD2, PIM-TD4, PIM-EXP, WRI-OTD-12 VDC, and WRI-IN-12 VDC as well as PIM400 and WRI400.	\$121.00

Note: Connections other than Wiegand or Clock & Data may incur additional fee. Consult access control provider for details.

AD-SERIES STANDALONE - TABLE OF CONTENTS	
HOW TO ORDER	122
AD-SERIES STANDALONE LOCKS & DEVICES OVERVIEW	123
AD-200 STANDALONE HARDWIRED	134
Cylindrical	134
Mortise/Mortise Deadbolt	136
Exit Trim	138
AD-201 STANDALONE HARDWIRED (FIPS 201-2 COMPLIANT); RIGHTS ON LOCK	140
Cylindrical	140
Mortise/Mortise Deadbolt	142
Exit Trim	144
AD-250 STANDALONE, RIGHT ON CARD	146
Cylindrical	146
Mortise/Mortise Deadbolt	148
Exit Trim	150
AD-SERIES 993 NON-FUNCTIONING "DUMMY" TRIM	152
CT5000 OFFLINE CONTROLLERS	154
AD SERIES STANDALONE ACCESSORIES	156

CONTACT INFORMATION FOR AD-SERIES STANDALONE LOCKS & DEVICES

Payment Address: Schlage Electronic Security
 15934 Collections Center Drive
 Chicago, IL 60693

877-671-7011	
Customer Service:	Technical Support:
Order Status, Credit Returns of Non-Defective Products, General Sales Questions	Technical Questions/Issues, Returns of Defective Products, Repairs
Email Orders To: Order_Entry_Schlage_Commercial@allegion.com	Contact For Technical Assistance: Electronic_Lock_TechProdSupport@allegion.com

For AD-Series Standalone Locks & Devices Warranty Information please see pages 10-13.

Pricing/product description subject to change without notice.

How to Order:

REQUIRED FIELDS

FACTORY DEFAULT AND OPTIONS

AD – 200 – CY – 70 – MG – SPA – 626 – PD – SI23 – RH – 4B – 13-247 – 10-025 – 1-3/4 – BAA

1. Series

2. Class

- 200 Rights on Lock
- 201 FIPS Compliant
- 250 Rights on Magnetic Card

3. Chassis:

- CY Cylindrical
- MS Mortise
- MD Mortise Deadbolt
- 993R Exit Trim – Rim/CVR/CVC
- 993S Exit Trim – SVR
- 993M Exit Trim – Mortise
- 993DT "Dummy" Exit Trim

4. Function:

- 70 Classroom/Storeroom
- 50 Office
- 40 Privacy
- 60 Apartment

5. Reader:

- KP Keypad
- MGK Magnetic Stripe + Keypad (Insert)
- MG Magnetic Stripe (Insert)
- MSK Magnetic Stripe + Keypad (Swipe)
- MS Magnetic Stripe (Swipe)
- MTK Multi-Technology + Keypad
- MT Multi-Technology
- FMK FIPS 201-2 Compliant Multi-Technology + Keypad

6. Lever: △

- SPA Sparta ATH Athens
 - RHO Rhodes TLR Tubular
- △ To add tactile warning, use prefix 8. Example 8SPA

7. Finish:

- 626 Satin Chrome
- 605 Bright Brass
- 606 Satin Brass
- 612 Satin Bronze
- 619 Satin Nickel
- 625 Bright Chrome
- 643e Aged Bronze
- 626AM Satin Chrome (Antimicrobial Coating)

8. Cylinder Type:

- PD Schlage 6-pin Full Cylinder
- For options see individual Class/Chassis page

9. Keyway Type:

- SI23 Everest 29
- For options see individual Class/Chassis page

10. Handing:

- RH Right Handed
- LH Left Handed
- RHR Right Handed Reverse
- LHR Left Handed Reverse

11. Battery Holder:

- 4B - 4AA Battery Kit 8B - 8AA Battery Kit

12. Backset and Latch or Armor Front:

- 13-247 2-3/4" Backset, Deadlatch, Square Corner, 1-1/8" x 2-1/4" (Standard on CY Chassis)
 - 09-663 Armor Front, 1-1/4" Wide, Square Corner (Standard on MS Chassis)
- For options see individual Class/Chassis page

13. Strike:

- 10-025 1-3/16" Lip, ANSI, no box, 1-1/4" x 4-7/8" (Standard on CY Chassis)
 - 10-072 1-3/16" Lip, 1-1/4" x 4-7/8" square corner, box (Standard on MS Chassis)
- For options see individual Class/Chassis page

14. Door Thickness:

- 1-3/4" (Standard)
- For options see individual Class/Chassis page

15. Additional Options

Pricing/product description subject to change without notice.

AD-Series Standalone Locks

With the AD-Series, one platform translates to an endless number of adaptable solutions. You can choose the features and functions that are right for the application today, and upgrade to meet your evolving needs in the future.

Class

AD-200	Standalone, User Rights on the Lock. Computer or Manually Programmable. Keypad, Multi-technology or Magnetic Stripe reader options available.	
AD-201	FIPS 201-2 Compliant Standalone, User Rights on the Lock. Computer Programmable with FIPS 201-2 Compliant multi-technology reader.	
AD-250	Standalone, user rights on magnetic stripe card. Computer programmable. Magnetic stripe or magnetic stripe + keypad reader options available	

Note: 1. AD-Series locks are upgradable from standalone to networked by applying a communication module available in the accessories section and new firmware available on www.schlage.com/support.

Chassis

CY: Cylindrical	Bored lock installed into a round hole in door	
MS: Mortise	Lock case installed into a mortise rectangular "pocket" in the door	
MD: Mortise Deadbolt	Mortise lock with built-in interconnected auxiliary deadbolt	
993R: Exit Trim	Rim/Concealed Vertical Rod* (CVR) & Concealed Vertical Cable* (CVC) *Metal door only	
993M: Exit Trim	Mortise	
993S: Exit Trim	Surface Vertical Rod (SVR)	
993DT: Exit Trim	Non-Functioning "Dummy" Exit Trim	

Note: 2. Exit trim utilizes universal hardware to simplify installation to a variety of exit device. AD-Series networked locks require a request to exit switch, please see compatibility below.

Exit Device Compatibility

Exit trim utilizes universal hardware to simplify installation to a variety of exit devices.

Exit Device Compatibility		Rim	SVR	CVR/CVC	Mortise
Von Duprin	98/99 and 98/99XP	●	●	●*	●
Von Duprin	22/22F	●	●		
Falcon	25	●			
Corbin Russwin®	5000	●			
Precision™	21 (2100 converts to 21 with Precision's BP21 kit)	●			
Yale®	7000	●			
Dorma®	9300	●			
Sargent®	80	●†			







● AD-200 and 250 Offline locks only. * Metal door only. † Narrow design and reversible rim exits not compatible

Pricing/product description subject to change without notice.







Function

AD-200/201

AD-250

<p>70: Classroom/ Storeroom</p>	<p>Lockset is normally secure. Inside lever always allows free egress. Valid toggle credentials on the exterior may be used to change to a passage or secured status.</p>	<p>No button</p> 	<p>No button</p> 
<p>50: Office</p>	<p>Lockset is normally secure. Inside lever always allows free egress. Interior pushbutton on inside housing may be used to select a passage or secured status. Meets need for lockdown function for safety and security. NOTE: Valid toggle credentials on the exterior may also be used to change status. Has interior pushbutton (IPB).</p>		
<p>40: Privacy</p>	<p>Lockset is normally secure. Inside lever always allows free egress. Interior pushbutton on inside housing may be used to select a privacy status. The interior pushbutton will disable normal electronic access from the exterior. Opening the door or pressing the interior pushbutton a second time on the inside housing deactivates the privacy status. Has interior pushbutton (IPB).</p>	<p>Privacy button</p> 	<p>Privacy button</p> 
<p>60: Apartment</p>	<p>Lockset is normally secure. Inside lever always allows free egress. Interior-pushbutton on inside housing may be used to select a passage or secured status. Opening the door or pressing the interior pushbutton causes the lockset to toggle unsecured. While toggled unsecured, the lockset can only be secured while the door is closed by pressing the interior pushbutton or using a normal credential on the exterior. Normal electronic access from the exterior is always allowed. Has interior pushbutton.</p>		

Reader

<p>KP: Keypad</p>	<p>12 button design</p>	
<p>MGK: Magnetic Stripe + Keypad (Insert)</p>		
<p>MG: Magnetic Stripe (Insert)</p>		
<p>MSK: Magnetic Stripe + Keypad (Swipe)</p>	<p>Configurable to read the complete Track 1, 2 or 3. Available with and without 12 button keypad.</p>	
<p>MS: Magnetic Stripe (Swipe)</p>		
<p>MTK: Multi-Technology + Keypad</p>		
<p>FMK: FIPS Compliant Multi-Technology + Keypad</p>	<p>Single solution that reads 125 kHz proximity and 13.56 MHz smart credentials. Available with and without 12-button keypad</p>	
<p>MT: Multi-Technology</p>		

- Notes:**
- 4. Please refer to AD-Series data sheets and solution sheets prior to ordering to verify credential compatibility.
 - 5. FMK reader now sold separately for field upgrades.
 - 6. Must specify finish when ordering reader separately. KP, MGK, MG, MSK & MS readers available in 626, 605, 606, 612, 619, 625 & 643e. MT, MTK & FMK readers are available in Grey (for 619, 626, 626AM & 625) and available in Brown (for 605, 606, 612 & 643e).

Pricing/product description subject to change without notice.

Lever

RHO	Rhodes		
SPA	Sparta		
TLR	Tubular		
ATH	Athens		
BRW	Broadway		
BRK	Boardwalk		
LAT	Latitude		
LON	Longitude		

- Notes:**
- All lever designs are available in finishes 605, 606, 612, 619, 625, 626, 643E and 626AM.
 - SPA, TLR & ATH Meet California Fire Code for 1/2" or less return to the door.
 - Changing Lever Cylinder Compatibility on a device typically requires replacement of existing spring cage and tailpiece
 - To order tactile warning levers use 8AT for Athens, 8RO for Rhodes, 8SP for Sparta and 8TR for Tubular. Applied to exterior lever only unless otherwise specified. Not available with 643e finish.
 - AD Series, CO Series and ND Series levers may be interchangeable in some cases depending whether it is an interior or exterior lever, the type of chassis and the type of cylinder/ spring cage/ tail piece. Please consult the AD Series Parts guide for more information.



Finish

626	Satin Chrome	BHMA # 626E, Government # US26D
605	Bright Brass	BHMA # 605E, Government # US3
606	Satin Brass	BHMA # 606E, Government # US4
612	Satin Bronze	BHMA # 612E, Government # US10
619	Satin Nickel	
625	Bright Chrome	BHMA # 625E, Government # US26
643e	Aged Bronze	
626AM	Satin Chrome Antimicrobial	

Note: 12. Please refer to the Electronic Access Control catalog or online product information at us.allegion.com to view each finish.

Pricing/product description subject to change without notice.

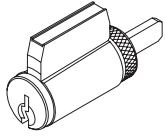
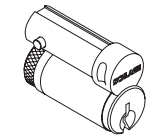
Cylinder

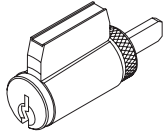
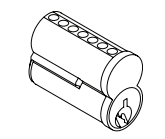
P	With cylinder Schlage- Everest 29 S123 6 Pin Key-in-Lever (KIL) Keyed different as standard with two keys	
L	Less cylinder Schlage, Falcon 6 Pin Key-in-Lever (KIL)	
R	With cylinder Schlage- Everest 29 S123 6 Pin Full Size Interchangeable Core (FSIC) Keyway one bitted as standard with two keys	
J	Less cylinder Schlage 6 Pin Full Size Interchangeable Core (FSIC)	
G	With cylinder Schlage Everest 29 R 7 Pin Small Format Interchangeable Core (SFIC) Factory master keyed with two keys as standard, master keying must be specified	
B	Less cylinder Schlage, Falcon, Competitive OEM's 7 Pin Small Format Interchangeable Core (SFIC)	
L SAR	Less cylinder Sargent (10L+11L) 6 Pin Key-in-Lever (KIL)	
LC06	Less cylinder Corbin 8000 6 Pin Key-in-Lever (KIL)	
JDSAR	Less cylinder Sargent 6300 6 Pin Full Size Interchangeable Core (FSIC)	
JC06	Less cylinder Corbin 8000 6 Pin Full Size Interchangeable Core (FSIC)	
JC07	Less cylinder Corbin 8000-7 7 Pin Full Size Interchangeable Core (FSIC) (Only RHO, 8RO, SPA, 8SP, TLR, 8TR)	
JMED	Less cylinder Medeco 32*0201 6 Pin Full Size Interchangeable Core (FSIC)	
JYA6	Less cylinder Yale 1210 or Medeco 31*0100 6 Pin Full Size Interchangeable Core (FSIC)	
JYA7	Less cylinder Yale 1220 7 Pin Full Size Interchangeable Core (FSIC)	
L FA7	Less cylinder Falcon 7 Pin Key-in-Lever (KIL) (Only RHO, 8RO, SPA, 8SP lever styles)	

- Notes:**
- 13. Competitor lever designs come in finishes 626 standard, and 605, 606, 612, 619, 625, 643e, and 626AM with extended lead-times.
 - 14. For P, R and G -Master Keyed cylinders can be specified and will be shipped in lock packaging.
 - 15. For Master Key System Summary form which should accompany the master keyed order, see pages 283-293.
 - 16. For Master Keying, additional line item 50-210 is required for Classic and Everest cylinders.
 - 17. Control Keys for installation/removal of interchangeable cores are not furnished and must be ordered separate.
 - 18. For additional assistance on Master Keying as well as restricted keyways please contact your local sales representative.
 - 19. Spring cages & tail pieces are different based on the type of cylinder and chassis selected. Please see the AD-Series parts guide for more information.
 - 20. The AD-Series accepts many popular models of standard, SFIC, and FSIC cylinders. Consult the Keyway/Cylinder compatibility datasheet (010432) for details. See pricebook for specific configurations.

Pricing/product description subject to change without notice.

Key Systems Available Through Schlage

Everest 29 S Keyway Family	Patent protected open keyways that are available in full size key in lever and full size interchangeable core (FSIC) formats. Patent protection through 2029.
Everest 29 T Keyway Family	Patent protected restricted keyways that are available in full size key in lever and full size interchangeable core (FSIC) formats. Patent protection through 2029.
Everest D Keyway Family	Restricted keyways that are available in full size key in lever and full size interchangeable core (FSIC) formats.
Everest C Keyway Family	Open keyways that are available in full size key in lever and full size interchangeable core (FSIC) formats. R
Schlage Classic Open Keyways	Classic (C/E/F): Open keyways available in key in lever and full size interchangeable core designs
Everest B Keyway Family	Restricted keyways that are available on small format interchangeable core (SFIC).
Everest 29 R Keyway Family	Patent protected restricted keyways that are available on small format interchangeable core (SFIC). Patent protection through 2029.

- Notes:** 21. Everest Restricted Keyways require a Letter of Authorization to be submitted with the order.
 22. See sample Letter of Authorization page 295.
 23. Full Size key systems (Everest 29 S & T, Everest C & D, Obverse & Quad) are available in Primus and Primus XP key system and must be ordered separately. Lock should be ordered less cylinder and Primus cylinder should be a separate line.
 24. Contact your local RSO representative for assistance in determining which format and level of exclusivity best suits your needs.

Handing

RH	Right Handed: Hinges on Right Opens Inward	
LH	Left Handed: Hinges on left Opens Inward	
RHR	Right Handed Reverse: Hinges on Right Opens Outward	
LHR	Left Handed Revers: Hinges on Left Opens Outward	

- Notes:** 25. Exit trim 993 chassis available only with RHR or LHR option.
 26. Handing is field reversible, but requires removal of the exterior escutcheon cover. Please see AD- Series installation instructions for details.

Battery

4B	4AA Battery Holder and Cover Kit	
8B	8AA Battery Holder and Cover Kit	

- Notes:** 27. AD-Series locks use standard off the shelf AA batteries.

Pricing/product description subject to change without notice.

Backset & Latchbolt (Cylindrical Chassis)



<p>13-247</p>	<p>2-3/4" Backset, Deadlatch, Square corner, 1-1/8" x 2-1/4"</p>	
<p>14-049</p>	<p>2-3/4" Backset, Deadlatch Anti-friction fire door latch, Square corner, 1-1/8" x 2-1/4", 3/4" throw</p>	
<p>14-051</p>	<p>2-3/8" Backset, Deadlatch Square corner, 1-1/8" x 2-1/4"</p>	
<p>14-050</p>	<p>3-3/4" Backset, Deadlatch Square corner, 1-1/8" x 2-1/4"</p>	
<p>43-001</p>	<p>5" Backset extension link, Deadlatch</p>	
<p>39-030</p>	<p>Rabbeted latch and strike kit, 605 and 626 only. Adapts square corner latch and 2-3/4" square corner strike to 1/2" rabbeted door and frame.</p>	<p>no image available</p>

Mortise Lock Armor Front (Mortise/Mortise Deadbolt Chassis)

<p>09-663</p>	<p>1-1/4" Wide Square Corner, Latch for MS</p>	
<p>09-669</p>	<p>1-1/16" Wide Square Corner, Latch, options for MS</p>	
<p>09-666</p>	<p>1-1/4" Wide Square Corner, Latch x Deadbolt for MD</p>	
<p>09-672</p>	<p>1-1/16" Wide Square Corner, Latch x Deadbolt, Options for MD</p>	

Notes: 28. For 1-3/4" thick doors, use wide armor front. For over 1-3/4" thick door extended equally (EE), use 1-1/4" wide armor front.
 29. Available finishes are 605, 606, 612, 619, 625, and 626.
 30. Images not shown to scale. Consult AD-Series Parts Guide for more information.

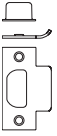
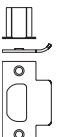
Strike Plate (Cylindrical Chassis)

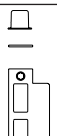
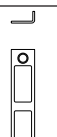
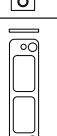
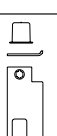
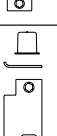
10-025	1-3/16" Lip, ANSI, no box, 1-1/4" x 4-7/8",	
10-013	1-1/8" Lip, Square Corner, T-strike, box, 1-1/8" - 2-3/4", 1-1/2" Lip available, must specify 1-1/2" Lip	
10-016	1-1/8" Lip, Square Corner, T-strike, deep box, fire door latch	
K510-066	Box for ANSI strike (Must be specific)	
10-072	1-3/16" Lip, 1-1/4" x 4-7/8", Square Corner, box	
10-072	7/8", 1", 1-1/2", 1-3/4", or 2" Lip, 1-1/4" x 4-7/8", Square Corner, box	
10-075	1/2" Rabbeted, For 1-3/4" thick doors, use wide armor front. For over 1-3/4" thick door extended equally (EE) use 1-1/4" wide armor front.	
37-015	Strike Frame Reinforcer, specify 37-015	
XL11-820	One hole for latching functions, RH & LHR doors Lip 1-3/16"	
XL11-821	One hole for latching functions, LH & RHR doors Lip 1-3/16"	
XQ07-351-134	Strike, ANSI, No Box, 1-1/4" x 4-7/8", 1-3/4" Lip Length	Image not available
XQ03-494-134	Strike, Square Corner, T-strike, Box, 1-1/8" x 2-3/4", 1-3/4" Lip	Image not available

Note: 33. XL11-820 & XL11-821 Extended lead time; contact customer service.

Pricing/product description subject to change without notice.

Door Thickness

1-3/4"	1-3/4"
1-3/8"	1-3/8" to 2-3/4", Shims included (Specify in 1/8" increments)

- Notes:**
- 32. *Door Thickness Kits are available on page 215 to install a lock on a door that is thicker or thinner than 1-3/4". See AD-Series Parts guide for details. Locks cannot be installed on doors thicker than 2-3/4" or thinner than 1-3/8".*
 - 33. *Thin Door Shims are available on page 215 to install a lock on a door that is thinner than 1-3/4".*
 - 34. *Decorative Plates are used to cover exposed holes when retrofitting from existing locks to AD-Series locks. The size of plate required will vary based on the size and location of holes being covered. Retrofit information can be found at www.schlage.com/support.*
 - 35. *If under the lock decorative plates are on both sides of device, then door will become 1/8" thicker. A Door Thickness Kit of an incremental 1/8" must be ordered to accommodate under the lock plates.*



AD-Series Standalone Locks - Ordering Guide

AD-SERIES

Networked

Standalone

Customer Name:

Customer Address:

Ship To:

Account #:

Quote #:

PO # & Date:

Price book #:

Shipping Instructions:

Requested Ship Date:

Order Written By:

For Further Information Contact
(Name, Phone, Fax)

	Quantity	1. Series	2. Class	3. Chassis ¹	4. Function ²	5. Reader ³	6. Lever	7. Finish	8. Cylinder	9. Keyway	10. Handling	11. Battery ⁴	12. Backset & Latch ⁵ or Armor Front ⁶	13. Strike ⁷	14. Door Thickness ⁸	15. Options
Ex.	1	AD	200	CY	70	KP	SPA	626	PD	SI23	RH	4B	13-247	10-025	1-3/4	BAA

Please complete all information above and email order to:

Order_Entry_Schlage_Commercial@allegion.com

¹ If Exit trim is chosen, no selections are required for options #12 & #13
² Function: 70 classroom storeroom is standard if no selection is made
³ Reader: KP keypad is standard if no selection is made
⁴ Battery: 4B standard if no selection is made
⁵ Backset & Latch: 13-247 standard for cylindrical if no selection is made
⁶ Armor Front: 09-663 standard for mortise if no selection is made, 09-666 standard for mortise deadbolt if no selection is made
⁷ Strike Plate: 10-025 standard for cylindrical if no selection is made, 10-072 standard for mortise/mortise deadbolt if no selection is made
⁸ Door Thickness: 1-3/4" standard if no selection is made

Pricing/product description subject to change without notice.





1-4. Select Chassis/Function

AD-200-CY-70*	Classroom/Storeroom	\$1,847.00
AD-200-CY-50*	Office	\$1,857.00
AD-200-CY-40	Privacy	\$1,857.00
AD-200-CY-60	Apartment	\$1,857.00

* Less Door Position Switch, use suffix LDP. Deduct \$19.50



AD-200-CY-70-KP



MG



MGK



MS



MSK



MT/SI



MTK/SIK/FMK

5. Select Reader **Note:** Reflects list price adder to base keypad reader price of \$537.00.

LLL	Less Reader (For reader module accessories sold separately, see page 156)	DEDUCT \$537.00
KP	Keypad	STANDARD
MS	Magnetic Stripe (Swipe)	\$100.00
MSK	Magnetic Stripe (Swipe) + Keypad	\$166.00
MG	Magnetic Stripe (Insert)	\$116.00
MGK	Magnetic Stripe (Insert) + Keypad	\$184.00
MT	Multi-Technology Proximity and Smart Card	\$199.00
MTK	Multi-Technology + Keypad Proximity and Smart Card	\$264.00

6. Select Lever*

LLL	Less interior and exterior levers	DEDUCT \$46.40
Standard Options:	SPA (Sparta), RHO (Rhodes), ATH (Athens), TLR (Tubular), BRW, (Broadway), BRK (Boardwalk), LAT (Latitude), LON (Longitude)	N/C

* Tactile Warning use BAT for Athens, BRO for Rhodes, BSP for Sparta and BTR for Tubular. \$45.60 per lever. Applied to exterior lever only unless otherwise specified. Not available with 643e finish.

7. Select Finish

626	Satin Chrome	N/C
605	Bright Brass	\$139.00
606	Satin Brass	\$139.00
612	Satin Bronze	\$139.00
619	Satin Nickel	\$139.00
625	Bright Chrome	\$139.00
643e	Aged Bronze	\$139.00
626AM	Satin Chrome Antimicrobial	\$179.00

8. Select Cylinder Type

P ● △	With Cylinder, Schlage- (Everest 29 S123, 6 Pin KIL standard)	N/C
L	Less Cylinder, Schlage, Falcon, 6 Pin KIL	DEDUCT \$64.00
R ● □	With Cylinder, Schlage 6-Pin (Everest 29 S123 standard) FSIC	\$38.00
J	Less Cylinder, Schlage, 6 Pin FSIC	DEDUCT \$35.00
G ● □	With Cylinder, Schlage 7-Pin (Everest 29R standard) (factory master keyed only) SFIC	\$84.00
B	Less Cylinder, Schlage, Falcon, Competitive OEM's, 7 Pin (SFIC)	N/C
L SAR	Less Cylinder, Sargent (10L + 11L), 6 Pin KIL	DEDUCT \$64.00
L CO6	Less Cylinder, Corbin 8000, 6 Pin KIL	DEDUCT \$64.00
J SAR	Less Cylinder, Sargent 6300, 6 Pin FSIC	DEDUCT \$35.00
J CO6	Less Cylinder, Corbin 8000, 6 Pin FSIC	DEDUCT \$35.00
J CO7	Less Cylinder, Corbin 8000-7, 7 Pin FSIC, (Only RHO, 8RO, SPA, 8SP, TLR and 8TR)	DEDUCT \$35.00
J MED	Less Cylinder, Medeco 32*0201, 6 Pin FSIC (Only RHO, 8RO, SPA, 8SP lever styles)	DEDUCT \$35.00
J YA6	Less Cylinder, Yale 1210 or Medeco 31*0100, 6 Pin FSIC	DEDUCT \$35.00
J YA7	Less Cylinder, Yale 1220, 7 Pin FSIC (Only RHO, 8RO, SPA, 8SP lever styles)	DEDUCT \$35.00
L FA7	Less Cylinder, Falcon, 7 Pin, KIL (Only RHO, 8RO, SPA, 8SP lever styles)	DEDUCT \$35.00

● Master Keyed cylinders can be specified and will be shipped in lock packaging. For Master Keying System Summary form which should accompany the master keyed order, see page 283.

△ For Master Keying, additional line item 50-210 is required, \$20.10 each.

□ Control Keys for installation/removal of interchangeable cores are not furnished and must be ordered separate.

For additional assistance on Master Keying as well as restricted keyways please contact customer service.

Full Cylinder
PD LD LDSAR LDFA7

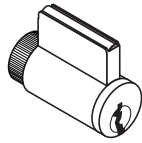

Full Size
Interchangeable Core
RD JD JD SAR JD CO6 JD YA6
JD CO7

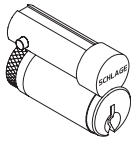

Small Format
Interchangeable Core
GD BD

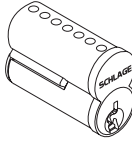

9. Select Keying Type

Open Keyway Families: KIL or FSIC ²		
S123	Everest 29 S (Key in Lever or FSIC)	STANDARD
C123	Everest C	N/C
C/CE/E/EF/ F/ FG/ G	Classic Obverse	N/C
Restricted Keyway Families: KIL or FSIC ^{1,2}		
29 T	Everest 29 T	\$17.50
D	Everest D	\$17.50
Classic Restricted	Quad, Numbered, Reverse	\$17.50
Restricted Keyway Families: SFIC ³		
29 R	Everest 29 R	N/C
B	Everest B	N/C

¹ Everest Restricted Keyways require a Letter of Authorization to be submitted with the order. See sample Letter of Authorization, see page 295.

² Full Size key systems (Everest 29 S & T, Everest C & D, Obverse & Quad) are available in Primus and Primus XP key system and must be ordered separately. Lock should be ordered less cylinder and Primus cylinder should be a separate line.

³ Master Keyed cylinders can be specified and will be shipped in lock packaging. For Master Keying System Summary form which should accompany the master keyed order, see page 283.

10. Select Handing (Field Reversible)

RH	Right Handed	N/C
LH	Left Handed	N/C
RHR	Right Handed Reverse	N/C
LHR	Left Handed Reverse	N/C

11. Select Battery

LLL	Less Battery Holder, Batteries, and Cover	DEDUCT \$25.80
4B	4AA Battery Kit	STANDARD
8B	8AA Battery Kit	\$39.00

12. Select Backset & Latchbolt

LLL	Less Latch	DEDUCT \$34.20
13-247	2-3/4" Backset, Deadlatch, Square corner, 1-1/8" x 2-1/4"	STANDARD
14-049	2-3/4" Backset, Deadlatch Anti-friction fire door latch, Square corner, 1-1/8" x 2-1/4", 3/4" throw	\$181.00
14-051	2-3/8" Backset, Deadlatch Square corner, 1-1/8" x 2-1/4"	N/C
14-050	3-3/4" Backset, Deadlatch Square corner, 1-1/8" x 2-1/4"	\$10.70
43-001	5" Backset extension link, Deadlatch	\$33.10
39-030*	Rabbeted latch and strike kit, 605 and 626 only	\$58.10

* Adapts square corner latch and 2-3/4" square corner strike to 1/2" rabbeted door and frame.

13. Select Strike Plate

LLL	Less Strike Plate	DEDUCT \$4.50
10-025	1-3/16" Lip, ANSI, no box, 1-1/14" x 4-7/8"	STANDARD
10-013*	1-1/8" Lip, Square Corner, T-strike, box, 1-1/8" - 2-3/4"	N/C
10-016	1-1/8" Lip, Square Corner, T-strike, deep box, fire door latch	\$15.70
K510-066	Box for ANSI strike (Must be specific)	N/C

* 1-1/2" Lip available, must specify 1-1/2" Lip \$8.00

14. Select Door Thickness

134	1-3/4"	STANDARD
Example 138	1-3/8" to 2-3/4", Shims included (Specify in 1/8" increments)	\$58.90

15. Select Options

BAA	BAA Compliant Product	\$115.00
------------	-----------------------	-----------------

BAA compliant products must have the cover letter on page 301 included with the order. Failure to use this cover letter will result in the customer receiving non-BAA compliant product with no recourse for an RMA or refund. BAA compliant product requires a longer lead time, please contact customer service for details.

Accessories available, see pages 156-158.
Accessories include Decorative Plates, Handheld Device, etc.
Credentials available, see pages 26-31.

Pricing/product description subject to change without notice.

1-3. Select Chassis

AD-200-MS	Mortise	\$2,121.00
AD-200-MD	Mortise Deadbolt	\$2,157.00



AD-200-MS-70-MG



KP



MGK



MS



MSK



MT/SI



MTK/SIK/FMK

4. Select Function **Note:** Locking function capabilities are determined by users access control system

70*	Classroom/Storeroom (Not available on mortise deadbolt)	STANDARD
50*	Office (Not available on mortise deadbolt)	\$10.00
40	Privacy ■	\$10.00
60	Apartment ■	\$10.00

* Less Door Position Switch, use suffix LDP. Deduct \$19.50

■ Inside Push Button (IPB) only included with Mortise (MS) chassis. Mortise deadbolt (MD) chassis comes with LED indicator only. \$10 charge does not apply to mortise deadbolt (MD) chassis.

5. Select Reader **Note:** Reflects list price adder to base keypad reader price of \$537.00.

LLL	Less Reader (For reader module accessories sold separately, see page 156)	DEDUCT \$537.00
KP	Keypad	STANDARD
MS	Magnetic Stripe (Swipe)	\$100.00
MSK	Magnetic Stripe (Swipe) + Keypad	\$166.00
MG	Magnetic Stripe (Insert)	\$116.00
MGK	Magnetic Stripe (Insert) + Keypad	\$184.00
MT	Multi-Technology Proximity and Smart Card	\$199.00
MTK	Multi-Technology + Keypad Proximity and Smart Card	\$264.00

6. Select Lever*

LLL	Less interior and exterior levers	DEDUCT \$64.90
Standard	SPA (Sparta), RHO (Rhodes), ATH (Athens), TLR (Tubular), BRW, (Broadway),	N/C
Options:	BRK (Boardwalk), LAT (Latitude), LON (Longitude)	

* Tactile Warning use 8AT for Athens, 8RO for Rhodes, 8SP for Sparta and 8TR for Tubular. \$45.60 per lever. Applied to exterior lever only unless otherwise specified. Not available with 643e finish.

7. Select Finish

626	Satin Chrome	N/C
605	Bright Brass	\$139.00
606	Satin Brass	\$139.00
612	Satin Bronze	\$139.00
619	Satin Nickel	\$139.00
625	Bright Chrome	\$139.00
643e	Aged Bronze	\$139.00
626AM	Satin Chrome Antimicrobial	\$179.00

8. Select Cylinder Type

P ●△	With Cylinder, Schlage- (Everest 29 S123, 6 Pin KIL standard)	N/C
L	Less Cylinder, Schlage, Falcon, 6 Pin KIL	DEDUCT \$64.00
R ●□	With Cylinder, Schlage 6-Pin (Everest 29 S123 standard) FSIC	\$38.00
J	Less Cylinder, Schlage, 6 Pin FSIC	DEDUCT \$35.00
G ●□	With Cylinder, Schlage 7-Pin (Everest 29R standard) (factory master keyed only) SFIC	\$84.00
B	Less Cylinder, Schlage, Falcon, Competitive OEM's, 7 Pin (SFIC)	N/C
L SAR	Less Cylinder, Sargent (10L + 11L), 6 Pin KIL	DEDUCT \$64.00
L CO6	Less Cylinder, Corbin 8000, 6 Pin KIL	DEDUCT \$64.00
JDSAR	Less Cylinder, Sargent 6300, 6 Pin FSIC	DEDUCT \$35.00
J CO6	Less Cylinder, Corbin 8000, 6 Pin FSIC	DEDUCT \$35.00
J CO7	Less Cylinder, Corbin 8000-7, 7 Pin FSIC, (Only RHO, 8RO, SPA, 8SP, TLR and 8TR)	DEDUCT \$35.00
J MED	Less Cylinder, Medeco 32*0201, 6 Pin FSIC (Only RHO, 8RO, SPA, 8SP lever styles)	DEDUCT \$35.00
J YA6	Less Cylinder, Yale 1210 or Medeco 31*0100, 6 Pin FSIC	DEDUCT \$35.00
J YA7	Less Cylinder, Yale 1220, 7 Pin FSIC (Only RHO, 8RO, SPA, 8SP lever styles)	DEDUCT \$35.00
L FA7	Less Cylinder, Falcon, 7 Pin, KIL (Only RHO, 8RO, SPA, 8SP lever styles)	DEDUCT \$35.00

● Master Keyed cylinders can be specified and will be shipped in lock packaging. For Master Keying System Summary form which should accompany the master keyed order, see page 283.

△ For Master Keying, additional line item 50-210 is required, \$20.10 each.

□ Control Keys for installation/removal of interchangeable cores are not furnished and must be ordered separate.

For additional assistance on Master Keying as well as restricted keyways please contact customer service.

Full Cylinder
PD LD LDSAR LDFA7

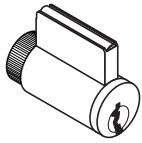

Full Size
Interchangeable Core
RD JD JD SAR JD CO6 JD YA6
JD CO7

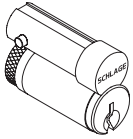

Small Format
Interchangeable Core
GD BD

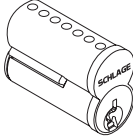

9. Select Keying Type

Open Keyway Families: KIL or FSIC ²		
S123	Everest 29 S (Key in Lever or FSIC)	STANDARD
C123	Everest C	N/C
C/CE/E/EF/ F/ FG/ G	Classic Obverse	N/C
Restricted Keyway Families: KIL or FSIC ^{1,2}		
29 T	Everest 29 T	\$17.50
D	Everest D	\$17.50
Classic Restricted	Quad, Numbered, Reverse	\$17.50
Restricted Keyway Families: SFIC ³		
29 R	Everest 29 R	N/C
B	Everest B	N/C

¹ Everest Restricted Keyways require a Letter of Authorization to be submitted with the order. See sample Letter of Authorization, see page 295.

² Full Size key systems (Everest 29 S & T, Everest C & D, Obverse & Quad) are available in Primus and Primus XP key system and must be ordered separately. Lock should be ordered less cylinder and Primus cylinder should be a separate line.

³ Master Keyed cylinders can be specified and will be shipped in lock packaging. For Master Keying System Summary form which should accompany the master keyed order, see page 283.

10. Select Handing (Field Reversible)

RH	Right Handed	N/C
LH	Left Handed	N/C
RHR	Right Handed Reverse	N/C
LHR	Left Handed Reverse	N/C

11. Select Battery

LLL	Less Battery Holder, Batteries, and Cover	DEDUCT \$25.90
4B	4AA Battery Kit	STANDARD
8B	8AA Battery Kit	\$39.00

12. Select Mortise Lock Armor Front

LLL	Less Armor Front	DEDUCT \$16.80
09-663	1-1/4" Wide Square Corner, Latch for MS	STANDARD
09-669	1-1/16" Wide Square Corner, Latch, options for MS	N/C
09-666	1-1/4" Wide Square Corner, Latch x Deadbolt for MD	STANDARD
09-672	1-1/16" Wide Square Corner, Latch x Deadbolt, Options for MD	N/C

13. Select Strike Plate

LLL	Less Strike	DEDUCT \$13.20
10-072	1-1/4" x 4-7/8" Square Corner + box; 1-3/16" lip length	STANDARD
10-072xx	1-1/4" x 4-7/8" Square Corner + box; specify lip length (xx) as 1" or 1-1/2"	N/C
10-072xx	1-1/4" x 4-7/8" Square Corner + box; specify lip length (xx) as 1-3/4"	\$31.30
10-075 ●	1/2" Rabbeted	\$108.00
37-015	Strike Frame Reinforcer, specify 37-015	N/C
XL11-820 △	One hole for latching functions, RH & LHR doors Lip 1-3/16"	\$13.40
XL11-821 △	One hole for latching functions, LH & RHR doors Lip 1-3/16"	\$13.40

● For 1-3/4" thick doors, use wide armor front. For over 1-3/4" thick door extended equally (EE) use 1-1/4" wide armor front.

△ Extended leadtime, consult customer service.

14. Select Door Thickness

134	1-3/4"	STANDARD
Example 138	1-3/8" to 2-3/4", Shims included (Specify in 1/8" increments)	\$58.90

15. Select Options

BAA	BAA Compliant Product	\$115.00
------------	-----------------------	-----------------

BAA compliant products must have the cover letter on page 301 included with the order. Failure to use this cover letter will result in the customer receiving non-BAA compliant product with no recourse for an RMA or refund. BAA compliant product requires a longer lead time, please contact customer service for details.

Accessories available, see pages 156-158.

Accessories include Decorative Plates, Handheld Device, etc.

Credentials available, see pages 26-31.

Pricing/product description subject to change without notice.



1-3. Select Chassis/Exit Trim Type Note: See page 123 for exit device compatibility

AD-200-993R	Exit Rim/Concealed Vertical Rod (Metal Door)/Concealed Vertical Cable (Metal Door)	\$2,200.00
AD-200-993S	Exit Surface Vertical Rod	\$2,217.00
AD-200-993M	Exit Mortise Lock	\$2,217.00

AD-SERIES

Networked

Standalone



AD-200-993-70-MTK



KP



MG



MS



MSK



MT/SI



MTK/SIK/FMK

4. Select Function Note: Locking function capabilities are determined by users access control system

70*	Classroom/Storeroom	STANDARD
50*	Office △	\$10.00
40	Privacy △	\$10.00
60	Apartment △	\$10.00

* Less Door Position Switch, use suffix LDP. Deduct \$19.50

△ Confirm these functions are supported by your access control system provider. RX-LC switch is included when ordered in 40, 50 or 60 function. Please specify if Von Duprin Exit or Falcon Exit is being used.

5. Select Reader Note: Reflects list price adder to base keypad reader price of \$537.00.

LLL	Less Reader (For reader module accessories sold separately, see page 156)	DEDUCT \$537.00
KP	Keypad	N/C
MS	Magnetic Stripe (Swipe)	\$100.00
MSK	Magnetic Stripe (Swipe) + Keypad	\$166.00
MG	Magnetic Stripe (Insert)	\$116.00
MGK	Magnetic Stripe (Insert) + Keypad	\$184.00
MT	Multi-Technology Proximity and Smart Card	\$199.00
MTK	Multi-Technology + Keypad Proximity and Smart Card	\$264.00

6. Select Lever*

LLL	Less interior and exterior levers	DEDUCT \$23.20
Standard Options:	SPA (Sparta), RHO (Rhodes), ATH (Athens), TLR (Tubular), BRW, (Boardwalk), BRK (Boardwalk), LAT (Latitude), LON (Longitude)	N/C

* Tactile Warning use BAT for Athens, 8RO for Rhodes, 8SP for Sparta and 8TR for Tubular. \$45.60 per lever. Applied to exterior lever only unless otherwise specified. Not available with 643e finish.

7. Select Finish

626	Satin Chrome	N/C
605	Bright Brass	\$139.00
606	Satin Brass	\$139.00
612	Satin Bronze	\$139.00
619	Satin Nickel	\$139.00
625	Bright Chrome	\$139.00
643e	Aged Bronze	\$139.00
626AM	Satin Chrome Antimicrobial	\$179.00

8. Select Cylinder Type

P ●△	With Cylinder, Schlage- (Everest 29 S123, 6 Pin KIL standard)	N/C
L	Less Cylinder, Schlage, Falcon, 6 Pin KIL	DEDUCT \$64.00
R ●□	With Cylinder, Schlage 6-Pin (Everest 29 S123 standard) FSIC	\$38.00
J	Less Cylinder, Schlage, 6 Pin FSIC	DEDUCT \$35.00
G ●□	With Cylinder, Schlage 7-Pin (Everest 29R standard) (factory master keyed only) SFIC	\$84.00
B	Less Cylinder, Schlage, Falcon, Competitive OEM's, 7 Pin (SFIC)	N/C
L SAR	Less Cylinder, Sargent (10L + 11L), 6 Pin KIL	DEDUCT \$64.00
L CO6	Less Cylinder, Corbin 8000, 6 Pin KIL	DEDUCT \$64.00
J SAR	Less Cylinder, Sargent 6300, 6 Pin FSIC	DEDUCT \$35.00
J CO6	Less Cylinder, Corbin 8000, 6 Pin FSIC	DEDUCT \$35.00
J CO7	Less Cylinder, Corbin 8000-7, 7 Pin FSIC, (Only RHO, 8RO, SPA, 8SP, TLR and 8TR)	DEDUCT \$35.00
J MED	Less Cylinder, Medeco 32*0201, 6 Pin FSIC (Only RHO, 8RO, SPA, 8SP lever styles)	DEDUCT \$35.00
J YA6	Less Cylinder, Yale 1210 or Medeco 31*0100, 6 Pin FSIC	DEDUCT \$35.00
J YA7	Less Cylinder, Yale 1220, 7 Pin FSIC (Only RHO, 8RO, SPA, 8SP lever styles)	DEDUCT \$35.00
L FA7	Less Cylinder, Falcon, 7 Pin, KIL (Only RHO, 8RO, SPA, 8SP lever styles)	DEDUCT \$35.00

● Master Keyed cylinders can be specified and will be shipped in lock packaging. For Master Keying System Summary form which should accompany the master keyed order, see page 283.

△ For Master Keying, additional line item 50-210 is required, \$20.10 each.

□ Control Keys for installation/removal of interchangeable cores are not furnished and must be ordered separate.

For additional assistance on Master Keying as well as restricted keyways please contact customer service.

Full Cylinder
PD LD LDSAR LDA7

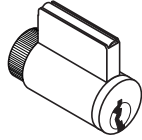

Full Size
Interchangeable Core
RD JD JD SAR JD CO6 JD YA6
JD CO7

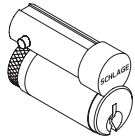

Small Format
Interchangeable Core
GD BD

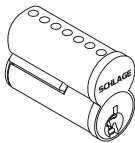

9. Select Keying Type

Open Keyway Families: KIL or FSIC ²		
S123	Everest 29 S (Key in Lever or FSIC)	STANDARD
C123	Everest C	N/C
C/CE/E/EF/ F/ FG/ G	Classic Obverse	N/C
Restricted Keyway Families: KIL or FSIC ^{1,2}		
29 T	Everest 29 T	\$17.50
D	Everest D	\$17.50
Classic Restricted	Quad, Numbered, Reverse	\$17.50
Restricted Keyway Families: SFIC ³		
29 R	Everest 29 R	N/C
B	Everest B	N/C

¹ Everest Restricted Keyways require a Letter of Authorization to be submitted with the order. See sample Letter of Authorization, see page 295.

² Full Size key systems (Everest 29 S & T, Everest C & D, Obverse & Quad) are available in Primus and Primus XP key system and must be ordered separately. Lock should be ordered less cylinder and Primus cylinder should be a separate line.

³ Master Keyed cylinders can be specified and will be shipped in lock packaging. For Master Keying System Summary form which should accompany the master keyed order, see page 283.

10. Select Handing (Field Reversible)

RHR	Right Handed Reverse	N/C
LHR	Left Handed Reverse	N/C

11. Select Battery

LLL	Less Battery Holder, Batteries, and Cover	DEDUCT \$25.90
4B	4AA Battery Kit	STANDARD
8B	8AA Battery Kit	\$39.00

12. -13. No Selection Required

14. Select Door Thickness

134	1-3/4"	STANDARD
Example 178	1-3/8" to 2-3/4", (Specify in 1/8" increments)	\$58.90

15. Select Options

BAA	BAA Compliant Product	\$115.00
------------	-----------------------	-----------------

BAA compliant products must have the cover letter on page 301 included with the order. Failure to use this cover letter will result in the customer receiving non-BAA compliant product with no recourse for an RMA or refund. BAA compliant product requires a longer lead time, please contact customer service for details.

AD-Series Exit Trim

The AD993DT Non-Functioning "Dummy" Trim comes with a universal mounting plate and is compatible with the following exit devices:

Von Duprin 98/99 and 98/99XP

Rim, Concealed Vertical Rod (metal door only), Concealed Vertical Cable (metal door only), Surface Vertical Rod, Mortise. Low current Request-to-Exit Switch optional for future network migration or if ordered as a 40, 50 or 60 function.

Von Duprin 22/22F

Rim, Surface Vertical Rod

Falcon 25

Rim Low current Request-to-Exit switch optional for future network migration or included if ordered as a 40, 50 or 60 function.

Sargent 80 Series (Narrow design & reversible rim exits not compatible) - Rim

Corbin Russwin 5000 Series - Rim

Yale 7000 - Rim

Dorma 9300 - Rim

Precision 21 - Rim (2100 converts to 21 with Precision's BP21 Kit)

Note: AD-Series Non-Functioning "Dummy" Exit Trim now available. Please See page 152-153 for details

Accessories available, see pages 156-158. Accessories include Decorative Plates, Handheld Device, etc. Credentials available, see pages 26-31.

Pricing/product description subject to change without notice.

1-4. Select Chassis/Function

Note: Locking function capabilities are determined by users access control system

AD-201-CY-70*	Classroom/Storeroom	\$1,847.00
AD-201-CY-50*	Office	\$1,857.00
AD-201-CY-40	Privacy	\$1,857.00
AD-201-CY-60	Apartment	\$1,857.00

* Less Door Position Switch, use suffix LDP. Deduct \$19.50



AD-201-CY-70-FMK

5. Select Reader

FMK	FIPS Multi-Technology + Keypad Proximity and Smart Card (PIV & PIV-I Card)	\$473.00
------------	--	-----------------

6. Select Lever*

LLL	Less interior and exterior levers	DEDUCT \$46.40
SPA	Sparta	N/C
RHO	Rhodes	N/C
ATH	Athens	N/C
TLR	Tubular	N/C

* Tactile Warning use 8AT for Athens, 8RO for Rhodes, 8SP for Sparta and 8TR for Tubular. \$45.60 per lever. Applied to exterior lever only unless otherwise specified. Not available with 643e finish.

7. Select Finish

626	Satin Chrome	N/C
605	Bright Brass	\$139.00
606	Satin Brass	\$139.00
612	Satin Bronze	\$139.00
619	Satin Nickel	\$139.00
625	Bright Chrome	\$139.00
643e	Aged Bronze	\$139.00
626AM	Satin Chrome Antimicrobial	\$179.00

8. Select Cylinder Type

P ●△	With Cylinder, Schlage- (Everest 29 S123, 6 Pin KIL standard)	N/C
L	Less Cylinder, Schlage, Falcon, 6 Pin KIL	DEDUCT \$64.00
R ●□	With Cylinder, Schlage 6-Pin (Everest 29 S123 standard) FSIC	\$38.00
J	Less Cylinder, Schlage, 6 Pin FSIC	DEDUCT \$35.00
G ●□	With Cylinder, Schlage 7-Pin (Everest 29R standard) (factory master keyed only) SFIC	\$84.00
B	Less Cylinder, Schlage, Falcon, Competitive OEM's, 7 Pin (SFIC)	N/C
LSAR	Less Cylinder, Sargent (10L + 11L), 6 Pin KIL	DEDUCT \$64.00
JSAR	Less Cylinder, Sargent 6300, 6 Pin FSIC	DEDUCT \$35.00
JCO6	Less Cylinder, Corbin 8000, 6 Pin FSIC	DEDUCT \$35.00
JCO7	Less Cylinder, Corbin 8000-7, 7 Pin FSIC, (Only RHO, 8RO, SPA, 8SP, TLR and 8TR)	DEDUCT \$35.00
JMED	Less Cylinder, Medeco 32*0201, 6 Pin FSIC (Only RHO, 8RO, SPA, 8SP lever styles)	DEDUCT \$35.00
JYA6	Less Cylinder, Yale 1210 or Medeco 31*0100, 6 Pin FSIC	DEDUCT \$35.00
JYA7	Less Cylinder, Yale 1220, 7 Pin FSIC (Only RHO, 8RO, SPA, 8SP lever styles)	DEDUCT \$35.00
LA7	Less Cylinder, Falcon, 7 Pin, KIL (Only RHO, 8RO, SPA, 8SP lever styles)	DEDUCT \$35.00

● Master Keyed cylinders can be specified and will be shipped in lock packaging. For Master Keying System Summary form which should accompany the master keyed order, see page 283.

△ For Master Keying, additional line item 50-210 is required, 20.10 each.

□ Control Keys for installation/removal of interchangeable cores are not furnished and must be ordered separate. For additional assistance on Master Keying as well as restricted keyways please contact customer service.

Full Cylinder
PD LD LDSAR LDFA7

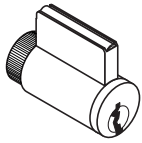

Full Size
Interchangeable Core
RD JD JD SAR JD CO6 JD YA6
JD C07

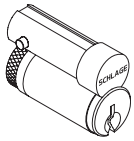

Small Format
Interchangeable Core
GD BD

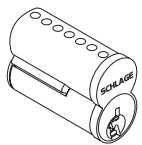

9. Select Keying Type

Open Keyway Families: KIL or FSIC ²		
S123	Everest 29 S (Key in Lever or FSIC)	STANDARD
C123	Everest C	N/C
C/CE/E/EF/ F/ FG/ G	Classic Obverse	N/C
Restricted Keyway Families: KIL or FSIC ^{1,2}		
29 T	Everest 29 T	\$17.50
D	Everest D	\$17.50
Classic Restricted	Quad, Numbered, Reverse	\$17.50
Restricted Keyway Families: SFIC ³		
29 R	Everest 29 R	N/C
B	Everest B	N/C

¹ Everest Restricted Keyways require a Letter of Authorization to be submitted with the order. See sample Letter of Authorization, see page 295.

² Full Size key systems (Everest 29 S & T, Everest C & D, Obverse & Quad) are available in Primus and Primus XP key system and must be ordered separately. Lock should be ordered less cylinder and Primus cylinder should be a separate line.

³ Master Keyed cylinders can be specified and will be shipped in lock packaging. For Master Keying System Summary form which should accompany the master keyed order, see page 283.

10. Select Handing (Field Reversible)

RH	Right Handed	N/C
LH	Left Handed	N/C
RHR	Right Handed Reverse	N/C
LHR	Left Handed Reverse	N/C

11. Select Battery

LLL	Less Battery Holder, Batteries, and Cover	DEDUCT \$25.90
4B	4AA Battery Kit	STANDARD
8B	8AA Battery Kit	\$39.00

12. Select Backset & Latchbolt

LLL	Less Latch	DEDUCT \$34.20
13-247	2-3/4" Backset, Deadlatch, Square corner, 1-1/8" x 2-1/4"	STANDARD
14-049	2-3/4" Backset, Deadlatch Anti-friction fire door latch, Square corner, 1-1/8" x 2-1/4", 3/4" throw	\$181.00
14-051	2-3/8" Backset, Deadlatch Square corner, 1-1/8" x 2-1/4"	N/C
14-050	3-3/4" Backset, Deadlatch Square corner, 1-1/8" x 2-1/4"	\$10.70
43-001	5" Backset extension link, Deadlatch	\$33.10
39-030*	Rabbeted latch and strike kit, 605 and 626 only	\$58.10

* Adapts square corner latch and 2-3/4" square corner strike to 1/2" rabbeted door and frame.

13. Select Strike Plate

LLL	Less Strike Plate	DEDUCT \$4.50
10-025	1-3/16" Lip, ANSI, no box, 1-1/4" x 4-7/8"	STANDARD
10-013*	1-1/8" Lip, Square Corner, T-strike, box, 1-1/8" - 2-3/4"	N/C
10-016	1-1/8" Lip, Square Corner, T-strike, deep box, fire door latch	\$15.70
K510-066	Box for ANSI strike (Must be specific)	N/C

* 1-1/2" Lip available, must specify 1-1/2" Lip \$7.50

14. Select Door Thickness

134	1-3/4"	STANDARD
Example 138	1-3/8" to 2-3/4", Shims included (Specify in 1/8" increments)	\$60.70

Note: The AD-200 lock can be field upgraded to a FIPS compliant solution simply by adding the FMK reader (sold separately) and by using the most current firmware revision.

Standard accessories available, see pages 156-158.

Standard accessories sold separately include Decorative Plates, Handheld Device, etc.

Pricing/product description subject to change without notice.

1-3. Select Chassis

AD-201-MS	Mortise	\$2,121.00
AD-201-MD	Mortise Deadbolt	\$2,157.00



AD-201-MS-70-FMK

4. Select Function

Note: Locking function capabilities are determined by users access control system

70*	Classroom/Storeroom (Not available on mortise deadbolt)	STANDARD
50*	Office (Not available on mortise deadbolt)	\$10.00
40	Privacy	\$10.00
60	Apartment	\$10.00

* Less Door Position Switch, use suffix LDP. Deduct \$19.50

5. Select Reader

FMK	FIPS Multi-Technology + Keypad Proximity and Smart Card (PIV & PIV-I Card)	\$473.00
-----	--	----------

6. Select Lever*

LLL	Less interior and exterior levers	DEDUCT \$54.60
SPA	Sparta	N/C
RHO	Rhodes	N/C
ATH	Athens	N/C
TLR	Tubular	N/C

* Tactile Warning use 8AT for Athens, 8RO for Rhodes, 8SP for Sparta and 8TR for Tubular. \$45.60 per lever. Applied to exterior lever only unless otherwise specified. Not available with 643e finish.

7. Select Finish

626	Satin Chrome	N/C
605	Bright Brass	\$139.00
606	Satin Brass	\$139.00
612	Satin Bronze	\$139.00
619	Satin Nickel	\$139.00
625	Bright Chrome	\$139.00
643e	Aged Bronze	\$139.00
626AM	Satin Chrome Antimicrobial	\$179.00

8. Select Cylinder Type

P ●△	With Cylinder, Schlage- (Everest 29 S123, 6 Pin KIL standard)	N/C
L	Less Cylinder, Schlage, Falcon, 6 Pin KIL	DEDUCT \$64.00
R ●□	With Cylinder, Schlage 6-Pin (Everest 29 S123 standard) FSIC	\$38.00
J	Less Cylinder, Schlage, 6 Pin FSIC	DEDUCT \$35.00
G ●□	With Cylinder, Schlage 7-Pin (Everest 29R standard) (factory master keyed only) SFIC	\$84.00
B	Less Cylinder, Schlage, Falcon, Competitive OEM's, 7 Pin (SFIC)	N/C
LSAR	Less Cylinder, Sargent (10L + 11L), 6 Pin KIL	DEDUCT \$64.00
JSAR	Less Cylinder, Sargent 6300, 6 Pin FSIC	DEDUCT \$35.00
JCO6	Less Cylinder, Corbin 8000, 6 Pin FSIC	DEDUCT \$35.00
JCO7	Less Cylinder, Corbin 8000-7, 7 Pin FSIC. (Only RHO, 8RO, SPA, 8SP, TLR and 8TR)	DEDUCT \$35.00
JMED	Less Cylinder, Medeco 32*0201, 6 Pin FSIC (Only RHO, 8RO, SPA, 8SP lever styles)	DEDUCT \$35.00
JYA6	Less Cylinder, Yale 1210 or Medeco 31*0100, 6 Pin FSIC	DEDUCT \$35.00
JYA7	Less Cylinder, Yale 1220, 7 Pin FSIC (Only RHO, 8RO, SPA, 8SP lever styles)	DEDUCT \$35.00
LFA7	Less Cylinder, Falcon, 7 Pin, KIL (Only RHO, 8RO, SPA, 8SP lever styles)	DEDUCT \$35.00

● Master Keyed cylinders can be specified and will be shipped in lock packaging. For Master Keying System Summary form which should accompany the master keyed order, page 283.

△ For Master Keying, additional line item 50-210 is required, \$20.10 each.

□ Control Keys for installation/removal of interchangeable cores are not furnished and must be ordered separate.

For additional assistance on Master Keying as well as restricted keyways please contact customer service.

AD-SERIES

Networked

Standalone

Full Cylinder
PD LD LDSAR LDFA7

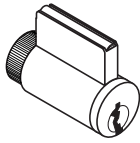

Full Size
Interchangeable Core
RD JD JD SAR JD CO6 JD YA6
JD CO7

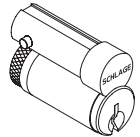

Small Format
Interchangeable Core
GD BD

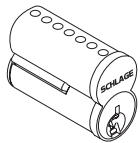

9. Select Keying Type

Open Keyway Families: KIL or FSIC ²		
S123	Everest 29 S (Key in Lever or FSIC)	STANDARD
C123	Everest C	N/C
C/CE/E/EF/F/FG/G	Classic Obverse	N/C
Restricted Keyway Families: KIL or FSIC ^{1,2}		
29 T	Everest 29 T	\$17.50
D	Everest D	\$17.50
Classic Restricted	Quad, Numbered, Reverse	\$17.50
Restricted Keyway Families: SFIC ³		
29 R	Everest 29 R	N/C
B	Everest B	N/C

¹ Everest Restricted Keyways require a Letter of Authorization to be submitted with the order. See sample Letter of Authorization, see page 295.

² Full Size key systems (Everest 29 S & T, Everest C & D, Obverse & Quad) are available in Primus and Primus XP key system and must be ordered separately. Lock should be ordered less cylinder and Primus cylinder should be a separate line.

³ Master Keyed cylinders can be specified and will be shipped in lock packaging. For Master Keying System Summary form which should accompany the master keyed order, see page 283.

10. Select Handing (Field Reversible)

RH	Right Handed	N/C
LH	Left Handed	N/C
RHR	Right Handed Reverse	N/C
LHR	Left Handed Reverse	N/C

11. Select Battery

LLL	Less Battery Holder, Batteries, and Cover	DEDUCT \$25.90
4B	4AA Battery Kit	STANDARD
8B	8AA Battery Kit	\$39.00

12. Select Mortise Lock Armor Front

LLL	Less Armor Front	DEDUCT \$16.80
09-663	1-1/4" Wide Square Corner, Latch for MS	STANDARD
09-669	1-1/16" Wide Square Corner, Latch, options for MS	N/C
09-666	1-1/4" Wide Square Corner, Latch x Deadbolt for MD	STANDARD
09-672	1-1/16" Wide Square Corner, Latch x Deadbolt, Options for MD	N/C

13. Select Strike Plate

LLL	Less Strike	DEDUCT \$13.20
10-072	1-1/4" x 4-7/8" Square Corner + box; 1-3/16" lip length	STANDARD
10-072xx	1-1/4" x 4-7/8" Square Corner + box; specify lip length (xx) as 1" or 1-1/2"	N/C
10-072xx	1-1/4" x 4-7/8" Square Corner + box; specify lip length (xx) as 1-3/4"	\$31.30
10-075 ●	1/2" Rabbeted	\$108.00
37-015	Strike Frame Reinforcer, specify 37-015	N/C
XL11-820 △	One hole for latching functions, RH & LHR doors Lip 1-3/16"	\$13.40
XL11-821 △	One hole for latching functions, LH & RHR doors Lip 1-3/16"	\$13.40

● For 1-3/4" thick doors, use wide armor front. For over 1-3/4" thick door extended equally (EE) use 1-1/4" wide armor front.

△ Extended leadtime, consult customer service.

14. Select Door Thickness

134	1-3/4"	STANDARD
Example 138	1-3/8" to 2-3/4", Shims included (Specify in 1/8" increments)	\$58.90

Note: The AD-200 lock can be field upgraded to a FIPS compliant solution simply by adding the FMK reader (sold separately) and by using the most current firmware revision.

Standard accessories available, see pages 156-158.

Standard accessories sold separately include Decorative Plates, Handheld Device, etc.

Pricing/product description subject to change without notice.

1-3. Select Chassis/Exit Trim Type*

AD-201-993R	Exit Rim/ ¹ Concealed Vertical Rod/ ¹ Concealed Vertical Cable	\$2,200.00
AD-201-993S	Exit Surface Vertical Rod	\$2,217.00
AD-201-993M	Exit Mortise Lock	\$2,217.00

* See page 123 for exit device compatibility. ¹ Metal door only.



AD-201-993R-70-FMK

4. Select Function *Note: Locking function capabilities are determined by users access control system*

70*	Classroom/Storeroom	STANDARD
50*	Office △	\$10.00
40	Privacy △	\$10.00
60	Apartment △	\$10.00

* Less Door Position Switch, use suffix LDP. Deduct \$19.50

5. Select Reader

FMK	FIPS Multi-Technology + Keypad Proximity and Smart Card (PIV & PIV-I Card)	\$473.00
------------	--	-----------------

6. Select Lever*

LLL	Less interior and exterior levers	DEDUCT \$23.20
SPA	Sparta	N/C
RHO	Rhodes	N/C
ATH	Athens	N/C
TLR	Tubular	N/C

* Tactile Warning use 8AT for Athens, 8RO for Rhodes, 8SP for Sparta and 8TR for Tubular. \$45.60 per lever. Applied to exterior lever only unless otherwise specified. Not available with 643e finish.

7. Select Finish

626	Satin Chrome	N/C
605	Bright Brass	\$139.00
606	Satin Brass	\$139.00
612	Satin Bronze	\$139.00
619	Satin Nickel	\$139.00
625	Bright Chrome	\$139.00
643e	Aged Bronze	\$139.00
626AM	Satin Chrome Antimicrobial	\$179.00

8. Select Cylinder Type

P ●△	With Cylinder, Schlage- (Everest 29 S123, 6 Pin KIL standard)	N/C
L	Less Cylinder, Schlage, Falcon, 6 Pin KIL	DEDUCT \$64.00
R ●□	With Cylinder, Schlage 6-Pin (Everest 29 S123 standard) FSIC	\$38.00
J	Less Cylinder, Schlage, 6 Pin FSIC	DEDUCT \$35.00
G ●□	With Cylinder, Schlage 7-Pin (Everest 29R standard) (factory master keyed only) SFIC	\$84.00
B	Less Cylinder, Schlage, Falcon, Competitive OEM's, 7 Pin (SFIC)	N/C
L SAR	Less Cylinder, Sargent (10L + 11L), 6 Pin KIL	DEDUCT \$64.00
J SAR	Less Cylinder, Sargent 6300, 6 Pin FSIC	DEDUCT \$35.00
J C06	Less Cylinder, Corbin 8000, 6 Pin FSIC	DEDUCT \$35.00
J C07	Less Cylinder, Corbin 8000-7, 7 Pin FSIC, (Only RHO, 8RO, SPA, 8SP, TLR and 8TR)	DEDUCT \$35.00
J MED	Less Cylinder, Medeco 32*0201, 6 Pin FSIC (Only RHO, 8RO, SPA, 8SP lever styles)	DEDUCT \$35.00
J YA6	Less Cylinder, Yale 1210 or Medeco 31*0100, 6 Pin FSIC	DEDUCT \$35.00
J YA7	Less Cylinder, Yale 1220, 7 Pin FSIC (Only RHO, 8RO, SPA, 8SP lever styles)	DEDUCT \$35.00
L FA7	Less Cylinder, Falcon, 7 Pin, KIL (Only RHO, 8RO, SPA, 8SP lever styles)	DEDUCT \$35.00

● Master Keyed cylinders can be specified and will be shipped in lock packaging. For Master Keying System Summary form which should accompany the master keyed order, see page 283.

△ For Master Keying, additional line item 50-210 is required, \$20.10 each.

□ Control Keys for installation/removal of interchangeable cores are not furnished and must be ordered separate.

For additional assistance on Master Keying as well as restricted keyways please contact customer service.

Full Cylinder
PD LD LDSAR LDA7

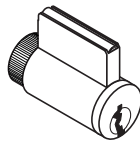

Full Size
Interchangeable Core
RD JD JD SAR JD CO6 JD YA6
JD C07

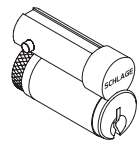

Small Format
Interchangeable Core
GD BD

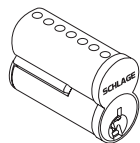

9. Select Keying Type

Open Keyway Families: KIL or FSIC ²		
S123	Everest 29 S (Key in Lever or FSIC)	STANDARD
C123	Everest C	N/C
C/CE/E/EF/ F/ FG/ G	Classic Obverse	N/C
Restricted Keyway Families: KIL or FSIC ^{1,2}		
29 T	Everest 29 T	\$17.50
D	Everest D	\$17.50
Classic Restricted	Quad, Numbered, Reverse	\$17.50
Restricted Keyway Families: SFIC ³		
29 R	Everest 29 R	N/C
B	Everest B	N/C

¹ Everest Restricted Keyways require a Letter of Authorization to be submitted with the order. See sample Letter of Authorization, see page 295.
² Full Size key systems (Everest 29 S & T, Everest C & D, Obverse & Quad) are available in Primus and Primus XP key system and must be ordered separately. Lock should be ordered less cylinder and Primus cylinder should be a separate line.
³ Master Keyed cylinders can be specified and will be shipped in lock packaging. For Master Keying System Summary form which should accompany the master keyed order, see page 283.

10. Select Handing (Field Reversible)

RHR	Right Handed Reverse	N/C
LHR	Left Handed Reverse	N/C

11. Select Battery

LLL	Less Battery Holder, Batteries, and Cover	DEDUCT \$25.90
4B	4AA Battery Kit	STANDARD
8B	8AA Battery Kit	\$39.00

12. -13. No Selection Required

14. Select Door Thickness

134	1-3/4"	STANDARD
Example 138	1-7/8" to 2-3/4", (Specify in 1/8" increments)	\$58.90

AD-Series Exit Trim
 The AD993DT Non-Functioning "Dummy" Trim comes with a universal mounting plate and is compatible with the following exit devices:

Von Duprin 98/99 and 98/99XP
 Rim, Concealed Vertical Rod (metal door only), Concealed Vertical Cable (metal door only), Surface Vertical Rod, Mortise. Low current Request-to-Exit Switch optional for future network migration.

Von Duprin 22/22F
 Rim, Surface Vertical Rod

Falcon 25 - Rim

Sargent 80 Series (Narrow design & reversible rim exits not compatible) - Rim

Corbin Russwin 5000 Series - Rim

Yale 7000 - Rim

Dorma 9300 - Rim

Precision 21 - Rim (2100 converts to 21 with Precision's BP21 Kit)

Note: AD-Series Non-Functioning "Dummy" Exit Trim now available. Please see pages 152-153 for details

Standard accessories available, see pages 156-158.
 Standard accessories sold separately include Decorative Plates, Handheld Device, etc.

Note: The AD-200 lock can be field upgraded to a FIPS compliant solution simply by adding the FMK reader (sold separately) and by using the most current firmware revision.

Pricing/product description subject to change without notice.

AD-250 Rights on Card - Cylindrical



1-4. Select Chassis/Function

Note: Locking function capabilities are determined by users access control system

AD-250-CY-70*	Classroom/Storeroom	\$2,014.00
AD-250-CY-50*	Office	\$2,024.00
AD-250-CY-40	Privacy	\$2,024.00
AD-250-CY-60	Apartment	\$2,024.00

* Less Door Position Switch, use suffix LDP. Deduct \$19.50



AD-250-CY-70-MG



MGK



MS



MSK

5. Select Reader Note: Reflects list price adder to base magnetic swipe reader price of \$656.00.

LLL	Less Reader (For reader module accessories sold separately, see page 156)	DEDUCT \$656.00
MS	Magnetic Stripe (Swipe)	N/C
MSK	Magnetic Stripe (Swipe) + Keypad	\$68.10
MG	Magnetic Stripe (Insert)	\$17.30
MGK	Magnetic Stripe (Insert) + Keypad	\$85.70

6. Select Lever*

LLL	Less interior and exterior levers	DEDUCT \$47.70
SPA	Sparta	N/C
RHO	Rhodes	N/C
ATH	Athens	N/C
TLR	Tubular	N/C
BRW	Broadway	N/C
BRK	Boardwalk	N/C
LAT	Latitude	N/C
LON	Longitude	N/C

* Tactile Warning use 8AT for Athens, 8RO for Rhodes, 8SP for Sparta and 8TR for Tubular. \$45.60 per lever. Applied to exterior lever only unless otherwise specified. Not available with 643e finish.

7. Select Finish

626	Satin Chrome	N/C
605	Bright Brass	\$139.00
606	Satin Brass	\$139.00
612	Satin Bronze	\$139.00
619	Satin Nickel	\$139.00
625	Bright Chrome	\$139.00
643e	Aged Bronze	\$139.00
626AM	Satin Chrome Antimicrobial	\$179.00

8. Select Cylinder Type

P ● △	With Cylinder, Schlage- (Everest 29 S123, 6 Pin KIL standard)	N/C
L	Less Cylinder, Schlage, Falcon, 6 Pin KIL	DEDUCT \$64.00
R ● □	With Cylinder, Schlage 6-Pin (Everest 29 S123 standard) FSIC	\$38.00
J	Less Cylinder, Schlage, 6 Pin FSIC	DEDUCT \$35.00
G ● □	With Cylinder, Schlage 7-Pin (Everest 29R standard) (factory master keyed only) SFIC	\$84.00
B	Less Cylinder, Schlage, Falcon, Competitive OEM's, 7 Pin (SFIC)	N/C
LSAR	Less Cylinder, Sargent (10L + 11L), 6 Pin KIL	DEDUCT \$64.00
LCO6	Less Cylinder, Corbin 8000, 6 Pin KIL	DEDUCT \$64.00
JSAR	Less Cylinder, Sargent 6300, 6 Pin FSIC	DEDUCT \$35.00
JCO6	Less Cylinder, Corbin 8000, 6 Pin FSIC	DEDUCT \$35.00
JCO7	Less Cylinder, Corbin 8000-7, 7 Pin FSIC, (Only RHO, 8RO, SPA, 8SP, TLR and 8TR)	DEDUCT \$35.00
JMED	Less Cylinder, Medeco 32*0201, 6 Pin FSIC (Only RHO, 8RO, SPA, 8SP lever styles)	DEDUCT \$35.00
JYA6	Less Cylinder, Yale 1210 or Medeco 31*0100, 6 Pin FSIC	DEDUCT \$35.00
JYA7	Less Cylinder, Yale 1220, 7 Pin FSIC (Only RHO, 8RO, SPA, 8SP lever styles)	DEDUCT \$35.00
LFA7	Less Cylinder, Falcon, 7 Pin, KIL (Only RHO, 8RO, SPA, 8SP lever styles)	DEDUCT \$35.00

● Master Keyed cylinders can be specified and will be shipped in lock packaging. For Master Keying System Summary form which should accompany the master keyed order, see page 283.

△ For Master Keying, additional line item 50-210 is required, \$20.10 each.

□ Control Keys for installation/removal of interchangeable cores are not furnished and must be ordered separate.

For additional assistance on Master Keying as well as restricted keyways please contact customer service.

Pricing/product description subject to change without notice.

Full Cylinder
PD LD LDSAR LDFA7

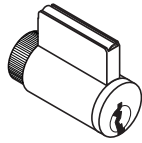

Full Size
Interchangeable Core
RD JD JD SAR JD CO6 JD YA6
JD C07

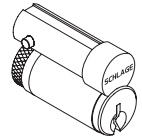

Small Format
Interchangeable Core
GD BD

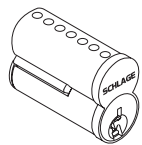

9. Select Keying Type

Open Keyway Families: KIL or FSIC ²		
S123	Everest 29 S (Key in Lever or FSIC)	STANDARD
C123	Everest C	N/C
C/CE/E/EF/F/FG/G	Classic Obverse	N/C
Restricted Keyway Families: KIL or FSIC ^{1,2}		
29 T	Everest 29 T	\$17.50
D	Everest D	\$17.50
Classic Restricted	Quad, Numbered, Reverse	\$17.50
Restricted Keyway Families: SFIC ³		
29 R	Everest 29 R	N/C
B	Everest B	N/C

¹ Everest Restricted Keyways require a Letter of Authorization to be submitted with the order. See sample Letter of Authorization, see page 295.

² Full Size key systems (Everest 29 S & T, Everest C & D, Obverse & Quad) are available in Primus and Primus XP key system and must be ordered separately. Lock should be ordered less cylinder and Primus cylinder should be a separate line.

³ Master Keyed cylinders can be specified and will be shipped in lock packaging. For Master Keying System Summary form which should accompany the master keyed order, see page 283.

10. Select Handing (Field Reversible)

RH	Right Handed	N/C
LH	Left Handed	N/C
RHR	Right Handed Reverse	N/C
LHR	Left Handed Reverse	N/C

11. Select Battery

LLL	Less Battery Holder, Batteries, and Cover	DEDUCT \$25.80
4B	4AA Battery Kit	STANDARD
8B	8AA Battery Kit	\$39.00

12. Select Backset & Latchbolt

LLL	Less Latch	DEDUCT \$34.20
13-247	2-3/4" Backset, Deadlatch, Square corner, 1-1/8" x 2-1/4"	STANDARD
14-049	2-3/4" Backset, Deadlatch Anti-friction fire door latch, Square corner, 1-1/8" x 2-1/4", 3/4" throw	\$181.00
14-051	2-3/8" Backset, Deadlatch Square corner, 1-1/8" x 2-1/4"	N/C
14-050	3-3/4" Backset, Deadlatch Square corner, 1-1/8" x 2-1/4"	\$10.70
43-001	5" Backset extension link, Deadlatch	\$33.10
39-030*	Rabbeted latch and strike kit, 605 and 626 only	\$56.10

* Adapts square corner latch and 2-3/4" square corner strike to 1/2" rabbeted door and frame.

13. Select Strike Plate

LLL	Less Strike Plate	DEDUCT \$4.50
10-025	1-3/16" Lip, ANSI, no box, 1-1/4" x 4-7/8"	STANDARD
10-013*	1-1/8" Lip, Square Corner, T-strike, box, 1-1/8" - 2-3/4"	N/C
10-016	1-1/8" Lip, Square Corner, T-strike, deep box, fire door latch	\$15.70
K510-066	Box for ANSI strike (Must be specific)	N/C

* 1-1/2" Lip available, must specify 1-1/2" Lip \$8.00

14. Select Door Thickness

134	1-3/4"	STANDARD
Example 138	1-3/8" to 2-3/4", Shims included (Specify in 1/8" increments)	\$58.90

15. Select Options

BAA	BAA Compliant Product	\$115.00
------------	-----------------------	-----------------

BAA compliant products must have the cover letter on page 301 included with the order. Failure to use this cover letter will result in the customer receiving non-BAA compliant product with no recourse for an RMA or refund. BAA compliant product requires a longer lead time, please contact customer service for details.

Accessories available, see pages 156-158.

Accessories include Decorative Plates, Handheld Device, etc.

Credentials available, see pages 26-31.

Pricing/product description subject to change without notice.

1-3. Select Chassis

AD-250-MS	Mortise	\$2,319.00
AD-250-MD	Mortise Deadbolt	\$2,356.00



AD-250-MS-70-MGK



MG



MS



MSK

4. Select Function **Note:** Locking function capabilities are determined by users access control system

70*	Classroom/Storeroom (Not available on mortise deadbolt)	STANDARD
50*	Office (Not available on mortise deadbolt)	\$10.00
40	Privacy ■	\$10.00
60	Apartment ■	\$10.00

* Less Door Position Switch, use suffix LDP. Deduct \$19.50

■ Inside Push Button (IPB) only included with Mortise (MS) chassis. Mortise deadbolt (MD) chassis comes with LED indicator only. \$10 charge does not apply to mortise deadbolt (MD) chassis.

5. Select Reader **Note:** Reflects list price adder to base magnetic swipe reader price of \$656.00.

LLL	Less Reader (For reader module accessories sold separately, see page 156)	DEDUCT \$656.00
MS	Magnetic Stripe (Swipe)	N/C
MSK	Magnetic Stripe (Swipe) + Keypad	\$68.10
MG	Magnetic Stripe (Insert)	\$17.30
MGK	Magnetic Stripe (Insert) + Keypad	\$85.70

6. Select Lever*

LLL	Less interior and exterior levers	DEDUCT \$66.80
SPA	Sparta	N/C
RHO	Rhodes	N/C
ATH	Athens	N/C
TLR	Tubular	N/C
BRW	Broadway	N/C
BRK	Boardwalk	N/C
LAT	Latitude	N/C
LON	Longitude	N/C

* Tactile Warning use 8AT for Athens, 8RO for Rhodes, 8SP for Sparta and 8TR for Tubular. \$45.60 per lever. Applied to exterior lever only unless otherwise specified. Not available with 643e finish.

7. Select Finish

626	Satin Chrome	N/C
605	Bright Brass	\$139.00
606	Satin Brass	\$139.00
612	Satin Bronze	\$139.00
619	Satin Nickel	\$139.00
625	Bright Chrome	\$139.00
643e	Aged Bronze	\$139.00
626AM	Satin Chrome Antimicrobial	\$179.00

8. Select Cylinder Type

P ●△	With Cylinder, Schlage- (Everest 29 S123, 6 Pin KIL standard)	N/C
L	Less Cylinder, Schlage, Falcon, 6 Pin KIL	DEDUCT \$64.00
R ●□	With Cylinder, Schlage 6-Pin (Everest 29 S123 standard) FSIC	\$38.00
J	Less Cylinder, Schlage, 6 Pin FSIC	DEDUCT \$35.00
G ●□	With Cylinder, Schlage 7-Pin (Everest 29R standard) (factory master keyed only) SFIC	\$84.00
B	Less Cylinder, Schlage, Falcon, Competitive OEM's, 7 Pin (SFIC)	N/C
L SAR	Less Cylinder, Sargent (10L + 11L), 6 Pin KIL	DEDUCT \$64.00
L CO6	Less Cylinder, Corbin 8000, 6 Pin KIL	DEDUCT \$64.00
J SAR	Less Cylinder, Sargent 6300, 6 Pin FSIC	DEDUCT \$35.00
J CO6	Less Cylinder, Corbin 8000, 6 Pin FSIC	DEDUCT \$35.00
J CO7	Less Cylinder, Corbin 8000-7, 7 Pin FSIC, (Only RHO, 8RO, SPA, 8SP, TLR and 8TR)	DEDUCT \$35.00
J MED	Less Cylinder, Medeco 32*0201, 6 Pin FSIC (Only RHO, 8RO, SPA, 8SP lever styles)	DEDUCT \$35.00
J YA6	Less Cylinder, Yale 1210 or Medeco 31*0100, 6 Pin FSIC	DEDUCT \$35.00
J YA7	Less Cylinder, Yale 1220, 7 Pin FSIC (Only RHO, 8RO, SPA, 8SP lever styles)	DEDUCT \$35.00
L FA7	Less Cylinder, Falcon, 7 Pin, KIL (Only RHO, 8RO, SPA, 8SP lever styles)	DEDUCT \$35.00

● Master Keyed cylinders can be specified and will be shipped in lock packaging. For Master Keying System Summary form which should accompany the master keyed order, see page 283.

△ For Master Keying, additional line item 50-210 is required, \$20.10 each.

□ Control Keys for installation/removal of interchangeable cores are not furnished and must be ordered separate.

For additional assistance on Master Keying as well as restricted keyways please contact customer service.

Full Cylinder
PD LD LDSAR LDFA7

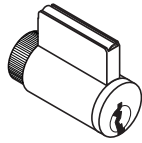

Full Size Interchangeable Core
RD JD JD SAR JD CO6 JD YA6 JD CO7

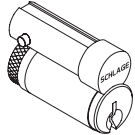

Small Format Interchangeable Core
GD BD

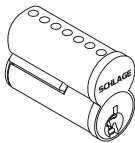

9. Select Keying Type

Open Keyway Families: KIL or FSIC ²		
S123	Everest 29 S (Key in Lever or FSIC)	STANDARD
C123	Everest C	N/C
C/CE/E/EF/F/FG/G	Classic Obverse	N/C
Restricted Keyway Families: KIL or FSIC ^{1,2}		
29 T	Everest 29 T	\$17.50
D	Everest D	\$17.50
Classic Restricted	Quad, Numbered, Reverse	\$17.50
Restricted Keyway Families: SFIC ³		
29 R	Everest 29 R	N/C
B	Everest B	N/C

¹ Everest Restricted Keyways require a Letter of Authorization to be submitted with the order. See sample Letter of Authorization, see page 295.

² Full Size key systems (Everest 29 S & T, Everest C & D, Obverse & Quad) are available in Primus and Primus XP key system and must be ordered separately. Lock should be ordered less cylinder and Primus cylinder should be a separate line.

³ Master Keyed cylinders can be specified and will be shipped in lock packaging. For Master Keying System Summary form which should accompany the master keyed order, see page 283.

10. Select Handing (Field Reversible)

RH	Right Handed	N/C
LH	Left Handed	N/C
RHR	Right Handed Reverse	N/C
LHR	Left Handed Reverse	N/C

11. Select Battery

LLL	Less Battery Holder, Batteries, and Cover	DEDUCT \$25.90
4B	4AA Battery Kit	STANDARD
8B	8AA Battery Kit	\$39.00

12. Select Mortise Lock Armor Front

LLL	Less Armor Front	DEDUCT \$16.80
09-663	1-1/4" Wide Square Corner, Latch for MS	STANDARD
09-669	1-1/16" Wide Square Corner, Latch, options for MS	N/C
09-666	1-1/4" Wide Square Corner, Latch x Deadbolt for MD	STANDARD
09-672	1-1/16" Wide Square Corner, Latch x Deadbolt, Options for MD	N/C

13. Select Strike Plate

LLL	Less Strike	DEDUCT \$13.20
10-072	1-1/4" x 4-7/8" Square Corner + box; 1-3/16" lip length	STANDARD
10-072xx	1-1/4" x 4-7/8" Square Corner + box; specify lip length (xx) as 1" or 1-1/2"	N/C
10-072xx	1-1/4" x 4-7/8" Square Corner + box; specify lip length (xx) as 1-3/4"	\$31.30
10-075 ●	1/2" Rabbeted	\$108.00
37-015	Strike Frame Reinforcer, specify 37-015	N/C
XL11-820 △	One hole for latching functions, RH & LHR doors Lip 1-3/16"	\$13.40
XL11-821 △	One hole for latching functions, LH & RHR doors Lip 1-3/16"	\$13.40

● For 1-3/4" thick doors, use wide armor front. For over 1-3/4" thick door extended equally (EE) use 1-1/4" wide armor front.

△ Extended leadtime, consult customer service.

14. Select Door Thickness

134	1-3/4"	STANDARD
Example 138	1-3/8" to 2-3/4", Shims included (Specify in 1/8" increments)	\$58.90

15. Select Options

BAA	BAA Compliant Product	\$115.00
------------	-----------------------	-----------------

BAA compliant products must have the cover letter on page 301 included with the order. Failure to use this cover letter will result in the customer receiving non-BAA compliant product with no recourse for an RMA or refund. BAA compliant product requires a longer lead time, please contact customer service for details.

Accessories available, see pages 156-158.
Accessories include Decorative Plates, Handheld Device, etc.
Credentials available, see pages 26-31.

Pricing/product description subject to change without notice.

1-3. Select Exit Trim Type*

AD-250-993R	Exit Rim/ ¹ Concealed Vertical Rod/ ¹ Concealed Vertical Cable	\$2,378.00
AD-250-993S	Exit Surface Vertical Rod	\$2,395.00
AD-250-993M	Exit Mortise Lock	\$2,395.00

* See page 123 for exit device compatibility. ¹ Metal door only.

AD-SERIES

Networked

Standalone



AD-250-993-70-MGK



MG



MS



MSK

4. Select Function **Note:** Locking function capabilities are determined by users access control system

70*	Classroom/Storeroom	STANDARD
50*	Office △	\$10.00
40	Privacy △	\$10.00
60	Apartment △	\$10.00

* Less Door Position Switch, use suffix LDP. Deduct \$19.50

5. Select Reader **Note:** Reflects list price adder to base magnetic swipe reader price of \$656.00.

LLL	Less Reader (For reader module accessories sold separately, see page 156)	DEDUCT \$656.00
MS	Magnetic Stripe (Swipe)	N/C
MSK	Magnetic Stripe (Swipe) + Keypad	\$68.10
MG	Magnetic Stripe (Insert)	\$17.30
MGK	Magnetic Stripe (Insert) + Keypad	\$85.70

6. Select Lever*

LLL	Less interior and exterior levers	DEDUCT \$66.80
SPA	Sparta	N/C
RHO	Rhodes	N/C
ATH	Athens	N/C
TLR	Tubular	N/C
BRW	Broadway	N/C
BRK	Boardwalk	N/C
LAT	Latitude	N/C
LON	Longitude	N/C

* Tactile Warning use 8AT for Athens, 8RO for Rhodes, 8SP for Sparta and 8TR for Tubular. \$45.60 per lever. Applied to exterior lever only unless otherwise specified. Not available with 643e finish.

7. Select Finish

626	Satin Chrome	N/C
605	Bright Brass	\$139.00
606	Satin Brass	\$139.00
612	Satin Bronze	\$139.00
619	Satin Nickel	\$139.00
625	Bright Chrome	\$139.00
643e	Aged Bronze	\$139.00
626AM	Satin Chrome Antimicrobial	\$179.00

8. Select Cylinder Type

P ●△	With Cylinder, Schlage- (Everest 29 S123, 6 Pin KIL standard)	N/C
L	Less Cylinder, Schlage, Falcon, 6 Pin KIL	DEDUCT \$64.00
R ●□	With Cylinder, Schlage 6-Pin (Everest 29 S123 standard) FSIC	\$38.00
J	Less Cylinder, Schlage, 6 Pin FSIC	DEDUCT \$35.00
G ●□	With Cylinder, Schlage 7-Pin (Everest 29R standard) (factory master keyed only) SFIC	\$84.00
B	Less Cylinder, Schlage, Falcon, Competitive OEM's, 7 Pin (SFIC)	N/C
L SAR	Less Cylinder, Sargent (10L + 11L), 6 Pin KIL	DEDUCT \$64.00
L CO6	Less Cylinder, Corbin 8000, 6 Pin KIL	DEDUCT \$64.00
J SAR	Less Cylinder, Sargent 6300, 6 Pin FSIC	DEDUCT \$35.00
J CO6	Less Cylinder, Corbin 8000, 6 Pin FSIC	DEDUCT \$35.00
J CO7	Less Cylinder, Corbin 8000-7, 7 Pin FSIC, (Only RHO, 8RO, SPA, 8SP, TLR and 8TR)	DEDUCT \$35.00
J MED	Less Cylinder, Medeco 32*0201, 6 Pin FSIC (Only RHO, 8RO, SPA, 8SP lever styles)	DEDUCT \$35.00
J YA6	Less Cylinder, Yale 1210 or Medeco 31*0100, 6 Pin FSIC	DEDUCT \$35.00
J YA7	Less Cylinder, Yale 1220, 7 Pin FSIC (Only RHO, 8RO, SPA, 8SP lever styles)	DEDUCT \$35.00
L FA7	Less Cylinder, Falcon, 7 Pin, KIL (Only RHO, 8RO, SPA, 8SP lever styles)	DEDUCT \$35.00

● Master Keyed cylinders can be specified and will be shipped in lock packaging. For Master Keying System Summary form which should accompany the master keyed order, see page 283.

△ For Master Keying, additional line item 50-210 is required, \$20.10 each.

□ Control Keys for installation/removal of interchangeable cores are not furnished and must be ordered separate.

For additional assistance on Master Keying as well as restricted keyways please contact customer service.

Pricing/product description subject to change without notice.

Full Cylinder
PD LD LDSAR LDFA7

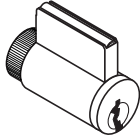

Full Size
Interchangeable Core
RD JD JD SAR JD CO6 JD YA6
JD CO7

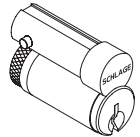

Small Format
Interchangeable Core
GD BD

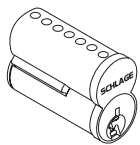

9. Select Keying Type

Open Keyway Families: KIL or FSIC ²		
S123	Everest 29 S (Key in Lever or FSIC)	STANDARD
C123	Everest C	N/C
C/CE/E/EF/F/FG/G	Classic Obverse	N/C
Restricted Keyway Families: KIL or FSIC ^{1,2}		
29 T	Everest 29 T	\$17.50
D	Everest D	\$17.50
Classic Restricted	Quad, Numbered, Reverse	\$17.50
Restricted Keyway Families: SFIC ³		
29 R	Everest 29 R	N/C
B	Everest B	N/C

¹ Everest Restricted Keyways require a Letter of Authorization to be submitted with the order. See sample Letter of Authorization, see page 295.

² Full Size key systems (Everest 29 S & T, Everest C & D, Obverse & Quad) are available in Primus and Primus XP key system and must be ordered separately. Lock should be ordered less cylinder and Primus cylinder should be a separate line.

³ Master Keyed cylinders can be specified and will be shipped in lock packaging. For Master Keying System Summary form which should accompany the master keyed order, see page 283.

10. Select Handing (Field Reversible)

RHR	Right Handed Reverse	N/C
LHR	Left Handed Reverse	N/C

11. Select Battery

LLL	Less Battery Holder, Batteries, and Cover	DEDUCT \$25.90
4B	4AA Battery Kit	STANDARD
8B	8AA Battery Kit	\$39.00

12. -13. No Selection Required

14. Select Door Thickness

134	1-3/4"	STANDARD
Example 138	1-3/8" to 2-3/4", (Specify in 1/8" increments)	\$58.90

15. Select Options

BAA	BAA Compliant Product	\$115.00
------------	-----------------------	-----------------

BAA compliant products must have the cover letter on page 301 included with the order. Failure to use this cover letter will result in the customer receiving non-BAA compliant product with no recourse for an RMA or refund. BAA compliant product requires a longer lead time, please contact customer service for details.

AD-Series Exit Trim

The AD993DT Non-Functioning "Dummy" Trim comes with a universal mounting plate and is compatible with the following exit devices:

Von Duprin 98/99 and 98/99XP

Rim, Concealed Vertical Rod (metal door only), Concealed Vertical Cable (metal door only), Surface Vertical Rod, Mortise. Low current Request-to-Exit Switch optional for future network migration.

Von Duprin 22/22F

Rim, Surface Vertical Rod

Falcon 25 - Rim

Sargent 80 Series (Narrow design & reversible rim exits not compatible) - Rim

Corbin Russwin 5000 Series - Rim

Yale 7000 - Rim

Dorma 9300 - Rim

Precision 21 - Rim (2100 converts to 21 with Precision's BP21 Kit)

Note: AD-Series Non-Functioning "Dummy" Exit Trim now available. Please see pages 152-153 for details

Accessories available, see pages 156-158.
Accessories include Decorative Plates, Handheld Device, etc.
Credentials available, see pages 26-31.



1-4. Select Chassis/ Exit Trim Type* /Reader

AD-993LLL	“Dummy” Trim Less Reader for Exit Rim/ [†] Concealed Vertical Rod/ [†] Concealed Vertical Cable /Surface Vertical Rod/Mortise Lock	\$655.00
AD-993DT	“Dummy” Trim with “Dummy” Reader Cover for Exit Rim/ [†] Concealed Vertical Rod/Surface Vertical Rod/Mortise Lock	\$668.00

* See page 123 for exit device compatibility. [†] Metal door only.



AD993DT

5. Select Lever*

LLL	Less interior and exterior levers	DEDUCT \$23.20
SPA	Sparta	N/C
RHO	Rhodes	N/C
ATH	Athens	N/C
TLR	Tubular	N/C
BRW	Broadway	N/C
BRK	Boardwalk	N/C
LAT	Latitude	N/C
LON	Longitude	N/C

* Tactile Warning use **BAT** for Athens, **BRO** for Rhodes, **BSP** for Sparta and **BTR** for Tubular. \$45.60 per lever. Applied to exterior lever only unless otherwise specified. Not available with 643e finish.

6. Select Finish

626	Satin Chrome	N/C
605	Bright Brass	\$139.00
606	Satin Brass	\$139.00
612	Satin Bronze	\$139.00
619	Satin Nickel	\$139.00
625	Bright Chrome	\$139.00
643e	Aged Bronze	\$139.00
626AM	Satin Chrome Antimicrobial	\$179.00

7. Select Cylinder Type

P ●△	With Cylinder, Schlage- (Everest 29 S123, 6 Pin KIL standard)	N/C
L	Less Cylinder, Schlage, Falcon, 6 Pin KIL	DEDUCT \$64.00
R ●□	With Cylinder, Schlage 6-Pin (Everest 29 S123 standard) FSIC	\$38.00
J	Less Cylinder, Schlage, 6 Pin FSIC	DEDUCT \$35.00
G ●□	With Cylinder, Schlage 7-Pin (Everest 29R standard) (factory master keyed only) SFIC	\$84.00
B	Less Cylinder, Schlage, Falcon, Competitive OEM's, 7 Pin (SFIC)	N/C
LSAR	Less Cylinder, Sargent (10L + 11L), 6 Pin KIL	DEDUCT \$64.00
LCO6	Less Cylinder, Corbin 8000, 6 Pin KIL	DEDUCT \$64.00
JSAR	Less Cylinder, Sargent 6300, 6 Pin FSIC	DEDUCT \$35.00
JCO6	Less Cylinder, Corbin 8000, 6 Pin FSIC	DEDUCT \$35.00
JCO7	Less Cylinder, Corbin 8000-7, 7 Pin FSIC, (Only RHO, 8RO, SPA, 8SP, TLR and 8TR)	DEDUCT \$35.00
JMED	Less Cylinder, Medeco 32*0201, 6 Pin FSIC (Only RHO, 8RO, SPA, 8SP lever styles)	DEDUCT \$35.00
JYA6	Less Cylinder, Yale 1210 or Medeco 31*0100, 6 Pin FSIC	DEDUCT \$35.00
JYA7	Less Cylinder, Yale 1220, 7 Pin FSIC (Only RHO, 8RO, SPA, 8SP lever styles)	DEDUCT \$35.00
LFA7	Less Cylinder, Falcon, 7 Pin, KIL (Only RHO, 8RO, SPA, 8SP lever styles)	DEDUCT \$35.00

● Master Keyed cylinders can be specified and will be shipped in lock packaging. For Master Keying System Summary form which should accompany the master keyed order, see page 283.

△ For Master Keying, additional line item 50-210 is required, \$20.10 each.

□ Control Keys for installation/removal of interchangeable cores are not furnished and must be ordered separate.

For additional assistance on Master Keying as well as restricted keyways please contact customer service.

Full Cylinder
PD LD LDSAR LDFA7

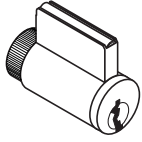

Full Size Interchangeable Core
RD JD JD SAR JD CO6 JD YA6 JD CO7

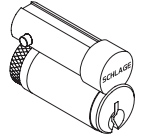

Small Format Interchangeable Core
GD BD

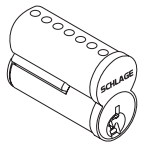

8. Select Keying Type

Open Keyway Families: KIL or FSIC ²		
S123	Everest 29 S (Key in Lever or FSIC)	STANDARD
C123	Everest C	N/C
C/CE/E/EF/ F/ FG/ G	Classic Obverse	N/C
Restricted Keyway Families: KIL or FSIC ^{1,2}		
29 T	Everest 29 T	\$17.50
D	Everest D	\$17.50
Classic Restricted	Quad, Numbered, Reverse	\$17.50
Restricted Keyway Families: SFIC ³		
29 R	Everest 29 R	N/C
B	Everest B	N/C

¹ Everest Restricted Keyways require a Letter of Authorization to be submitted with the order. See sample Letter of Authorization, see page 295.

² Full Size key systems (Everest 29 S & T, Everest C & D, Obverse & Quad) are available in Primus and Primus XP key system and must be ordered separately. Lock should be ordered less cylinder and Primus cylinder should be a separate line.

³ Master Keyed cylinders can be specified and will be shipped in lock packaging. For Master Keying System Summary form which should accompany the master keyed order, see page 283.

9. Select Handing (Field Reversible)

RHR	Right Handed Reverse	N/C
LHR	Left Handed Reverse	N/C

10. - 12. No Selection Required

13. Select Door Thickness

134	1-3/4"	STANDARD
Example 178	1-7/8" to 2-3/4", (Specify in 1/8" increments)	\$58.90

14. Select Options

BAA	BAA Compliant Product	\$115.00
------------	-----------------------	-----------------

BAA compliant products must have the cover letter on page 301 included with the order. Failure to use this cover letter will result in the customer receiving non-BAA compliant product with no recourse for an RMA or refund. BAA compliant product requires a longer lead time, please contact customer service for details.

AD-Series Exit Trim

The AD993DT Non-Functioning “Dummy” Trim comes with a universal mounting plate and is compatible with the following exit devices:

Von Duprin 98/99 and 98/99XP

Rim, Concealed Vertical Rod (metal door only), Concealed Vertical Cable (metal door only), Surface Vertical Rod, Mortise. Low current Request-to-Exit Switch optional for future network migration.

Von Duprin 22/22F

Rim, Surface Vertical Rod

Falcon 25 - Rim

Sargent 80 Series (Narrow design & reversible rim exits not compatible) - Rim

Corbin Russwin 5000 Series - Rim

Yale 7000 - Rim

Dorma 9300 - Rim

Precision 21 - Rim (2100 converts to 21 with Precision’s BP21 Kit)

Accessories available, see pages 156-158.
Accessories include Panel Interface Mobile (PIM400) Decorative Plates, Handheld Device, etc.
Credentials available, see pages 26-31.

CT5000

The CT5000 is an indoor, offline single opening controller. It is flexible and works with various card reader technologies. With the correct power supply, the CT5000 controller works with various types of locking hardware, including electric strikes, electro-magnetic locks, or EL exit devices.

If networked functionality is required in the future, the CT5000 can be upgraded to a WRI-400 by upgrading the firmware and adding one incremental piece of hardware. This provides greater adaptability in the field.

Perimeter Door Application

The CT5000 can be used for perimeter door applications with an automatic operator, electric strike and card reader

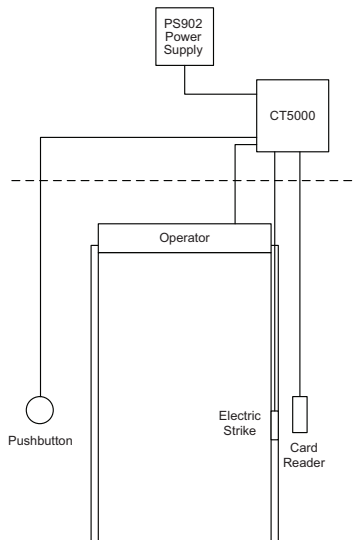

Narrow Stile Application

For narrow stile applications the CT5000 can be used with an electric strike and card reader

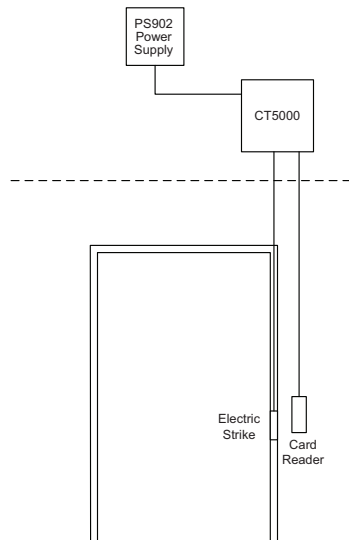

Panic Device Application

The CT5000 and a card reader along with the Von Duprin 914 Power Supply can control two EL exit devices for double door applications

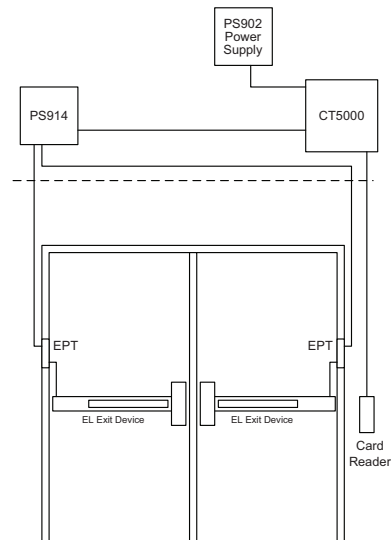

Note: All hardware shown above including exit devices, electric strikes, auto operators, power supplies, push buttons, etc. are sold separately.

Certifications

- UL 294
- Canada UL
- FCC Part 15
- Canada RSS – 210
- RoHS

Features

- Supports up to 5000 users and audits
- Comes standard with 15 foot USB remote cable connector
- Programmed using Schlage Handheld Device (HHD) via USB connection
- Power is hardwired
- Three form C relay outputs (for strike, auxiliary, and alarm)
- Supports Request to exit (remote release) and Door Position Switch input.
- Card functions supported: normal, toggle, freeze, pass through, construction, lock down, and all card plus PIN applications
- Multiple reader technologies and positions on both sides of the gate/ door
- Internal LED visual indicators (Including low battery and state of the relay)
- Compatible with Schlage Express

Credential Compatibility

- Magnetic stripe: field configurable track 1, 2, or 3
- Compatible with Schlage, Xceed ID™, AWID®, HID®, GE/CASI ProxLite®
- 125 kHz Proximity cards: 26a, 34x, 35x, 37x bit formats (reader dependant)
- 13.56 MHz Smart card: 26a, 34x, 35x, 37x, 40x, 48x bit format (reader dependant)
- Can read card serial number of Mifare DESfire (reader dependant)

The following readers are UL294 listed for use with the CT5000:

- Essex Electronics model KTP-162
- Mercury Security models MR-5 and MR-20
- XceedID models PR10, MT11, MT15, MTK15, SM10

CT5000	Offline Controller (15 ft. USB cable standard)	\$1,050.00
PS-902	2 amp Power Supply (Required)	see page 248
HHD-Kit	Schlage Handheld Programming Device (Required)	see page 156
23745565	125 ft. USB cable for CT5000 (Optional)	\$142.00
23703481	23703481 N N SL USB Wall Plate With Panel Mount Cable	\$72.20
23787088	23787088 N N SL CT5000 - 5 M USB Extension Cable - A Female To A Male	\$45.60

AD-Series Standalone Accessories



Product ID	Product Description	Product Specification	Price
Handheld Device			
HHD KIT-USB	Handheld Device Kit	Includes Handheld Device pre-loaded with SUS Application, and HHD-USB Cable. Used to initialize, manage, and test AD and CO Series devices	\$1,293.00
HH-USB	USB Replacement Cable	Used to connect Handheld Device to USB locks and accessories.	\$58.50

Handheld Device Accessories (Legacy Product Support)

HH-2PIN SERIAL	Serial Cable	Used to connect current model HHD (BM170) directly to legacy serial products without the need of a CIP	\$144.00
HH-SERIAL	Serial Cable*	Used to connect previous model HHD (BM150) with CIP to program serial products.	\$129.00
PIMWA-CV	Null Converter	Used to connect Handheld Device to WA Series PIM, using HH-SERIAL Serial Cable. (compatible to current and previous model HHDs)	\$25.90
P512112	Computer Interface Module (CIP)*	Used to program serial products using HH-SERIAL Serial Cable.	\$331.00
P101203	CIP with iButton Reader*	Used to program serial products using HH-SERIAL Serial Cable.	\$350.00

* Not compatible to current HHD (BM170)

Reader Modules - (Select by Technology) - (Please specify FINISH - Example: KP-626)

KP	Keypad Only Reader Module		\$537.00
MG	Magnetic Stripe (Insert) Reader Module - (Track 1, 2, or 3)		\$653.00
MGK	Magnetic Stripe (Insert) with Keypad Reader Module - (Track 1, 2, or 3)		\$719.00
MS	Magnetic Stripe (Swipe) Reader Module - (Track 1, 2, or 3)		\$638.00
MSK	Magnetic Stripe (Swipe) with Keypad Reader Module - (Track 1, 2, or 3)		\$705.00
MT	Multi-Technology Reader Module - (125 kHz Proximity and 13.56 MHz Smart)		\$736.00
MTK	Multi-Technology with Keypad Reader Module - (125 kHz Proximity and 13.56 MHz Smart)		\$802.00
FMK	FIPS Multi-Technology with Keypad Reader Module - (125 kHz Proximity and 13.56 MHz Smart)		\$1,008.00
DT	Dummy Trim Reader Cover		\$30.00

Reader Module Accessories

510310	Magnetic Stripe Cleaning Cards		\$38.50
---------------	--------------------------------	--	----------------

Communication Module Kits - (Please specify FINISH - Example: COM200C-626)

COM200C	AD-200/AD-250 Offline Communication Kit (Cover)	Classroom/Storeroom Functions (Cylindrical and Exit Chassis)	\$157.00
COM200L	AD-200/AD-250 Offline Communication Kit (Cover with Indicator Lens)	Privacy/Apartment Functions (Mortise Deadbolt Chassis)	\$157.00
COM200P◆	AD-200/AD-250 Offline Communication Kit (Cover with Push Button)	Privacy/Apartment/Office Functions (Cylindrical and Mortise Chassis)	\$157.00
COM300L◆■	AD-300 Hardwired Communication Kit (Cover with Indicator Lens, RS485 Communication PCB)	Classroom/Storeroom Functions (Cylindrical, Mortise and Exit Chassis) Privacy/Apartment Functions (Mortise Deadbolt Chassis)	\$348.00
COM300P◆■	AD-300 Hardwired Communication Kit (Cover with Push Button, RS485 Communication PCB)	Privacy/Apartment/Office Functions (Cylindrical and Mortise Chassis)	\$348.00
COM400L◆■	AD-400 Wireless Communication Kit (Cover with Indicator Lens, 900MHz Communication PCB)	Classroom/Storeroom Functions (Cylindrical, Mortise and Exit Chassis) Privacy/Apartment Functions (Mortise Deadbolt Chassis)	\$376.00
COM400P◆■	AD-400 Wireless Communication Kit (Cover with Push Button, 900MHz Communication PCB)	Privacy/Apartment/Office Functions (Cylindrical and Mortise Chassis)	\$376.00

◆ Must install Door Position Switch #46929121 for proper operation

■ Must order and install Pigtail Exit Adapter #23536774 for RX-LC switch if retrofitting AD-200-993 to AD-300-993 or AD-400-993

	Class	Chassis	Type	Classroom/ Storeroom (70)	Office (50)	Apartment (60)	Privacy (40)
OFFLINE	AD-200 & AD-250	CY	Cylindrical	COM200C	COM200P	COM200P	COM200P
	AD-200 & AD-250	MS	Mortise	COM200C	COM200P	COM200P	COM200P
	AD-200 & AD-250	MD	Mortise Deadbolt	N/A	N/A	COM200L	COM200L
	AD-200 & AD-250	993	Exit Trim	COM200C	N/A	N/A	N/A
NETWORKED	AD-300	CY	Cylindrical	COM300L	COM300P	COM300P	COM300P
	AD-300	MS	Mortise	COM300L	COM300P	COM300P	COM300P
	AD-300	MD	Mortise Deadbolt	N/A	N/A	COM300L	COM300L
	AD-300	993	Exit Trim	COM300L	N/A	N/A	N/A
	AD-400	CY	Cylindrical	COM400L	COM400P	COM400P	COM400P
	AD-400	MS	Mortise	COM400L	COM400P	COM400P	COM400P
	AD-400	MD	Mortise Deadbolt	N/A	N/A	COM400L	COM400L
AD-400	993	Exit Trim	COM400L	N/A	N/A	N/A	

Suffixes: C= Cover L= LED Only P= Pushbutton

Note: Connections other than Wiegand or Clock & Data may incur additional fee. Consult access control provider for details.

Pricing/product description subject to change without notice.

Product ID	Product Description	Price
------------	---------------------	-------

Door Position Switch

46929121	Door Position Switch	See page 215
----------	----------------------	--------------

Battery Cover - (Select by Battery Quantity) - (Please specify FINISH - Example: 4C-626)

4C (46929071)	4AA Battery Cover (with Screw)	See page 216
---------------	--------------------------------	--------------

8C (46929105)	8AA Battery Cover (with Screw)	See page 216
---------------	--------------------------------	--------------

Battery Holder & Cover Kit - (Select by Battery Quantity) - (Please specify FINISH - Example: 4B-626)

4B (46929055)	4AA Battery Holder & Cover Kit (Includes 4AA Battery Holder with Cable, 4AA Battery Strap, Battery Strap Screws, 4AA Battery Cover, Cover Screw, Torx Cover Screw)	See page 216
---------------	--	--------------

8B (46929089)	8AA Battery Holder & Cover Kit (Includes 8AA Battery Holder with Cable, 8AA Battery Strap, Battery Strap Screws, 8AA Battery Cover, Cover Screw, Torx Cover Screw, Mylar)	See page 216
---------------	---	--------------

Torx Tamper Screw Pack - (Select by Chassis Type) - (Please specify FINISH - Example: 23538812-626)
Cylindrical

23538812	Torx Tamper Screw Pack	See page 216
----------	------------------------	--------------

Mortise

23538820	Torx Tamper Screw Pack	See page 216
----------	------------------------	--------------

Exit

23538838	Torx Tamper Screw Pack	See page 216
----------	------------------------	--------------

Decorative Plate - (Select by Size) - (Please specify FINISH - Example: 23760283-626)

23631823	1.5" x 3.25" x .105" Decorative Plate (with Screws) - (Exit Trim)	See page 215
----------	---	--------------

23760267	1.7" x 3.5" x .075" Decorative Plate (with Screws)	See page 215
----------	--	--------------

23760283	3.2" x 3.5" x .075" Decorative Plate (with Screws)	See page 215
----------	--	--------------

23760317	6.0" x 3.5" x .075" Decorative Plate (with Screws)	See page 215
----------	--	--------------

23760325	6.6" x 3.5" x .075" Decorative Plate (with Screws)	See page 215
----------	--	--------------

23760309	8.0" x 3.5" x .075" Decorative Plate (with Screws)	See page 215
----------	--	--------------

23760291	8.0" x 3.5" x .075" Decorative Plate (with Screws and Welded Standoff)	See page 215
----------	--	--------------

23760259*	10.5" x 3.5" x .075" Decorative Plate (no Screws necessary) - (Under Lock)	See page 215
-----------	--	--------------

23760275*	12.0" x 3.5" x .075" Decorative Plate (no Screws necessary) - (Under Lock)	See page 215
-----------	--	--------------

*Please consider overall Door Thickness when ordering

Note: Single Decorative Plate. Interior and Exterior Decorative Plates may be required.

Note: Decorative Plates may have multiple applications. Please refer to AD-Series Retrofit Template Overlay guide at www.schlage.com/support for more information.

Available Finishes: 626 Satin Chrome Standard. Please consult Customer Care for 605 Bright Brass or 643E Aged Bronze.

Shim Plates

23458607	Interior Shim Plate - (for AD-200/250/300)	See page 215
----------	--	--------------

23458565	Interior Shim Plate - (for AD-400)	See page 215
----------	------------------------------------	--------------

23458599	Exterior Shim Plate	See page 215
----------	---------------------	--------------

Note: Device is 0.063" thick

Wood Mounts

44-169	AD-Series Cylindrical Mount	\$221.00
--------	-----------------------------	----------

23740251	AD-Series Mortise Mount	\$248.00
----------	-------------------------	----------

23740269	AD-Series & CO Series Exit Trim Mount	\$318.00
----------	---------------------------------------	----------

Installation Tools

40-286	Universal Clamp (For use with all AD, CO and LE Series installation templates)	\$483.00
--------	--	----------

40-288	AD Series cylindrical lock installation template	\$933.00
--------	--	----------

40-292	Universal cylindrical door position switch (DPS) installation template	\$145.00
--------	--	----------

40-287	AD Series mortise lock installation template	\$933.00
--------	--	----------

40-291	Universal mortise door position switch (DPS) installation template	\$142.00
--------	--	----------

Note: These metal lock and DPS templates require use of specially designed universal clamp to ensure drilling accuracy.

AD-Series Standalone Accessories



Product ID	Product Description	Product Specification	Price
------------	---------------------	-----------------------	-------

AD-200 Standalone Accessories

Express Level Software Package

SXPR-SFT-1	Express Offline Lock Software	Recommended for offline locks of fewer than 1000 users and/or 100 access points. Reporting of last 1000 events capability will retrieve audit trails. Must be installed on a computer that meets the minimum requirements (refer to software datasheet)	See page 201
-------------------	-------------------------------	---	---------------------

Note: Refer to Software Levels Datasheet for features and details

Express Level Software Package Accessories

P512112	Express Computer Interface Module	Used to program legacy CM/CL/KC products, using HH-SERIAL Serial Cable	See page 201
P101203	Express Computer Interface Module (with iButton)	Used to connect PC/laptop to access device	See page 201
P394548	Express Female to Female Serial Cable	Used to connect P101203 Computer Interface Module to PC/laptop	See page 201
SDB9USBCBL	Express Male DB9 to USB 6" Cable Adapter	Used to connect a USB Port device to a Serial Port device	See page 201
CRM2	Express Magnetic Stripe Enrollment Reader		See page 201
CRP2	Express Proximity Enrollment Reader		See page 201
MT20	USB/BLE (ENGAGE mobile app) MIFARE/EV1 PIV Enrollment Reader		See page 38

Express Installation & Training

SCH-EXP-INST	Express Installation & Training	Includes software installation and training. Provided by Allegion Security & Safety Consultant remotely from factory. (No discounts apply)	See page 201
---------------------	---------------------------------	--	---------------------

Remote Door Release

	Push Button Release Options	AD-200 firmware enables the use of a wired remote release of the door. Many push button types are available.	See pages 255-256
--	-----------------------------	--	--------------------------

AD-250 Accessories

CL-ENCODER-2	Campus Lock Magnetic Stripe Encoder	ISO compatible high/low coercivity with female/male serial cable.	\$4,566.00
---------------------	-------------------------------------	---	-------------------

Pricing/product description subject to change without notice.

CO-SERIES STANDALONE; MANUALLY PROGRAMMABLE	
HOW TO ORDER	160
CO-SERIES OVERVIEW	161
CO-100 STANDALONE; MANUALLY PROGRAMMABLE	172
Cylindrical	172
Mortise	174
Exit Trim	176
CO-200 STANDALONE; COMPUTER OR MANUALLY PROGRAMMABLE WITH USER RIGHTS ON LOCKS	178
Cylindrical	178
Mortise/Mortise Deadbolt	180
Exit Trim	182
CO-220 CLASSROOM LOCKDOWN	184
Cylindrical	184
Mortise	186
Exit Trim	188
CO-993DT - NON FUNCTIONING "DUMMY" TRIM FOR EXIT	190
CO-250 STANDALONE; COMPUTER PROGRAMMABLE WITH USER RIGHTS ON MAGNETIC STRIPE CARD	192
Cylindrical	192
Mortise/Mortise Deadbolt	194
Exit Trim	196
CO-993DT NON-FUNCTIONING "DUMMY" EXIT TRIM	198
CO-SERIES ACCESSORIES	200
HHD and Accessories	200
Decorative Plates	200
Shim Plates	200
Wood Mounts	200
Installation Tools	201
Express Level Software Package Accessories	201
CT5000-OFFLINE CONTROLLER	202

CONTACT INFORMATION FOR CO-SERIES STANDALONE LOCKS

Payment Address: Schlage Electronic Security
 15934 Collections Center Drive
 Chicago, IL 60693

877-671-7011	
Customer Service:	Technical Support:
Order Status, Credit Returns of Non-Defective Products, General Sales Questions	Technical Questions/Issues, Returns of Defective Products, Repairs
Email Orders To: Order_Entry_Schlage_Commercial@allegion.com	Contact For Technical Assistance: Electronic_Lock_TechProdSupport@allegion.com

Pricing/product description subject to change without notice.

How to Order:

REQUIRED FIELDS

FACTORY DEFAULT AND OPTIONS

CO - 200 - CY - 70 - MS - SPA - 626 - PD - S123 - RH - 4B - 13-247 - 10-025 - 1-3/4 - BAA

1. Series

2. Class:

- 100 Keypad Programmable
- 200 Rights on Lock
- 220 Classroom Lockdown Solution
- 250 Rights on Magnetic Stripe Credential

3. Chassis:

- CY Cylindrical
- MS Mortise
- MD Mortise Deadbolt
- 993R Exit Trim – Rim/CVR/CVC
- 993S Exit Trim – SVR
- 993M Exit Trim – Mortise
- 993DT "Dummy" Exit Trim

4. Function:

- 75 Classroom Security
- 70 Classroom/Storeroom
- 50 Office
- 40 Privacy

5. Reader:

- KP Keypad
- MSK Magnetic Stripe + Keypad (Swipe)
- MS Magnetic Stripe (Swipe)
- PRK Proximity + Keypad
- PR Proximity

6. Lever: △

- SPA Sparta ATH Athens
 - RHO Rhodes TLR Tubular
- △ To add tactile warning, use prefix 8. Example 8SPA

7. Finish:

- 626 Satin Chrome
- 605 Bright Brass
- 606 Satin Brass
- 612 Satin Bronze
- 619 Satin Nickel
- 625 Bright Chrome
- 643e Aged Bronze
- 626AM Satin Chrome (Antimicrobial Coating)

8. Cylinder Type:

- PD Schlage 6-pin Full Cylinder
- For options see individual Class/Chassis page

9. Keyway Type:

- S123 Everest 29
- For options see individual Class/Chassis page

10. Handing:

- RH Right Handed
- LH Left Handed
- RHR Right Handed Reverse
- LHR Left Handed Reverse

11. Battery Holder:

- 4B - 4AA Battery Kit

12. Backset and Latch or Armor Front:

- 13-247 2-3/4" Backset, Deadlatch, Square Corner, 1-1/8" x 2-1/4" (Standard on CY Chassis)
 - 09-663 Armor Front, 1-1/4" Wide, Square Corner (Standard on MS Chassis)
- For options see individual Class/Chassis page

13. Strike:

- 10-025 1-3/16" Lip, ANSI, no box, 1-1/4" x 4-7/8" (Standard on CY Chassis)
 - 10-072 1-3/16" Lip, 1-1/4" x 4-7/8" square corner, box (Standard on MS Chassis)
- For options see individual Class/Chassis page

14. Door Thickness:

- 1-3/4" (Standard)
- For options see individual Class/Chassis page





15. Additional Options

Pricing/product description subject to change without notice.





Series

CO-Series standalone locks are the ideal solution for facilities that want the convenience and efficiency of electronic access control without the complexity or cost of a networked system.

Class

CO-100	Standalone, keypad only, manually programmable only	
CO-200	Standalone, user access rights stored on the lock, manually or computer programmable	
CO-220	Standalone, classroom security, remote local lockdown	
CO-250	Standalone, user rights stored on magnetic stripe card, computer programmable only	

Chassis

CY: Cylindrical	Bored lock installed into a round hole in the door	
MS: Mortise	Lock case installed into a mortise rectangular "pocket" in the door	
MD: Mortise Deadbolt	Mortise lock with built-in interconnected auxiliary deadbolt	
993R: Exit Trim	Rim/Concealed Vertical Rod* (CVR) & Concealed Vertical Cable* (CVC) <i>*Metal door only</i>	
993M: Exit Trim	Mortise	
993S: Exit Trim	Surface Vertical Rod (SVR)	
993DT: Exit Trim	Non-Functioning "Dummy" Exit Trim	

Note: 1. Exit trim is only available in 70 function on CO-200, CO-220, and CO-250 models.
2. Exit trim utilizes universal hardware to simplify installation to a variety of exit device.

Pricing/product description subject to change without notice.

Exit Device Compatibility

Exit trim utilizes universal hardware to simplify installation to a variety of exit devices.





Exit Device Compatibility		Rim	SVR	CVR/CVC	Mortise
Von Duprin	98/99 and 98/99XP	●	●	●*	●
Von Duprin	22/22F	●	●		
Falcon	25	●			
Corbin Russwin®	5000	●			
Precision™	21 (2100 converts to 21 with Precision's BP21 kit)	●			
Yale®	7000	●			
Dorma®	9300	●			
Sargent®	80	●†			

● CO-220 is not compatible with surface vertical rod (SVR) devices. * Metal door only. † Narrow design and reversible rim exits not compatible

Function

CO-100

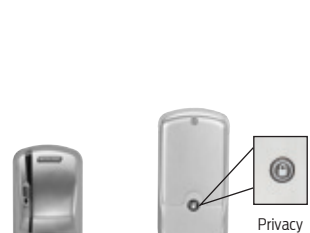
CO-200/CO-250

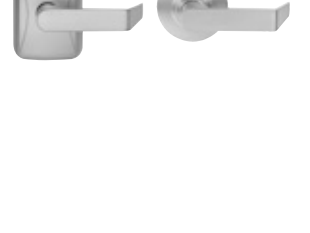

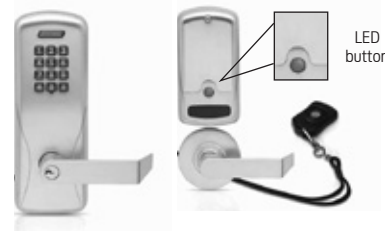

<p>70: Classroom/Storeroom</p>	<p>Lockset is normally secure. Inside lever always allows free egress. Valid toggle credentials on the exterior may be used to change to a passage or secured status.</p>	 <p>No button</p>	 <p>No button</p>
<p>50: Office</p>	<p>Lockset is normally secure. Inside lever always allows free egress. Interior pushbutton on inside housing may be used to select a passage or secured status. Meets need for lockdown function for safety and security. Note: Valid toggle credentials on the exterior may also be used to change status. Has interior pushbutton (IPB).</p>	 <p>Privacy button</p>	 <p>Privacy button</p>
<p>40: Privacy</p>	<p>Lockset is normally secure. Inside lever always allows free egress. Interior pushbutton on inside housing may be used to select a privacy status. The interior pushbutton will disable normal electronic access from the exterior. Opening the door or pressing the interior pushbutton a second time on the inside housing deactivates the privacy status. Has interior pushbutton (IPB).</p>	 <p>Privacy button</p>	 <p>Privacy button</p>

CO-220

<p>75: Classroom Security</p>	<p>Operates like a standard classroom/storeroom (70) function. When remote fob is pressed to initiate immediate local lockdown, all normal credentials are rejected and only an authorized pass through credential will allow access. Inside lever always allows free egress.</p>	 <p>LED button</p>
--------------------------------------	---	---

Pricing/product description subject to change without notice.

Reader

<p>KP: Keypad</p>	<p>12 button design</p>	
<p>MSK: Magnetic Stripe + Keypad (Swipe)</p>	<p>Configurable to read the complete Track 1, 2 or 3</p>	
<p>MS: Magnetic Stripe (Swipe)</p>		
<p>PR: Proximity</p>	<p>Reads 125 kHz proximity credentials</p>	
<p>PRK: Proximity + Keypad</p>		

Note: 3. Please refer to CO-Series data sheets and solution sheets prior to ordering to verify credential compatibility.

Lever

RHO	Rhodes		
SPA	Sparta		
TLR	Tubular		
ATH	Athens		
BRW	Broadway		
BRK	Boardwalk		
LAT	Latitude		
LON	Longitude		

- Notes:**
4. All lever designs are available in finishes 605, 606, 612, 619, 625, 626, 643E and 626AM.
 5. SPA, TLR & ATH Meet California Fire Code for 1/2" or less return to the door.
 6. Changing Lever Cylinder Compatibility on a device typically requires replacement of existing spring cage and tailpiece
 7. To order tactile warning levers use 8AT for Athens, 8RO for Rhodes, 8SP for Sparta and 8TR for Tubular. Applied to exterior lever only unless otherwise specified. Not available with 643e finish.
 8. AD Series, CO Series & ND Series levers may be interchangeable in some cases depending whether it is an interior or exterior lever, the type of chassis and the type of cylinder/ spring cage/ tail piece. Please consult the CO Series Parts guide for more information.



Finish

626	Satin Chrome	BHMA # 626E, Government # US26D
605	Bright Brass	BHMA # 605E, Government # US3
606	Satin Brass	BHMA # 606E, Government # US4
612	Satin Bronze	BHMA # 612E, Government # US10
619	Satin Nickel	
625	Bright Chrome	BHMA # 625E, Government # US26
643e	Aged Bronze	
626AM	Satin Chrome Antimicrobial	

Note: 9. Please refer to the Electronic Access Control catalog or online product information at us.allegion.com to view each finish.

Pricing/product description subject to change without notice.

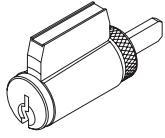
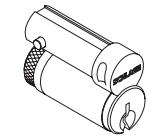
Cylinder

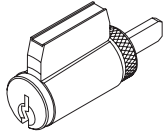
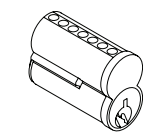
P	With cylinder Schlage- Everest 29 S123 6 Pin Key-in-Lever (KIL) Keyed different as standard with two keys	
L	Less cylinder Schlage, Falcon 6 Pin Key-in-Lever (KIL)	
R	With cylinder Schlage- Everest 29 S123 6 Pin Full Size Interchangeable Core (FSIC) Keyway one bitted as standard with two keys	
J	Less cylinder Schlage 6 Pin Full Size Interchangeable Core (FSIC)	
G	With cylinder Schlage Everest 29 R 7 Pin Small Format Interchangeable Core (SFIC) Factory master keyed with two keys as standard, master keying must be specified	
B	Less cylinder Schlage, Falcon, Competitive OEM's 7 Pin Small Format Interchangeable Core (SFIC)	
L SAR	Less cylinder Sargent (10L+11L) 6 Pin Key-in-Lever (KIL)	
LC06	Less cylinder Corbin 8000 6 Pin Key-in-Lever (KIL)	
JSAR	Less cylinder Sargent 6300 6 Pin Full Size Interchangeable Core (FSIC)	
JC06	Less cylinder Corbin 8000 6 Pin Full Size Interchangeable Core (FSIC)	
JC07	Less cylinder Corbin 8000-7 7 Pin Full Size Interchangeable Core (FSIC) (Only RHO, 8RO, SPA, BSP, TLR, 8TR)	
JMED	Less cylinder Medeco 32*0201 6 Pin Full Size Interchangeable Core (FSIC)	
JYA6	Less cylinder Yale 1210 or Medeco 31*0100 6 Pin Full Size Interchangeable Core (FSIC)	
JYA7	Less cylinder Yale 1220 7 Pin Full Size Interchangeable Core (FSIC)	
L FA7	Less cylinder Falcon 7 Pin Key-in-Lever (KIL) (Only RHO, 8RO, SPA, BSP lever styles)	

- Notes:**
- 14. Competitor lever designs come in finishes 626 standard, and 605, 606, 612, 619, 625, 643e, and 626AM with extended lead-times.
 - 15. For P, R and G -Master Keyed cylinders can be specified and will be shipped in lock packaging.
 - 16. For Master Key System Summary form which should accompany the master keyed order, see pages 283-293.
 - 17. For Master Keying, additional line item 50-210 is required for Classic and Everest cylinders.
 - 18. Control Keys for installation/removal of interchangeable cores are not furnished and must be ordered separate.
 - 19. For additional assistance on Master Keying as well as restricted keyways please contact your local sales representative.
 - 20. Spring cages & tail pieces are different based on the type of cylinder and chassis selected. Please see the CO-Series parts guide for more information.
 - 21. The CO-Series accepts many popular models of standard, SFIC, and FSIC cylinders. Consult the Keyway/Cylinder compatibility datasheet (010432) for details. See pricebook for specific configurations.

Key Systems Available Through Schlage

Everest 29 S Keyway Family	Patent protected open keyways that are available in full size key in lever and full size interchangeable core (FSIC) formats. Patent protection through 2029.
Everest 29 T Keyway Family	Patent protected restricted keyways that are available in full size key in lever and full size interchangeable core (FSIC) formats. Patent protection through 2029.
Everest D Keyway Family	Restricted keyways that are available in full size key in lever and full size interchangeable core (FSIC) formats.
Everest C Keyway Family	Open keyways that are available in full size key in lever and full size interchangeable core (FSIC) formats.
Schlage Classic Open Keyways	Classic (C/E/F): Open keyways available in key in lever and full size interchangeable core designs
Everest B Keyway Family	Restricted keyways that are available on small format interchangeable core (SFIC).
Everest 29 R Keyway Family	Patent protected restricted keyways that are available on small format interchangeable core (SFIC). Patent protection through 2029.

- Notes:** 18. Everest Restricted Keyways require a Letter of Authorization to be submitted with the order.
 19. See sample Letter of Authorization page 295.
 20. Full Size key systems (Everest 29 S & T, Everest C & D, Obverse & Quad) are available in Primus and Primus XP key system and must be ordered separately. Lock should be ordered less cylinder and Primus cylinder should be a separate line.
 21. Contact your local RSO representative for assistance in determining which format and level of exclusivity best suits your needs.

Handing

RH	Right Handed: Hinges on Right Opens Inward	
LH	Left Handed: Hinges on left Opens Inward	
RHR	Right Handed Reverse: Hinges on Right Opens Outward	
LHR	Left Handed Reverse: Hinges on Left Opens Outward	

- Notes:** 22. Exit trim 993 chassis available only with RHR or LHR option.
 23. Handing is field reversible, but requires removal of the exterior escutcheon cover. Please see CO-Series installation instructions for details.

Battery

4B	4AA Battery Holder and Cover Kit	
-----------	----------------------------------	--

- Note:** 24. CO-Series locks use standard off the shelf AA batteries.

Backset & Latchbolt (Cylindrical Chassis)

<p>13-247</p>	<p>2-3/4" Backset, Deadlatch, Square corner, 1-1/8" x 2-1/4"</p>	
<p>14-049</p>	<p>2-3/4" Backset, Deadlatch Anti-friction fire door latch, Square corner, 1-1/8" x 2-1/4", 3/4" throw</p>	
<p>14-051</p>	<p>2-3/8" Backset, Deadlatch Square corner, 1-1/8" x 2-1/4"</p>	
<p>14-050</p>	<p>3-3/4" Backset, Deadlatch Square corner, 1-1/8" x 2-1/4"</p>	
<p>43-001</p>	<p>5" Backset extension link, Deadlatch</p>	
<p>39-030</p>	<p>Rabbeted latch and strike kit, 605 and 626 only. Adapts square corner latch and 2-3/4" square corner strike to 1/2" rabbeted door and frame.</p>	<p>No image available</p>

Mortise Lock Armor Front (Mortise/Mortise Deadbolt Chassis)

<p>09-663</p>	<p>1-1/4" Wide Square Corner, Latch for MS</p>	
<p>09-669</p>	<p>1-1/16" Wide Square Corner, Latch, options for MS</p>	<p>1-1/4" Wide</p> <p>1-1/16" Wide</p>
<p>09-666</p>	<p>1-1/4" Wide Square Corner, Latch x Deadbolt for MD</p>	
<p>09-672</p>	<p>1-1/16" Wide Square Corner, Latch x Deadbolt, Options for MD</p>	<p>1-1/4" Wide</p> <p>1-1/16" Wide</p>

Notes: 25. For 1-3/4" thick doors, use wide armor front. For over 1-3/4" thick door extended equally (EE), use 1-1/4" wide armor front
 26 Available finishes are 605, 606, 612, 619, 625, and 626.
 27 Images not shown to scale. Consult CO-Series Parts Guide for more information.

Strike Plate (Cylindrical Chassis)

10-025	1-3/16" Lip, ANSI, no box, 1-1/4" x 4-7/8",	
10-013	1-1/8" Lip, Square Corner, T-strike, box, 1-1/8" - 2-3/4", 1-1/2" Lip available, must specify 1-1/2" Lip	
10-016	1-1/8" Lip, Square Corner, T-strike, deep box, fire door latch	
K510-066	Box for ANSI strike (Must be specific)	
10-072	1-3/16" Lip, 1-1/4" x 4-7/8", Square Corner, box	
10-072	7/8", 1", 1-1/2", 1-3/4", or 2" Lip, 1-1/4" x 4-7/8", Square Corner, box	
10-075	1/2" Rabbeted, For 1-3/4" thick doors, use wide armor front. For over 1-3/4" thick door extended equally (EE) use 1-1/4" wide armor front.	
37-015	Strike Frame Reinforcer, specify 37-015	
XL11-820	One hole for latching functions, RH & LHR doors Lip 1-3/16"	
XL11-821	One hole for latching functions, LH & RHR doors Lip 1-3/16"	
XQ07-351-134	Strike, ANSI, No Box, 1-1/4" x 4-7/8", 1-3/4" Lip Length	Image not available
XQ03-494-134	Strike, Square Corner, T-strike, Box, 1-1/8" x 2-3/4", 1-3/4" Lip	Image not available

Note: 33. XL11-820 & XL11-821 Extended lead time; contact customer service.

Door Thickness

1-3/4"	1-3/4"
1-3/8"	1-3/8" to 2-3/4", Shims included (Specify in 1/8" increments)

- Notes:**
- 29. Door Thickness Kits are available on page 230 to install a lock on a door that is thicker or thinner than 1-3/4". See AD-Series Parts guide for details. Locks cannot be installed on doors thicker than 2-3/4" or thinner than 1-3/8".
 - 30. Thin Door Shims are available on page 200 to install a lock on a door that is thinner than 1-3/4".
 - 31. Decorative Plates are used to cover exposed holes when retrofitting from existing locks to CO-Series locks. The size of plate required will vary based on the size and location of holes being covered. Retrofit information can be found at www.schlage.com/support.
 - 32. If under the lock decorative plates are on both sides of device, then door will become 1/8" thicker. A Door Thickness Kit of an incremental 1/8" must be ordered to accommodate under the lock plates.

Customer Name: _____

Customer Address: _____

Ship To: _____

Account #: _____

Quote #: _____

PO # & Date: _____

Price book #: _____

Shipping Instructions: _____

Requested Ship Date: _____

Order Written By: _____

For Further Information Contact
(Name, Phone, Fax) _____

	Quantity	1. Series	2. Class	3. Chassis ¹	4. Function ²	5. Reader ³	6. Lever	7. Finish	8. Cylinder	9. Keypad ⁴	10. Handing	11. Battery	12. Backset & Latch ⁵ or Armor Front ⁶	13. Strike ⁷	14. Door Thickness ⁸	15. Options
Ex.	1	CO	200	CY	70	KP	SPA	626	PD	SI23	RH	4B	13-247	10-025	1-3/4	

Please complete all information above and email order to:

Order_Entry_Schlage_Commercial@allegion.com

¹ If Exit trim is chosen, no selections are required for options #12 & #13

² Function: 70 classroom storeroom is standard if no selection is made

³ Reader: KP keypad is standard if no selection is made

⁴ Only applies to the PD, RD or GD cylinder type

⁵ Backset & Latch: 13-247 standard for cylindrical if no selection is made

⁶ Armor Front: 09-663 standard for mortise if no selection is made, 09-666 standard for mortise deadbolt if no selection is made

⁷ Strike Plate: 10-025 standard for cylindrical if no selection is made, 10-072 standard for mortise/mortise deadbolt if no selection is made

⁸ Door Thickness: 1-3/4" standard if no selection is made

Pricing/product description subject to change without notice.

1-5. Select Chassis/Function/Reader (Note: CO-Series readers are not interchangeable)

CO-100-CY-70-KP	Classroom/Storeroom with Keypad Reader; manually programmed	\$866.00
CO-100-CY-50-KP	Office with Keypad Reader; manually programmed	\$876.00
CO-100-CY-40-KP	Privacy with Keypad Reader; manually programmed	\$876.00



CO-100-CY-70-KP

CO-SERIES Standalone

6. Select Lever*

LLL	Less interior and exterior levers	DEDUCT \$45.00
SPA	Sparta	N/C
RHO	Rhodes	N/C
ATH	Athens	N/C
TLR	Tubular	N/C
BRW	Broadway	N/C
BRK	Boardwalk	N/C
LAT	Latitude	N/C
LON	Longitude	N/C

* Tactile Warning use **BAT** for Athens, **8RO** for Rhodes, **8SP** for Sparta and **8TR** for Tubular. \$45.60 per lever. Applied to exterior lever only unless otherwise specified. Not available with 643e finish.

7. Select Finish

626	Satin Chrome	N/C
605	Bright Brass	\$139.00
606	Satin Brass	\$139.00
612	Satin Bronze	\$139.00
619	Satin Nickel	\$139.00
625	Bright Chrome	\$139.00
643e	Aged Bronze	\$139.00
626AM	Satin Chrome Antimicrobial	\$179.00

8. Select Cylinder Type

P ● △	With Cylinder, Schlage- (Everest 29 S123, 6 Pin KIL standard)	N/C
L	Less Cylinder, Schlage, Falcon, 6 Pin KIL	DEDUCT \$64.00
R ● □	With Cylinder, Schlage 6-Pin (Everest 29 S123 standard) FSIC	\$38.00
J	Less Cylinder, Schlage, 6 Pin FSIC	DEDUCT \$35.00
G ● □	With Cylinder, Schlage 7-Pin (Everest 29R standard) (factory master keyed only) SFIC	\$84.00
B	Less Cylinder, Schlage, Falcon, Competitive OEM's, 7 Pin (SFIC)	N/C
L SAR	Less Cylinder, Sargent (10L + 11L), 6 Pin KIL	DEDUCT \$64.00
L CO6	Less Cylinder, Corbin 8000, 6 Pin KIL	DEDUCT \$64.00
J SAR	Less Cylinder, Sargent 6300, 6 Pin FSIC	DEDUCT \$35.00
J CO6	Less Cylinder, Corbin 8000, 6 Pin FSIC	DEDUCT \$35.00
J CO7	Less Cylinder, Corbin 8000-7, 7 Pin FSIC, (Only RHO, 8RO, SPA, 8SP, TLR and 8TR)	DEDUCT \$35.00
J MED	Less Cylinder, Medeco 32*0201, 6 Pin FSIC (Only RHO, 8RO, SPA, 8SP lever styles)	DEDUCT \$35.00
J YA6	Less Cylinder, Yale 1210 or Medeco 31*0100, 6 Pin FSIC	DEDUCT \$35.00
J YA7	Less Cylinder, Yale 1220, 7 Pin FSIC (Only RHO, 8RO, SPA, 8SP lever styles)	DEDUCT \$35.00
L FA7	Less Cylinder, Falcon, 7 Pin, KIL (Only RHO, 8RO, SPA, 8SP lever styles)	DEDUCT \$35.00

● Master Keyed cylinders can be specified and will be shipped in lock packaging. For Master Keying System Summary form which should accompany the master keyed order, see page 283.

△ For Master Keying, additional line item 50-210 is required, \$20.10 each.

□ Control Keys for installation/removal of interchangeable cores are not furnished and must be ordered separate.

For additional assistance on Master Keying as well as restricted keyways please contact customer service.

Full Cylinder
PD LD LDSAR LDFA7

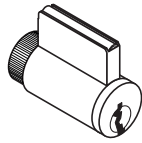

Full Size
Interchangeable Core
RD JD JD SAR JD CO6 JD YA6
JD CO7

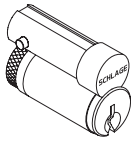

Small Format
Interchangeable Core
GD BD

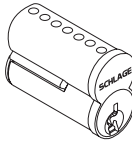

9. Select Keying Type

Open Keyway Families: KIL or FSIC ²		
S123	Everest 29 S (Key in Lever or FSIC)	STANDARD
C123	Everest C	N/C
C/CE/E/EF/ F/ FG/ G	Classic Obverse	N/C
Restricted Keyway Families: KIL or FSIC ^{1,2}		
29 T	Everest 29 T	\$17.50
D	Everest D	\$17.50
Classic Restricted	Quad, Numbered, Reverse	\$17.50
Restricted Keyway Families: SFIC ³		
29 R	Everest 29 R	N/C
B	Everest B	N/C

¹ Everest Restricted Keyways require a Letter of Authorization to be submitted with the order. See sample Letter of Authorization, see page 295.

² Full Size key systems (Everest 29 S & T, Everest C & D, Obverse & Quad) are available in Primus and Primus XP key system and must be ordered separately. Lock should be ordered less cylinder and Primus cylinder should be a separate line.

³ Master Keyed cylinders can be specified and will be shipped in lock packaging. For Master Keying System Summary form which should accompany the master keyed order, see page 283.

10. Select Handing (Field Reversible)

RH	Right Handed	N/C
LH	Left Handed	N/C
RHR	Right Handed Reverse	N/C
LHR	Left Handed Reverse	N/C

11. Select Battery

4B	4AA Battery Kit	STANDARD
-----------	-----------------	-----------------

12. Select Backset & Latchbolt

LLL	Less Latch	DEDUCT \$34.20
13-247	2-3/4" Backset, Deadlatch, Square corner, 1-1/8" x 2-1/4"	STANDARD
14-049	2-3/4" Backset, Deadlatch Anti-friction fire door latch, Square corner, 1-1/8" x 2-1/4", 3/4" throw	\$181.00
14-051	2-3/8" Backset, Deadlatch Square corner, 1-1/8" x 2-1/4"	N/C
14-050	3-3/4" Backset, Deadlatch Square corner, 1-1/8" x 2-1/4"	\$10.70
43-001	5" Backset extension link, Deadlatch	\$33.10
39-030*	Rabbeted latch and strike kit, 605 and 626 only	\$58.10

* Adapts square corner latch and 2-3/4" square corner strike to 1/2" rabbeted door and frame.

13. Select Strike Plate

LLL	Less Strike Plate	DEDUCT \$4.50
10-025	1-3/16" Lip, ANSI, no box, 1-1/4" x 4-7/8"	STANDARD
10-013*	1-1/8" Lip, Square Corner, T-strike, box, 1-1/8" - 2-3/4"	N/C
10-016	1-1/8" Lip, Square Corner, T-strike, deep box, fire door latch	\$15.70
K510-066	Box for ANSI strike (Must be specific)	N/C

* 1-1/2" Lip available, must specify 1-1/2" Lip \$8.00

14. Select Door Thickness

134	1-3/4"	STANDARD
Example 138	1-3/8" to 2-3/4", Shims included (Specify in 1/8" increments)	\$58.90

Accessories available, see pages 200-201.
Accessories include Decorative Plates, Handheld Device, etc.

1-5. Select Chassis/Function/Reader (Note: CO-Series readers are not interchangeable)

CO-100-MS-70-KP	Classroom/Storeroom with Keypad Reader; manually programmed	1,031.00
CO-100-MS-50-KP	Office with Keypad Reader; manually programmed	1,041.00
CO-100-MS-40-KP	Privacy with Keypad Reader; manually programmed	1,041.00



CO-100-MS-70-KP

6. Select Lever*

LLL	Less interior and exterior levers	DEDUCT \$63.00
SPA	Sparta	N/C
RHO	Rhodes	N/C
ATH	Athens	N/C
TLR	Tubular	N/C
BRW	Broadway	N/C
BRK	Boardwalk	N/C
LAT	Latitude	N/C
LON	Longitude	N/C

* Tactile Warning use **BAT** for Athens, **8RO** for Rhodes, **BSP** for Sparta and **8TR** for Tubular. \$45.60 per lever. Applied to exterior lever only unless otherwise specified. Not available with 643e finish.

7. Select Finish

626	Satin Chrome	N/C
605	Bright Brass	\$139.00
606	Satin Brass	\$139.00
612	Satin Bronze	\$139.00
619	Satin Nickel	\$139.00
625	Bright Chrome	\$139.00
643e	Aged Bronze	\$139.00
626AM	Satin Chrome Antimicrobial	\$179.00

8. Select Cylinder Type

P ●△	With Cylinder, Schlage- (Everest 29 S123, 6 Pin KIL standard)	N/C
L	Less Cylinder, Schlage, Falcon, 6 Pin KIL	DEDUCT \$64.00
R ●□	With Cylinder, Schlage 6-Pin (Everest 29 S123 standard) FSIC	\$38.00
J	Less Cylinder, Schlage, 6 Pin FSIC	DEDUCT \$35.00
G ●□	With Cylinder, Schlage 7-Pin (Everest 29R standard) (factory master keyed only) SFIC	\$84.00
B	Less Cylinder, Schlage, Falcon, Competitive OEM's, 7 Pin (SFIC)	N/C
LSAR	Less Cylinder, Sargent (10L + 11L), 6 Pin KIL	DEDUCT \$64.00
LCO6	Less Cylinder, Corbin 8000, 6 Pin KIL	DEDUCT \$64.00
JSAR	Less Cylinder, Sargent 6300, 6 Pin FSIC	DEDUCT \$35.00
JCO6	Less Cylinder, Corbin 8000, 6 Pin FSIC	DEDUCT \$35.00
JCO7	Less Cylinder, Corbin 8000-7, 7 Pin FSIC, (Only RHO, 8RO, SPA, 8SP, TLR and 8TR)	DEDUCT \$35.00
JMED	Less Cylinder, Medeco 32*0201, 6 Pin FSIC (Only RHO, 8RO, SPA, 8SP lever styles)	DEDUCT \$35.00
JYA6	Less Cylinder, Yale 1210 or Medeco 31*0100, 6 Pin FSIC	DEDUCT \$35.00
JYA7	Less Cylinder, Yale 1220, 7 Pin FSIC (Only RHO, 8RO, SPA, 8SP lever styles)	DEDUCT \$35.00
LFA7	Less Cylinder, Falcon, 7 Pin, KIL (Only RHO, 8RO, SPA, 8SP lever styles)	DEDUCT \$35.00

● Master Keyed cylinders can be specified and will be shipped in lock packaging. For Master Keying System Summary form which should accompany the master keyed order, see page 283.

△ For Master Keying, additional line item 50-210 is required, \$20.10 each.

□ Control Keys for installation/removal of interchangeable cores are not furnished and must be ordered separate. For additional assistance on Master Keying as well as restricted keyways please contact customer service.

Full Cylinder
PD LD LDSAR LDFA7

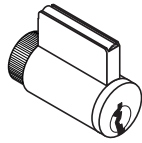

Full Size
Interchangeable Core
RD JD JD SAR JD CO6 JD YA6
JD CO7

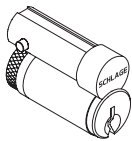

Small Format
Interchangeable Core
GD BD

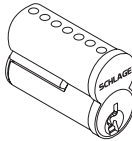

9. Select Keying Type

Open Keyway Families: KIL or FSIC ²		
S123	Everest 29 S (Key in Lever or FSIC)	STANDARD
C123	Everest C	N/C
C/CE/E/EF/ F/ FG/ G	Classic Obverse	N/C
Restricted Keyway Families: KIL or FSIC ^{1,2}		
29 T	Everest 29 T	\$17.50
D	Everest D	\$17.50
Classic Restricted	Quad, Numbered, Reverse	\$17.50
Restricted Keyway Families: SFIC ³		
29 R	Everest 29 R	N/C
B	Everest B	N/C

¹ Everest Restricted Keyways require a Letter of Authorization to be submitted with the order. See sample Letter of Authorization, see page 295.

² Full Size key systems (Everest 29 S & T, Everest C & D, Obverse & Quad) are available in Primus and Primus XP key system and must be ordered separately. Lock should be ordered less cylinder and Primus cylinder should be a separate line.

³ Master Keyed cylinders can be specified and will be shipped in lock packaging. For Master Keying System Summary form which should accompany the master keyed order, see page 283.

10. Select Handing (Field Reversible)

RH	Right Handed	N/C
LH	Left Handed	N/C
RHR	Right Handed Reverse	N/C
LHR	Left Handed Reverse	N/C

11. Select Battery

4B	4AA Battery Kit	STANDARD
-----------	-----------------	-----------------

12. Select Mortise Lock Armor Front

LLL	Less Armor Front	DEDUCT \$16.80
09-663	1-1/4" Wide Square Corner, Latch for MS	STANDARD
09-669	1-1/16" Wide Square Corner, Latch, options for MS	N/C

13. Select Strike Plate

LLL	Less Strike	DEDUCT \$13.20
10-072	1-1/4" x 4-7/8" Square Corner + box; 1-3/16" lip length	STANDARD
10-072xx	1-1/4" x 4-7/8" Square Corner + box; specify lip length (xx) as 1" or 1-1/2"	N/C
10-072xx	1-1/4" x 4-7/8" Square Corner + box; specify lip length (xx) as 1-3/4"	\$31.30
10-075●	1/2" Rabbeted	\$108.00
37-015	Strike Frame Reinforcer, specify 37-015	N/C
XL11-820 △	One hole for latching functions, RH & LHR doors Lip 1-3/16"	\$13.40
XL11-821 △	One hole for latching functions, LH & RHR doors Lip 1-3/16"	\$13.40

● For 1-3/4" thick doors, use wide armor front. For over 1-3/4" thick door extended equally (EE) use 1-1/4" wide armor front.

△ Extended leadtime, consult customer service.

14. Select Door Thickness

134	1-3/4"	STANDARD
Example 138	1-3/8" to 2-3/4", Shims included (Specify in 1/8" increments)	\$58.90

Accessories available, see pages 200-201.

Accessories include Decorative Plates, Handheld Device, etc.

1-3. Select Chassis/Function/Reader (Note: CO-Series readers are not interchangeable)

CO-100-993R*-70-KP	Exit Rim/ [†] Concealed Vertical Rod/ [†] Concealed Vertical Cable with Keypad Reader, Manually Programmed	\$1,195.00
CO-100-993R*-40-KP	Privacy with Keypad Reader; manually programmed	\$1,195.00
CO-100-993R-50-KP	Office with Keypad Reader; manually programmed	\$1,195.00
CO-100-993S*-70-KP	Exit Surface Vertical Rod with Keypad Reader, Manually Programmed	\$1,205.00
CO-100-993M*-70-KP	Exit Mortise Lock with Keypad Reader, Manually Programmed	\$1,205.00

* See page 162 for exit device compatibility. † Metal door only.



CO-100-993R-70-KP

4. Select Function

70	Classroom/Storeroom	STANDARD
-----------	---------------------	-----------------

5. Select Lever*

LLL	Less interior and exterior levers	DEDUCT \$22.50
SPA	Sparta	N/C
RHO	Rhodes	N/C
ATH	Athens	N/C
TLR	Tubular	N/C
BRW	Broadway	N/C
BRK	Boardwalk	N/C
LAT	Latitude	N/C
LON	Longitude	N/C

* Tactile Warning use **8AT** for Athens, **8RO** for Rhodes, **8SP** for Sparta and **8TR** for Tubular. \$45.60 per lever. Applied to exterior lever only unless otherwise specified. Not available with 643e finish.

6. Select Finish

626	Satin Chrome	N/C
605	Bright Brass	\$139.00
606	Satin Brass	\$139.00
612	Satin Bronze	\$139.00
619	Satin Nickel	\$139.00
625	Bright Chrome	\$139.00
643e	Aged Bronze	\$139.00
626AM	Satin Chrome Antimicrobial	\$179.00

7. Select Cylinder Type

P ● △	With Cylinder, Schlage- (Everest 29 S123, 6 Pin KIL standard)	N/C
L	Less Cylinder, Schlage, Falcon, 6 Pin KIL	DEDUCT \$64.00
R ● □	With Cylinder, Schlage 6-Pin (Everest 29 S123 standard) FSIC	\$38.00
J	Less Cylinder, Schlage, 6 Pin FSIC	DEDUCT \$35.00
G ● □	With Cylinder, Schlage 7-Pin (Everest 29R standard) (factory master keyed only) SFIC	\$84.00
B	Less Cylinder, Schlage, Falcon, Competitive OEM's, 7 Pin (SFIC)	N/C
LSAR	Less Cylinder, Sargent (10L + 11L), 6 Pin KIL	DEDUCT \$64.00
LCO6	Less Cylinder, Corbin 8000, 6 Pin KIL	DEDUCT \$64.00
JSAR	Less Cylinder, Sargent 6300, 6 Pin FSIC	DEDUCT \$35.00
JCO6	Less Cylinder, Corbin 8000, 6 Pin FSIC	DEDUCT \$35.00
JCO7	Less Cylinder, Corbin 8000-7, 7 Pin FSIC. (Only RHO, 8RO, SPA, 8SP, TLR and 8TR)	DEDUCT \$35.00
JMED	Less Cylinder, Medeco 32*0201, 6 Pin FSIC (Only RHO, 8RO, SPA, 8SP lever styles)	DEDUCT \$35.00
JYA6	Less Cylinder, Yale 1210 or Medeco 31*0100, 6 Pin FSIC	DEDUCT \$35.00
JYA7	Less Cylinder, Yale 1220, 7 Pin FSIC (Only RHO, 8RO, SPA, 8SP lever styles)	DEDUCT \$35.00
LFA7	Less Cylinder, Falcon, 7 Pin, KIL (Only RHO, 8RO, SPA, 8SP lever styles)	DEDUCT \$35.00

● Master Keyed cylinders can be specified and will be shipped in lock packaging. For Master Keying System Summary form which should accompany the master keyed order, see page 283.

△ For Master Keying, additional line item 50-210 is required, \$20.10 each.

□ Control Keys for installation/removal of interchangeable cores are not furnished and must be ordered separate.

For additional assistance on Master Keying as well as restricted keyways please contact customer service.

Full Cylinder
PD LD LDSAR LDA7

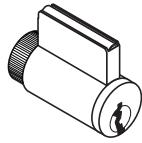

Full Size
Interchangeable Core
RD JD JD SAR JD CO6 JD YA6
JD CO7

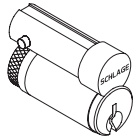

Small Format
Interchangeable Core
GD BD

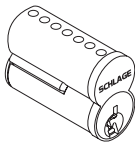

8. Select Keying Type

Open Keyway Families: KIL or FSIC ²		
S123	Everest 29 S (Key in Lever or FSIC)	STANDARD
C123	Everest C	N/C
C/CE/E/EF/F/FG/G	Classic Obverse	N/C
Restricted Keyway Families: KIL or FSIC ^{1,2}		
29 T	Everest 29 T	\$17.50
D	Everest D	\$17.50
Classic Restricted	Quad, Numbered, Reverse	\$17.50
Restricted Keyway Families: SFIC ³		
29 R	Everest 29 R	N/C
B	Everest B	N/C

¹ Everest Restricted Keyways require a Letter of Authorization to be submitted with the order. See sample Letter of Authorization, see page 295.

² Full Size key systems (Everest 29 S & T, Everest C & D, Obverse & Quad) are available in Primus and Primus XP key system and must be ordered separately. Lock should be ordered less cylinder and Primus cylinder should be a separate line.

³ Master Keyed cylinders can be specified and will be shipped in lock packaging. For Master Keying System Summary form which should accompany the master keyed order, see page 283.

9. Select Handing (Field Reversible)

RHR	Right Handed Reverse	N/C
LHR	Left Handed Reverse	N/C

10. Select Battery

4B	4AA Battery Kit	STANDARD
-----------	-----------------	-----------------

11. - 12. No Selection Required

13. Select Door Thickness

134	1-3/4"	STANDARD
Example 138	1-3/8" to 2-3/4", (Specify in 1/8" increments)	\$58.90

CO-Series Exit Trim

The CO-100 Exit Trim comes with a universal mounting plate and is compatible with the following exit devices:

Von Duprin 98/99, 98/99XP

Rim, Concealed Vertical Rod (metal door only), Concealed Vertical Cable (metal door only), Surface Vertical Rod, Mortise.

Von Duprin 22/22F

Rim, Surface Vertical Rod

Falcon 25 - Rim

Sargent 80 Series (Narrow design & reversible rim exits not compatible) - Rim

Corbin Russwin 5000 Series - Rim

Yale 7000 - Rim

Dorma 9300 - Rim

Precision 21 - Rim (2100 converts to 21 with Precision's BP21 kit)

Note: CO-Series Non-Functioning "Dummy" Exit Trim now available. Please see pages 190-191 for details

Accessories available, see pages 200-201.

Accessories include Decorative Plates, Handheld Device, etc.

Credentials available, see pages 26-31.

Pricing/product description subject to change without notice.

1-4. Select Chassis/Function

CO-200-CY-70	Classroom/Storeroom	\$1,084.00
CO-200-CY-50	Office	\$1,094.00
CO-200-CY-40	Privacy	\$1,094.00



CO-200-CY-70-PRK



CO-200-CY-70-PR



CO-200-CY-70-MSK



CO-200-CY-70-MS



CO-200-CY-70-KP

5. Select Reader (Note: CO-Series readers are not interchangeable)

KP	Keypad	N/C
MS	Magnetic Stripe (Swipe)	\$100.00
MSK	Magnetic Stripe (Swipe) + Keypad	\$166.00
PR	Proximity	\$166.00
PRK	Proximity + Keypad	\$232.00

6. Select Lever*

LLL	Less interior and exterior levers	DEDUCT \$46.40
SPA	Sparta	N/C
RHO	Rhodes	N/C
ATH	Athens	N/C
TLR	Tubular	N/C
BRW	Broadway	N/C
BRK	Boardwalk	N/C
LAT	Latitude	N/C
LON	Longitude	N/C

* Tactile Warning use 8AT for Athens, 8RO for Rhodes, 8SP for Sparta and 8TR for Tubular. \$45.60 per lever. Applied to exterior lever only unless otherwise specified. Not available with 643e finish.

7. Select Finish

626	Satin Chrome	N/C
605	Bright Brass	\$139.00
606	Satin Brass	\$139.00
612	Satin Bronze	\$139.00
619	Satin Nickel	\$139.00
625	Bright Chrome	\$139.00
643e	Aged Bronze	\$139.00
626AM	Satin Chrome Antimicrobial	\$179.00

8. Select Cylinder Type

P ●△	With Cylinder, Schlage- (Everest 29 S123, 6 Pin KIL standard)	N/C
L	Less Cylinder, Schlage, Falcon, 6 Pin KIL	DEDUCT \$64.00
R ●□	With Cylinder, Schlage 6-Pin (Everest 29 S123 standard) FSIC	\$38.00
J	Less Cylinder, Schlage, 6 Pin FSIC	DEDUCT \$35.00
G ●□	With Cylinder, Schlage 7-Pin (Everest 29R standard) (factory master keyed only) SFIC	\$84.00
B	Less Cylinder, Schlage, Falcon, Competitive OEM's, 7 Pin (SFIC)	N/C
L SAR	Less Cylinder, Sargent (10L + 11L), 6 Pin KIL	DEDUCT \$64.00
L CO6	Less Cylinder, Corbin 8000, 6 Pin KIL	DEDUCT \$64.00
J SAR	Less Cylinder, Sargent 6300, 6 Pin FSIC	DEDUCT \$35.00
J CO6	Less Cylinder, Corbin 8000, 6 Pin FSIC	DEDUCT \$35.00
J CO7	Less Cylinder, Corbin 8000-7, 7 Pin FSIC, (Only RHO, 8RO, SPA, 8SP, TLR and 8TR)	DEDUCT \$35.00
J MED	Less Cylinder, Medeco 32*0201, 6 Pin FSIC (Only RHO, 8RO, SPA, 8SP lever styles)	DEDUCT \$35.00
J YA6	Less Cylinder, Yale 1210 or Medeco 31*0100, 6 Pin FSIC	DEDUCT \$35.00
J YA7	Less Cylinder, Yale 1220, 7 Pin FSIC (Only RHO, 8RO, SPA, 8SP lever styles)	DEDUCT \$35.00
L FA7	Less Cylinder, Falcon, 7 Pin, KIL (Only RHO, 8RO, SPA, 8SP lever styles)	DEDUCT \$35.00

● Master Keyed cylinders can be specified and will be shipped in lock packaging. For Master Keying System Summary form which should accompany the master keyed order, see page 283.

△ For Master Keying, additional line item 50-210 is required, \$20.10 each.

□ Control Keys for installation/removal of interchangeable cores are not furnished and must be ordered separate.

For additional assistance on Master Keying as well as restricted keyways please contact customer service.

Full Cylinder
PD LD LDSAR LDFA7

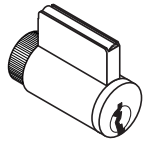

Full Size
Interchangeable Core
RD JD JD SAR JD CO6 JD YA6
JD CO7

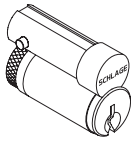

Small Format
Interchangeable Core
GD BD

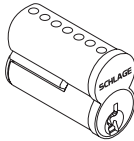

9. Select Keying Type

Open Keyway Families: KIL or FSIC ²		
S123	Everest 29 S (Key in Lever or FSIC)	STANDARD
C123	Everest C	N/C
C/CE/E/EF/ F/ FG/ G	Classic Obverse	N/C
Restricted Keyway Families: KIL or FSIC ^{1,2}		
29 T	Everest 29 T	\$17.50
D	Everest D	\$17.50
Classic Restricted	Quad, Numbered, Reverse	\$17.50
Restricted Keyway Families: SFIC ³		
29 R	Everest 29 R	N/C
B	Everest B	N/C

¹ Everest Restricted Keyways require a Letter of Authorization to be submitted with the order. See sample Letter of Authorization, see page 295.

² Full Size key systems (Everest 29 S & T, Everest C & D, Obverse & Quad) are available in Primus and Primus XP key system and must be ordered separately. Lock should be ordered less cylinder and Primus cylinder should be a separate line.

³ Master Keyed cylinders can be specified and will be shipped in lock packaging. For Master Keying System Summary form which should accompany the master keyed order, see page 283.

10. Select Handing (Field Reversible)

RH	Right Handed	N/C
LH	Left Handed	N/C
RHR	Right Handed Reverse	N/C
LHR	Left Handed Reverse	N/C

11. Select Battery

4B	4AA Battery Kit	STANDARD
-----------	-----------------	-----------------

12. Select Backset & Latchbolt

LLL	Less Latch	DEDUCT \$34.20
13-247	2-3/4" Backset, Deadlatch, Square corner, 1-1/8" x 2-1/4"	STANDARD
14-049	2-3/4" Backset, Deadlatch Anti-friction fire door latch, Square corner, 1-1/8" x 2-1/4", 3/4" throw	\$181.00
14-051	2-3/8" Backset, Deadlatch Square corner, 1-1/8" x 2-1/4"	\$10.70
14-050	3-3/4" Backset, Deadlatch Square corner, 1-1/8" x 2-1/4"	\$10.70
43-001	5" Backset extension link, Deadlatch	\$33.10
39-030*	Rabbeted latch and strike kit, 605 and 626 only	\$58.10

* Adapts square corner latch and 2-3/4" square corner strike to 1/2" rabbeted door and frame.

13. Select Strike Plate

LLL	Less Strike Plate	DEDUCT \$4.50
10-025	1-3/16" Lip, ANSI, no box, 1-1/4" x 4-7/8"	STANDARD
10-013*	1-1/8" Lip, Square Corner, T-strike, box, 1-1/8" - 2-3/4"	N/C
10-016	1-1/8" Lip, Square Corner, T-strike, deep box, fire door latch	\$15.70
K510-066	Box for ANSI strike (Must be specific)	N/C

* 1-1/2" Lip available, must specify 1-1/2" Lip \$8.00

14. Select Door Thickness

134	1-3/4"	STANDARD
Example 138	1-3/8" to 2-3/4", Shims included (Specify in 1/8" increments)	\$58.90

Accessories available, see pages 200-201.
Accessories include Decorative Plates, Handheld Device, etc.
Credentials available, see pages 26-31.

1-3. Select Chassis

CO-200-MS	Mortise	\$1,277.00
CO-200-MD	Mortise Deadbolt	\$1,346.00



CO-200-MS-70-PR



CO-200-MS-70-PRK



CO-200-MS-70-MSK



CO-200-MS-70-MS



CO-200-MS-70-KP

4. Select Function

70	Classroom/Storeroom (Not available on mortise deadbolt)	STANDARD
50	Office (Not available on mortise deadbolt)	\$10.00
40	Privacy ■	\$10.00

■ Inside Push Button (IPB) only included with Mortise (MS) chassis. Mortise deadbolt (MD) chassis comes with LED indicator only. \$10 charge does not apply to mortise deadbolt (MD) chassis.

5. Select Reader (Note: CO-Series readers are not interchangeable)

KP	Keypad	STANDARD
MS	Magnetic Stripe (Swipe)	\$100.00
MSK	Magnetic Stripe (Swipe) + Keypad	\$166.00
PR	Proximity	\$166.00
PRK	Proximity + Keypad	\$232.00

6. Select Lever*

LLL	Less interior and exterior levers	DEDUCT \$64.90
SPA	Sparta	N/C
RHO	Rhodes	N/C
ATH	Athens	N/C
TLR	Tubular	N/C
BRW	Broadway	N/C
BRK	Boardwalk	N/C
LAT	Latitude	N/C
LON	Longitude	N/C

* Tactile Warning use 8AT for Athens, 8RO for Rhodes, 8SP for Sparta and 8TR for Tubular. \$45.60 per lever. Applied to exterior lever only unless otherwise specified. Not available with 643e finish.

7. Select Finish

626	Satin Chrome	N/C
605	Bright Brass	\$139.00
606	Satin Brass	\$139.00
612	Satin Bronze	\$139.00
619	Satin Nickel	\$139.00
625	Bright Chrome	\$139.00
643e	Aged Bronze	\$139.00
626AM	Satin Chrome Antimicrobial	\$179.00

8. Select Cylinder Type

P ●△	With Cylinder, Schlage- (Everest 29 S123, 6 Pin KIL standard)	N/C
LD	Less Cylinder, Schlage, Falcon, 6 Pin KIL	DEDUCT \$64.00
R ●□	With Cylinder, Schlage 6-Pin (Everest 29 S123 standard) FSIC	\$38.00
J	Less Cylinder, Schlage, 6 Pin FSIC	DEDUCT \$35.00
G ●□	With Cylinder, Schlage 7-Pin (Everest 29R standard) (factory master keyed only) SFIC	\$84.00
B	Less Cylinder, Schlage, Falcon, Competitive OEM's, 7 Pin (SFIC)	N/C
L SAR	Less Cylinder, Sargent (10L + 11L), 6 Pin KIL	DEDUCT \$64.00
L CO6	Less Cylinder, Corbin 8000, 6 Pin KIL	DEDUCT \$64.00
J SAR	Less Cylinder, Sargent 6300, 6 Pin FSIC	DEDUCT \$35.00
J CO6	Less Cylinder, Corbin 8000, 6 Pin FSIC	DEDUCT \$35.00
J CO7	Less Cylinder, Corbin 8000-7, 7 Pin FSIC, (Only RHO, 8RO, SPA, 8SP, TLR and 8TR)	DEDUCT \$35.00
J MED	Less Cylinder, Medeco 32*0201, 6 Pin FSIC (Only RHO, 8RO, SPA, 8SP lever styles)	DEDUCT \$35.00
J YA6	Less Cylinder, Yale 1210 or Medeco 31*0100, 6 Pin FSIC	DEDUCT \$35.00
J YA7	Less Cylinder, Yale 1220, 7 Pin FSIC (Only RHO, 8RO, SPA, 8SP lever styles)	DEDUCT \$35.00
L FA7	Less Cylinder, Falcon, 7 Pin, KIL (Only RHO, 8RO, SPA, 8SP lever styles)	DEDUCT \$35.00

● Master Keyed cylinders can be specified and will be shipped in lock packaging. For Master Keying System Summary form which should accompany the master keyed order, see page 283.

△ For Master Keying, additional line item 50-210 is required, \$20.10 each.

□ Control Keys for installation/removal of interchangeable cores are not furnished and must be ordered separate.

For additional assistance on Master Keying as well as restricted keyways please contact customer service.

Pricing/product description subject to change without notice.

Full Cylinder
PD LD LDSAR LDFA7

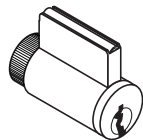

Full Size Interchangeable Core
RD JD JD SAR JD CO6 JD YA6 JD CO7

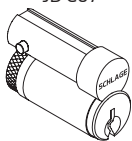

Small Format Interchangeable Core
GD BD

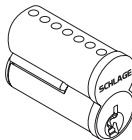

9. Select Keying Type

Open Keyway Families: KIL or FSIC ²		
S123	Everest 29 S (Key in Lever or FSIC)	STANDARD
C123	Everest C	N/C
C/CE/E/EF/ F/ FG/ G	Classic Obverse	N/C
Restricted Keyway Families: KIL or FSIC ^{1,2}		
29 T	Everest 29 T	\$17.50
D	Everest D	\$17.50
Classic Restricted	Quad, Numbered, Reverse	\$17.50
Restricted Keyway Families: SFIC ³		
29 R	Everest 29 R	N/C
B	Everest B	N/C

¹ Everest Restricted Keyways require a Letter of Authorization to be submitted with the order. See sample Letter of Authorization, see page 295.

² Full Size key systems (Everest 29 S & T, Everest C & D, Obverse & Quad) are available in Primus and Primus XP key system and must be ordered separately. Lock should be ordered less cylinder and Primus cylinder should be a separate line.

³ Master Keyed cylinders can be specified and will be shipped in lock packaging. For Master Keying System Summary form which should accompany the master keyed order, see page 283.

10. Select Handing (Field Reversible)

RH	Right Handed	N/C
LH	Left Handed	N/C
RHR	Right Handed Reverse	N/C
LHR	Left Handed Reverse	N/C

11. Select Battery

4B	4AA Battery Kit	STANDARD
-----------	-----------------	-----------------

12. Select Mortise Lock Armor Front

LLL	Less Armor Front	DEDUCT \$16.80
09-663	1-1/4" Wide Square Corner, Latch for MS	STANDARD
09-669	1-1/16" Wide Square Corner, Latch, options for MS	N/C
09-666	1-1/4" Wide Square Corner, Latch x Deadbolt for MD	STANDARD
09-672	1-1/16" Wide Square Corner, Latch x Deadbolt, Options for MD	N/C

13. Select Strike Plate

LLL	Less Strike	DEDUCT \$13.20
10-072	1-1/4" x 4-7/8" Square Corner + box; 1-3/16" lip length	STANDARD
10-072xx	1-1/4" x 4-7/8" Square Corner + box; specify lip length (xx) as 1" or 1-1/2"	N/C
10-072xx	1-1/4" x 4-7/8" Square Corner + box; specify lip length (xx) as 1-3/4"	\$31.30
10-075 ●	1/2" Rabbeted	\$108.00
37-015	Strike Frame Reinforcer, specify 37-015	N/C
XL11-820 △	One hole for latching functions, RH & LHR doors Lip 1-3/16"	\$13.40
XL11-821 △	One hole for latching functions, LH & RHR doors Lip 1-3/16"	\$58.60

● For 1-3/4" thick doors, use wide armor front. For over 1-3/4" thick door extended equally (EE) use 1-1/4" wide armor front.

△ Extended leadtime, consult customer service.

14. Select Door Thickness

134	1-3/4"	STANDARD
Example 138	1-3/8" to 2-3/4", Shims included (Specify in 1/8" increments)	\$13.40

Accessories available, see pages 200-201.

Accessories include Decorative Plates, Handheld Device, etc.

Credentials available, see pages 26-31.

Pricing/product description subject to change without notice.



1-3. Select Chassis/Exit Trim Type*

CO-200-993R	Exit Rim/ ¹ Concealed Vertical Rod/ ¹ Concealed Vertical Cable	\$1,436.00
CO-200-993S	Exit Surface Vertical Rod	\$1,455.00
CO-200-993M	Exit Mortise Lock	\$1,455.00

* See page 162 for exit device compatibility. ¹ Metal door only.



CO-200-993R-70-MSK



CO-200-993R-70-MS



CO-200-993R-70-KP



CO-200-993R-70-PR



CO-200-993R-70-PRK

4. Select Function

70	Classroom/Storeroom	STANDARD
-----------	---------------------	-----------------

5. Select Reader (Note: CO-Series readers are not interchangeable)

KP	Keypad	N/C
MS	Magnetic Stripe (Swipe)	\$100.00
MSK	Magnetic Stripe (Swipe) + Keypad	\$166.00
PR	Proximity	\$166.00
PRK	Proximity + Keypad	\$232.00

6. Select Lever*

LLL	Less interior and exterior levers	DEDUCT \$23.20
SPA	Sparta	N/C
RHO	Rhodes	N/C
ATH	Athens	N/C
TLR	Tubular	N/C
BRW	Broadway	N/C
BRK	Boardwalk	N/C
LAT	Latitude	N/C
LON	Longitude	N/C

* Tactile Warning use **BAT** for Athens, **8RO** for Rhodes, **8SP** for Sparta and **8TR** for Tubular. \$45.60 per lever. Applied to exterior lever only unless otherwise specified. Not available with 643e finish.

7. Select Finish

626	Satin Chrome	N/C
605	Bright Brass	\$139.00
606	Satin Brass	\$139.00
612	Satin Bronze	\$139.00
619	Satin Nickel	\$139.00
625	Bright Chrome	\$139.00
643e	Aged Bronze	\$139.00
626AM	Satin Chrome Antimicrobial	\$179.00

8. Select Cylinder Type

P ●△	With Cylinder, Schlage- (Everest 29 S123, 6 Pin KIL standard)	N/C
L	Less Cylinder, Schlage, Falcon, 6 Pin KIL	DEDUCT \$64.00
R ●□	With Cylinder, Schlage 6-Pin (Everest 29 S123 standard) FSIC	\$38.00
J	Less Cylinder, Schlage, 6 Pin FSIC	DEDUCT \$35.00
G ●□	With Cylinder, Schlage 7-Pin (Everest 29R standard) (factory master keyed only) SFIC	\$84.00
B	Less Cylinder, Schlage, Falcon, Competitive OEM's, 7 Pin (SFIC)	N/C
L SAR	Less Cylinder, Sargent (10L + 11L), 6 Pin KIL	DEDUCT \$64.00
L CO6	Less Cylinder, Corbin 8000, 6 Pin KIL	DEDUCT \$64.00
J SAR	Less Cylinder, Sargent 6300, 6 Pin FSIC	DEDUCT \$35.00
J CO6	Less Cylinder, Corbin 8000, 6 Pin FSIC	DEDUCT \$35.00
J CO7	Less Cylinder, Corbin 8000-7, 7 Pin FSIC, (Only RHO, 8RO, SPA, 8SP, TLR and 8TR)	DEDUCT \$35.00
J MED	Less Cylinder, Medeco 32*0201, 6 Pin FSIC (Only RHO, 8RO, SPA, 8SP lever styles)	DEDUCT \$35.00
J YA6	Less Cylinder, Yale 1210 or Medeco 31*0100, 6 Pin FSIC	DEDUCT \$35.00
J YA7	Less Cylinder, Yale 1220, 7 Pin FSIC (Only RHO, 8RO, SPA, 8SP lever styles)	DEDUCT \$35.00
L FA7	Less Cylinder, Falcon, 7 Pin, KIL (Only RHO, 8RO, SPA, 8SP lever styles)	DEDUCT \$35.00

● Master Keyed cylinders can be specified and will be shipped in lock packaging. For Master Keying System Summary form which should accompany the master keyed order, see page 283.

△ For Master Keying, additional line item 50-210 is required, \$20.10 each.

□ Control Keys for installation/removal of interchangeable cores are not furnished and must be ordered separate.

For additional assistance on Master Keying as well as restricted keyways please contact customer service.

Full Cylinder
PD LD LDSAR LDA7

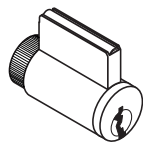

Full Size Interchangeable Core
RD JD JD SAR JD CO6 JD YA6 JD CO7

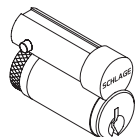

Small Format Interchangeable Core
GD BD

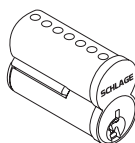

9. Select Keying Type

Open Keyway Families: KIL or FSIC ²		
S123	Everest 29 S (Key in Lever or FSIC)	STANDARD
C123	Everest C	N/C
C/CE/E/EF/ F/ FG/ G	Classic Obverse	N/C
Restricted Keyway Families: KIL or FSIC ^{1,2}		
29 T	Everest 29 T	\$17.50
D	Everest D	\$17.50
Classic Restricted	Quad, Numbered, Reverse	\$17.50
Restricted Keyway Families: SFIC ³		
29 R	Everest 29 R	N/C
B	Everest B	N/C

¹ Everest Restricted Keyways require a Letter of Authorization to be submitted with the order. See sample Letter of Authorization, see page 295.
² Full Size key systems (Everest 29 S & T, Everest C & D, Obverse & Quad) are available in Primus and Primus XP key system and must be ordered separately. Lock should be ordered less cylinder and Primus cylinder should be a separate line.
³ Master Keyed cylinders can be specified and will be shipped in lock packaging. For Master Keying System Summary form which should accompany the master keyed order, see page 283.

10. Select Handing (Field Reversible)

RHR	Right Handed Reverse	N/C
LHR	Left Handed Reverse	N/C

11. Select Battery

4B	4AA Battery Kit	STANDARD
-----------	-----------------	-----------------

12. - 13. No Selection Required

14. Select Door Thickness

134	1-3/4"	STANDARD
Example 138	1-3/8" to 2-3/4", (Specify in 1/8" increments)	\$58.90

CO-Series Exit Trim

The CO-100 Exit Trim comes with a universal mounting plate and is compatible with the following exit devices:

Von Duprin 98/99, 98/99XP

Rim, Concealed Vertical Rod (metal door only), Concealed Vertical Cable (metal door only), Surface Vertical Rod, Mortise.

Von Duprin 22/22F

Rim, Surface Vertical Rod

Falcon 25 - Rim

Sargent 80 Series (Narrow design & reversible rim exits not compatible) - Rim

Corbin Russwin 5000 Series - Rim

Yale 7000 - Rim

Dorma 9300 - Rim

Precision 21 - Rim (2100 converts to 21 with Precision's BP21 kit)

Note: CO-Series Non-Functioning "Dummy" Exit Trim now available. Please see pages 198-199 for details

Accessories available, see pages 200-201.
 Accessories include Decorative Plates, Handheld Device, etc.
 Credentials available, see pages 26-31.

Pricing/product description subject to change without notice.

1-4. Select Chassis/Function

CO-220-CY-75	Classroom Security	\$1,437.00
---------------------	--------------------	-------------------

Note: Price includes (1) pre-paired Remote Lockdown Fob, p/n 24744856, shipped with lock. Additional fobs available under "CO-Series Accessories."



CO-220-CY-75-PRK



CO-220-CY-75-PR



CO-220-CY-75-MSK



CO-220-CY-75-MS



CO-220-CY-75-KP

5. Select Reader (Note: CO-Series readers are not interchangeable)

KP	Keypad	N/C
MS	Magnetic Stripe (Swipe)	\$100.00
MSK	Magnetic Stripe (Swipe) + Keypad	\$166.00
PR	Proximity	\$166.00
PRK	Proximity + Keypad	\$232.00

6. Select Lever*

LLL	Less interior and exterior levers	DEDUCT \$47.70
SPA	Sparta	N/C
RHO	Rhodes	N/C
ATH	Athens	N/C
TLR	Tubular	N/C
BRW	Broadway	N/C
BRK	Boardwalk	N/C
LAT	Latitude	N/C
LON	Longitude	N/C

* Tactile Warning use 8AT for Athens, 8RO for Rhodes, 8SP for Sparta and 8TR for Tubular. \$45.60 per lever. Applied to exterior lever only unless otherwise specified. Not available with 643e finish.

7. Select Finish

626	Satin Chrome	N/C
605	Bright Brass	\$139.00
606	Satin Brass	\$139.00
612	Satin Bronze	\$139.00
619	Satin Nickel	\$139.00
625	Bright Chrome	\$139.00
643e	Aged Bronze	\$139.00
626AM	Satin Chrome Antimicrobial	\$179.00

8. Select Cylinder Type

P ●△	With Cylinder, Schlage- (Everest 29 S123, 6 Pin KIL standard)	N/C
L	Less Cylinder, Schlage, Falcon, 6 Pin KIL	DEDUCT \$64.00
R ●□	With Cylinder, Schlage 6-Pin (Everest 29 S123 standard) FSIC	\$38.00
J	Less Cylinder, Schlage, 6 Pin FSIC	DEDUCT \$35.00
G ●□	With Cylinder, Schlage 7-Pin (Everest 29R standard) (factory master keyed only) SFIC	\$84.00
B	Less Cylinder, Schlage, Falcon, Competitive OEM's, 7 Pin (SFIC)	N/C
L SAR	Less Cylinder, Sargent (10L + 11L), 6 Pin KIL	DEDUCT \$64.00
L CO6	Less Cylinder, Corbin 8000, 6 Pin KIL	DEDUCT \$64.00
J SAR	Less Cylinder, Sargent 6300, 6 Pin FSIC	DEDUCT \$35.00
J CO6	Less Cylinder, Corbin 8000, 6 Pin FSIC	DEDUCT \$35.00
J CO7	Less Cylinder, Corbin 8000-7, 7 Pin FSIC, (Only RHO, 8RO, SPA, 8SP, TLR and 8TR)	DEDUCT \$35.00
J MED	Less Cylinder, Medeco 32*0201, 6 Pin FSIC (Only RHO, 8RO, SPA, 8SP lever styles)	DEDUCT \$35.00
J YA6	Less Cylinder, Yale 1210 or Medeco 31*0100, 6 Pin FSIC	DEDUCT \$35.00
J YA7	Less Cylinder, Yale 1220, 7 Pin FSIC (Only RHO, 8RO, SPA, 8SP lever styles)	DEDUCT \$35.00
L FA7	Less Cylinder, Falcon, 7 Pin, KIL (Only RHO, 8RO, SPA, 8SP lever styles)	DEDUCT \$35.00

● Master Keyed cylinders can be specified and will be shipped in lock packaging. For Master Keying System Summary form which should accompany the master keyed order, see page 283.

△ For Master Keying, additional line item 50-210 is required, \$20.10 each.

□ Control Keys for installation/removal of interchangeable cores are not furnished and must be ordered separate.

For additional assistance on Master Keying as well as restricted keyways please contact customer service.

Full Cylinder
PD LD LDSAR LDFA7

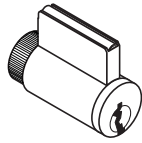

Full Size
Interchangeable Core
RD JD JD SAR JD CO6 JD YA6
JD CO7

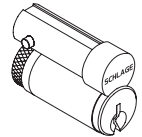

Small Format
Interchangeable Core
GD BD

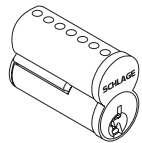

9. Select Keying Type

Open Keyway Families: KIL or FSIC ²		
S123	Everest 29 S (Key in Lever or FSIC)	STANDARD
C123	Everest C	N/C
C/CE/E/EF/ F/ FG/ G	Classic Obverse	N/C
Restricted Keyway Families: KIL or FSIC ^{1,2}		
29 T	Everest 29 T	\$17.50
D	Everest D	\$17.50
Classic Restricted	Quad, Numbered, Reverse	\$17.50
Restricted Keyway Families: SFIC ³		
29 R	Everest 29 R	N/C
B	Everest B	N/C

¹ Everest Restricted Keyways require a Letter of Authorization to be submitted with the order. See sample Letter of Authorization, see page 295.

² Full Size key systems (Everest 29 S & T, Everest C & D, Obverse & Quad) are available in Primus and Primus XP key system and must be ordered separately. Lock should be ordered less cylinder and Primus cylinder should be a separate line.

³ Master Keyed cylinders can be specified and will be shipped in lock packaging. For Master Keying System Summary form which should accompany the master keyed order, see page 283.

10. Select Handing (Field Reversible)

RH	Right Handed	N/C
LH	Left Handed	N/C
RHR	Right Handed Reverse	N/C
LHR	Left Handed Reverse	N/C

11. Select Battery

4B	4AA Battery Kit	STANDARD
-----------	-----------------	-----------------

12. Select Backset & Latchbolt

LLL	Less Latch	DEDUCT \$34.20
13-247	2-3/4" Backset, Deadlatch, Square corner, 1-1/8" x 2-1/4"	STANDARD
14-049	2-3/4" Backset, Deadlatch Anti-friction fire door latch, Square corner, 1-1/8" x 2-1/4", 3/4" throw	\$181.00
14-051	2-3/8" Backset, Deadlatch Square corner, 1-1/8" x 2-1/4"	N/C
14-050	3-3/4" Backset, Deadlatch Square corner, 1-1/8" x 2-1/4"	\$10.70
43-001	5" Backset extension link, Deadlatch	\$33.10
39-030*	Rabbeted latch and strike kit, 605 and 626 only	\$58.10

* Adapts square corner latch and 2-3/4" square corner strike to 1/2" rabbeted door and frame.

13. Select Strike Plate

LLL	Less Strike Plate	DEDUCT \$4.50
10-025	1-3/16" Lip, ANSI, no box, 1-1/4" x 4-7/8"	STANDARD
10-013*	1-1/8" Lip, Square Corner, T-strike, box, 1-1/8" - 2-3/4"	N/C
10-016	1-1/8" Lip, Square Corner, T-strike, deep box, fire door latch	\$15.70
K510-066	Box for ANSI strike (Must be specific)	N/C

* 1-1/2" Lip available, must specify 1-1/2" Lip \$8.00

14. Select Door Thickness

134	1-3/4"	STANDARD
Example 138	1-3/8" to 2-3/4", Shims included (Specify in 1/8" increments)	\$58.90

Accessories available, see pages 200-201.
Accessories include Decorative Plates, Handheld Device, etc.
Credentials available, see pages 26-31.

1-4. Select Chassis/Function

CO-220-MS-75	Classroom Security	\$1,636.00
---------------------	--------------------	-------------------

Note: Price includes (1) pre-paired Remote Lockdown Fob, p/n 44485001, shipped with lock. Additional fobs available under "CO-Series Accessories."



CO-220-MS-75-PR



CO-220-MS-75-PRK



CO-220-MS-75-MSK



CO-220-MS-75-MS



CO-220-MS-75-KP

5. Select Reader (Note: CO-Series readers are not interchangeable)

KP	Keypad	STANDARD
MS	Magnetic Stripe (Swipe)	\$100.00
MSK	Magnetic Stripe (Swipe) + Keypad	\$166.00
PR	Proximity	\$166.00
PRK	Proximity + Keypad	\$232.00

6. Select Lever*

LLL	Less interior and exterior levers	DEDUCT \$66.80
SPA	Sparta	N/C
RHO	Rhodes	N/C
ATH	Athens	N/C
TLR	Tubular	N/C
BRW	Broadway	N/C
BRK	Boardwalk	N/C
LAT	Latitude	N/C
LON	Longitude	N/C

* Tactile Warning use 8AT for Athens, 8RO for Rhodes, 8SP for Sparta and 8TR for Tubular. \$45.60 per lever. Applied to exterior lever only unless otherwise specified. Not available with 643e finish.

7. Select Finish

626	Satin Chrome	N/C
605	Bright Brass	\$139.00
606	Satin Brass	\$139.00
612	Satin Bronze	\$139.00
619	Satin Nickel	\$139.00
625	Bright Chrome	\$139.00
643e	Aged Bronze	\$139.00
626AM	Satin Chrome Antimicrobial	\$179.00

8. Select Cylinder Type

P ● △	With Cylinder, Schlage- (Everest 29 S123, 6 Pin KIL standard)	N/C
L	Less Cylinder, Schlage, Falcon, 6 Pin KIL	DEDUCT \$64.00
R ● □	With Cylinder, Schlage 6-Pin (Everest 29 S123 standard) FSIC	\$38.00
J	Less Cylinder, Schlage, 6 Pin FSIC	DEDUCT \$35.00
G ● □	With Cylinder, Schlage 7-Pin (Everest 29R standard) (factory master keyed only) SFIC	\$84.00
B	Less Cylinder, Schlage, Falcon, Competitive OEM's, 7 Pin (SFIC)	N/C
L SAR	Less Cylinder, Sargent (10L + 11L), 6 Pin KIL	DEDUCT \$64.00
L CO6	Less Cylinder, Corbin 8000, 6 Pin KIL	DEDUCT \$64.00
J SAR	Less Cylinder, Sargent 6300, 6 Pin FSIC	DEDUCT \$35.00
J CO6	Less Cylinder, Corbin 8000, 6 Pin FSIC	DEDUCT \$35.00
J CO7	Less Cylinder, Corbin 8000-7, 7 Pin FSIC, (Only RHO, 8RO, SPA, 8SP, TLR and 8TR)	DEDUCT \$35.00
J MED	Less Cylinder, Medeco 32*0201, 6 Pin FSIC (Only RHO, 8RO, SPA, 8SP lever styles)	DEDUCT \$35.00
J YA6	Less Cylinder, Yale 1210 or Medeco 31*0100, 6 Pin FSIC	DEDUCT \$35.00
J YA7	Less Cylinder, Yale 1220, 7 Pin FSIC (Only RHO, 8RO, SPA, 8SP lever styles)	DEDUCT \$35.00
L FA7	Less Cylinder, Falcon, 7 Pin, KIL (Only RHO, 8RO, SPA, 8SP lever styles)	DEDUCT \$35.00

● Master Keyed cylinders can be specified and will be shipped in lock packaging. For Master Keying System Summary form which should accompany the master keyed order, see page 283.

△ For Master Keying, additional line item 50-210 is required, \$20.10 each.

□ Control Keys for installation/removal of interchangeable cores are not furnished and must be ordered separate.

For additional assistance on Master Keying as well as restricted keyways please contact customer service.

Full Cylinder
PD LD LDSAR LDFA7

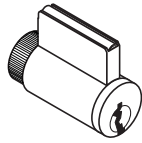

Full Size Interchangeable Core
RD JD JD SAR JD CO6 JD YA6 JD CO7

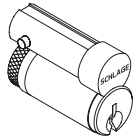

Small Format Interchangeable Core
GD BD

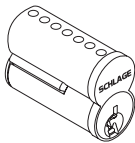

9. Select Keying Type

Open Keyway Families: KIL or FSIC ²		
S123	Everest 29 S (Key in Lever or FSIC)	STANDARD
C123	Everest C	N/C
C/CE/E/EF/ F/ FG/ G	Classic Obverse	N/C
Restricted Keyway Families: KIL or FSIC ^{1,2}		
29 T	Everest 29 T	\$17.50
D	Everest D	\$17.50
Classic Restricted	Quad, Numbered, Reverse	\$17.50
Restricted Keyway Families: SFIC ³		
29 R	Everest 29 R	N/C
B	Everest B	N/C

¹ Everest Restricted Keyways require a Letter of Authorization to be submitted with the order. See sample Letter of Authorization, see page 295.

² Full Size key systems (Everest 29 S & T, Everest C & D, Obverse & Quad) are available in Primus and Primus XP key system and must be ordered separately. Lock should be ordered less cylinder and Primus cylinder should be a separate line.

³ Master Keyed cylinders can be specified and will be shipped in lock packaging. For Master Keying System Summary form which should accompany the master keyed order, see page 283.

10. Select Handing (Field Reversible)

RH	Right Handed	N/C
LH	Left Handed	N/C
RHR	Right Handed Reverse	N/C
LHR	Left Handed Reverse	N/C

11. Select Battery

4B	4AA Battery Kit	STANDARD
-----------	-----------------	-----------------

12. Select Mortise Lock Armor Front

LLL	Less Armor Front	\$16.80
09-663	1-1/4" Wide Square Corner, Latch for MS	STANDARD
09-669	1-1/16" Wide Square Corner, Latch, options for MS	N/C
09-666	1-1/4" Wide Square Corner, Latch x Deadbolt for MD	STANDARD
09-672	1-1/16" Wide Square Corner, Latch x Deadbolt, Options for MD	N/C

13. Select Strike Plate

LLL	Less Strike	DEDUCT \$13.20
10-072	1-1/4" x 4-7/8" Square Corner + box; 1-3/16" lip length	STANDARD
10-072xx	1-1/4" x 4-7/8" Square Corner + box; specify lip length (xx) as 1" or 1-1/2"	N/C
10-072xx	1-1/4" x 4-7/8" Square Corner + box; specify lip length (xx) as 1-3/4"	\$31.30
10-075 ●	1/2" Rabbeted	\$108.00
37-015	Strike Frame Reinforcer, specify 37-015	N/C
XL11-820 △	One hole for latching functions, RH & LHR doors Lip 1-3/16"	\$13.40
XL11-821 △	One hole for latching functions, LH & RHR doors Lip 1-3/16"	\$13.40

● For 1-3/4" thick doors, use wide armor front. For over 1-3/4" thick door extended equally (EE) use 1-1/4" wide armor front.

△ Extended leadtime, consult customer service.

14. Select Door Thickness

134	1-3/4"	STANDARD
Example 138	1-3/8" to 2-3/4", Shims included (Specify in 1/8" increments)	\$58.90

Accessories available, see pages 200-201.

Accessories include Decorative Plates, Handheld Device, etc.

Credentials available, see pages 26-31.

Pricing/product description subject to change without notice.

1-3. Select Chassis/Exit Trim Type*

CO-220-993R	Exit Rim/ ¹ Concealed Vertical Rod/ ¹ Concealed Vertical Cable	\$1,800.00
CO-220-993M	Exit Mortise Lock	\$1,818.00

* See page 162 for exit device compatibility. ¹ Metal door only.



CO-220-993R-75-MSK



CO-220-993R-75-M5



CO-220-993R-75-KP



CO-220-993R-75-PR



CO-220-993R-75-PRK

4. Select Function

75	Classroom/Security	STANDARD
-----------	--------------------	-----------------

5. Select Reader (Note: CO-Series readers are not interchangeable)

KP	Keypad	N/C
MS	Magnetic Stripe (Swipe)	\$100.00
MSK	Magnetic Stripe (Swipe) + Keypad	\$166.00
PR	Proximity	\$166.00
PRK	Proximity + Keypad	\$232.00

6. Select Lever*

LLL	Less interior and exterior levers	DEDUCT \$23.20
SPA	Sparta	N/C
RHO	Rhodes	N/C
ATH	Athens	N/C
TLR	Tubular	N/C
BRW	Broadway	N/C
BRK	Boardwalk	N/C
LAT	Latitude	N/C
LON	Longitude	N/C

* Tactile Warning use **BAT** for Athens, **8RO** for Rhodes, **8SP** for Sparta and **8TR** for Tubular. \$45.60 per lever. Applied to exterior lever only unless otherwise specified. Not available with 643e finish.

7. Select Finish

626	Satin Chrome	N/C
605	Bright Brass	\$139.00
606	Satin Brass	\$139.00
612	Satin Bronze	\$139.00
619	Satin Nickel	\$139.00
625	Bright Chrome	\$139.00
643e	Aged Bronze	\$139.00
626AM	Satin Chrome Antimicrobial	\$179.00

8. Select Cylinder Type

P ●△	With Cylinder, Schlage- (Everest 29 S123, 6 Pin KIL standard)	N/C
L	Less Cylinder, Schlage, Falcon, 6 Pin KIL	DEDUCT \$64.00
R ●□	With Cylinder, Schlage 6-Pin (Everest 29 S123 standard) FSIC	\$38.00
J	Less Cylinder, Schlage, 6 Pin FSIC	DEDUCT \$35.00
G ●□	With Cylinder, Schlage 7-Pin (Everest 29R standard) (factory master keyed only) SFIC	\$84.00
B	Less Cylinder, Schlage, Falcon, Competitive OEM's, 7 Pin (SFIC)	N/C
L SAR	Less Cylinder, Sargent (10L + 11L), 6 Pin KIL	DEDUCT \$64.00
L CO6	Less Cylinder, Corbin 8000, 6 Pin KIL	DEDUCT \$64.00
J SAR	Less Cylinder, Sargent 6300, 6 Pin FSIC	DEDUCT \$35.00
J CO6	Less Cylinder, Corbin 8000, 6 Pin FSIC	DEDUCT \$35.00
J CO7	Less Cylinder, Corbin 8000-7, 7 Pin FSIC, (Only RHO, 8RO, SPA, 8SP, TLR and 8TR)	DEDUCT \$35.00
J MED	Less Cylinder, Medeco 32*0201, 6 Pin FSIC (Only RHO, 8RO, SPA, 8SP lever styles)	DEDUCT \$35.00
J YA6	Less Cylinder, Yale 1210 or Medeco 31*0100, 6 Pin FSIC	DEDUCT \$35.00
J YA7	Less Cylinder, Yale 1220, 7 Pin FSIC (Only RHO, 8RO, SPA, 8SP lever styles)	DEDUCT \$35.00
L FA7	Less Cylinder, Falcon, 7 Pin, KIL (Only RHO, 8RO, SPA, 8SP lever styles)	DEDUCT \$35.00

● Master Keyed cylinders can be specified and will be shipped in lock packaging. For Master Keying System Summary form which should accompany the master keyed order, see page 283.

△ For Master Keying, additional line item 50-210 is required, \$20.10 each.

□ Control Keys for installation/removal of interchangeable cores are not furnished and must be ordered separate.

For additional assistance on Master Keying as well as restricted keyways please contact customer service.

Full Cylinder
PD LD LDSAR LDA7

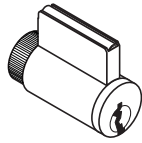

Full Size Interchangeable Core
RD JD JD SAR JD CO6 JD YA6 JD CO7

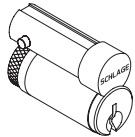

Small Format Interchangeable Core
GD BD

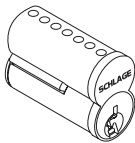

9. Select Keying Type

Open Keyway Families: KIL or FSIC ²		
S123	Everest 29 S (Key in Lever or FSIC)	STANDARD
C123	Everest C	N/C
C/CE/E/EF/ F/ FG/ G	Classic Obverse	N/C
Restricted Keyway Families: KIL or FSIC ^{1,2}		
29 T	Everest 29 T	\$17.50
D	Everest D	\$17.50
Classic Restricted	Quad, Numbered, Reverse	\$17.50
Restricted Keyway Families: SFIC ³		
29 R	Everest 29 R	N/C
B	Everest B	N/C

¹ Everest Restricted Keyways require a Letter of Authorization to be submitted with the order. See sample Letter of Authorization, see page 295.

² Full Size key systems (Everest 29 S & T, Everest C & D, Obverse & Quad) are available in Primus and Primus XP key system and must be ordered separately. Lock should be ordered less cylinder and Primus cylinder should be a separate line.

³ Master Keyed cylinders can be specified and will be shipped in lock packaging. For Master Keying System Summary form which should accompany the master keyed order, see page 283.

10. Select Handing (Field Reversible)

RHR	Right Handed Reverse	N/C
LHR	Left Handed Reverse	N/C

11. Select Battery

4B	4AA Battery Kit	STANDARD
-----------	-----------------	-----------------

12. - 13. No Selection Required

14. Select Door Thickness

134	1-3/4"	STANDARD
Example 138	1-3/8" to 2-3/4", (Specify in 1/8" increments)	\$58.90

CO-Series Exit Trim

The CO-220 Exit Trim comes with a universal mounting plate and is compatible with the following exit devices:

Von Duprin 98/99, 98/99XP

Rim, Concealed Vertical Rod (metal door only), Concealed Vertical Cable (metal door only), Mortise.

Von Duprin 22/22F - Rim

Falcon 25 - Rim

Sargent 80 Series (Narrow design & reversible rim exits not compatible) - Rim

Corbin Russwin 5000 Series - Rim

Yale 7000 - Rim

Dorma 9300 - Rim

Precision 21 - Rim (2100 converts to 21 with Precision's BP21 kit)

Note: CO-Series Non-Functioning "Dummy" Exit Trim now available. Please see page 190 for details

Accessories available, see pages 200-201.

Accessories include Decorative Plates, Handheld Device, etc.

Credentials available, see pages 26-31.

1-3. Select Chassis/ Exit Trim Type*

CO-993DT	Dummy Trim with Dummy Reader Cover and CO-100/200/250 Interior Escutcheon for Exit Rim/ [†] Concealed Vertical Rod/ [†] Concealed Vertical Cable/Surface Vertical Rod/Mortise Lock	\$718.00
CO-220-993DT	Dummy Trim with Dummy Reader Cover and CO-220 Interior Escutcheon for Exit Rim/ [†] Concealed Vertical Rod / [†] Concealed Vertical Cable / Mortise Lock	\$658.00

* See page 162 for exit device compatibility. [†] Metal door only.



CO993DT

4. Select Lever*

LLL	Less interior and exterior levers	DEDUCT \$23.20
SPA	Sparta	N/C
RHO	Rhodes	N/C
ATH	Athens	N/C
TLR	Tubular	N/C
BRW	Broadway	N/C
BRK	Boardwalk	N/C
LAT	Latitude	N/C
LON	Longitude	N/C

* Tactile Warning use 8AT for Athens, 8RO for Rhodes, 8SP for Sparta and 8TR for Tubular. \$44.30 per lever. Applied to exterior lever only unless otherwise specified. Not available with 643e finish.

5. Select Finish

626	Satin Chrome	N/C
605	Bright Brass	\$139.00
606	Satin Brass	\$139.00
612	Satin Bronze	\$139.00
619	Satin Nickel	\$139.00
625	Bright Chrome	\$139.00
643e	Aged Bronze	\$139.00
626AM	Satin Chrome Antimicrobial	\$179.00

6. Select Cylinder Type

P ● △	With Cylinder, Schlage- (Everest 29 S123, 6 Pin KIL standard)	N/C
L	Less Cylinder, Schlage, Falcon, 6 Pin KIL	DEDUCT \$64.00
R ● □	With Cylinder, Schlage 6-Pin (Everest 29 S123 standard) FSIC	\$38.00
J	Less Cylinder, Schlage, 6 Pin FSIC	DEDUCT \$35.00
G ● □	With Cylinder, Schlage 7-Pin (Everest 29R standard) (factory master keyed only) SFIC	\$84.00
B	Less Cylinder, Schlage, Falcon, Competitive OEM's, 7 Pin (SFIC)	N/C
L SAR	Less Cylinder, Sargent (10L + 11L), 6 Pin KIL	DEDUCT \$64.00
L CO6	Less Cylinder, Corbin 8000, 6 Pin KIL	DEDUCT \$64.00
J SAR	Less Cylinder, Sargent 6300, 6 Pin FSIC	DEDUCT \$35.00
J CO6	Less Cylinder, Corbin 8000, 6 Pin FSIC	DEDUCT \$35.00
J CO7	Less Cylinder, Corbin 8000-7, 7 Pin FSIC, (Only RHO, 8RO, SPA, 8SP, TLR and 8TR)	DEDUCT \$35.00
J MED	Less Cylinder, Medeco 32*0201, 6 Pin FSIC (Only RHO, 8RO, SPA, 8SP lever styles)	DEDUCT \$35.00
J YA6	Less Cylinder, Yale 1210 or Medeco 31*0100, 6 Pin FSIC	DEDUCT \$35.00
J YA7	Less Cylinder, Yale 1220, 7 Pin FSIC (Only RHO, 8RO, SPA, 8SP lever styles)	DEDUCT \$35.00
L FA7	Less Cylinder, Falcon, 7 Pin, KIL (Only RHO, 8RO, SPA, 8SP lever styles)	DEDUCT \$35.00

● Master Keyed cylinders can be specified and will be shipped in lock packaging. For Master Keying System Summary form which should accompany the master keyed order, see page 283.

△ For Master Keying, additional line item 50-210 is required, \$19.50 each.

□ Control Keys for installation/removal of interchangeable cores are not furnished and must be ordered separate.

For additional assistance on Master Keying as well as restricted keyways please contact customer service.

Full Cylinder
PD LD LDSAR LDA7

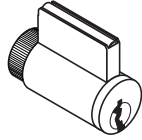

Full Size
Interchangeable Core
RD JD JD SAR JD CO6 JD YA6
JD CO7

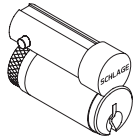

Small Format
Interchangeable Core
GD BD

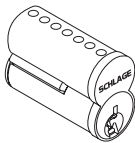

7. Select Keying Type

Open Keyway Families: KIL or FSIC ²		
S123	Everest 29 S (Key in Lever or FSIC)	STANDARD
C123	Everest C	N/C
C/CE/E/EF/F/FG/G	Classic Obverse	N/C
Restricted Keyway Families: KIL or FSIC ^{1,2}		
29 T	Everest 29 T	\$17.50
D	Everest D	\$17.50
Classic Restricted	Quad, Numbered, Reverse	\$17.50
Restricted Keyway Families: SFIC ³		
29 R	Everest 29 R	N/C
B	Everest B	N/C

¹ Everest Restricted Keyways require a Letter of Authorization to be submitted with the order. See sample Letter of Authorization, see page 295.

² Full Size key systems (Everest 29 S & T, Everest C & D, Obverse & Quad) are available in Primus and Primus XP key system and must be ordered separately. Lock should be ordered less cylinder and Primus cylinder should be a separate line.

³ Master Keyed cylinders can be specified and will be shipped in lock packaging. For Master Keying System Summary form which should accompany the master keyed order, see page 283.

8. Select Handing (Field Reversible)

RHR	Right Handed Reverse	N/C
LHR	Left Handed Reverse	N/C

9. - 10. No Selection Required

11. Select Door Thickness

134	1-3/4"	STANDARD
Example 138	1-3/8" to 2-3/4", (Specify in 1/8" increments)	\$58.90

CO-Series Exit Trim

The CO-Series Exit Trim comes with a universal mounting plate and is compatible with the following exit devices:

Von Duprin 98/99, 98/99XP

Rim, Concealed Vertical Rod (metal door only), Concealed Vertical Cable (metal door only), Surface Vertical Rod*, Mortise.

Von Duprin 22/22F

Rim, Surface Vertical Rod*

Falcon 25 - Rim

Sargent 80 Series (Narrow design & reversible rim exits not compatible) - Rim

Corbin Russwin 5000 Series - Rim

Yale 7000 - Rim

Dorma 9300 - Rim

Precision 21 - Rim (2100 converts to 21 with Precision's BP21 kit)

*CO-100, CO-200 and CO-250 only.

Accessories available, see pages 200-201.

Accessories include Decorative Plates, Handheld Device, etc.

Credentials available, see pages 26-31.

1-4. Select Chassis/Function

CO-250-CY-70	Classroom/Storeroom	\$1,224.00
CO-250-CY-50	Office	\$1,234.00
CO-250-CY-40	Privacy	\$1,234.00



CO-250-CY-70-MS



CO-250-CY-70-MSK

5. Select Reader (Note: CO-Series readers are not interchangeable)

MS	Magnetic Stripe (Swipe)	N/C
MSK	Magnetic Stripe (Swipe) + Keypad	\$68.10

6. Select Lever*

LLL	Less interior and exterior levers	DEDUCT \$47.70
SPA	Sparta	N/C
RHO	Rhodes	N/C
ATH	Athens	N/C
TLR	Tubular	N/C
BRW	Broadway	N/C
BRK	Boardwalk	N/C
LAT	Latitude	N/C
LON	Longitude	N/C

* Tactile Warning use 8AT for Athens, 8RO for Rhodes, 8SP for Sparta and 8TR for Tubular. \$45.60 per lever. Applied to exterior lever only unless otherwise specified. Not available with 643e finish.

7. Select Finish

626	Satin Chrome	N/C
605	Bright Brass	\$139.00
606	Satin Brass	\$139.00
612	Satin Bronze	\$139.00
619	Satin Nickel	\$139.00
625	Bright Chrome	\$139.00
643e	Aged Bronze	\$139.00
626AM	Satin Chrome Antimicrobial	\$179.00

8. Select Cylinder Type

P ●△	With Cylinder, Schlage- (Everest 29 S123, 6 Pin KIL standard)	N/C
L	Less Cylinder, Schlage, Falcon, 6 Pin KIL	DEDUCT \$64.00
R ●□	With Cylinder, Schlage 6-Pin (Everest 29 S123 standard) FSIC	\$38.00
J	Less Cylinder, Schlage, 6 Pin FSIC	DEDUCT \$35.00
G ●□	With Cylinder, Schlage 7-Pin (Everest 29R standard) (factory master keyed only) SFIC	\$82.00
B	Less Cylinder, Schlage, Falcon, Competitive OEM's, 7 Pin (SFIC)	N/C
L SAR	Less Cylinder, Sargent (10L + 11L), 6 Pin KIL	DEDUCT \$64.00
L CO6	Less Cylinder, Corbin 8000, 6 Pin KIL	DEDUCT \$64.00
J SAR	Less Cylinder, Sargent 6300, 6 Pin FSIC	DEDUCT \$35.00
J CO6	Less Cylinder, Corbin 8000, 6 Pin FSIC	DEDUCT \$35.00
J CO7	Less Cylinder, Corbin 8000-7, 7 Pin FSIC, (Only RHO, 8RO, SPA, 8SP, TLR and 8TR)	DEDUCT \$35.00
J MED	Less Cylinder, Medeco 32*0201, 6 Pin FSIC (Only RHO, 8RO, SPA, 8SP lever styles)	DEDUCT \$35.00
J YA6	Less Cylinder, Yale 1210 or Medeco 31*0100, 6 Pin FSIC	DEDUCT \$35.00
J YA7	Less Cylinder, Yale 1220, 7 Pin FSIC (Only RHO, 8RO, SPA, 8SP lever styles)	DEDUCT \$35.00
L FA7	Less Cylinder, Falcon, 7 Pin, KIL (Only RHO, 8RO, SPA, 8SP lever styles)	DEDUCT \$35.00

● Master Keyed cylinders can be specified and will be shipped in lock packaging. For Master Keying System Summary form which should accompany the master keyed order, see page 283.
 △ For Master Keying, additional line item 50-210 is required, \$20.10 each.
 □ Control Keys for installation/removal of interchangeable cores are not furnished and must be ordered separate.
 For additional assistance on Master Keying as well as restricted keyways please contact customer service.

Full Cylinder
PD LD LDSAR LDFA7

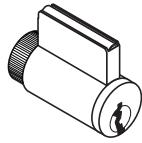

Full Size
Interchangeable Core
RD JD JD SAR JD CO6 JD YA6
JD CO7

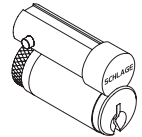

Small Format
Interchangeable Core
GD BD

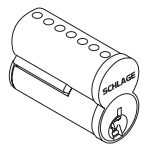

9. Select Keying Type

Open Keyway Families: KIL or FSIC ²		
S123	Everest 29 S (Key in Lever or FSIC)	STANDARD
C123	Everest C	N/C
C/CE/E/EF/ F/ FG/ G	Classic Obverse	N/C
Restricted Keyway Families: KIL or FSIC ^{1,2}		
29 T	Everest 29 T	\$17.50
D	Everest D	\$17.50
Classic Restricted	Quad, Numbered, Reverse	\$17.50
Restricted Keyway Families: SFIC ³		
29 R	Everest 29 R	N/C
B	Everest B	N/C

¹ Everest Restricted Keyways require a Letter of Authorization to be submitted with the order. See sample Letter of Authorization, see page 295.

² Full Size key systems (Everest 29 S & T, Everest C & D, Obverse & Quad) are available in Primus and Primus XP key system and must be ordered separately. Lock should be ordered less cylinder and Primus cylinder should be a separate line.

³ Master Keyed cylinders can be specified and will be shipped in lock packaging. For Master Keying System Summary form which should accompany the master keyed order, see page 283.

10. Select Handing (Field Reversible)

RH	Right Handed	N/C
LH	Left Handed	N/C
RHR	Right Handed Reverse	N/C
LHR	Left Handed Reverse	N/C

11. Select Battery

4B	4AA Battery Kit	STANDARD
-----------	-----------------	-----------------

12. Select Backset & Latchbolt

LLL	Less Latch	DEDUCT \$34.20
13-247	2-3/4" Backset, Deadlatch, Square corner, 1-1/8" x 2-1/4"	STANDARD
14-049	2-3/4" Backset, Deadlatch Anti-friction fire door latch, Square corner, 1-1/8" x 2-1/4", 3/4" throw	\$181.00
14-051	2-3/8" Backset, Deadlatch Square corner, 1-1/8" x 2-1/4"	N/C
14-050	3-3/4" Backset, Deadlatch Square corner, 1-1/8" x 2-1/4"	\$10.70
43-001	5" Backset extension link, Deadlatch	\$33.10
39-030*	Rabbeted latch and strike kit, 605 and 626 only	\$58.10

* Adapts square corner latch and 2-3/4" square corner strike to 1/2" rabbeted door and frame.

13. Select Strike Plate

LLL	Less Strike Plate	DEDUCT \$4.50
10-025	1-3/16" Lip, ANSI, no box, 1-1/4" x 4-7/8"	STANDARD
10-013*	1-1/8" Lip, Square Corner, T-strike, box, 1-1/8" - 2-3/4"	N/C
10-016	1-1/8" Lip, Square Corner, T-strike, deep box, fire door latch	\$15.70
K510-066	Box for ANSI strike (Must be specific)	N/C

* 1-1/2" Lip available, must specify 1-1/2" Lip \$8.00

14. Select Door Thickness

134	1-3/4"	STANDARD
Example 138	1-3/8" to 2-3/4", Shims included (Specify in 1/8" increments)	\$58.90

Accessories available, see pages 200-201.
Accessories include Decorative Plates, Handheld Device, etc.
Credentials available, see pages 26-31.

1-3. Select Chassis/Function

CO-250-MS	Mortise	\$1,449.00
CO-250-MD	Mortise Deadbolt	\$1,521.00

4. Select Function

70	Classroom/Storeroom (Not available on mortise deadbolt)	STANDARD
50	Office (Not available on mortise deadbolt)	\$10.00
40	Privacy ■	\$10.00

■ Inside Push Button (IPB) only included with Mortise (MS) chassis. Mortise deadbolt (MD) chassis comes with LED indicator only. \$10 charge does not apply to mortise deadbolt (MD) chassis.

5. Select Reader (Note: CO-Series readers are not interchangeable)

MS	Magnetic Stripe (Swipe)	N/C
MSK	Magnetic Stripe (Swipe) + Keypad	\$68.10

6. Select Lever*

LLL	Less interior and exterior levers	DEDUCT \$47.70
SPA	Sparta	N/C
RHO	Rhodes	N/C
ATH	Athens	N/C
TLR	Tubular	N/C
BRW	Broadway	N/C
BRK	Boardwalk	N/C
LAT	Latitude	N/C
LON	Longitude	N/C

* Tactile Warning use 8AT for Athens, 8RO for Rhodes, 8SP for Sparta and 8TR for Tubular. \$45.60 per lever. Applied to exterior lever only unless otherwise specified. Not available with 643e finish.

7. Select Finish

626	Satin Chrome	N/C
605	Bright Brass	\$139.00
606	Satin Brass	\$139.00
612	Satin Bronze	\$139.00
619	Satin Nickel	\$139.00
625	Bright Chrome	\$139.00
643e	Aged Bronze	\$139.00
626AM	Satin Chrome Antimicrobial	\$179.00

8. Select Cylinder Type

P ●△	With Cylinder, Schlage- (Everest 29 S123, 6 Pin KIL standard)	N/C
L	Less Cylinder, Schlage, Falcon, 6 Pin KIL	DEDUCT \$64.00
R ●□	With Cylinder, Schlage 6-Pin (Everest 29 S123 standard) FSIC	\$38.00
J	Less Cylinder, Schlage, 6 Pin FSIC	DEDUCT \$35.00
G ●□	With Cylinder, Schlage 7-Pin (Everest 29R standard) (factory master keyed only) SFIC	\$84.00
B	Less Cylinder, Schlage, Falcon, Competitive OEM's, 7 Pin (SFIC)	N/C
LSAR	Less Cylinder, Sargent (10L + 11L), 6 Pin KIL	DEDUCT \$64.00
LCO6	Less Cylinder, Corbin 8000, 6 Pin KIL	DEDUCT \$64.00
JSAR	Less Cylinder, Sargent 6300, 6 Pin FSIC	DEDUCT \$35.00
JCO6	Less Cylinder, Corbin 8000, 6 Pin FSIC	DEDUCT \$35.00
JCO7	Less Cylinder, Corbin 8000-7, 7 Pin FSIC, (Only RHO, 8RO, SPA, 8SP, TLR and 8TR)	DEDUCT \$35.00
JMED	Less Cylinder, Medeco 32*0201, 6 Pin FSIC (Only RHO, 8RO, SPA, 8SP lever styles)	DEDUCT \$35.00
JYA6	Less Cylinder, Yale 1210 or Medeco 31*0100, 6 Pin FSIC	DEDUCT \$35.00
JYA7	Less Cylinder, Yale 1220, 7 Pin FSIC (Only RHO, 8RO, SPA, 8SP lever styles)	DEDUCT \$35.00
LFA7	Less Cylinder, Falcon, 7 Pin, KIL (Only RHO, 8RO, SPA, 8SP lever styles)	DEDUCT \$35.00

● Master Keyed cylinders can be specified and will be shipped in lock packaging. For Master Keying System Summary form which should accompany the master keyed order, see page 283.

△ For Master Keying, additional line item 50-210 is required, \$20.10 each.

□ Control Keys for installation/removal of interchangeable cores are not furnished and must be ordered separate. For additional assistance on Master Keying as well as restricted keyways please contact customer service.



CO-250-MS-70-MSK



CO-250-MS-70-MS

Full Cylinder
PD LD LDSAR LDFA7

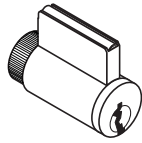

Full Size
Interchangeable Core
RD JD JD SAR JD CO6 JD YA6
JD CO7

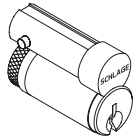

Small Format
Interchangeable Core
GD BD

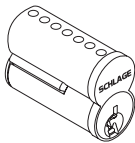

9. Select Keying Type

Open Keyway Families: KIL or FSIC ²		
S123	Everest 29 S (Key in Lever or FSIC)	STANDARD
C123	Everest C	N/C
C/CE/E/EF/F/FG/G	Classic Obverse	N/C
Restricted Keyway Families: KIL or FSIC ^{1,2}		
29 T	Everest 29 T	\$17.50
D	Everest D	\$17.50
Classic Restricted	Quad, Numbered, Reverse	\$17.50
Restricted Keyway Families: SFIC ³		
29 R	Everest 29 R	N/C
B	Everest B	N/C

¹ Everest Restricted Keyways require a Letter of Authorization to be submitted with the order. See sample Letter of Authorization, see page 295.

² Full Size key systems (Everest 29 S & T, Everest C & D, Obverse & Quad) are available in Primus and Primus XP key system and must be ordered separately. Lock should be ordered less cylinder and Primus cylinder should be a separate line.

³ Master Keyed cylinders can be specified and will be shipped in lock packaging. For Master Keying System Summary form which should accompany the master keyed order, see page 283.

10. Select Handing (Field Reversible)

RH	Right Handed	N/C
LH	Left Handed	N/C
RHR	Right Handed Reverse	N/C
LHR	Left Handed Reverse	N/C

11. Select Battery

4B	4AA Battery Kit	STANDARD
-----------	-----------------	-----------------

12. Select Mortise Lock Armor Front

LLL	Less Armor Front	DEDUCT \$16.80
09-663	1-1/4" Wide Square Corner, Latch for MS	STANDARD
09-669	1-1/16" Wide Square Corner, Latch, options for MS	N/C
09-666	1-1/4" Wide Square Corner, Latch x Deadbolt for MD	STANDARD
09-672	1-1/16" Wide Square Corner, Latch x Deadbolt, Options for MD	N/C

13. Select Strike Plate

LLL	Less Strike	DEDUCT \$13.20
10-072	1-1/4" x 4-7/8" Square Corner + box; 1-3/16" lip length	STANDARD
10-072xx	1-1/4" x 4-7/8" Square Corner + box; specify lip length (xx) as 1" or 1-1/2"	N/C
10-072xx	1-1/4" x 4-7/8" Square Corner + box; specify lip length (xx) as 1-3/4"	\$31.30
10-075 ●	1/2" Rabbeted	\$108.00
37-015	Strike Frame Reinforcer, specify 37-015	N/C
XL11-820 △	One hole for latching functions, RH & LHR doors Lip 1-3/16"	\$13.40
XL11-821 △	One hole for latching functions, LH & RHR doors Lip 1-3/16"	\$13.40

● For 1-3/4" thick doors, use wide armor front. For over 1-3/4" thick door extended equally (EE) use 1-1/4" wide armor front.
△ Extended leadtime, consult customer service.

14. Select Door Thickness

134	1-3/4"	STANDARD
Example 138	1-3/8" to 2-3/4", Shims included (Specify in 1/8" increments)	\$58.90

Accessories available, see pages 200-201.
Accessories include Decorative Plates, Handheld Device, etc.
Credentials available, see pages 26-31.



1-3. Select Exit Trim Type*

CO-250-993R	\$1,588.00
CO-250-993S	\$1,604.00
CO-250-993M	\$1,604.00

* See page 162 for exit device compatibility. [†] Metal door only.



CO-250-993R-70-MS



CO-250-993R-70-MSK

4. Select Function

70	Classroom/Storeroom	STANDARD
----	---------------------	----------

5. Select Reader (Note: CO-Series readers are not interchangeable)

MS	Magnetic Stripe (Swipe)	N/C
MSK	Magnetic Stripe (Swipe) + Keypad	\$66.10

6. Select Lever*

LLL	Less interior and exterior levers	DEDUCT \$69.10
SPA	Sparta	N/C
RHO	Rhodes	N/C
ATH	Athens	N/C
TLR	Tubular	N/C
BRW	Broadway	N/C
BRK	Boardwalk	N/C
LAT	Latitude	N/C
LON	Longitude	N/C

* Tactile Warning use 8AT for Athens, 8RO for Rhodes, 8SP for Sparta and 8TR for Tubular. \$45.60 per lever. Applied to exterior lever only unless otherwise specified. Not available with 643e finish.

7. Select Finish

626	Satin Chrome	N/C
605	Bright Brass	\$139.00
606	Satin Brass	\$139.00
612	Satin Bronze	\$139.00
619	Satin Nickel	\$139.00
625	Bright Chrome	\$139.00
643e	Aged Bronze	\$139.00
626AM	Satin Chrome Antimicrobial	\$179.00

8. Select Cylinder Type

P ●△	With Cylinder, Schlage- (Everest 29 S123, 6 Pin KIL standard)	N/C
L	Less Cylinder, Schlage, Falcon, 6 Pin KIL	DEDUCT \$64.00
R ●□	With Cylinder, Schlage 6-Pin (Everest 29 S123 standard) FSIC	\$38.00
J	Less Cylinder, Schlage, 6 Pin FSIC	DEDUCT \$35.00
G ●□	With Cylinder, Schlage 7-Pin (Everest 29R standard) (factory master keyed only) SFIC	\$84.00
B	Less Cylinder, Schlage, Falcon, Competitive OEM's, 7 Pin (SFIC)	N/C
L SAR	Less Cylinder, Sargent (10L + 11L), 6 Pin KIL	DEDUCT \$64.00
L CO6	Less Cylinder, Corbin 8000, 6 Pin KIL	DEDUCT \$64.00
J SAR	Less Cylinder, Sargent 6300, 6 Pin FSIC	DEDUCT \$35.00
J CO6	Less Cylinder, Corbin 8000, 6 Pin FSIC	DEDUCT \$35.00
J CO7	Less Cylinder, Corbin 8000-7, 7 Pin FSIC, (Only RHO, 8RO, SPA, 8SP, TLR and 8TR)	DEDUCT \$35.00
J MED	Less Cylinder, Medeco 32*0201, 6 Pin FSIC (Only RHO, 8RO, SPA, 8SP lever styles)	DEDUCT \$35.00
J YA6	Less Cylinder, Yale 1210 or Medeco 31*0100, 6 Pin FSIC	DEDUCT \$35.00
J YA7	Less Cylinder, Yale 1220, 7 Pin FSIC (Only RHO, 8RO, SPA, 8SP lever styles)	DEDUCT \$35.00
L FA7	Less Cylinder, Falcon, 7 Pin, KIL (Only RHO, 8RO, SPA, 8SP lever styles)	DEDUCT \$35.00

● Master Keyed cylinders can be specified and will be shipped in lock packaging. For Master Keying System Summary form which should accompany the master keyed order, see page 283.

△ For Master Keying, additional line item 50-210 is required, \$20.10 each.

□ Control Keys for installation/removal of interchangeable cores are not furnished and must be ordered separate.

For additional assistance on Master Keying as well as restricted keyways please contact customer service.

Full Cylinder
PD LD LDSAR LDFA7

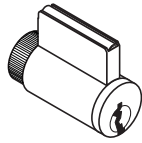

Full Size Interchangeable Core
RD JD JD SAR JD CO6 JD YA6 JD CO7

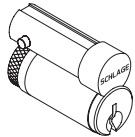

Small Format Interchangeable Core
GD BD

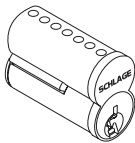

9. Select Keying Type

Open Keyway Families: KIL or FSIC ²		
S123	Everest 29 S (Key in Lever or FSIC)	STANDARD
C123	Everest C	N/C
C/CE/E/EF/ F/ FG/ G	Classic Obverse	N/C
Restricted Keyway Families: KIL or FSIC ^{1,2}		
29 T	Everest 29 T	\$17.50
D	Everest D	\$17.50
Classic Restricted	Quad, Numbered, Reverse	\$17.50
Restricted Keyway Families: SFIC ³		
29 R	Everest 29 R	N/C
B	Everest B	N/C

¹ Everest Restricted Keyways require a Letter of Authorization to be submitted with the order. See sample Letter of Authorization, see page 295.

² Full Size key systems (Everest 29 S & T, Everest C & D, Obverse & Quad) are available in Primus and Primus XP key system and must be ordered separately. Lock should be ordered less cylinder and Primus cylinder should be a separate line.

³ Master Keyed cylinders can be specified and will be shipped in lock packaging. For Master Keying System Summary form which should accompany the master keyed order, see page 283.

10. Select Handing (Field Reversible)

RHR	Right Handed Reverse	N/C
LHR	Left Handed Reverse	N/C

11. Select Battery

4B	4AA Battery Kit	STANDARD
-----------	-----------------	-----------------

12. - 13. No Selection Required

14. Select Door Thickness

134	1-3/4"	STANDARD
Example 138	1-3/8" to 2-3/4", (Specify in 1/8" increments)	\$58.90

CO-Series Exit Trim

The CO-100 Exit Trim comes with a universal mounting plate and is compatible with the following exit devices:

Von Duprin 98/99, 98/99XP

Rim, Concealed Vertical Rod (metal door only), Concealed Vertical Cable (metal door only), Surface Vertical Rod, Mortise.

Von Duprin 22/22F

Rim, Surface Vertical Rod

Falcon 25 - Rim

Sargent 80 Series (Narrow design & reversible rim exits not compatible) - Rim

Corbin Russwin 5000 Series - Rim

Yale 7000 - Rim

Dorma 9300 - Rim

Precision 21 - Rim (2100 converts to 21 with Precision's BP21 kit)

Note: CO-Series Non-Functioning "Dummy" Exit Trim now available. Please see pages 198-199 for details

Accessories available, see pages 200-201.

Accessories include Decorative Plates, Handheld Device, etc.

Credentials available, see pages 26-31.

Pricing/product description subject to change without notice.

1-3. Select Chassis/ Exit Trim Type*

CO-993DT	Dummy Trim with Dummy Reader Cover for Exit Rim/ [†] Concealed Vertical Rod/ [†] Concealed Vertical Cable/ Surface Vertical Rod/Mortise Lock	\$718.00
-----------------	---	-----------------

* See page 162 for exit device compatibility. [†] Metal door only.



CO993DT

4. Select Lever*

LLL	Less interior and exterior levers	DEDUCT \$23.20
SPA	Sparta	N/C
RHO	Rhodes	N/C
ATH	Athens	N/C
TLR	Tubular	N/C
BRW	Broadway	N/C
BRK	Boardwalk	N/C
LAT	Latitude	N/C
LON	Longitude	N/C

* Tactile Warning use 8AT for Athens, 8RO for Rhodes, 8SP for Sparta and 8TR for Tubular. \$45.60 per lever. Applied to exterior lever only unless otherwise specified. Not available with 643e finish.

5. Select Finish

626	Satin Chrome	N/C
605	Bright Brass	\$139.00
606	Satin Brass	\$139.00
612	Satin Bronze	\$139.00
619	Satin Nickel	\$139.00
625	Bright Chrome	\$139.00
643e	Aged Bronze	\$139.00
626AM	Satin Chrome Antimicrobial	\$179.00

6. Select Cylinder Type

P ● △	With Cylinder, Schlage- (Everest 29 S123, 6 Pin KIL standard)	N/C
L	Less Cylinder, Schlage, Falcon, 6 Pin KIL	DEDUCT \$64.00
R ● □	With Cylinder, Schlage 6-Pin (Everest 29 S123 standard) FSIC	\$38.00
J	Less Cylinder, Schlage, 6 Pin FSIC	DEDUCT \$35.00
G ● □	With Cylinder, Schlage 7-Pin (Everest 29R standard) (factory master keyed only) SFIC	\$84.00
B	Less Cylinder, Schlage, Falcon, Competitive OEM's, 7 Pin (SFIC)	N/C
L SAR	Less Cylinder, Sargent (10L + 11L), 6 Pin KIL	DEDUCT \$64.00
L CO6	Less Cylinder, Corbin 8000, 6 Pin KIL	DEDUCT \$64.00
J SAR	Less Cylinder, Sargent 6300, 6 Pin FSIC	DEDUCT \$35.00
J CO6	Less Cylinder, Corbin 8000, 6 Pin FSIC	DEDUCT \$35.00
J CO7	Less Cylinder, Corbin 8000-7, 7 Pin FSIC, (Only RHO, 8RO, SPA, 8SP, TLR and 8TR)	DEDUCT \$35.00
J MED	Less Cylinder, Medeco 32*0201, 6 Pin FSIC (Only RHO, 8RO, SPA, 8SP lever styles)	DEDUCT \$35.00
J YA6	Less Cylinder, Yale 1210 or Medeco 31*0100, 6 Pin FSIC	DEDUCT \$35.00
J YA7	Less Cylinder, Yale 1220, 7 Pin FSIC (Only RHO, 8RO, SPA, 8SP lever styles)	DEDUCT \$35.00
L FA7	Less Cylinder, Falcon, 7 Pin, KIL (Only RHO, 8RO, SPA, 8SP lever styles)	DEDUCT \$35.00

● Master Keyed cylinders can be specified and will be shipped in lock packaging. For Master Keying System Summary form which should accompany the master keyed order, see page 283.

△ For Master Keying, additional line item 50-210 is required, \$20.10 each.

□ Control Keys for installation/removal of interchangeable cores are not furnished and must be ordered separate.

For additional assistance on Master Keying as well as restricted keyways please contact customer service.

Full Cylinder
PD LD LDSAR LDFA7

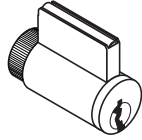

Full Size
Interchangeable Core
RD JD JD SAR JD CO6 JD YA6
JD C07

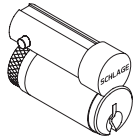

Small Format
Interchangeable Core
GD BD

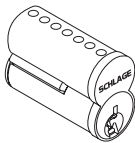

7. Select Keying Type

Open Keyway Families: KIL or FSIC ²		
S123	Everest 29 S (Key in Lever or FSIC)	STANDARD
C123	Everest C	N/C
C/CE/E/EF/ F/ FG/ G	Classic Obverse	N/C
Restricted Keyway Families: KIL or FSIC ^{1,2}		
29 T	Everest 29 T	\$17.50
D	Everest D	\$17.50
Classic Restricted	Quad, Numbered, Reverse	\$17.50
Restricted Keyway Families: SFIC ³		
29 R	Everest 29 R	N/C
B	Everest B	N/C

¹ Everest Restricted Keyways require a Letter of Authorization to be submitted with the order. See sample Letter of Authorization, see page 295.
² Full Size key systems (Everest 29 S & T, Everest C & D, Obverse & Quad) are available in Primus and Primus XP key system and must be ordered separately. Lock should be ordered less cylinder and Primus cylinder should be a separate line.
³ Master Keyed cylinders can be specified and will be shipped in lock packaging. For Master Keying System Summary form which should accompany the master keyed order, see page 283.

8. Select Handing (Field Reversible)

RHR	Right Handed Reverse	N/C
LHR	Left Handed Reverse	N/C

9. - 10. No Selection Required

11. Select Door Thickness

134	1-3/4"	STANDARD
Example 138	1-3/8" to 2-3/4", (Specify in 1/8" increments)	\$58.90

CO-Series Exit Trim
 The CO-100 Exit Trim comes with a universal mounting plate and is compatible with the following exit devices:

Von Duprin 98/99, 98/99XP
 Rim, Concealed Vertical Rod (metal door only), Concealed Vertical Cable (metal door only), Surface Vertical Rod, Mortise.

Von Duprin 22/22F
 Rim, Surface Vertical Rod

Falcon 25 - Rim

Sargent 80 Series (Narrow design & reversible rim exits not compatible) - Rim

Corbin Russwin 5000 Series - Rim

Yale 7000 - Rim

Dorma 9300 - Rim

Precision 21 - Rim (2100 converts to 21 with Precision's BP21 kit)

Accessories available, see pages 200-201.
 Accessories include Decorative Plates, Handheld Device, etc.
 Credentials available, see pages 26-31.

CO-Series Accessories



Product ID	Product Description	Product Specification	Price
Handheld Device			
HHD KIT-USB	Handheld Device Kit	Includes Handheld Device pre-loaded with SUS Application, and HHD-USB Cable. Used to initialize, manage, and test AD and CO Series devices	\$1,332.00
HH-USB	USB Replacement Cable	Used to connect Handheld Device to USB locks and accessories.	\$60.30
Handheld Device Accessories (Legacy Product Support)			
HH-2PIN SERIAL	Serial Cable	Used to connect current model HHD (BM170) directly to legacy serial products without the need of a CIP	\$148.00
HH-SERIAL	Serial Cable*	Used to connect previous model HHD (BM150) with CIP to program serial products.	\$133.00
PIMWA-CV	Null Converter	Used to connect Handheld Device to WA Series PIM, using HH-SERIAL Serial Cable. (compatible to current and previous model HHDs)	\$26.70
P512112	Computer Interface Module (CIP)*	Used to program serial products using HH-SERIAL Serial Cable.	\$341.00
P101203	CIP with iButton Reader*	Used to program serial products using HH-SERIAL Serial Cable.	\$361.00

* Not compatible to current HHD (BM170)

Reader Module Accessories

510310	Magnetic Stripe Cleaning Cards	See page 220
---------------	--------------------------------	---------------------

Battery Holder & Cover Kit - (Select by Chassis Type) - (Please specify FINISH - Example: 4B-CM-626)

Cylindrical		
4B-CM (23599202)	Battery Holder Kit (Includes 4AA Battery Holder with Cable, 4AA Battery Strap, (2) Battery Strap Screws, 4AA Battery Cover, Cover Screw, Torx Cover Screw)	See page 231
Mortise		
4B-CM (23599202)	Battery Holder Kit (Includes 4AA Battery Holder with Cable, 4AA Battery Strap, (2) Battery Strap Screws, 4AA Battery Cover, Cover Screw, Torx Cover Screw)	See page 231
Exit		
4B-E (23599285)	Battery Holder Kit (Includes 4AA Battery Holder with Cable, 4AA Battery Strap, (2) Battery Strap Screws, 4AA Battery Cover, Cover Screw, Torx Cover Screw)	See page 231

Decorative Plate - (Select by Size) - (Please specify FINISH - Example: 23760283-626)

23631823	1.5" x 3.25" x .105" Decorative Plate (with Screws) - (Exit Trim)	See page 230
23760267	1.7" x 3.5" x .075" Decorative Plate (with Screws)	See page 230
23760283	3.2" x 3.5" x .075" Decorative Plate (with Screws)	See page 230
23760317	6.0" x 3.5" x .075" Decorative Plate (with Screws)	See page 230
23760325	6.6" x 3.5" x .075" Decorative Plate (with Screws)	See page 230
23760309	8.0" x 3.5" x .075" Decorative Plate (with Screws)	See page 230
23760291	8.0" x 3.5" x .075" Decorative Plate (with Screws and Welded Standoff)	See page 230
23760259*	10.5" x 3.5" x .075" Decorative Plate (no Screws necessary) - (Under Lock)	See page 230
23760275*	12.0" x 3.5" x .075" Decorative Plate (no Screws necessary) - (Under Lock)	See page 230

*Please consider overall Door Thickness when ordering

Note: Single Decorative Plate. Interior and Exterior Decorative Plates may be required.

Note: Decorative Plates may have multiple applications. Please refer to AD-Series Retrofit Template Overlay guide at www.schlage.com/support for more information

Available Finishes: 626 Satin Chrome Standard. Please consult Customer Care for 605 Bright Brass or 643E Aged Bronze.

Shim Plates

23599368	Interior Shim Plate	See page 231
23458599	Exterior Shim Plate	See page 231

Note: Device is 0.063" thick

Wood Mounts

23740277	CO-Series Cylindrical Mount	\$207.00
23740285	CO-Series Mortise Mount	\$240.00
23740269	AD-Series & CO Series Exit Trim Mount	\$328.00

Pricing/product description subject to change without notice.

Product ID	Product Description	Price
Installation Tools		
40-286	Universal Clamp	\$497.00
40-289	CO Series mortise lock installation template	\$1,037.00
40-291	Universal mortise door position switch (DPS) installation template	\$149.00
40-290	CO Series cylindrical lock installation template	\$1,037.00
40-292	Universal cylindrical door position switch (DPS) installation template	\$149.00

Note: The universal clamp above is necessary when using the remaining products to ensure hole placement accuracy. The "Universal" (Clamp & DPS) products are for use in all CO, AD and LE product installations.

CO-200 Standalone Accessories

Express Level Software Package

SXPR-SFT-1	Express Offline Lock Software	Recommended for offline locks of fewer than 1000 users and/or 100 access points. Reporting of last 1000 events capability will retrieve audit trails. Must be installed on a computer that meets the minimum requirements (refer to software datasheet)	\$479.00
-------------------	-------------------------------	---	-----------------

Note: Refer to Software Levels Datasheet for features and details

Express Level Software Package Accessories

P512112	Express Computer Interface Module	Used to program legacy CM/CL/KC products, using HH-SERIAL Serial Cable	\$331.00
P101203	Express Computer Interface Module (with iButton)	Used to connect PC/laptop to access device	\$350.00
P394548	Express Female to Female Serial Cable	Used to connect P101203 Computer Interface Module to PC/laptop	\$64.90
SDB9USBCBL	Express Male DB9 to USB 6" Cable Adapter	Used to connect a USB Port device to a Serial Port device	\$104.00
CRM2	Express Magnetic Stripe Enrollment Reader		\$709.00
CRP2	Express Proximity Enrollment Reader		\$572.00

Express Installation & Training

SCH-EXP-INST	Express Installation & Training	Includes software installation and training. Provided by Allegion Security & Safety Consultant remotely from factory. (No discounts apply)	\$428.00
---------------------	---------------------------------	--	-----------------

CO-220 Classroom Lockdown Accessories

24744856	Remote lockdown fob	Can be paired with up to ten locks	\$141.00
-----------------	---------------------	------------------------------------	-----------------

CO-250 Standalone Accessories

CL-ENCODER-2	Campus Lock Magnetic Stripe Encoder	ISO compatible high/low coercivity with female/male serial cable.	\$4,437.00
---------------------	-------------------------------------	---	-------------------

CT5000

The CT5000 is an indoor, offline single opening controller. It is flexible and works with various card reader technologies. With the correct power supply, the CT5000 controller works with various types of locking hardware, including electric strikes, electro-magnetic locks, or EL exit devices.

If networked functionality is required in the future, the CT5000 can be upgraded to a WRI-400 by upgrading the firmware and adding one incremental piece of hardware. This provides greater adaptability in the field.

Perimeter Door Application

The CT5000 can be used for perimeter door applications with an automatic operator, electric strike and card reader

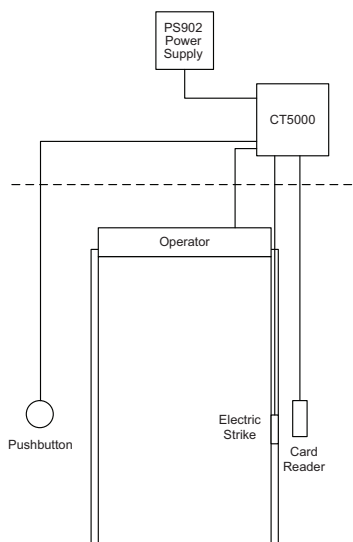

Narrow Stile Application

For narrow stile applications the CT5000 can be used with an electric strike and card reader

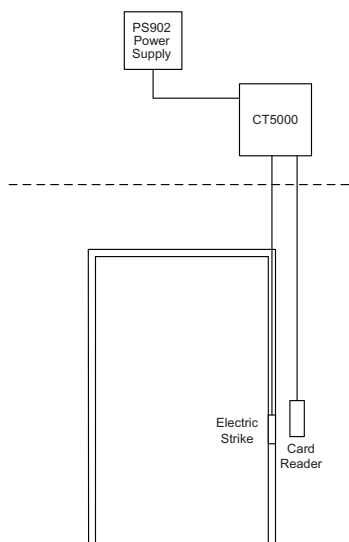

Panic Device Application

The CT5000 and a card reader along with the Von Duprin 914 Power Supply can control two EL exit devices for double door applications

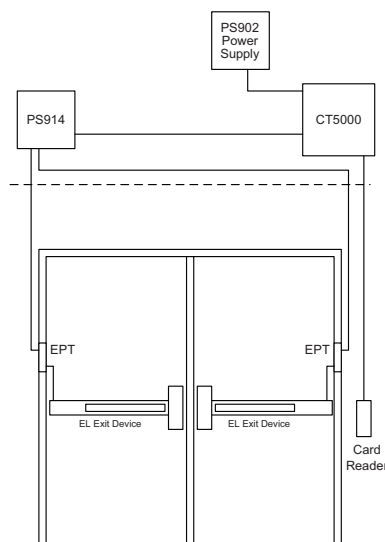

Note: All hardware shown above including exit devices, electric strikes, auto operators, power supplies, push buttons, etc. are sold separately.

Certifications

- UL 294
- Canada UL
- FCC Part 15
- Canada RSS – 210
- RoHS

Features

- Supports up to 5000 users and audits
- Comes standard with 15 foot USB remote cable connector
- Programmed using Schlage Handheld Device (HHD) via USB connection
- Power is hardwired
- Three form C relay outputs (for strike, auxiliary, and alarm)
- Supports Request to exit (remote release) and Door Position Switch input.
- Card functions supported: normal, toggle, freeze, pass through, construction, lock down, and all card plus PIN applications
- Multiple reader technologies and positions on both sides of the gate/ door
- Internal LED visual indicators (Including low battery and state of the relay)
- Compatible with Schlage Express

Credential Compatibility

- Magnetic stripe: field configurable track 1, 2, or 3
- Compatible with Schlage, Xceed ID™, AWID®, HID®, GE/CASI ProxLite®
- 125 kHz Proximity cards: 26a, 34x, 35x, 37x bit formats (reader dependant)
- 13.56 MHz Smart card: 26a, 34x, 35x, 37x, 40x, 48x bit format (reader dependant)
- Can read card serial number of Mifare DESfire (reader dependant)

The following readers are UL294 listed for use with the CT5000:

- Essex Electronics model KTP-162
- Mercury Security models MR-5 and MR-20
- XceedID models PR10, MT11, MT15, MTK15, SM10

CT5000	Offline Controller (15 ft. USB cable standard)	\$1,050.00
PS-902	2 amp Power Supply (Required)	See page 248
HHD-Kit	Schlage Handheld Programming Device (Required)	See page 200
23745565	125 ft. USB cable for CT5000 (Optional)	\$142.00

AD-SERIES PARTS - TABLE OF CONTENTS	
READER MODULE SCREWS	206
INTERIOR ESCUTCHEON	206
EXTERIOR ESCUTCHEON	206
EXTERIOR GASKET KIT	206
BASE PLATE SUB ASSEMBLY	207
MOUNTING HARDWARE	207
EXTERIOR SPRING CAGE	208
TAILPIECE	209
CYLINDER	211
LEVER	211
LOCK RETRACTOR	214
STRIKE PLATE	214
DOOR THICKNESS KIT	215
MISCELLANEOUS	216

CONTACT INFORMATION FOR AD-SERIES PARTS

Payment Address: Schlage Electronic Security
 15934 Collections Center Drive
 Chicago, IL 60693

877-671-7011	
Customer Service:	Technical Support:
Order Status, Credit Returns of Non-Defective Products, General Sales Questions	Technical Questions/Issues, Returns of Defective Products, Repairs
Email Orders To: Order_Entry_Schlage_Commercial@allegion.com	Contact For Technical Assistance: Electronic_Lock_TechProdSupport@allegion.com

For AD-Series Parts Warranty Information please see page 13.

Pricing/product description subject to change without notice.

Reader Module - (Please specify FINISH - Example: KP-626)

New Part Number	Original Part Number	Description	List Price
	KP	Keypad Only Reader Module	See page 156
	MG	Magnetic Stripe (Insert) Reader Module - (Track 1, 2, or 3)	See page 156
	MGK	Magnetic Stripe (Insert) with Keypad Reader Module - (Track 1, 2, or 3)	See page 156
	MS	Magnetic Stripe (Swipe) Reader Module - (Track 1, 2, or 3)	See page 156
	MSK	Magnetic Stripe (Swipe) with Keypad Reader Module - (Track 1, 2, or 3)	See page 156
	MT	Multi-Technology Reader Module - (125 kHz Proximity and 13.56 MHz Smart)	See page 156
	MTK	Multi-Technology with Keypad Reader Module - (125 kHz Proximity and 13.56 MHz Smart)	See page 156
	SI	Smart Technology iClass Compatible Reader	See page 156
	SIK	Smart Technology iClass Compatible Reader + Keypad	See page 156
	FMK	FIPS Multi-Technology with Keypad Reader Module - (125 kHz Proximity and 13.56 MHz Smart)	See page 156
	DT	Dummy Trim Reader Cover	See page 156

Reader Module Screws - (Please specify DOOR THICKNESS - Example: 46928511-138 for 1-3/8")

46928511	Screws, Reader Module Assembly - (1-3/8", 1-1/2", 1-5/8", 1-3/4", 1-7/8", 2", 2-1/8", 2-1/4", 2-3/8", 2-1/2", 2-5/8", and 2-3/4")	\$10.00
----------	---	---------

Magnetic Swipe Cleaning Cards

510310	Magnetic Stripe Cleaning Cards	\$38.50
--------	--------------------------------	---------

Interior Escutcheon - (Select by Chassis Type) - (Please specify FINISH - Example: 46929014-626)

Cylindrical		
46929014	Interior Escutcheon (with Baseplate Screws)	\$74.60
Mortise		
46929014	Interior Escutcheon (with Baseplate Screws)	\$74.60
Mortise Deadbolt		
46929022	Interior Escutcheon (with Baseplate Screws)	\$74.60
Exit		
46929279	Interior Escutcheon (with Baseplate Screws)	\$58.10

Interior Baseplate Gasket

46928982	Interior Baseplate Gasket	\$33.40
----------	---------------------------	---------

USB Cover Plug, 10-Piece Bulk Pack

46928719	46928719	USB Cover Plug (10-Piece Bulk Pack)	\$24.90
47258550	New	USB Cover Plug, Exit (10-Piece Bulk Pack)	\$24.90
47253409	New	Cable, USB, AD/CO, Exit	\$21.90

Exterior Escutcheon - (Select by Chassis Type) - (Please specify FINISH - Example: 46928743-626)

Cylindrical			
46928743	46928743	Exterior Escutcheon (with Baseplate Screws)	\$123.00
Mortise			
46928743	46928750 46928743	Exterior Escutcheon (with Baseplate Screws)	\$123.00
Exit			
47258398	46928750 46928743	Exterior Escutcheon (with Baseplate Screws)	\$123.00

Exterior Escutcheon, 10-Piece Bulk Pack - (Select by Chassis Type) - (Please specify FINISH - Example: 23608532-626)

Cylindrical			
23608532	23608532	Exterior Escutcheon (with Baseplate Screws)	\$626.00
Mortise			
23608532	23608540 23608532	Exterior Escutcheon (with Baseplate Screws)	\$626.00
Exit			
47260731	23608540 23608532	Exterior Escutcheon (with Baseplate Screws)	\$626.00

Exterior Gasket Kit - (Select by Chassis Type)

Cylindrical			
47260740	46929154	Exterior Gasket Kit (Includes Exterior Baseplate Gasket, Spindle Cover Seal, Reader O-Ring)	\$50.00
Mortise			
47260740	46929162	Exterior Gasket Kit (Includes Exterior Baseplate Gasket, Spindle Cover Seal, Reader O-Ring)	\$50.00
Exit			
47260741	46929162	Exterior Gasket Kit (Includes Exterior Baseplate Gasket, Spindle Cover Seal, Reader O-Ring)	\$50.00

Pricing/product description subject to change without notice.

New Part Number	Original Part Number	Description	List Price
Interior Baseplate Sub-Assembly - (Select by Chassis Type) - (Please specify CLASS - Example: 46928990-200)			
Cylindrical			
47261347	46928990	Interior Baseplate Sub-Assembly - (Less Lever, Less Escutcheon, Less Spring Cage)	\$912.00
Mortise			
47261347	46928990	Interior Baseplate Sub-Assembly - (Less Lever, Less Escutcheon, Less Spring Cage)	\$912.00
Exit			
46929253	46929253	Interior Baseplate Sub-Assembly - (Less Escutcheon, Less Battery Cover, Less Communication Module Cover)	\$662.00
Exterior Baseplate Sub-Assembly - (Select by Chassis Type) - (Please specify CYLINDER DETAIL - Example: 46928529-LD)			
Cylindrical			
47260732	46928529	Exterior Baseplate Sub-Assembly - (Less Lever, Less Cylinder, Less Escutcheon)	\$770.00
Mortise			
47260738	46928537	Exterior Baseplate Sub-Assembly - (Less Lever, Less Cylinder, Less Escutcheon)	\$806.00
Exit			
47260739	46928545	Exterior Baseplate Sub-Assembly - (Less Lever, Less Cylinder, Less Escutcheon)	\$770.00
Interior Baseplate Spacer for SVR			
Exit			
	46929238	Interior Baseplate Spacer for SVR (with Baseplate Mounting Screws, Surface Mount Screws)	\$46.40
Interior Wireless Cover Spacer for SVR			
Exit			
	46929246	Interior Wireless Cover Spacer for SVR (with Surface Mount Screw)	\$33.40
Interior Mounting Plate			
	46929030	Interior Mounting Plate (with Screws)	\$50.00
Exit Device Mounting Plate - (Please specify FINISH - Example: 46929220-626)			
Exit			
Obsolete	46929220	Exit Device Mounting Plate (with (2) Baseplate Mounting Screws)	\$74.60
Exit Device Mounting Hardware Kit -			
(Please specify Device Type (993R, 993S or 993M), DOOR THICKNESS, FINISH - Example: 46929287-993M-626-134)			
Exit			
47260744	46929287	Exit Device Mounting Hardware Kit (Upper Mounting Bolts, Lower Mounting Sex-Bolts, Reader Mounting Bolts, Finish Washers, Screws)	\$83.20
Interior Spring Cage			
47260743	46929006	Interior Spring Cage (with Screws)	\$56.10

Pricing/product description subject to change without notice.

Exterior Spring Cage (with Screws) - (Select by Chassis Type, Cylinder OEM, Cylinder Type, Cylinder Detail)

Cylindrical			
New Part Number	Original Part Number	Description	List Price
47258543	46928552	Schlage, KIL, PD/LD	\$69.80
	46928552	Schlage, FSIC, RD/JD	
	46928560	Schlage, SFIC, GD/BD	
	23845969	Falcon, KIL, LD FA7 (7-PIN)	
	46928586	Corbin Russwin, FSIC, JD CO6 (6-PIN)	
	23990674	Corbin Russwin, FSIC, JD CO7 (7-PIN)	
	46928578	Sargent, KIL, LD SAR (6-PIN)	
	46928586	Sargent, FSIC, JD SAR (6-PIN)	
47258544	24281735	Medeco, FSIC, JD MED (6-PIN)	\$333.00
	46928644	Yale, FSIC, JD YA6 (6-PIN)	
	24281768	Yale, FSIC, JD YA7 (7-PIN)	
Mortise			
47258543	46928602	Schlage, KIL, PD/LD	\$69.80
	46928610	Schlage, FSIC, RD/JD	
	46928560	Schlage, SFIC, GD/BD	
	23845977	Falcon, KIL, LD FA7 (7-PIN)	
	46928636	Corbin Russwin, FSIC, JD CO6 (6-PIN)	
	23988033	Corbin Russwin, FSIC, JD CO7 (7-PIN)	
	46928628	Sargent, KIL, LD SAR (6-PIN)	
	46928636	Sargent, FSIC, JD SAR (6-PIN)	
47258544	24281735	Medeco, FSIC, JD MED (6-PIN)	\$333.00
	46928644	Yale, FSIC, JD YA6 (6-PIN)	
	24281768	Yale, FSIC, JD YA7 (7-PIN)	
Exit			
47258545	46928651	Schlage, KIL, PD/LD (Steel Levers)	\$170.00
	46928553	Schlage, FSIC, RD/JD (Steel Levers)	
	46928669	Schlage, SFIC, GD/BD (Zinc Levers)	
	23779838	Falcon, KIL, LD FA7 (7-PIN) (Steel Levers) - (Except ATH, 8AT Lever Style)	
	46928693	Corbin Russwin, FSIC, JD CO6 (6-PIN) (Steel Levers)	
	23988017	Corbin Russwin, FSIC, JD CO7 (7-PIN) (Steel Levers) - (Except ATH, 8AT Lever Style)	
	46928677	Sargent, KIL, LD SAR (6-PIN) (Steel Levers)	
	46928685	Sargent, FSIC, JD SAR (6-PIN) (Steel Levers)	
47258546	24289902	Medeco, FSIC, JD MED (6-PIN)	\$335.00
	46928701	Yale, FSIC, JD YA6 (6-PIN) (Steel Levers)	
	24289928	Yale, FSIC, JD YA7 (7-PIN)	

Exterior Spring Cage & Tailpiece Kit (for Schlage), 10-Piece Bulk Pack - (Select by Chassis, Cylinder OEM, Cylinder Type, Cylinder Detail)

Cylindrical			
47259238	23593270	Schlage, KIL, PD/LD	\$691.00
47259239	23593288	Schlage, FSIC, RD/JD	\$729.00
47259240	23593304	Schlage, SFIC, GD/BD	\$1,132.00
Mortise			
47259238	23593346	Schlage, KIL, PD/LD	\$1,538.00
47259239	23593353	Schlage, FSIC, RD/JD	\$2,297.00
47259240	23593304	Schlage, SFIC, GD/BD	\$1,132.00
Exit			
47259249	23593271	Schlage, KIL, PD/LD	\$1,538.00
47259250	23593272	Schlage, FSIC, RD/JD	\$2,297.00
47259248	23593437	Schlage, SFIC, GD/BD	\$1,233.00
	23593510		

Pricing/product description subject to change without notice.

**Exterior Spring Cage & Tailpiece Kit (for Non-Schlage), Single Piece -
(Select by Chassis Type, Cylinder OEM, Cylinder Type, Cylinder Detail)**

Cylindrical			
New Part Number	Original Part Number	Description	List Price
47259244	23845985	Falcon, KIL, LD FA7 (7-PIN)	\$83.40
47259242	23593320	Corbin Russwin, FSIC, JD CO6 (6-PIN)	\$362.00
	23990666	Corbin Russwin, FSIC, JD CO7 (7-PIN)	
47259241	23593312	Sargent, KIL, LD SAR (6-PIN)	\$338.00
47259242	23593320	Sargent, FSIC, JD SAR (6-PIN)	\$362.00
47259245	24281792	Medeco, FSIC, JD MED (6-PIN)	\$381.00
47259243	23593395	Yale, FSIC, JD YA6 (6-PIN)	\$381.00
47259246	24281826	Yale, FSIC, JD YA7 (7-PIN)	\$333.00
Mortise			
47259244	23845923	Falcon, KIL, LD FA7 (7-PIN)	\$83.40
47259242	23593387	Corbin Russwin, FSIC, JD CO6 (6-PIN)	\$362.00
	23988041	Corbin Russwin, FSIC, JD CO7 (7-PIN)	
47259241	23593379	Sargent, KIL, LD SAR (6-PIN)	\$338.00
47259242	23593387	Sargent, FSIC, JD SAR (6-PIN)	\$362.00
47259245	24281792	Medeco, FSIC, JD MED (6-PIN)	\$381.00
47259243	23593395	Yale, FSIC, JD YA6 (6-PIN)	\$381.00
47259246	24281826	Yale, FSIC, JD YA7 (7-PIN)	\$333.00
Exit			
47259254	23810872	Falcon, KIL, LD FA7 (7-PIN)	\$88.10
47259252	23593274	Corbin Russwin, FSIC, JD CO6 (6-PIN)	\$362.00
	23988025	Corbin Russwin, FSIC, JD CO7 (7-PIN) - (Except ATH, BAT Lever Styles)	
47259251	23593273	Sargent, KIL, LD SAR (6-PIN)	\$338.00
47259252	23593274	Sargent, FSIC, JD SAR (6-PIN)	\$362.00
47259255	24289936	Medeco, FSIC, JD MED (6-PIN)	\$368.00
47259253	23593275	Yale, FSIC, JD YA6 (6-PIN)	\$368.00
47259257	24289944	Yale, FSIC, JD YA7 (7-PIN)	\$315.00

Tailpiece (For Cylinder) - (Select by Chassis Type, Cylinder OEM, Cylinder Type, Cylinder Detail)

Cylindrical			
New Part Number	Original Part Number	Description	List Price
47258186	C604-243	Schlage, KIL, PD/LD - (Everest/Primus/Modular Cylinders)	\$1.90*
	C603-524	Schlage, KIL, PD/LD - (Classic Cylinders)	
23446339	23446339	Schlage, FSIC, JD/RD/TD	\$5.50
47258182	23779820	Falcon, KIL, LD FA7 (7-PIN)	\$24.10
47258187	46929456	Universal, SFIC, BD/BDC	\$15.60
47258180	23433634	Corbin Russwin, FSIC, JD CO6 (6-PIN)	\$37.10
	23854516	Corbin Russwin, FSIC, JD CO7 (7-PIN)	
47258179	23433626	Sargent, KIL, LD SAR (6-PIN) - (Compatible with 10L and 11L)	\$5.70
47258180	23433634	Sargent, FSIC, JD SAR (6-PIN)	\$37.10
47258183	23810898	Medeco, FSIC, JD MED (6-PIN)	\$86.70
47258181	23760366	Yale, FSIC, JD YA6 (6-PIN) - (Compatible with Medeco 31)	\$47.40
47258184	23929722	Yale, FSIC, JD YA7 (7-PIN)	\$32.00
23446347	23446347	Universal, SFIC, GD/HD	\$13.70
47258185	new	Corbin Russwin, KIL LD CO6	\$14.60
Mortise			
47258186	23538077	Schlage, KIL, PD/LD - (Everest/Primus/Modular Cylinders)	\$1.90*
	23538085	Schlage, KIL, PD/LD - (Classic Cylinders)	
23446339	23446339	Schlage, FSIC, JD/RD/TD	\$5.50
47258182	23779820	Falcon, KIL, LD FA7 (7-PIN)	\$24.10
47258187	46929456	Universal, SFIC, BD/BDC	\$15.60
47258180	23443435	Corbin Russwin, FSIC, JD CO6 (6-PIN)	\$37.10
	23854516	Corbin Russwin, FSIC, JD CO7 (7-PIN)	
47258179	23443427	Sargent, KIL, LD SAR (6-PIN) - (Compatible with 10L and 11L)	\$5.70
47258180	23443435	Sargent, FSIC, JD SAR (6-PIN)	\$37.10
47258183	23810898	Medeco, FSIC, JD MED (6-PIN)	\$86.70
47258181	23760366	Yale, FSIC, JD YA6 (6-PIN) - (Compatible with Medeco 31)	\$47.40
47258184	23929722	Yale, FSIC, JD YA7 (7-PIN)	\$32.00
23446347	23446347	Universal, SFIC, GD/HD	\$13.70
47258185	new	Corbin Russwin, KIL LD CO6	\$14.60

*This part is shared with Schlage mechanical and defaults to the Schlage mechanical discount.

Pricing/product description subject to change without notice.

Tailpiece (for cylinder) - (Select by Chassis Type, Cylinder OEM, Cylinder Type, Cylinder Detail) (continued)

Exit			
New Part Number	Original Part Number	Description	List Price
47258186	23538077	Schlage, KIL, PD/LD - (Everest/Primus/Modular Cylinders)	\$1.90*
	23538085	Schlage, KIL, PD/LD - (Classic Cylinders)	
23446339	23446339	Schlage, FSIC, JD/RD/TD	\$5.50
47258182	23779820	Falcon, KIL, LD FA7 (7-PIN)	\$24.10
47258187	46929456	Universal, SFIC, BD/ BDC	\$15.60
23446347	N523-091	Universal, SFIC, GD/HD	\$13.70
47258180	23443435	Corbin Russwin, FSIC, JD CO6 (6-PIN)	\$37.10
	23854516	Corbin Russwin, FSIC, JD CO7 (7-PIN)	
47258179	23443427	Sargent, KIL, LD SAR (6-PIN)	\$5.70
47258180	23443435	Sargent, FSIC, JD SAR (6-PIN)	\$37.10
47258183	23810898	Medeco, FSIC, JD MED (6-PIN)	\$86.70
47258181	23760366	Yale, FSIC, JD YA6 (6-PIN) - (Compatible with Medeco 31)	\$47.40
47258184	23929722	Yale, FSIC, JD YA7 (7-PIN)	\$32.00
23446347	23446347	Universal, SFIC, GD/HD	\$15.60
47258187	09-774	Universal, SFIC, BD/BDC	\$15.60
47258185	new	Corbin Russwin, KIL LD CO6	\$14.60

Tailpiece Kit- (for Exterior Escutcheon into Exit Device)

Exit Trim			
	46929303	Tailpiece Kit (Includes Tailpiece, Tailpiece Guide, Pine Tree Clip)	\$19.90

Tailpiece Kit, 10-Piece Bulk Pack - (Select by Chassis Type, Cylinder OEM, Cylinder Type, Cylinder Detail)

Cylindrical			
09-418	09-418	Schlage, KIL, PD/LD - (Classic Cylinders)	\$13.40
09-417	09-417	Schlage, KIL, PD/LD - (Everest/Primus/Modular Cylinders)	\$13.40
23790611	23790611	Falcon, KIL, PD/LD	\$22.60
Mortise			
09-418	46928768	Schlage, KIL, PD/LD - (Classic Cylinders)	\$13.40
09-417	46928776	Schlage, KIL, PD/LD - (Everest/Primus/Modular Cylinders)	\$13.40
23790611	new	Falcon, KIL, PD/LD	\$22.60
Exit			
09-418	46928768	Schlage, KIL, PD/LD - (Classic Cylinders)	\$13.40
09-417	46928776	Schlage, KIL, PD/LD - (Everest/Primus/Modular Cylinders)	\$13.40
23790611	new	Falcon, KIL, PD/LD	\$22.60

Cylinder - (Select by Chassis Type, Cylinder Mechanism, Cylinder Type, Cylinder Detail)

Cylindrical			
	23-013	Classic, KIL, PD - (Only ATH, 8AT Lever Styles)	\$64.00*
	23-030	Classic, FSIC, RD (Open)	\$73.00
	23-030	Classic, FSIC, RD (Restricted)	\$90.50
	20-750	Primus, KIL, PD - (Only ATH, 8AT Lever Styles)	\$141.00
	20-740	Primus, FSIC, RD	\$152.00
	20-550	Primus UL, KIL, PD - (Only ATH, 8AT Lever Styles)	\$174.00
	20-750-XP	Primus XP, KIL, PD - (Only ATH, 8AT Lever Styles)	\$141.00
	20-740-XP	Primus XP, FSIC, RD	\$152.00
	20-550-XP	Primus UL XP, KIL, PD - (Only ATH, 8AT Lever Styles)	\$174.00
Mortise			
	23-118	Classic, KIL, PD - (Except ATH, 8AT Lever Styles) (Open)	\$64.00*
	23-118	Classic, KIL, PD - (Except ATH, 8AT Lever Styles) (Restricted)	\$81.50
	23-030	Classic, FSIC, RD (Open)	\$73.00
	20-854	Primus, KIL, PD - (Except ATH, 8AT Lever Styles)	\$141.00
	20-740	Primus, FSIC, RD	\$152.00
	20-554	Primus UL, KIL, PD - (Except ATH, 8AT Lever Styles)	\$174.00
	20-854-XP	Primus XP, KIL, PD - (Except ATH, 8AT Lever Styles)	\$141.00
	20-740-XP	Primus XP, FSIC, RD	\$142.00
	20-554-XP	Primus UL XP, KIL, PD - (Except ATH, 8AT Lever Styles)	\$174.00

*This part is shared with Schlage mechanical and defaults to the Schlage mechanical discount.

Cylinder - (Select by Chassis Type, Cylinder Mechanism, Cylinder Type, Cylinder Detail) (continued)

Exit			
New Part Number	Original Part Number	Description	List Price
	23-118	Classic, KIL, PD - (Except ATH, 8AT Lever Styles) (Open)	\$64.00*
	23-118	Classic, KIL, PD - (Except ATH, 8AT Lever Styles) (Restricted)	\$81.50
	23-013	Classic, KIL, PD - (Only ATH, 8AT Lever Styles)	\$64.00*
	23-030	Classic, FSIC, RD (Open)	\$73.00
	23-030	Classic, FSIC, RD (Restricted)	\$90.50
	20-854	Primus, KIL, PD - (Except ATH, 8AT Lever Styles)	\$141.00
	20-750	Primus, KIL, PD - (Only ATH, 8AT Lever Styles)	\$141.00
	20-740	Primus, FSIC, RD	\$152.00
	20-554	Primus UL, KIL, PD - (Except ATH, 8AT Lever Styles)	\$174.00
	20-550	Primus UL, KIL, PD - (Only ATH, 8AT Lever Styles)	\$174.00
	20-854-XP	Primus XP, KIL, PD - (Except ATH, 8AT Lever Styles)	\$141.00
	20-750-XP	Primus XP, KIL, PD - (Only ATH, 8AT Lever Styles)	\$141.00
	20-740-XP	Primus XP, FSIC, RD	\$152.00
	20-554-XP	Primus UL XP, KIL, PD - (Except ATH, 8AT Lever Styles)	\$174.00
	20-550-XP	Primus UL XP, KIL, PD - (Only ATH, 8AT Lever Styles)	\$174.00

Interior Lever (Closed) - (Please specify STYLE and FINISH - Example: 03-030-SPA-626)

03-230	03-030	Inside Lever, Closed - ATH, RHO, SPA, TLR	\$136.00
---------------	---------------	---	-----------------

Exterior Lever (Less Cylinder) - (Select by Chassis Type, Cylinder OEM, Cylinder Type, Cylinder Detail) - (Please specify STYLE and FINISH - Example: 03-031-SPA-626)

Cylindrical			
03-231	03-031	Schlage, KIL, PD/LD	\$136.00
03-232	03-032	Schlage, FSIC, RD/JD	\$136.00
03-200	03-000	Schlage, SFIC, GD/BD	\$136.00
03-280	23779739 (RHO)	Falcon, KIL, LD FA7 (7-PIN)	\$144.00
	23779762 (SPA)		
	23779747 (8RO)		
	23779770 (8SP)		
03-266	03-066	Corbin Russwin, FSIC, JD CO6 (6-PIN)	\$252.00
03-235	23854524 (RHO)	Corbin Russwin, FSIC, JD CO7 (7-PIN)	\$252.00
	23854540 (SPA)		
	23854565 (TLR)		
	23854532 (8RO)		
	23854557 (8SP)		
23854573 (8TR)			
03-244	03-044	Sargent, KIL, LD SAR (6-PIN)	\$252.00
03-277	03-077	Sargent, FSIC, JD SAR (6-PIN)	\$252.00
03-237	09-388	Medeco, FSIC, JD MED (6-PIN)	\$252.00
03-255	09-355	Yale, FSIC, JD YA6 (6-PIN)	\$252.00
03-236	09-399	Yale, FSIC, JD YA7 (7-PIN)	\$252.00
03-234		Corbin Russwin, KIL, LD CO6 (6-PIN)	\$252.00

New Lever Options

47258044	NEW	BOARDWALK - Closed	\$136.00
47258052	NEW	BOARDWALK - JD	\$136.00
47258048	NEW	BOARDWALK - PD/LD	\$136.00
47258040	NEW	BOARDWALK - BDC/BD/GD/HD	\$136.00
47258043	NEW	BROADWAY - Closed	\$136.00
47258051	NEW	BROADWAY - JD	\$136.00
47258047	NEW	BROADWAY - PD/LD	\$136.00
47258039	NEW	BROADWAY - BDC/BD/GD/HD	\$136.00
47258045	NEW	LATITUDE - Closed	\$136.00
47258053	NEW	LATITUDE - JD	\$136.00
47258049	NEW	LATITUDE - PD/LD	\$136.00
47258041	NEW	LATITUDE - BDC/BD/GD/HD	\$136.00
47258046	NEW	LONGITUDE - Closed	\$136.00
47258054	NEW	LONGITUDE - JD	\$136.00
47258050	NEW	LONGITUDE - PD/LD	\$136.00
47258042	NEW	LONGITUDE - BDC/BD/GD/HD	\$136.00
47260554	NEW	BOARDWALK (TACTILE) - Closed	\$182.00
47260546	NEW	BOARDWALK (TACTILE) - JD	\$182.00
47260550	NEW	BOARDWALK (TACTILE) - PD/LD	\$182.00
47260538	NEW	BOARDWALK (TACTILE) - BDC/BD/GD/HD	\$182.00

Pricing/product description subject to change without notice.

Exterior Lever (Less Cylinder)-
 (Select by Chassis Type, Cylinder OEM, Cylinder Type, Cylinder Detail) -
 (Please specify STYLE and FINISH - Example: 03-031-SPA-626) (continued)

New Part Number	Original Part Number	Description	List Price
New Lever Options (continued)			
47260553	NEW	BROADWAY (TACTILE) - Closed	\$182.00
47260545	NEW	BROADWAY (TACTILE) - JD	\$182.00
47260549	NEW	BROADWAY (TACTILE) - PD/LD	\$182.00
47260537	NEW	BROADWAY (TACTILE) - BDC/BD/GD/HD	\$182.00
47260555	NEW	LATITUDE (TACTILE) - Closed	\$182.00
47260547	NEW	LATITUDE (TACTILE) - JD	\$182.00
47260551	NEW	LATITUDE (TACTILE) - PD/LD	\$182.00
47260539	NEW	LATITUDE (TACTILE) - BDC/BD/GD/HD	\$182.00
47260556	NEW	LONGITUDE (TACTILE) - Closed	\$182.00
47260548	NEW	LONGITUDE (TACTILE) - JD	\$182.00
47260552	NEW	LONGITUDE (TACTILE) - PD/LD	\$182.00
47260540	NEW	LONGITUDE (TACTILE) - BDC/BD/GD/HD	\$182.00
Mortise			
03-231	09-331	Schlage, KIL, PD/LD	\$136.00
03-232	09-332	Schlage, FSIC, RD/JD	\$136.00
03-200	03-000	Schlage, SFIC, GD/BD	\$136.00
03-280	09-331	Falcon, KIL, LD FA7 (7-PIN)	\$144.00
03-266	09-366	Corbin Russwin, FSIC, JD CO6 (6-PIN)	\$252.00
03-235	09-366	Corbin Russwin, FSIC, JD CO7 (7-PIN)	\$252.00
03-244	09-344	Sargent, KIL, LD SAR (6-PIN)	\$252.00
03-277	09-377	Sargent, FSIC, JD SAR (6-PIN)	\$252.00
03-237	09-388	Medeco, FSIC, JD MED (6-PIN)	\$252.00
03-255	09-355	Yale, FSIC, JD YA6 (6-PIN)	\$252.00
03-236	09-399	Yale, FSIC, JD YA7 (7-PIN)	\$252.00
03-234	NEW	Corbin Russwin, KIL, LD CO6 (6-PIN)	\$252.00
New Lever Options			
47258044	NEW	BOARDWALK - Closed	\$136.00
47258052	NEW	BOARDWALK - JD	\$136.00
47258048	NEW	BOARDWALK - PD/LD	\$136.00
47258040	NEW	BOARDWALK - BDC/BD/GD/HD	\$136.00
47258043	NEW	BROADWAY - Closed	\$136.00
47258051	NEW	BROADWAY - JD	\$136.00
47258047	NEW	BROADWAY - PD/LD	\$136.00
47258039	NEW	BROADWAY - BDC/BD/GD/HD	\$136.00
47258045	NEW	LATITUDE - Closed	\$136.00
47258053	NEW	LATITUDE - JD	\$136.00
47258049	NEW	LATITUDE - PD/LD	\$136.00
47258041	NEW	LATITUDE - BDC/BD/GD/HD	\$136.00
47258046	NEW	LONGITUDE - Closed	\$136.00
47258054	NEW	LONGITUDE - JD	\$136.00
47258050	NEW	LONGITUDE - PD/LD	\$136.00
47258042	NEW	LONGITUDE - BDC/BD/GD/HD	\$136.00
47260554	NEW	BOARDWALK (TACTILE) - Closed	\$182.00
47260546	NEW	BOARDWALK (TACTILE) - JD	\$182.00
47260550	NEW	BOARDWALK (TACTILE) - PD/LD	\$182.00
47260538	NEW	BOARDWALK (TACTILE) - BDC/BD/GD/HD	\$182.00
47260553	NEW	BROADWAY (TACTILE) - Closed	\$182.00
47260545	NEW	BROADWAY (TACTILE) - JD	\$182.00
47260549	NEW	BROADWAY (TACTILE) - PD/LD	\$182.00
47260537	NEW	BROADWAY (TACTILE) - BDC/BD/GD/HD	\$182.00
47260555	NEW	LATITUDE (TACTILE) - Closed	\$182.00
47260547	NEW	LATITUDE (TACTILE) - JD	\$182.00
47260551	NEW	LATITUDE (TACTILE) - PD/LD	\$182.00
47260539	NEW	LATITUDE (TACTILE) - BDC/BD/GD/HD	\$182.00
47260556	NEW	LONGITUDE (TACTILE) - Closed	\$182.00
47260548	NEW	LONGITUDE (TACTILE) - JD	\$182.00
47260552	NEW	LONGITUDE (TACTILE) - PD/LD	\$182.00
47260540	NEW	LONGITUDE (TACTILE) - BDC/BD/GD/HD	\$182.00
Exit			
03-231	03-331	Schlage, KIL, PD/LD	\$136.00
03-232	03-332	Schlage, FSIC, RD/JD	\$136.00
03-200	03-300	Schlage, SFIC, GD/BD	\$136.00

Pricing/product description subject to change without notice.

**Exterior Lever (Less Cylinder)-
 (Select by Chassis Type, Cylinder OEM, Cylinder Type, Cylinder Detail) -
 (Please specify STYLE and FINISH - Example: 03-031-SPA-626) (continued)**

New Part Number	Original Part Number	Description	List Price
Exit (Continued)			
03-280	03-331	Falcon, KIL, LD FA7 (7-PIN)	\$144.00
03-266	03-366	Corbin Russwin, FSIC, JD CO6 (6-PIN)	\$252.00
03-235	03-366	Corbin Russwin, FSIC, JD CO7 (7-PIN)	\$252.00
03-244	03-344	Sargent, KIL, LD SAR (6-PIN)	\$252.00
03-277	03-377	Sargent, FSIC, JD SAR (6-PIN)	\$252.00
03-237	03-388	Medeco, FSIC, JD MED (6-PIN)	\$252.00
03-255	03-355	Yale, FSIC, JD YA6 (6-PIN)	\$252.00
03-236	03-399	Yale, FSIC, JD YA7 (7-PIN)	\$252.00
03-234	NEW	Corbin Russwin, KIL, LD CO6 (6-PIN)	\$252.00
New Lever Options			
47258044	NEW	BOARDWALK - Closed	\$136.00
47258052	NEW	BOARDWALK - JD	\$136.00
47258048	NEW	BOARDWALK - PD/LD	\$136.00
47258040	NEW	BOARDWALK - BDC/BD/GD/HD	\$136.00
47258043	NEW	BROADWAY - Closed	\$136.00
47258051	NEW	BROADWAY - JD	\$136.00
47258047	NEW	BROADWAY - PD/LD	\$136.00
47258039	NEW	BROADWAY - BDC/BD/GD/HD	\$136.00
47258045	NEW	LATITUDE - Closed	\$136.00
47258053	NEW	LATITUDE - JD	\$136.00
47258049	NEW	LATITUDE - PD/LD	\$136.00
47258041	NEW	LATITUDE - BDC/BD/GD/HD	\$136.00
47258046	NEW	LONGITUDE - Closed	\$136.00
47258054	NEW	LONGITUDE - JD	\$136.00
47258050	NEW	LONGITUDE - PD/LD	\$136.00
47258042	NEW	LONGITUDE - BDC/BD/GD/HD	\$136.00
47260554	NEW	BOARDWALK (TACTILE) - Closed	\$182.00
47260546	NEW	BOARDWALK (TACTILE) - JD	\$182.00
47260550	NEW	BOARDWALK (TACTILE) - PD/LD	\$182.00
47260538	NEW	BOARDWALK (TACTILE) - BDC/BD/GD/HD	\$182.00
47260553	NEW	BROADWAY (TACTILE) - Closed	\$182.00
47260545	NEW	BROADWAY (TACTILE) - JD	\$182.00
47260549	NEW	BROADWAY (TACTILE) - PD/LD	\$182.00
47260537	NEW	BROADWAY (TACTILE) - BDC/BD/GD/HD	\$182.00
47260555	NEW	LATITUDE (TACTILE) - Closed	\$182.00
47260547	NEW	LATITUDE (TACTILE) - JD	\$182.00
47260551	NEW	LATITUDE (TACTILE) - PD/LD	\$182.00
47260539	NEW	LATITUDE (TACTILE) - BDC/BD/GD/HD	\$182.00
47260556	NEW	LONGITUDE (TACTILE) - Closed	\$182.00
47260548	NEW	LONGITUDE (TACTILE) - JD	\$182.00
47260552	NEW	LONGITUDE (TACTILE) - PD/LD	\$182.00
47260540	NEW	LONGITUDE (TACTILE) - BDC/BD/GD/HD	\$182.00

**Exterior Lever (Less Cylinder), 10-Piece Bulk Pack-
 (Select by Chassis Type, Cylinder OEM, Cylinder Type, Cylinder Detail) - (Please specify STYLE and FINISH - Example: K103-031-SPA-626)**

Cylindrical			
K103-681	K103-031	Schlage, KIL, PD/LD	\$1,044.00*
K103-682	K103-032	Schlage, FSIC, RD/JD	\$1,244.00*
K103-680	K103-000	Schlage, SFIC, GD/BD	\$1,244.00*
K103-684	K103-066	Corbin Russwin, FSIC, JD CO6 (6-PIN)	\$1,937.00*
K103-683	K103-044	Sargent, KIL, LD SAR (6-PIN)	\$2,479.00*
K103-685	K103-077	Sargent, FSIC, JD SAR (6-PIN)	\$1,995.00*
K103-687	K109-388	Medeco, FSIC, JD MED (6-PIN)	\$2,482.00
K103-686	K103-055	Yale, FSIC, JD YA6 (6-PIN)	\$2,482.00*
K103-688	K109-399	Yale, FSIC, JD YA7 (7-PIN)	\$2,482.00*
K103-689	NEW	Falcon, KIL, LD FA7 (7-PIN)	\$1,995.00
K103-690	23991086 (RHO)	Corbin Russwin, FSIC, JD CO7 (7-PIN)	\$1,995.00
	23991094 (SPA)		
	23991102 (TLR)		
	23991110 (BRO)		
	23991128 (8SP)		
	23991136 (8TR)		

Pricing/product description subject to change without notice.

Exterior Lever (Less Cylinder), 10-Piece Bulk Pack-

(Select by Chassis Type, Cylinder OEM, Cylinder Type, Cylinder Detail) - (Please specify STYLE and FINISH - Example: K103-031-SPA-626)

New Part Number	Original Part Number	Description	List Price
Mortise			
K103-681	K109-331	Schlage, KIL, PD/LD	\$1,044.00*
K103-682	K109-332	Schlage, FSIC, RD/JD	\$1,244.00*
K103-680	K103-000	Schlage, SFIC, GD/BD	\$1,244.00*
K103-684	K109-366	Corbin Russwin, FSIC, JD CO6 (6-PIN)	\$1,937.00*
K103-683	K109-344	Sargent, KIL, LD SAR (6-PIN)	\$2,479.00*
K103-685	K109-377	Sargent, FSIC, JD SAR (6-PIN)	\$1,995.00*
K103-687	K109-388	Medeco, FSIC, JD MED (6-PIN)	\$2,482.00
K103-686	K109-355	Yale, FSIC, JD YA6 (6-PIN)	\$2,482.00*
K103-688	K109-399	Yale, FSIC, JD YA7 (7-PIN)	\$2,482.00*
K103-689	K109-331	Falcon, KIL, LD FA7 (7-PIN)	\$1,995.00
K103-690	K109-366	Corbin Russwin, FSIC, JD CO7 (7-PIN)	\$1,995.00
Exit			
K103-681	K103-331	Schlage, KIL, PD/LD	\$1,044.00*
K103-682	K103-332	Schlage, FSIC, RD/JD	\$1,244.00*
K103-680	K103-000	Schlage, SFIC, GD/BD	\$1,244.00*
K103-689	K103-331	Falcon, KIL, LD FA7 (7-PIN)	\$1,937.00
K103-684	K103-366	Corbin Russwin, FSIC, JD CO6 (6-PIN)	\$2,479.00
K103-690	K103-366	Corbin Russwin, FSIC, JD CO7 (7-PIN)	\$1,995.00
K103-683	K103-344	Sargent, KIL, LD SAR (6-PIN)	\$2,482.00*
K103-685	K103-377	Sargent, FSIC, JD SAR (6-PIN)	\$2,482.00*
K103-687	K103-388	Medeco, FSIC, JD MED (6-PIN)	\$2,482.00
K103-686	K103-355	Yale, FSIC, JD YA6 (6-PIN)	\$1,995.00*
K103-688	K103-399	Yale, FSIC, JD YA7 (7-PIN)	\$1,995.00*

*This part is shared with Schlage mechanical and defaults to the Schlage mechanical discount.

Steel Lever Kits & Parts

Obsolete	24274730-AD	Steel Lever Conversion Kit - (Includes Escutcheon Assembly, Spring Cage Assembly, Lever Rotation Stops, Screws, Instructions) - Please specify CLASS, READER, FINISH)	Obsolete
Obsolete			
Obsolete	47250325	Stainless Steel Set Screw for outside Steel Levers (Package of 20)	Obsolete

Part Number	Description	List Price
Lock Retractor - (Select by Chassis Type, Chassis Thickness)		
Cylindrical		
46928800	Retractor	\$333.00
Mortise		
46928818	1-1/16" Narrow - (Door Thicknesses 1-3/8" to 1-5/8")	\$428.00
46928826	1-1/4" Standard - (Door Thicknesses 1-3/4" to 2-3/4")	\$428.00
Mortise Deadbolt		
46928834	1-1/16" Narrow - (Door Thicknesses 1-3/8" to 1-5/8")	\$542.00
46928842	1-1/4" Standard - (Door Thicknesses 1-3/4" to 2-3/4")	\$542.00

Spindle & Hub Kit - (Select by Chassis Type)

Exit		
46929295	Exit Spindle & Hub Kit (Includes Spindle, Spindle Cover, Spindle Hub, Tailpiece, Twisted Tailpiece, Tailpiece Spring, Pine Tree Clip, Screw)	\$41.60

Spindle Spring

47256978	Inside Spindle Spring (25 Pack)	\$77.00
----------	---------------------------------	---------

Deadbolt Thumb Turn Assembly (with E-Clip) - (Please specify FINISH - Example: 46929113-626)

46929113	Deadbolt Thumb Turn Assembly (with E-Clip)	\$334.00
----------	--	----------

Strike Plate - Select by Chassis Type - (Please specify FINISH-SHAPE and LIP - Example -10-025-0118-0626)

Cylindrical		
10-025-1316	ANSI, no box, 1-1/4" x 4-7/8", Standard with 1-3/16" Lip	\$15.20*
10-025-138	ANSI, no box, 1-1/4" x 4-7/8", Standard with Lip 1-3/8" Lip	\$43.70*
10-025-112	ANSI, no box, 1-1/4" x 4-7/8", Standard with 1-1/2" Lip	\$43.70*
10-013-118	Square corner, T-strike, box, 1-1/8" x 2-3/4" with 1-1/8" Lip	\$11.80*
10-013-112	Square corner, T-strike, box, 1-1/8" x 2-3/4" with 1-1/2" Lip	\$16.50*
10-016	Square corner, T-strike, deep box, 1-1/8" x 2-3/4" with 1-1/8" Lip Use with Fire door latch	\$15.70*
K510-066	Box for ANSI strike	\$7.20*
XQ07-351-134	Strike, ANSI, No Box, 1-1/4" x 4-7/8", 1-3/4" Lip Length	\$206.00*
XQ03-494-134	Strike, Square Corner, T-strike, Box, 1-1/8" x 2-3/4", 1-3/4" Lip	\$170.00*
Mortise Deadbolt		
10-072-1316	1-1/4" x 4-7/8" Square corner, box, standard with Lip at 1-3/16", 1", 1-1/2", 1-3/4", or 2"	\$22.50*
10-072-xx	1-1/4" x 4-7/8" Square corner, box, specify lip length (xx) as 1" or 1-1/2"	\$22.50*
10-072-xx	1-1/4" x 4-7/8" Square corner, box, specify lip length (xx) as 1-3/4", 1" or 2"	\$57.50*
10-075	1/2" Rabbeted	\$148.00*
37-015	Strike frame reinforcer	\$25.00*
XL11-820	Strike, One hole for latching Functions, RH & LHR door, 1-3/16" Lip	\$42.70*
XL11-821	Strike, One hole for latching Functions, LH & RHR door, 1-3/16" Lip	\$42.70*

Mortise Armor Front - (Select by Width, Door Thickness) - (Please specify FINISH: 09-663-626)

09-663	Armor, 1-1/4" Wide Square Corner, Latch x Auxiliary latch (for door range 1-3/4" to 2-3/4")	\$37.00*
09-666	Armor, 1-1/4" Wide Square Corner, Latch x Auxiliary latch x Deadbolt (for door range 1-3/4" to 2-3/4")	\$37.00*
09-669	Armor, 1-1/16" Wide Square Corner, Latch x Auxiliary latch (for door range 1-3/8" to 1-5/8")	\$37.00*
09-672	Armor, 1-1/16" Wide Square Corner, Latch x Auxiliary latch x Deadbolt (for door range 1-3/8" to 1-5/8")	\$37.00*

*This part is shared with Schlage mechanical and defaults to the Schlage mechanical discount.

AD-Series Parts



Part Number	Description	List Price
Door Thickness Kit - (Select by Chassis Type) - (Please specify DOOR THICKNESS - Example: 46929170-134)		
Cylindrical		
46929170-138	1-3/8" Door Thickness Kit (Includes Baseplate Screws, Reader Screws, Spindles, Spring, Pin Wrench, Fire Plate Screw, Shim Plates, Standoffs)	\$163.00
46929170-112	1-1/2" Door Thickness Kit (Includes Baseplate Screws, Reader Screws, Spindles, Spring, Pin Wrench, Fire Plate Screw, Shim Plates, Standoffs)	\$116.00
46929170-158	1-5/8" Door Thickness Kit (Includes Baseplate Screws, Reader Screws, Spindles, Spring, Pin Wrench, Fire Plate Screw, Shim Plates, Standoffs)	\$83.00
46929170-XXX	Door Thickness Kit (Includes Baseplate Screws, Reader Screws, Spindles, Spring, Pin Wrench, Fire Plate Screw, Shim Plates, Standoffs) Must specify door thickness: 1-3/4" to 2-3/4" in 1/8" increments (EXAMPLE: 46929170-134 for a 1-3/4" door)	\$50.00
Mortise		
46929178-138	1-3/8" Door Thickness Kit (Includes Baseplate Screws, Reader Screws, Spindles, Spring, Pin Wrench, Fire Plate Screw, Shim Plates, Standoffs)	\$163.00
46929178-112	1-1/2" Door Thickness Kit (Includes Baseplate Screws, Reader Screws, Spindles, Spring, Pin Wrench, Fire Plate Screw, Shim Plates, Standoffs)	\$116.00
46929178-158	1-5/8" Door Thickness Kit (Includes Baseplate Screws, Reader Screws, Spindles, Spring, Pin Wrench, Fire Plate Screw, Shim Plates, Standoffs)	\$83.20
46929178-XXX	Door Thickness Kit (Includes Baseplate Screws, Reader Screws, Spindles, Spring, Pin Wrench, Fire Plate Screw, Shim Plates, Standoffs) Must specify door thickness: 1-3/4" to 2-3/4" in 1/8" increments (EXAMPLE: 46929178-134 for a 1-3/4" door)	\$50.00
Decorative Plate - (Select by Size) - (Please specify FINISH - Example: 23760283-626)		
23631823	1.5" x 3.25" x .105" Decorative Plate (with Screws) - (Exit Chassis)	\$35.30
23760267	1.7" x 3.5" x .075" Decorative Plate (with Screws)	\$25.90
23760283	3.2" x 3.5" x .075" Decorative Plate (with Screws)	\$40.10
23760317	6.0" x 3.5" x .075" Decorative Plate (with Screws)	\$61.10
23760325	6.6" x 3.5" x .075" Decorative Plate (with Screws)	\$61.10
23760309	8.0" x 3.5" x .075" Decorative Plate (with Screws)	\$62.40
23760291	8.0" x 3.5" x .075" Decorative Plate (with Screws and Welded Standoff)	\$84.50
23760259*	10.5" x 3.5" x .075" Decorative Plate (no Screws necessary) - (Under Lock)	\$81.00
23760275*	12.0" x 3.5" x .075" Decorative Plate (no Screws necessary) - (Under Lock)	\$80.20
*Please consider overall Door Thickness when ordering		
Note: Single Decorative Plate. Interior and Exterior Decorative Plates may be required.		
Note: Decorative Plates may have multiple applications. Please see AD-Series Retrofit Template Overlay guide at www.schlage.com/support for more information		
Available Finishes: 626 Satin Chrome Standard. Please consult Customer Care for 605 Bright Brass or 643E Aged Bronze.		
Interior Shim Plate - (Select by Class)		
23458607	Interior Shim Plate, AD200/250/300 - (Device is 0.063" thick)	\$28.80
23458565	Interior Shim Plate, AD400 - (Device is 0.063" thick)	\$28.80
Exterior Shim Plate		
23458599	Exterior Shim Plate - (Device is 0.063" thick)	\$22.50
Door Position Switch		
46929121	Door Position Switch	\$31.60
Offline/Hardwired Communication Module Cover - (Select by Function) - (Please specify FINISH - Example: COM200C-626)		
COM200C (23519168)	Offline Communication Module Cover, Cover (Includes Communication Module Cover, Cover Screw, Torx Cover Screw)	See page 156
COM200L (23519184)	Offline/Hardwired Communication Module Cover, Indicator (Includes Off-Line/Hardwired Communication Module Cover with Indicator, Cover Screw, Torx Cover Screw)	See page 156
COM200P (23519176)	Offline/Hardwired Communication Module Cover, Pushbutton (Includes Offline/Hardwired Communication Module Cover with Pushbutton, Cover Screw, Torx Cover Screw)	See page 156
Hardwired Upgrade Kit - (Select by Function) - (Please specify FINISH - Example: COM300L-626)		
COM300L (46928909)	Hardwired Upgrade Kit, Indicator (Includes Hardwired Communication Module, Standoff, Offline/Hardwired Communication Module Cover with Indicator, Cover Screw, Torx Cover Screw)	See page 156
COM300P (46928891)	Hardwired Upgrade Kit, Pushbutton (Includes Hardwired Communication Module, Standoff, Offline/Hardwired Communication Module Cover with Pushbutton, Cover Screw, Torx Cover Screw)	See page 156

Pricing/product description subject to change without notice.

Part Number	Description	List Price
Hardwired Communication Module		
46928958	Hardwired Communication Module (with Fasteners, Jumpers)	\$249.00
Wireless Upgrade Kit - (Select by Function) - (Please specify FINISH - Example: COM400L-GRY)		
COM400L (46928867)	Wireless Upgrade Kit, Indicator (Includes Wireless Communication Module, (2) Standoffs, Wireless Communication Module Cover with Indicator, Cover Screw, Torx Cover Screw, Wireless Foil Gasket)	See page 156
COM400P (46928859)	Wireless Upgrade Kit, Pushbutton (Includes Wireless Communication Module, (2) Standoffs, Wireless Communication Module Cover with Pushbutton, Cover Screw, Torx Cover Screw, Wireless Foil Gasket)	See page 156
Wireless Communication Module Cover - (Select by Function) - (Please specify FINISH - Example: 46928883-GRY)		
46928883	Wireless Communication Module Cover, Indicator (with Screws)	\$58.10
46928875	Wireless Communication Module Cover, Pushbutton (with Screws)	\$66.30
Wireless Communication Module		
46928941	Wireless Communication Module (with Screws, Standoffs)	\$333.00
23848385	Wireless Communication Module with Antenna Connector (with Screws, Standoffs)	\$362.00
Wireless Parts		
46928974	Wireless Foil Gasket	\$19.90
47250326	Terminal Block Kit – (Includes one power connector and ten I/O connectors) supports PIM400, PIB300, TK400, ECK400, GCK400 and WRI400	\$44.40
Battery Holder & Cover Kit - (Select by Battery Quantity) - (Please specify FINISH - Example: 4B-626)		
4B (46929055)	4AA Battery Holder & Cover Kit (Includes 4AA Battery Holder with Cable, 4AA Battery Strap, Battery Strap Screws, 4AA Battery Cover, Cover Screw, Torx Cover Screw)	\$56.00
8B (46929089)	8AA Battery Holder & Cover Kit (Includes 8AA Battery Holder with Cable, 8AA Battery Strap, Battery Strap Screws, 8AA Battery Cover, Cover Screw, Torx Cover Screw)	\$104.00
Battery Holder Kit - (Select by Battery Quantity)		
46929063	4AA Battery Holder Kit (Includes 4AA Battery Holder with Cable, 4AA Battery Strap, Battery Strap Screws)	\$24.10
46929097	8AA Battery Holder Kit (Includes 8AA Battery Holder with Cable, 8AA Battery Strap, Battery Strap Screws)	\$48.00
Battery Parts		
4C (46929071)	4AA Battery Cover (with Screw) - Please specify FINISH - Example: 4C-626)	\$32.00
8C (46929105)	8AA Battery Cover (with Screw) - Please specify FINISH	\$56.00
47250305	Mylar Protective Sticker for 8 Battery Pack (Package of 20)	\$144.00
47250320	AD Battery Cable (Package of 5)	\$22.90
Battery - (Select by Battery Type)		
F206-488	(4) AA Batteries	\$10.70
<i>*Not for use with AD-Series Locks</i>		
Interior Cover Hardware Kit - (Please specify FINISH - Example: 46928966-626)		
46928966	Interior Cover Hardware Kit (Includes (2) Wireless Communication Module Cover Screws, (1) Hardwired Communication Module Cover Screw, (1) 4AA Battery Cover Screw, (1) 8AA Battery Cover Screw)	\$41.60
Torx Tamper Screw Pack - (Select by Chassis Type)		
Cylindrical		
23538812	Torx Tamper Screw Pack	\$40.10
Mortise		
23538820	Torx Tamper Screw Pack	\$32.00
Exit		
23538838	Torx Tamper Screw Pack	\$39.00
Interior Main Board - (Please specify CLASS - Example: 46929048-200 for AD-200)		
46929048	Interior Main Board (with Battery Lead, Coin Cell Battery, (2) Screws)	\$639.00

Pricing/product description subject to change without notice.

Part Number	Description	List Price
Wiring Harness (Interior Main Board to Exterior Board) - (Select by Chassis Type)		
Cylindrical		
46928727	Wiring Harness (Interior Main Board to Exterior Board)	\$51.20
Mortise		
46928727	Wiring Harness (Interior Main Board to Exterior Board)	\$51.20
Exit		
46928735	Wiring Harness (Interior Main Board to Exterior Board)	\$51.20
23536774	RX Adapter	\$48.00
REX Switch, Leaf Spring and Screws		
46929139	REX Switch, Leaf Spring and Screws - (for CY and MS/MD only)	\$33.40
Drill Bit (Same as Legacy)		
P511472	Drill Bit for 3/8" VIP/AD-300	\$770.00
Request-to-Exit Switch Kit		
RX-LC	Von Duprin RX-LC (also called SI-LC or Von Duprin part number 050281)	\$318.00

Please see Falcon Price Book for Falcon AE part number 650359

CO-SERIES PARTS - TABLE OF CONTENTS

READER MODULE WITH EXTERIOR ESCUTCHEON	220
INTERIOR ESCUTCHEON	220
EXTERIOR ESCUTCHEON	221
BASE PLATE SUB ASSEMBLY	221
MOUNTING HARDWARE	221
INTERIOR SPRING CAGE	221
EXTERIOR SPRING CAGE	222
TAILPIECE	223
CYLINDER	225
LEVER	225
LOCK RETRACTOR	229
STRIKE PLATE	229
DOOR THICKNESS KIT	230
DECORATIVE PLATE	230
MISCELLANEOUS	231

CONTACT INFORMATION FOR CO-SERIES PARTS

Payment Address: Schlage Electronic Security
 15934 Collections Center Drive
 Chicago, IL 60693

877-671-7011	
Customer Service:	Technical Support:
Order Status, Credit Returns of Non-Defective Products, General Sales Questions	Technical Questions/Issues, Returns of Defective Products, Repairs
Email Orders To: Order_Entry_Schlage_Commercial@allegion.com	Contact For Technical Assistance: Electronic_Lock_TechProdSupport@allegion.com

For CO-Series Parts Warranty Information please see page 13.

Pricing/product description subject to change without notice.

New Part Number	Original Part Number	Description	List Price
Reader Module (with Exterior Escutcheon)-			
(Select by Chassis, Class, Reader Technology) - (Please specify FUNCTION, FINISH, CYLINDER TYPE, HANDING)			
Cylindrical			
EXT-CO-100-CY-xx-KP	EXT-CO-100-CY-xx-KP	CO-100, Keypad Only Reader Module	\$461.00
EXT-CO-200-CY-xx-KP	EXT-CO-200-CY-xx-KP	CO-200, Keypad Only Reader Module	\$682.00
EXT-CO-200-CY-xx-MS	EXT-CO-200-CY-xx-MS	CO-200, Magnetic Stripe (Swipe) Reader Module - (Track 1, 2, or 3)	\$806.00
EXT-CO-200-CY-xx-MSK	EXT-CO-200-CY-xx-MSK	CO-200, Magnetic Stripe (Swipe) with Keypad Reader Module - (Track 1, 2, or 3)	\$885.00
EXT-CO-200-CY-xx-PR	EXT-CO-200-CY-xx-PR	CO-200, Proximity Reader Module - (125 kHz Proximity)	\$885.00
EXT-CO-200-CY-xx-PRK	EXT-CO-200-CY-xx-PRK	CO-200, Proximity with Keypad Reader Module - (125 kHz Proximity)	\$968.00
EXT-CO-250-CY-xx-MS	EXT-CO-250-CY-xx-MS	CO-250, Magnetic Stripe (Swipe) Reader Module - (Track 1, 2, or 3)	\$806.00
EXT-CO-250-CY-xx-MSK	EXT-CO-250-CY-xx-MSK	CO-250, Magnetic Stripe (Swipe) with Keypad Reader Module - (Track 1, 2, or 3)	\$885.00
Mortise			
EXT-CO-100-MS-xx-KP	EXT-CO-100-MS-xx-KP	CO-100, Keypad Only Reader Module	\$499.00
EXT-CO-200-MS-xx-KP	EXT-CO-200-MS-xx-KP	CO-200, Keypad Only Reader Module	\$722.00
EXT-CO-200-MS-xx-MS	EXT-CO-200-MS-xx-MS	CO-200, Magnetic Stripe (Swipe) Reader Module - (Track 1, 2, or 3)	\$843.00
EXT-CO-200-MS-xx-MSK	EXT-CO-200-MS-xx-MSK	CO-200, Magnetic Stripe (Swipe) with Keypad Reader Module - (Track 1, 2, or 3)	\$923.00
EXT-CO-200-MS-xx-PR	EXT-CO-200-MS-xx-PR	CO-200, Proximity Reader Module - (125 kHz Proximity)	\$923.00
EXT-CO-200-MS-xx-PRK	EXT-CO-200-MS-xx-PRK	CO-200, Proximity with Keypad Reader Module - (125 kHz Proximity)	\$1,002.00
EXT-CO-250-MS-xx-MS	EXT-CO-250-MS-xx-MS	CO-250, Magnetic Stripe (Swipe) Reader Module - (Track 1, 2, or 3)	\$843.00
EXT-CO-250-MS-xx-MSK	EXT-CO-250-MS-xx-MSK	CO-250, Magnetic Stripe (Swipe) with Keypad Reader Module - (Track 1, 2, or 3)	\$923.00
Mortise Deadbolt			
EXT-CO-200-MD-40-KP	EXT-CO-200-MD-40-KP	CO-200, Keypad Only Reader Module	\$722.00
EXT-CO-200-MD-40-MS	EXT-CO-200-MD-40-MS	CO-200, Magnetic Stripe (Swipe) Reader Module - (Track 1, 2, or 3)	\$843.00
EXT-CO-200-MD-40-MSK	EXT-CO-200-MD-40-MSK	CO-200, Magnetic Stripe (Swipe) with Keypad Reader Module - (Track 1, 2, or 3)	\$923.00
EXT-CO-200-MD-40-PR	EXT-CO-200-MD-40-PR	CO-200, Proximity Reader Module - (125 kHz Proximity)	\$923.00
EXT-CO-200-MD-40-PRK	EXT-CO-200-MD-40-PRK	CO-200, Proximity with Keypad Reader Module - (125 kHz Proximity)	\$1,002.00
EXT-CO-250-MD-40-MS	EXT-CO-250-MD-40-MS	CO-250, Magnetic Stripe (Swipe) Reader Module - (Track 1, 2, or 3)	\$843.00
EXT-CO-250-MD-40-MSK	EXT-CO-250-MD-40-MSK	CO-250, Magnetic Stripe (Swipe) with Keypad Reader Module - (Track 1, 2, or 3)	\$923.00
Exit			
EXT-CO-100-993-xx-KP	New	CO-100, Keypad Only Reader Module	\$461.00
EXT-CO-200-993-xx-KP	New	CO-200, Keypad Only Reader Module	\$682.00
EXT-CO-200-993-xx-MS	New	CO-200, Magnetic Stripe (Swipe) Reader Module - (Track 1, 2, or 3)	\$806.00
EXT-CO-200-993-xx-MSK	New	CO-200, Magnetic Stripe (Swipe) with Keypad Reader Module - (Track 1, 2, or 3)	\$885.00
EXT-CO-200-993-xx-PR	New	CO-200, Proximity Reader Module - (125 kHz Proximity)	\$885.00
EXT-CO-200-993-xx-PRK	New	CO-200, Proximity with Keypad Reader Module - (125 kHz Proximity)	\$968.00
EXT-CO-250-993-xx-MS	New	CO-250, Magnetic Stripe (Swipe) Reader Module - (Track 1, 2, or 3)	\$806.00
EXT-CO-250-993-xx-MSK	New	CO-250, Magnetic Stripe (Swipe) with Keypad Reader Module - (Track 1, 2, or 3)	\$885.00

Keypad Membrane

44487247	Keypad Membrane	\$37.60
----------	-----------------	---------

Magnetic Swipe Cleaning Cards

510310	Magnetic Stripe Cleaning Cards	\$38.50
--------	--------------------------------	---------

Interior Escutcheon - (Select by Chassis Type, Function) - (Please specify FINISH - Example: 23599327-626)

Cylindrical			
	23599327	Interior Escutcheon, Non-Privacy	\$132.00
	23599335	Interior Escutcheon, Privacy	\$160.00
Mortise			
	23599327	Interior Escutcheon, Non-Privacy	\$132.00
	23599335	Interior Escutcheon, Privacy	\$160.00
Mortise Deadbolt			
	23599343	Interior Escutcheon, Non-Privacy	\$148.00
	23599350	Interior Escutcheon, Privacy	\$160.00
Exit			
	46929279	Interior Escutcheon, Non-Privacy (with (4) Screws)	\$56.50

Interior Baseplate Gasket

Exit			
	46928982	Interior Baseplate Gasket	\$33.40

USB Cover Plug, 10-Piece Bulk Pack

46928719	46928719	USB Cover Plug (10-Piece Bulk Pack)	\$24.90
47258550	New	USB Cover Plug, Exit (10-Piece Bulk Pack)	\$24.90
47253409	New	Cable, USB, AD/CO, Exit	\$21.90

New Part Number	Original Part Number	Description	List Price
Exterior Escutcheon - (Select by Chassis Type, Class, Reader Type) - (Please specify FINISH - Example: 23599053-626)			
Cylindrical			
47260707	23599053	Exterior Escutcheon, CO-100, KP (with (6) Screws)	\$225.00
47260709	23599079	Exterior Escutcheon, CO-200, KP (with (6) Screws)	\$200.00
47260705	23599038	Exterior Escutcheon, CO-200/250, PR/PRK/MS/MSK (with (6) Screws, O-Ring)	\$123.00
Mortise			
47260707	23599061	Exterior Escutcheon, CO-100, KP (with (6) Screws)	\$123.00
47260709	23599087	Exterior Escutcheon, CO-200, KP (with (6) Screws)	\$200.00
47260705	23599046	Exterior Escutcheon, CO-200/250, PR/PRK/MS/MSK (with (6) Screws, O-Ring)	\$123.00
Exit			
47260708	23599061	Exterior Escutcheon, CO-100, KP (with (6) Screws)	\$123.00
47260710	23599087	Exterior Escutcheon, CO-200, KP (with (6) Screws)	\$200.00
47260706	23599046	Exterior Escutcheon, CO-200/250, PR/PRK/MS/MSK (with (6) Screws, O-Ring)	\$123.00
Exterior Gasket Kit - (Select by Chassis Type)			
Cylindrical			
47260740	46929154	Exterior Gasket Kit (Includes Exterior Baseplate Gasket, Spindle Cover Seal, Reader O-Ring)	\$50.00
Mortise			
47260740	46929162	Exterior Gasket Kit (Includes Exterior Baseplate Gasket, Spindle Cover Seal, Reader O-Ring)	\$50.00
Exit			
47260741	46929162	Exterior Gasket Kit (Includes Exterior Baseplate Gasket, Spindle Cover Seal, Reader O-Ring)	\$50.00
Interior Baseplate Sub-Assembly			
Exit			
	23599251	Interior Baseplate Sub-Assembly	\$32.00
Interior Baseplate Spacer for SVR			
Exit			
	46929238	Interior Baseplate Spacer for SVR (with Baseplate Mounting Screws, Surface Mount Screws)	\$46.50
Interior Mounting Plate			
	23599244	Interior Mounting Plate (with Screws)	\$40.00
Exit Device Mounting Plate - (Please specify FINISH - Example: 46929220-626)			
Exit			
Obsolete	46929220	Exit Device Mounting Plate (with (2) Baseplate Mounting Screws)	
Exit Device Mounting Hardware Kit- (Please specify Device Type (993R, 993S or 993M), DOOR THICKNESS, FINISH - Example: 46929287-993M-626-134)			
Exit			
47260744	46929287	Exit Device Mounting Hardware Kit (Upper Mounting Bolts, Lower Mounting Sex-Bolts, Reader Mounting Bolts, Finish Washers, Screws)	\$83.20
Interior Spring Cage (with Screws)			
Cylindrical			
47260717	23599210	Interior Spring Cage (with Screws)	\$48.10
Mortise			
47260717	23599210	Interior Spring Cage (with Screws)	\$48.10

Pricing/product description subject to change without notice.

New Part Number	Original Part Number	Description	List Price
Exterior Spring Cage (with Screws) - (Select by Chassis Type, Cylinder OEM, Cylinder Type, Cylinder Detail)			
Cylindrical			
47258543	46928552	Schlage, KIL, PD/LD	\$69.80
	46928552	Schlage, FSIC, RD/JD	
	46928560	Schlage, SFIC, GD/BD	
	23845969	Falcon, KIL, LD FA7 (7-PIN)	
	46928586	Corbin Russwin, FSIC, JD CO6 (6-PIN)	
	23990674	Corbin Russwin, FSIC, JD CO7 (7-PIN)	
	46928578	Sargent, KIL, LD SAR (6-PIN)	
	46928586	Sargent, FSIC, JD SAR (6-PIN)	
47258544	24281735	Medeco, FSIC, JD MED (6-PIN)	\$333.00
	46928644	Yale, FSIC, JD YA6 (6-PIN)	
	24281768	Yale, FSIC, JD YA7 (7-PIN)	
Mortise			
47258543	46928602	Schlage, KIL, PD/LD	\$69.80
	46928610	Schlage, FSIC, RD/JD	
	46928560	Schlage, SFIC, GD/BD	
	23845977	Falcon, KIL, LD FA7 (7-PIN)	
	46928636	Corbin Russwin, FSIC, JD CO6 (6-PIN)	
	23988033	Corbin Russwin, FSIC, JD CO7 (7-PIN)	
	46928628	Sargent, KIL, LD SAR (6-PIN)	
	46928636	Sargent, FSIC, JD SAR (6-PIN)	
47258544	24281735	Medeco, FSIC, JD MED (6-PIN)	\$333.00
	46928644	Yale, FSIC, JD YA6 (6-PIN)	
	24281768	Yale, FSIC, JD YA7 (7-PIN)	
Exit			
47258545	46928651	Schlage, KIL, PD/LD (Steel Levers)	\$170.00
	46928553	Schlage, FSIC, RD/JD (Steel Levers)	
	46928669	Schlage, SFIC, GD/BD (Zinc Levers)	
	23779838	Falcon, KIL, LD FA7 (7-PIN) (Steel Levers) - (Except ATH, 8AT Lever Style)	
	46928693	Corbin Russwin, FSIC, JD CO6 (6-PIN) (Steel Levers)	
	23988017	Corbin Russwin, FSIC, JD CO7 (7-PIN) (Steel Levers) - (Except ATH, 8AT Lever Style)	
	46928677	Sargent, KIL, LD SAR (6-PIN) (Steel Levers)	
	46928685	Sargent, FSIC, JD SAR (6-PIN) (Steel Levers)	
47258546	24289902	Medeco, FSIC, JD MED (6-PIN)	\$335.00
	46928701	Yale, FSIC, JD YA6 (6-PIN) (Steel Levers)	
	24289928	Yale, FSIC, JD YA7 (7-PIN)	

Exterior Spring Cage & Tailpiece Kit (for Schlage), 10-Piece Bulk Pack - (Select by Chassis, Cylinder OEM, Cylinder Type, Cylinder Detail)			
Cylindrical			
47259238	23593270	Schlage, KIL, PD/LD	\$691.00
47259239	23593288	Schlage, FSIC, RD/JD	\$729.00
47259240	23593304	Schlage, SFIC, GD/BD	\$1,132.00
Mortise			
47259238	23593346	Schlage, KIL, PD/LD	\$1,538.00
47259239	23593353	Schlage, FSIC, RD/JD	\$2,297.00
47259240	23593304	Schlage, SFIC, GD/BD	\$1,132.00
Exit			
47259249	23593271	Schlage, KIL, PD/LD	\$1,538.00
47259250	23593272	Schlage, FSIC, RD/JD	\$2,297.00
47259248	23593437	Schlage, SFIC, GD/BD	\$1,233.00
	23593510		

Pricing/product description subject to change without notice.

New Part Number	Original Part Number	Description	List Price
Exterior Spring Cage & Tailpiece Kit (for Non-Schlage), Single Piece - (Select by Chassis Type, Cylinder OEM, Cylinder Type, Cylinder Detail)			
Cylindrical			
47259244	23845985	Falcon, KIL, LD FA7 (7-PIN)	\$83.40
47259242	23593320	Corbin Russwin, FSIC, JD CO6 (6-PIN)	\$362.00
	23990666	Corbin Russwin, FSIC, JD CO7 (7-PIN)	
47259241	23593312	Sargent, KIL, LD SAR (6-PIN)	\$338.00
47259242	23593320	Sargent, FSIC, JD SAR (6-PIN)	\$362.00
47259245	24281792	Medeco, FSIC, JD MED (6-PIN)	\$381.00
47259243	23593395	Yale, FSIC, JD YA6 (6-PIN)	\$381.00
47259246	24281826	Yale, FSIC, JD YA7 (7-PIN)	\$333.00
Mortise			
47259244	23845923	Falcon, KIL, LD FA7 (7-PIN)	\$83.40
47259242	23593387	Corbin Russwin, FSIC, JD CO6 (6-PIN)	\$362.00
	23988041	Corbin Russwin, FSIC, JD CO7 (7-PIN)	
47259241	23593379	Sargent, KIL, LD SAR (6-PIN)	\$338.00
47259242	23593387	Sargent, FSIC, JD SAR (6-PIN)	\$362.00
47259245	24281792	Medeco, FSIC, JD MED (6-PIN)	\$381.00
47259243	23593395	Yale, FSIC, JD YA6 (6-PIN)	\$381.00
47259246	24281826	Yale, FSIC, JD YA7 (7-PIN)	\$333.00
Exit			
47259254	23810872	Falcon, KIL, LD FA7 (7-PIN)	\$88.00
47259252	23593274	Corbin Russwin, FSIC, JD CO6 (6-PIN)	\$362.00
	23988025	Corbin Russwin, FSIC, JD CO7 (7-PIN) - (Except ATH, 8AT Lever Styles)	
47259251	23593273	Sargent, KIL, LD SAR (6-PIN)	\$338.00
47259252	23593274	Sargent, FSIC, JD SAR (6-PIN)	\$362.00
47259255	24289936	Medeco, FSIC, JD MED (6-PIN)	\$368.00
47259253	23593275	Yale, FSIC, JD YA6 (6-PIN)	\$368.00
47259257	24289944	Yale, FSIC, JD YA7 (7-PIN)	\$315.00
Tailpiece - (Select by Chassis Type, Cylinder OEM, Cylinder Type, Cylinder Detail)			
Cylindrical			
47258186	C604-243	Schlage, KIL, PD/LD - (Everest/Primus/Modular Cylinders)	\$1.90*
	C603-524	Schlage, KIL, PD/LD - (Classic Cylinders)	
23446339	23446339	Schlage, FSIC, JD/RD/TD	\$5.50
47258182	23779820	Falcon, KIL, LD FA7 (7-PIN)	\$24.10
47258187	46929456	Universal, SFIC, BD/BDC	\$15.60
47258180	23433634	Corbin Russwin, FSIC, JD CO6 (6-PIN)	\$37.10
	23854516	Corbin Russwin, FSIC, JD CO7 (7-PIN)	
47258179	23433626	Sargent, KIL, LD SAR (6-PIN) - (Compatible with 10L and 11L)	\$5.70
47258180	23433634	Sargent, FSIC, JD SAR (6-PIN)	\$37.10
47258183	23810898	Medeco, FSIC, JD MED (6-PIN)	\$86.70
47258181	23760366	Yale, FSIC, JD YA6 (6-PIN) - (Compatible with Medeco 31)	\$47.40
47258184	23929722	Yale, FSIC, JD YA7 (7-PIN)	\$32.00
23446347	23446347	Universal, SFIC, GD/HD	\$13.70
47258185	new	Corbin Russwin, KIL LD CO6	\$14.60
Mortise			
47258186	23538077	Schlage, KIL, PD/LD - (Everest/Primus/Modular Cylinders)	\$1.90*
	23538085	Schlage, KIL, PD/LD - (Classic Cylinders)	
23446339	23446339	Schlage, FSIC, JD/RD/TD	\$5.50
47258182	23779820	Falcon, KIL, LD FA7 (7-PIN)	\$24.10
47258187	46929456	Universal, SFIC, BD/BDC	\$15.60
47258180	23443435	Corbin Russwin, FSIC, JD CO6 (6-PIN)	\$37.10
	23854516	Corbin Russwin, FSIC, JD CO7 (7-PIN)	
47258179	23443427	Sargent, KIL, LD SAR (6-PIN) - (Compatible with 10L and 11L)	\$5.70
47258180	23443435	Sargent, FSIC, JD SAR (6-PIN)	\$37.10
47258183	23810898	Medeco, FSIC, JD MED (6-PIN)	\$86.70
47258181	23760366	Yale, FSIC, JD YA6 (6-PIN) - (Compatible with Medeco 31)	\$47.40
47258184	23929722	Yale, FSIC, JD YA7 (7-PIN)	\$32.00
23446347	23446347	Universal, SFIC, GD/HD	\$13.70
47258185	new	Corbin Russwin, KIL LD CO6	\$14.60

*This part is shared with Schlage mechanical and defaults to the Schlage mechanical discount.

Pricing/product description subject to change without notice.

New Part Number	Original Part Number	Description	List Price
Tailpiece (for cylinder) - (Select by Chassis Type, Cylinder OEM, Cylinder Type, Cylinder Detail) - (continued)			
Exit			
47258186	23538077	Schlage, KIL, PD/LD - (Everest/Primus/Modular Cylinders)	\$1.90*
	23538085	Schlage, KIL, PD/LD - (Classic Cylinders)	
23446339	23446339	Schlage, FSIC, JD/RD/TD	\$5.50
47258182	23779820	Falcon, KIL, LD FA7 (7-PIN)	\$24.10
47258187	46929456	Universal, SFIC, BD/BDC	\$15.60
23446347	N523-091	Universal, SFIC, GD/HD	\$13.70
47258180	23443435	Corbin Russwin, FSIC, JD CO6 (6-PIN)	\$37.10
	23854516	Corbin Russwin, FSIC, JD CO7 (7-PIN)	
47258179	23443427	Sargent, KIL, LD SAR (6-PIN)	\$5.70
47258180	23443435	Sargent, FSIC, JD SAR (6-PIN)	\$37.10
47258183	23810898	Medeco, FSIC, JD MED (6-PIN)	\$86.70
47258181	23760366	Yale, FSIC, JD YA6 (6-PIN) - (Compatible with Medeco 31)	\$47.40
47258184	23929722	Yale, FSIC, JD YA7 (7-PIN)	\$32.00
23446347	23446347	Universal, SFIC, GD/HD	\$15.60
47258187	09-774	Universal, SFIC, BD/BDC	\$13.70
47258185	new	Corbin Russwin, KIL LD CO6	\$14.60

Tailpiece Kit - (for Exterior Escutcheon into Exit Device)

Exit Trim			
	46929303	Tailpiece Kit (Includes Tailpiece, Tailpiece Guide, Pine Tree Clip)	\$19.90

Tailpiece Kit, 10-Piece Bulk Pack - (Select by Chassis Type, Cylinder OEM, Cylinder Type, Cylinder Detail)

Cylindrical			
09-418	09-418	Schlage, KIL, PD/LD - (Classic Cylinders)	\$13.30
09-417	09-417	Schlage, KIL, PD/LD - (Everest/Primus/Modular Cylinders)	\$13.30
23790611	23790611	Falcon, KIL, PD/LD	\$22.60
Mortise			
09-418	46928768	Schlage, KIL, PD/LD - (Classic Cylinders)	\$13.30
09-417	46928776	Schlage, KIL, PD/LD - (Everest/Primus/Modular Cylinders)	\$13.30
23790611	new	Falcon, KIL, PD/LD	\$22.60
Exit			
09-418	46928768	Schlage, KIL, PD/LD - (Classic Cylinders)	\$13.30
09-417	46928776	Schlage, KIL, PD/LD - (Everest/Primus/Modular Cylinders)	\$13.30
23790611	new	Falcon, KIL, PD/LD	\$22.60

*This part is shared with Schlage mechanical and defaults to the Schlage mechanical discount.

New Part Number	Original Part Number	Description	List Price
Cylinder - (Select by Chassis Type, Cylinder Mechanism, Cylinder Type, Cylinder Detail)			
Cylindrical			
	23-013	Classic, KIL, PD - (Only ATH, 8AT Lever Styles)	\$64.00*
	23-030	Classic, FSIC, RD - (Open)	\$73.00*
	23-030	Classic, FSIC, AD - (Restricted)	\$92.00*
	20-750	Primus, KIL, PD - (Only ATH, 8AT Lever Styles)	\$141.00*
	20-740	Primus, FSIC, RD	\$152.00*
	20-550	Primus UL, KIL, PD - (Only ATH, 8AT Lever Styles)	\$174.00*
	20-750-XP	Primus XP, KIL, PD - (Only ATH, 8AT Lever Styles)	\$141.00*
	20-740-XP	Primus XP, FSIC, RD	\$152.00*
	20-550-XP	Primus UL XP, KIL, PD - (Only ATH, 8AT Lever Styles)	\$174.00*
Mortise			
	23-118	Classic, KIL, PD - (Except ATH, 8AT Lever Styles)	\$64.00*
	23-118	Classic, KIL, PD - (Except ATH, 8AT Lever Styles) (Restricted)	\$81.50*
	23-030	Classic, FSIC, RD	\$73.00*
	20-854	Primus, KIL, PD - (Except ATH, 8AT Lever Styles)	\$141.00*
	20-740	Primus, FSIC, RD	\$152.00*
	20-554	Primus UL, KIL, PD - (Except ATH, 8AT Lever Styles)	\$174.00*
	20-854-XP	Primus XP, KIL, PD - (Except ATH, 8AT Lever Styles)	\$141.00*
	20-740-XP	Primus XP, FSIC, RD	\$152.00*
	20-554-XP	Primus UL XP, KIL, PD - (Except ATH, 8AT Lever Styles)	\$174.00*
Exit			
	23-118	Classic, KIL, PD - (Except ATH, 8AT Lever Styles)	\$64.00*
	23-118	Classic, KIL, PD - (Except ATH, 8AT Lever Styles) (Restricted)	\$81.50*
	23-030	Classic, FSIC, RD	\$73.00*
	20-854	Primus, KIL, PD - (Except ATH, 8AT Lever Styles)	\$141.00*
	20-750	Primus, KIL, PD - (Only ATH, 8AT Lever Styles)	\$141.00*
	20-740	Primus, FSIC, RD	\$152.00*
	20-554	Primus UL, KIL, PD - (Except ATH, 8AT Lever Styles)	\$174.00*
	20-550	Primus UL, KIL, PD - (Only ATH, 8AT Lever Styles)	\$174.00*
	20-854-XP	Primus XP, KIL, PD - (Except ATH, 8AT Lever Styles)	\$141.00*
	20-750-XP	Primus XP, KIL, PD - (Only ATH, 8AT Lever Styles)	\$141.00*
	20-740-XP	Primus XP, FSIC, RD	\$152.00*
	20-554-XP	Primus UL XP, KIL, PD - (Except ATH, 8AT Lever Styles)	\$174.00*
	20-550-XP	Primus UL XP, KIL, PD - (Only ATH, 8AT Lever Styles)	\$174.00*
Interior Lever (Closed) - (Please specify STYLE and FINISH - Example: 03-030-SPA-626)			
03-230	03-030	Inside Lever, Closed - ATH, RHO, SPA, TLR	\$136.00

*This part is shared with Schlage mechanical and defaults to the Schlage mechanical discount.

New Part Number	Original Part Number	Description	List Price
Exterior Lever (Less Cylinder) -			
(Select by Chassis Type, Cylinder OEM, Cylinder Type, Cylinder Detail) - (Please specify STYLE and FINISH - Example: 03-031-SPA-626)			
Cylindrical			
03-231	03-031	Schlage, KIL, PD/LD	\$136.00
03-232	03-032	Schlage, FSIC, RD/JD	\$136.00
03-200	03-000	Schlage, SFIC, GD/BD	\$136.00
03-280	23779739 (RHO)	Falcon, KIL, LD FA7 (7-PIN)	\$144.00
	23779762 (SPA)		
	23779747 (8RO)		
	23779770 (8SP)		
03-266	03-066	Corbin Russwin, FSIC, JD CO6 (6-PIN)	\$252.00
03-235	23854524 (RHO)	Corbin Russwin, FSIC, JD CO7 (7-PIN)	\$252.00
	23854540 (SPA)		
	23854565 (TLR)		
	23854532 (8RO)		
	23854557 (8SP)		
	23854573 (8TR)		
03-244	03-044	Sargent, KIL, LD SAR (6-PIN)	\$252.00
03-277	03-077	Sargent, FSIC, JD SAR (6-PIN)	\$252.00
03-237	09-388	Medeco, FSIC, JD MED (6-PIN)	\$252.00
03-255	09-355	Yale, FSIC, JD YA6 (6-PIN)	\$252.00
03-236	09-399	Yale, FSIC, JD YA7 (7-PIN)	\$252.00
03-234	NEW	Corbin Russwin, KIL, LD CO6 (6-PIN)	\$252.00
New Lever Options			
47258044	NEW	BOARDWALK - Closed	\$136.00
47258052	NEW	BOARDWALK - JD	\$136.00
47258048	NEW	BOARDWALK - PD/LD	\$136.00
47258040	NEW	BOARDWALK - BDC/BD/GD/HD	\$136.00
47258043	NEW	BROADWAY - Closed	\$136.00
47258051	NEW	BROADWAY - JD	\$136.00
47258047	NEW	BROADWAY - PD/LD	\$136.00
47258039	NEW	BROADWAY - BDC/BD/GD/HD	\$136.00
47258045	NEW	LATITUDE - Closed	\$136.00
47258053	NEW	LATITUDE - JD	\$136.00
47258049	NEW	LATITUDE - PD/LD	\$136.00
47258041	NEW	LATITUDE - BDC/BD/GD/HD	\$136.00
47258046	NEW	LONGITUDE - Closed	\$136.00
47258054	NEW	LONGITUDE - JD	\$136.00
47258050	NEW	LONGITUDE - PD/LD	\$136.00
47258042	NEW	LONGITUDE - BDC/BD/GD/HD	\$136.00
47260554	NEW	BOARDWALK (TACTILE) - Closed	\$182.00
47260546	NEW	BOARDWALK (TACTILE) - JD	\$182.00
47260550	NEW	BOARDWALK (TACTILE) - PD/LD	\$182.00
47260538	NEW	BOARDWALK (TACTILE) - BDC/BD/GD/HD	\$182.00
47260553	NEW	BROADWAY (TACTILE) - Closed	\$182.00
47260545	NEW	BROADWAY (TACTILE) - JD	\$182.00
47260549	NEW	BROADWAY (TACTILE) - PD/LD	\$182.00
47260537	NEW	BROADWAY (TACTILE) - BDC/BD/GD/HD	\$182.00
47260555	NEW	LATITUDE (TACTILE) - Closed	\$182.00
47260547	NEW	LATITUDE (TACTILE) - JD	\$182.00
47260551	NEW	LATITUDE (TACTILE) - PD/LD	\$182.00
47260539	NEW	LATITUDE (TACTILE) - BDC/BD/GD/HD	\$182.00
47260556	NEW	LONGITUDE (TACTILE) - Closed	\$182.00
47260548	NEW	LONGITUDE (TACTILE) - JD	\$182.00
47260552	NEW	LONGITUDE (TACTILE) - PD/LD	\$182.00
47260540	NEW	LONGITUDE (TACTILE) - BDC/BD/GD/HD	\$182.00
Mortise			
03-231	09-331	Schlage, KIL, PD/LD	\$136.00
03-232	09-332	Schlage, FSIC, RD/JD	\$136.00
03-200	03-000	Schlage, SFIC, GD/BD	\$136.00
03-280	09-331	Falcon, KIL, LD FA7 (7-PIN)	\$144.00
03-266	09-366	Corbin Russwin, FSIC, JD CO6 (6-PIN)	\$252.00
03-235	09-366	Corbin Russwin, FSIC, JD CO7 (7-PIN)	\$252.00
03-244	09-344	Sargent, KIL, LD SAR (6-PIN)	\$252.00
03-277	09-377	Sargent, FSIC, JD SAR (6-PIN)	\$252.00
03-237	09-388	Medeco, FSIC, JD MED (6-PIN)	\$252.00

Pricing/product description subject to change without notice.

New Part Number	Original Part Number	Description	List Price
Exterior Lever (Less Cylinder) -			
(Select by Chassis Type, Cylinder OEM, Cylinder Type, Cylinder Detail) - (Please specify STYLE and FINISH - Example: 03-031-SPA-626)			
Mortise (Continued)			
03-255	09-355	Yale, FSIC, JD YA6 (6-PIN)	\$252.00
03-236	09-399	Yale, FSIC, JD YA7 (7-PIN)	\$252.00
03-234	NEW	Corbin Russwin, KIL, LD CO6 (6-PIN)	\$252.00
New Lever Options			
47258044	NEW	BOARDWALK - Closed	\$136.00
47258052	NEW	BOARDWALK - JD	\$136.00
47258048	NEW	BOARDWALK - PD/LD	\$136.00
47258040	NEW	BOARDWALK - BDC/BD/GD/HD	\$136.00
47258043	NEW	BROADWAY - Closed	\$136.00
47258051	NEW	BROADWAY - JD	\$136.00
47258047	NEW	BROADWAY - PD/LD	\$136.00
47258039	NEW	BROADWAY - BDC/BD/GD/HD	\$136.00
47258045	NEW	LATITUDE - Closed	\$136.00
47258053	NEW	LATITUDE - JD	\$136.00
47258049	NEW	LATITUDE - PD/LD	\$136.00
47258041	NEW	LATITUDE - BDC/BD/GD/HD	\$136.00
47258046	NEW	LONGITUDE - Closed	\$136.00
47258054	NEW	LONGITUDE - JD	\$136.00
47258050	NEW	LONGITUDE - PD/LD	\$136.00
47258042	NEW	LONGITUDE - BDC/BD/GD/HD	\$136.00
47260554	NEW	BOARDWALK (TACTILE) - Closed	\$182.00
47260546	NEW	BOARDWALK (TACTILE) - JD	\$182.00
47260550	NEW	BOARDWALK (TACTILE) - PD/LD	\$182.00
47260538	NEW	BOARDWALK (TACTILE) - BDC/BD/GD/HD	\$182.00
47260553	NEW	BROADWAY (TACTILE) - Closed	\$182.00
47260545	NEW	BROADWAY (TACTILE) - JD	\$182.00
47260549	NEW	BROADWAY (TACTILE) - PD/LD	\$182.00
47260537	NEW	BROADWAY (TACTILE) - BDC/BD/GD/HD	\$182.00
47260555	NEW	LATITUDE (TACTILE) - Closed	\$182.00
47260547	NEW	LATITUDE (TACTILE) - JD	\$182.00
47260551	NEW	LATITUDE (TACTILE) - PD/LD	\$182.00
47260539	NEW	LATITUDE (TACTILE) - BDC/BD/GD/HD	\$182.00
47260556	NEW	LONGITUDE (TACTILE) - Closed	\$182.00
47260548	NEW	LONGITUDE (TACTILE) - JD	\$182.00
47260552	NEW	LONGITUDE (TACTILE) - PD/LD	\$182.00
47260540	NEW	LONGITUDE (TACTILE) - BDC/BD/GD/HD	\$182.00
Exit			
03-231	03-331	Schlage, KIL, PD/LD	\$136.00
03-232	03-332	Schlage, FSIC, RD/JD	\$136.00
03-200	03-300	Schlage, SFIC, GD/BD	\$136.00
03-280	03-331	Falcon, KIL, LD FA7 (7-PIN)	\$144.00
03-266	03-366	Corbin Russwin, FSIC, JD CO6 (6-PIN)	\$252.00
03-235	03-366	Corbin Russwin, FSIC, JD CO7 (7-PIN)	\$252.00
03-244	03-344	Sargent, KIL, LD SAR (6-PIN)	\$252.00
03-277	03-377	Sargent, FSIC, JD SAR (6-PIN)	\$252.00
03-237	03-388	Medeco, FSIC, JD MED (6-PIN)	\$252.00
03-255	03-355	Yale, FSIC, JD YA6 (6-PIN)	\$252.00
03-236	03-399	Yale, FSIC, JD YA7 (7-PIN)	\$252.00
03-234		Corbin Russwin, KIL, LD CO6 (6-PIN)	\$252.00
New Lever Options			
47258044	NEW	BOARDWALK - Closed	\$136.00
47258052	NEW	BOARDWALK - JD	\$136.00
47258048	NEW	BOARDWALK - PD/LD	\$136.00
47258040	NEW	BOARDWALK - BDC/BD/GD/HD	\$136.00
47258043	NEW	BROADWAY - Closed	\$136.00
47258051	NEW	BROADWAY - JD	\$136.00
47258047	NEW	BROADWAY - PD/LD	\$136.00
47258039	NEW	BROADWAY - BDC/BD/GD/HD	\$136.00
47258045	NEW	LATITUDE - Closed	\$136.00
47258053	NEW	LATITUDE - JD	\$136.00

Pricing/product description subject to change without notice.

New Part Number	Original Part Number	Description	List Price
Exterior Lever (Less Cylinder) -			
(Select by Chassis Type, Cylinder OEM, Cylinder Type, Cylinder Detail) - (Please specify STYLE and FINISH - Example: 03-031-SPA-626)			
New Lever Options (Continued)			
47258049	NEW	LATITUDE - PD/LD	\$136.00
47258041	NEW	LATITUDE - BDC/BD/GD/HD	\$136.00
47258046	NEW	LONGITUDE - Closed	\$136.00
47258054	NEW	LONGITUDE - JD	\$136.00
47258050	NEW	LONGITUDE - PD/LD	\$136.00
47258042	NEW	LONGITUDE - BDC/BD/GD/HD	\$136.00
47260554	NEW	BOARDWALK (TACTILE) - Closed	\$182.00
47260546	NEW	BOARDWALK (TACTILE) - JD	\$182.00
47260550	NEW	BOARDWALK (TACTILE) - PD/LD	\$182.00
47260538	NEW	BOARDWALK (TACTILE) - BDC/BD/GD/HD	\$182.00
47260553	NEW	BROADWAY (TACTILE) - Closed	\$182.00
47260545	NEW	BROADWAY (TACTILE) - JD	\$182.00
47260549	NEW	BROADWAY (TACTILE) - PD/LD	\$182.00
47260537	NEW	BROADWAY (TACTILE) - BDC/BD/GD/HD	\$182.00
47260555	NEW	LATITUDE (TACTILE) - Closed	\$182.00
47260547	NEW	LATITUDE (TACTILE) - JD	\$182.00
47260551	NEW	LATITUDE (TACTILE) - PD/LD	\$182.00
47260539	NEW	LATITUDE (TACTILE) - BDC/BD/GD/HD	\$182.00
47260556	NEW	LONGITUDE (TACTILE) - Closed	\$182.00
47260548	NEW	LONGITUDE (TACTILE) - JD	\$182.00
47260552	NEW	LONGITUDE (TACTILE) - PD/LD	\$182.00
47260540	NEW	LONGITUDE (TACTILE) - BDC/BD/GD/HD	\$182.00

*This part is shared with Schlage mechanical and defaults to the Schlage mechanical discount.

New Part Number	Original Part Number	Description	List Price
Exterior Lever (Less Cylinder), 10-Piece Bulk Pack -			
(Select by Chassis Type, Cylinder OEM, Cylinder Type, Cylinder Detail) - (Please specify STYLE and FINISH - Example: K103-031-SPA-626)			
Cylindrical			
K103-681	K103-031	Schlage, KIL, PD/LD	\$1,044.00*
K103-682	K103-032	Schlage, FSIC, RD/JD	\$1,244.00*
K103-680	K103-000	Schlage, SFIC, GD/BD	\$1,244.00*
K103-684	K103-066	Corbin Russwin, FSIC, JD CO6 (6-PIN)	\$1,995.00*
K103-683	K103-044	Sargent, KIL, LD SAR (6-PIN)	\$2,479.00*
K103-685	K103-077	Sargent, FSIC, JD SAR (6-PIN)	\$1,995.00*
K103-687	K109-388	Medeco, FSIC, JD MED (6-PIN)	\$2,482.00*
K103-686	K103-055	Yale, FSIC, JD YA6 (6-PIN)	\$2,482.00*
K103-688	K109-399	Yale, FSIC, JD YA7 (7-PIN)	\$2,482.00*
K103-689	NEW	Falcon, KIL, LD FA7 (7-PIN)	\$1,995.00
K103-690	23991086 (RHO)	Corbin Russwin, FSIC, JD CO7 (7-PIN)	\$1,995.00
	23991094 (SPA)		
	23991102 (TLR)		
	23991110 (8RO)		
	23991128 (8SP)		
	23991136 (8TR)		
Mortise			
K103-681	K109-331	Schlage, KIL, PD/LD	\$1,044.00*
K103-682	K109-332	Schlage, FSIC, RD/JD	\$1,244.00*
K103-680	K103-000	Schlage, SFIC, GD/BD	\$1,244.00*
K103-684	K109-366	Corbin Russwin, FSIC, JD CO6 (6-PIN)	\$1,995.00*
K103-683	K109-344	Sargent, KIL, LD SAR (6-PIN)	\$2,479.00*
K103-685	K109-377	Sargent, FSIC, JD SAR (6-PIN)	\$1,995.00*
K103-687	K109-388	Medeco, FSIC, JD MED (6-PIN)	\$2,482.00*
K103-686	K109-355	Yale, FSIC, JD YA6 (6-PIN)	\$2,482.00*
K103-688	K109-399	Yale, FSIC, JD YA7 (7-PIN)	\$2,482.00*
K103-689	K109-331	Falcon, KIL, LD FA7 (7-PIN)	\$1,995.00
K103-690	K109-366	Corbin Russwin, FSIC, JD CO7 (7-PIN)	\$1,995.00
Exit			
K103-681	K103-331	Schlage, KIL, PD/LD	\$1,044.00*
K103-682	K103-332	Schlage, FSIC, RD/JD	\$1,244.00*
K103-680	K103-000	Schlage, SFIC, GD/BD	\$1,244.00*
K103-689	K103-331	Falcon, KIL, LD FA7 (7-PIN)	\$1,995.00
K103-684	K103-366	Corbin Russwin, FSIC, JD CO6 (6-PIN)	\$1,995.00
K103-690	K103-366	Corbin Russwin, FSIC, JD CO7 (7-PIN)	\$1,995.00
K103-683	K103-344	Sargent, KIL, LD SAR (6-PIN)	\$2,479.00*
K103-685	K103-377	Sargent, FSIC, JD SAR (6-PIN)	\$1,995.00*
K103-687	K103-388	Medeco, FSIC, JD MED (6-PIN)	\$2,479.00
K103-686	K103-355	Yale, FSIC, JD YA6 (6-PIN)	\$2,479.00*
K103-688	K103-399	Yale, FSIC, JD YA7 (7-PIN)	\$2,479.00*
Steel Lever Kits & Parts			
Obsolete	24274730-AD	Steel Lever Conversion Kit - (Includes Escutcheon Assembly, Spring Cage Assembly, Lever Rotation Stops, Screws, Instructions) - Please specify CLASS, READER, FINISH)	Obsolete
Obsolete	47250325	Stainless Steel Set Screw for outside Steel Levers (Package of 20)	Obsolete

*This part is shared with Schlage mechanical and defaults to the Schlage mechanical discount.

Part Number	Description	List Price
Interior Rose - (Please specify FINISH - Example: 03-042-RHO-626)		
03-042-RHO-626	Interior Rose - (626 Finish)	\$121.00
03-042-RHO	Interior Rose - (605/606/612/619/625/643e Finishes)	\$124.00
03-042-RHO-613	Interior Rose - (613 Finish)	\$129.00
Lock Retractor - (Select by Chassis Type, Chassis Thickness)		
Cylindrical		
46928800	Retractor	\$333.00
Mortise		
46928818	1-1/16" Narrow - (Door Thicknesses 1-3/8" to 1-5/8")	\$428.00
46928826	1-1/4" Standard - (Door Thicknesses 1-3/4" to 2-3/4")	\$428.00
Mortise Deadbolt		
46928834	1-1/16" Narrow - (Door Thicknesses 1-3/8" to 1-5/8")	\$542.00
46928842	1-1/4" Standard - (Door Thicknesses 1-3/4" to 2-3/4")	\$542.00
Spindle & Hub Kit - (Select by Chassis Type)		
Exit		
46929295	Exit Spindle & Hub Kit (Includes Spindle, Spindle Cover, Spindle Hub, Tailpiece, Twisted Tailpiece, Tailpiece Spring, Pine Tree Clip, Screw)	\$41.60
Spindle Spring		
47256978	Inside Spindle Spring (25 Pack)	\$77.00
Hub, 10-Piece Bulk Pack - (Select by Chassis Type)		
Cylindrical		
23599228	Hub (10-Piece Bulk Pack)	\$152.00
Mortise		
23599228	Hub (10-Piece Bulk Pack)	\$152.00
Deadbolt Thumb Turn Assembly (with E-Clip) - (Please specify FINISH - Example: 46929113-626)		
46929113	Deadbolt Thumb Turn Assembly (with E-Clip)	\$33.40
Strike Plate (Select by Chassis Type) - (Please specify FINISH-SHAPE and LIP - Example: 10-025-0118-0626)		
Cylindrical		
10-025-1316	ANSI, no box, 1-1/4" x 4-7/8", Standard with 1-3/16" Lip	\$15.20*
10-025-138	ANSI, no box, 1-1/4" x 4-7/8", Standard with 1-3/8" Lip	\$43.70*
10-025-112	ANSI, no box, 1-1/4" x 4-7/8", Standard with 1-1/2" Lip	\$43.70*
10-013-118	Square corner, T-strike, box, 1-1/8" x 2-3/4" with 1-1/8" Lip	\$11.80*
10-013-112	Square corner, T-strike, box, 1-1/8" x 2-3/4" with 1-1/2" Lip	\$16.50*
10-016	Square corner, T-strike, deep box, 1-1/8" x 2-3/4" with 1-1/8" Lip Use with Fire door latch	\$15.70*
K510-066	Box ANSI strike	\$7.20*
Mortise Deadbolt		
10-072-1316	1-1/4" x 4-7/8" Square corner, box, standard with Lip at 1-3/16", 1", 1-1/2",	\$22.50*
10-072-xx	1-1/4" x 4-7/8" Square corner, box, specify lip length (xx) as 1" or 1-1/2"	\$22.50*
10-072-xx	1-1/4" x 4-7/8" Square corner, box, specify lip length (xx) as 1", 1-3/4", or 2"	\$57.50*
10-075	1/2" Rabbeted	\$148.00*
37-015	Strike frame reinforcer	\$25.00*
XL11-820	Strike, One hole for latching Functions, RH & LHR door, 1-3/16" Lip	\$42.70*
XL11-821	Strike, One hole for latching Functions, LH & RHR door, 1-3/16" Lip	\$42.70*
Mortise Armor Front - (Select by Width, Door Thickness) - (Please specify FINISH: 09-663-626)		
09-663	Armor, 1-1/4" Wide Square Corner, Latch x Auxiliary latch (for door range 1-3/4" to 2-3/4")	\$37.00*
09-666	Armor, 1-1/4" Wide Square Corner, Latch x Auxiliary latch x Deadbolt (for door range 1-3/4" to 2-3/4")	\$37.00*
09-669	Armor, 1-1/16" Wide Square Corner, Latch x Auxiliary latch (for door range 1-3/8" to 1-5/8")	
09-672	Armor, 1-1/16" Wide Square Corner, Latch x Auxiliary latch x Deadbolt (for door range 1-3/8" to 1-5/8")	\$37.00*

*This part is shared with Schlage mechanical and defaults to the Schlage mechanical discount.

Part Number	Description	List Price
Door Thickness Kit - (Select by Chassis Type, Door Thickness) - (Please specify Door Thickness - Example: 23599376-134 for 1-3/4")		
Cylindrical		
23599376-138	1-3/8" Door Thickness Kit (Includes Baseplate Screws, Reader Screws, Spindles, Spring, Pin Wrench, Fire Plate Screw, Shim Plates, Standoffs)	\$163.00
23599376-112	1-1/2" Door Thickness Kit (Includes Baseplate Screws, Reader Screws, Spindles, Spring, Pin Wrench, Fire Plate Screw, Shim Plates, Standoffs)	\$116.00
23599376-158	1-5/8" Door Thickness Kit (Includes Baseplate Screws, Reader Screws, Spindles, Spring, Pin Wrench, Fire Plate Screw, Shim Plates, Standoffs)	\$83.20
23599376-XXX	Door Thickness Kit (Includes Baseplate Screws, Reader Screws, Spindles, Spring, Pin Wrench, Fire Plate Screw, Shim Plates, Standoffs) Must specify door thickness: 1-3/4" to 2-3/4" in 1/8" increments (EXAMPLE: 23599376-134 for a 1-3/4" door)	\$50.00
Mortise		
23599384-138	1-3/8" Door Thickness Kit (Includes Baseplate Screws, Reader Screws, Spindles, Spring, Pin Wrench, Fire Plate Screw, Shim Plates, Standoffs)	\$163.00
23599384-112	1-1/2" Door Thickness Kit (Includes Baseplate Screws, Reader Screws, Spindles, Spring, Pin Wrench, Fire Plate Screw, Shim Plates, Standoffs)	\$116.00
23599384-158	1-5/8" Door Thickness Kit (Includes Baseplate Screws, Reader Screws, Spindles, Spring, Pin Wrench, Fire Plate Screw, Shim Plates, Standoffs)	\$83.20
23599384-XXX	Door Thickness Kit (Includes Baseplate Screws, Reader Screws, Spindles, Spring, Pin Wrench, Fire Plate Screw, Shim Plates, Standoffs) Must specify door thickness: 1-3/4" to 2-3/4" in 1/8" increments (EXAMPLE: 23599384-134 for a 1-3/4" door)	\$50.00
Decorative Plate - (Select by Size) - (Please specify FINISH - Example: 23760283-626)		
23631823	1.5" x 3.25" x .105" Decorative Plate (with Screws) - (Exit Trim)	\$35.30
23760267	1.7" x 3.5" x .075" Decorative Plate (with Screws)	\$25.90
23760283	3.2" x 3.5" x .075" Decorative Plate (with Screws)	\$40.10
23760317	6.0" x 3.5" x .075" Decorative Plate (with Screws)	\$61.10
23760325	6.6" x 3.5" x .075" Decorative Plate (with Screws)	\$61.10
23760309	8.0" x 3.5" x .075" Decorative Plate (with Screws)	\$62.40
23760291	8.0" x 3.5" x .075" Decorative Plate (with Screws, Welded Standoffs)	\$84.50
23760259*	10.5" x 3.5" x .075" Decorative Plate (no Screws necessary) - (Under Lock)	\$81.00
23760275*	12.0" x 3.5" x .075" Decorative Plate (no Screws necessary) - (Under Lock)	\$70.20

*Please consider overall Door Thickness when ordering

Note: Single Decorative Plate. Interior and Exterior Decorative Plates may be required.

Note: Decorative Plates may have multiple applications. Please see AD-Series Retrofit Template Overlay guide at www.schlage.com/support for more information
Available Finishes: 626 Satin Chrome Standard. Please consult Customer Care for 605 Bright Brass or 643E Aged Bronze.

CO-Series Parts



Part Number	Description	List Price
Interior Shim Plate - (Please specify FINISH - Example: 23599368-626)		
23599368	Interior Shim Plate (with Interior Spring Cage Spacer) - (Device is 0.063" thick)	\$24.00
Exterior Shim Plate		
23458599	Exterior Shim Plate - (Device is 0.063" thick)	\$22.50
Door Position Switch		
46929121	Door Position Switch	\$31.60
Battery Holder & Cover Kit - (Select by Chassis Type, Battery Capacity) - (Please specify FINISH - Example: 4B-CM-626)		
Cylindrical		
4B-CM (23599202)	4AA Battery Holder & Cover Kit (Includes 4AA Battery Holder with Cable, 4AA Battery Strap, (2) Battery Strap Screws, 4AA Battery Cover, Cover Screw, Torx Cover Screw)	\$56.00
Mortise		
4B-CM (23599202)	4AA Battery Holder & Cover Kit (Includes 4AA Battery Holder with Cable, 4AA Battery Strap, (2) Battery Strap Screws, 4AA Battery Cover, Cover Screw, Torx Cover Screw)	\$56.00
Exit		
4B-E (23599285)	4AA Battery Holder & Cover Kit (Includes 4AA Battery Holder with Cable, 4AA Battery Strap, (2) Battery Strap Screws, 4AA Battery Cover, Cover Screw, Torx Cover Screw)	\$56.00
Battery Holder Kit		
46929063	4AA Battery Holder Kit (Includes 4AA Battery Holder with Cable, 4AA Battery Strap, Battery Strap Screws)	\$24.00
Battery - (Select by Battery Type)		
F206-488	(4) AA Batteries	\$10.70
Torx Tamper Screw Pack - (Select by Chassis Type)		
Cylindrical		
23631765	Torx Tamper Screw Pack	\$40.10
Mortise		
23631781	Torx Tamper Screw Pack	\$40.10
Exit		
23631799	Torx Tamper Screw Pack	\$32.00
Request-to-Exit Switch Kit		
RX-LC	Von Duprin RX-LC (also called SI-LC or Von Duprin part number 050281)	\$318.00
<i>Please see Falcon Price Book for Falcon AD part number 650359</i>		
Wireless Parts		
47250326	Terminal Block Kit - (Includes one power connector and ten I/O connectors) supports CT5000	\$44.40
Cables		
23518392	Storeroom (70) Thru-Door Cable	\$18.40
23518384	Privacy (40) & Office (50) Thru-Door Cable	\$29.80

Pricing/product description subject to change without notice.

ELECTROMAGNETIC LOCKS - TABLE OF CONTENTS	
M490 MAX SECURITY	234
M450 HIGH SECURITY	235
M420 TRAFFIC CONTROL SERIES	236
M490DE DEYLAIED EGRESS SERIES	237
M390RFK RETROFIT LOCK	238
FILLER PLATES AND ANGLE BRACKETS	239
ELECTROMAGNETIC SPECIALTY LOCKS	240
M490G Gate Lock	240
320M MiniLine Magnet Lock	240
GF3000 SHEAR LOCK MORTISE SERIES	241
GF3000 SHEAR LOCK SURFACE SERIES	242
ELECTROMAGNETIC LOCK PARTS	243

CONTACT INFORMATION FOR ELECTROMAGNETIC LOCKS

Payment Address: Schlage Electronic Security
 15934 Collections Center Drive
 Chicago, IL 60693

877-671-7011	
Customer Service:	Technical Support:
Order Status, Credit Returns of Non-Defective Products, General Sales Questions	Technical Questions/Issues, Returns of Defective Products, Repairs
Email Orders To: Order_Entry_Schlage_Commercial@allegion.com	Contact For Technical Assistance: Electronic_Lock_TechProdSupport@allegion.com

For Electromagnetic Lock Warranty Information please see page 10.

Pricing/product description subject to change without notice.

M490 Max Security Series with Limited Lifetime Warranty on Magnetic Coil Assembly

Standard Features:

- ANSI/BHMA 156.23 Grade 1
- UL 1034 listed for burglary resistance
- UL 10C listed; cUL
- UL 294 listed for access control system units
- CSFM California State Fire Marshal listed

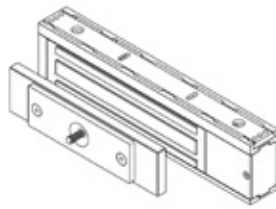

M490/M490P
Single Lock

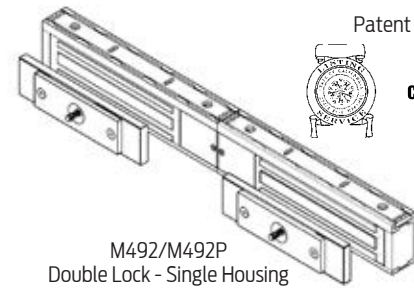

M492/M492P
Double Lock - Single Housing

Patent # 5,133,581



1. Select Model

	M490	M492
Electromagnetic Lock Automatic Voltage Selection	\$698.00	\$1,464.00
Electromagnetic Lock Automatic Voltage Selection Door Status Monitor (DSM), Magnetic Bond Sensor (MBS) Relocking Time Delay (RTD)	\$905.00	\$1,875.00

2. Select Options and Accessories

	M490/M490P		M492/M492P	
Anti-Tamper Switch (ATS), MBS indicator (LED) for M490P/M492P only	450/490-ATS/LED	\$77.80	450/490-ATS/LED-2	\$157.00
Herculite Door Bracket	HDB490	\$351.00	HDB490-2	\$706.00
Top Jamb (inswinging doors)	TJ490	\$170.00	TJ492	\$342.00
M452/M492 Connector Kit. (used to convert two (2) single mag locks to a double)	DBK450/490			\$64.90

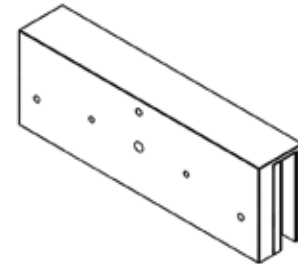
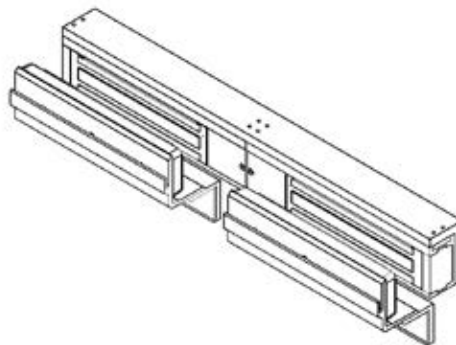
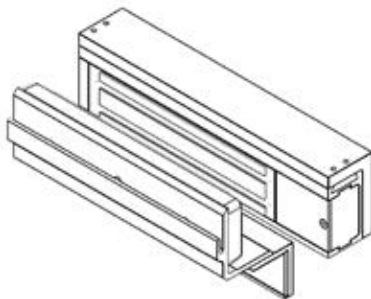

3. Select Filler Plates and Angle Brackets - Listed on page 239

Specifications	M490/M490P	M492/M492P
Holding Force	1500 lbs	1500 lbs per door leaf
Input Voltage	12/24 VDC	12/24 VDC
Current Draw Automatic Dual Voltage 12/24 VDC	.65A @ 12 VDC .35A @ 24 VDC	1.3A @ 12 VDC .7A @ 24 VDC
Height	3"	3"
Length	12-1/2"	25-1/16"
Width	3-3/4"	3-3/4"
Weight (Approximate)	14 lbs	28 lbs

M450 High Security Series with Limited Lifetime Warranty on Magnetic Coil Assembly

Standard Features:

- ANSI/BHMA 156.23 Grade 1
- UL 1034 listed for burglary resistance
- UL 10C listed; cUL
- UL 294 listed for access control system units
- CSFM California State Fire Marshal listed

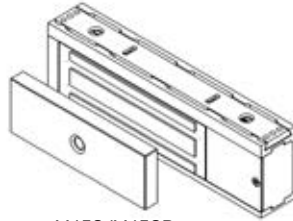

M450/M450P
Single Lock

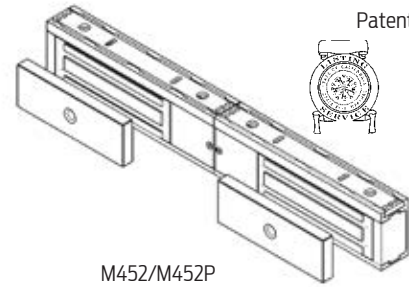

M452/M452P
Double Lock with Single Housing

Patent # 5,133,581



1. Select Model

	M450	M452
Electromagnetic Lock Automatic Voltage Selection	\$639.00	\$1,339.00
Electromagnetic Lock Automatic Voltage Selection Door Status Monitor (DSM), Magnetic Bond Sensor (MBS) Relocking Time Delay (RTD)	\$849.00	\$1,762.00

2. Select Options and Accessories

	M450/M450P		M452/M452P	
Anti-Tamper Switch (ATS), MBS indicator (LED) for M450P/M452P only	450/490-ATS/LED	\$78.00	450/490-ATS/LED-2	\$157.00
Herculite Door Bracket	HDB450	\$351.00	HDB450-2	\$706.00
Top Jamb (inswinging doors)	TJ450	\$170.00	TJ452	\$342.00
M452/M492 Connector Kit. (used to convert two (2) single mag locks to a double)	DBK450/490		64.90	

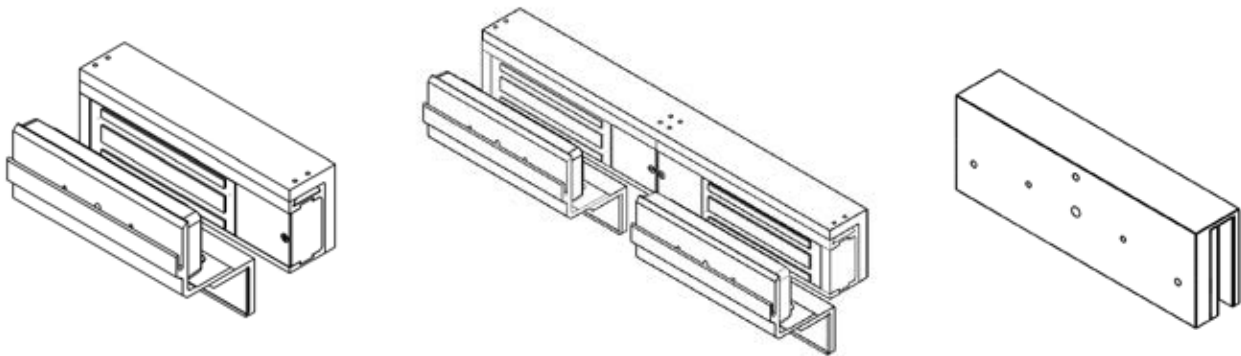

3. Select Filler Plates and Angle Brackets - Listed on page 239

Specifications	M450/M450P	M452/M452P
Holding Force	1000 lbs	1000 lbs per door leaf
Input Voltage	12/24 VDC	12/24 VDC
Current Draw Automatic Dual Voltage 12/24 VDC	.75A @ 12 VDC .38A @ 24 VDC	1.5A @ 12 VDC 0.75A @ 24 VDC
Height	3"	3"
Length	10-1/4"	20-9/16"
Width	1-3/4"	1-3/4"
Weight (Approximate)	10 lbs	20 lbs

Pricing/product description subject to change without notice.

**M420 Traffic Control Series
with Limited Lifetime Warranty
on Magnetic Coil Assembly**

Patent # 5,133,581

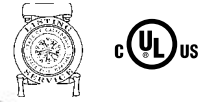

Standard Features:

- ANSI/BHMA 156.23 Grade 1
- UL 1034 listed for burglary resistance
- UL 10C listed; cUL
- UL 294 listed for access control system units
- CSFM California State Fire Marshal listed

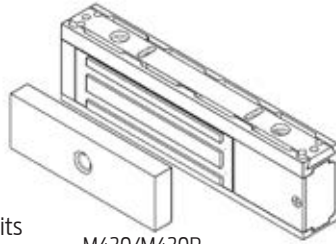

M420/M420P
Single Lock

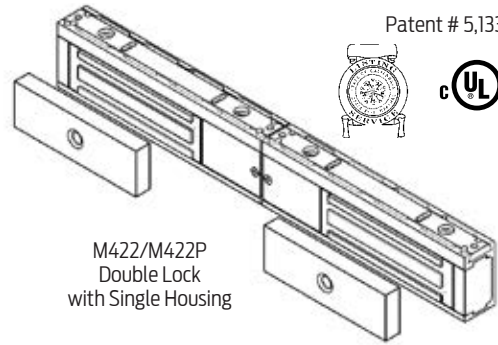

M422/M422P
Double Lock
with Single Housing

1. Select Model

	M420	M422
Electromagnetic Lock Automatic Voltage Selection	\$558.00	\$1,181.00
Electromagnetic Lock Automatic Voltage Selection Door Status Monitor (DSM), Magnetic Bond Sensor (MBS) Relocking Time Delay (RTD)	\$769.00	\$1,580.00

2. Select Options and Accessories

	M420/M420P		M422/M422P	
Anti-Tamper Switch (ATS), MBS indicator (LED) for M420P/M422P only	420-ATS/LED	\$78.00	420-ATS/LED-2	\$157.00
Herculite Door Bracket	HDB420	\$351.00	HDB420-2	\$706.00
Top Jamb (inswinging doors)	TJ420	\$170.00	TJ422	\$342.00
M422 Connector Kit. (used to convert two (2) single mag locks to a double)	DBK420			\$64.90

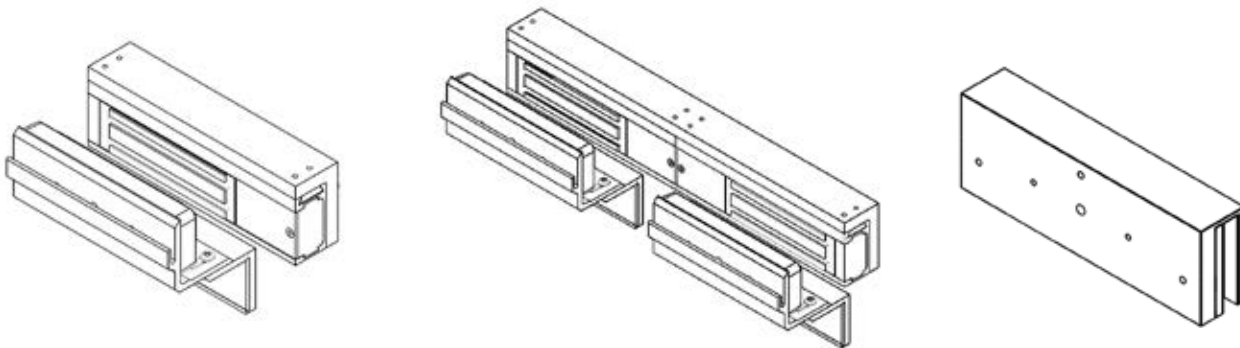

3. Select Filler Plates and Angle Brackets - Listed on page 239

Specifications	M420/M420P	M422/M422P
Holding Force	500 lbs	500 lbs per door leaf
Input Voltage	12/24 VDC	12/24 VDC
Current Draw Automatic Dual Voltage 12/24 VDC	.75A @ 12 VDC .38A @ 24 VDC	1.5A @ 12 VDC .76A @ 24 VDC
Height	2-1/2"	2-1/2"
Length	9"	18-1/16"
Width	1-3/8"	1-3/8"
Weight (Approximate)	6 lbs	12 lbs

Pricing/product description subject to change without notice.

Patent #'s 6,053,546/5,479,151/5,133,581



M490DE Delayed Egress Series with Limited Lifetime Warranty on Magnetic Coil Assembly

Standard Features

- Delayed egress with plunger switch and external switch input
- Designed to meet NFPA 101 Life Safety Code
- Automatic voltage selection
- UL294 Special locking arrangement including BOCA*
- ANSI/BHMA 156.24
- UL 10C listed; cUL
- CSFM California State Fire Marshal listed
- Authorized release input
- On-board audible alarm
- On-board bi-color LED
- Fire alarm terminals

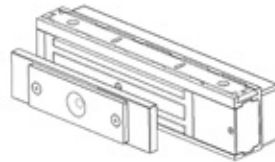

SINGLE LOCK

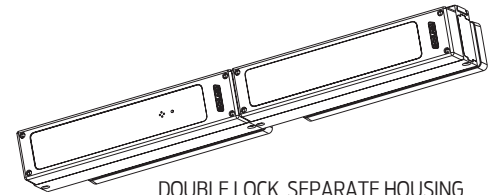

DOUBLE LOCK SEPARATE HOUSING

All 30 second delay requests, require a letter from the local fire marshal for approval or local jurisdiction.

1. Select Model	Factory Set Delay		Single Lock		Double Lock	
	15 sec	30 sec				
Electromagnetic Delayed Egress Lock (DE)	X		M490DE	\$1,502.00	M490DE-2	\$2,940.00
		X	M490DE-30S	\$1,553.00	M490DE-2-30S	\$2,991.00
Delayed Egress Plus (DEP)	X		M490DEP	\$2,254.00	M490DEP-2	\$4,357.00
Delayed Egress Plus (DEP)		X	M490DEP-30S	\$2,305.00	M490DEP-2-30S	\$4,808.00
Delayed Egress Plus, BOCA (DEP-BC)	X		M490DEP-BC	\$2,254.00	M490DEP-2-BC	\$4,357.00
Delayed Egress Plus, BOCA (DEP-BC)		X	M490DEP-BC30S	\$2,305.00	M490DEP-2-BC30S	\$4,408.00

* Plus (P): Door Status Monitor (DSM), Magnetic Bond Sensor (MBS), Relocking Time Delay (RTD)

* For BOCA option please contact Customer Care, only available on Plus (P) models

*PCB Kits (:15, :30 second) are sold separate for in-field updates. See parts section for M490DE, M490DEP and M490DEP BOCA kits.

* All 30 second delay requests (product / PCB kits), require a letter from the local fire marshal for approval or local jurisdiction.

2. Select Options and Accessories

	M490DE / M490DEP	M490DE-2 / M490DEP-2
Herculite (Glass) Door Bracket	HDB490 \$351.00	HDB490-2 \$706.00

3. Select Filler Plates and Angle Brackets - Listed on page 239

Specifications	M490DE/M490DEP	M490DE-2/M490DEP-2
Holding Force	1300 lbs	1300 lbs per door leaf
Input Voltage	12/24 VDC	12/24 VDC
Current Draw Automatic Dual Voltage 12/24 VDC	.75A @ 12 VDC .45A @ 24 VDC	1.25A @ 12 VDC 0.76A @ 24 VDC
Height	3"	3"
Length	12-1/2"	25-1/16"
Width	3-1/16"	3-1/16"
Weight (Approximate)	16 lbs	32 lbs

Pricing/product description subject to change without notice.

M390RFK Retrofit Lock with Limited Lifetime Warranty on Magnetic Coil Assembly

Patent # 5,133,581

Designed to retrofit Locknetics 390+ without any additional prep.

Standard Features:

- ANSI/BHMA 156.23 Grade 1
- UL 294 listed for access control systems units
- UL 10C listed; cUL
- CSFM California State Fire Marshal listed

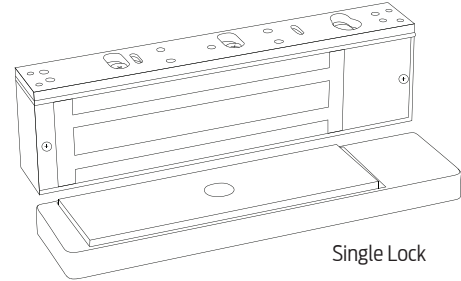

Single Lock

1. Select Model

	M390RFK
Electromagnetic Lock Automatic Voltage Selection, Magnetic Bond Sensor, Door Status Monitor, 628 satin aluminum finish	\$905.00

2. Specifications

	M390RFK
Holding Force	1500 lbs
Input Voltage	12/24 VDC
Current Draw Automatic Dual Voltage 12/24 VDC	.65A @ 12 VDC .45A @ 24 VDC
Height	2-7/8"
Length	10-1/2"
Width	1-5/8"
Weight (Approximate)	12.4 lbs

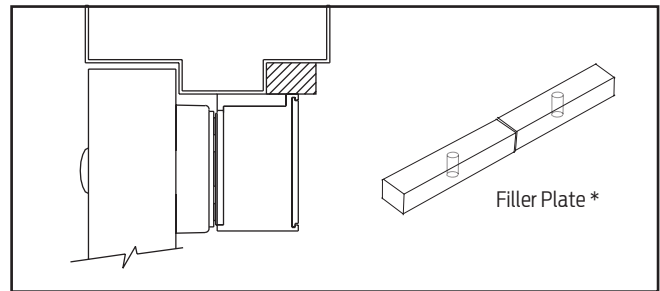
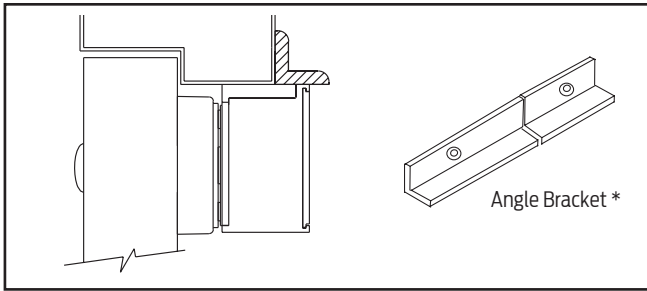

Angle Brackets

Length	M420		M450	
	9"		10-1/4"	
Width x Height	Bracket No.	Price Ea.	Bracket No.	Price Ea.
1" x 1"	4201A	\$84.00	4501A	\$84.00
1-1/2" x 1"	4202A	\$90.00	4502A	\$90.00
1-1/2" x 1-1/2"	4203A	\$95.00	4503A	\$95.00
1-1/2" x 2"	4204A	\$124.00	4504A	\$124.00
1-1/2" x 2-1/2"	4205A	\$150.00	4505A	\$150.00

Note: Overall lengths are cut to the appropriate magnet size.

Angle Brackets

Length	M490/M490DE		M490G Corrosion Resistant	
	12-1/2"		11"	
Width x Height	Bracket No.	Price Ea.	Bracket No.	Price Ea.
1" x 1"	4901A	\$84.00	49G1A	\$84.00
1-1/2" x 1"	4902A	\$90.00	49G2A	\$90.00
1-1/2" x 1-1/2"	4903A	\$95.00	49G3A	\$95.00
1-1/2" x 2"	4904A	\$124.00	49G4A	\$124.00
1-1/2" x 2-1/2"	4905A	\$150.00	49G5A	\$150.00

NOTE: Overall lengths are cut to the appropriate magnet size.

Filler Plates

Length	M420		M450	
	9"		10-1/4"	
Width x Height	Plate No.	Price Ea.	Plate No.	Price Ea.
1-1/4" x 1/8"	4201F	\$71.40	4501F	\$71.40
1-1/4" x 1/4"	4202F	\$71.40	4502F	\$71.40
1-1/4" x 3/8"	4203F	\$79.10	4503F	\$79.10
1-1/4" x 1/2"	4204F	\$79.10	4504F	\$79.10
1-1/4" x 5/8"	4205F	\$79.10	4505F	\$79.10
3/4" x 1/2"	4206F	\$79.10	4506F	\$79.10
3/4" x 5/8"	4207F	\$89.70	4507F	\$89.70
3/4" x 3/4"	4208F	\$89.70	4508F	\$89.70

Filler Plates

Length	M490/M490DE		M490G Corrosion Resistant	
	12-1/2"		11"	
Width x Height	Plate No.	Price Ea.	Plate No.	Price Ea.
1-1/4" x 1/8"	4901F	\$71.40	49G1F	\$71.40
1-1/4" x 1/4"	4902F	\$71.40	49G2F	\$71.40
1-1/4" x 3/8"	4903F	\$79.10	49G3F	\$79.10
1-1/4" x 1/2"	4904F	\$79.10	49G4F	\$79.10
1-1/4" x 5/8"	4905F	\$79.10	49G5F	\$79.10
3/4" x 1/2"	4906F	\$79.10	49G6F	\$79.10
3/4" x 5/8"	4907F	\$89.70	49G7F	\$89.70
3/4" x 3/4"	4908F	\$89.70	49G8F	\$89.70

Note: When ordering 422, 452 or 492 two Angle Brackets or Filler Plates are required.
Double bracket part # is no longer available convert two single brackets.

Pricing/product description subject to change without notice.

M490G Gate Lock with Limited Lifetime Warranty on Magnetic Coil Assembly

Standard Features

- Includes - universal mounting brackets - for swinging or sliding gate
- Special corrosion-resistant finish
- 1/2" EMT compression fitting
- Built in voltage spike suppression
- Door status monitor
- Magnetic Bond Sensor
- ANSI/BHMA 156.23, Outdoor Rated - Certified for use -31° to 151° F (-35° to 66° C)

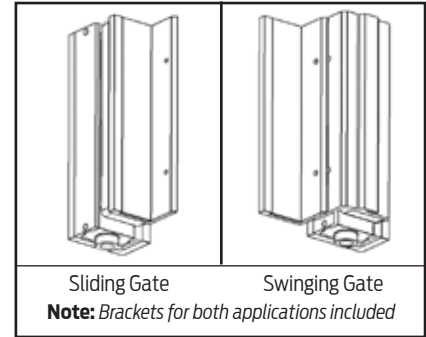

Specifications	M490G
Holding Force	1500 lbs
Input Voltage (Standard Unit)	12/24 VDC
Current Draw (Amps Standard Unit)	.65A @ 12 VDC
Dual Voltage Field Selectable	.35A @ 24 VDC
Height	3"
Length	11"
Width	1-3/4"
Weight (Approximate)	14 lbs

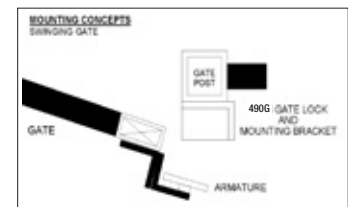
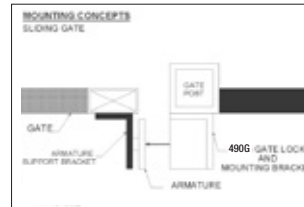

1. Select Model

M490G	Gate Lock	\$706.00
-------	-----------	----------

320M MiniLine Magnet Lock

with Limited Lifetime Warranty on Magnetic Coil Assembly

Standard Features

- Mortise mount for sliding doors
- Includes mounting tabs and armature mounting block
- Door status monitor and Magnetic Bond Sensor
- Adjustable relocking delay
- UL 10C listed; cUL
- CSFM California State Fire Marshal listed

Specifications	320M
Holding Force	500 lbs. @ 12 VDC; 650 lbs. @ 24 VDC
Input Voltage	12/24 VDC
Current Draw	.23A @ 12 VDC
(Dual Voltage Field Selectable)	.45A @ 24 VDC
Height	1-3/8"
Length	7"
Width	1-7/8"
Weight (Approximate)	6 lbs

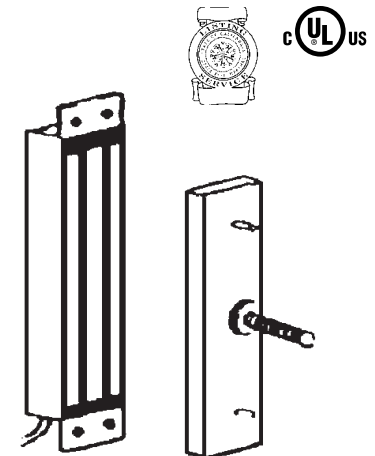

Note: For Wood Frames: Due to higher ambient operating temperatures, it is **REQUIRED** that the 12 VDC configuration be used.

1. Select Model

320M	Mini Line	\$600.00
------	-----------	----------

GF3000 Shear Lock Mortise Series with Limited Lifetime Warranty on Magnetic Coil Assembly

Patent # 6,611,414

Standard Features

- Microprocessor controlled
- Built-in auto relocking switch (ARS)
- Jump 1/4" gap - no in-rush current (noticeable noise level when connecting)
- Automatic voltage selection 12 VDC or 24 VDC
- Cool temperature regulator
- Adjustable time delay: 1-30 sec. from face of magnet
- ANSI/BHMA 156.23
- UL 10C listed; cUL
- CSFM California State Fire Marshal listed

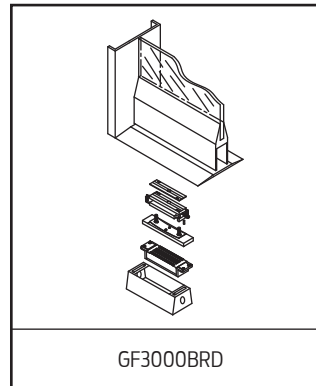
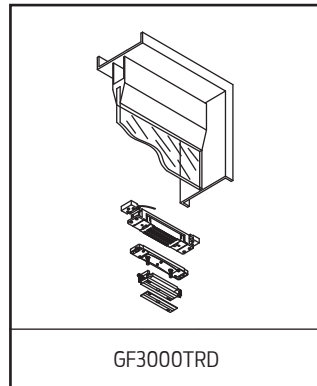
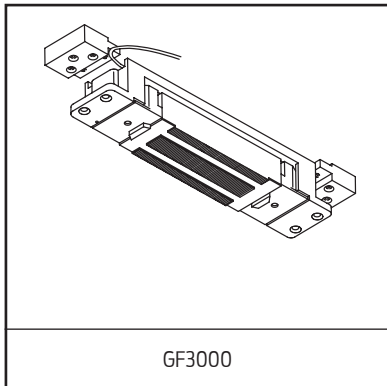

1. Select Model

GF3000	Standard Unit Adjustable from top edge of door	\$1,119.00
GF3000TRD	Top Rail Door Mounting assembly which provides armature adjustment from latch edge of door Recommended with zero clearance condition between top of door and ceiling	\$1,538.00
GF3000BRD	Bottom Rail Door Mounting assembly to mortise armature into bottom rail of door Magnet is installed in floor/threshold Provides solution when no top rail is available	\$1,650.00

2. Select Options

DSM/MBS	Door Status Monitor/Magnetic Bond Sensor	\$275.00
----------------	--	-----------------

Specifications

Holding Force	3000 lbs
Current Draw	0.90A @ 12 VDC 0.45A @ 24 VDC
Lock Size	9-1/2" L x 1-1/2" W x 1-1/2" H
Weight (Approximate)	7 lbs
w/ Mounting Tabs	11-9/16" L x 1-1/2" W x 1-1/2" H
Armature	8-3/8" L x 1-3/8" W x 1/2" D
Armature Bracket	10-5/8" L x 1-3/8" W x 1" D

Note: Filtered, regulated power supply recommended. See PS900 Series Power Supplies.

Pricing/product description subject to change without notice.

GF3000 Shear Lock Surface Series with Limited Lifetime Warranty on Magnetic Coil Assembly

Patent # 6,611,414



Standard Features

- Microprocessor controlled
- Built in auto relocking switch (ARS)
- Jump 1/4" gap - no in-rush current (noticeable noise when connecting)
- Automatic voltage selection 12 VDC or 24 VDC
- Cool temperature regulator
- Adjustable time delay, 0-30 sec. from face of magnet
- Satin black, anodized housing (not available in special finishes)
- ANSI/BHMA 156.23
- UL 10C listed; cUL
- CSFM California State Fire Marshal listed

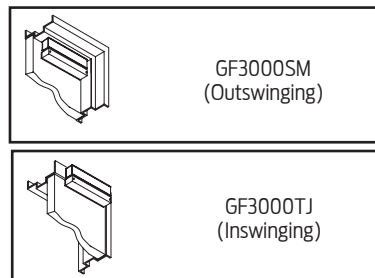
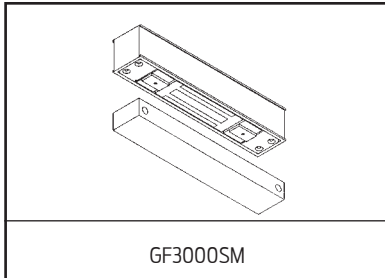

1. Select Model

GF3000SM	Standard Unit (outswinging doors) Adjustable from top edge of armature. Finish plates available in 628 Satin Aluminum, Clear Anodized Finish	\$1,364.00
GF3000TJ	Top Jamb Unit (inswinging doors) Magnet mounts on inside top jamb. Adjustable from top edge of armature Finish plates available in 628 Satin Aluminum, Clear Anodized Finish	\$1,364.00

2. Select Options

DSM/MBS	Door Status Monitor/Magnetic Bond Sensor	\$275.00
----------------	--	-----------------

Note: Housing available in satin black, anodized (335) finish only

Specifications

Holding Force	3000 lbs
Current Draw	0.90A @ 12 VDC 0.45A @ 24 VDC
Lock Housing	9-13/16" L x 1-1/4" W x 1-1/2" H
Armature Housing	8-3/8" L x 1-3/8" W x 1/2" D
Weight (Approximate)	9 lbs (SM, TJ suffix)

Note: Filtered, regulated power supply recommended See 900 Series Power Supplies

Part Number	Description	List
P44488484	PCB ASSY BASIC - w/ Tape	\$137.00
P44488492	PCB ASSY PLUS - w/ Tape	\$249.00
P23561665	M490 MTG PLATE	\$66.50
P23561954	M450 MTG PLATE	\$61.40
P23561962	M420 MTG PLATE	\$55.30
P44487825	M490 DEL 2 CABLE ASSY	\$124.00
P390498	SEX NUTS 5/16 INSIDE THREAD - 1-3/4" DOOR	\$16.50
P390498-2	SEX NUTS 5/16 INSIDE THREAD - 1-1/2" DOOR	\$79.90
P390498-5	SEX NUTS 5/16 INSIDE THREAD - 2" DOOR	\$110.00
P390498-6	SEX NUTS 5/16 INSIDE THREAD - 2-1/8" DOOR	\$130.00
P390498-7	SEX NUTS 5/16 INSIDE THREAD - 2-1/4" DOOR	\$130.00
P390498-8	SEX NUTS 5/16 INSIDE THREAD - 2-3/8" DOOR	\$131.00
P390498-9	SEX NUTS 5/16 INSIDE THREAD - 2-1/2" DOOR	\$132.00
P390498-11	SEX NUTS 5/16 INSIDE THREAD - 2-3/4" DOOR	\$148.00
P44489342	Armature TJ Fastener Pack	\$16.00
P23566821	Magnetic TJ Fastener Pack	\$16.00
P44489110	490 Armature Mounting Fastener Pack	\$22.50
P44489128	450/420 Armature Mounting Fastener Pack	\$29.70
P44488377	490/450 DBK - Double Magnet Connector Kit (Screw Mounting Pack Sold Separate)	\$80.20
P44488286	420 DBK - Double Magnet Connector Kit (Screw Mounting Pack Sold Separate)	\$80.20
P23879471	DE Cover Security Screw Pack	\$23.90
P23841067	M450/490 Cover Plate Kit	\$16.00
P23841075	M420 Cover Plate Kit	\$16.00
P23840283	M420 Mag MTG Pack	\$16.00
P23840291	M490/450 Mag MTG Pack	\$16.00
P23840911	M490DE PCB Cover Kit	\$84.60
P23840929	M490DE-S Cover Kit	\$76.50
P23840937	M490DEP PCB Kit (:15 Sec. Delay)	\$707.00
P47261542	M490DEP PCB Kit (:30 Sec Delay)	\$727.00
P23840945	M490DE PCB Kit (:15 Sec. Delay)	\$569.00
P47261543	M490DE PCB Kit (:30 Sec Delay)	\$589.00
P47244950	M490DE Arm Mount Fast Pack	\$19.80
P44487817	M490DE Cover Plate Assembly	\$47.20
P23840952	M490DEP BOCA PCB Kit (:15 Sec. Delay)	\$306.00
P47261544	M490DEP BOCA PCB Kit (:30 Sec Delay)	\$329.00
P23841208	HDB SCREW Kit	\$16.00
P23850357	Screw Pack - M400 Series Filler Plate - Angle Bracket	\$43.50
P23566359	M490 Armature Housing Assembly	\$87.00
P23561996	M450 Armature Housing Assembly	\$82.40
P23566888	M420 Armature Housing Assembly	\$81.00
P23561707	M490 Armature	\$249.00
P44489318	M450 Armature	\$116.00
P23562025	M420 Armature	\$88.00
P44487767	M490DEL Armature	\$255.00
P44488443	M490DE Basic Slave (DE Slave only)	\$1,437.00
P44488468	M490DEP Plus Slave (DE Plus Slave only)	\$2,103.00
P280037	GF3000 Armature Mounting Assembly TRD & BRD	\$185.00
P280043	GF3000BR Threshold Box	\$36.10
P280052	GF3000BRD Armature Assembly	\$126.00
P280053	GF3000BRD Mounting Hardware Pack	\$21.90
P280055	GF3000BRD Switch Kit ARSM	\$35.00
P280113	GF3000 Magnet Bracket	\$46.40
P280120	GF3000 Armature	\$124.00
P280124	GF3000 Armature Bracket	\$39.10
P280130-2	GF3000 Control Module	\$359.00
P280135	GF3000 Mounting Hardware Pack	\$63.90
P280147	GF3000TRD Armature Assembly	\$162.00
P300000	GF3000BRD Connector Assembly	\$11.30
P300001	GF3000 & TRD Connector Assembly	\$235.00
P679024	GF3000 DSM Switch	\$155.00

Pricing/product description subject to change without notice.

POWER SUPPLIES - TABLE OF CONTENTS	
PS902 POWER SUPPLIES AND OPTION BOARDS	246
PS904 POWER SUPPLIES AND OPTION BOARDS	247
PS906 POWER SUPPLIES AND OPTION BOARDS	248

CONTACT INFORMATION FOR POWER SUPPLIES & ACCESSORIES

Payment Address: Schlage Electronic Security
 15934 Collections Center Drive
 Chicago, IL 60693

877-671-7011	
Customer Service:	Technical Support:
Order Status, Credit Returns of Non-Defective Products, General Sales Questions	Technical Questions/Issues, Returns of Defective Products, Repairs
Email Orders To: Order_Entry_Schlage_Commercial@allegion.com	Contact For Technical Assistance: Electronic_Lock_TechProdSupport@allegion.com

For Power Supply Warranty Information please see page 12.

Pricing/product description subject to change without notice.

PS902 Power Supplies

2A @ 12/24 VDC – field selectable



Standard Features

- UL 294 Listed for Access Control
- Class2 rated power limited output
- Universal 120-240 VAC input
- Regulated and filtered DC outputs
- AC input and DC output LED indications
- Fire alarm relay and battery backup board attach to main board
- 1 Plug and play connector for optional distribution boards
- AC input status indication on outside cover
- AC status monitor
- 14" H x 12" W x 4" D enclosure

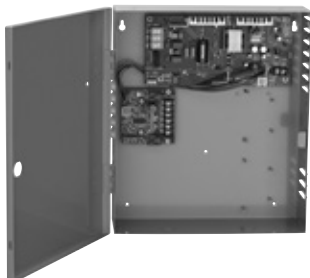

1. Select Power Supply

PS902	Base Power Supply (2A @ 12/24 VDC- field selectable) (approx. weight: 9 lbs) -PS902 is able to accept a total of one optional distribution board, plus one fire alarm relay along with one battery backup board and up to two 7A/hr batteries	\$278.00
--------------	--	-----------------

2. Select Optional Distribution Board with or without FA (Fire Alarm Relay)

1.	900-4R - 4 independently controlled relays	\$186.00
1.	900-4R FA - 4 independently controlled relays with FA	\$253.00
2.	900-2RS - 2 relay EL panic device control board	\$172.00
2.	900-2RS FA - 2 relay output with FA	\$239.00
3.	900-4RL - 4 relay board with integrated logic for controlling security interlocks, auto operators, and time delays	\$509.00
3.	900-4RL FA - 4 relay board with integrated logic for controlling security interlocks, auto operators, and time delays with FA	\$576.00
4.	900-8F - 8 fuse protected outputs	\$66.00
4.	900-8F FA - 8 fuse protected outputs with FA	\$133.00
5.	900-8P - 8 PTC protected outputs	\$66.00
5.	900-8P FA - 8 PTC protected outputs with FA	\$133.00

* Fire alarm relay requires option board installation. If PS906 with fire alarm input only is desired, order 900-8P FA

3. Select Other Power Supply Options

1.	900-BBK - Battery Backup Kit (includes two 7A/hr batteries)	\$266.00
1.	900-BB - Battery Backup Board only (sold separately)	\$133.00
1.	900-BAT - Backup Battery Pack Two (2) 7A/hr batteries (sold separately)	\$133.00
2.	900-FA - Fire Alarm Relay (EIR) module is a plug-in relay to provide an interface with fire or other emergency override systems *may be installed directly on main board, or may be used with optional distribution board	\$67.00
3.	900-KL - Key Lock	\$42.40
4.	BAA-BAA Compliant Product	\$42.40

BAA compliant products must have the cover letter on page 299 included with the order. Failure to use this cover letter will result in the customer receiving non-BAA compliant product with no recourse for an RMA or refund. BAA compliant product requires a longer lead time, please contact customer service for details.

Note: PS902 power supplies require connection to AC line voltage. Installation and all electrical connections (high and low voltage) should be performed by a qualified electrical contractor.

PS904 Power Supplies

4A @ 12/24 VDC – field selectable



Standard Features

- UL 294 Listed for Access Control
- Class2 rated power limited output
- Universal 120-240 VAC input
- Regulated and filtered DC outputs
- AC input and DC output LED indications
- Battery backup board attaches to main board
- 2 Plug and play connectors for optional distribution boards
- AC input status indication on outside cover
- AC status monitor
- 14" H x 12" W x 4" D enclosure

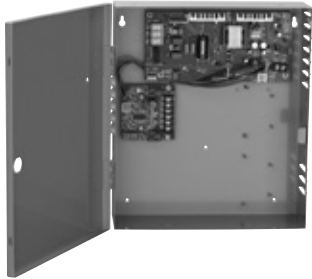

1. Select Power Supply

PS904	Base Power Supply (4A @ 12/24 VDC- field selectable) (approx. weight: 11 lbs) PS904 is able to accept a total of two optional distribution boards, plus one battery backup board and up to two 7A/hr batteries	\$530.00
--------------	---	-----------------

2. Select Optional Distribution Board with or without FA (Fire Alarm Relay)

1.	900-4R - 4 independently controlled relays	\$186.00
1.	900-4R FA - 4 independently controlled relays with FA	\$253.00
2.	900-2RS - 2 relay EL panic device control board	\$172.00
2.	900-2RS FA - 2 relay output with FA	\$239.00
3.	900-4RL - 4 relay board with integrated logic for controlling security interlocks, auto operators, and time delays	\$509.00
3.	900-4RL FA - 4 relay board with integrated logic for controlling security interlocks, auto operators, and time delays with FA	\$576.00
4.	900-8F - 8 fuse protected outputs	\$66.00
4.	900-8F FA - 8 fuse protected outputs with FA	\$133.00
5.	900-8P - 8 PTC protected outputs	\$66.00
5.	900-8P FA - 8 PTC protected outputs with FA	\$133.00

* Fire alarm relay requires option board installation. If PS904 with fire alarm input only is desired, order 900-8P FA

3. Select Other Power Supply Options

1.	900-BBK - Battery Backup Kit (includes two 7A/hr batteries)	\$266.00
1.	900-BB - Battery Backup Board only (sold separately)	\$133.00
1.	900-BAT - Backup Battery Pack Two (2) 7A/hr batteries (sold separately)	\$133.00
2.	900-KL - Key Lock	\$42.40
3.	BAA-BAA Compliant Product	\$42.40

BAA compliant products must have the cover letter on page 299 included with the order. Failure to use this cover letter will result in the customer receiving non-BAA compliant product with no recourse for an RMA or refund. BAA compliant product requires a longer lead time, please contact customer service for details.

Note: PS904 power supplies require connection to AC line voltage. Installation and all electrical connections (high and low voltage) should be performed by a qualified electrical contractor.

PS906 Power Supplies

6A @ 12/24 VDC – field selectable



Standard Features

- UL 294 Listed for Access Control
- Class 2 rated power limited output when paired with 8P option board
- Universal 120-240 VAC input
- Regulated and filtered DC outputs
- AC input and DC output LED indications
- Battery backup board attaches to main board
- 3 Plug and play connectors for optional distribution boards
- AC input status indication on outside cover
- AC status monitor
- 14" H x 12" W x 4" D enclosure

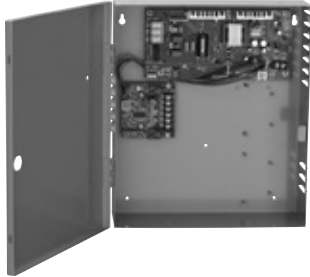

1. Select Power Supply

PS906	Base Power Supply (6A @ 12/24 VDC- field selectable) (approx. weight: 7 lbs) PS906 is able to accept three optional distribution boards or two optional boards with battery backup board and two 7A/hr batteries	\$822.00
--------------	--	-----------------

2. Select Optional Distribution Board with or without FA (Fire Alarm Relay)

1.	900-4R - 4 independently controlled relays	\$186.00
1.	900-4R FA - 4 independently controlled relays with FA	\$253.00
2.	900-2RS - 2 relay EL panic device control board	\$172.00
2.	900-2RS FA - 2 relay output with FA	\$239.00
3.	900-4RL - 4 relay board with integrated logic for controlling security interlocks, auto operators, and time delays	\$509.00
3.	900-4RL FA - 4 relay board with integrated logic for controlling security interlocks, auto operators, and time delays with FA	\$576.00
4.	900-8F - 8 fuse protected outputs	\$66.00
4.	900-8F FA - 8 fuse protected outputs with FA	\$133.00
5.	900-8P - 8 PTC protected outputs	\$66.00
5.	900-8P FA - 8 PTC protected outputs with FA	\$133.00

3. Select Other Power Supply Options

1.	900-BBK - Battery Backup Kit (includes two 7A/hr batteries) <i>*Can not be used if 3rd distribution board is installed*</i>	\$266.00
1.	900-BB - Battery Backup Board only (sold separately)	\$133.00
1.	900-BAT - Backup Battery Pack Two (2) 7A/hr batteries (sold separately)	\$133.00
2.	900-KL - Key Lock	\$42.40
3.	BAA-BAA Compliant Product	\$42.40

BAA compliant products must have the cover letter on page 299 included with the order. Failure to use this cover letter will result in the customer receiving non-BAA compliant product with no recourse for an RMA or refund. BAA compliant product requires a longer lead time, please contact customer service for details.

Note: PS906 power supplies require connection to AC line voltage. Installation and all electrical connections (high and low voltage) should be performed by a qualified electrical contractor.

SYSTEM ACCESSORIES - TABLE OF CONENTS

CONSOLES AND MONITORING STATIONS	250
8200 Series	250
800 Series	250
ELECTRONIC ACCESS RELEASING DEVICES	251
672 TouchBar	251
692 SmartBar	252
672 TouchBar / 692 SmartBar Parts	253
600 Series Heavy Duty Pushbutton	254
700 Series Entry Level Pushbutton	256
650 Series Heavy Duty Keyswitches	257
SPECIALTY EQUIPMENT	259
Door Position Switches	259
Door Cords	259
ACCESSORIES	260
Electric Horns	260
Scanners/PIRs	260
740 sereis Emergency Break Glass	260
660 Series Surface Mini Box	260
ELECTROMECHANICAL LOCKS	261
442S Series Cabinet Lock	261
PB405-PB405S PowerBolts	261

CONTACT INFORMATION FOR SYSTEM ACCESSORIES

Payment Address: Schlage Electronic Security
 15934 Collections Center Drive
 Chicago, IL 60693

877-671-7011	
Customer Service:	Technical Support:
Order Status, Credit Returns of Non-Defective Products, General Sales Questions	Technical Questions/Issues, Returns of Defective Products, Repairs
Email Orders To: Order_Entry_Schlage_Commercial@allegion.com	Contact For Technical Assistance: Electronic_Lock_TechProdSupport@allegion.com

For System Accessories Warranty Information please see page 12.

Pricing/product description subject to change without notice.



8200 Series Consoles

Features

- Slope front design, with anodized face plate and durable housing
- Each station provides maintained or momentary SPDT pushbutton switch
- Red and green indicator lamps
- Security keyswitch
- Signaling Horn
- Alarm reset button
- 24 VDC operation
- UL 294 listed for access control system

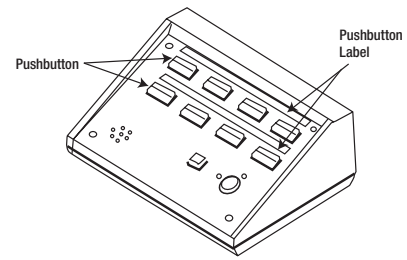

4 or 8 zone console

Select Model

1. Select model - last digit indicates # of zones and select pushbutton function by zone
2. Specify a switch for each zone; M (momentary) or A (alternate action, maintained)

	ZONE	1	2	3	4	5	6	7	8	
8204		---	---	---	---					\$1,377.00
8208		---	---	---	---	---	---	---	---	\$2,423.00

Replacement Parts

8200MS	Momentary Switch Assembly	\$151.00
8200AS	Alternate Action (maintained) Switch Assembly	\$151.00
P810033	8 Zone PCB Assembly	\$236.00
P810049	Console Silence Button	\$82.30
P810050	Console Keyswitch	\$93.20

800 Series Remote & Local Monitoring Stations



800A

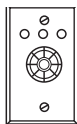

801

Select Model

800A	Remote monitoring - audible sound, 80 dB @ 2ft	\$150.00
800L1	Local monitoring - one LED indicator - red, green or amber	\$75.40
800L2	Two LED indicators - red, green or amber	\$104.00
801	Local or Remote Monitoring Station (requires MBS option on locking device)	\$279.00
801KS	Local or Remote Monitoring Station with Keyswitch (less cylinder) for Legal Release & Reset feature (requires MBS on locking device) SPDT momentary x SPDT maintained contact arrangement	\$735.00



672 TouchBar

The 672 TouchBar is a request-to-exit device used to release electromagnetic locks. Designed for easy installation, smooth operation and maximum durability.

Standard Features

- Pushpad with "PUSH TO EXIT" signage
- 1/4" Movement to activate switch
- Heavy-duty aluminum extrusion and powder coated zinc end caps
- Double pole, double throw switch
- UL 294 listed for access control system
- Universal mounting system for aluminum, hollow metal and wood doors (Includes self-drilling, self-tapping screws for aluminum or wood door application: RIV nuts for hollow metal door applications)
- Field reversible

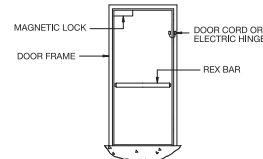

REX Bar Application

1. Select Model

672	For aluminum, hollow metal and wood doors	\$355.00
------------	---	-----------------

2. Select Door Size

36", 42" or 48"	Standard door width	STANDARD
------------------------	---------------------	-----------------

3. Select Finish

628	Clear Anodized Aluminum	STANDARD
313	Dark Satin Bronze Anodized Aluminum	\$33.80

4. Select Pushpad

RD	Black pushpad with RED letters "PUSH TO EXIT"	STANDARD
GID	Black pushpad with Glow-In-The-Dark letters "PUSH TO EXIT"	NO CHARGE

5. Select Handing

RHR	Right Hand Reverse	STANDARD
LHR	Left Hand Reverse	NO CHARGE

6. Select Option/Accessory

AR	798-18, 18" x 1/2" Armored Door Cord (less wires) in/out swinging	\$63.80
WD	Sexnut door kit for heavy-duty wood door and hollow metal door applications (includes 4 sex bolts & screws)	\$83.20
SHK	Aluminum Door Mounting Shim Kit (Includes brackets/shims & screws)	\$83.20

Parts

See 672 TouchBar Parts on page 253

Specifications

Mechanical

- Available in standard lengths to fit 36", 42" and 48" doors
- Can also be field cut at the installation site for custom lengths

Electrical

- Switch:** DPDT contacts rated 4A @ 30 VDC
- Wiring:** 6 Conductor Cable - 20 AWG (standard)

692 SmartBar



The 692 TouchBar is a request-to-exit device with no moving parts used to release electromagnetic locks. Designed for easy installation, smooth operation and maximum durability.

Standard Features

- Push pad with "PUSH TO EXIT" signage
- Touch any point on the pushpad to release locking device
- Audible alarm
- Heavy duty aluminum extrusion and powder coated zinc end caps
- Directionally opposed infrared detection circuits
- DPDT relay
- Universal mounting system for aluminum, hollow metal and wood doors (Includes self-drilling, self-tapping screws for aluminum or wood door application: RIV nuts for hollow metal door applications)
- 798-18, 18" x 1/2" Armored door cord (798-18) shipped standard
- UL 294 listed for access control system



1. Select Model

692	For aluminum, hollow metal and wood doors	\$646.00
------------	---	-----------------

2. Select Door Size

36", 42" or 48"	Standard door width	STANDARD
------------------------	---------------------	-----------------

3. Select Finish

628	Clear Anodized Aluminum	STANDARD
313	Dark Satin Bronze Anodized Aluminum	\$33.80

4. Select Pushpad

RD	Black pushpad with RED letters "PUSH TO EXIT"	STANDARD
GID	Black pushpad with Glow-In-The-Dark letters "PUSH TO EXIT"	NO CHARGE

5. Select Handing

RHR	Right hand reverse	STANDARD
LHR	Left hand reverse	NO CHARGE

6. Select Option/Accessory

WD	Sexnut door kit (for heavy-duty wood door and hollow metal door applications)	\$83.20
SHK	Aluminum Door Mounting Shim Kit (Includes brackets/shims & screws)	\$83.20

Parts

See 692 TouchBar Parts on page 253

Specifications

Mechanical

- Available in standard lengths to fit 36", 42" and 48" doors
- Can also be field cut at the installation site

Electrical

- Input Voltage:** 12 or 24 VDC. Maximum current draw .50A
- Contact Rating:** 4A @ 30 VDC
- Wiring:** 8 Conductor Cable - 20 AWG - 6 ft long

672 / 692 Shared Parts

P972797	CHAN END CAP BRKT - 672/692	\$98.10
P972792	Exit Insert - Red	\$93.20
P972791	Exit Plate - Black	\$93.20
P900256	Mounting Screw Pack 672/692	\$93.20
P900257-628	REX SNB KIT QTY-4 US32D	\$93.20
P900257-313	REX SNB KIT QTY-4 SP313	\$93.20
P900275-BLK	Spacer Adaptor - Black	\$110.00
P900275-GRY	Spacer Adaptor - Gray	\$110.00
P972772-313	Standard Pushbar-36-313	\$159.00
P972772-628	Standard Pushbar-36-628	\$159.00
P972773-313	Standard Pushbar-42-313	\$159.00
P972773-628	Standard Pushbar-42-628	\$159.00
P972774-313	Standard Pushbar-48-313	\$159.00
P972774-628	Standard Pushbar-48-628	\$159.00

672 Parts

P972766-628	672 Cover Plate - 36"- 628	\$121.00
P972767-313	672 Cover Plate - 42"- 313	\$121.00
P972767-628	672 Cover Plate - 42"- 628	\$121.00
P972768-313	672 Cover Plate - 48"- 313	\$121.00
P972768-628	672 Cover Plate - 48"- 628	\$121.00
P972784-BLK	672 Channel End Cap - Black 672	\$98.80
P972784-GRY	672 Channel End Cap	\$98.80
P114281	PCB Assembly DPDT 672	\$198.00

692 Parts

P692001	692 Beam Housing Assembly - Black	\$170.00
P114285	Control Board Assy - 692	\$330.00
P972769-313	692 Cover Plate - 36"- 313	\$121.00
P972769-628	692 Cover Plate - 36"- 628	\$121.00
P972770-313	692 Cover Plate - 42"- 313	\$121.00
P972770-628	692 Cover Plate - 42"- 628	\$121.00
P972771-313	692 Cover Plate - 48"- 313	\$121.00
P972771-628	692 Cover Plate - 48"- 628	\$121.00
P114287	692 Wire Harness - 6 Ft	\$126.00
P114284	End Cap PCB Cable Assy - 692	\$98.80

600 Series Heavy Duty Pushbuttons

3A@30 VDC, Momentary (Standard) contacts



621
623



621-NS
623-NS

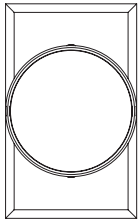

625



625-NS

1. Select Model

Product No.	Cover Plate	Cone	Button		
621AL	Stainless Steel	Plastic	1-1/4"	Aluminum	\$208.00
621AL EX	2-3/4" x 4-1/2"	Translucent	1-1/4"	Alum. "Push to Exit" engraved	\$208.00
621AL RD EX			1-1/4"	Alum. (red coated), "Push to Exit" engraved	\$208.00
621BLH			1-1/4"	Blue Handicapped symbol	\$167.00
621BK			1-1/4"	Black	\$167.00
621GR			1-1/4"	Green	\$167.00
621GR EX			1-1/4"	Green "Push to Exit"	\$167.00
621RD			1-1/4"	Red	\$167.00
621RD EX			1-1/4"	Red "Push to Exit"	\$167.00
621GID			1-1/4"	Glow-in-the-Dark	\$167.00
621GID EX			1-1/4"	Glow-in-the-Dark "Push to Exit"	\$167.00
623BLH	Stainless Steel	Plastic	1-5/8"	Blue Handicapped symbol	\$167.00
623BK	2-3/4" x 4-1/2"	Translucent	1-5/8"	Black	\$167.00
623GR			1-5/8"	Green	\$167.00
623GR EX			1-5/8"	Green "Push to Exit"	\$167.00
623RD			1-5/8"	Red	\$167.00
623RD EX			1-5/8"	Red "Push to Exit"	\$167.00
623GID			1-5/8"	Glow-in-the-Dark	\$167.00
623GID EX			1-5/8"	Glow-in-the-Dark "Push to Exit"	\$167.00
625BLH	Stainless Steel	Plastic	2-3/4"	Blue Handicapped symbol	\$167.00
625BK	2-3/4" x 4-1/2"	Translucent	2-3/4"	Black	\$167.00
625GR			2-3/4"	Green	\$167.00
625GR EX			2-3/4"	Green "Push to Exit"	\$167.00
625RD			2-3/4"	Red	\$167.00
625RD EX			2-3/4"	Red "Push to Exit"	\$167.00
631AL*	Cast Zinc	Zinc	1-1/4"	Aluminum	\$306.00
631AL EX*	2-3/4" x 4-1/2"		1-1/4"	Aluminum "Push to Exit" engraved	\$306.00
631AL RD EX*	Extreme Duty		1-1/4"	Aluminum (red coated) "Push to Exit" Engraved silver	\$306.00

* not available in special finishes

2. Select Options

DA	Delayed Action (3A @ 30 VDC, form Z contacts)	\$446.00
NS	Narrow Stile - Stainless Steel Plate (1-3/4" x 4-1/2")	NO CHARGE
AA	Alternate Action/Maintained (3A @ 30VDC)	NO CHARGE
L2/ILL	LEDs for glow thru cone for 621 and 623 models (12-24 VDC .025A @ 28VDC)	\$67.30
DP	DPDT - Double pole, double throw (not available with DA option)	\$33.80

3. Select Finish - Heavy Duty Plate (HDP Included - Required for Special Finish)

630	BHMA 630/US32D on .035 Satin Stainless Steel	Standard
SF-626	Satin Chrome on heavy-duty zinc	\$57.20
SF-625	Bright Chrome on heavy-duty zinc	\$148.00
SF-613	Oil Rubbed Bronze on heavy-duty zinc	\$148.00

PCB Assembly Only

P620009-1	DPDT - PC Board Assembly	\$77.70
P620009	SPDT - PC Board Assembly	\$43.90
P395362	L2/ILL - PC Board Assembly	\$67.90

621 Button Only

P620136	Button 1-1/4" Metal	\$41.70
P620026-1	Button 1-1/4" Metal Push to Exit	\$41.70
P620092-BL	Button 1-1/4" Blue Handicap	\$29.70
P620090-BK	Button 1-1/4" Black	\$29.70
P620090-GID	Button 1-1/4" GID	\$29.70
P620090-GR	Button 1-1/4" Green	\$29.70
P620090-RD	Button 1-1/4" Red	\$29.70
P620091-GID	Button 1-1/4" GID	\$29.70
P620091-GR	Button 1-1/4" Green	\$29.70
P620091-RD	Button 1-1/4" Red	\$29.70

623 Button Only

P620032-BL	Button 1-5/8" Blue Handicap	\$29.70
P620014-GID	Button 1-5/8" GID	\$29.70
P620031-GID	Button 1-5/8" GID Push to Exit	\$29.70
P620014-GR	Button 1-5/8" Green	\$29.70
P620031-GR	Button 1-5/8" Green Push to Exit	\$29.70
P620014-RD	Button 1-5/8" Red	\$29.70
P620031-RD	Button 1-5/8" Red Push to Exit	\$29.70
P620014-BK	Button 1-5/8" Black	\$29.70

625 Button Only

P620029-BK	Button 2-3/4" Black	\$29.70
P620027-BL	Button 2-3/4" Blue Handicap	\$29.70
P620029-GR	Button 2-3/4" Green	\$29.70
P620028-GR	Button 2-3/4" Green Push to Exit	\$29.70
P620029-RD	Button 2-3/4" Red	\$29.70
P620028-RD	Button 2-3/4" Red Push to Exit	\$29.70

Faceplates Only

P620008-613	Heavy Duty Plate - 613 Dark Satin Bronze	\$147.00
P620008-625	Heavy Duty Plate - 625 Bright Chrome	\$147.00
P620008-626	Heavy Duty Plate - 626 Satin Chrome	\$53.70
P620020-613	Heavy Duty Plate Narrow - 613 Dark Satin Bronze	\$147.00
P620020-625	Heavy Duty Plate Narrow - 625 Bright Chrome	\$147.00
P620020-626	Heavy Duty Plate Narrow - 626 Satin Chrome	\$57.20
P620088	Plate Narrow Stainless Steel	\$57.20
P620033	Plate Single-Gang Stainless Steel	\$57.20

Other Parts

P630032	Anti-Tamper Plug - 631 Stainless Steel	\$5.50
---------	--	---------------

700 Series Entry Level Pushbutton

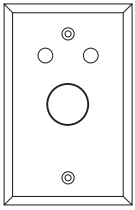

701RD-L2

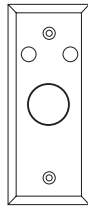

701RD-NS-L2



709BLH ILL-L2

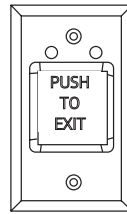

709RD EX ILL-L2

Specifications

Output contact Rating:

701 Series 3A @ 30 VAC/VDC, momentary SPDT contacts

709 Series 5A @ 30 VAC/VDC, momentary SPDT contacts

1. Select Model

Product No.	Cover Plate	Color	Button Size	Button Feature	Price
701RD	Stainless Steel Only	Red	7/8"		\$136.00
701BK	2-3/4" x 4-1/2"	Black	7/8"		\$136.00
701RD EX		Red	5/8"	Engraved "Push to Exit"	\$136.00
701RD EX ILL		Red	5/8"	Illuminated "Push to Exit"	\$164.00
709RD EX ILL*	Stainless Steel Only	Red	2" sq	Illuminated "Push to Exit"	\$159.00
709GR EX ILL*	2-3/4" x 4-1/2"	Green	2" sq	Illuminated "Push to Exit"	\$159.00
709BLH ILL*		Blue	2" sq	Illuminated Handicapped Symbol	\$159.00

*Must Specify 12 VDC or 24 VDC when ordering 709 Series Pushbuttons

2. Select Options

L2	Two LEDs, red or green, dual voltage	\$67.60
AA	Alternate Action - maintained for 701 Series only	\$20.70
NS	Narrow Stile plate for 701 Series only	NO CHARGE

Parts

P100682	701 Button 7/8" - Red	\$41.70
P100688	701 Button 7/8" - Black	\$41.70
P701629	701 Narrow Stainless Steel Plate	\$33.00
P701607	701 Stainless Steel Plate	\$33.00
P701628	701 Stainless Steel Plate L2	\$33.00

650 Series Heavy Duty Keyswitches

Patent #6689972

- Patented Magnetic Spring Design
- Momentary to Maintained Functions
- 5A @ 30 VDC, SPDT contacts
- Standard faceplate finish 630 Stainless Steel

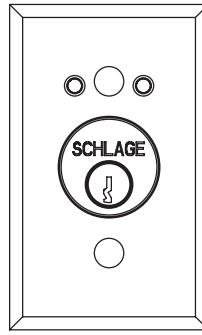

653-04-L2



653-04-L2-NS

Note: 650 Series Keyswitches operate with either a 1-1/8" or 1-1/4" cylinder having a straight type cam. 1-1/4" Cylinders require a 1/8" blocking / spacer ring (included with the CYL and CYL-KA options). Cannot be used with cylinder and/or collar greater than 1-3/8".

1. Select Keyswitch Function

Product No.	Description	Cover Plate	
653-04	SPDT maintained single direction - Stainless Steel	2-3/4" x 4-1/2"	\$224.00
653-05	SPDT momentary single direction - Stainless Steel	2-3/4" x 4-1/2"	\$224.00
653-14	DPDT maintained single direction - Stainless Steel	2-3/4" x 4-1/2"	\$258.00
653-15	DPDT momentary single direction - Stainless Steel	2-3/4" x 4-1/2"	\$258.00
653-1414	(2) DPDT maintained bi-direction - Stainless Steel	2-3/4" x 4-1/2"	\$342.00
653-1415	DPDT maintained x DPDT momentary - Stainless Steel	2-3/4" x 4-1/2"	\$342.00
653-1515	(2) DPDT momentary bi-direction - Stainless Steel	2-3/4" x 4-1/2"	\$342.00
653-041	SPDT maintained x key remove one position - Stainless Steel	2-3/4" x 4-1/2"	\$224.00
653-0404	(2) SPDT maintained bi-direction - Stainless Steel	2-3/4" x 4-1/2"	\$258.00
653-0405	SPDT maintained x SPDT momentary - Stainless Steel	2-3/4" x 4-1/2"	\$258.00
653-141	DPDT maintained x key remove one position - Stainless Steel	2-3/4" x 4-1/2"	\$258.00
653-0505	(2) SPDT momentary bi-direction - Stainless Steel	2-3/4" x 4-1/2"	\$258.00

2. Select Option

L2	Two LEDs (red/green), dual voltage 12/24 VDC	\$67.60
NS	Narrow Stile - Stainless Steel Plate (1-3/4" x 4-1/2")	NO CHARGE
ATS	Anti-Tamper Switch	\$63.80
WP	Water Resistant Cover fits 1-1/8" cylinder only (not available with NS or L2 or special finishes)	\$80.70
CYL	1-1/4" Schlage Everest Mortise Cylinder with two keys & 1/8" spacer ring	\$75.40
CYL-KA (keyed alike)	1-1/4" Schlage Everest Mortise Cylinder with two keys & 1/8" spacer ring	\$75.40

3. Select Plate Finish

630	BHMA 630/US32D on .035 Satin Stainless Steel	Standard
SF-626	Satin Chrome on heavy-duty zinc	\$57.20
SF-625	Bright Chrome on heavy-duty zinc	\$147.00
SF-612	Satin Bronze on heavy-duty zinc	\$147.00
SF-613	Oil Rubbed Bronze on heavy-duty zinc	\$147.00
SF-605	Bright Brass on heavy-duty zinc	\$147.00

4. Select Optional Blocking Ring - (only necessary when using with a competitive cylinder)

36-079	Blocking ring for use without compression ring	\$14.00
--------	--	----------------

5. Specify Blocking Ring Size - (example: 36-079-012)

012	1/8" length
018	3/16" length
025	1/4" length
031	5/16" length
037	3/8" length
043	7/16" length
050	1/2" length

Pricing/product description subject to change without notice.

650 Series Heavy Duty Keyswitch Parts



Mounting Hardware Only

P630013-605	Heavy Duty Mounting Hardware - 605 Bright Brass	\$24.10
P630013-612	Heavy Duty Mounting Hardware - 612 Satin Bronze	\$24.10
P630013-613	Heavy Duty Mounting Hardware - 613 Dark Satin Bronze	\$24.10
P630013-625	Heavy Duty Mounting Hardware - 625 Bright Chrome	\$24.10
P630013	Heavy Duty Mounting Hardware - 626 Satin Chrome	\$12.10

Single Gang Faceplate Only

P653063	Standard Plate - Stainless Steel	\$57.20
P653009-605	Heavy Duty Plate - 605 Bright Brass	\$147.00
P653009-612	Heavy Duty Plate - 612 Satin Bronze	\$147.00
P653009-613	Heavy Duty Plate - 613 Dark Satin Bronze	\$147.00
P653009-625	Heavy Duty Plate - 625 Bright Chrome	\$147.00
P653009-626	Heavy Duty Plate - 626 Satin Chrome	\$57.20
P653064	Standard Plate - Stainless Steel - L2	\$57.20
P653015-605	Heavy Duty Plate - L2 - 605 Bright Brass	\$147.00
P653015-612	Heavy Duty Plate - L2 - 612 Satin Bronze	\$147.00
P653015-613	Heavy Duty Plate - L2 - 613 Dark Satin Bronze	\$147.00
P653015-625	Heavy Duty Plate - L2 - 625 Bright Chrome	\$147.00
P653015-626	Heavy Duty Plate - L2 - 626 Satin Chrome	\$57.20

Narrow Faceplate Only

P653065	Standard Plate Narrow - Stainless Steel	\$57.20
P653026-605	Heavy Duty Plate Narrow - 605 Bright Brass	\$147.00
P653026-612	Heavy Duty Plate Narrow - 612 Satin Bronze	\$147.00
P653026-613	Heavy Duty Plate Narrow - 613 Dark Satin Bronze	\$147.00
P653026-625	Heavy Duty Plate Narrow - 625 Bright Chrome	\$147.00
P653026-626	Heavy Duty Plate Narrow - 626 Satin Chrome	\$57.20
P653066	Standard Plate Narrow - Stainless Steel - L2	\$117.00
P653027-605	Heavy Duty Plate Narrow - L2 - 605 Bright Brass	\$125.00
P653027-612	Heavy Duty Plate Narrow - L2 - 612 Satin Bronze	\$147.00
P653027-613	Heavy Duty Plate Narrow - L2 - 613 Dark Satin Bronze	\$147.00
P653027-625	Heavy Duty Plate Narrow - L2 - 625 Bright Chrome	\$147.00
P653027-626	Heavy Duty Plate Narrow - L2 - 626 Satin Chrome	\$57.20

Switches Only

P653067	Anti-Tamper Switch and Magnet	\$24.10
P653059	Switch and Lead Assembly	\$29.70

Pricing/product description subject to change without notice.

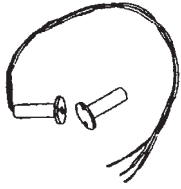

679-05 Concealed SPDT Magnetic Switch

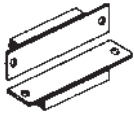

7764 Concealed door position switch

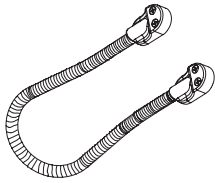

Door Cord

Door Position Switches

674-OH	Overhead Door Floor Mount	\$280.00
679 SERIES CONCEALED SPDT MAGNETIC SWITCH (0.3A @ 30 VDC)		
679-05	Wood Door and Frame	\$61.20
679-05HM	HM Hollow Metal Door and Frame	\$84.70
679-05WD	WD Wood Door and Metal Frame	\$101.00
7700 SERIES DOOR POSITION SWITCHES (0.25A @ 30 VDC)		
7764	Concealed / Flush Mount	\$204.00
7766	Surface Mount	\$216.00

Door Cords

788-12	12" x 3/8" Armored Door Cord - less wires	\$66.10
788C-12	12" x 3/8" Armored Door Cord with 20" 4-conductor wire	\$101.00
788-18	18" x 3/8" Armored Door Cord - less wires	\$88.20
788C-18	18" x 3/8" Armored Door Cord with 26" 4-conductor wire	\$118.00
798-12	12" x 1/2" Armored Door Cord - less wires	\$76.60
798C-12	12" x 1/2" Armored Door Cord with 20" 4-conductor wire	\$101.00
798-18	18" x 1/2" Armored Door Cord - less wires	\$97.40
798C-18	18" x 1/2" Armored Door Cord with 26" 4-conductor wire	\$118.00

Notes: C Suffix = 20 AWG wires
Classified by UL to UL 10C

Pricing/product description subject to change without notice.

Accessories



Electronic Horns



- Immediate, local audible warning device
- Designed for indoor application
- Surface and flush mounting kits included with all horns
- Latching units require a reset action
- Strobe units activate / deactivate based on the state of the horn
- Horn color is white
- Dual decibal settings high/low 102 and 88 with dba's

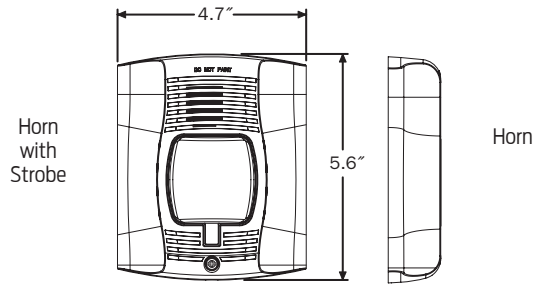

1. Select Model

1910-1	12/24 VDC Horn, current draw 14 mA @ 12 VDC; 28 mA @ 24 VDC	\$455.00
1910S-1	24 VDC Horn with strobe, current draw 71mA	\$620.00
L1910-1	24 VDC Horn with latching, current draw 28mA	\$630.00
L1910S-1	24 VDC Horn with strobe & latching, current draw 71mA	\$823.00

Scanners/PIRs

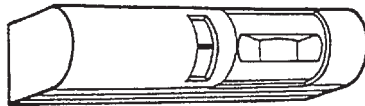

SCAN II-W

- Passive Infrared Detector
- Surface Mounting height range is from 7 to 15 ft
- Two form "C" relay contacts rated 2A @ 30 VDC for DC resistive loads
- Relay latch time is adjustable up to 64 seconds
- UL 294 listed by manufacturer as an access control device
- Designed for indoor applications



1. Select Model

Scan II - B	Black	\$538.00
Scan II - W	White	\$538.00

740 Series Emergency Break Glass

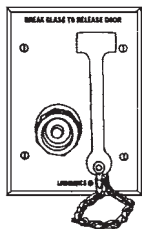

740

Switch contact form "Z", rated 6A @ 30 VDC

740	Assembly only	\$384.00
741	With indicator light	\$393.00
742	With Sonalert	\$427.00

Assembly mounts in 3 gang electrical box
 P800003 is the part number for the 5 pack of glass disc replacements. Cost: \$103.00

660 Series Surface Mini Box

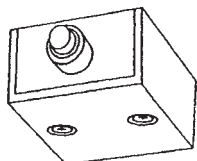

660

- Dimensions: 2" H x 2" W x 1" D
- Switch contact rating: 6A @ 120 VAC

660-T4	SPDT Maintained Toggle	\$142.00
660-PB	SPDT Momentary Pushbutton	\$145.00

Recommended for concealed desk application

Pricing/product description subject to change without notice.

Patent #'s 4,557,121/4,579,376

442S Series Cabinet Lock

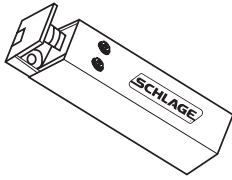

442S

Specifications

Overall Dimensions: 3" L x 1" W x 1" D
Current Draw: 0.50A @ 12 VDC; 0.25A @ 24 VDC (field selectable)

1. Select Model

442S	Lock with strike - Black Lexan finish	Fail Secure	\$267.00
-------------	---------------------------------------	-------------	-----------------

PB405/PB405S PowerBolts

Standard Features

- Magnetic Door Status Monitor
- Magnetic Relocking Switch

Specifications

Bolt Size 405/405S:	.61" diameter x .67" throw
PB405 overall size:	7.87" x 1.26" x 1.57", 90° locking
PB405S overall size:	7.87" x 1.26" x 1.57"
Current Draw:	0.9A @ 12 VDC; 0.45A @ 24 VDC 12/24 VDC dual voltage, field selectable

Note: Electromechanical locks not recommended where life safety may be compromised, or where panic bar hardware is the only means of egress.
 Mortise mount electric bolts furnished in Satin Aluminum finish.



PB405/PB405S

1. Select Model

PB405	Fail Safe, Rectangular Front	\$553.00
PB405S	Fail Secure, Rectangular Front	\$687.00
PB405-RFK	Retro Fit Kit	\$62.30

Fail Secure Lock - Requires power to unlock

Fail Safe Lock - Requires power to lock

VON DUPRIN ACCESS CONTROL PRODUCTS - TABLE OF CONTENTS

ELECTRIC STRIKES	264
4200 Series	264
6400 Series	264
5100 Series	265
6100 Series	265
6200 Series	265
6300 Series	266
POWER SUPPLY	266
DELAYED EXIT SYSTEM	266
ELECTRIC POWER TRANSFER	266
VON DUPRIN REMOTE UNDOGGING AND REMOTE MONITORING	266

CONTACT INFORMATION FOR VON DUPRIN ACCESS CONTROL PRODUCTS

Payment Address: Von Duprin
 15934 Collections Center Drive
 Chicago, IL 60693

877-671-7011	
Customer Service:	Technical Support:
Order Status, Credit Returns of Non-Defective Products, General Sales Questions	Technical Questions/Issues, Returns of Defective Products, Repairs
Email Orders To: Order_Vondurpin@allegion.com	Contact For Technical Assistance: Exits_TechProdSupport@allegion.com

For Von Duprin Access Control Products Warranty Information please see the Von Duprin Exit Hardware and Parts book.

Pricing/product description subject to change without notice.

4200 Series Von Duprin Electric Strikes for cylindrical and deadlatch locks

Orderable through Schlage (ships from Security, CO) or Von Duprin (ships from Indianapolis, IN)



Features:

- Field selectable fail-safe/fail-secure without disassembly
- Dual voltage: 12 VDC at 0.20 A / 24 VDC at 0.10 A
- Finish: BHMA 630 / US32D stainless steel, satin finish
- Compatible with all Schlage and Falcon cylindrical locks as well as cylindrical and deadlatch locks of many other manufacturers
- Meets ANSI/BHMA 156.31 Grade 1 endurance & dynamic strength
- Meets ANSI/BHMA 156.31 Grade 2 static strength

Model	Fire Rated	Throw	Hollow Metal	Wood	Aluminum	Single	Mullion Pair	
4211		1/2"-3/4"	■		■	■		Shallow 1-3/8" backbox depth \$186.00
4212		1/2"-5/8"	■		■	■		Includes latchbolt monitor. Shallow backbox. \$224.00

Options (please specify):

S012	Rectifier Kit						Converts 12 VAC to 12 VDC	\$41.20
S024	Rectifier Kit						Converts 24 VAC to 24 VDC	\$41.20
EB	EB Entry Buzzer						Use in fail-secure applications	\$41.20

Available Parts:

P050805	4200 Hardware Kit						Includes: mounting tab hardware, mounting screws, allen wrench and diode	\$15.00
P90114	Faceplate, 4200, square corner							\$18.80
P90110	Faceplate, 4200, round corner							\$18.80

For additional parts list, please see Von Duprin price book.

6400 Series Von Duprin Modular Electric Strike for mortise or cylindrical locks

Orderable through Schlage (ships from Security, CO) or Von Duprin (ships from Indianapolis, IN)



Features:

- Dual voltage: 12 VDC at 0.375 A / 24 VDC at 0.19 A
- Finish: BHMA 630/US32D stainless steel, satin finish
- Modular options fit cylindrical and nearly any mortise lock.
- Includes movable deadbolt keeper, plug and deadlatch ramp inserts.
- ANSI/BHMA 156.31 Grade 1
- 1500 lbs. static strength
- UL1034 listed for burglary resistance
- 3-hour fire rated to UL10C (fail secure only)
- UL 294 listed for access control system units
- CSFM California State Fire Marshal listed

Model	Fire Rated	Throw	Hollow Metal	Wood	Aluminum	Single	Mullion Pair	
6400	■	up to 3/4"	■	■	■	■		Up to 1" deadbolt throw (as night latch only) \$583.00

Options (please specify):

LM6400	Latch Monitor							Optional plug-in latch monitor can be added in the field \$62.30
--------	---------------	--	--	--	--	--	--	---

For additional parts list, please see Von Duprin price book.

S012	Rectifier Kit	Converts 12 VAC to 12 VDC						\$41.20
S024	Rectifier Kit	Converts 24 VAC to 24 VDC						\$41.20
EB	EB Entry Buzzer	Use in fail-secure applications						\$41.20

Additional Electric Strikes available exclusively through Von Duprin:

Please see Von Duprin price book for current list price information.

5100 Series Von Duprin Electric Strike for cylindrical and deadlatch locks

Features:

- Adjustable keeper improves fit on tight door preps
- Field selectable fail-safe/fail-secure
- Dual voltage: 12 VDC at 0.38 A / 24 VDC at 0.19 A
- Available finishes: BHMA 689 / US SP28 aluminum; BHMA 622 / US19 flat black; BHMA 695 / US SP313 dark brown
- Compatible with Schlage and Falcon cylindrical and deadlatch locks including those of many other manufacturers
- Meets ANSI/BHMA 156.31 Grade 1 endurance & dynamic strength
- Meets ANSI/BHMA 156.31 Grade 2 static strength
- UL 1034 burglary-resistant

Model	Throw	Hollow Metal	Wood	Aluminum	Single	Mullion Pair
5100	1/2"-5/8"	■	■	■	■	3 faceplates cover HM, AL and Wood applications with hardware included for an all-in-one boxed solution

For specified options and complete parts list, please see Von Duprin pricebook.

6100 Series Von Duprin Electric Strikes for rim exit devices

Features:

- Furnished standard in fail secure configuration unless specified fail safe
- 24 VDC supplied standard if not specified otherwise
- Available finishes on a stainless steel construction: US3 Polished Brass; US4 Satin Brass; US10 Satin Bronze, clear coated; US10B Dark Bronze, Oil Rubbed; BHMA 629 / US32 Bright Stainless Steel; BHMA 630 / US32D Satin Stainless Steel
- Compatible with Von Duprin and Falcon rim exit devices and those of many other manufacturers
- Specify when using these strikes with a 55 rim device
- UL1034 burglary-resistant

Model	Fire Rated	Throw	Hollow Metal	Wood	Aluminum	Single	Mullion Pair
6111	■	3/4"	■	■	■	■	Can be used with vertical rod exit devices
6112	■	3/4"	■	■	■	■	Designed to replace FA 310-5 with minor frame modification
6113	■	3/4"	■	■	■	■	
6114		3/4"	■		■	■	Surface applied for use with rim nightlatch devices
6121		3/4"	■	■	■		* * For rim exit devices on double doors without mullion

For specified options and complete parts list, please see Von Duprin pricebook.

6200 Series Von Duprin Electric Strikes for mortise or cylindrical locks

Features:

- Furnished standard in fail secure configuration unless specified fail safe
- 24 VDC supplied standard if not specified otherwise
- Available finishes on stainless steel construction: US3 Polished Brass; US4 Satin Brass; US10 Satin Bronze, clear coated; US10B Dark Bronze, Oil Rubbed; BHMA 629 / US32 Bright Stainless Steel; BHMA 630 / US32D Satin Stainless Steel
- Compatible with mortise (without deadbolt) and cylindrical lock applications except where noted
- ANSI/BHMA 156.31 Grade 1: 6211, 6211AL and 6211WF
- UL10C fire rated (fail secure only)
- UL1034 burglary-resistant

Model	Fire Rated	Throw	Hollow Metal	Wood	Aluminum	Single	Mullion Pair
6210	■	3/4"	■		■	■	Mortise only. Includes strike pocket inserts to accommodate deadlocking triggers
6211	■	3/4"	■		■	■	Retrofits VD 3140 or FA 712
6211AL	■	3/4"			■	■	Retrofits FA 722
6211WF	■	3/4"		■		■	Retrofits FA 732 with minor frame modification
6212	■	3/4"	■		■	■	Fits modified ANSI 115.2 cutout. Retrofits VD 3146.
6212WF	■	3/4"		■		■	
6213	■	3/4"	■	Retrofits only	■	■	Retrofits VD 3041, 3042, 3061 and 3062
6214	■	3/4"	■		■	■	Retrofits FA 310-2 3/4
6215	■	3/4"	■		■	■	Retrofits FA 310-2
6216	■	3/4"	■	■	■	■	Retrofits FA 310-3-1. For mortise with deadbolt 1" throw. Deadbolt must be manually operated
6221	■	3/4"	■	■	■	■	Open back, retrofits VD 3071 and 3072. 4-3/4" minimum stile required
6222	■	3/4"	■	■	■	■	Open back, retrofits FA 310-2 3/4 OB
6223	■	3/4"	■	■	■	■	Closed back, retrofits VD 3091 and 3092. 4-3/4" minimum stile required
6224	■	3/4"	■		■	■	Closed back, retrofits FA 310-2 3/4. For door thicknesses 1-3/4" or 2-1/4"
6224AL	■	3/4"			■	■	Closed back, retrofits FA 310-ZRF. For door thicknesses 1-3/4" or 2-1/4"
6225	■	3/4"	■		■	■	Open back, retrofits FA 310-2 OB
6226	■	3/4"	■		■	■	Closed back, retrofits FA 310-2. For door thicknesses 1-3/4" or 2-1/4"

For specified options and complete parts list, please see Von Duprin price book.

Pricing/product description subject to change without notice.

6300 Series Von Duprin Surface Mount Electric Strike for rim exit devices

Features:

- Dual voltage: 12 VDC at 0.50 A / 24 VDC at 0.24 A
- Finish: BHMA 630 / US32D stainless steel, satin finish
- Compatible with most rim exit devices
- UL1034 burglary-resistant
- UL 10C 3-hour fire rated (fail secure only)
- UL 294 listed for access control system units
- CSFM California State Fire Marshal listed

Model	Fire Rated	Throw	Hollow Metal	Wood	Aluminum	Single	Mullion Pair	
6300	■	3/4"	■	■	■	■	■	No cut, surface mount design

For specified options and complete parts list, please see Von Duprin priceook.

PS914 Von Duprin Power Supply

See Von Duprin Exit Hardware & Parts Price Book

4A @ 12/24 VDC – field selectable

- Designed for high inrush current
- UL 294 Listed for Access Control
- Class 2 rated power limited output
- Universal 120-240 VAC input
- Regulated and filtered DC outputs
- LED indicators: AC input (visible on outside of enclosure) and DC output
- 2 connectors for optional distribution boards
- AC monitoring
- 14" H x 12" W x 4" enclosure

Von Duprin Delayed Exit System

DE5300 Series

See Von Duprin Exit Hardware & Parts Price Book

Application	
	<ul style="list-style-type: none"> • Designed to meet NFPA 101 "Special Locking Arrangement" applications • Ideal for controlled areas • Addresses life safety and security needs • Commonly used on narrow stile doors where a standard narrow stile Chexit is not practical

Von Duprin Electric Power Transfer

EPT

See Von Duprin Exit Hardware & Parts Price Book

Application	
	<ul style="list-style-type: none"> • Provide a means for transferring electrical power from a door frame to the edge of a swinging door • Units are completely concealed when the door is in the closed position • Ideally suited for applications involving abuse or heavy traffic
Popular Models	<ul style="list-style-type: none"> • EPT-2: Two 18 gauge wires; Up to 2 amps @ 24VDC, with a 16 AMP maximum surge • EPT-10: Ten 24 gauge wires; Up to 1 amp @ 24VDC, with a 16 AMP maximum surge

See 2018 Von Duprin Exit Hardware & Parts price book for pricing and complete information.
Additional electrified products available in the IVES price book & the LCN price book.

Von Duprin Remote Undogging and Remote Monitoring

Modular Retrofit Option for 98/99 and 33A/35A Series Devices

Model #	Description	List Price
47258681	Remote Undogging (RU) 3' kit	\$949.00
47258682	Remote Undogging (RU) 4' kit	\$949.00
47258683	Remote Monitoring (RM) 3' kit	\$725.00
47258684	Remote Monitoring (RM) 4' kit	\$725.00

Reference Notes

- Access control managed via an IP or RS1/RS-485 connection to the ENGAGE gateway through Allegion software alliance members, consult your access control software provider for specific scope of support.
- ENGAGE gateway sold separately.
- Compatible with 98/99 and 33A/35A series rim, SVR, CVR, CVC and 3-point devices.
- Specify CON for Allegion Connect
- RU option:
 - Enables both remote undogging and door status monitoring (DPS, RX and LX)
 - Not compatible with exit devices with the following options: QEL, DI/CDSI/HDSI, RX2, Schlage AD/CO Trim, SD, SS, PN, E-Strikes/Pullman Latch, CX
 - Compatible device lengths: All 33A/35A and 98/99 device types – 3' (914 mm) length to 2' 9" (838 mm), 4' (1219 mm) length to 3' 3" (991 mm)
- RM option:
 - Enables door status monitoring (DPS, RX and LX) only
 - Not compatible with exit devices with the following options: DI/CDSI/HDSI, RX2, Schlage AD/CO Trim, SD, SS, PN, E-Strikes/Pullman Latch, CX
 - If the door and exit device are fire rated, and the exit device type is a 98/99-F Rim manufactured prior to April 1, 2018, a new center case will be required before proceeding with the installation of the RM kit. 98/99-F Rim Center Case Kit Less Cover, part number 050026.

Pricing/product description subject to change without notice.

BIOMETRICS - TABLE OF CONTENTS	
BIOMETRICS OVERVIEW	268
HOW TO ORDER	269
BIOMETRIC HANDREADERS	270
Memory Options	270
Communication Options	270
Card Reader & Keypad Options	271
Outdoor Options	271
Power Options	271
BIOMETRIC ACCESSORIES	272
Network Accessories	272
Miscellaneous Accessories	272
HandNet Software	272
Extended Warranty	272
Training Courses	272
BIOMETRIC PARTS	273

CONTACT INFORMATION FOR BIOMETRIC HANDREADERS

Email Order To: sbsom@allegion.com
 Fax Order To: 800-452-0665
 Payment Address: Recognition Systems, Inc
 15934 Collections Center Drive
 Chicago, IL 60693

877-671-7011	
Customer Service:	Technical Support:
General Sales Questions, Order Status, Credit Returns of Non-Defective Products	Technical Questions/Issues, Returns of Defective Products, Repairs
Email Orders To: Order_Entry_Schlage_Commercial@allegion.com	877-671-7011 Readers_Credentials_Biometrics_TechProdSupport@allegion.com

For Biometric Handreaders Warranty Information please see section 18 of Terms and Conditions (page 5).

Pricing/product description subject to change without notice.

Biometrics Overview



Schlage brings the security and convenience of biometric technology to any access control system with the HandKey II hand geometry readers. By using your hand as your credential, this technology provides reliable one-to-one matching - personal proof that people are who they claim to be.

Schlage biometric HandReaders can also be integrated with other reader technologies such as smart card, proximity or magnetic stripe, to provide a highly secure system that verifies who you are in one transaction.

The benefits of using HandReaders are:

- Fast and easy to use
- Field-proven reliable technology
- Integrates into existing access control systems
- Increases convenience by eliminating cards
- Lower administrative costs compared to card-based systems
- Standalone or networked options

Purchase Orders:

Fax purchase orders to: 800-452-0665

All purchase orders must include the following information:

- Purchase order number
- Invoice address
- Ship to address
- Shipping method
- Part number
- Pricing
- Any special configuration ID #s
- Any options requiring factory installation

Missing or inaccurate information may cause a delay in the order process.

Quick Turn Program:

A quick turn program is available for urgent orders up to 10 units (11 or more, please call the factory directly).

- A 15% premium charge is applied to the total order for items requiring a one day turn
- A 5% premium charge is applied to the total order for items requiring a three day turn

All orders must be received by 11:00 am PT to count as one day.

Purchase orders must include the premium charge as a separate line item.

Quick Turn may not be available on all items (Please contact the factory for expedited availability).

Payment Terms:

Please refer to the October, 2017 Terms and Conditions.

Order Changes/Cancellations:

Please refer to the October, 2017 Terms and Conditions.

Packing:

Company will pack, mark, and ship the Products according to its standard procedures for shipment, unless the parties agree, in writing, that Company will comply with any special instructions provided by Customer. Compliance with special instructions may result in an increased price.

HandKey F Series

Polycarbonate housing. Expanded memory options are available.

HK-2-F3	HandKey F Series with memory for 512 users	\$2,817.00
----------------	--	-------------------



HandKey-2
Hand Geometry Reader

Memory Options

Memory expansions can be factory configured when ordered with the HandReader. For field expansions, the serial number on the main board must be supplied with the order so that an authorization code can be generated.

Note: Credit will not be given for field installed memory expansion returns.

F Series

Readers built after 2003 or readers that have been upgraded to main boards with a push button reset switch.

EM-801-F3	HandKey Memory Expansion to 9,728 users	\$272.00
EM-803-F3	HandKey Memory Expansion to 32,512 users	\$599.00
EM-813-F3	HandKey Memory Expansion to 64,768 users (non field upgradeable)	DISCONTINUED
EM-823-F3	HandKey Memory Expansion to 129,536 users (non field upgradeable)	DISCONTINUED
EM-833-F3	HandKey Memory Expansion to 194,304 users (non field upgradeable)	DISCONTINUED
EM-843-F3	HandKey Memory Expansion to 259,072 users (non field upgradeable)	DISCONTINUED

Communication Options

F Series

EN-201	Ethernet Communication Module 10baseT (supercedes part number EN-200)	\$411.00
MD-500	Internal 14.4K Baud Dial-Up Modem. Contact sales for international compatibility	\$468.00

Card Reader & Keypad Options
F Series

PROX	Externally top mounted Proximity RF Reader <i>Factory option only, not available for field installation</i>	\$416.00
SC-100	Integrated side mounted Mifare® Classic Smart Card Reader with external clear acrylic card holder <i>Factory option only, not available for field installation</i>	\$1,172.00
ICLASS	Internally installed Legacy iCLASS® Reader with external clear acrylic card holder <i>Factory option only, not available for field installation</i>	DISCONTINUED

Outdoor Options
F Series*

INT-HTR	Outdoor Platen Heater. Factory option only, not available for field installation** Includes 24 VDC power supply to operate HandKey	\$649.00
FX-ENCL	Polyethylene with UV Resist Outdoor Enclosure (supersedes model # HURCNE)	\$489.00
TX-ENCL	Metal Watertight Enclosure (supersedes model # TSNAMI)	\$1,980.00

Power Options
F Series

PS-110	Power Supply. 120 VAC to 13.5 VDC with connector	\$54.00
PS-220	Power Supply. 220 VAC to 13.5 VDC with connector	\$65.00
BB-250	Battery Backup available only at the time of initial purchase	\$109.00

* Lead times for enclosures are subject to be extended to four weeks

** Not compatible with the SC-100

Network Accessories

DC-102	Data Converter for 4 wire system, RS-232 to RS-422 with 120V, 60 Hz power supply	\$170.00
DC-102-220	Data Converter for 4 wire system, RS-232 to RS-422 with 220V, 50 Hz power supply	\$170.00

Miscellaneous Accessories

BG-200	Demo Bag for E and F Series readers	\$68.00
BR-100	5V Relay	\$124.00
DS-200	Demo Stand for F Series readers	\$91.00
TM-100	Table-top Secure Mount for F Series	\$312.00

HandNet Software

HN-2-T1	Tier One: Up to 5 HandKeys	\$930.00
HN-2-T2	Tier Two: Up to 25 HandKeys	\$1,566.00
HN-2-T3	Tier Three: Unlimited HandKeys	\$2,293.00
HN-T1-T2	Tier Upgrade: T1-T2 from 6 to 25 HandKeys	\$1,538.00
HN-T1-T3	Tier Upgrade: T1-T3 from 6 to unlimited HandKeys	\$1,619.00
HN-T2-T3	Tier Upgrade: T2-T3 from 25 to unlimited HandKeys	\$976.00

Extended Warranty

EXT-WAR	1 year extended warranty (available at the time of initial biometrics reader purchase only)	\$315.00
----------------	---	-----------------

Training Courses and Support Services

Note: Prices are as posted. No discounts apply.

SBT-HK	1-day training course at an Allegion facility. User will be able to install, program and troubleshoot the hardware functions of the HandKey upon completion of the course.	\$150.00 per person
SBT-HK-ONSITE	1-day training course at customer site. User will be able to install, program and troubleshoot the hardware functions of the HandKey upon completion of the course (max 10 trainees per classroom).	\$1,200.00 per day plus expenses
SBT-HNWL	1-day training course at an Allegion facility. User will be able to install, program and troubleshoot the access control software (HandNet for Windows and HandNet Lite) on HandKeys.	\$150.00 per person
SBT-HNWL-ONSITE	1-day training course at customer site. User will be able to install, program and troubleshoot the access control software (HandNet for Windows and HandNet Lite) on HandKeys (max 10 trainees per classroom).	\$1,200.00 per day plus expenses
SS-SVC	Schlage Biometrics Support – Support Services Professional support services to assist business partners, dealers, and solution providers with services involving the F Series handreaders. A quote for services will be provided.	\$150.00 per hour

Main Boards

Note: Replacing any main board in the field creates a risk of the HandKey falling outside of acceptable calibration range. It is recommended that units be sent back to the factory to have the main board calibrated to the camera. Price does not include memory upgrades. Custom configurations must be noted on PO.

F Series

S-PC-HK2-RB	HandKey II Main PCB Battery Backup Ready	\$822.00
--------------------	--	-----------------

Top Panels
F Series

S-TP-HK2	HandKey II Top Panel Assembly	\$405.00
-----------------	-------------------------------	-----------------

Power Options
F Series
Field Upgradeable Battery Backup Options

BB-200	Operational Battery Backup with power management board for reader with serial numbers below 1345000	\$109.00
S-BB-BAT	Operational Battery Backup for readers with serial numbers higher than 1362000, Spare Battery for BB-250	\$79.00

Overlays
F Series

OVLV HK-2	HandKey II Overlay	\$73.00
------------------	--------------------	----------------

Terminal Strips

F Series

Readers built after 2003, or readers that have been upgraded to main boards with a push button reset switch.

S-TS-F02	Terminal Strip / connector 2 pin (pack of 5)	\$68.00
S-TS-F03-F3	Terminal Strip / connector 3 pin - F3 (pack of 5)	\$68.00
S-TS-F04-F3	Terminal Strip / connector 4 pin - F3 (pack of 5)	\$68.00
S-TS-F06-F3	Terminal Strip / connector 6 pin - F3 (pack of 5)	\$68.00
S-TS-F08-F3	Terminal Strip / connector 8 pin - F3 (pack of 5)	\$68.00
S-TS-FPK-F3	Terminal Strip / connector pack - 2, 3, 4, 6, 8 pin (F3 Series)	\$68.00

F Series Original Generation

Readers built before 2004, can be identified by a 5 position DIP switch.

S-TS-F02	Terminal Strip / connector 2 pin (pack of 5)	\$68.00
S-TS-F06	Terminal Strip / connector 6 pin (pack of 5)	\$68.00
S-TS-F08	Terminal Strip / connector 8 pin (pack of 5)	\$68.00
S-TS-F12	Terminal Strip / connector 12 pin (pack of 5)	\$68.00
S-TS-FPK	Terminal Strip / connector pack - 6, 8, 12 pin	\$68.00

EPROMS

F Series

Contact technical services for assistance selecting the proper version.

S-PR-F00-F3	EPROM Upgrade current F Series	\$39.00
--------------------	--------------------------------	----------------

Platens

F Series

S-PL-F30	Complete platen assembly with antimicrobial and blue hand outline	\$217.00
S-PL-F	Platen overlay with antimicrobial and blue hand outline	\$108.00

Keys

F Series

S-KY-F00	Spare Keys (pack of 5)	\$91.00
-----------------	------------------------	----------------

Mounting Kits

F Series

S-RP-F00	Back Plate, rear sheet metal with hardware. Note: Serial numbers are required for a new label	\$65.00
S-WM-F00-F3	Wall Mount Bracket with hardware	\$87.00

Shipping Boxes

S-SB-F00	F Series Shipping Box with foam inserts	\$41.00
-----------------	---	----------------

Ship Kits

S-SK-HK-2-CR	Replacement Ship Kit for HandKey II	\$169.00
---------------------	-------------------------------------	-----------------

Cables

F Series

S-CB-232-F3	RS-232 Cable 50'	\$36.00
--------------------	------------------	----------------

MISCELLANEOUS - TABLE OF CONTENTS

AGENCY LISTING	276
DOOR HANDING	278
SYSTEM DESIGN GUIDE	281
KEY SYSTEM SUMMARY	283
WIRING DIAGRAMS	297
BAA/ARRA COVER LETTER	301

Agency Listings



Product	Listing	Standard	Agency
M420/M420P	Builders Hardware - Aux. Locks	UL 10C/UL 1034/UL 294	UL/cUL CSFM
M450/M450P	Builders Hardware - Aux. Locks	UL 10C/UL 1034/UL 294	UL/cUL CSFM
M490/M490P	Builders Hardware - Aux. Locks	UL 10C/UL 1034/UL 294	UL/cUL CSFM
M490DE	Builders Hardware - Aux. Locks	UL10C UL294 Special Locking Arrangement including BOCA	UL/cUL CSFM
M390RFK	Builders Hardware - Aux. Locks	UL 10C UL/cUL	UL/cUL CSFM
490G	Builders Hardware - Aux. Locks (outdoor rated)	--	--
320 series M suffix	Builders Hardware- Aux. Locks	UL10C	UL/cUL CSFM
GF3000 (surface mount)	Builders Hardware- Aux. Locks	UL10C	UL /cUL
GF3000 (mortise mount)	Builders Hardware-Aux. Locks	UL10C	UL/cUL CSFM
PS902	Power Supply	UL294	UL/cUL FCC Part 15 and Rotts Compliant
PS904	Power Supply	UL294	UL/cUL FCC Part 15 and Rotts Compliant
PS906	Power Supply	UL294	UL/cUL FCC Part 15 and Rotts Compliant
900-2RS	Power Supply Option Board	UL294	UL/cUL
900-4R/900-4RL	Power Supply Option Board	UL294	UL/cUL
900-8P/900-8F	Power Supply Option Board	UL294	UL/cUL
900-FA/900-BB	Power Supply Option Board	UL294	UL/cUL
672 series All models including BRG	Access Control System Units Burglary Resistant Electric Locking Mechanism Accessory	UL294 UL1034	UL UL
692 series All models including BRG	Access Control Systems Units Burglary Resistant Electronic Locking Mechanism Accessory	UL294 UL1034	UL UL
7764 switch	Connectors and Switches Misc Fire Door Accessories	UL634 UL10B	UL-multiple listing UL-multiple listing
7766 switch	Connectors and Switches	UL634	UL-multiple listing
8200 series	Access Control Units	UL294	UL
SCAN-II-W SCAN-II-B	Access Control System Units	UL294	UL-multiple listing

Listed Electromagnetic Locks

A156.23-2010

ANSI Type Numbers Licensee's Catalog

ANSI Function Number	Designations		
	1500 lbf Rating	1000 lbf Rating	500 lbf Rating
E18501	M490, M490P, M390RFK	M450, M450P, 70	M420, 420P, 40
E18511	M492, M492P	M452, M452P, 72	M422, M422P
E18531	M490-TJ, M490P-TJ	M450-TJ, M450P-TJ, 70-TJ	M420-TJ, M420P-TJ, 40-TJ
E18541	M490-HDB, M490P-HDB	M450-HDB, M450P-HDB, 70-HDB	M420-HDB, M420P-HDB, 40-HDB
E08501	M490G ¹		
E08531	M490G ¹		
E08561	GF3000, GF3000TJ		
E08571	280		
E08581	GF3000, 280		
E08591	GF3000, 280		
E08601	GF3000BRD		

1. Outdoor rated lock.

All of the above available in 12VDC or 24VDC.

Finish Type	Certified Finishes
Clear Anodized Aluminum	Licensee's Catalog Designations
Satin Black, Anodized	628
	335

AD-Series and CO-Series Electronic Locks

Product	Standard
AD-Series & CO-Series	UL294
	UL10C
	BHMA/ANSI 156.25 Grade 1 Operation and Security
	A156.2
	A156.3
	A156.12
	A156.13
	NFPA 101 – Ch 7
	NFPA 80 – Ch 6 & 7
	IBC – Ch 10
	ADA – Ch 4.13
	FCC Part 15
	Industry Canada (IC) RSS-210
	Florida Building Code
	RoHS

Door and Frame Handing Chart

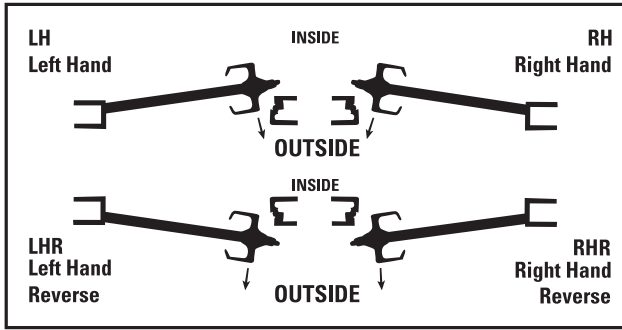

Door Handing from Reader Side



Architectural Finishes Chart

Finish Description	Finish #	BHMA #	Government
Bright Brass	605 or 666	605E	US3
Bright Chrome	625 or 672	625E	US26
Oil Rubbed Bronze, Anodized	690 or 313	690	US20A
Oil Rubbed Bronze	613 or 710	613E	US10B
Satin Aluminum, Clear Anodized	628	628	US28
Satin Black, Anodized	711 or 335	711	US19
Satin Brass	606	606E	US4
Satin Bronze	612 or 668	612E	US10
Satin Chrome	626	626E	US26D
Satin Stainless Steel	630	630	US32D
Oil Rubbed Bronze, Powder Paint	SP313		
Satin Black, Powder Paint	SP335		

Note: To preserve finishes, wipe clean with a soft cloth. Commercial cleaners may damage finish.

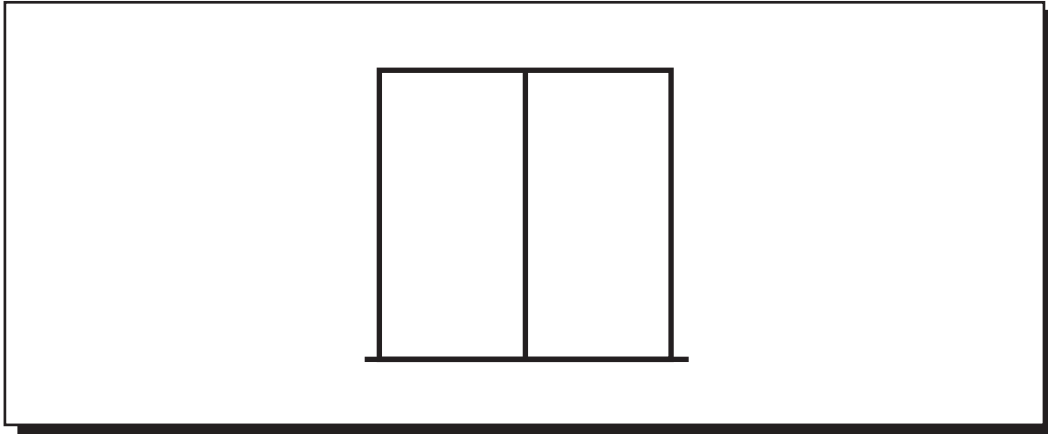

DESCRIPTION OF OPERATION

ELECTRIC LOCK

TYPE: VOLTAGE: CURRENT DRAW

OPTIONS

LOCK STATUS SW: DOOR STATUS SW

POWER SUPPLY

MODEL: VOLTAGE: CURRENT CAPACITY

OPTIONS

FIRE SYSTEM TIE-IN: STANDBY BATTERIES

CONTROL-ACCESS

TYPE:

CONTROL-EGRESS

TYPE:

MONITORING REQUIRED-DESCRIBE:

INTERLOCK REQUIRED-DESCRIBE:



MASTER KEY SYSTEM SUMMARY

This form must be attached to the **Master Key Order form and P.O.**
Please provide as complete and accurate as possible so we can provide what you need for your Key System.

Job Name
Address
City / State
Country

Account No.

P.O.#

For detailed instructions on how to complete this form please refer to pages 4 & 5

System Overview

- New Existing (provide info below)
- Attached Dealer Specified Combinations Registry # _____
- Structure or
Factory Order # _____

I. Select System

Schlage

- Classic
- Classic Primus *

Everest®

- B (Small Format IC, Restricted *)
- C (Open)
- Primus® *
- D (Restricted *)
- Primus® *

Everest 29™

- R (Small Format IC, Restricted *)
- S (Open)
- Primus® *
- T (Restricted *)
- Primus® *

Falcon

- Standard
- Schlage C
- Restricted *
- Interchangeable Core A2
- Interchangeable Core A4

Everest 29 key sections are backwards compatible to Everest keyways and have the following relationships:

R family sections > B family keyways
S family sections > C family keyways
T family sections > D family keyways

Type

- 5-pin 6-pin 7-pin
- See compatibility chart on page 5*

Keyway _____
Specified **: _____

** = The Commercial Master Key Department makes the final decision in the selection of key sections

Construction Keyed Yes No

Full Size Construction Cores ICA ICB ICC
(Schlage Only)

Small Format Construction Cores Brown Green

Construction Keyed Type

- Falcon CK (BOK) Lost Ball
- Schlage CK (Split) RCK (5-Pin C only)

2. Select Keys & Key Stamping

Change Keys

No. Of Keys per Symbol _____

No. Of Keys per Cylinder _____

Type

Standard Bow

Standard Bow
(Unembossed)

Access Bow
(Schlage Only)

Large Bow

Key Stamp Details

Keyset Symbol

Do Not Duplicate
(DND)

With Custom Die
(Specify) _____

Non-standard Code (Specify) _____

Change Key Packaging and Shipping Instructions

Pack Keys Independently (PKI) of Lock or Cylinder ***

*** = *Furnished standard at no charge with
Split-Key construction keying*

Yes No

If PKI, ship change keys to:

Dealer

Other _____

See Primus Facesheet

3. Select Cylinder Stamping

Cylinder Stamp Details

With Industry Standard Key Symbol

Non-Standard Code (Specify)

Cylinder Stamping Location

Plug Face (N/A in Primus) - VKC

Concealed (N/A in Falcon STD) - CKC

4. Select Key Quantities

Level	Qty. Per	Master Key Symbol (s)	Total Quantity
GGM _____	_____	_____	_____
GM _____	_____	_____	_____
MK or RMK _____	_____	_____	_____
Control _____	_____	_____	_____
Emergency _____	_____	_____	_____
Others _____	_____	_____	_____

Ship Master Keys To:

Dealer
 See Primus Facesheet
 Other _____

Special Function	Qty. Per		Qty. Per
RCK (Lost Ball) ****	_____	Full Size Construction Core Keys (Schlage Only)	_____
CK (Split Key) ****	_____	Full Size Construction Core Control Keys (Schlage Only)	_____
Extractor Tools ****	_____	Small Format Construction Core Keys	_____
		Small Format Construction Core Control Keys	_____

**** = Use with Construction Keying

5. Master Key Future Expansion

List Future MK Symbols	Approx. # of Change Key Symbols Under Each Future MK
Example: MK..... <input checked="" type="checkbox"/>	BJ, BK _____ 40 each _____
GGM_ <input type="checkbox"/>	_____
GM_ <input type="checkbox"/>	_____
MK_ <input type="checkbox"/>	_____
MK_ <input type="checkbox"/>	_____
MK_ <input type="checkbox"/>	_____
MK_ <input type="checkbox"/>	_____
Others_ <input type="checkbox"/>	_____

6. Operating Instructions

(Unless otherwise specified, all hierarchical master keys will operate cross-keyed cylinders)

Cross Keyed Cylinder	is operated by these change keys	Cross Keyed Cylinder	is operated by these change keys
X _____	_____	X _____	_____
X _____	_____	X _____	_____
X _____	_____	X _____	_____
X _____	_____	X _____	_____

7. Instructions and Compatibility

General Information

If you do not know the registry number (R#), structure number or the original factory order number for an existing system, contact Customer Service prior to placing the order:

Tel. 1-877-671-7011
Fax 1-800-452-0663

- Only one structure may be ordered on the same purchase order
- Classic refers to Obverse, Numbered (Paracentric), Quad, and Reverse key section families
- Classic Primus refers to Primus Obverse and Primus Quad key section families

Section 1: System a System

Full Size Construction Cores

- Schlage only

Small Format Construction Cores

- 7-pin only for Schlage
- 6- and 7-pin for Falcon

CK (Split)

- 6-pin for Schlage and Falcon
- Split key construction keying is not available for Classic Primus or Everest 29 Primus

RCK (Lost Ball)

- 5-pin (C keyway) only for Schlage
- 5-, 6-, and 7-pin for Falcon

System Selection

- Refer to the compatibility chart

Section 2: Select Kys and Key Stamping

Stamp Details

- Unless otherwise specified, industry standard key symbols are stamped on Everest 29™ and Primus® keys
- For custom die, attach RFQ approval for Schlage

Section 3: Select Cylinder Stamping

Type

- For cylinder type refer to the compatibility chart

Keyway (specify)

- Schlage Commercial's default key section for new Master Key Systems is Everest™ S145

Section 4: Key Quantities

Level

- Unless otherwise specified, the control key has the same cut as the highest-level key in the system (Except SFIC systems)

Special Function

- Construction keys are not furnished unless specified

Change Keys

- Unless otherwise specified 2 change keys are furnished per lock or cylinder

Section 5: Master Key Future Expansion

- Do not use the letters “I”, “O”, “CK”, “KA”, or “KD” for any master key symbols

Section 6: Operating Instructions

- Cross keying reduces the security and expansion of key systems
- Unless otherwise specified, all hierarchical master keys will operate cross-keyed cylinders

Compatibility Chart

	5 Pin	6 Pin	7 Pin	Split Key	Block O-Key	Lost Ball	Tempe Core	A2	A4	0.025	0.018
Schlage											
Classic	X	X		X		X	X				
Everest 29 S		X		X			X				
Everest 29 T		X		X			X				
Everest 29 R			X				X	X			
Classic Primus (XP)		X					X				
Everest 29 Primus (XP)		X					X				
Falcon											
Open	X	X	X		X	X					X
Restricted		X	X		X	X				X	
Schlage C		X		X							
SFIC Open		X	X				X	X	X		
SFIC Restricted		X	X				X	X	X		



MASTER KEYED ORDER

This form must be attached to the MASTER KEY SYSTEM SUMMARY FORM

Excel Soft copy - Print Instructions:
To avoid printing more sheets than needed,
select <Print>, from the print screen select
<Print range>, then select <Pages> from
___ to ___ & click OK.

Please provide as complete and accurate as possible so we can provide what you need for your Key System

Quote #:		Account No.:			P.O. #:									
Shipping Instructions:		Mark Cartons:			Date:									
Order Written By:		Customer Name and Address:												
For Further Information Contact:		Ship to:												
Name:														
Phone:														
Fax:														
LINE ITEM	Items Ordered		OUTSIDE		INSIDE		DOOR #	KEY Symbol-(s)	MK Symbol-(s)	DR THK	EXT	DIM	ADDITIONAL DETAILS	
	QTY	PRODUCT	DESIGN	FINISH	DESIGN	FINISH								QTY

Sample Letter of Authorization For All Restricted Key Products



DISTRICT 10

**End User
Letterhead - REQUIRED**

District 10 Schools
555 Main Street
End User City, State 55555
(555) 555-5555

May 1, 2003

Date - REQUIRED

To: Schlage Dealer
100 East Avenue
Dealer City, State 11111

**Dealer Name -
RECOMMENDED**

**Include Registry
Number & Facility
Code (stamped on
keys) for existing
key systems**

RE: District 10, Jones Elementary School

Facility Name - REQUIRED

Please consider this authorization to ship product for the above-referenced project.

Jones Elementary School is to be keyed using a new Everest D Restricted Key System. For security reasons, we would like to have all keys for this facility shipped to a location other than the job site. Master keyed products, however, can be shipped directly to the site. This letter authorizes Schlage to ship our restricted products to the following addresses:

Master Keyed Products, Construction Keys, Locks Less
Cylinders, and Locks with Construction Cores

Attn: Building Project Manager
District 10 Schools
555 Main Street
End User City, State 55555

Master Keys, Change Keys, Control Keys, and Key Blanks

Attn: Locksmith
District 10 Lockshop
1201 Fifth Avenue
End User City, State 55555

**Authorized Ship-
To Addresses -
REQUIRED**

These two addresses above serve as our only authorized shipment addresses for all orders placed for our facility. We understand that this letter will be kept on file and referenced for our future orders and that a new letter is only required to add, remove, or change authorized shipping locations.

Sincerely,

End User Representative
Facilities Manager

**End User
Representative
Signature -
REQUIRED**

Letter may be mailed or faxed to Schlage
Schlage Restricted Order Processing
3899 Hancock Expressway
Colorado Springs, CO 80911

A library of common wiring diagrams are available at no-charge for use in single and double door applications utilizing various configurations of Allegion door hardware products. These diagrams can be accessed through our Knowledge Center tool at <http://kc.allegion.com/>. Click on *Common wiring diagrams* located under the column Top Solutions.

Custom Wiring Diagram Request

When common wiring diagrams do not meet the needs of the job requirements Allegion offers a service to purchase custom wiring diagrams. All custom wiring diagrams include a point-to-point with theory of operation and a riser diagram. Custom wiring diagrams fall into two categories; Standard and Complex:

- **Standard drawings:** All Allegion products with a single opening and a basic theory of operation. These drawings are quoted on a per drawing basis.
- **Complex drawings:** Generic contacts, 3rd party components, complex relay logic, timer circuit logic, any other additional advanced logic. These drawings must be processed through a quote process to determine the total NET cost of the request.

How does the Custom Wiring Diagram Request Process work?

- Custom wiring diagrams can only be ordered by and shipped to current Allegion Channel Partners
- Obtain a Wiring Diagram Request Form on page 69 or email a request to Wiring.Diagram.Request@allegion.com
- Email the completed request form to Wiring.Diagram.Request@allegion.com
- Be sure and include the following information to prevent delays to the request:
 - All supporting documentation for non-Allegion products
 - Hardware list with complete part numbers
 - Detailed Theory of operation for all openings
- Upon receipt the custom wiring coordinator will review and clarify the request as needed
- Once all clarifications are resolved a QUOTE#, NET pricing, and lead time will be assigned and communicated to the requestor within 1 business day
- Drawings that fall under a Standard type will be quoted a NET \$250 for each drawing
- Drawings that fall under a Complex type will receive a NET quote depending on the time required to complete the drawings at an hourly rate of \$250/hour
- A purchase order with the QUOTE# must be received for the wiring diagrams to be produced
 - Send the completed PO to Wiring.Diagram.Request@allegion.com
- Lead time is generally 2-3 weeks from time PO is received, more complex requests will have longer lead times
- Changes to the original request after a quote approval may incur additional charges and affect lead time
- QUOTE# is valid for 90 days
- Custom wiring diagrams, once completed, will be emailed to the requestor

Wiring Diagram Request Form



ALLEGION™

Must be a Schlage Electronics, LCN, or Von Duprin Dealer

=====

Date ___/___/___ Project Name _____

Dealer/Distributor _____

Account # _____ Dealer Contact Name _____ Phone ____-____-_____

=====

Provide a Primary Technical Contact _____ Phone ____-____-_____

=====

Provide/Attach the Following

- All supporting documentation for all non-Allegion products.
 - Included hardware list with complete part numbers.
 - Detailed Theory of Operation for all openings.

Additional information that helps expedite the project:

Door Number; Door Size; Door Material;
 Fire Rated Opening; Single/Pair; Double Egress; Interior/Exterior;
 Interlocked Opening; Basic Floor Plan/Traffic Flow

=====

E-mail completed form and supporting documentation to

Wiring.Diagram.Request@allegion.com

Phone: 877-671-7011

BAA Order Transmittal Cover Letter



Buy America Act and American Recovery and Reinvestment Act (BAA/ARRA)

*Note that orders requiring BAA compliant products MUST include this cover letter to
be properly identified.*

About Allegion

Allegion (NYSE: ALLE) creates peace of mind by pioneering safety and security. As a \$2 billion provider of security solutions for homes and businesses, Allegion employs more than 8,000 people and sells products in more than 120 countries across the world. Allegion comprises 27 global brands, including strategic brands CISA®, Interflex®, LCN®, Schlage® and Von Duprin®.

For more, visit www.allegion.com

KRYPTONITE ■ LCN ■  ■ STEELCRAFT ■ VON DUPRIN