



User's Guide
TouchScreen Deadbolt
with Alarm



CONTENTS

Security You Hear Instantly	2	Troubleshooting	10
Customer Service and Help	3	Factory Default Reset	11
Lock Parts	4	My Codes	12
Locking and Unlocking.....	5	Best Practices	12
Replacing the Batteries	5	Default Programming and User Codes	
Emergency Key Override	5	Locations	12
Programming the TouchScreen	6	Nexia Home Intelligence Functions	14
Finding your Default Codes	6	Function Descriptions.....	14
About Programming	6	The Nexia Home Bridge.....	14
Function Procedures.....	7	Function Procedures	14
Function Descriptions.....	7	Warranty and FCC/IC Statements.....	15
Programming the Alarm	8		
Powering the Alarm	8		
Adjusting the Sensitivity Level.....	8		
Changing the Alert Setting	9		
Alert Setting Descriptions.....	9		

NEED HELP?

Please call customer support before returning the product to the store.

Customer Service and Help

If you need us to help you, we are here for you!

	U.S.A.:	(888) 805-9837
Toll-Free Calling From:	Canada:	(800) 997-4734
	Mexico:	018005067866

Visit our web sites for videos,
FAQs and more:

Web: www.schlage.com

REGISTER YOUR PRODUCT

Document your purchase and register your warranty at RegisterMySchlage.com, or use the included registration card.

⚠ PLEASE KEEP THIS GUIDE ⚠

This guide contains important information about your lock!

- Default User Codes and Programming Code are located on the yellow sticker on the back of this guide! You will need these if you ever need to reset your lock back to factory default settings!
- Instructions for adding and deleting user codes, changing the lock behavior, troubleshooting, customer service and more are explained in this guide!
- The yellow sticker also contains your serial number, which may be needed for warranty and customer service support.

LOCK SETUP

Follow these steps to get your lock set up and ready to use.

1. More information coming soon.

LOCK PARTS

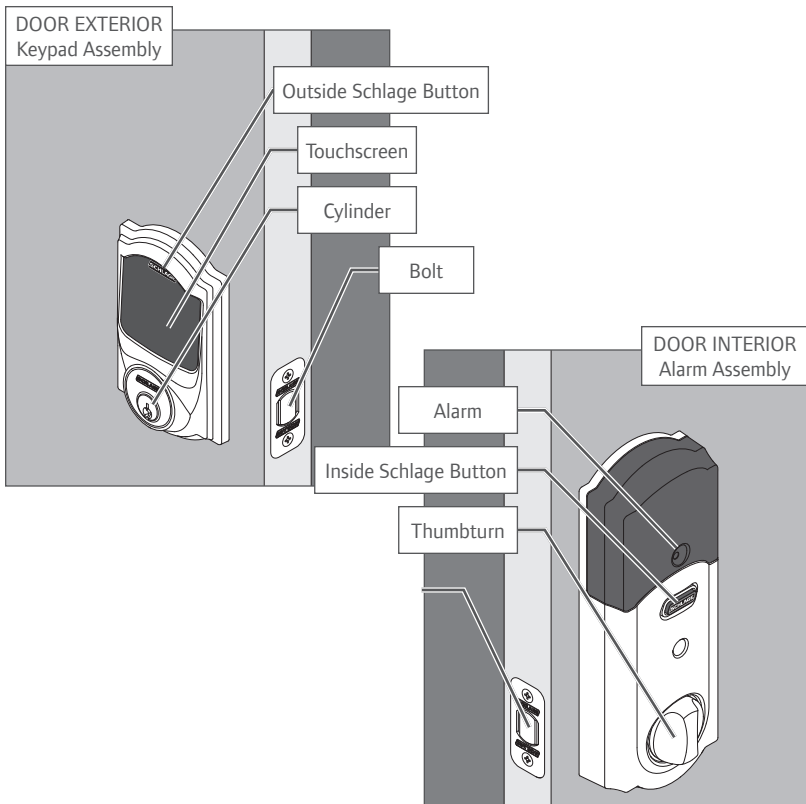

Inside Schlage Button

- Located on the inside of the door.
- Has three distinct lights and used to set and program the alarm. **Programming the Alarm** on page 8.
- This button does not lock or unlock the door.

Thumbturn

- Used to lock and unlock the door from the inside.

Outside Schlage Button

- Located on the outside of the door.

Touchscreen

- Remains unlit until the Outside Schlage Button is pressed.
- Located on the outside of the door.
- Used to enter codes for programming and unlocking.

Cylinder

- Used only in emergency situations to unlock the lock. **Emergency Key Override** on page 4.

Alarm

- Sounds alerts based on the chosen settings. **Programming the Alarm** on page 8.

Bolt

- Automatically extends and retracts when the touchscreen is used.
- Manually extends and retracts when the thumbturn is rotated.

EMERGENCY KEY OVERRIDE

Emergency Key Override can be used when the battery is completely dead, or when no valid User Code is known.

Insert key and rotate to unlock, just like any lock. See **Replacing the Batteries** on page 5.

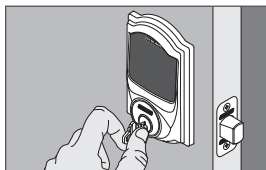

LOCKING AND UNLOCKING

① If you make a mistake while entering a User Code, press the Outside Schlage Button and start again.

Locking from the Outside

Press the Outside Schlage Button.
The lock will lock.¹

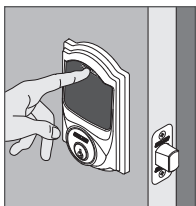

Locking from the Inside

Rotate the Inside Thumbturn.



¹ If the Lock & Leave feature is disabled, a valid User Code must be entered to lock the door. See **Enable/Disable Lock & Leave** on page 7.

Unlocking from the Outside

Press the Outside Schlage Button and then enter a valid User Code into the Keypad. The green success check mark will light and the lock will unlock.

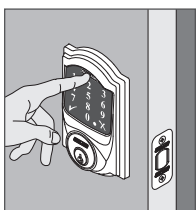

Unlocking from the Inside

Rotate the Inside Thumbturn.



If the red error X lights, the User Code was not valid.

REPLACING THE BATTERIES

① Replace the batteries in your lock at the same time each year that you test and replace the batteries in your smoke alarms. This will ensure continued reliable operation.

ELECTROSTATIC DISCHARGE WARNING!



DO NOT TOUCH the green board! You may damage the lock.

1. Remove the inside cover.

2. Unsnap the battery cable, remove the battery tray and replace the batteries.

3. Replace the battery tray with the batteries facing the door. Snap the battery cable to the tray and replace the cover.

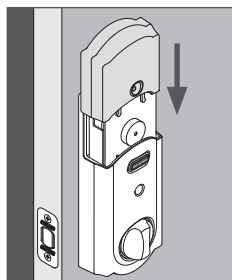
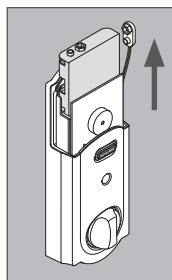
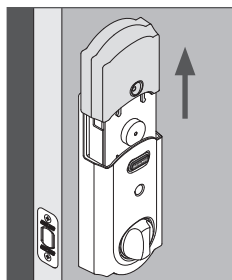

PROGRAMMING THE TOUCHSCREEN

Finding your Default Codes

Default Codes are located on the back of the Alarm Assembly, and on the back of this guide.

① Want to see a video of programming before you begin? Browse to www.schlage.com.

① The lock comes preset with a unique default Programming Code and two unique default User Codes. You can either use these codes to operate your lock or change them using the instructions in this guide.

① User Codes can also be programmed using the Nexia Home Intelligence System. Browse to www.nexiahome.com for more information.

Outside Schlage Button

The Schlage button is the first button you will press in the programming process.

Green Check Mark

Blinks when a number key is pressed and when a function is complete.

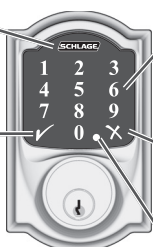

TouchScreen

Use the numbers on the TouchScreen to enter codes and for programming.

Red X

If there is a problem during programming, you will see the red error X.

Programming Indicator

Blinks while in Programming Mode.

Programming Procedures

① Extend the deadbolt before beginning.





① Determine how long you want your user codes to be BEFORE adding any user codes. If you change the user code length after adding user codes, all existing user codes will be deleted!

Function	Enter Programming Mode	Function Steps
Add User Code	SCHLAGE → 6 Digit Programming Code → ● →	1 → New 4-8 Digit User Code → Same New 4-8 Digit User Code → ✓ 2 blinks + 2 beeps
Delete User Code	SCHLAGE → 6 Digit Programming Code → ● →	2 → 4-8 Digit User Code → Same 4-8 Digit User Code → ✓ 2 blinks + 2 beeps
Change Programming Code	SCHLAGE → 6 Digit Programming Code → ● →	3 → New 6 Digit Programming Code → Same New 6 Digit Programming Code → ✓ 2 blinks + 2 beeps
Enable Vacation Mode	SCHLAGE → 6 Digit Programming Code → ● →	4 → ✓ 2 blinks + 2 beeps
Disable Vacation Mode	SCHLAGE → 6 Digit Programming Code →	✓ 2 blinks + 2 beeps

Programming Descriptions

Add User Code	User Codes are used for unlocking the lock. Codes can be 4 - 8 digits long. All codes must be the same length. See Change User Code Length .
Delete User Code	Removes one User Code
Change Programming Code	The Programming Code is used to put the lock into Programming Mode. It is 6 digits long.
Enable Vacation Mode	When Vacation Mode is enabled, no User Codes can be entered into the TouchScreen. This provides extra security while you are away from your home for an extended period of time.
Disable Vacation Mode	Returns lock to normal operation.
Enable/Disable Beeper	The beeper can be turned off if desired. Beeps will still sound during programming.
Delete ALL User Codes	Removes ALL User Codes from the lock.
Enable/Disable Lock & Leave	When Lock & Leave Mode is enabled, the lock can be locked from the outside by simply pressing the Outside Schlage Button. When disabled, a User Code must be entered to lock from the outside. This feature is enabled by default.
Change User Code Length	You can change the length of the User Codes in your lock. User Codes can be 4 - 8 digits in length. Default is 4 digits. <i>Changing the User Code length will delete all existing User Codes!</i>
Enable/Disable Auto Lock	When Auto-Lock is enabled, the lock will automatically relock itself 30 seconds after being unlocked. This feature is disabled by default.

- ① You can add or delete another User Code, without leaving programming mode. Press 1 or 2 respectively after the green success symbol and start at the Function Steps again.
- ② If you make a mistake, press the Outside Schlage Button to leave Programming Mode, and then start over. Programming Mode will automatically time out after 30 seconds of inactivity.

Function	Enter Programming Mode	Function Steps
Enable/Disable Beeper	 → 6 Digit Programming Code → ● → ● → 5 → ✓ Blinking	Enable: 2 blinks + 2 beeps Disable: 1 blink + 1 beep
Delete ALL User Codes	 → 6 Digit Programming Code → ● → ● → 6 → ✗ → 6 Digit Programming Code → ✓ Blinking	Wait for 3 blinks + 3 beeps → 6 Digit Programming Code → 3 blinks + 3 beeps
! Warning !	Removes ALL User Codes from the lock. User Codes cannot be retrieved after they are deleted!	
Enable/Disable Lock & Leave	 → 6 Digit Programming Code → ● → ● → 7 → ✓ Blinking	Enable: 2 blinks + 2 beeps Disable: 1 blink + 1 beep
Change User Code Length	 → 6 Digit Programming Code → ● → ● → 8 → Desired User Code Length → ✓ Blinking	2 blinks + 2 beeps
! Warning !	Changing the User Code length will delete all existing User Codes!	
Enable/Disable Auto Lock	 → 6 Digit Programming Code → ● → ● → 9 → ✓ Blinking	Enable: 2 blinks + 2 beeps Disable: 1 blink + 1 beep

PROGRAMMING THE ALARM

Powering the Alarm

The alarm is turned off by default. After installation, you'll need to turn on your alarm.

- ① Program the alarm using the Inside Schlage Button, shown below.
- ① Not sure your alarm is turned on? Simply press the Inside Alarm Button once. It will beep and light up to confirm it is activated. If it does not, try turning the alarm on again, and check the batteries.
- ① For videos and more, browse to alarm.schlage.com.

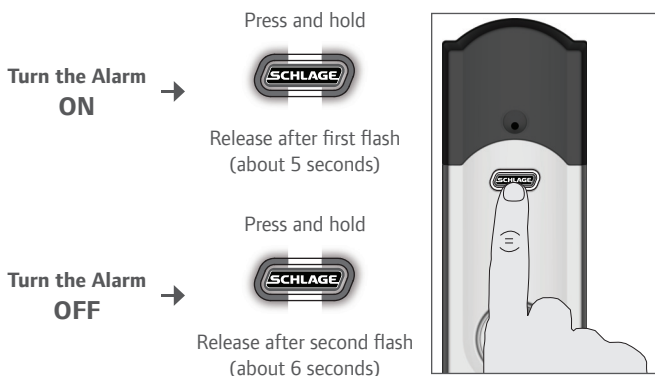

Adjusting the Sensitivity Level

The lock comes preset to a sensitivity level of three. If your alarm is sounding too frequently, or not frequently enough, try changing this setting.

- ① You do not need to adjust this setting unless the alarm is sounding too frequently or not frequently enough.

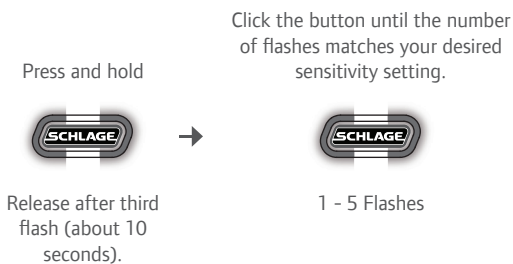

- ① As you cycle through the five levels, the alarm will beep the same number of times as each setting level.

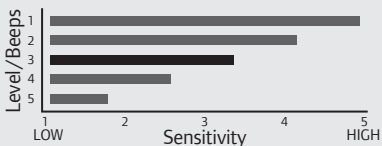



Changing the Alarm Setting

After you power on the alarm, it will be preset to the Forced Entry alert, by default. If you want to change it from Forced Entry to another alert setting, follow these simple steps:

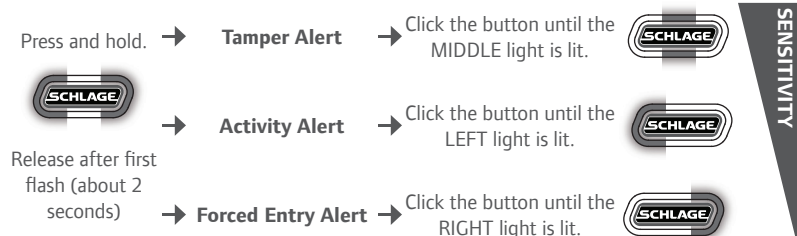
① **The alarm must first be powered on before changing the alert setting!**



Alert Setting Descriptions

ALARM	DESCRIPTION	TRIGGER	LIGHTS	SOUNDS
Activity	Perfect for monitoring doors while you're at home. <ul style="list-style-type: none"> • After the alarm is triggered, there is a built-in 3-second delay for it to reset 	Every time the door opens or closes	Middle LED light flashes 	Two short beeps
Tamper	As the most sensitive alert setting, the Tamper Alert senses even subtle activity at the lock, not just when the door opens, notifying you immediately of any tampering. <ul style="list-style-type: none"> • Built-in 60-second delay before device alarms allows you to exit and lock the door 	Every time the thumbturn/lock is disturbed	Left and right LED lights flash alternately 	15 second Alarm (90 dB=similar to the volume of your smoke alarm)
Forced Entry	Perfect for nighttime or when you're away from home. <ul style="list-style-type: none"> • Acts as an effective deterrent by instantly alerting you, and others nearby, at first impact against your door • Least sensitive mode – many choose to use this alert setting all the time 	Every time significant force pushes against the door—like when someone tries to kick it in.	All lights on the LED track flash 	Three-minute shrill, steady alarm (90 dB=similar to the volume of your smoke alarm)

① If you want to silence an alarm early, press and hold the Inside Schlage Button until the alarm sound stops.

TROUBLESHOOTING

PROBLEM	SOUNDS	LIGHTS	SOLUTION
Alarm sounds too frequently or false alarm	Alarm	—	Sensitivity level is too high (at 1 or 2) and should be adjusted to a less sensitive level (3, 4 or 5). See Adjusting the Sensitivity Level on page 8.
The tamper alert is not sounding.	—	—	There is a 60-second delay before device alarms to allow you to exit and lock the door. See Alert Setting Descriptions on page 9.
I forgot my Programming Code.	—	—	Check the back of this guide or the back of the Alarm Assembly for default Programming Code. If needed, restore lock to factory settings. See Factory Default Reset on page 11.
I need to delete a User Code that I don't remember.	—	—	Delete all User Codes. Then add all needed User Codes back into the lock. See Programming the TouchScreen on page 6.
User Code does not unlock lock.	1 beep	1 Red X	User Code entered is not a valid User Code.
User Code cannot be entered after Outside Schlage button is pressed	1 beep	1 Red X	Vacation Mode is enabled. Disable Vacation Mode. See Disable Vacation Mode on page 6.
User Code cannot be entered after Outside Schlage button is pressed.	1 beep	1 Red X	Too many incorrect User Codes have been entered. Wait 30 seconds and try again. If keypad does not respond after 30 seconds, then replace battery. See Replacing the Batteries on page 5.
User Code cannot be entered after Outside Schlage button is pressed	1 beep	1 Red X	Batteries are dead. See Replacing the Batteries on page 5.
Backlighting does not come on when Outside Schlage button is pressed and User Code cannot be entered.	—	—	Batteries are completely dead and no electronic operations are possible. See Replacing the Batteries on page 5.
After entering a User Code to unlock the lock, the yellow dot is flashing and there is a delay before unlock.	—	Yellow dot flashing	Battery is low and should be replaced. See Replacing the Batteries on page 5.
Inside Alarm Button is flashing but no alarms are sounding.	—	3 Red X flashes every 5 minutes	Battery is low and should be replaced. See Replacing the Batteries on page 5.
Pressing Schlage button when lock is unlocked does not cause lock to relock.	—	—	The Lock & Leave feature is not enabled. See Enable/Disable Lock & Leave on page 7.
Lock will not stay in programming mode.	—	Yellow dot flashing	An incorrect entry was made during the programming process.
Alarm will not sound.	—	—	Alarm is turned off.

PROBLEM	SOUNDS	LIGHTS	SOLUTION
Cannot add a new User Code	—	Yellow dot flashing	“1” was not pressed after entering programming mode.
	2 beep	2 Red X	30 User Codes already exist. Delete a User Code before adding a new one. See Delete User Code on page 6.
	2 beep	2 Red X	Second User Code entry did not match first User Code entry.
	2 beep	2 Red X	The new User Code matches the first 4 - 6 digits of the existing Programming Code.
Cannot delete a User Code	—	Yellow dot flashing	“2” was not pressed after entering programming mode.
	2 beep	2 Red X	First User Code entered did not match any current User Code.
	2 beep	2 Red X	Second User Code entered did not match first User Code entry.
Cannot change Programming Code.	—	Yellow dot flashing	“3” was not pressed after entering programming mode.
	2 beep	2 Red X	Second Programming Code entered did not match first Programming Code entered.
	2 beep	2 Red X	Programming code entered second time is incorrect.
	2 beep	2 Red X	First 4 - 6 digits of new Programming Code match an existing User Code.
Cannot delete all User Codes	—	Yellow dot flashing	“6” was not pressed after entering programming mode.
Deadbolt will not extend or retract as expected.	Several beeps	Red X flashing	Check door preparation to make sure the bolt is not jammed
			Batteries are weak and should be replaced.
NEXIA services are not available.	—	—	The lock has not been properly enrolled into a bridge.

Factory Default Reset

When should you perform a Factory Default Reset?

- If you want to move the lock to a different door
- If you have forgotten your Programming Code, you can restore the default codes

⚠ WARNING ⚠

Locate the default programming and User Codes on the back of this guide or the back of the Alarm Assembly before beginning! Default programming and User Codes will be restored. All existing User Codes and current Programming Code will be erased.

CUSTOMER SERVICE CANNOT RETRIEVE LOST DEFAULT CODES! DO NOT RESTORE FACTORY SETTINGS UNLESS YOU CAN LOCATE THE DEFAULT CODES.

1. Disconnect the batteries. See **Replacing the Batteries** on page 5.
2. Press and hold the Outside Schlage Button.
3. While holding the Outside Schlage Button, reconnect the batteries.
4. Release the Outside Schlage Button.

The lock will go through the setup routine again. See the **TouchScreen Deadbolt with Alarm Installation Guide** for more information.

MY CODES

Use these tables to record Programming and User Codes that you program into the lock.

The Programming Code can be any combination of six numbers entered into the keypad to put the lock in programming mode. The first 4 - 6 numbers (depending on User Code length) must be different from all of the User Codes currently in the lock. One Programming Code is programmed into the lock by default. This code can be found on the yellow stickers, one on the back of the Alarm Assembly and one on the back of this guide

① Use a pencil to enter the codes in the boxes so you can easily change them later.

User Codes

A User Code can be any combination of 4 - 8 numbers entered into the keypad to unlock the lock. These four digits must be different from the first four digits of the Programming Code. Two User Codes are programmed into the lock by default. These two codes can be found on the yellow stickers, one on the back of the Inside Alarm Assembly and one on the back of this guide.

① Up to 30 User Codes can be stored in the lock at one time.

Best Practices

- Give each person their own unique User Code.
- Change User and Programming Codes periodically to ensure security.

Default Programming and User Codes Locations

Codes are located on the sticker on the back of this guide. They are also located on the back of the Alarm Assembly.



The same codes are located in both places.

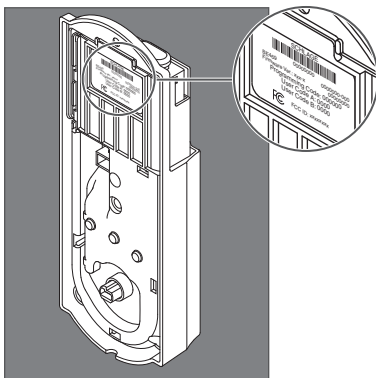

① DO NOT remove the sticker from the back of the lock! If you lose your programming code, you can reset your lock back to these default codes.

DATE			PROGRAMMING CODE			

USER NAME	USER CODE
Example: John Smith	1234
1.	
2.	
3.	
4.	
5.	
6.	
7.	
8.	
9.	
10.	
11.	
12.	
13.	
14.	
15.	
16.	
17.	
18.	
19.	
20.	
21.	
22.	
23.	
24.	
25.	
26.	
27.	
28.	
29.	
30.	

NEXIA HOME INTELLIGENCE FUNCTIONS

This lock is equipped with a Z-Wave radio, which allows it to integrate seamlessly with the Nexia Home Intelligence System. Enrolling is the process of adding the lock to your Nexia Home Intelligence account. To enroll the lock, you must first have a Nexia Home Bridge and Nexia Home Intelligence account.

- ① For more information about Nexia Home Intelligence, please browse to www.nexiahome.com.
- ② The Z-Wave radio is disabled by default to conserve battery life. When the lock is enrolled for the first time, the radio is automatically enabled.
- ③ If you no longer wish to use the Nexia Home Intelligence system, make sure to unenroll the lock to conserve battery life.

Function Descriptions

Enroll the Lock	Turns the Z-Wave radio on and enrolls the lock.
Verify Lock Enrollment	Verifies that the lock is enrolled in a Z-Wave network. You do not need to put the Bridge into enrollment mode for verification
Unenroll the Lock	Unenrolls the lock and turns the Z-Wave radio off.

The Nexia Home Bridge

To enroll the lock, you must first put your Nexia Home Bridge into enrollment mode:

1. Install a fresh, high-quality 9V battery into the Bridge.
2. Hold the Bridge within 6 feet (1.8 meters) of the lock throughout the entire enrollment process.
3. Press and release the **plus (+)** button on the Bridge.
4. Then perform the following functions on the lock.

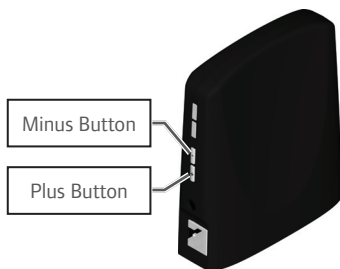

To unenroll the lock, you must first put your Nexia Home Bridge into unenrollment mode:

1. Install a fresh, high-quality 9V battery into the Bridge.
2. Hold the Bridge within 6 feet (1.8 meters) of the lock throughout the entire unenrollment process.
3. Press and release the **minus (-)** button on the Bridge.
4. Then perform the following steps on the lock.

Function Procedures

Function	Enter Programming Mode	Function Steps
Enroll the Lock	<p>SCHLAGE → 6 Digit Programming Code → ● → 9 →</p> <p>Blinking</p>	<p>✓ OR ✗</p> <p>The lock was enrolled. OR The lock was not enrolled.</p>
Verify Lock Enrollment	<p>SCHLAGE → 6 Digit Programming Code → ● → 0 → 1 →</p> <p>Blinking</p>	<p>✓ OR ✗</p> <p>The lock is enrolled. OR The lock is not enrolled.</p>
Unenroll the Lock	<p>SCHLAGE → 6 Digit Programming Code → ● → 0 → 0 →</p> <p>Blinking</p>	<p>✓ OR ✗</p> <p>The lock was unenrolled. OR Unenrollment failed. The lock is still enrolled.</p>

WARRANTY AND FCC/IC STATEMENTS

Lifetime Limited Mechanical and Finish Warranty and 1-Year Limited Electronics Warranty

Subject to the terms and conditions of the warranty, Schlage extends a lifetime limited mechanical and finish warranty and a one-year limited electronics warranty to the original consumer user ("Original User") of our Schlage brand product ("Product") against defects in material and workmanship, as long as the Original User occupies the residential premises upon which the Product was originally installed. See www.schlage.com for specific warranty details and limitations, or contact Schlage Customer Service at (888) 805-9837 in the U.S. and Canada or (800) 506-7866 in Mexico for assistance.

FCC Interference Statement

This equipment has been tested and found to comply with the limits for a Class B digital device, pursuant to Part 15 of the FCC Rules. These limits are designed to provide reasonable protection against harmful interference in a residential installation. This equipment generates uses and can radiate radio frequency energy and, if not installed and used in accordance with the instructions, may cause harmful interference to radio communications. However, there is no guarantee that interference will not occur in a particular installation. If this equipment does cause harmful interference to radio or television reception, which can be determined by turning the equipment off and on, the user is encouraged to try to correct the interference by one of the following measures:

- Reorient or relocate the receiving antenna.
- Increase the separation between the equipment and receiver.
- Connect the equipment into an outlet on a circuit different from that to which the receiver is connected.
- Consult the dealer or an experienced radio/TV technician for help.

This device complies with Part 15 of the FCC Rules. Operation is subject to the following two conditions:

1. This device may not cause harmful interference, and
2. This device must accept any interference received, including interference that may cause undesired operation.

Changes or modifications not expressly approved by the party responsible for compliance could void the user's authority to operate the equipment.

RF Exposure

To comply with FCC/IC RF exposure requirements for mobile transmitting devices, this transmitter should only be used or installed at locations where there is at least 20 cm separation distance between the antenna and all persons.

Under Industry Canada regulations, this radio transmitter may only operate using an antenna of a type and maximum (or lesser) gain approved for the transmitter by Industry Canada. To reduce potential radio interference to other users, the antenna type and its gain should be so chosen that the equivalent isotropically radiated power (e.i.r.p.) is not more than that necessary for successful communication.

Conformément aux normes d'Industrie Canada, ce transmetteur radio ne peut fonctionner qu'avec une antenne dont le type et le gain maximum sont approuvés par Industrie Canada. Pour réduire les risques d'interférences radio encourus par d'autres utilisateurs, le type et le gain de l'antenne doivent être choisis de façon à ce que la puissance rayonnée isotrope équivalente (PIRE) ne soit pas supérieure à celle nécessaire pour établir une bonne communication.

This Device complies with Industry Canada License-exempt RSS standard(s). Operation is subject to the following two conditions: 1) this device may not cause interference, and 2) this device must accept any interference, including interference that may cause undesired operation of the device.

Cet appareil est conforme norme Industrie Canada RSS exempts de licence (s). Son fonctionnement est soumis aux deux conditions suivantes: 1) cet appareil ne doit pas provoquer d'interférences, et 2) cet appareil doit accepter toute interférence, y compris les interférences pouvant provoquer un fonctionnement indésirable de l'appareil.

If you have questions about any part of installation or programming, don't return the Keypad Deadbolt with Built-in Alarm to the store. Our Schlage Customer Service representatives are ready to help.

Toll-Free: 1.888.805.9837

Live Chat: schlage.com

To learn more about this product, scan the code with your smartphone.

Download the app at scanlife.com.



Ingersoll Rand Residential Solutions, a business comprised of well-known brands like Schlage® and Trane®, delivers safety, comfort and efficiency to homeowners throughout North America. Our quality

Default Codes

Default Programming Code —
Default User Codes —

Place Sticker Here



24060840

© 2012 Ingersoll Rand
All rights reserved.

Printed in Country
24060840 Rev. 09/12-a5