

# Trio Q Data Radio

## User Manual



# Contents

---

<b>Part A – Preface</b>	<b>3</b>	<b>Part G– Quick Start Guide</b>	<b>78</b>
Safety Information	3	Step-by-Step Point to Point Setup	78
Revision History	5	Step-by-Step eDiags Setup	82
Important Information	5	System Topology Configuration	83
Compliance Information	6	Serial and MODBUS	89
<b>Part B – Feature Overview</b>	<b>7</b>	Single Frequency (Simplex) Mode	94
Introduction	7	E-Series Emulation Mode	95
Features and Benefits	8	<b>Part H – Advanced</b>	<b>97</b>
Q Data Radio Range	9	Connectivity	97
<b>Part C – System Topologies &amp; Operating Modes</b>	<b>11</b>	Ease of Use	105
System Topologies	11	Security	128
Operating Modes	16	<b>Part I – Installation &amp; Commissioning</b>	<b>129</b>
<b>Part D – Feature Detail</b>	<b>18</b>	Optimising the Antenna for Rx Signal	131
Hardware	18	Commissioning	132
Efficiency and Bandwidth	19	<b>Part J – Firmware Updating and Maintenance</b>	<b>133</b>
Connectivity	30	Firmware Updating	133
Ease of Use	32	Global Firmware Updating	134
Security	39	Fuse Replacement - QR450	136
<b>Part E – Radio Planning and Design</b>	<b>41</b>	<b>Part K – Open Source License Acks</b>	<b>137</b>
Radio Path analysis	41	<b>Part L – Support Options</b>	<b>138</b>
BER & Fade Margin	43		
Radio Accessories	44		
RF Feeders and Protection	45		
<b>Part F – Quick Reference Guide</b>	<b>46</b>		
Introduction	46		
Half Duplex Radio - QR450	46		
Full Duplex Radio - QB450	53		
Hot Standby Half Duplex Radio - QP450	58		
Hot Standby Full Duplex Radio - QH450	62		
LED indicators	70		
Connecting Antennas	72		
Communication Ports	72		
Activating Transmitter	74		
Factory Default	74		
Digital I/O	75		
Connecting to Web User Interface (WUI)	76		
Resolving Ethernet Connection Issues	77		

# Part A – Preface

## Safety Information

Read these instructions carefully, and look at the equipment to become familiar with the device before trying to install, operate, or maintain it. The following special messages may appear throughout this documentation or on the equipment to warn of potential hazards or to call attention to information that clarifies or simplifies a procedure.



The addition of this symbol to a Danger or Warning safety label indicates that an electrical hazard exists, which will result in personal injury if the instructions are not followed.



This is the safety alert symbol. It is used to alert you to a potential personal injury hazards. Obey all safety messages that follow this symbol to avoid possible injury or death.

### **WARNING**

**WARNING** indicates a hazardous situation which, if not avoided, **could result in death or serious injury**.

### **CAUTION**

**CAUTION** indicates a hazardous situation which, if not avoided, **could result in minor or moderate injury**.

### **NOTICE**

**NOTICE** is used to address practices not related to physical injury.

Electrical equipment should be installed, operated, serviced, and maintained only by qualified personnel. No responsibility is assumed by Schneider Electric for any consequences arising out of the use of this material.

### **WARNING**

#### HAZARD OF BURN

The QR450 must be installed in a restricted access location..

**Failure to follow these instructions can result in death or serious injury.**

### **WARNING**

#### HAZARD OF BURN

Where an QB450 is to be operated between 60°C and 70°C (122°F and 158°F), it must be installed in a restricted access location.

**Failure to follow these instructions can result in death or serious injury.**

For the definition of a restricted access location, refer to the ETSI EN 60950 standard.

### **WARNING**

#### HAZARD OF THERMAL BURNS

High operating temperature.

- Avoid direct contact with device while in operation.
- Install device in a restricted access location to avoid unintentional contact.

**Failure to follow these instructions can result in death or serious injury.**

### **WARNING**

#### HAZARD OF RADIO FREQUENCY (RF) BURNS

Ensure that a matching load or antenna is attached to the RF port prior to applying power to the device.

**Failure to follow these instructions can result in death or serious injury.**

### **WARNING**

#### HAZARD OF EXPLOSION

Ensure that all connected equipment is grounded to the power source ground termination.

**Failure to follow these instructions can result in death or serious injury.**

### WEEE Regulation (Europe)

This symbol on the product or its packaging indicates that this product must not be disposed of with other waste. Instead, it is your responsibility to dispose of your waste equipment by handing it over to a designated collection point for the recycling of waste electrical and electronic equipment. The separate collection and recycling of your waste equipment at the time of disposal will help conserve natural resources and help ensure that it is recycled in a manner that protects human health and the environment. For more information about where you can drop off your waste equipment for recycling, contact the dealer from whom you originally purchased the product.



Dieses Symbol auf dem Produkt oder seinem Verpacken zeigt an, daß dieses Produkt nicht mit anderer Vergeudung entledigt werden darf. Stattdessen ist es Ihre Verantwortlichkeit, sich Ihre überschüssige Ausrüstung zu entledigen, indem es rüber sie zu einem gekennzeichneten Ansammlungspunkt für die Abfallverwertung elektrische und elektronische Ausrüstung übergibt. Die unterschiedliche Ansammlung und die Wiederverwertung Ihrer überschüssigen Ausrüstung zu der Zeit der Beseitigung helfen, Naturressourcen zu konservieren und sicherzugehen, daß es in gewissem Sinne aufbereitet wird, daß menschliche Gesundheit und das Klima schützt. Zu mehr Information ungefähr, wo Sie weg von Ihrer überschüssigen Ausrüstung für die Wiederverwertung fallen können, treten Sie bitte mit dem Händler in Verbindung, von dem Sie ursprünglich das Produkt kauften.

Before using this product, read the Safety Information, Compliance information and all recommendations related to the purchased wireless communications equipment found within the Installation and Commissioning section found within the product user manual. The product user manual is available at [www.schneider-electric.com](http://www.schneider-electric.com)

<b>⚠ WARNING</b>
<b>HAZARD OF UNINTENDED EQUIPMENT OPERATION</b>
To help prevent equipment malfunction, take every precaution during installation against incorrectly activating the wireless communications equipment. This equipment is not a functional safety product.
<b>Failure to follow these instructions can result in death or serious injury, and equipment damage.</b>

**Environment**

This environment is “enclosed”. It can be installed without any specific protection in areas with restricted access and low pollution levels (not exceeding 2), for example; stations or control rooms which have neither machines nor any activity generating metallic dust or other metallic particles. In other environments, it is recommended to follow rules as defined in the user manual. For the definition of a restricted access location, refer to the ETSI EN 60950 standard.

<b>⚠ WARNING</b>															
<b>HAZARD OF DEATH OR SERIOUS INJURY</b>															
<ul style="list-style-type: none"> <li>• The QR450 must be installed in a restricted access location.</li> <li>• Where an QB450 is to be operated between 60°C and 70°C (140°F and 158°F), it must be installed in a restricted access location.</li> <li>• Ensure that the operating temperature (air surrounding equipment) never exceeds 70 °C (158 °F)</li> <li>• Ensure all radio equipment is installed with a lightning arrestor.</li> <li>• Ensure all connected equipment is grounded to the power source ground termination.</li> <li>• Where an internal fuse is to be replaced, the replacement fuse must be of the specified type and current rating. Refer to fuse replacement instructions within the Product User Manual before servicing.</li> <li>• Ensure a matching load or antenna is attached to the RF port prior to applying power to the device.</li> <li>• RF Exposure - The radio equipment described in the Product User Manual emits low level radio frequency energy. The concentrated energy may pose a health hazard depending on the type of antenna used. To satisfy EU, FCC and Industry Canada requirements a minimum separation distance should be maintained between the antenna of this device and persons during operation as per the table below</li> </ul>															
<table border="1"> <thead> <tr> <th>Range of Antenna gains (dBd)</th> <th>Minimum Separation from Antenna (Meters)</th> <th>Minimum Separation from Antenna (Feet)</th> </tr> </thead> <tbody> <tr> <td>0 to 4</td> <td>1.5</td> <td>5</td> </tr> <tr> <td>4 to 8</td> <td>2.4</td> <td>7.6</td> </tr> <tr> <td>8 to 12</td> <td>3.7</td> <td>12.2</td> </tr> <tr> <td>12 to 16</td> <td>5.8</td> <td>19.1</td> </tr> </tbody> </table>	Range of Antenna gains (dBd)	Minimum Separation from Antenna (Meters)	Minimum Separation from Antenna (Feet)	0 to 4	1.5	5	4 to 8	2.4	7.6	8 to 12	3.7	12.2	12 to 16	5.8	19.1
Range of Antenna gains (dBd)	Minimum Separation from Antenna (Meters)	Minimum Separation from Antenna (Feet)													
0 to 4	1.5	5													
4 to 8	2.4	7.6													
8 to 12	3.7	12.2													
12 to 16	5.8	19.1													
<b>Failure to follow these instructions can result in death or serious injury.</b>															

**Wiring**

In order to improve the security of the installation, follow the rules below:

<b>NOTICE</b>
<b>HAZARD OF EQUIPMENT DAMAGE</b>
The radio modem can be damaged if there is any potential difference between the chassis-ground, RS232 signal ground, power (-) input, or antenna coaxial shield. Before connecting any wiring, ensure all components are earthed to a common ground point.
<b>Failure to follow these instructions can result in equipment damage.</b>

## Revision History

---

<b>Issue: 08-14D</b>	- (August 2014)	Initial release.
<b>Issue: 09-14</b>	- (September 2014)	Added QH450
<b>Issue: 10-14</b>	- (October 2014)	Updated Compliance information.
<b>Issue: 02-15</b>	- (February 2015)	Added QP450, E-Series Emulation Mode and compliance Information.
<b>Issue: 03-15</b>	- (March 2015)	Alarms and Events
<b>Issue: 05-15</b>	- (May 2015)	Updated Compliance Information.

## Important Information

---

© Copyright 2015 Trio Datacom Pty Ltd All Rights Reserved

This manual covers the operation of the Q Data Radio range. Specifications described are typical only and are subject to normal manufacturing and service tolerances.

Trio Datacom Pty Ltd reserves the right to modify the equipment, its specification or this manual without prior notification, in the interest of improving performance, reliability or servicing. At the time of publication all data is correct for the operation of the equipment at the voltage and/or temperature referred to. Performance data indicates typical values related to the particular product.

This manual is copyright by Trio Datacom Pty Ltd. All rights reserved. No part of the documentation or the information supplied may be divulged to any third party without the express written permission of Trio Datacom Pty Ltd.

The manual is also proprietary to Trio Datacom Pty Ltd and are supplied for the purposes referred to in the accompanying documentation and must not be used for any other purpose. All such information remains the property of Trio Datacom Pty Ltd and may not be reproduced, copied, stored on or transferred to any other media or used or distributed in any way save for the express purposes for which it is supplied.

Products offered may contain software which is proprietary to Trio Datacom Pty Ltd. However, the offer of supply of these products and services does not include or infer any transfer of ownership of such proprietary information and as such reproduction or reuse without the express permission in writing from Trio Datacom Pty Ltd is forbidden. Permission may be applied for by contacting Trio Datacom Pty Ltd in writing.

## Compliance Information

### **⚠ WARNING**

#### HAZARD TO HEALTH DUE TO RADIO FREQUENCY (RF) EXPOSURE

- The radio equipment described in this user manual emits low level radio frequency energy. The concentrated energy may pose a health hazard depending on the type of antenna used.
- To satisfy EU, FCC and Industry Canada requirements a minimum separation distance should be maintained between the antenna of this device and persons during operation as per the table below.

Range of Antenna gains (dBd)	Minimum Separation from Antenna (Meters)	Minimum Separation from Antenna (Feet)
0 to 4	1.5	5
4 to 8	2.4	7.6
8 to 12	3.7	12.2
12 to 16	5.8	19.1

Failure to follow these instructions can result in death or serious injury.

### Typical Antenna Installation Exclusion Zone

The diagram below shows the exclusion zone for a typical antenna installation. The details of this typical system are as follows:

- Q Data Radio - 40dBm (10W)
- Antenna - Yagi 14 dBd/16.15 dBi gain
- Lightning Arrestor - 0.5dB loss
- Cable Run - 1.5dB loss

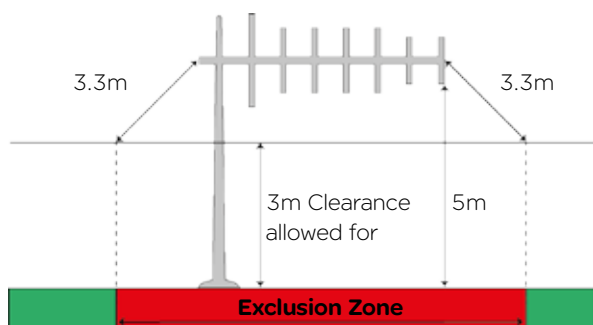

### FCC Compliance

This device complies with part 15 of the FCC rules. Operation is subject to the following two conditions: (1) this device may not cause harmful interference, and (2) this device must accept any interference received, including interference that may cause undesired operation.

The manufacturer is not responsible for any radio or TV interference caused by unauthorised modifications to this equipment. Such modifications could void the user's authority to operate the equipment.

When antennas are co-located on a community (shared) site the correct site engineering must be performed to ensure RF exposure limits are met.

FCC requirements can be found in 47 CFR 1.1307(b)(3)

### Site Grounding

Ensure that the chassis mounting plate, power supply (-) Ground, RTU terminal device, and lightning arrester, are all securely connected to the ground in the building installation or a common ground point to which an earth/ground stake is attached.

### R&TTE Directive (Europe)

Applies to models TBURQx4xx-Exxxxxxx

In order to comply with the R&TTE (Radio & Telecommunications Terminal Equipment) directive 1999/5/EC, all radio modem installations must include an external in-line lightning arrester or equivalent device that complies with the following specifications:

- DC Blocking Capability - 1.5kV impulse (Rise Time 10mS, Fall Time 700mS) (Repetition 10 Times) or 1.0kV rms 50Hz sine wave for 1 minute.

Trio Datacom declares that the Q data radio range is in compliance with the essential requirements and other relevant provisions of the Directive 1999/5/EC. Therefore the Trio Datacom Q data radio range is labelled with the following CE-marking.



### Collocating the QR450 remote (Europe)

The QR450 is a remote radio and should not be collocated with other transmitting equipment.

### FCC Compliance (Hot Standby Controller Only)

This equipment has been tested and found to comply with the limits for a Class B digital device, pursuant to Part 15 of the FCC Rules. These limits are designed to provide reasonable protection against harmful interference in a residential installation. This equipment generates, uses, and can radiate radio frequency energy and, if not installed and used in accordance with the instruction, equipment may cause harmful interference to radio communications. However, there is no guarantee that interference will not occur in a particular installation. If this equipment does cause harmful interference to radio or television reception, which can be determined by turning the equipment off and on, the user is encouraged to try to correct the interference by one or more of the following measures:

- Re-orient to relocate the receiving antenna.
- Increase the separation between the equipment and receiver.
- Connect the equipment into an outlet on a circuit different to that which the receiver is connected.
- Consult the dealer or an experienced radio/television technician for assistance.

# Part B – Feature Overview

---

## Introduction

---

The Trio Q is a family of data radios designed for wireless transport of Telemetry and Remote SCADA data using the licensed UHF spectrum.

Trio Q Data Radios are ideal where:

- Total ownership and control of the data radio network is required
- There are long distances to cover
- Public Communications (ie: Cellular) is too expensive or unreliable
- Variety of communications delivery is required

Trio Q Data radios are suitable for a wide variety of applications that require the transport of serial or Ethernet protocols, including DNP, MODBUS and IEC, over distances of that up to 50Km (30 miles). Common applications include the monitoring and control of remote assets in the management of:

- Water and Waste Water
- Electrical Distribution and Sub Station automation such as those found in Smart Grids
- The extraction and transportation of Oil & Gas

However, as data transport is transparent to the application, there are virtually no application-specific constraints, other than data throughput and range.

A typical radio system topology permits a central master / control application, like a SCADA Host system for example, to communicate with remotely-situated application equipment such as RTUs or PLCs; using single or dual-frequency radio channels in the 400 MHz UHF band. A diverse range of system topologies are possible, but in general remote sites communicate directly with the entry point or via repeater stations when direct communication is not possible.

Trio Q Data Radios come in a variety of hardware form factors. The QR450 Half-Duplex Radio, is ideal for deployment at remote sites, and operates in simplex or half-duplex modes. Built around a rugged but compact die-cast housing, complete with physical mounting locations, it also has an optional DIN rail mounting kit. Complementing this is the QB450 Full Duplex Radio, which is ideal for deployment at entry point or repeater sites as it provides high performance full-duplex operation in a 1RU 19" rack form factor. Where redundancy is of value, there are also Hot Standby variants of both the full and half duplex radios.

Over-the-air data speeds are now four times faster than those found in existing licensed data radio systems. Additionally, the radio system can dynamically change its speed during a signal fade or rain storm, enhancing reliable operation, even at the fastest speeds. Combined with features like IP routing and automatic retries, together with advances in collision avoidance, Trio Q provides the ideal platform for building a scalable, easy-to-use, licensed data radio system, where users can greatly increase the number of remote sites per system, and the amount of data transported over the network. Trio Q data radios operate between 400 and 518MHz, are approved for use by ETSI & ACMA, are software-configurable for 12.5kHz or 25kHz channels, and up to 10W of Transmit power even at the fastest speed.

There are two Ethernet and two serial ports, that operate in either a Layer-2 Ethernet or Layer-3 IP routing mode. For serial data, both RS-232 and RS-485 is supported using embedded terminal servers, secured by 256-bit AES encryption. Diagnostics and Configuration are performed via web server, Telnet/SSH or serial console, and built in wizards take out the guess work. SNMP traps can provide real time alarm detection of parameters and Integration into ClearSCADA is painless with library templates .

In summary, Trio Q Data radios offer enhanced flexibility, security and reliability, even in harsh, remote environments. They provide an ideal foundation on which to build a data radio system that is scalable, has extended reach, and is virtually future-proof, to help you protect the value of your investment.

## Features and Benefits

---

### Common Features – QR450 | QB450 | QP450 | QH450

#### Radio

- UHF Frequency Band Operation : 400-450MHz and 450-518MHz
- 12.5kHz and 25kHz channel operation in one radio model
- User configurable transmitter output power up to 10 Watts
- Coverage of common international frequency bands
- Designed to meet international FCC & ETSI radio regulatory requirements
- VSWR and over temperature protection
- Operation over full -40°C to +70°C (-40 to 158°F) ambient temperature range
- Automatic frequency offset compensation for years of service/calibration free operation

#### Ethernet

- Transport of Ethernet based protocols (including UDP, TCP, DHCP, ARP, ICMP, STP, IGMP, SNMP & TFPT)
- Layer-2 Ethernet Bridge Mode & Layer-3 IP Router mode
- Maximum narrowband channel utilisation with smart peer-to-peer repeating, broadcast filtering and data compression
- SNMP access to radio diagnostics parameters (including alarm detection and traps)
- Legacy RS-232/RS-485 serial support via embedded terminal servers (UDP/TCP) and MODBUS/TCP gateway
- Configuration via embedded HTTP, HTTPS web interface and/or Telnet/SSH/Serial console
- Local and (one to N) broadcast firmware upgrades
- Embedded NTP Time Server (NTP Client / Server / Client-Server / Manual modes)

#### Modem

- Dynamic Speed Selection: QoS/RSSI based automatic speed selection (or fixed mode)
- RF Data Rates: Up to 32kbps in a 12.5kHz ETSI Channel & 56kbps in a 25kHz Channel
- ChannelShare+™: Advanced dynamic supervisory collision avoidance system

#### Security

- Support for 256-bit AES encryption#
- Password protected HTTP and HTTPS configuration/diagnostics management interface
- Password protected Telnet, SSH and Serial console interface

#### Diagnostics

- Compatible with the Trio TVIEW+ Diagnostics Network Management Software
- Embedded error rate testing facilities
- Diagnostics parameters available for Tx Power, RSSI, DV Supply Volts, Frequency Offset, Temperature and VSWR
- In-build event logging facility

#### Approvals

- Europe (ETSI): ETSI EN 300 113, EN 301 489, EN 60950
- United States (FCC): FCC Part 15, Part 90
- Canada (IC): IC RS119, ICES-001
- Australia (ACMA): ACMA AS4295-1995 (Data)

#: Export and import restrictions may apply.



## Q Data Radio Range

---

### QR450 - Half Duplex Radio

---

The QR450 Half Duplex Radio is ideal for remote applications as it has a smaller form factor, allowing the product to be installed in space restricted cabinets/enclosures. The QR450 can also be used as an Entry Point (Base/Master Station) or repeater for systems with a small number of remotes where the transmitter duty cycle is low.

Features of the QR450 include:

- Simplex or Half duplex operation
- Small form factor, rugged die cast housing  
115 x 34 x 164mm (4.52" x 1.33" x 6.45")
- 10-30 V DC supply voltage.
- DIN Rail Mounting Kit Option  
(TBURDIN-KIT-TYPEA)
- Suitable for use in Class I, Division 2, Groups A, B, C & D hazardous locations



**Half Duplex Radio**

### QB450 - Full Duplex Radio

---

Complimenting the QR450 half duplex remote radio, the QB450 full duplex radio is ideal for deployment at base & repeater sites in systems using two frequency operation. In high duty cycle applications, the QB450 delivers maximum rated transmitter power in ambient temperatures up to +70°C (158°F). Where 1+1 hot standby redundancy is required, the half duplex QP450 and the full duplex QH450 are available.

Features of the QB450 include:

- Full Duplex operation (100% duty cycle)
- 19" 1RU rack mount
- Digital Inputs & Outputs



**Full Duplex Base Radio**

### QP450 - Hot Standby Half Duplex Radio

---

The QP450 half duplex radio is ideal for deployment at base & repeater sites in systems using two frequency (half duplex) or single frequency (simplex) operation, where it will only be required to transmit OR receive. In high duty cycle applications, the QP450 delivers maximum rated transmitter power in ambient temperatures up to +70°C (158°F).

The features of the QP450 include:

- Simplex or Half duplex operation
- Duplicated redundant transceiver configuration
- Automatic change-over
- 19" 1RU rack mount
- Digital Inputs & Outputs



**Half Duplex Hot Standby Base Radio**

## QH450 - Hot Standby Full Duplex Radio

---

Complimenting the QR450 half duplex remote radio, the QH450 full duplex radio kit is ideal for deployment at base & repeater sites in systems using two frequency operation. In high duty cycle applications, the QH450 delivers maximum rated transmitter power in ambient temperatures up to +70°C (158°F). Where 1+1 hot standby redundancy is not required,

the full duplex QB450 base/repeater station is available.

The features of the QH450 include:

- Full Duplex operation (100% duty cycle)
- Ethernet link monitoring and shared IP address provides smart Ethernet redundancy
- Remote monitoring, control and changeover of duplicated base/repeater stations
- Hot-swappable modular 19" rack mount transceiver configuration (3 RU total)
- Automatic changeover upon alarm detection of transmitter, receiver, data alarm detection, power supply and data connectivity.
- Digital Inputs & Outputs
- Hot Standby Controller power supply
  - 11-14V DC (from output of QBs)
  - Max Current: 800mA



**Full Duplex Hot Standby Base Radio**

# Part C – System Topologies & Operating Modes

## System Topologies

### Introduction

Fundamental to understanding the use of the Q data radio range in your system is the need for a basic understanding of the different types of radio system topologies and system topology functions.

#### System Topologies:

Point to Point (PTP):

- A system topology with two radios, one Entry Point and one Remote

Point to Multipoint (PTMP):

- A system topology with three or more radios, one Entry Point that directly communicates to two or more Remotes.

Point to Multipoint via a Repeater (PTMP/R):

- A system topology with three or more radios, one Entry Point that communicates via a repeater to two or more Remotes.

Point to Multipoint via multiple Repeaters:

- A system topology with four or more radios, one Entry Point that communicates via multiple cascaded repeaters to one or more Remotes.

Multipoint to multipoint (MPTMP):

- A system topology with one Entry Point and one or more remotes, and no repeaters, where remotes can talk directly to the Entry Point or to each other.
- Only works with Simplex frequencies.

#### System Topology Functions:

Entry Point:

- The radio where user data enters the systems. Typically connected (directly or indirectly) to the Master RTU or SCADA Host.

Repeater:

- A radio which repeats data from an Entry point to Remote, or Remote to Remote, or Repeater to Repeater.

Remote:

- A radio which is the endpoint or perimeter of the system topology.

Each type of network is described in the following diagrams.

#### Point-to-Point (PTP)

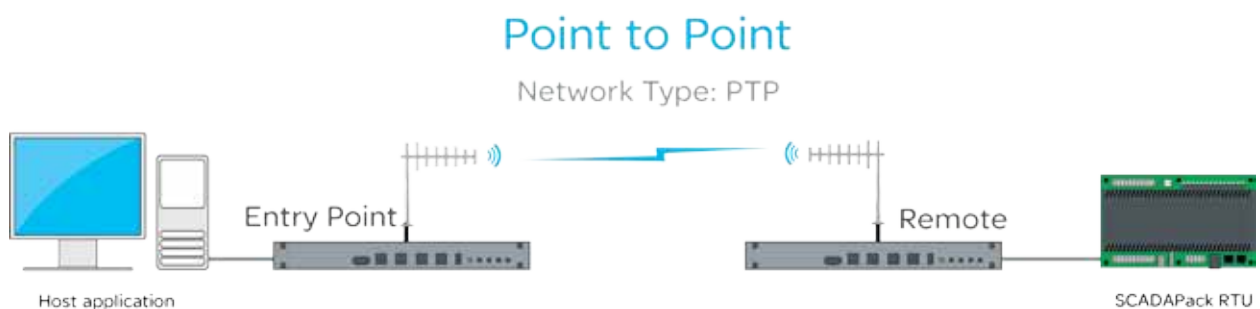

A Point to Point (PTP) network has one Entry Point and one Remote radio. When full duplex radios are installed, full data throughput can be achieved in each direction. Alternatively, half-duplex radios can also be implemented although collision avoidance should be enabled.

Full Duplex radios have the advantage that they simulate a cable connection with respect to the connected devices. Even if one device transmits continuously it will not block the other device from sending data. This is useful for applications that expect full duplex communications or that are not designated to be radio modem friendly.

## Point to Multipoint (PTMP)

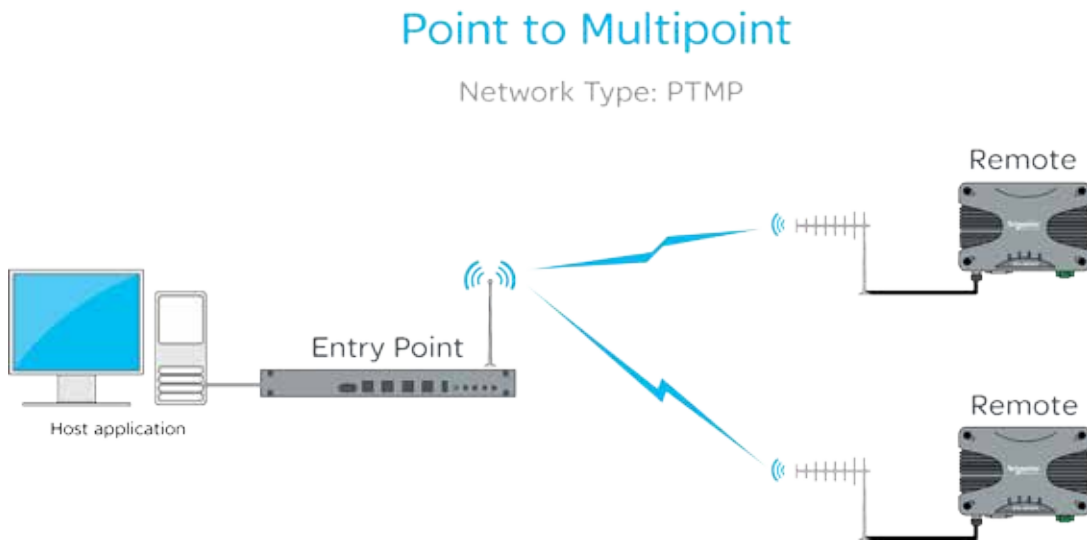

A Point to Multipoint (PTMP) network is normally chosen when a central site (i.e.: The HOST application) needs to communicate with multiple REMOTE sites.

Point to Multipoint (PTMP) operation requires the Entry Point site to have adequate RF coverage of all Remote sites. A PTMP offers optimal available bandwidth and data latency when multiple remote sites are required.

In a multiple access radio system (MAS), communication occurs from a common site (the Entry Point) to all others, either using a half duplex or simplex radio channel. In addition, remote sites can communicate to each for peer to peer messaging, via the Entry Point.

For two frequency systems, to facilitate efficient data communication and support features such as the 'Channel Share+' collision avoidance mechanism, it is recommended that the Entry Point be a full duplex radio (QB/QH).

Utilising a half duplex Entry Point radio is possible, however some features may not be available and system performance may be lower when compared to using a full duplex entry point.

In most applications, this type of system topology is more efficient than other topologies.

## Point to Multipoint via Repeater (PTMP via Rep)

## Point to Multipoint via Repeater

Network Type: PTMP/R

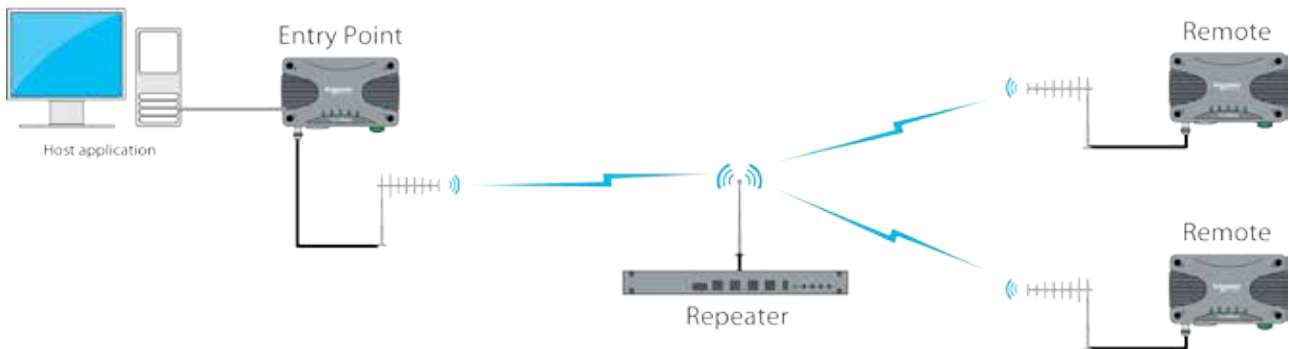

A Point to Multipoint via repeater (PTMP/R) network is a variation of the Point To Multipoint (PTMP) network. It is normally chosen when the site where the Host application (i.e.: Entry Point) does not have adequate RF coverage of Remote sites in the network.

This network topology consists of a radio configured as a Repeater (typically full duplex), an entry point radio and a number of remotes. The repeater can be configured to repeat data based on either IP layer 2 (Bridge mode), or IP layer 3 (Router mode) rules.

The repeater should be located at a site with adequate RF coverage to each of the remotes.

For two frequency systems, to facilitate efficient data communication and support features such as the 'Channel Share+' collision avoidance mechanism, it is recommended that the Repeater be a full duplex radio (QB/QH).

Utilising a half duplex Entry Point radio is possible, however some features may not be available and system performance may be lower when compared to using a full duplex entry point.

Other aspects of the Point to Multipoint network apply to this network topology.

## Point to Multipoint via Multiple Repeaters (PTMP via multiple Repts)

### Point to Multipoint via Multiple Repeaters

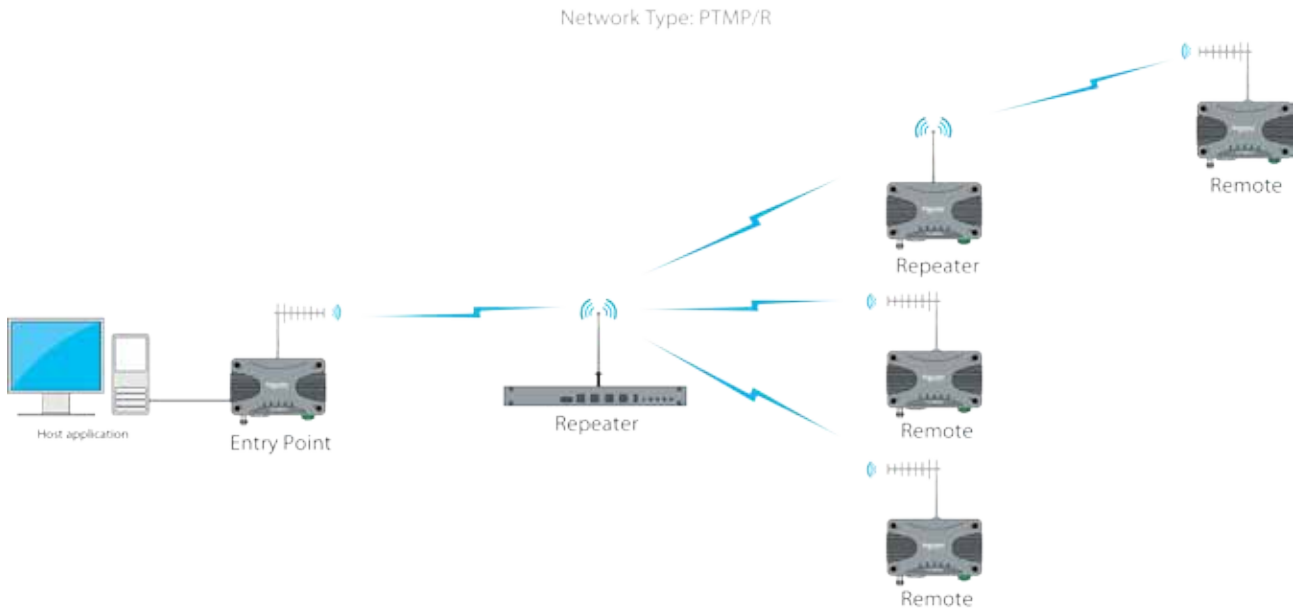

A PTMP via multiple repeaters system is a variation of the PTMP/R system. It is normally chosen when the site where the Host application (i.e.: Entry Point) together with the first repeater have inadequate RF coverage of remote sites in the network.

In this system topology, there are multiple radios configured as repeaters. The PTMP/R with multiple repeater system topology is only possible when using IP routing mode. Each repeater is configured to repeat traffic based on destination IP address.

The repeaters should be located at sites with adequate RF coverage for the remote sites. For two frequency systems, to facilitate efficient data communication and support features such as the collision avoidance mechanism, it is recommended that the first Repeater be a full duplex radio (QB/QH).

Utilizing a half duplex Repeater is possible, however some features may not be available and system performance may be lower when compared to using a full duplex entry point.

Other aspects of the Point to Multipoint network apply to this network topology.

## Flat Multipoint to Multipoint (MPTMP) - Simplex

## Multipoint to Multipoint (Simplex)

Network Type: MPTMP

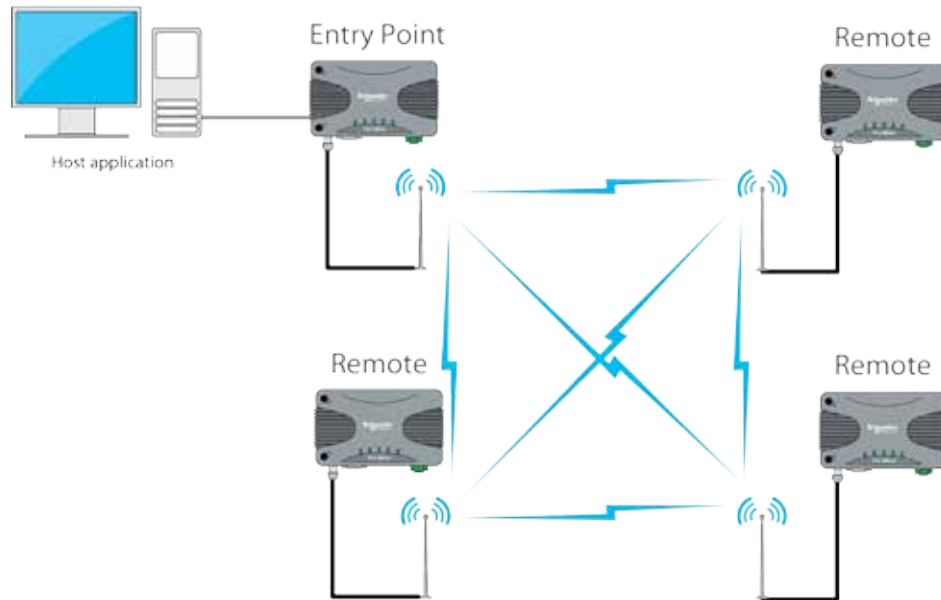

A Multipoint to Multipoint network is a variation of the Point To Multipoint network. It is primarily used when the system requirement is for each site to be able to communicate directly with every other site. This requires every site to have adequate RF line of sight to every other site along with the use of simplex frequencies (Rx & Tx frequencies are the same).

In this system topology, each site typically require the use of an omni directional antenna. This is to provide an even spread of antenna gain to and from each site.

## Operating Modes

### Introduction

This section assumes the reader has an operational understanding of industrial Ethernet.

A typical Ethernet network consists of a number of IP devices, all which share the requirement of data communication. In order for a pair of devices within an Ethernet based network to communicate with one another, they need to be able to address data to a specific destination (in this case, each other).

**MAC Address** - MAC addresses identify Ethernet devices on a network when operating at Layer-2. All Ethernet ports in devices have their own unique media access control (MAC) address. There are special MAC addresses used for broadcast and Multicast messages.

**IP Address** - An IP address is a numerical label assigned to each device (e.g., Radio, RTU, SCADA Host) participating in a computer network that uses the Internet Protocol for communication.

An IP address serves two principal functions:

- Host or network interface identification and
- Location addressing.

**Subnet** - A subnet is a subdivision of an IP network. It allows a network designer to segment a large IP network into smaller, manageable sub networks. This can assist in the allocation of IP addresses and the management of network bandwidth.

**Subnet Mask** - Together with the IP address, the subnet mask is used to determine which subnet a device belongs to.

**Gateway** - A gateway forwards IP messages between devices on different subnets in an IP network. A gateway uses configurable routing rules to determine where to forward an IP message.

**Route** - A route is a rule that indicates where an IP message needs to be sent in order to get to a specific device on an IP network.

### Transparent Bridge Mode

The Q data radios can be configured to operate in a transparent bridge mode. This mode transports all data as layer 2 Ethernet traffic over the radio network. Each radio will behave like a layer 2 Ethernet switch, transparently forwarding data, based on rules, dynamically determined from device MAC addresses. Although traffic is transported at layer 2, each radio requires an IP address in order for a user to access radio management features (web server/telnet/diagnostics/etc..).

The example below shows a typical PTMP/R topology, with all radios operating in bridge mode.

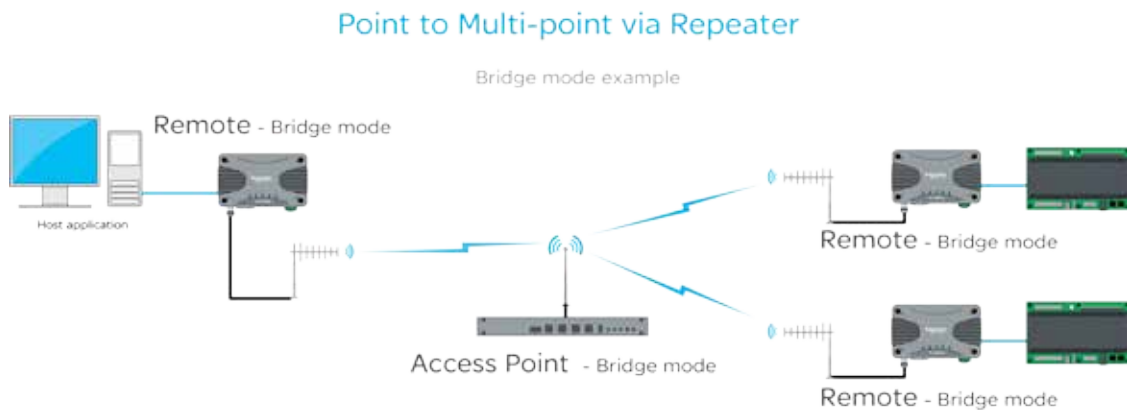

From an IP network perspective, each radio within the topology above, effectively looks like an Ethernet switch. See the example below.

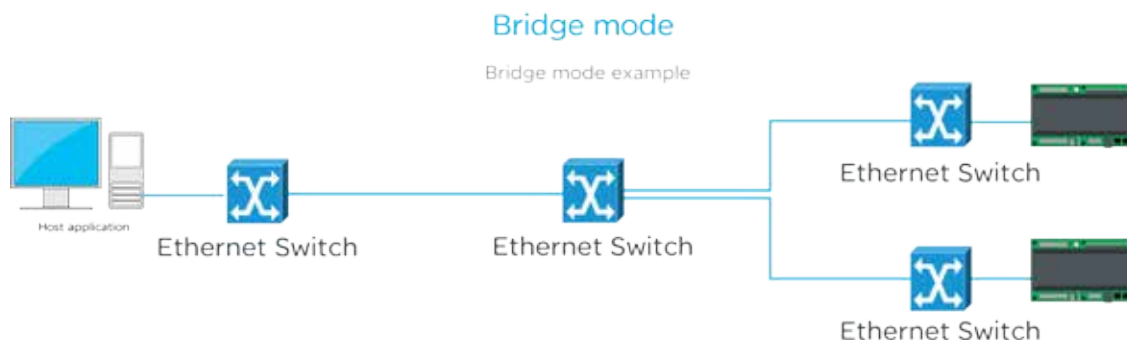



## Router Mode

The Q data radios can also be configured to operate in router mode. Router mode provides the radio the ability to route IP data, based on user configurable network routing rules (OSI model layer 3), between devices on different subnets.

The benefits of router mode include:

- Faster poll times
- Higher throughput
- Improved management of IP addresses

Each radio behaves as a network gateway for its corresponding subnet. This allows a network designer to segment a wide area IP network (WAN) into smaller subnets, which minimises the amount of over the air radio traffic. The example below shows how router mode segments an IP radio network into smaller subnets. Each radio has its own subnet, represented in the example by dashed colored boxes.

### Point to Multi-point - Router mode

Router mode example

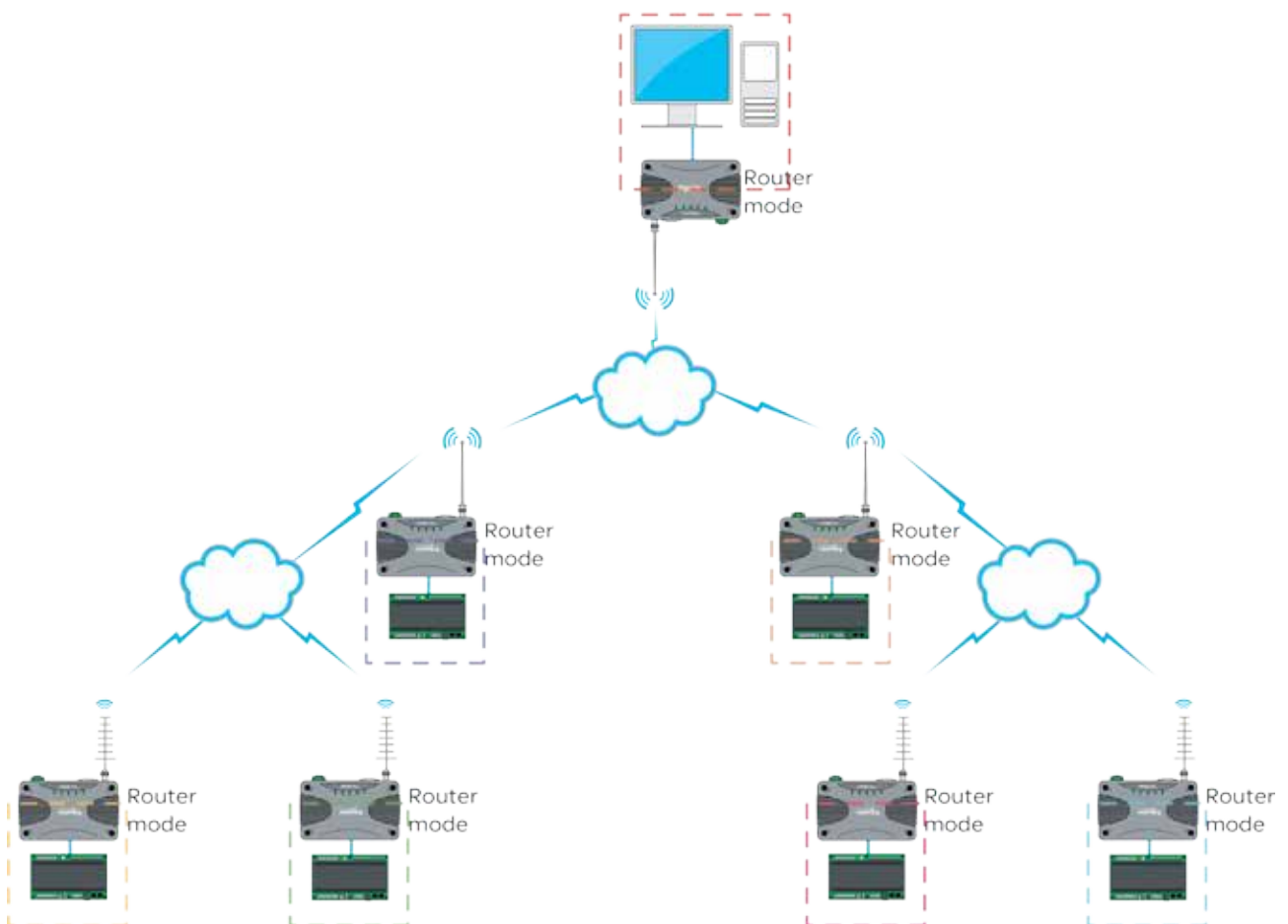

# Part D – Feature Detail

## Hardware

### QR450 - Half Duplex Radio



**Mounting Holes**

- Flat Panel Mounting
- DIN Rail Mounting

**Diagnostics & Management**

- Status LEDs
- RSSI Output
- Factory Reset

**RF Port**

- Up to 10W RF Power
- High VSWR Foldback
- -40 to +70 degC (-40 to +158 degF)
- Over Temperature Foldback

**Serial Ports**

- Dual RS-232 Serial Ports
- Shared on single DB-9 Connector
- Break Out cable if two ports required
- RS-485 mode supported

**Ethernet Ports**

- 2 x 10/100 MBps
- Auto MDIX Sensing

**DC Power**

- 10-30 V DC
- 5W standby



### QB450 - Full Duplex Radio



**Digital Inputs / Outputs**

- 3 DI / 3 DO
- Alarm Output
- Read/Write via SNMP

**RF Port**

- Up to 10W RF Power
- Separate Tx/Rx Connections
- High VSWR Foldback
- Over Temperature Foldback

**Status LEDs**

- Status LEDs
- RSSI Output
- Factory Reset

**Ethernet Ports**

- 3 x 10/100 MBps
- Auto MDIX Sensing

**Serial Ports**

- Dual RS-232 Serial Ports
- Shared on single DB-9 Connector
- Break Out cable if two ports required
- RS-485 mode supported

**General**

- 19" 1RU Rack Mounted
- -40 to +70 degC (-40 to +158 degF) @ 100% duty cycle
- Full Duplex Operation
- Temperature Controlled Fan forced cooling

## Efficiency and Bandwidth

### RF Speeds and Sensitivity

The Trio Q data radios use continuous phase modulation (CPM) which supports up to 10 Watts of transmitter output power, even at the fastest RF data rate.

This avoids the need to compromise on range when operating at the fastest speeds. Two different radio variants and modulation types are available, depending on the regulatory requirements (FCC or ACMA/ETSI).

- TBURQx4xx-**E**00xxxxx: 'E' denotes ACMA/ETSI
- TBURQx4xx-**F**00xxxxx: 'F' denotes FCC

Contact your local sales representative if you need to confirm the applicable model for your regulatory region.

Regulatory Region	Channel Bandwidth (KHz)	RF Speed (Kbps)	BER threshold (10 <sup>-6</sup> )
FCC/IC	12.5	8	-113
		16	-110
		24	-107
		32	-100
ACMA/ETSI	12.5	8	-113
		16	-110
		24	-107
		32	-100
	25	14	-111
		28	-109
		42	-106
		56	-99

### ARQs

Automatic Repeat reQuests (ARQs): When enabled, ARQs confirm successful reception of data transmitted over the air. Each time a radio (originator) transmits data, the receiving radio replies with an acknowledgement back to the originator, confirming successful reception of the data. If an acknowledgement is not received by the originator within an acceptable time frame, the originator declares the data lost and retransmits the data. The number of retransmit attempts is user configurable (i.e. when ARQ = 2, there will be a maximum of two retransmit attempts per message).

When Ethernet data is not successfully transmitted over a radio network (i.e. due to a data collision), Ethernet devices can interpret this as network congestion, resulting in unnecessary slow down of SCADA polling. ARQs increase the probability of successful transportation of data over the radio link. However, when ARQs are enabled, the capacity of the radio network is reduced, due to the ARQ acknowledgements. As only one device can generate an acknowledgement for received data, ARQs are not applicable to broadcast or multicast traffic

#### Typical data transaction with ARQ enabled

The example below shows the ARQ behavior between a pair of radios during a typical data transaction.

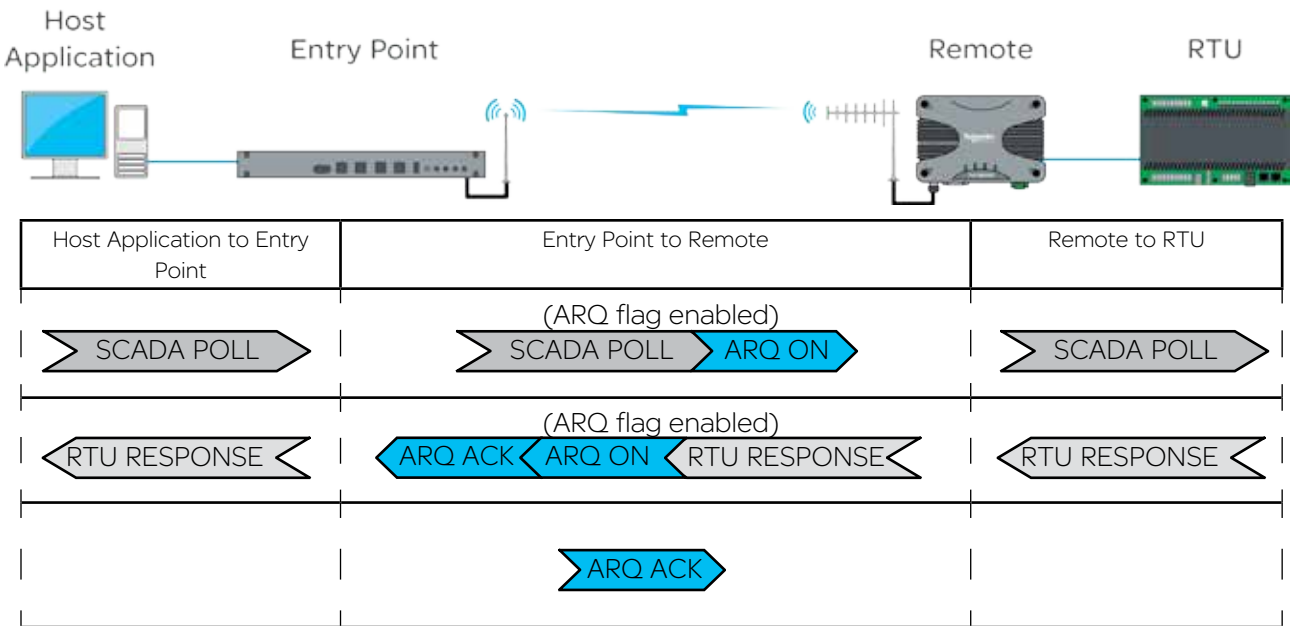

**Automatic Retry Example**

The example below shows the ARQ behavior between a pair of radios when a packet is lost during a transmission (ARQ =1).

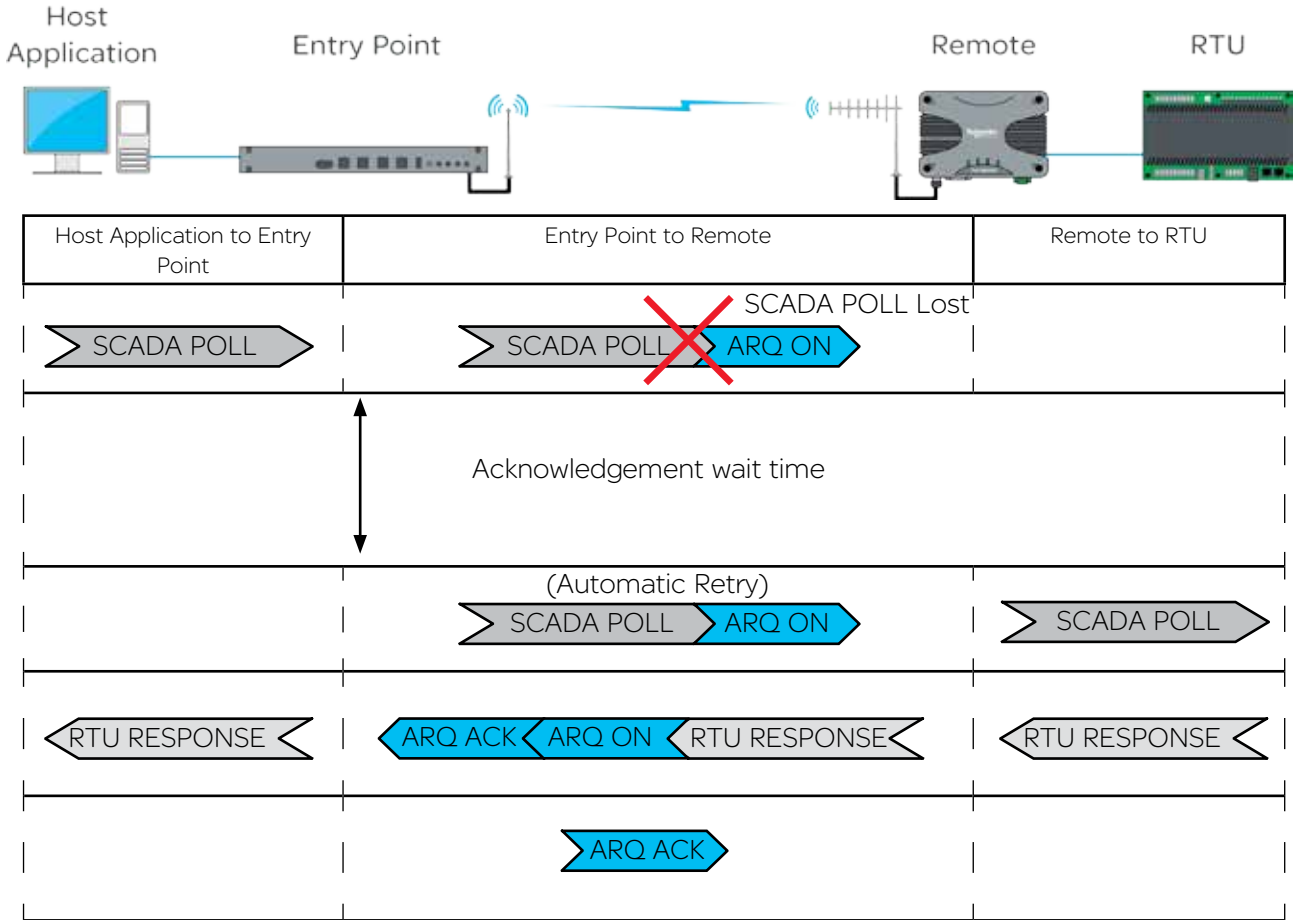

The radio will wait 500ms for an acknowledgement, before sending an automatic retry. It is recommended that the SCADA host poll response time out time is configured to be a minimum of 3 seconds.

## Dynamic Speed Selection

Traditional narrow band SCADA data radios achieved wireless communication over long distances by transmitting at low RF data rates (typically 9600bps or less). Modern SCADA systems require faster RF data rates, due to the need to support additional traffic for Ethernet and IP. However, reliable transmission over long distances at faster RF data rates, can be difficult to achieve.

To assist in reliable data transmission over long distances at faster RF data rates, the Trio Q data radios utilise dynamic speed selection. Dynamic speed selection provides the following enhancements:

- Operation at the fastest possible RF speeds
- Measurement of Quality of Service - QoS (success of data delivery to other end) and
- Automatically adjusting to a slower RF speed to improve quality, if QoS is inadequate

Dynamic speed selection is individual for each remote in a point to multipoint (PTMP) system. Should one remote need to operate at a slower RF speed due to limited received RF signal, others will continue to operate at the fastest possible RF speed as dictated by their own received RF signal strength for that specific site.

### RF Data Rate vs RF Sensitivity

As stated earlier in this section, Trio Q Data Radios have four different RF speeds for each channel bandwidth selection (12.5kHz or 25kHz). Each RF speed has a corresponding receiver  $1 \times 10^{-6}$  BER (Bit Error Rate) sensitivity. The slower the RF speed, the better RF sensitivity, and therefore the longer the range for a given level of reliability.

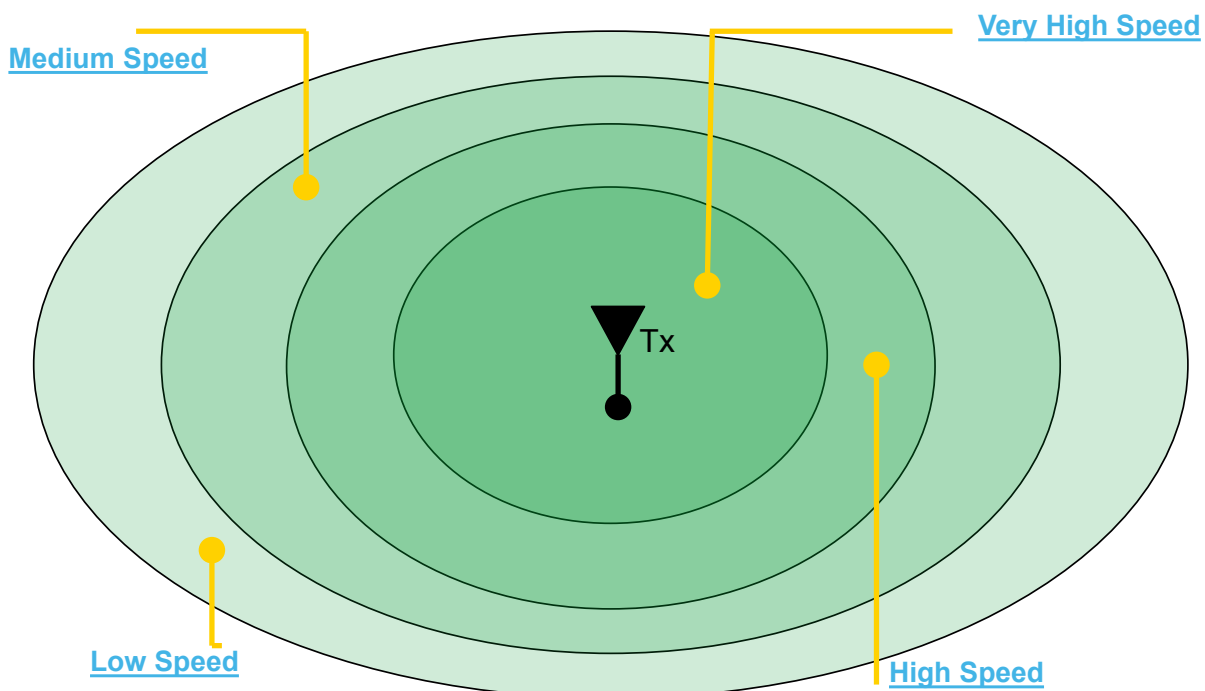

The further away from the master station, the weaker the received signal. Slower RF speeds are required for an acceptable level of reliability.

Consider the example shown in the diagram above. An entry point / base station is located in a fixed position. When communicating with a remote radio, RF energy between the two radios diminishes in strength as the signal propagates over distance.

In a system with out dynamic RF speed selection, the user would need to configure a suitable fixed RF speed, dependent on the signal strength at the remote site. In most applications, a minimum of 20dB fade margin is recommended for reliable operation (due to rain fades, cable degradation, multipath fading, etc). If the remote radio is fixed at a specific RF speed, then in order to maintain a received signal 20dB above the  $1E-6$  BER sensitivity (20dB fade margin), the user would need to decrease the RF speed when the receiving radio is further away from the transmitter. This is depicted in the diagram above by the concentric rings showing what RF speed can needs to be selected in order to maintain a 20dB fade margin.

Consider now, in the below example where dynamic RF speed selection is enabled. Now that the receiving radio can adjust its RF speed dynamically, a faster RF speed can be chosen for normal operation. Even though the faster RF speed will not provide 20dB of fade margin, the system is still reliable because dynamic speed selection will drop down in RF speed when a signal fade occurs.

**Dynamic Speed - No Obstructions**

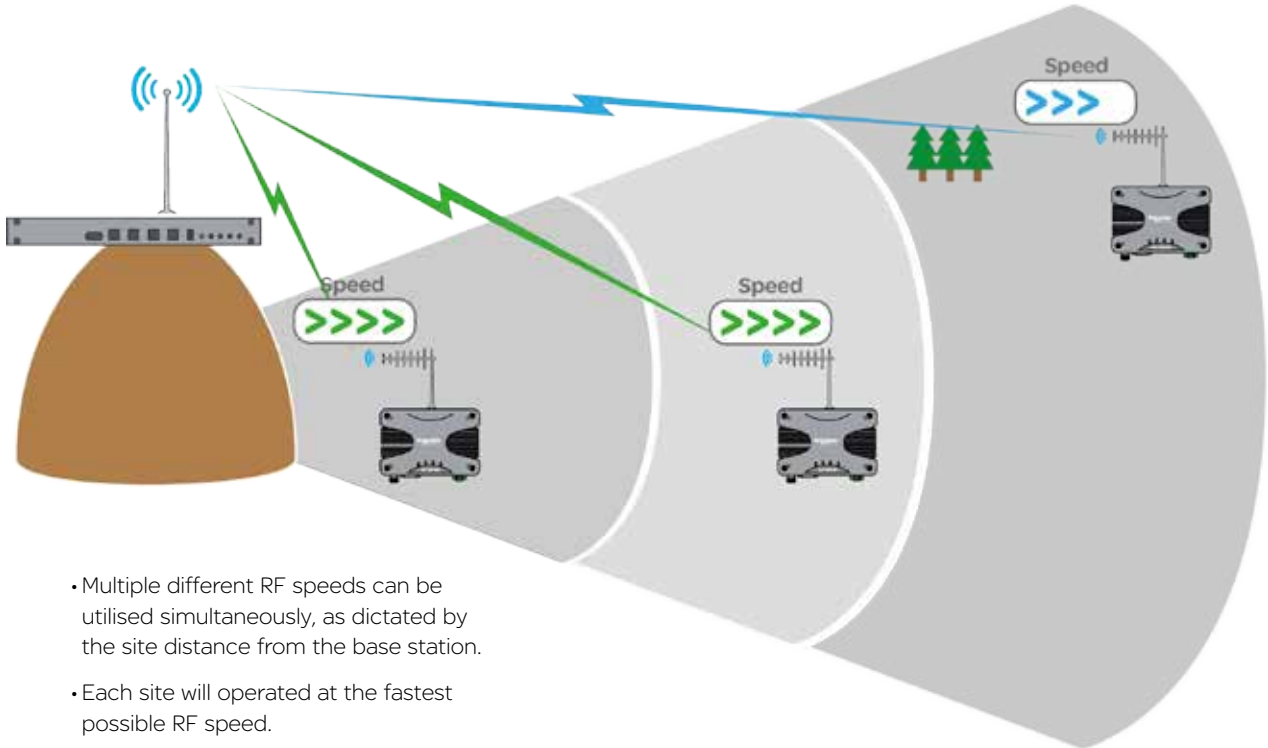

- Multiple different RF speeds can be utilised simultaneously, as dictated by the site distance from the base station.
- Each site will operate at the fastest possible RF speed.

**Old Technology - No Obstructions**

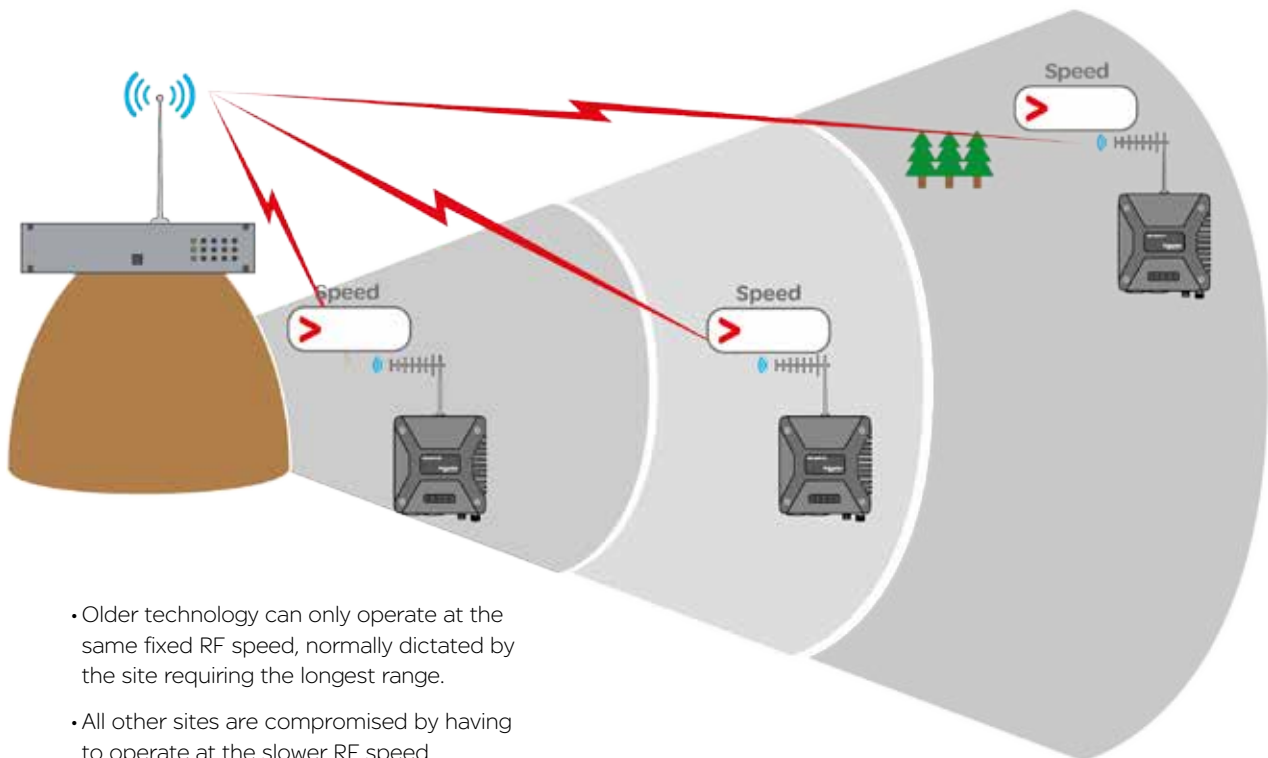

- Older technology can only operate at the same fixed RF speed, normally dictated by the site requiring the longest range.
- All other sites are compromised by having to operate at the slower RF speed

Dynamic speed selection derives QoS from both RSSI (Received Signal Strength) and ARQ performance in order to maintain a radio link operating at the fastest speed possible for the given quality of the link.

Each radio stores a table of destination MAC addresses vs fastest RF speed in a dynamic speed cache, using information learned from previous transactions over the air. In this way, the radio dynamically learns what RF speed should be chosen for a transmission. Should the transmission generate an ARQ, the radio will drop down in RF speed to improve reliability of data delivery.

In the event that radio has not yet learnt the fastest RF speed for a destination MAC, the message will be transmitted out at the slowest RF speed in the given bandwidth, to provide the highest sensitivity, and therefore the highest reliability.

As broadcast and multicast addresses are potentially destined for multiple radios these types messages will always be transmitted at the slowest speed. The following diagrams show how the RF data rate can be influenced by obstructions:

**Dynamic Speed - With Obstructions**

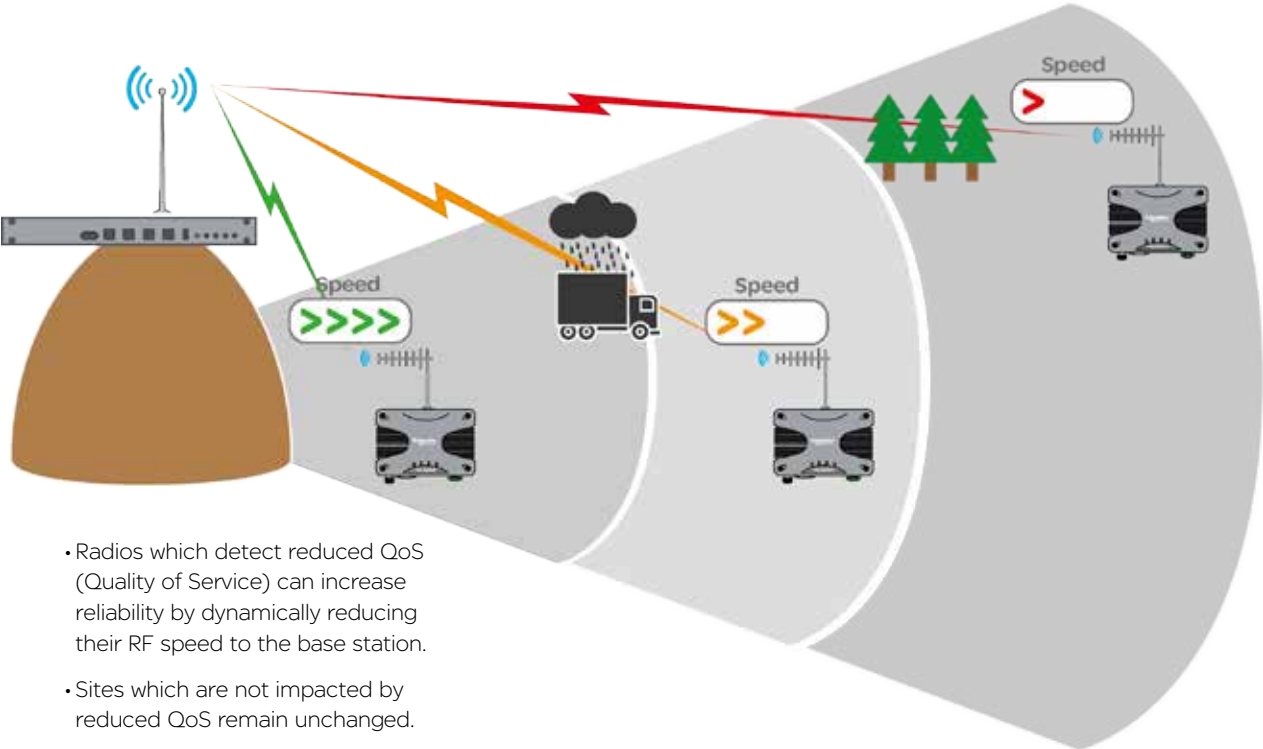

**Old Technology - With Obstructions**

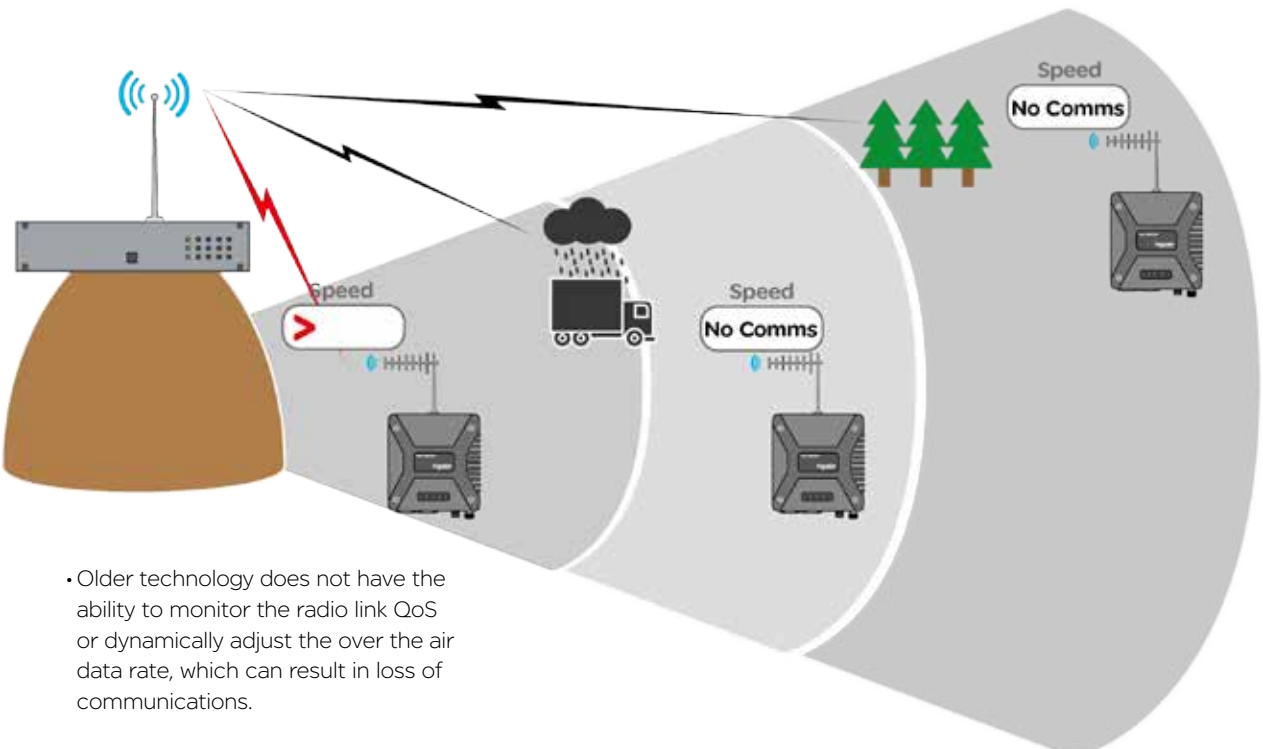

## Dynamic Speed Cache

The dynamic speed cache is used by a radio to record specific external values that are learnt. These values are then used by other processes within the radio (such as dynamic speed and ARQ) to help ensure optimum performance is achieved over the radio channel.

External values that are learnt are shown in the table below.

Remote Host MAC	Associated Radio Serial Number	RSSI level

**Remote Host MAC:** The MAC address of a device which is connected to a remote radio.

**Associated Radio Serial Number:** The Unique ID of a remote radio with which the Remote Host Device/MAC is associated with.

**RSSI level:** The signal strength received from the radio specified within the associated radio serial number field.

A typical data packet structure is shown below. (For the purposes of this example, the preamble, Ethernet type and CRC fields have been excluded.)



Data packets sent over the air between radios have an additional field appended. An example is shown below.

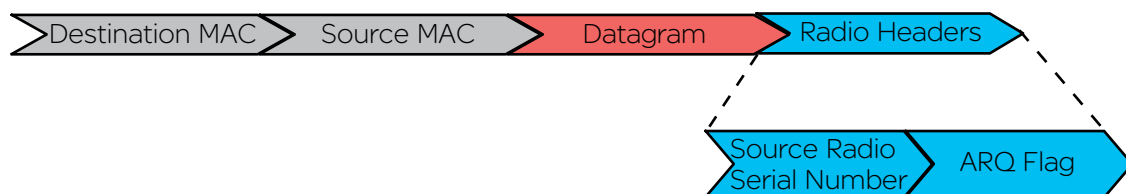

Consider now, in the below example where dynamic RF speed selection is enabled. Now that the receiving radio can adjust its RF speed dynamically, a faster RF speed can be chosen for normal operation. Even though the faster RF speed will not provide 20dB of fade margin, the system is still reliable because dynamic speed selection will drop down in RF speed when a signal fade occurs.

Dynamic speed selection derives QoS from both RSSI (Received Signal Strength) and ARQ performance in order to maintain a radio link operating at the fastest speed possible for the given quality of the link. The two influencing factors are:

Each radio stores a table of destination MAC addresses vs fastest RF speed in a dynamic speed cache, using information learned from previous transactions over the air. In this way, the radio dynamically learns what RF speed should be chosen for a transmission. Should the transmission generate an ARQ, the radio will drop down in RF speed to improve reliability of data delivery.

In the event that radio has not yet learnt the fastest RF speed for a destination MAC, the message will be transmitted out at the slowest RF speed in the given bandwidth, to provide the highest sensitivity, and therefore the highest reliability.

As broadcast and multicast addresses are potentially destined for multiple radios these types messages will always be transmitted at the slowest speed.



## E-Series Emulation Mode

The Q data radios can be configured to operate in E-Series emulation mode. This can allow the replacement of existing E-Series radio networks to be upgraded to Q data radio systems at a pace the user defines.

E-Series Emulation Mode can provide:

- A cost effective upgrade to a Q data radio network
- Minimise SCADA connectivity downtime during an upgrade
- A greater subset of features once the radio network is fully upgraded, as E-Series emulation mode is a user configurable feature.

The diagram below shows how an existing E-Series radio system can be progressively upgraded to a Q data radio system by replacing E-Series radios 'One by One' with Q data radios operating in E-Series emulation mode.

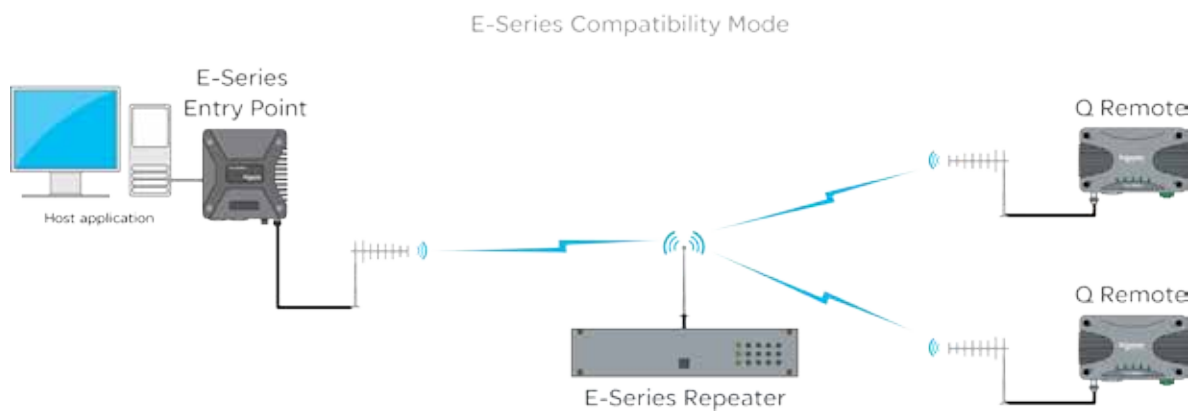

Once all E-Series have been replaced, the Q data radios may be re-configured to operate in Q mode, to provide advanced features and functionalities of the Q data radios.

## Collision Avoidance

---

### Introduction

In many SCADA and remote Telemetry applications, there exists the potential for over the air data collisions between radios. This can occur when multiple asynchronous data traffic is present on the radio channel, such as SCADA polling, SCADA exception reports, SNMP traps, pings and ARP requests.

In two frequency systems, collisions may occur on the receive channel of an Entry Point or Repeater radio, due to two or more remotes transmitting simultaneously. If this occurs, the radio will receive a corrupted message from both radios and a re-try will be required. Similarly, in simplex (single frequency) systems, collisions may occur on any receiving radio when two or more radio transmit simultaneously.

In two frequency systems, collision avoidance minimises the chance of collisions by configuring one radio, as the collision avoidance master, which informs remote radios when the master's receive RF channel is busy. Remotes will check whether the master is allowing access to the channel before a transmission occurs. If the channel is free, the remote will transmit. If the channel is busy, the remote will buffer the message and execute a small random delay (in case multiple remotes have data to send), then attempt to access the channel again. By avoiding collisions the SCADA system is able to operate more efficiently, with fewer retries. Similarly, in simplex (single frequency) systems, remote radios can detect when the Entry Point or Repeater radio is transmitting, and wait for it finish, before transmitting itself.

For two frequency systems, there are two different modes of collision avoidance:

- **Carrier Detect** - Remote radios in a carrier detect collision avoidance system, listen for a transmission (carrier) from the collision avoidance master, to determine if the collision avoidance master is currently busy receiving a transmission from another remote. When the collision avoidance master receives a transmission from a remote, it activates its own transmitter, indicating to all other remotes that the channel is busy.

In this mode of operation, remote radios can not distinguish between the collision avoidance master transmitting data and the collision avoidance master indicating the channel is busy.

Carrier Detect Mode can also be used without a collision avoidance master. This is typically implemented in simplex systems, or systems with a small number of remotes.

- **ChannelShare+™** - Remote radios in a ChannelShare+ collision avoidance system, monitor a channel busy flag in the digital data stream transmitted from the collision avoidance master to determine if the collision avoidance master is currently busy receiving a transmission from another remote. When the collision avoidance master receives a transmission from a remote, it activates its own transmitter and sets the channel busy flag, indicating to all other remote the channel is busy. However, unlike carrier detect mode, if the collision avoidance master needs to transmit data to remotes, it can do so and clear the channel busy flag.

In this mode of operation, remote radios can distinguish between the collision avoidance master transmitting data and the collision avoidance master indicating the channel is busy. Even if the collision avoidance master is transmitting data, a remote radio can transmit data back to the collision avoidance master. In this way the radio system can fully utilise the full duplex capabilities of the Entry Point or the Repeater (collision avoidance master). The channel busy flag consumes a small amount of bandwidth in the collision avoidance master to remote direction. However, as this direction is one to many, it has negligible impact on radio network capacity.

ChannelShare+ can be used in two frequency, PTMP and PTMP/R system topologies where the Entry Point or Repeater is full duplex. It is not available in simplex systems, or where the Entry Point/Repeater is half duplex or in PTMP via multiple Repeaters system topologies.

**Collision avoidance operational examples:**

Collision avoidance (C/A) has a number of user configurable parameters. These parameters work together with the specific mode of C/A chosen to minimise the number of collisions on the radio channel. Interaction of these parameters in C/A is best explained by reviewing the operational flow charts for common C/A configurations.

**ChannelShare+™ Example 1**

This flow chart shows the C/A operation in a remote radio with the following configuration:

- **C/A:** ChannelShare+
- **Backoff Method:** Retry After Tx attempt
- **Backoff time:**
  - **Max Slots:** 16
  - **Slot Time:** 20ms
- **Data Priority:** Tx Data

When data is ready to be transmitted, the remote radio checks the C/A busy flag to see if it is set (i.e. is the C/A master receiver busy). If the C/A busy flag is clear, the data is transmitted to the C/A master. If the C/A busy flag is set, the radio waits a random time before trying again.

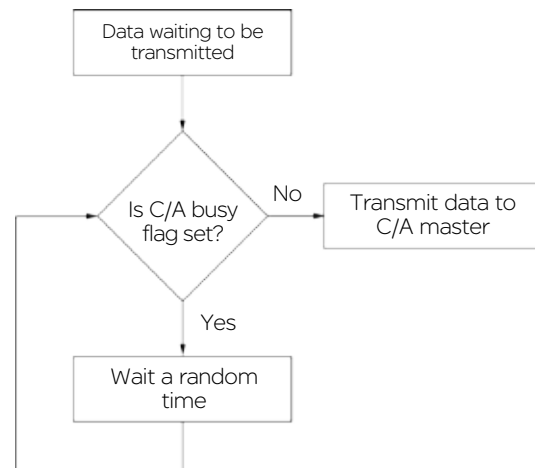

As it is possible that there may be more than one radio waiting to transmit data to the C/A master, a random wait time is applied, to avoid two radios waiting the same time, retrying and then colliding. There are multiple configurable parameters involved in when the wait time is applied and what amount of time is waited.

- **Backoff Method** - Defines 'when' a radio will implement the backoff time. In this example, the backoff method is configured to 'Retry After Tx Attempt'. If the C/A busy flag is clear, the remote will transmit data immediately. If the C/A busy flag is set, the remote will wait a random Backoff time and try again.

The Backoff time is calculated by choosing a random number between 1 and 'Max Slots' (in this example 16) and multiplying the number by the 'Slot Time' (in this example 20ms). In any remote radio, a smaller number of 'Max Slots' and 'Slot Time' can be configured to reduce the random Backoff time, which will increase the rate at which the radio checks the C/A busy flag. In effect, a radio with a smaller backoff time has a higher probability of transmitting its data first, in a situation where multiple remote radios are waiting for access the channel.

As the data priority is configured for Tx Data, the radio will transmit data even when an incoming data packet it being received.

This collision avoidance configuration provides maximum radio channel efficiency and are recommended when there is multiple asynchronous data traffic on the radio channel.

### ChannelShare+™ Example 2

This flow chart shows the C/A operation in a remote radio with the following configuration:

- **C/A:** ChannelShare+
- **Backoff Method:** Delay Before Tx attempt
- **Backoff time:**
  - **Max Slots:** 16
  - **Slot Time:** 20ms
- **Data Priority:** Tx Data

When data is ready to be transmitted, the remote radio waits a random time before checking the C/A busy flag to see if it is set (i.e. is the C/A master receiver busy). If the C/A busy flag is clear, the data is transmitted to the C/A master. If the C/A busy flag is set, the radio repeats the wait time and tries again.

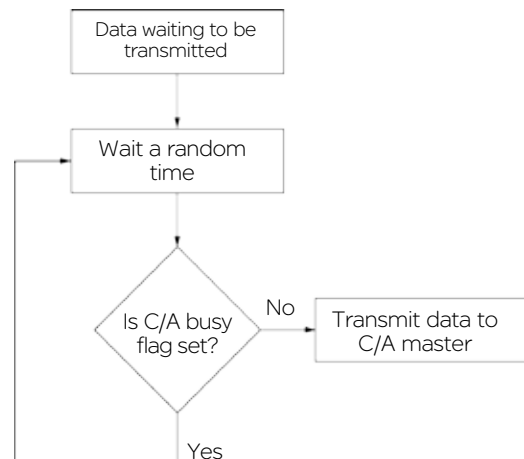

The primary difference when compared to example 1, is that the radio applies the random wait time before any attempt is made to check the C/A busy flag.

This collision avoidance configuration provides maximum radio channel efficiency when there is synchronous data traffic on the radio channel (i.e. GPS timing, synchronous exception reports).

### Rx data 'Priority':

In PTMP/R system topologies, where the Entry Point radio is half duplex, the configuration of Rx data priority may be required. This is particularly useful for asynchronous traffic, such as a combination of SCADA exception reporting and polling. In this scenario, the probability that a data packet currently being receive by the Entry Point radio is for the Entry Point radio and not for a remote, is high. Therefore, without Rx data priority, incoming packets to the Entry Point radio would be lost if priority was given to transmitting packets.

## Compression

---

In determining whether to use compression, the type of application and the latency requirements may need to be considered. Compression will typically reduce the size of data packets being sent over the radio channel, if the original data is compressible, at the expense of slightly (ie: a few milliseconds) longer latency. SCADA traffic such as DNP3 or Modbus are well suited to compression. Applying compression to data that is highly random (ie: encrypted data) should be avoided as it is unlikely to be compressible. Compression is enabled by default.

## Ethernet Filtering

---

Ethernet filtering provides an easy to configure Layer 2 filtering mechanism, which can help prevent unnecessary Ethernet traffic and increasing channel loading. There are various different addressing methodologies that can be filtered, which include:

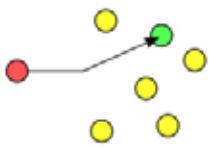

### Unicast:

Unicast is an addressing methodology that delivers messages to a single network destination identified by a unique address.

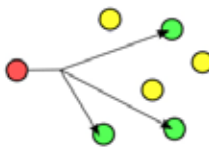

### Multicast:

Multicast is an addressing methodology that delivers messages to a group of destination addresses simultaneously in a single transmission. Spanning tree messages are an example of multicast messages.

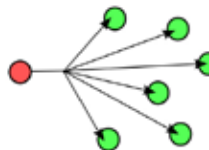

### Broadcast:

Broadcast is an addressing methodology that delivers messages to every device on a network. The broadcast address of a device is calculated from the subnet mask. If all devices within a network use a common network mask, the broadcast address will also be common.

Although typical SCADA applications only require Unicast & ARP data, the filtering mechanism provides the option to allow:

- All Ethernet traffic
- Unicast & ARP only (ARP is primarily used by networks to identify which physical devices own which IP addresses).
- Unicast only (Only used when a MAC address table is statically assigned).
- Or allow traffic from a single MAC address only.

Although Spanning tree messages are multicast messages, they are also filtered out unless the user is allowing all Ethernet traffic to pass. This also helps to prevent unnecessary channel loading.

## Connectivity

### Embedded Serial Device Server

A serial device server can perform two tasks: encapsulate serial data within IP headers to allow transportation of the serial data over a LAN/WAN, or take IP encapsulated serial data, strip off the IP headers and output the raw serial data. Normally, systems require a standalone device server to integrate external serial devices at remote sites into a managed LAN/WAN. Q data radios provide the functionality of two embedded device servers which avoids the requirement for an external device server. The example below shows a traditional IP radio, Ethernet to serial topology, using an external device server.

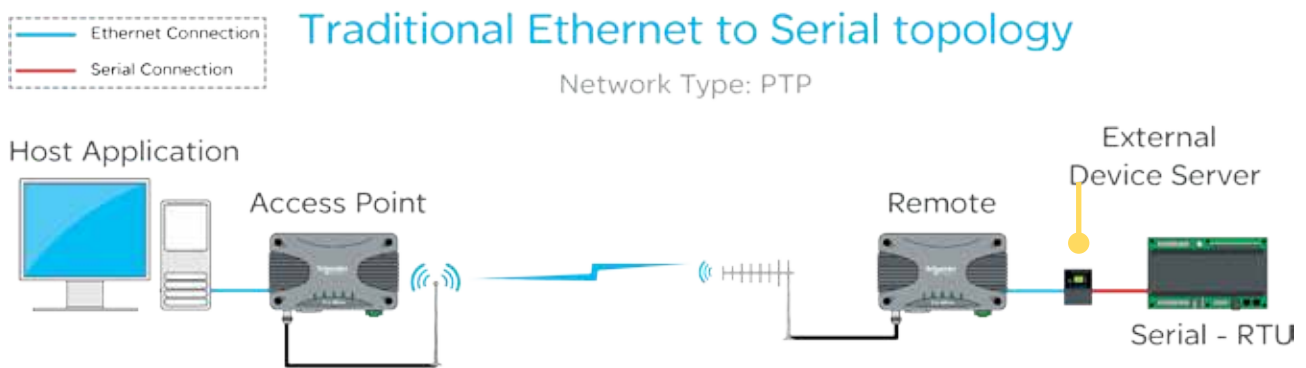

In a system that requires a serial connection to a remote end device and an Ethernet connection at the Host application end, the device server should be enabled within the remote radio. When the embedded device server is enabled, the remote radio provides the same functionality as if there was an external device server at the remote site. This functionality is also available in a PTMP system.

Device Server mode provides an easily configurable mechanism for transporting serial traffic that does not have any built-in addressing. The benefit of the device server feature is that device addressing can be performed using IP addresses for non-addressable serial protocols, without the need for external terminal servers or managing serial devices using the IP address of the remote radio.

Features of the embedded serial device server include:

- Support for two independent fully configurable serial device servers.
- Support for three transport protocols: TCP, UDP and PPP.
- Support for three modes of TCP operation: Client mode, Server mode and Client/Server mode.
- User-configurable port numbers.
- Support for up to 4 simultaneous TCP connections when operating in server mode.

The diagram below shows a typical setup using the device server functionality in remote radios.

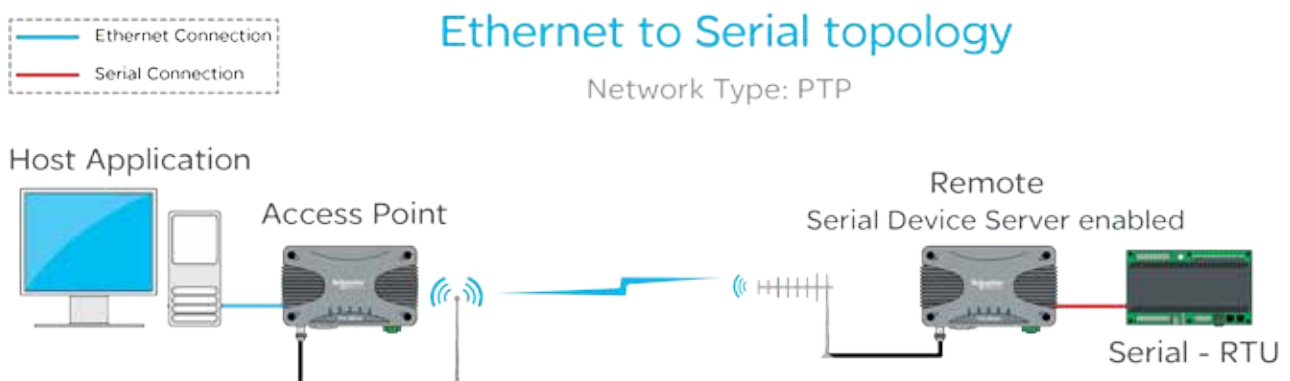

### Embedded MODBUS Gateway

Q data radios have an embedded MODBUS Gateway feature that can be enabled to function like an external MODBUS gateway. The MODBUS gateway is a protocol converter between MODBUS/TCP and MODBUS RTU protocols. The gateway is an addition to the Device Server feature on the legacy serial port.

When operating in MODBUS gateway mode, the remote radio provides the same functionality as if there was an external MODBUS gateway at each remote site of the system. In traditional systems, standalone MODBUS gateways were required to convert the IP MODBUS TCP protocol to MODBUS RTU, the example below shows a traditional MODBUS TCP system using a stand-alone MODBUS gateway at each remote site.

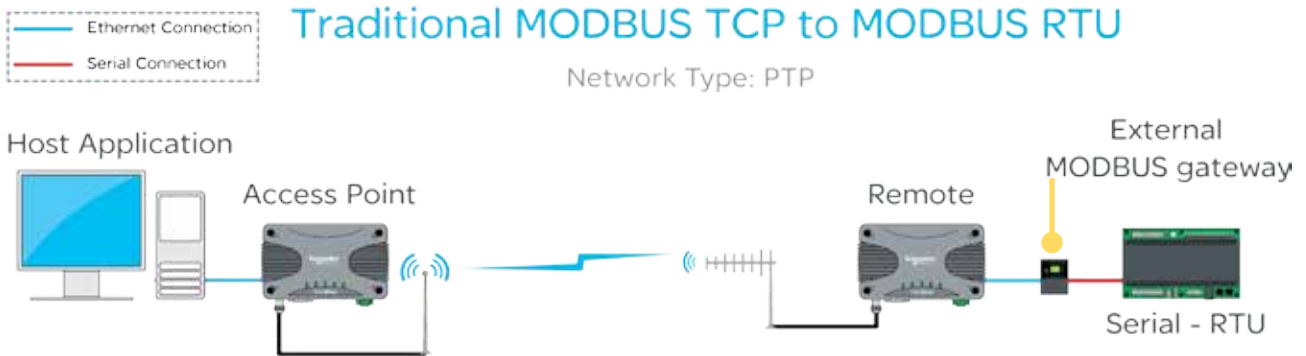

When operating in MODBUS gateway mode, the remote radio provides the same functionality as if there was an external MODBUS gateway at each remote site.

Features of the embedded MODBUS gateway include:

- Support for two independent fully configurable MODBUS gateways.
- Support for two transport protocols: TCP and UDP.
- Support for two modes of TCP operation: Client mode and Server mode.
- User-configurable port numbers.
- Support for up to 16 simultaneous TCP connections when operating in server mode.

MODBUS gateway mode provides an easily configurable mechanism for transporting serial traffic over an IP network (LAN/WAN). A benefit of the MODBUS gateway feature is that the limitation of MODBUS addressing (0-255) can be ignored as the IP address of the radio can be used giving unlimited addresses to external equipment such as RTUs or PLCs. Below is an example of a typical system using the MODBUS gateway (remote) feature at each remote site to avoid the limitation of MODBUS addressing.

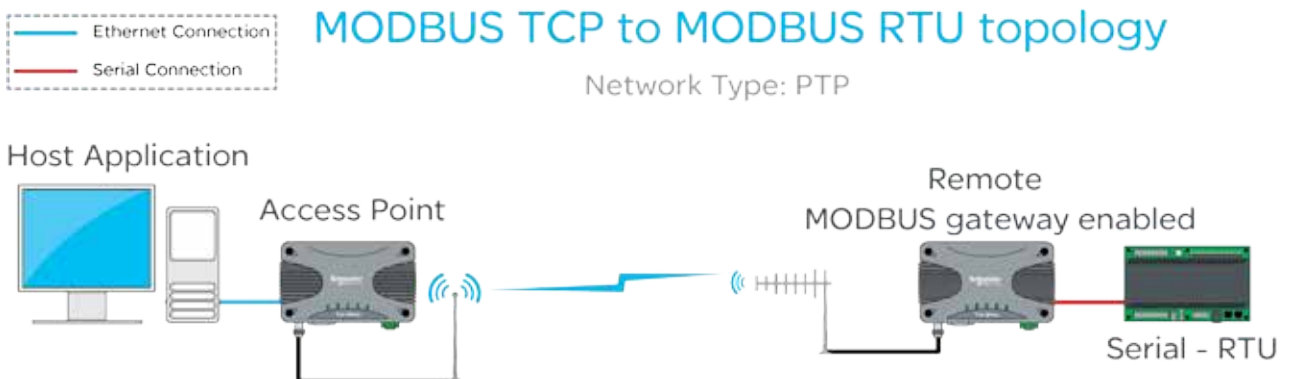

## Ease of Use

### Alarms and Events

The Q data radio can be configured to monitor specific diagnostic values and raise alarms or record events (i.e DC volts, Tx Power, etc). The radio's active condition can be evaluated by observing the event history and alarm states.

#### Event History

The events window displays the history of each event that has occurred. Each event contains a time/date stamp, an event ID, the severity level and a description of the event. Reviewing the event history can also help in fault diagnosis.

### Events

24/11/1975 17:32:06	400	EVENT	Radio power up.
24/11/1975 17:32:06	501	EVENT	Radio firmware installation successful.
26/11/1975 20:33:22	500	EVENT	Radio firmware installation activated. 1.2.6.3524 -> 1.2.6.3545
24/11/1975 17:32:10	300	EVENT	Radio changed to online status.
24/11/1975 17:32:08	301	EVENT	Radio changed to offline status.
24/11/1975 17:32:06	400	EVENT	Radio power up.
24/11/1975 17:32:10	300	EVENT	Radio changed to online status.
24/11/1975 17:32:08	301	EVENT	Radio changed to offline status.
24/11/1975 17:32:06	400	EVENT	Radio power up.
24/11/1975 17:34:29	51	EVENT	Active critical alarms detected.
24/11/1975 17:34:29	190	CRITICAL	Operational critical alarm detected.
24/11/1975 17:33:21	300	EVENT	Radio changed to online status.
24/11/1975 17:33:18	301	EVENT	Radio changed to offline status.
24/11/1975 17:33:16	400	EVENT	Radio power up.
24/11/1975 17:33:16	300	EVENT	Radio changed to online status.

#### Alarm States

Alarms can be displayed in the following states: Disabled, Normal, Recovered, Warning or Critical.

Warning state thresholds for some alarms can be configured to best suit user requirements. This can provide early detection and notification before an issue becomes critical (i.e. damaged antenna, lost power/battery backup, etc).

Alarm state changes can also be subscribed to by notification services such as SNMP and digital outputs.

ID	ALARM	STATE	CURRENT VALUE
50	Global Alarm		
60	Base Health		
100	Frequency Offset		
110	Received Signal Strength Indication (RSSI)		
120	VSWR		< 1.5:1
130	Tx Power		30.3dBm
140	DC Supply		12.0V
150	Temperature		35.0 (Deg C)
160	Ethernet Link		
170	PLL Lock		
180	Fan		
190	Operational		
200	Rx Packet Comparison		
210	RSSI Comparison		



## SNMP Diagnostics

The Q data radio can provide SNMP diagnostic data via an internal SNMP agent. The radio supports SNMP v1 & v2c along with notifications which includes traps and informs. SNMP facilities include RFC1213, Ethernet diagnostics and radio diagnostics

The features and benefits of SNMP diagnostics include:

- SNMP messages/notifications that can be sent to Clear SCADA or SNMP management software.
- SNMP notifications that provide real time alarm detection reporting.
- Helping to eliminate the need for radio polling.
- Radios that can send diagnostic information via SNMP periodically (diagnostics heartbeat).

MIB files made available by Schneider Electric may be imported into most major SNMP Management consoles. These .MIB files define the contents of the SNMP parameters including a description for each parameter. The parameters are sorted into six distinct groups: General, Radio, Security, LAN, Error and Notification.

## SNMP Notifications

The Q data radio have the capability to send SNMP notifications. An SNMP notification is a message to inform a user that a radio state has changed. These states include: input voltage, temperature, Tx power, etc. There are two types of SNMP notifications available: traps and informs.

- A trap is a single UDP message that is sent from the Q data radios to a user defined SNMP manger.
- An inform is still a UDP message, however, an inform requests a response to the UDP message sent. This allows retries and time outs to be used within the radio.

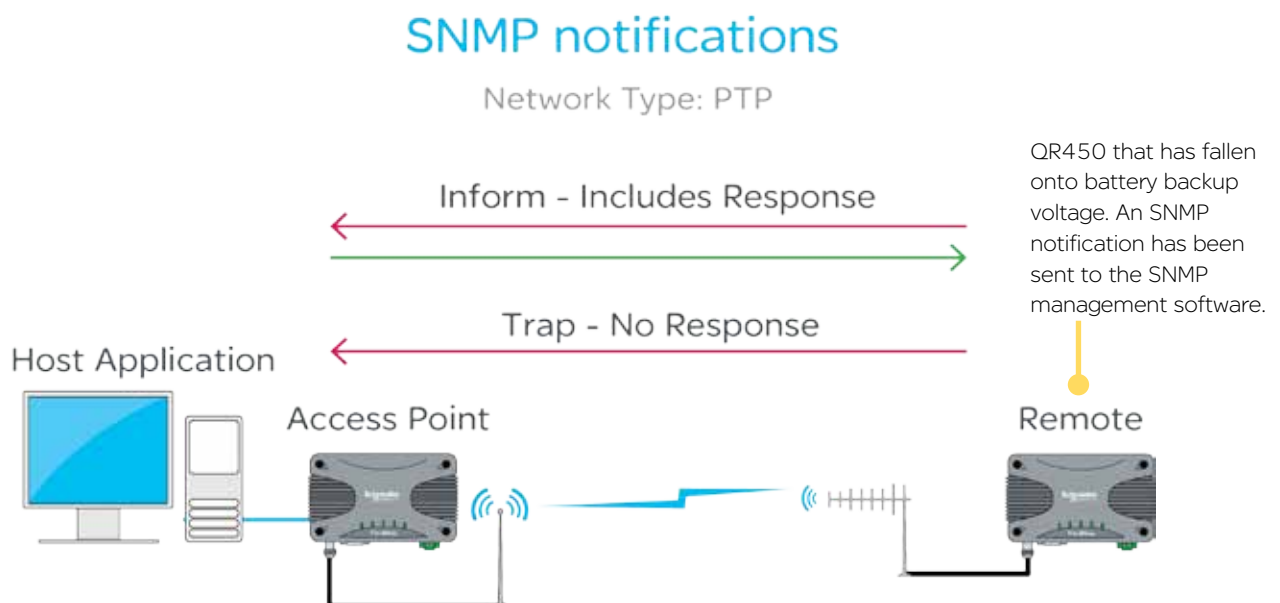

### Web User Interface (WUI)

---

Q data radios provide a graphical Web User Interface (WUI) which can be accessed by a web browser to perform configuration changes. This helps to eliminate the requirement for stand-alone configuration software to be installed on a PC.



### Text User Interface (TUI)

---

The text user interface (TUI) provides an alternative to the HTML web user interface for configuration and diagnostics. The TUI can be accessed directly from the serial port of the Q data radio or via a telnet or SSH session. The TUI is enabled on COM 1 by default, while Telnet is also enabled by default, however, this requires an Ethernet connection. Access to the TUI via the serial port is useful if you have forgotten the IP address of the radio you are trying to configure or diagnose.

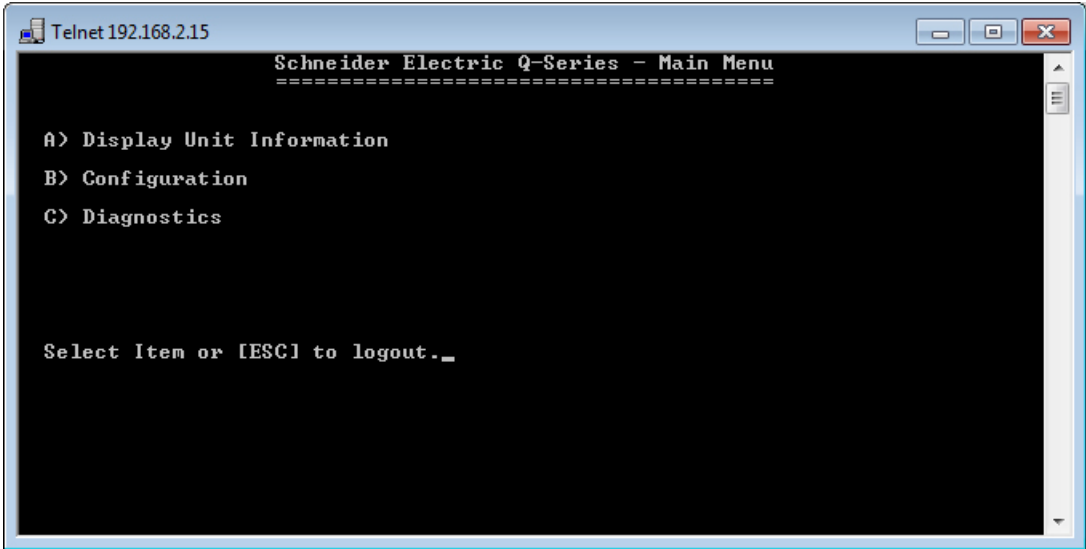

## Diagnostics Tools

The Q data radios provide SNMP access to radio diagnostics as well as providing embedded (web) diagnostics and commissioning features.

### Radio Diagnostics:

The Q data radios include the ability for installers to review useful radio & Ethernet diagnostics parameters. The parameters include unit specific (date & time), network specific (Ethernet traffic) and radio specific parameters (Tx Power, DC volts, etc). Diagnostics can be accessed via the web user Interface or using the TVIEW+ Diagnostics suite (via eDiags) or via serial console (COM 1 enabled by default). Diagnostics can also be accessed via SNMP.

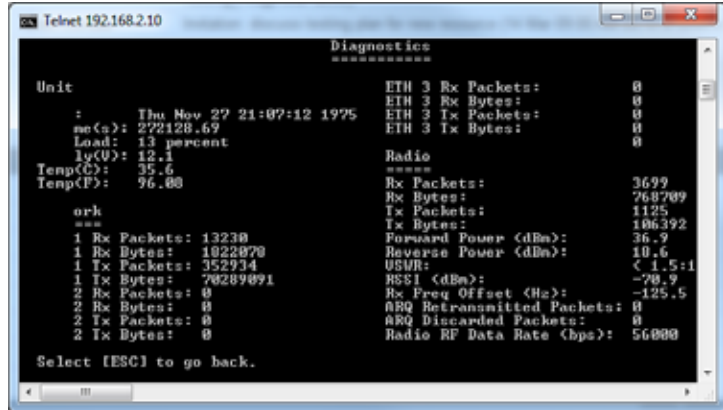

### Statistics Log:

The Q data radios include the ability to measure and record radio diagnostics and performance statistics over a period of time. This facility is known as the statistics log. The statistics log can be configured to display/log data at a low, medium or high frequency depending on a user's requirements and can also be saved to a CSV file for further analysis.

Date		Up Time (sec)	CPU Load (%)	ETH 1 Rx Packets	ETH 1 Rx Bytes	ETH 1 Tx Packets	ETH 1 Tx Bytes	ETH 2 Rx Packets	ETH 2 Rx Bytes	ETH 2 Tx Packets	ETH 2 Tx Bytes	ETH 3 Rx Packets	ETH 3 Rx Bytes	ETH 3 Tx Packets	ETH 3 Tx Bytes	Radio Rx Packets	Radio Rx Bytes	Radio Tx Packets	Radio Tx Bytes	Radio Offsets	
Mon	Nov 24 17:34:28	170	47.2	222	38058	223	80388	0	0	0	0	0	0	0	0	0	18	1224	NA		
Mon	Nov 24 17:34:29	100	82.0	2	128	0	0	0	0	0	0	0	0	0	0	0	0	0	0	NA	
Mon	Nov 24 17:34:34	171	45.0	192	33245	196	78613	0	0	0	0	0	0	0	0	0	0	0	0	NA	
Mon	Nov 24 17:34:14	182	87.0	48	7003	0	0	0	0	0	0	0	0	0	0	0	4	288	NA		
Mon	Nov 24 17:34:17	188	82.8	0	0	0	0	0	0	0	0	0	0	0	0	0	0	0	0	NA	
Mon	Nov 24 17:34:18	184	73.0	83	9110	0	0	0	0	0	0	0	0	0	0	0	0	0	0	NA	
Mon	Nov 24 17:34:17	185	8.4	0	0	0	0	0	0	0	0	0	0	0	0	0	0	0	0	NA	
Mon	Nov 24 17:34:16	185	24.4	0	0	0	0	0	0	0	0	0	0	0	0	0	0	0	0	NA	

**Packet Transmission Testing:**

When commissioning a radio link, it is useful to generate Ethernet traffic to test the link for functional performance. One method of generating traffic is using the “ping” utility provided on MS Windows based operating systems. Another method is to perform a packet transmission test. This can be done using the “Packet Transmission Test” facility provided in the radio.

To perform the test, the user specifies the destination radio or Ethernet device IP address, number of packets to send, time between packets (in milliseconds), packet length (in bytes), timeout and time between page refreshing. The test facility will then execute the test and provide the results, which can then form part of the commissioning process.

**Broadcast Firmware Upgrades**

---

The TView+ Management Suite provides an over-the-air firmware update tool for Q Data radios. The firmware update feature is speed-limited to help prevent RF channel congestion and can broadcast to all of the remotes within a Q data radio system.

Broadcasting to all remotes has the benefit of upgrading the alternative firmware pack in many radios simultaneously, without the need to send firmware to each remote radio individually. Due to the speed-limiting of the firmware upgrade process, SCADA data will not be blocked or interfered with while firmware packs are being transferred.

Each radio stores two sets of firmware. The current firmware pack is the firmware the radio is running from. The alternative firmware pack is a secondary (optional) area where alternative firmware can be stored. When the alternative firmware pack has been updated, it can then be activated which moves the alternative firmware into the current firmware pack area, and causes the radio to reboot using the new firmware.

The firmware upgrade tool also provides the capability of individual activation or group activation, depending on user preference. Firmware upgrades are typically done using “patch” files where only the difference between the current and target firmware is actually sent. This reduces the over the air transmission of firmware data by up to 90%

See Part J for detailed information on this topic.

### Trio E-Series Emulation Mode

Trio Q data radios can be configured to operate in E-Series mode. This can help a user to determine the length of time a full system upgrade will take. See the examples below:

#### Typical E-Series system - Stage 1

The diagram below shows a typical E-Series system.

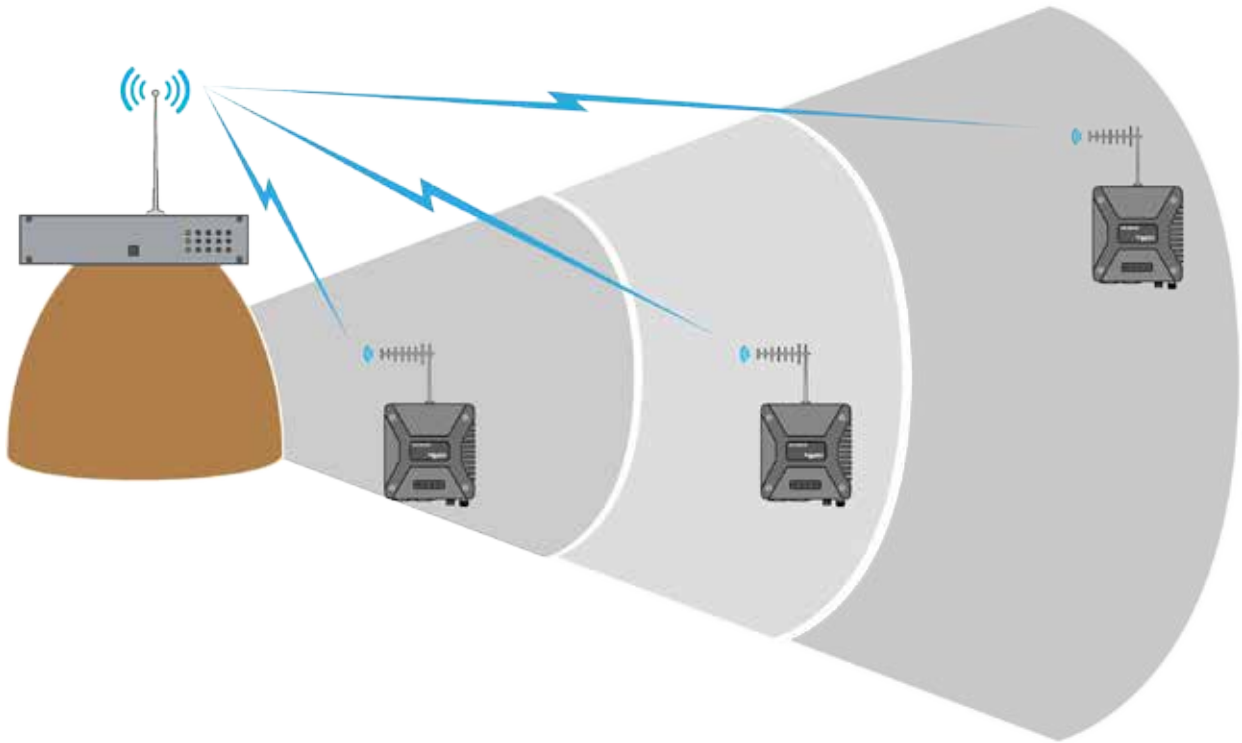

#### E-Series system upgrade - Stage 2

New installations or replacements of E-Series radios can be performed with Q data radios operating in E-Series compatibility mode. This allows for a controlled and steady system upgrade. The diagram below shows Q data radios operating within an E-Series system.

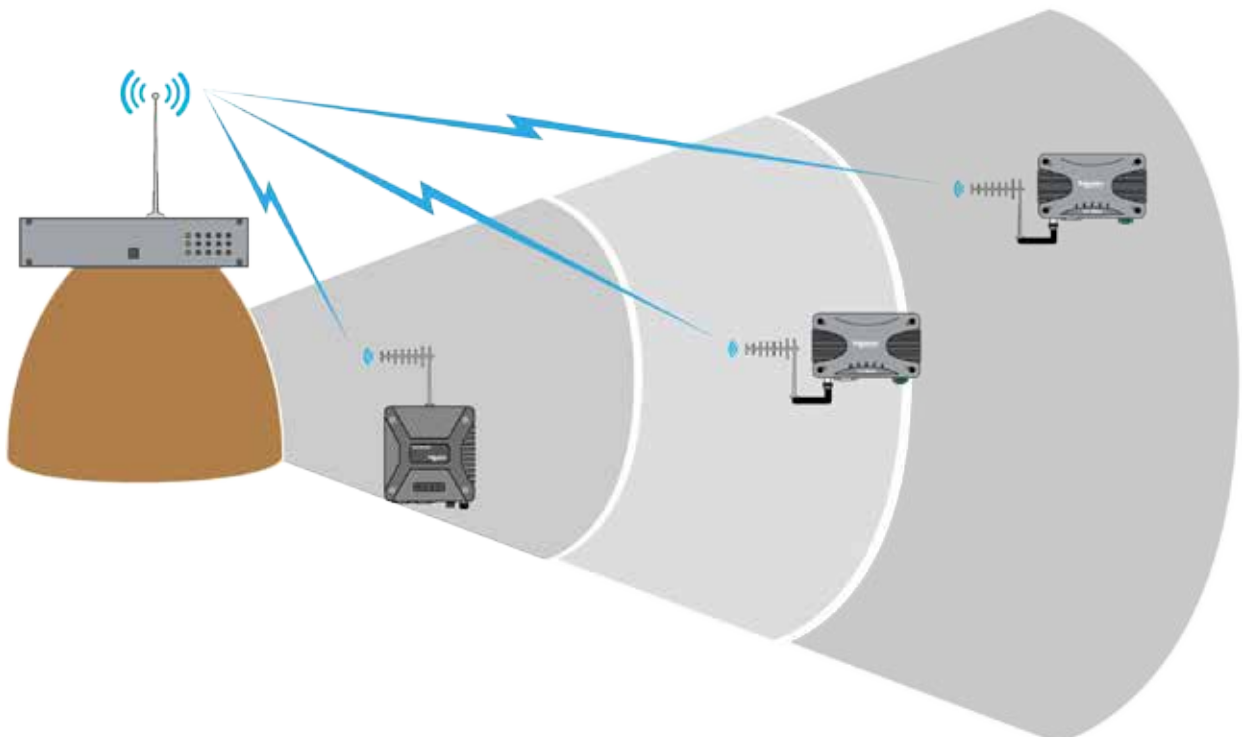

**Switch system to Q Mode - Stage 3**

Once all E-Series have been replaced, the Q data radios may be re-configured to operate in Q mode, to provide advanced features and functionalities of the Q data radios.

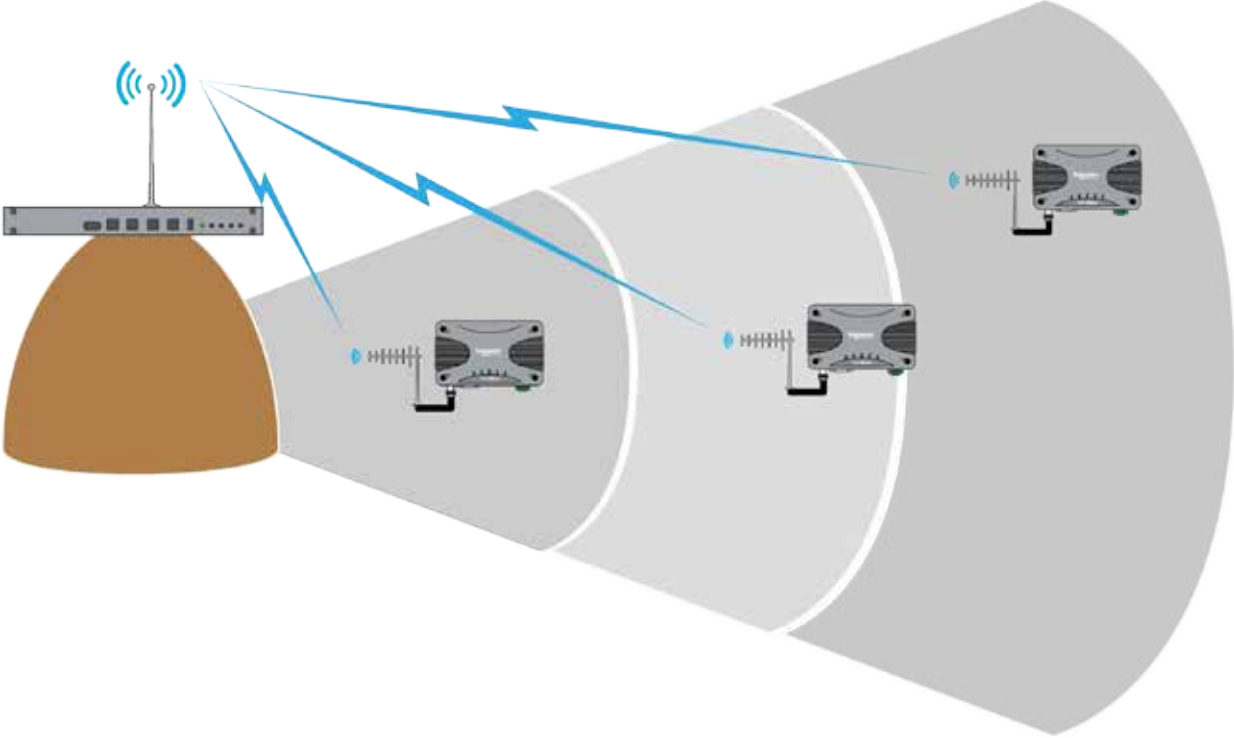

## Security

### Password Protection

Configuration information can be protected by a user-defined login name and password. When a password is set, the programmer will request the password each time the radio is read. No configuration information can be displayed or changed without the entry of the correct password.

### AES encryption

The 256-bit AES encryption feature can provide an encrypted channel that helps to prevent eaves-dropping and snooping. The effort for configuration is minimal as the radio automatically adjusts, to keep packet transport compatible (i.e.: MODBUS messages are not broken up). Enabling encryption requires additional overhead depending on packet sizes being sent.

### Secure Shell (SSH)

SSH provides a secure and authenticated method for remotely accessing the Q data radios text user interface (TUI) for configuration and diagnostics.

To access Q data radios via SSH, the network management PC requires an SSH-capable program (ie: Putty).

All traffic over the SSH connection is encrypted.

During the first connection to the SSH terminal software, a “fingerprint” of the remote device is taken and stored on the Network Management PC. This allows for authentication in the future.

The SSH session also requires the user to enter a user name and password for authorised access to the TUI.

#### SSH example:

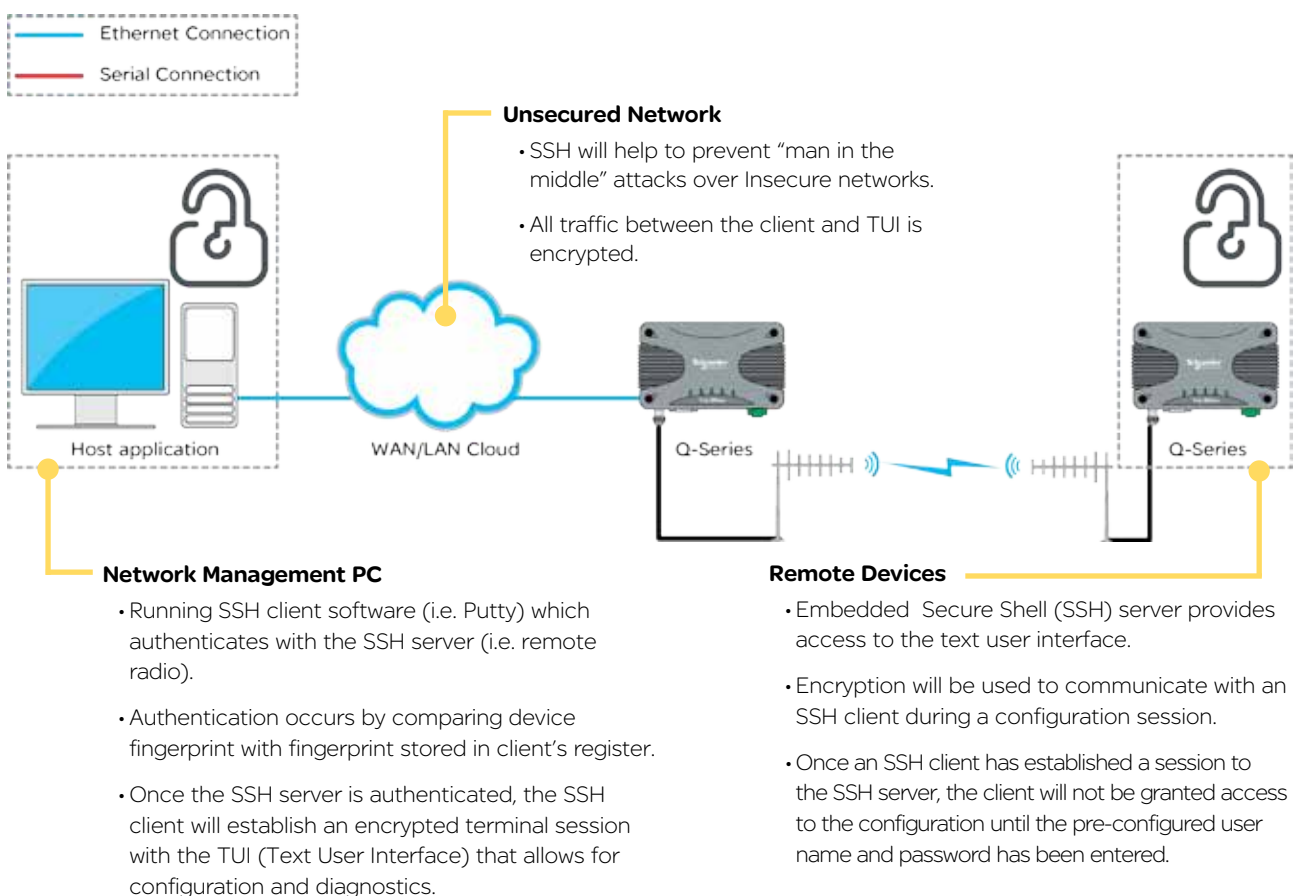

## HTTP Secure (HTTPS)

HTTPS provides a secure and authenticated method for remotely accessing the Q data radios Web User Interface (WUI) for configuration and diagnostics.

To access the Q data radios via HTTPS, use a web browser which has HTTPS capabilities. Common web browsers which provide HTTPS capabilities include: Internet Explorer, Firefox and Chrome.

The HTTPS client (web browser) will request a digitally-signed certificate from the HTTPS server (Q data radios) to help ensure that the target device is authentic.

All traffic over the HTTPS connection is encrypted.

Two methods of certificate management are available: Self-signed certificates generated by the radio itself or the use of certificates generated by external certificate servers.

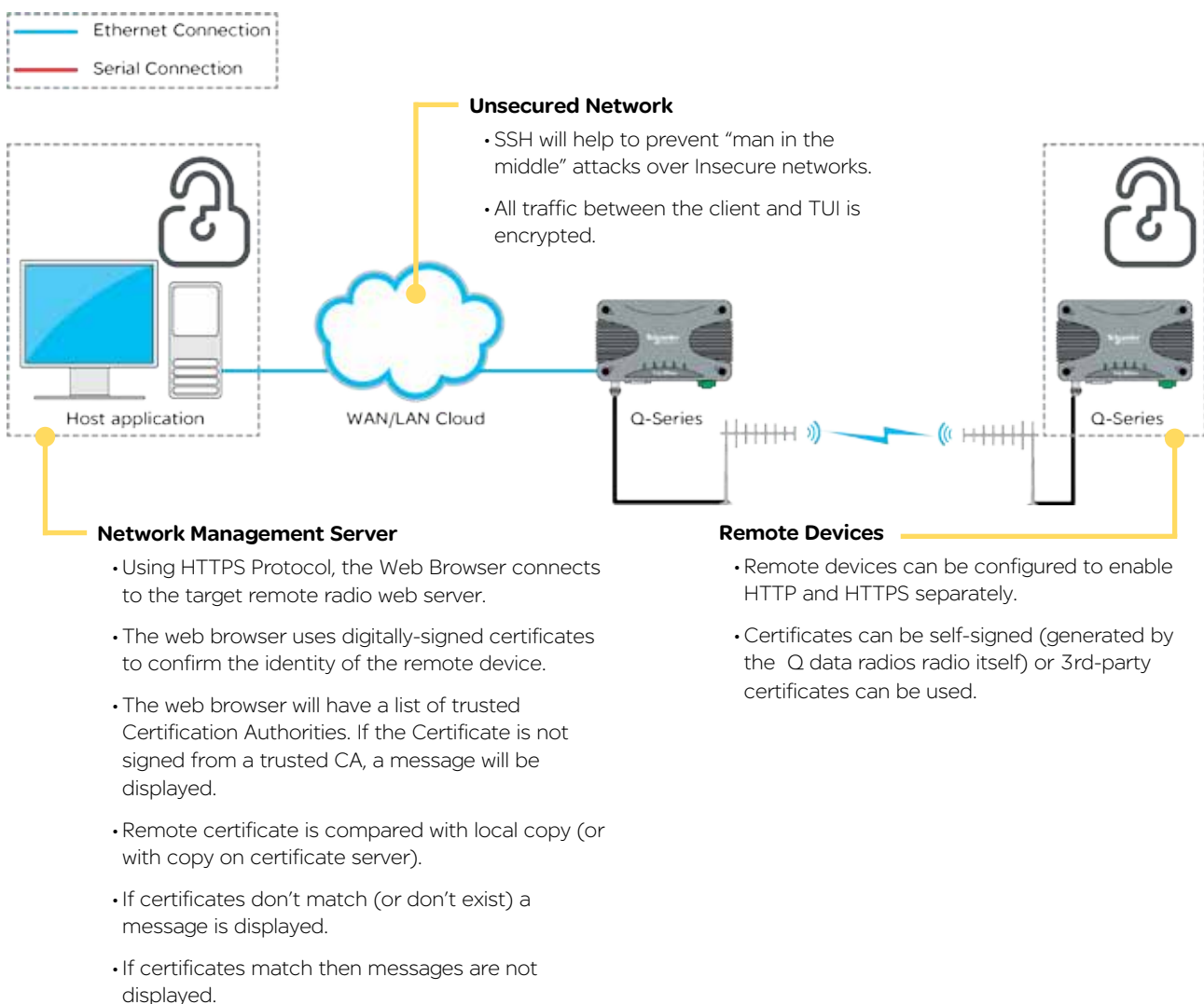



# Part E – Radio Planning and Design

## Radio Path analysis

### Clear line of sight

Radio path with good signal levels, attenuated only by free space loss.

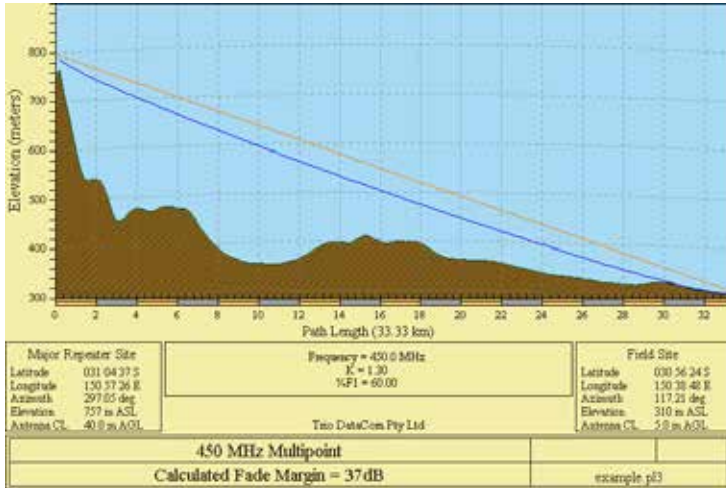

### Obstructed Radio Path

This path has an obstruction that will reduce the signal arriving at the field site.

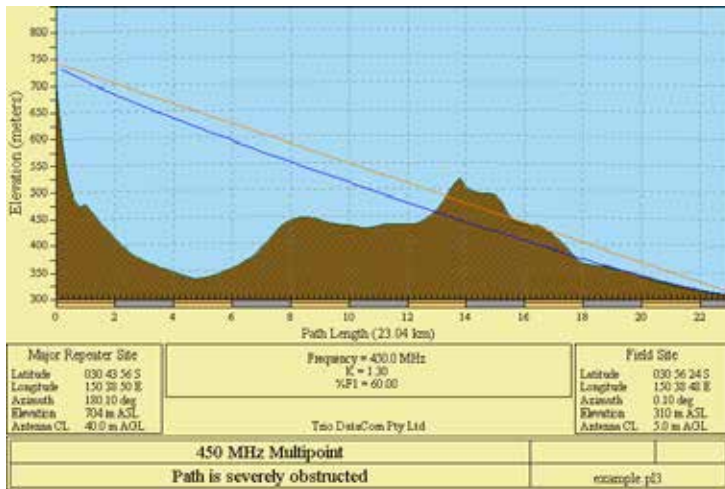

GOODPATH2400.p14	Major Repeater Site	Field Site
Elevation (m)	756.69	309.67
Latitude	31 04 37.49 S	30 56 24.00 S
Longitude	150 57 26.34 E	150 38 48.00 E
True azimuth (°)	297.05	117.21
Vertical Angle (°)	-0.94	0.72
Antenna Model	6dB Omni	16dB Grid Reflector
Antenna Height (m)	40.00	5.00
Antenna Gain (dBi)	8.15	18.15
	6.00	16.00
TX Line Type	LDF4-60	LDF4-60
TX Line Length (m)	40.00	5.00
TX Line Unit loss (dB /100 m)	6.79	6.79
TX Line loss (dB)	2.72	0.34
Connector loss (dB)	2.00	2.00
Frequency (MHz)	2400.00	
Polarization	Vertical	
Path Length (km)	33.33	
Free Space loss (dB)	130.53	
Diffraction loss (dB)	0.00	
Net Path loss (dB)	111.29	111.29
Radio Model	HR240	HR240
TX power (watts)	1.00	1.00
(dBm)	30.00	30.00
Effective Radiated Power (Watts)	1.34	23.23
(dBm)	31.28	43.66
RX Sensitivity (µv)	1.26	1.26
(dBm)	-105.00	-105.00
RX Signal (µv)	19.28	19.28
(dBm)	-81.29	-81.29
RX Field Strength (µv/m)	1014.39	243.90
Fade Margin (dB)	23.71	23.71
Rayleigh Fade Probability (%)	0.42	0.42
Log Normal Fade Probability (%)	3.88E-03	3.88E-03

### Understanding RF Path Requirements

A radio modem needs a minimum amount of received RF signal to operate reliably and provide adequate data throughput.

In most cases, spectrum regulatory authorities will also define or limit the amount of signal that can be transmitted, and the transmitted power will decay with distance and other factors, as it moves away from the transmitting antenna.

It follows, therefore, that for a given transmission level, there will be a finite distance at which a receiver can operate reliably with respect to the transmitter.

Apart from signal strength reduction due to distance, other factors that will decay a signal include obstructions (hills, buildings, foliage), horizon (effectively the bulge between two points on the earth), and factors such as fog, heavy rain-bursts, dust storms, etc.

In order to ascertain the available RF coverage from a transmitting station, it will be necessary to consider these factors. This can be done in a number of ways, including

- (a) Using basic formulas to calculate the theoretically available signal - allowing only for free space loss due to distance,
- (b) Using sophisticated software to build earth terrain models and apply other correction factors such as earth curvature and the effects of obstructions, and
- (c) By actual field strength testing.

It is good design practice to consider the results of at least two of these models to design a radio path.

**Effect of Earth Curvature on Long Paths**

This path requires greater mast height to offset the earth curvature experienced at such a distance (73km).

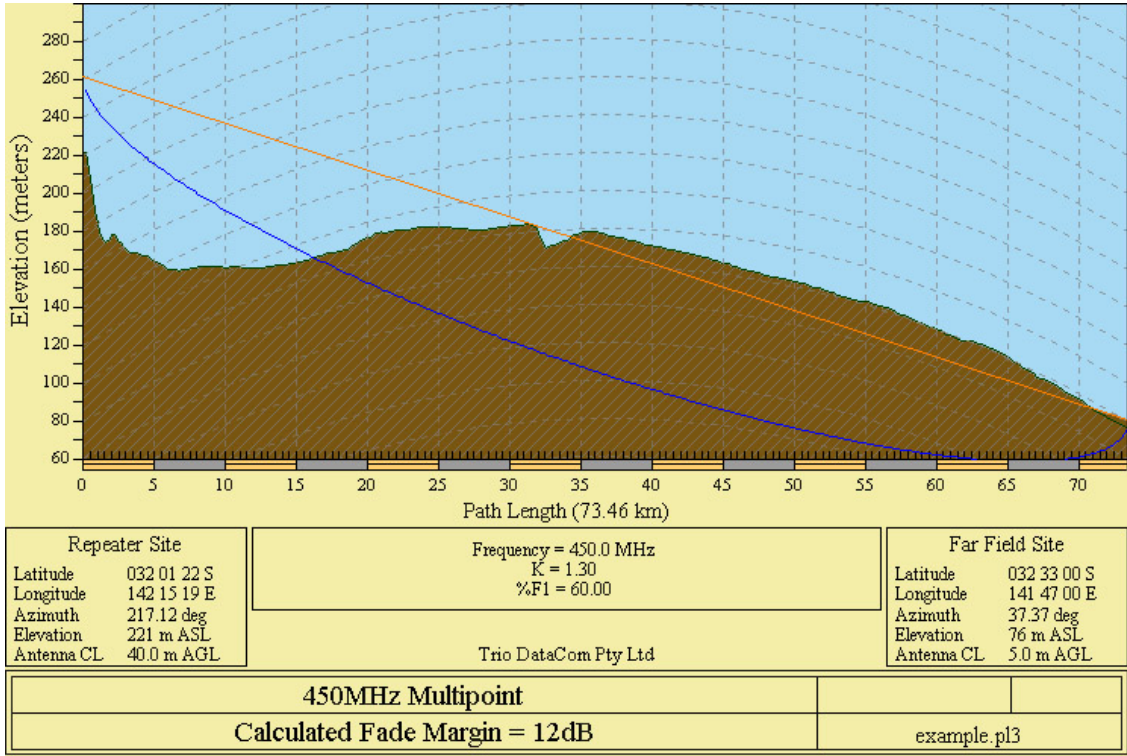

LONGPATH.PL3	Repeater Site	Far Field Site
Elevation (m)	221.26	75.58
Latitude	32 01 21.63 S	32 33 00.00 S
Longitude	142 15 19.26 E	141 47 00.00 E
True azimuth (°)	217.12	37.37
Vertical Angle (°)	-0.37	-0.03
Antenna Model	6dB Omni	15dB Grid Reflector
Antenna Height (m)	40.00	5.00
Antenna Gain (dBi)	8.15	17.15
(dBd)	6.00	15.00
TX Line Type	LDF4-50	LDF4-50
TX Line Length (m)	40.00	5.00
TX Line Unit loss (dB /100 m)	6.79	6.79
TX Line loss (dB)	2.72	0.34
Connector loss (dB)	2.00	2.00
Frequency (MHz)	2400.00	
Polarization	Vertical	
Path Length (km)	73.46	
Free Space loss (dB)	137.39	
Diffraction loss (dB)	34.02	
Net Path loss (dB)	153.18	153.18
Radio Model	HR240	HR240
TX power (watts)	1.00	1.00
(dBm)	30.00	30.00
Effective Radiated Power (Watts)	1.34	18.45
(dBm)	31.28	42.66
RX Sensitivity (µv)	1.26	1.26
(dBm)	-105.00	-105.00
RX Signal (µv)	0.16	0.16
(dBm)	-123.18	-123.18
RX Field Strength (µv/m)	8.16	2.20
Fade Margin (dB)	-18.18	-18.18

Location - Woodland (sigma = 6 dB)

## BER & Fade Margin

The BER specification used by the Q data radios shows '1 x 10E -6 BER'. This means one bit of data in a million bits of data will error at the BER threshold level. The BER threshold values can vary depending on the over the air data rate (RF speed). The BER thresholds can be found in the table shown.

Fade Margin is the amount by which a received signal level may be reduced without causing system performance to fall below a specified threshold value, in this case, the specified threshold value is defined by the radio's Bit Error Rate (BER).

20dB to 30dB fade margins are typical design targets, however, 15db may still be acceptable if this is all that is possible.

Regulatory Region	Channel Bandwidth (KHz)	RF Speed (Kbps)	BER threshold (10 <sup>6</sup> )
FCC	12.5	8	-113
		16	-110
		24	-107
		32	-100
ACMA/ ETSI	12.5	8	-113
		16	-110
		24	-107
		32	-100
	25	14	-111
		28	-109
		42	-106
		56	-99

Fade margin is required to maintain the radio link quality if the signal fades, factors that can influence signal fading include:

- Reflections
- Rain
- Maintenance Issues

When a Q data radio system is configured for Dynamic mode, the 20 dB (typical) fade margin calculation may be performed using the lowest data rate, for best receiver sensitivity. (8 kbps in a 12.5 kHz channel or 14 kbps in a 25 kHz channel) This helps to ensure a strong reliable path when conditions are poor

The amount of fade margin a radio link has can be calculated by performing a theoretical system gain calculation.

Factors that can influence system gain include: Tx power of Transmitting Radio, Coaxial Cable, Antenna Gains, Free Space Loss, Rx sensitivity of receiving radio. See the example below.

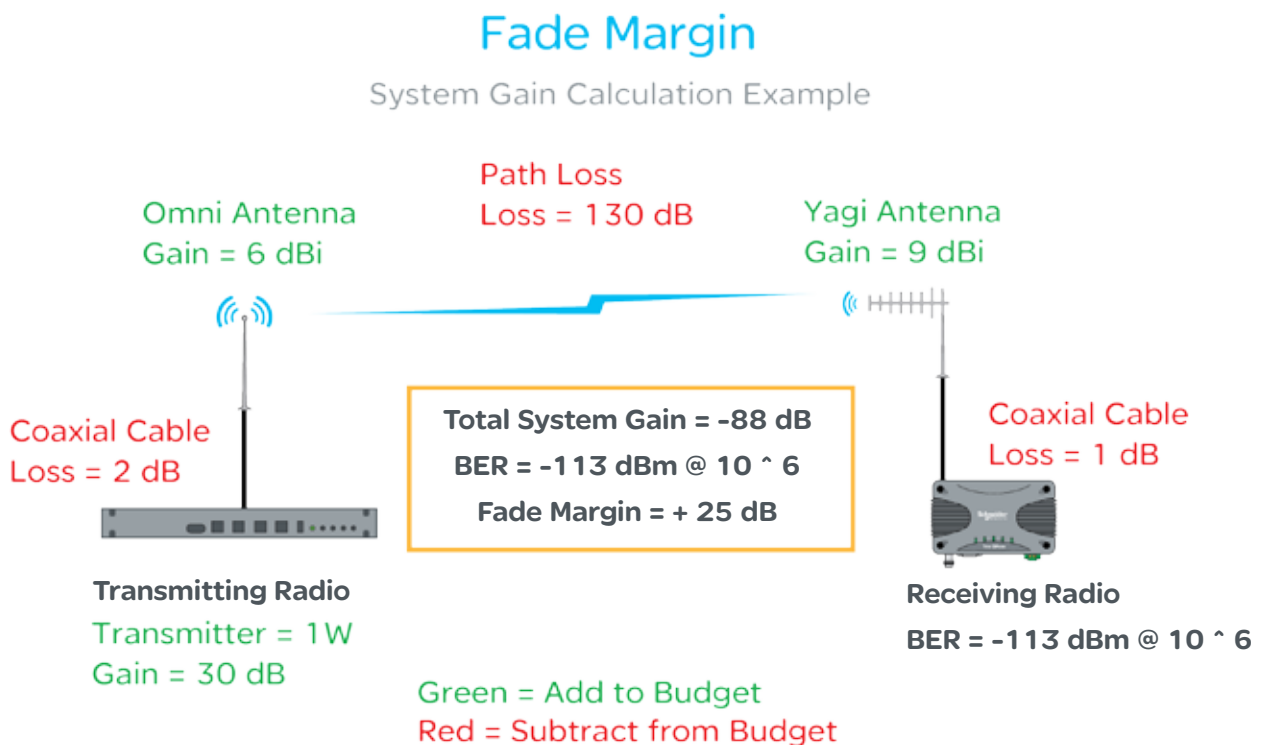

The example is showing the factors within a radio link that can influence the signal strength of the transmitting radio at the receiving radio (total system gain). Once the total system gain is calculated, the result is -88 dB. This means the received signal strength (RSSI) at the receiving radio should be -88dBm.

As the BER threshold of the receiving radio is at -113 dBm, with an RSSI value of -88, the fade margin, before 1 bit in a million bits of data become lost, is 25 dB. In other words, the RSSI level at the receiving radio can fluctuate up to -25 dB before data loss may start to occur in over the air transmissions.

## Radio Accessories

### Antennas

There are basically two types of antennas – omnidirectional and directional.

Omnidirectional antennas are designed to radiate signal in a 360 degrees segment around the antenna. Basic short range antennas such as folded dipoles and ground independent whips are used to radiate the signal in a “ball” shaped pattern. High gain Omni antennas such as the “co-linear” compress the sphere of energy into the horizontal plane, providing a relatively flat “disc” shaped pattern which goes further because all of the energy is radiated in the horizontal plane.

Directional antennas are designed to concentrate the signal into a “beam” of energy for transmission in a single direction (i.e. for point-to-point or remote to base applications).

Beamwidths vary according to the antenna type, and so can be selected to suit design requirements. The most common directional antenna is the YAGI, which offers useable beam widths of 15-40 degrees. Higher “gain” is available using parabolic “dish” type antennas such as gridpacks.



**Omni directional  
360 degree signal  
Antenna Gain**

**Directional  
Concentrated beam**

By compressing the transmission energy into a disc or beam, the antenna provides more energy (a stronger signal) in that direction, and thus is said to have a performance “gain” over a basic Omni antenna. Gain is usually expressed in dBd, which is referenced to a standard folded dipole. Gain can also be expressed in dBi, which is referenced to a theoretical “isotropic” radiator. Either way, if you intend to send and receive signals from a single direction, there is advantage in using a directional antenna - due to the increased signal in the wanted direction, and the relatively decreased signal in the unwanted direction (i.e. “interference rejection” properties).

### Alignment of Directional Antennas

This is generally performed by altering the alignment of the antenna whilst measuring the received signal strength. If the signal is weak, it may be necessary to pre-align the antenna using a compass, GPS, visual or map guidance in order to “find” the wanted signal. Yagi antennas have a number of lower gain “lobes” centred around the primary lobe. When aligning for optimal signal strength, the antenna should be scanned through at least 90 degrees, to help ensure that the centre (strongest) lobe is identified.

When aligning a directional antenna, avoid placing hands or body in the vicinity of the radiating element or the forward beam pattern, as this will affect the performance of the antenna.

### Antenna Placement

When mounting the antenna, it is necessary to consider the following criteria:

The mounting structure will need to be solid enough to withstand additional loading on the antenna mount due to extreme wind, ice or snow (and in some cases, large birds).

For Omni directional antennas, it is necessary to consider the effect of the mounting structure (tower mast or building) on the radiation pattern. Close-in structures, particularly steel structures, can alter the radiation pattern of the antenna. Where possible, Omni antennas should be mounted on the top of the mast or pole to minimise this effect. If this is not possible, mount the antenna on a horizontal outrigger to get it at least 1-2m (3-6 ft) away from the structure. When mounting on buildings, a small mast or pole, 2-4m (6-12ft) can significantly improve the radiation pattern by providing clearance from the building structure.

For directional antennas, it is generally only necessary to consider the structure in relation to the forward radiation pattern of the antenna, unless the structure is metallic, and of a solid nature. In this case it is also prudent to position the antenna as far away from the structure as is practical. With directional antennas, it is also necessary to ensure that the antenna cannot move in such a way that the directional beamwidth will be affected. For long YAGI antennas, it is often necessary to install a fibreglass strut to stabilise the antenna under windy conditions.

### Connecting Antennas and RF Feeders

The RF antenna system should be installed in accordance with the manufacturer’s notes. Consider the antenna gain when setting transmit power on the radio. EIRP limits will vary depending on your geographic location. Check with your local authority to ensure you are abiding to the local laws.

### **▲ WARNING**

#### **HAZARD OF RADIO FREQUENCY (RF) BURNS**

Ensure that a matching load or antenna is attached to the RF port prior to applying power to the device.

**Failure to follow these instructions can result in death or serious injury.**

## RF Feeders and Protection

### Lightning Arrestor

A lightning arrestor is used to help minimise lightning damage to radio devices. Lightning arrestors are made to bleed off electrostatic build-up to help prevent a direct lightning strike from hitting the antenna system. Also, if a lightning strike happens nearby, the arrestor helps to route the energy to ground.

The lightning arrestor is typically installed on the inside of a radio hut, between a coaxial tail lead the antenna feeder cable. The lightning arrestor comes with an N-Type female socket on each end.

### RF Coaxial Cable

There are many types of RF coaxial cables available, but it is sometimes difficult to know which type of cable to use.

There are two main aspects of a cable to consider when selecting the right cable for the job.

#### Bend Radius:

The bend radius of a cable is a specification given to a cable to define how flexible the cable is. Exceeding the bend radius specification can change characteristics within the cable and lead to reduced RF performance. The thicker the cable is, the wider its bend radius will be, however, the thicker the cable, the lower its electrical resistance will be, providing less impact on the radio system gain.



The cable connected from the radio to the lightning arrestor is typically quite short. This allows a thin, flexible cable to be used. Thin flexible cables have a higher electrical resistance characteristic than thick rigid cables, but as there is only a short length being used, the impact on radio system gain is negligible. The thick rigid cable is typically connected from the hut to the top of an antenna mast connected to an antenna.

#### Cable Loss:

Each cable has its own specified cable loss characteristics. These characteristics can vary depending on what frequency is being carried through the cable. See the table below for typical cable loss values.

Cable Type	Loss (dB) Relative to Distance (m) - at 450MHz			
	1 dB	3 dB	6 dB	9 dB
RG58	2.3 m (7ft 6in)	7 m (23ft)	14 m (46ft)	20 m (65ft 6in)
RG223	3.1 m (10ft)	8 m (26ft)	18 m (59ft)	28 m (92ft)
RG213	6.1 m (20ft)	18 m (59ft)	37 m (121ft 6in)	55 m (180ft 6in)
LDF 4-50	19 m (62ft)	57 m (187ft)	114 m (374ft)	171 m (561f)
LDF 5-50	38 m (124ft)	114 m (374ft)	229 m (751ft)	343 m (1125ft)



# Part F – Quick Reference Guide

## Introduction

Welcome to the quick reference guide for the Q data radios. This guide provides general information on the physical attributes of the Q data radios including, physical dimensions, mounting guides, LED indications and physical interface connections.

## Half Duplex Radio - QR450

### Typical Radio Setup

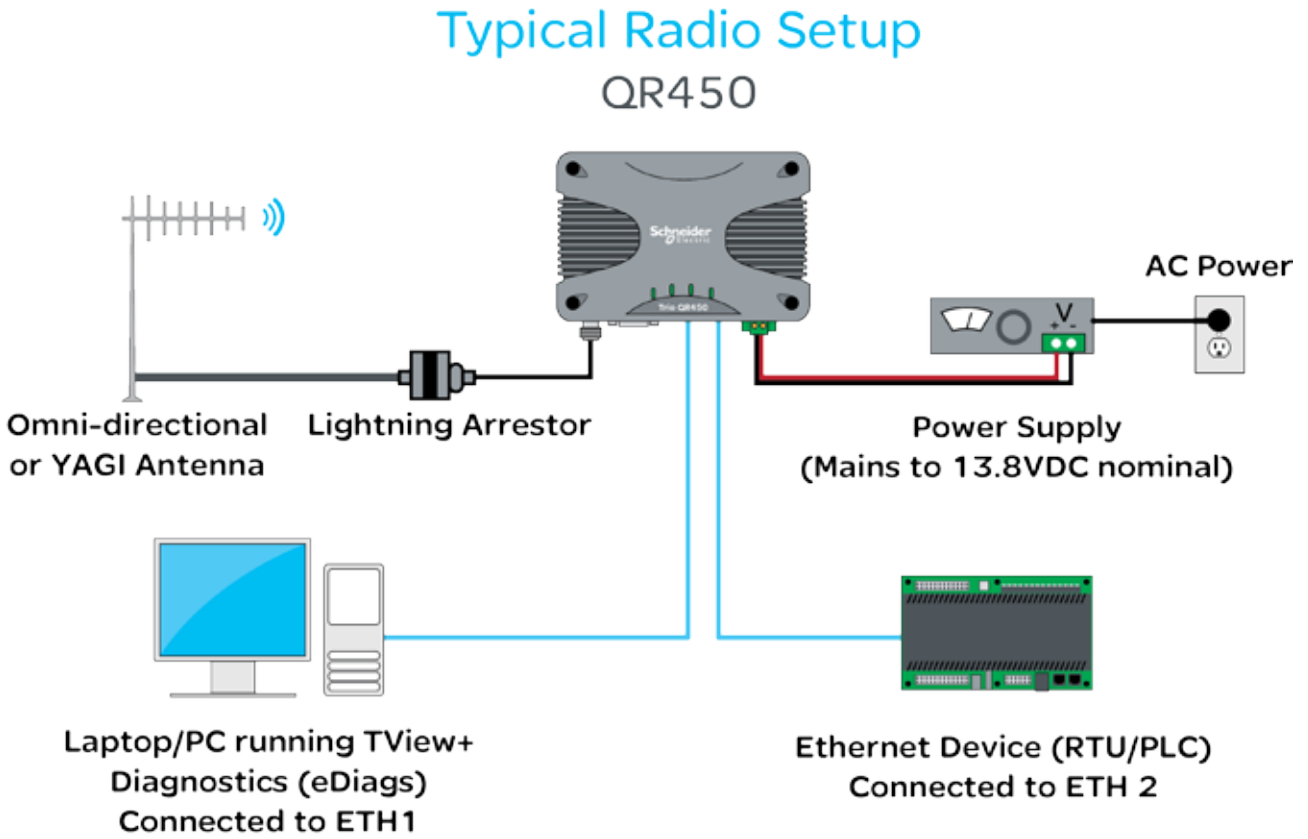

### Mounting Instructions

The radio should be mounted in a clean and dry location, protected from water, excessive dust, corrosive fumes, extremes of temperature and direct sunlight. In high power or high temperature applications, allow sufficient passive or active ventilation. To avoid moisture ingress it is suggested to mount the radio with the connectors facing downwards.

When mounting the equipment, consideration should be given to the environmental aspects of the site. The cabinet should be positioned so that it is shaded from potential high temperature of the afternoon sun, or icy cold wind. Although the radios are designed for harsh temperature extremes, they will give a longer service life if operated in a more stable temperature environment.

In an industrial environment, the radio modems should be isolated from excessive vibration, which can destroy electronic components, joints, and crystals. The cabinet should provide full protection from moisture, dust, corrosive atmospheres, and residue from ants and small vermin (which can be corrosive or conductive). The radio modem will radiate heat from the in-built heat sink, and the higher the transmitter duty cycle, the more heat will be radiated from the heat sink. Ensure there is sufficient ventilation in the form of passive or forced air circulation to help ensure that the radio is able to maintain quoted temperature limits.

The QR450 is designed with four mounting holes to allow a flat mount of the radio. Each QR450 comes standard with four 1.6mm x 40mm self drilling screws. The heads of these screws are low profile wafer heads with a no. 2 Phillips recess.

### Physical Dimensions

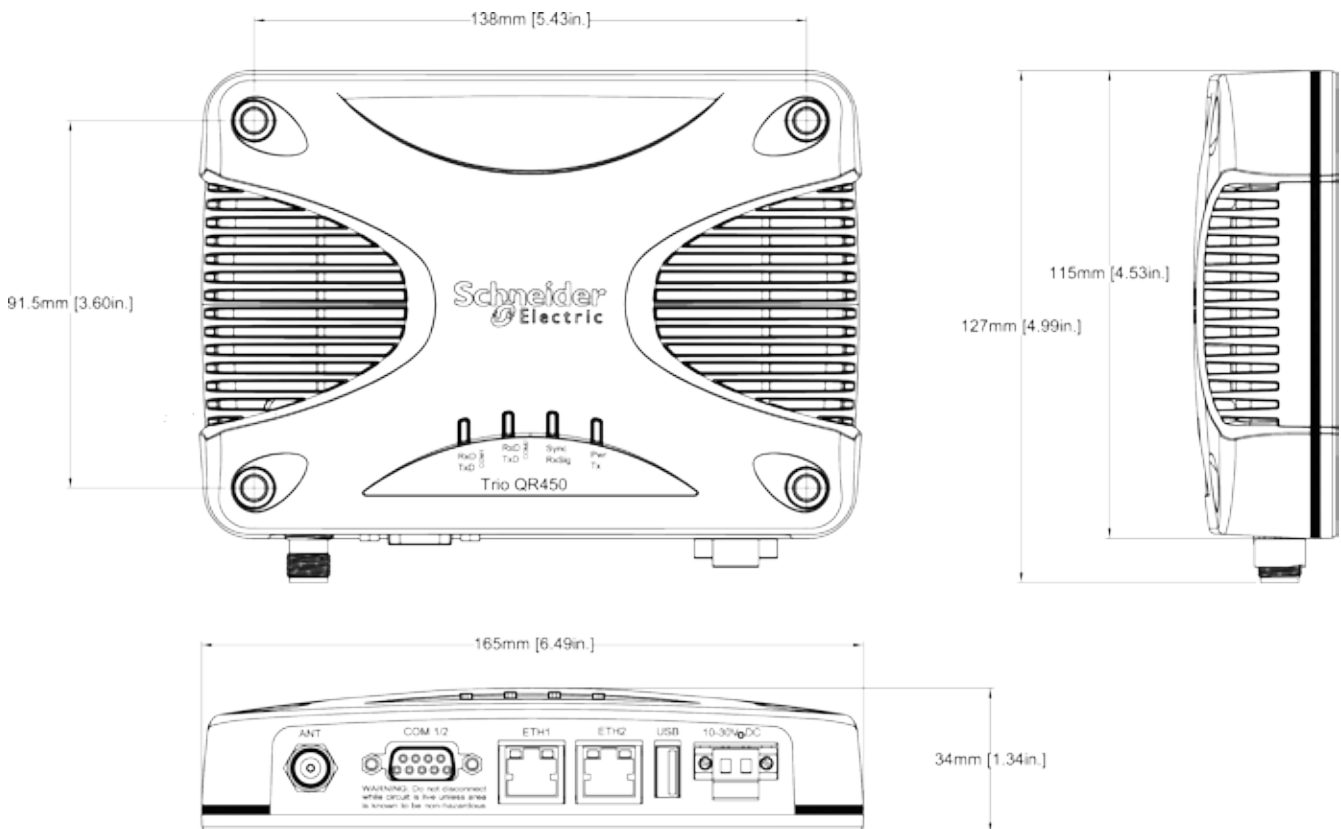

Drawings not to scale.

**DIN rail mounting kit**

An optional DIN rail mounting kit is available for the QR450. The Mount is screwed onto the bottom of the QR450 giving the unit the ability to be simply ‘clipped’ and Locked onto 7.5 mm by 35 mm (0.3 in. x 1.4 in.) DIN rail.

Each DIN rail kit supplies:

- A DIN rail mounting bracket
- A Phoenix DIN rail clip
- x4 Countersunk M4X8 screws (to mount DIN rail clip to bracket)
- x4 M4 nuts (to mount DIN rail clip to bracket)
- x4 Pan head M3X6 screws (to mount Spread spectrum radio to bracket)
- x4 Pan head M4X2.5 screws (to mount M-Series to bracket)
- x4 Pan head M4X8 screws (to mount QR450 to bracket)

**DIN rail mounting bracket**

Drawings not to scale.

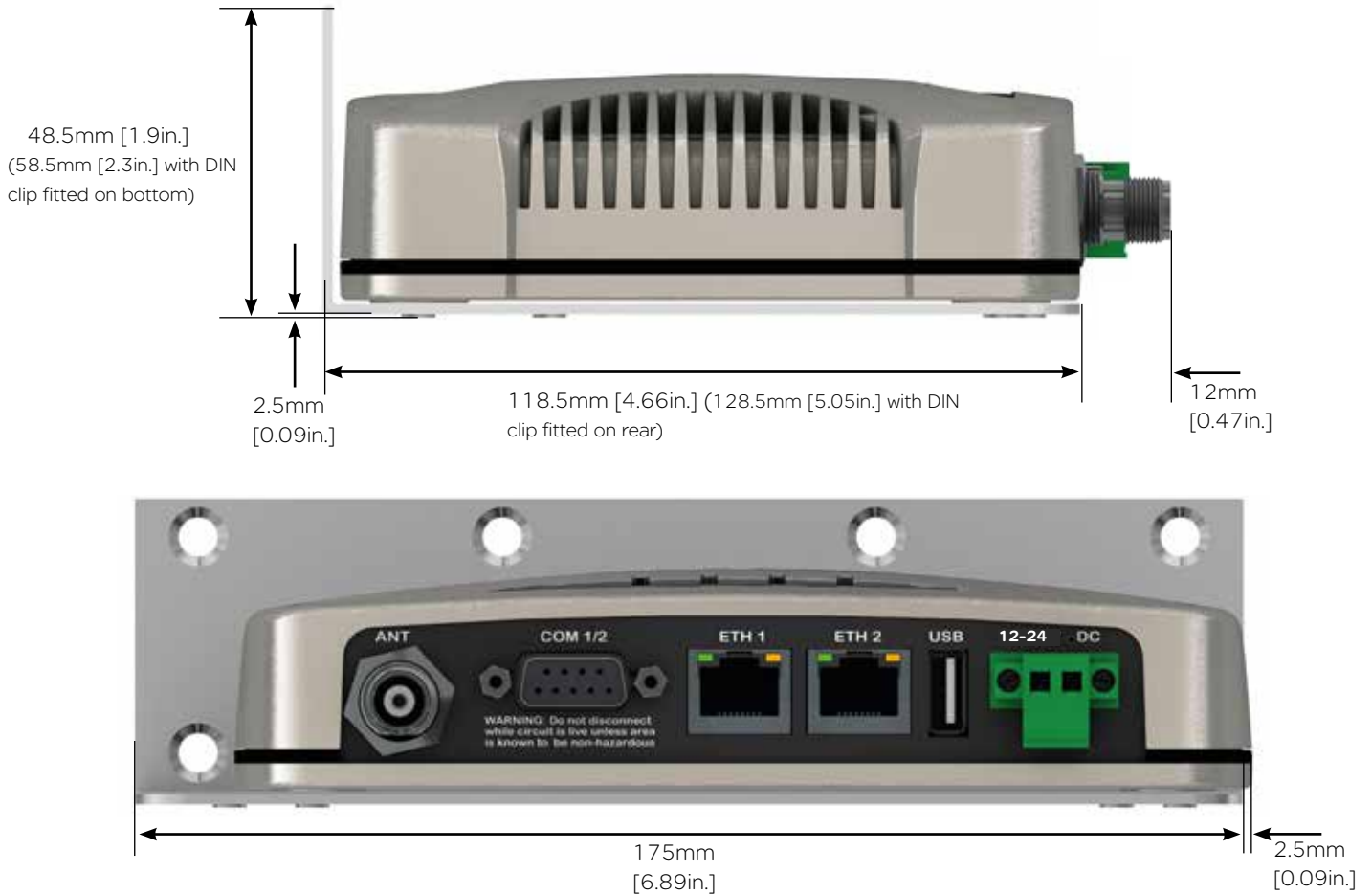



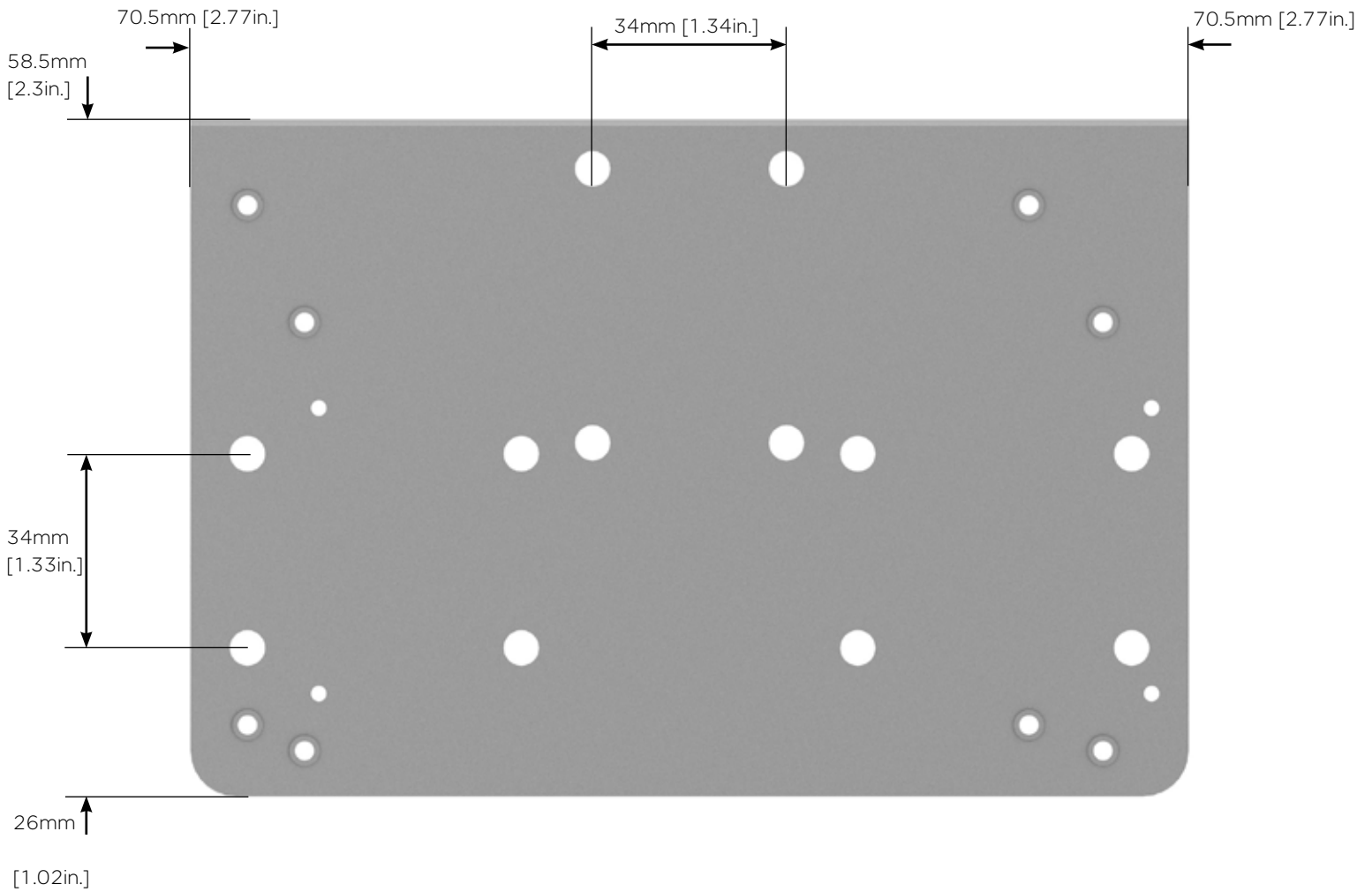
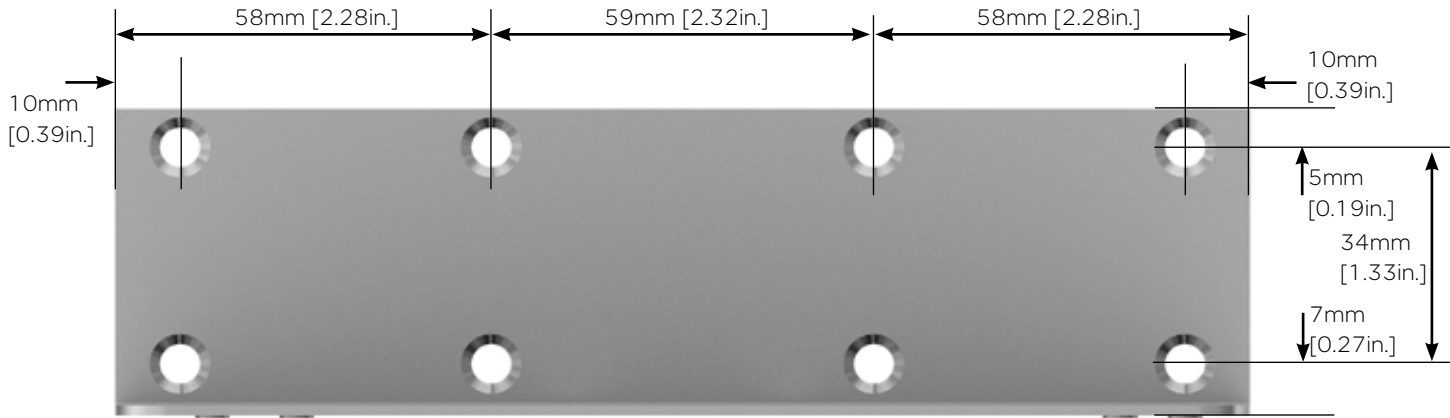

**DIN rail clip**

The DIN rail clip has a spring loaded latch to allow easy installation/removal of the radio device being installed.

The DIN rail clip can be fitted to the DIN rail mounting bracket x5 different ways to allow as much installation flexibility as possible.

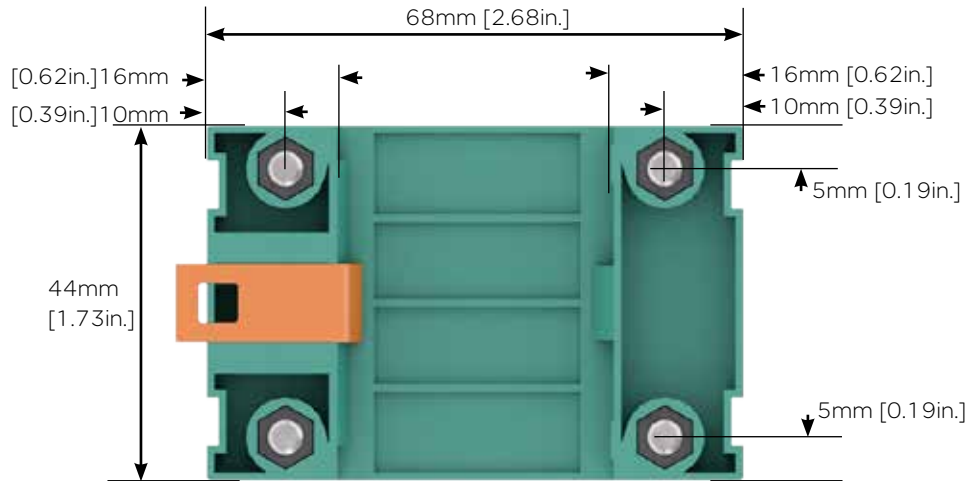

**Rear mount DIN rail clip**

The DIN rail clip can be fitted on the rear of the DIN rail mounting bracket two ways shown below.

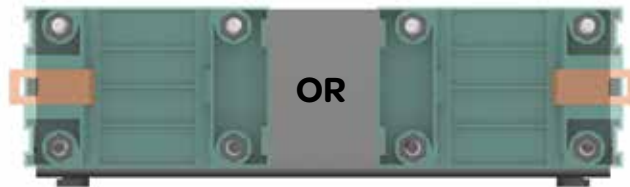

**Examples of rear fitted DIN clips:**



**Bottom mount DIN rail clip**

The DIN rail clip can be fitted on the bottom of the DIN rail mounting bracket three different ways shown below.

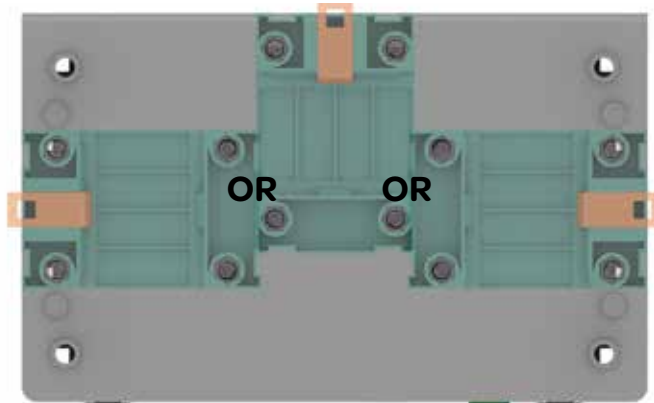

**Examples of bottom fitted DIN clips:**

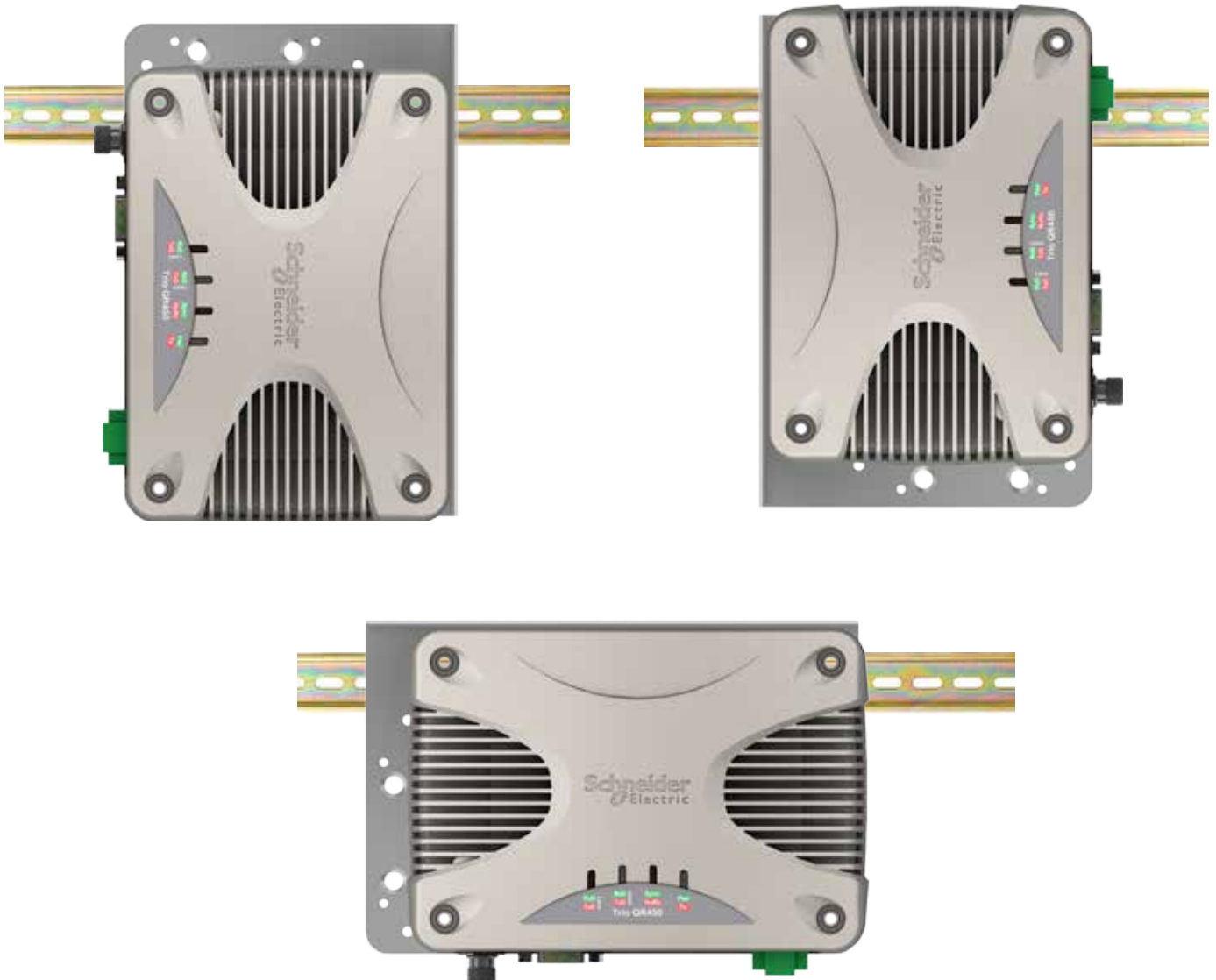

**Power Supply Requirements**

Rated Operating Voltage: 10 to 30V DC  
 Nominal Operating voltage: 12 and 24V DC  
 Input Power (Rx typical): 5 Watts  
 Input Power (Tx typical): (See table below)

Tx Power (dBm)	Typical Input Power (Watts)
30	22
37	37
40	51

Typical receive/standby input power is 5 Watts. The input power will vary in transmit mode according to RF output power level.

The QR450 is supplied with a lock-in mating DC power connector which should be installed with the locking screws done up tightly (0.5 - 0.6 Nm / 4.42 - 5.31 ftin ).

The radio is designed to limit damage if the voltage exceeds 30V DC or if reverse polarity is applied. The field replaceable internal fuse has a 7 Amp rating. Fuse replacement instructions can be found within this user manual.

NOTICE

**HAZARD OF EQUIPMENT DAMAGE**

The radio modem can be damaged if there is any potential difference between the chassis-ground, RS232 signal ground, power (-) input, or antenna coaxial shield. Before connecting any wiring, ensure all components are earthed to a common ground point.

**Failure to follow these instructions can result in equipment damage.**

Connect and secure the antenna, Ethernet and serial connectors BEFORE applying power to the unit. Lastly, before inserting the power connector, re-check that the polarity and voltage is correct using a multimeter and check the power cable against the +/- label printed on the front panel of the radio.

**Physical Interfaces**

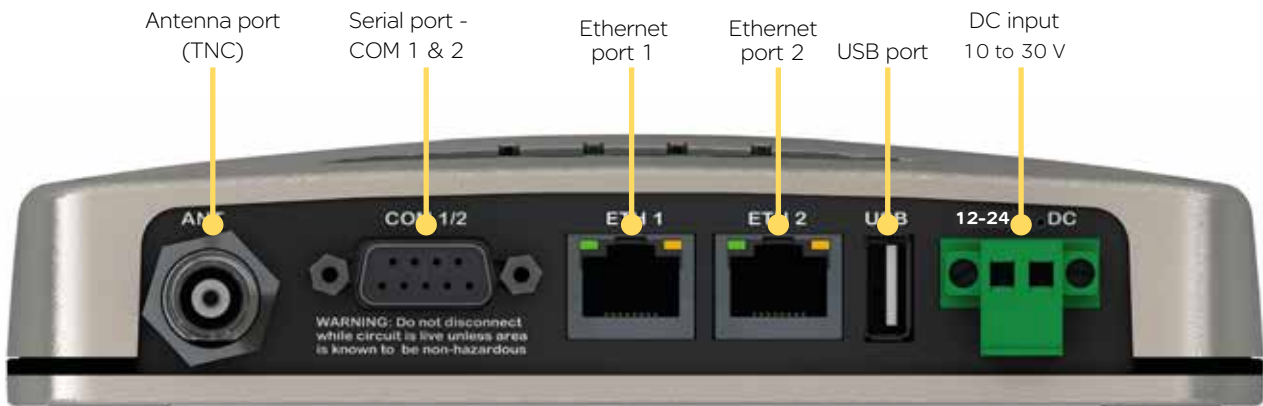

## Full Duplex Radio - QB450

### Typical Radio Setup

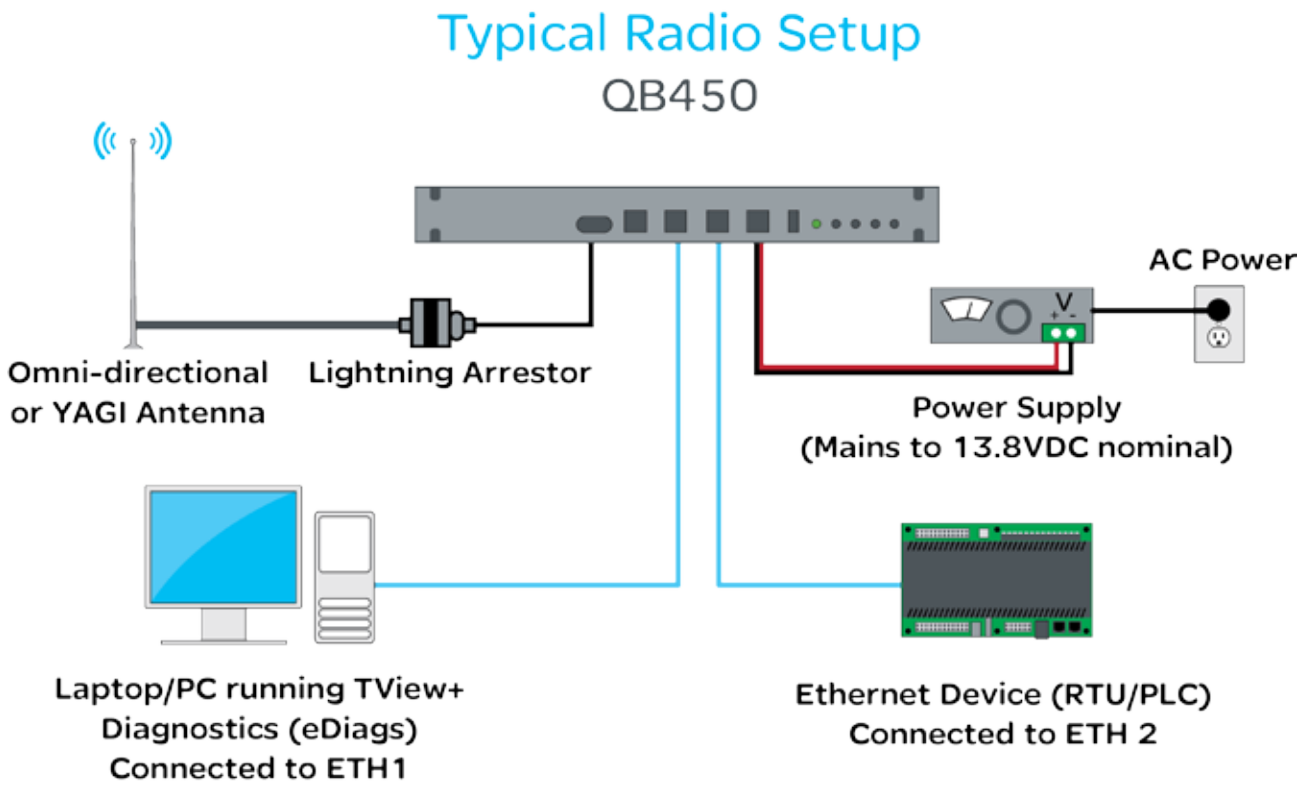

## Mounting

---

The QB450 Full Duplex Radio is housed in a 1RU 19" rack enclosure. The radio is supplied with x2 1RU mounting brackets, which should be fitted to each side of the radio before it can be installed into a 19" rack. The mounting brackets can be fitted to the side of the radio in 3 different locations to provide different mounting capabilities: Front Mount, Proud Mount or Center Mount.



### Front Mount

Fixing the mounting brackets for a front mount, allows the front of the radio to be flush with the front of a 19" rack.



### Proud Mount

Fixing the mounting brackets for a proud mount, allows the front of the radio to slightly hang over the front of a 19" rack.



### Center Mount

Fixing the mounting brackets for a center mount, allows the radio to be mounted into a 19" rack which contains a center pillar.

The radio should be mounted in a clean and dry location, protected from water, excessive dust, corrosive fumes, extremes of temperature and direct sunlight. Allow sufficient passive or active ventilation to allow the radio modem's heat sink to operate efficiently.

Antenna connections, Power connections and Digital I/O are all made at the rear of the unit.

All User ports, including; Serial Com ports, Ethernet ports, and Aux port are located on the front panel to provide easy access.

**Physical Dimensions**

19" (483mm) 1 RU rack mount.

Without mounting brackets, D:424 x H:44.45 x W:436.5mm (D:16.7" x H:1.75" x W:17.18")

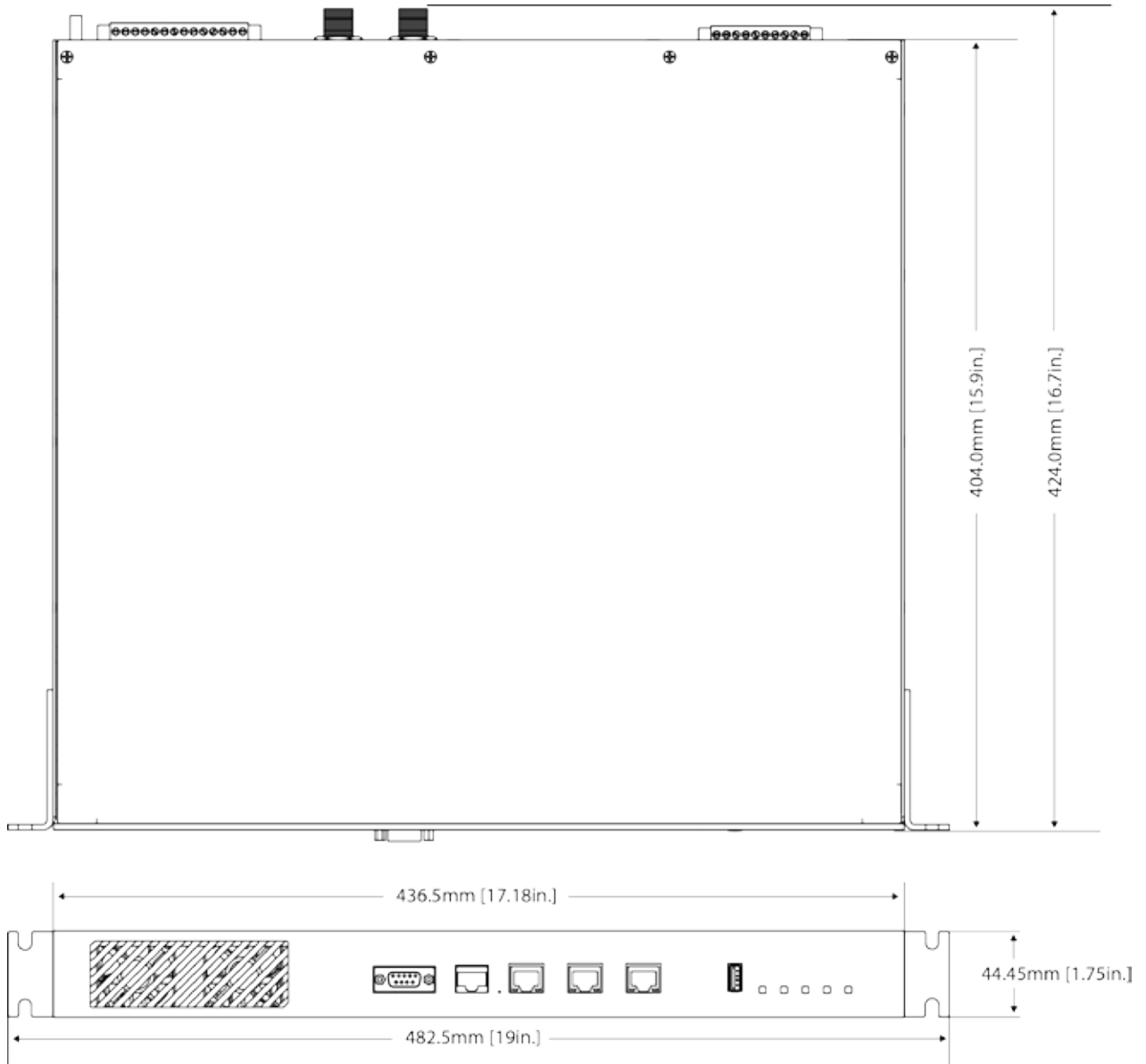

Drawings not to scale.

**Power Supply Requirements**

Operating Voltage: 11 to 30V DC (Dual Input)

Input Power (Rx typical): 35 Watts

Input Power (Tx typical): (See table below)

In high ambient temperature situations, the internal fans may operate, resulting in an increase of input power of up to 28 Watts.

Tx Power (dBm)	Typical Input Power (Watts)
30	55
37	71
40	85

Typical receive/standby input power is 35 Watts. The input power will vary in transmit mode according to RF output power level.

The QB450 is supplied with a lock-in mating DC power connector which should be installed with the locking screws done up tightly (0.5 - 0.6 Nm / 4.42 - 5.31 ftin ).

The radio is designed to limit damage if the voltage exceeds the operating voltage or if reverse polarity is applied. The field replaceable internal fuse has a 12 Amp rating.

<b>NOTICE</b>	
<b>HAZARD OF EQUIPMENT DAMAGE</b>	
The radio modem can be damaged if there is any potential difference between the chassis-ground, RS232 signal ground, power (-) input, or antenna coaxial shield. Before connecting any wiring, ensure all components are earthed to a common ground point.	
<b>Failure to follow these instructions can result in equipment damage.</b>	

Connect and secure the antenna, Ethernet and serial connectors BEFORE applying power to the unit. Lastly, before inserting the power connector, re-check that the polarity and voltage is correct using a multimeter and check the power cable against the +/- label printed on the rear panel of the radio.



Physical Interfaces

Front Panel

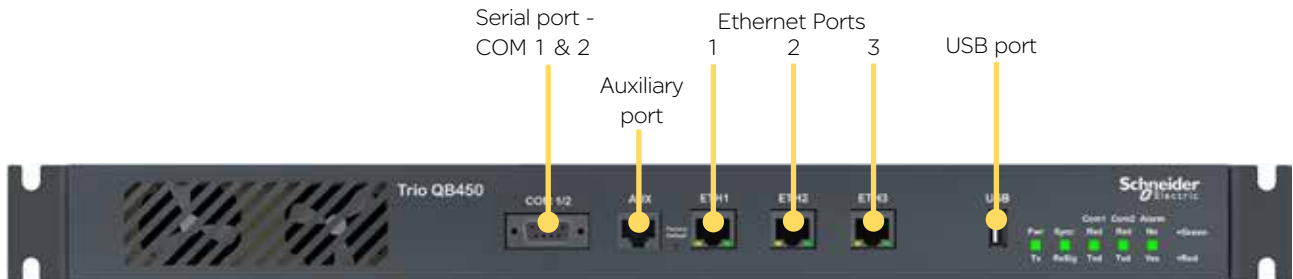

Rear Panel (11 to 30 VDC power supply option)

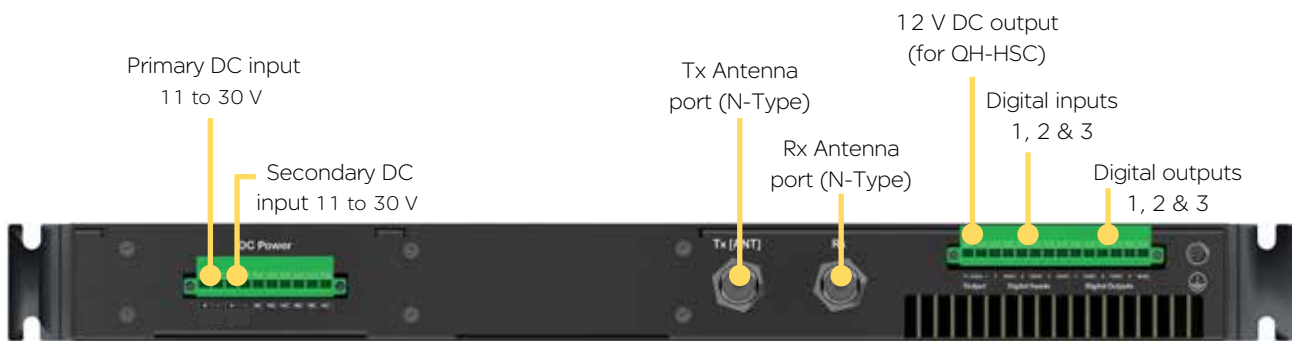

## Hot Standby Half Duplex Radio - QP450

### Typical Radio Setup

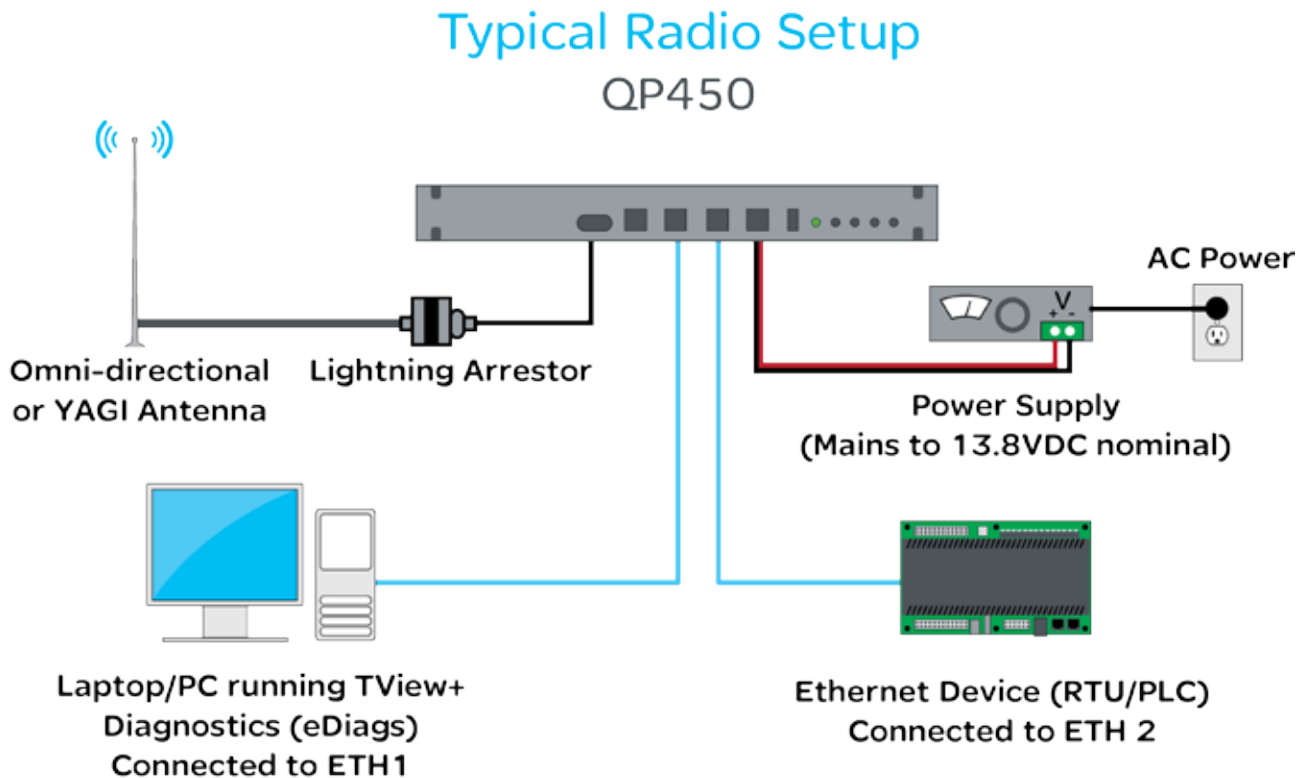

### Operational Description

The QP hot standby half duplex radio, is a 1RU rack mounted module which operates with two internal highly reliable half duplex radios, which can be switched between to provide redundancy.

The two half duplex radios (Radio A & Radio B) operate simultaneously and depending on the QP antenna option, there are different antenna arrangements available:

- Option B: Duplicate Ports - This option provide a separate antenna port for each of the internal radios.
- Option E: Common Port - This option will connect the internal radio's antenna ports through an RF relay, providing a single antenna port on the QP.

Only data received by the "online" radio is directed to the user equipment. The online radio is also the only unit transmitting at any time. The QP can perform the following functions:

- Monitor the alarm output from both radio A and radio B and change over the online radio if required.
- Switch all user data through to the online radio.
- Switch the antenna via internal coaxial relay to the online radio transmitter (Requires QP Kit Option E).

Digital switching in the QP directs user data to and from the user ports on the front panel directly to the user ports of the online radio.

**Mounting Guidelines**

The QP450 hot standby half duplex radio is housed as a 1RU 19" rack mounted unit. There are mounting brackets included for the front panel, which can be used to secure the unit to the rack. The mounting brackets can be fitted to the side of each unit in 3 different locations to provide different mounting capabilities: Front Mount, Proud Mount or Center Mount. Refer to the QB450 Mounting guide for a graphical representation of the different mounting positions.

The unit should be mounted in a clean and dry location, protected from water, excessive dust, corrosive fumes, extremes of temperature and direct sunlight. Allow sufficient passive or active ventilation to allow the radio fans to pass air through the internal heat sink efficiently.

All RF, power and digital I/O connections are made at the rear of the unit. All User interfaces are located at the front of the unit, this includes: Ethernet interface, Serial COM port interfaces and Auxiliary interface.

**Physical Dimensions**

19" (483mm) 1 RU rack mount.

Without mounting brackets, D:424 x H:44.45 x W:436.5mm (D:16.7" x H:1.75" x W:17.18")

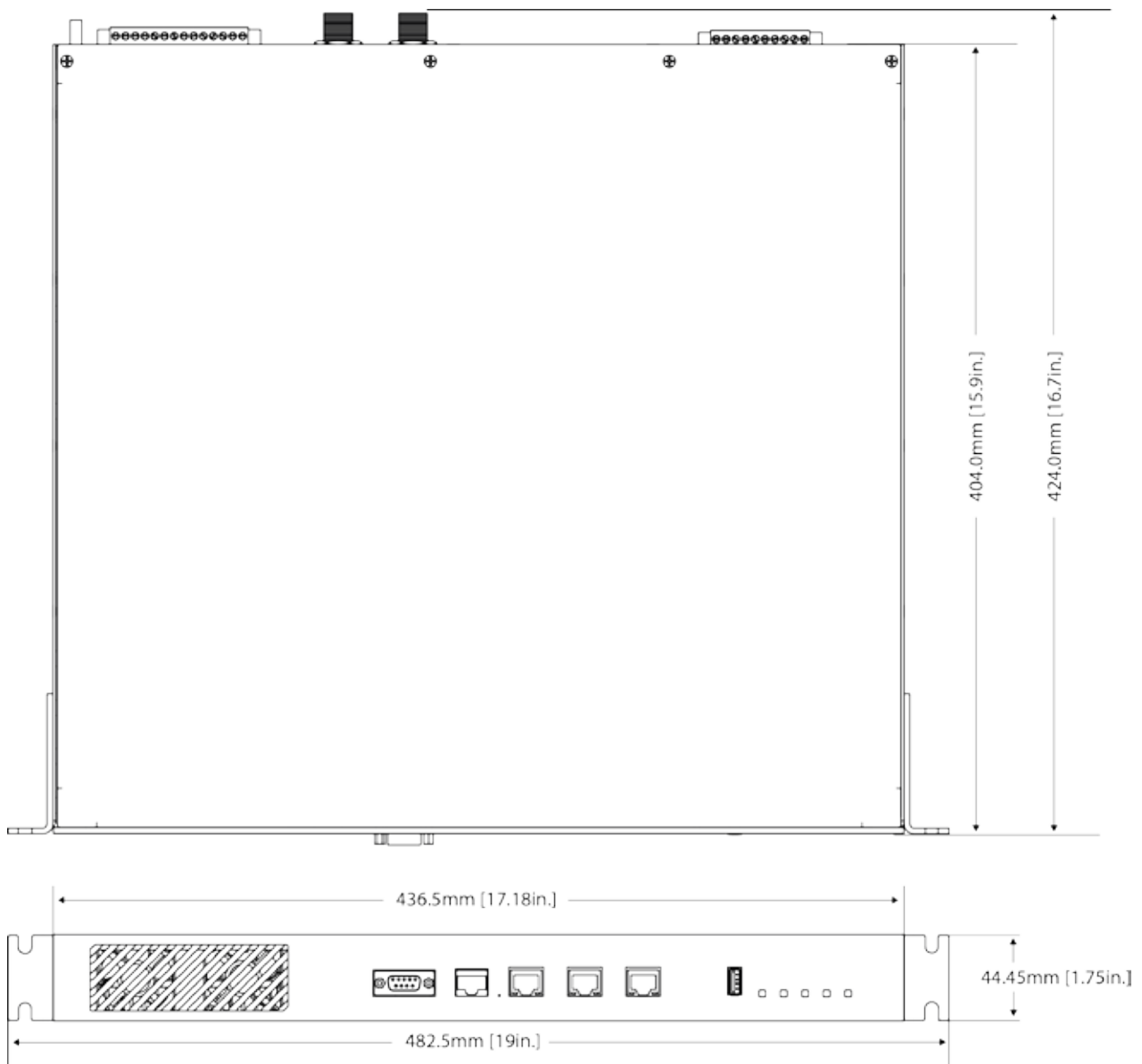

**Power Supply Requirements**

Operating Voltage: 11 to 30V DC (Dual Input)

Input Power (Rx typical): 35 Watts

Input Power (Tx typical): (See table below)

In high ambient temperature situations, the internal fans may operate, resulting in an increase of input power of up to 28 Watts.

Tx Power (dBm)	Typical Input Power (Watts)
30	55
37	71
40	85

Typical receive/standby input power is 35 Watts. The input power will vary in transmit mode according to RF output power level.

The QP450 is supplied with a lock-in mating DC power connector which should be installed with the locking screws done up tightly (0.5 - 0.6 Nm / 4.42 - 5.31 ftin ).

The radio is designed to limit damage if the voltage exceeds the operating voltage or if reverse polarity is applied. The field replaceable internal fuse has a 12 Amp rating.

<b>NOTICE</b>	
<b>HAZARD OF EQUIPMENT DAMAGE</b>	
The radio modem can be damaged if there is any potential difference between the chassis-ground, RS232 signal ground, power (-) input, or antenna coaxial shield. Before connecting any wiring, ensure all components are earthed to a common ground point.	
<b>Failure to follow these instructions can result in equipment damage.</b>	

Connect and secure the Antenna, Ethernet and Serial connectors BEFORE applying power to the unit. Lastly, before inserting the power connector, re-check that the polarity and voltage is correct using a multimeter and check the power cable against the +/- label printed on the rear panel of the radio.

Physical Interfaces

Front Panel

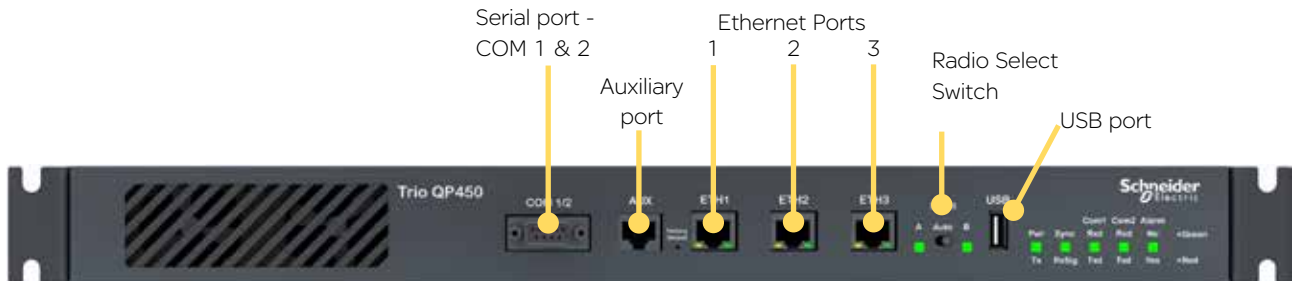

Radio Select Switch

The 3 position switch (A / Auto / B) on the front panel provides the following functionality:

- Position A: Radio A is forced online
- Position Auto: changeover hardware will select the online radio
- Position B: Radio B is forced online

Adjacent to the select switch are two LEDs: These LEDs indicate the current online radio.

Indicated State	Select LEDs
Auto Mode	
Local Force	
Remote Force	

Rear Panel (Hot Standby Option B)

Duplicated Antenna Ports

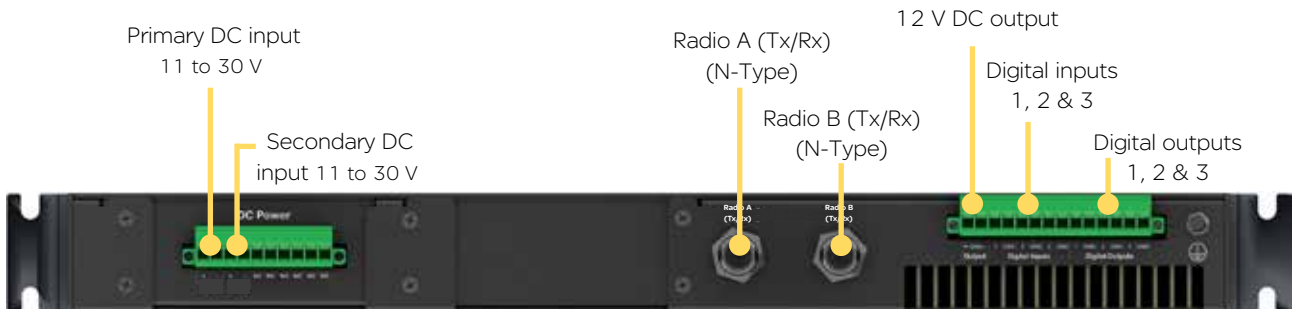

Rear Panel (Hot Standby Option E)

Common Switch Antenna Ports

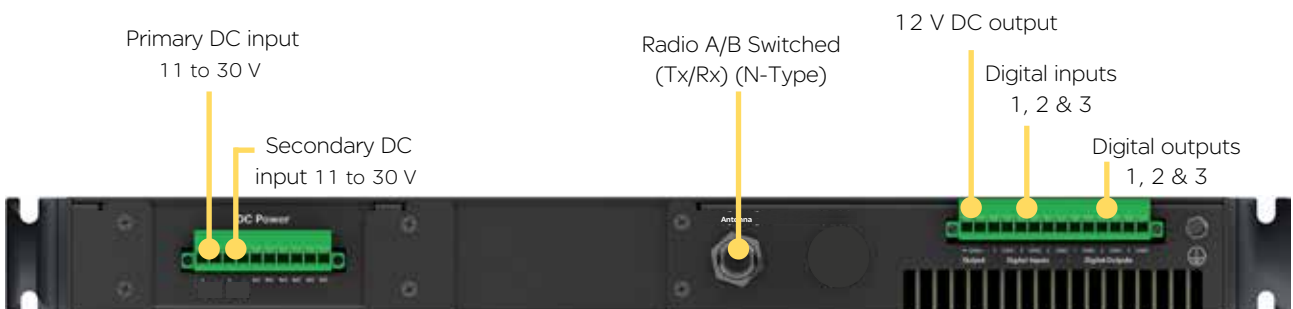

## Hot Standby Full Duplex Radio - QH450

---

### Introduction

---

Welcome to the Quick Start Guide for the QH450 Hot Standby full duplex radio. This section provides additional installation considerations, wiring diagrams and operational descriptions. This document should be read in conjunction with the QB450 full duplex radio Quick Start Guide.

The QH450 is a redundant, hot standby full duplex radio providing automatic changeover facilities.

The QH450 is designed as a modular solution, comprising 2 identical QB450 full duplex radios (standard) linked to a central monitoring and changeover controller (Hot Standby Controller). Either QB450 may be taken out for maintenance without the need for system down time. The automatic changeover can be triggered by the online out of tolerance (alarm) conditions based on either RF and/or user data throughput parameters.



## Typical Radio Setup

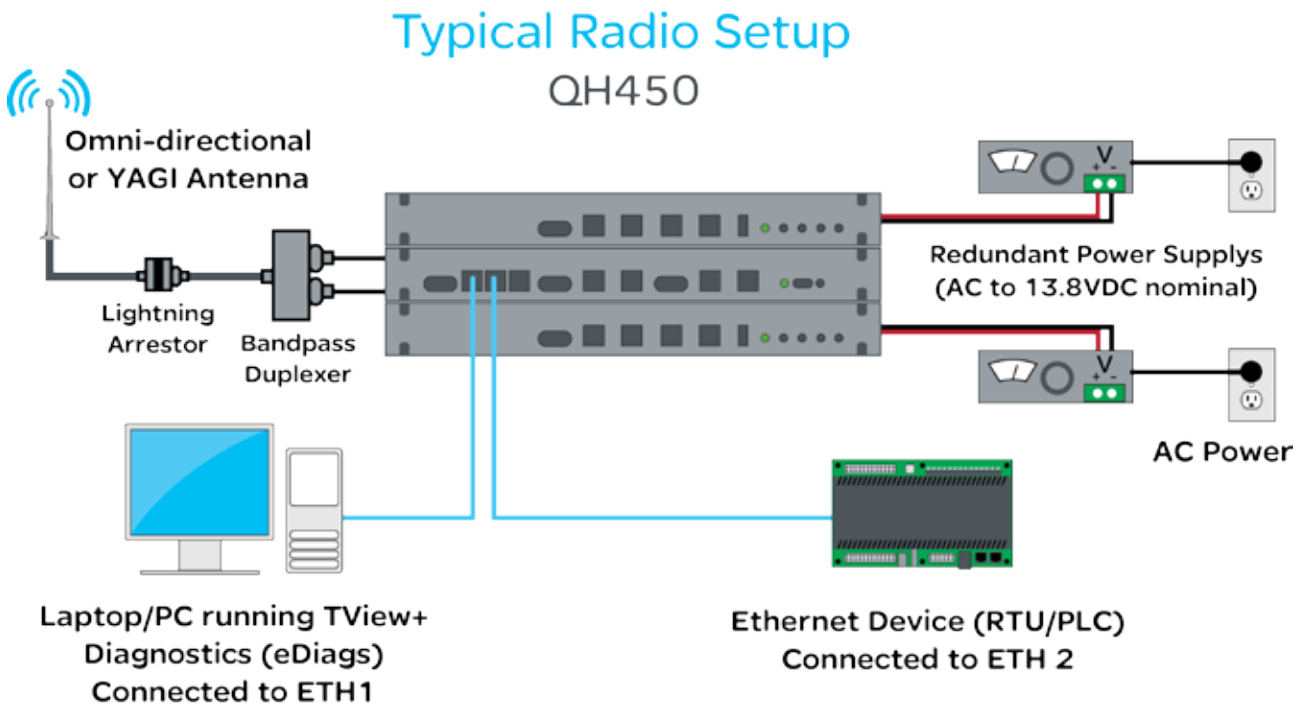

### Operational Description

The QH Hot Standby Controller (QHHSC) unit is a 1RU rack mounted module that interfaces to two separate full duplex radios (each 1RU rack mounted modules) via a number of RF and data cables.

Both full duplex radios (Radio A & Radio B) operate simultaneously and should both be constantly receiving radio signals, however only data from one radio (the "online" radio) is directed to the user equipment. The online radio is also the only unit transmitting at any time. The Hot Standby Controller has the following functions:

- Amplify and split the incoming signal two ways so both radio A and radio B receive at once.
- Monitor the alarm output from both radio A and radio B and change over the online radio if required.
- Switch all user data through to the online radio.
- Switch the antenna via internal coaxial relay to the online radio transmitter (Requires QHHSC Kit Option A).

Digital switching in the QHHSC directs user data to and from the user ports on the front panel directly to the user ports of the online radio.

The QHHSC and the two full duplex radios will pass operational/alarm detection status between one another via the AUX interface. Any alarm detection indicated from the online radio can cause the QHHSC to change over the online radio.

## Mounting

The QH450 hot standby full duplex radio is housed as a 3RU 19" rack mounted set, encompassing 2 x 1RU QB full duplex radios and 1 x 1RU QH Hot Standby Controller. The Controller and full duplex radios are each supplied with x2 1RU mounting brackets, which should be fitted to each sides of each unit before it can be installed into a 19" rack. The mounting brackets can be fitted to the side of each unit in 3 different locations to provide different mounting capabilities: Front Mount, Proud Mount or Center Mount. Refer to the QB450 Mounting guide for a graphical representation of the different mounting positions.

The unit should be mounted in a clean and dry location, protected from water, excessive dust, corrosive fumes, extremes of temperature and direct sunlight. Allow sufficient passive or active ventilation to allow the full duplex radio fans to pass air through the internal heat sink efficiently.

All RF, power and digital I/O connections are made at the rear of the unit. All User interfaces are located at the front of the unit, this includes: Ethernet interface, Serial COM port interfaces and Auxiliary interfaces.

## Physical Dimensions

Hot Standby is configured using 2 x QB450 + 1 x Hot Standby Controller (19" 1 RU each) for a total of 19"(483mm) 3 RU rack mount.

Without mounting brackets, D:424 x H:133.3 x W:436.5mm (D:16.7" x H:5.25" x W:17.18")

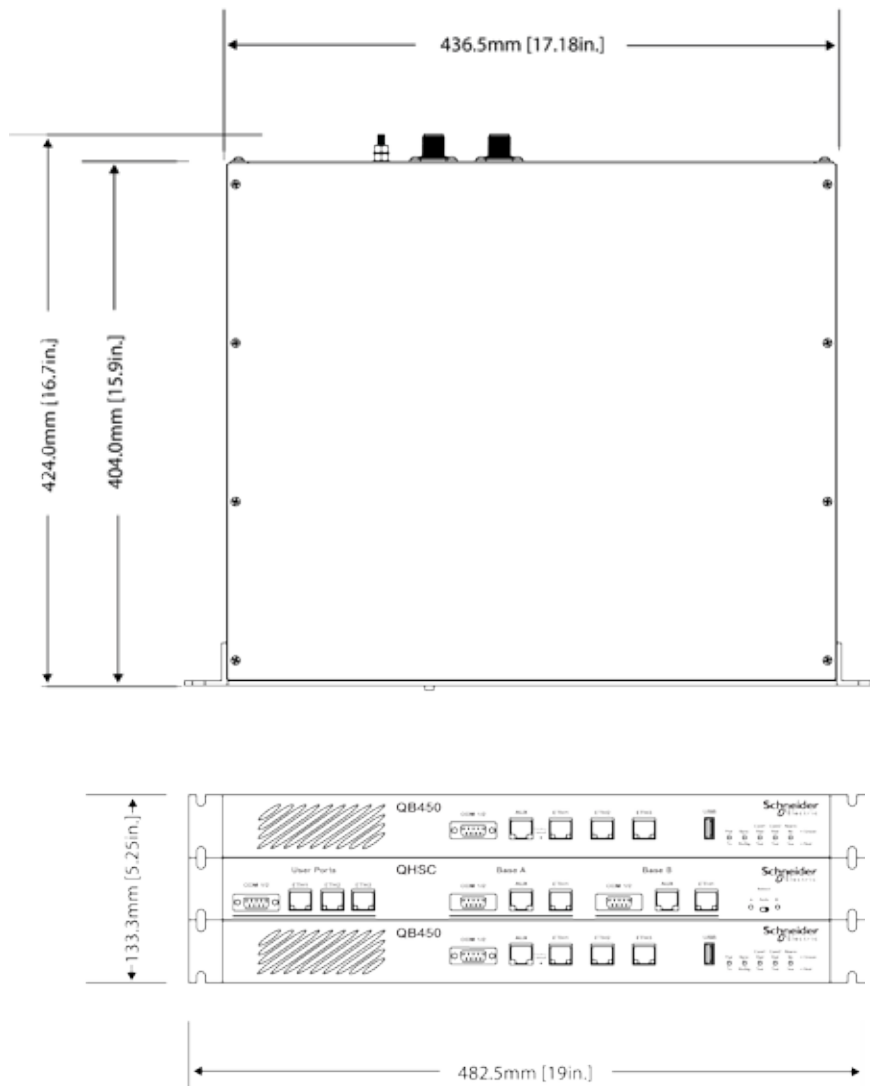



**Radio Configuration**

---

Before connecting the hot standby together, Radio A and B should first be configured for use in a hot standby arrangement.

To configure a QB to operate within a hot standby arrangement, go to: Setup -> Basestation -> General and enable the HSC Mode.

**General**

---

HSC Mode	<div style="border: 1px solid black; padding: 2px;">             Disable ▾  <span style="background-color: #0070C0; color: white; padding: 2px;">Enable</span>              Disable           </div>
----------	--

Once HSC Mode is enabled, a range of hot standby configuration parameters will become available.

**Unique IP Address**

---

Each QB radio within a hot standby arrangement should have it’s own unique IP address. IP addresses should be configured before any cable connections are made between the QB radios or QHHSC, to avoid any IP conflicts.

To configure the IP address, go to: Setup -> Network -> Ethernet -> IP Address

**Shared IP Address**

---

The two QB radios within a hot standby arrangement can be configure to ‘share’ an IP address. This is a separate IP address from the radio’s unique IP address. The shared IP address can be used to access the current ‘online’ radio.

The shared IP address should be configured in each individual QB as the same IP address.

To configure the shared IP address, enable HSC mode, then go to: Setup -> Basestation -> General and enable Shared IP Mode.

**General**

---

HSC Mode	<div style="border: 1px solid black; padding: 2px;">             Enable ▾           </div>
Shared IP Mode	<input checked="" type="radio"/> Enabled <input type="radio"/> Disabled
Shared IP	<div style="border: 1px solid black; padding: 2px;">             192.168.2.20           </div>

### Radio Position Allocation

The QH is made up of three separate devices, a single QH hot standby controller and two separate QB full duplex radios. Within a hot standby arrangement, the two full duplex radios need to be allocated a QH position, Radio A or Radio B. The diagrams on the following pages use the radio position allocation shown below.



### Communication Ports

There are multiple connections which need to be established between front panel interfaces of the QH

- COM 1/2 (Both Radios to QHHSC)
- AUX (Both Radios to QHHSC)
- ETH 1 (Both Radios to QHHSC)
- ETH 3 (Between Radios A & B)

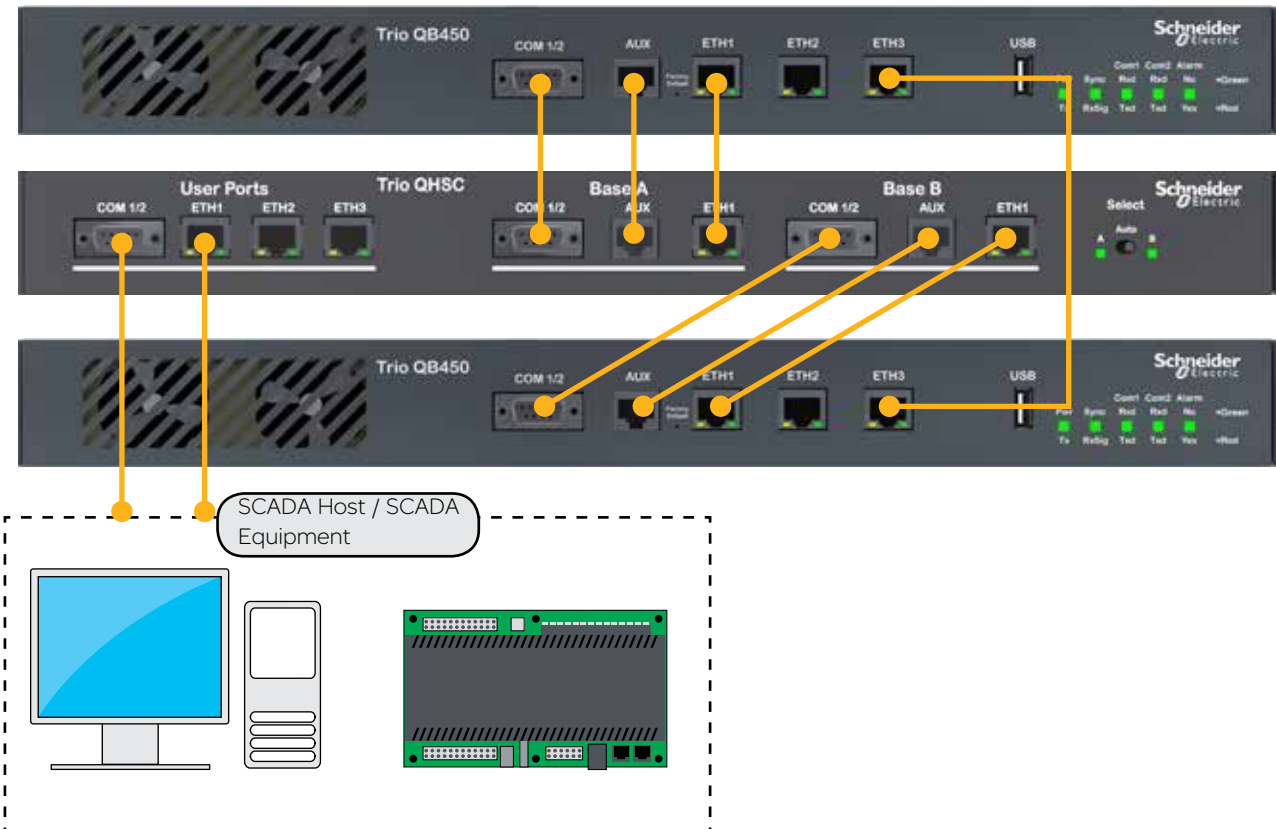

## Power Supply

The QH has facilities for dual power supplies to provide for a redundant system. A separate power supply should be used for each of the full duplex radios, then to help increase reliability, cross-over the power supplies to each of the secondary supply inputs of the full duplex radios shown in the diagram below.

Each full duplex radio has diode-ORed supply inputs, so a redundant power supply pair for each full duplex radio is also possible.

The Hot Standby Controller has connections for dual power supplies and should be powered from the 12V DC output of the full duplex radios as shown in the diagram below.

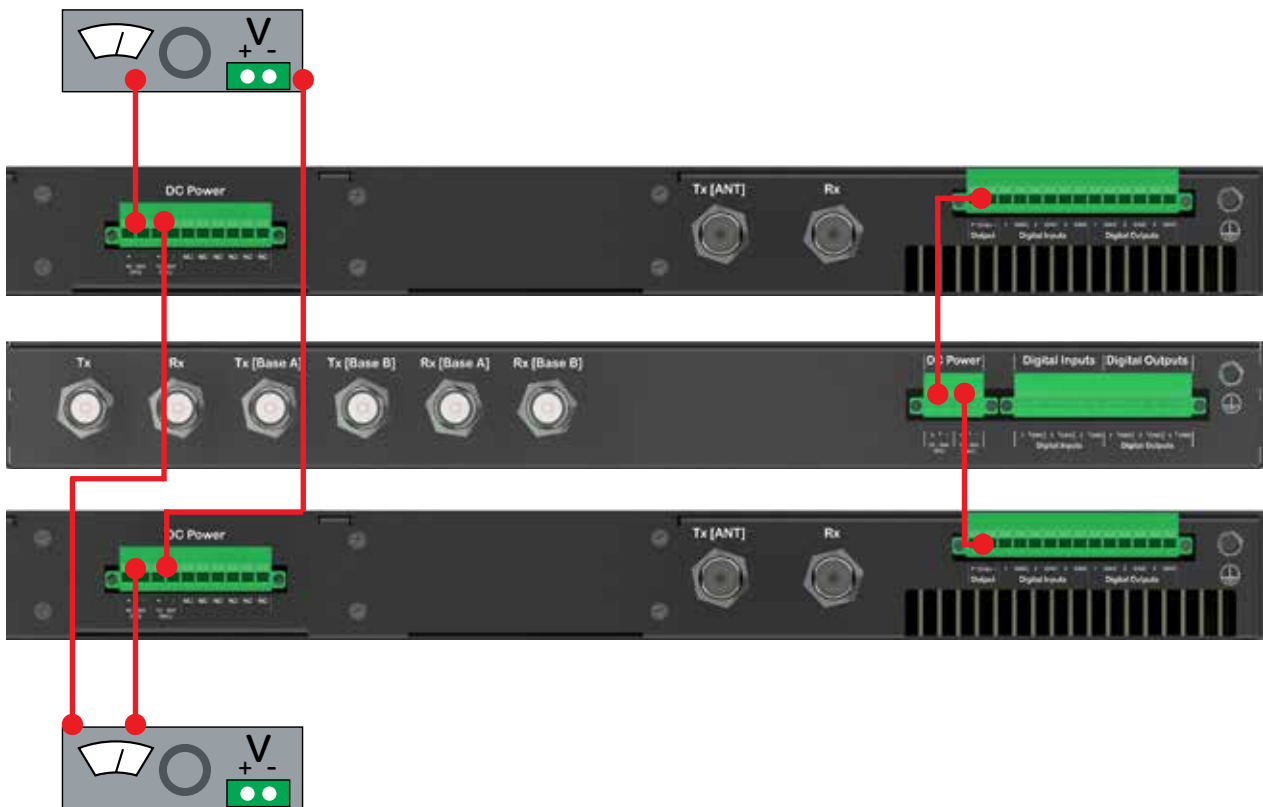

### Antennas and RF Feeders

There are 2 primary antenna connection options. All connectors used are standard N Type sockets. See diagrams below for further details.

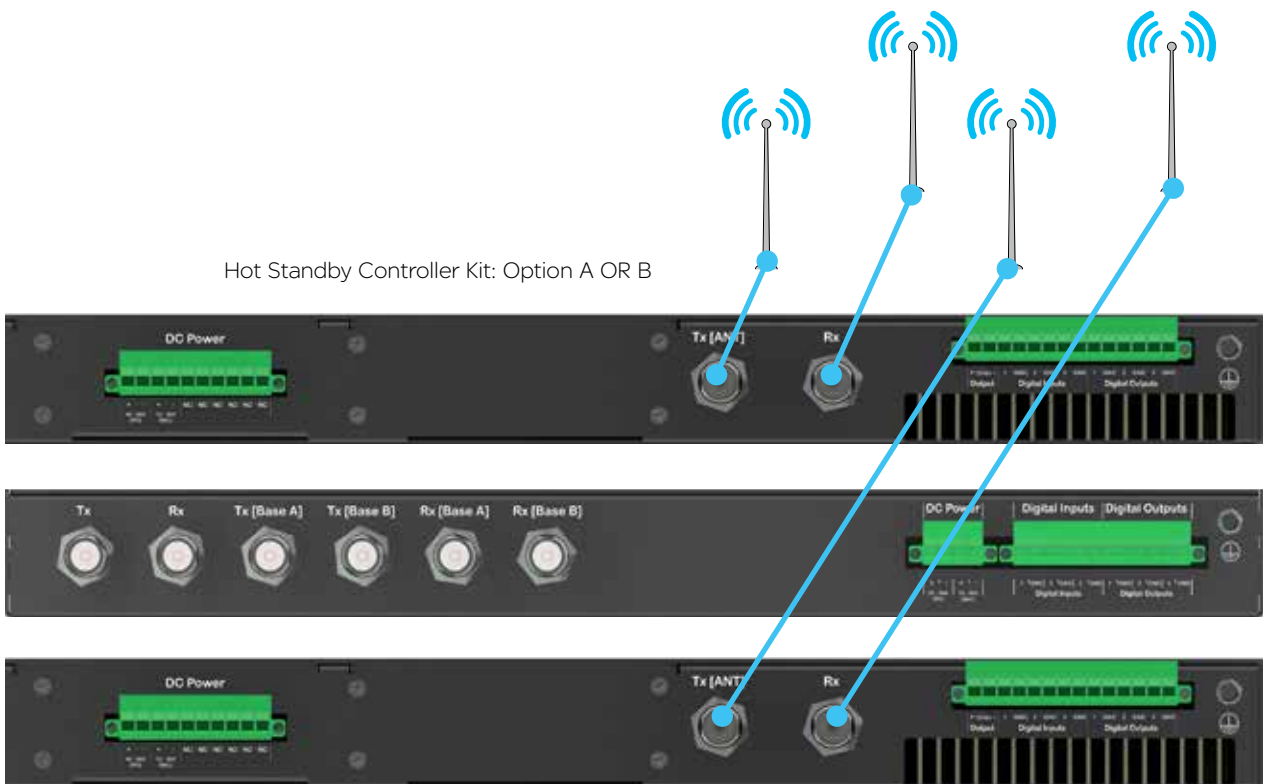
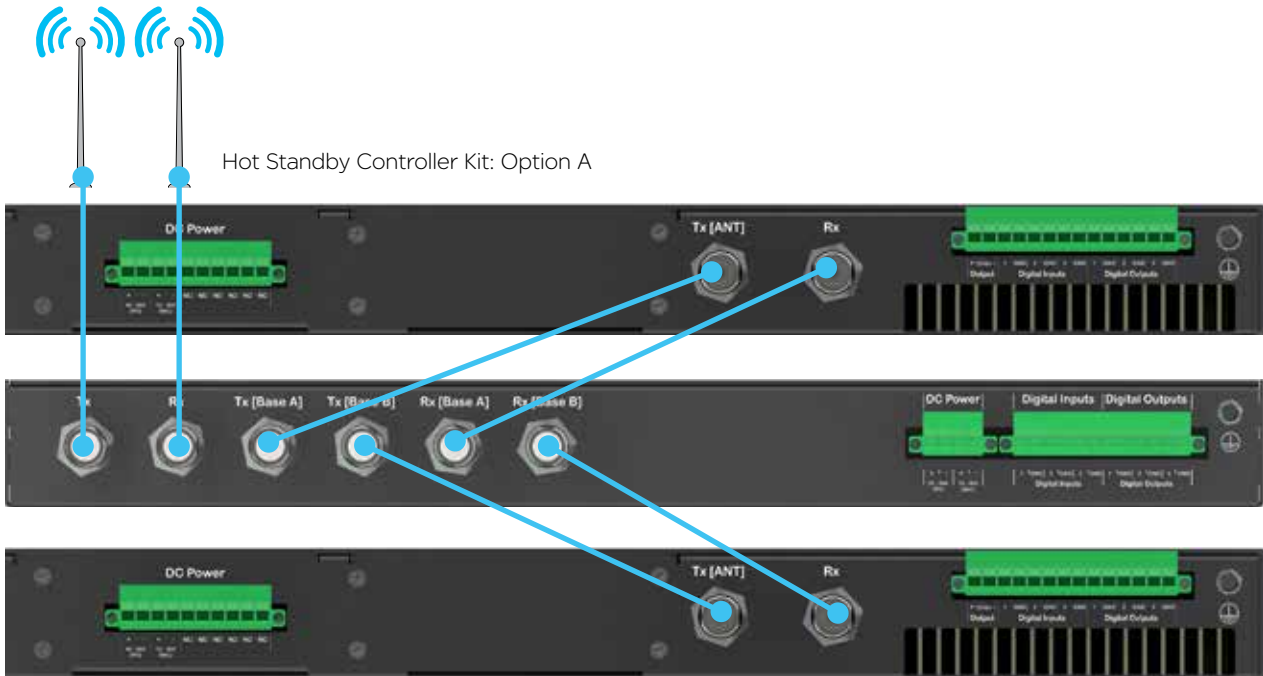

Physical Interfaces

Front Panel

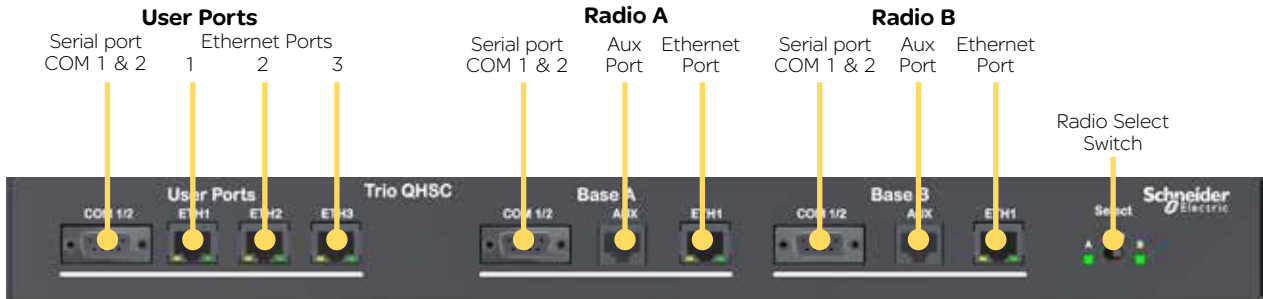

User Ports

Digital switching in the hot standby controller directs user data to and from the user ports on the front panel directly to the user ports on the online radio.

Ethernet Port LED Indicators

Indicated State	ETH port
Ethernet port inactive, no cable connected	
Ethernet port active @ 10Mbps	
Ethernet port active @ 100Mbps	

Select Switch

The 3 position switch (A / Auto / B) on the front panel provides the following functionality:

- Position A: Radio A is forced online
- Position Auto: changeover hardware will select the online radio
- Position B: Radio B is forced online

Adjacent to the select switch are two LEDs: These LEDs indicate the current online radio.

Indicated State	Select LEDs
Auto Mode	
Local Force	
Remote Force	

Rear Panel (Hot Standby Controller Option A)



Hot Standby Controller Option B

The QHSC Option B connections are identical to option A however, option B does not include any RF interfaces on the HSC.

## LED indicators

Each image below shows where to find the LED indicators of each Q data radio.



Top of QR450



Front of QR450



Front of QB450 & QP450



Front of QB450, QP450 & QHSC

### Pwr/TX - DC Power & TX LEDs

If all the LEDs are off, no DC power is reaching the radio modem or the internal fuse is open. Successful power-up is indicated by the Pwr/Tx LED showing a continuous GREEN state.

Tx Indicator (Tx) : When the transmitter is active the Pwr/Tx LED is in a RED state.

The QR450 will take approximately 60 seconds to boot up - during this time, the DC power LED will flash green/off periodically along with various LED activity. Wait until the DC power LED is not longer periodically flashing and is in a solid green state before attempting to communicate with the radio.

Indicated State	Pwr/Tx
No power, or ShutDown	
Power on	
Transmitter On	

### Sync/No RX - Synchronisation and No Received Signal LEDs

A flashing or solid green Sync/No RX LED indicates that the modem is receiving decodable transmissions from another source.

A regular/solid flashing red Sync/No RX LED indicates that the modem is receiving un-decodable transmissions from another source. This symptom can be caused by insufficient RX signal, too much interference or an incorrect configuration parameter set within the pair of modems.

Indicated State	Synch/RxSig
No received signal	
Receiver in SYNC state	
RSSI over mute level and no sync	

### TxD/RxD (COM 1 and COM 2) - Serial Tx/D/RxD LEDs

The Rx/D/TxD LEDs indicate data flow into/out of the serial user port. Data being sent to the port for transmission is indicated by a red flash, and data being received over the air and then forwarded to the serial port is shown as a green flash. As the serial port is full duplex, there may be instances where the Tx/D and Rx/D LEDs illuminate simultaneously, this will be indicated by an amber illumination of the port LED.

Indicated State	COM1/2
No Activity	
RxD Data Output	
TxD Data Input	
RxD & TxD Data Active	

### ETH 1 & ETH 2 - Ethernet Link and Activity LEDs

The Ethernet port LEDs are found on the physical RJ45 sockets, located on the front panel. Green LED activity typically represents a current physical connection to another Ethernet device has been established. Amber LED activity indicates Ethernet data is being transferred between the local Ethernet port and another Ethernet device.

Indicated State	ETH port
Ethernet port inactive, no cable connected	
Ethernet port active @ 10Mbps	
Ethernet port active @ 100Mbps	

**Alarm LED Indications**

In some circumstances the radio will indicate an alarm state. This is shown as all LEDs flashing RED for 1 sec and then a pattern of green LEDs for 1 sec. The pattern of green LEDs indicate the type of alarm. Consult the table for more information.

<b>QR450</b>				
<b>Error Type</b>	COM 1 RxD / TxD	COM 2 RxD / TxD	Sync / NoRx	Pwr / Tx
Supply voltage alarm				Green
Retry Factory default		Green		
Configuration alarm		Green		Green
Firmware upgrade alarm		Green	Green	
Reverted to factory default due to internal alarm		Green	Green	Green
IP address not set	Green			
Configuration record not found	Green	Green		
Over temperature alarm (Tx has been disabled)	Green	Green		Green
Over temperature alarm (Tx has been folded back)	Green	Green	Green	
VSWR alarm	Green	Green	Green	Green

<b>QB450/QP450</b>				
<b>Error Type</b>	Pwr / Tx	Sync / NoRx	COM 1 RxD / TxD	COM 2 RxD / TxD
Supply voltage alarm	Green			
Retry Factory default				Green
Configuration alarm	Green			Green
Firmware upgrade alarm		Green		Green
Reverted to factory default due to internal alarm	Green	Green		Green
IP address not set			Green	
Configuration record not found			Green	Green
Over temperature alarm (Tx has been disabled)	Green		Green	Green
Over temperature alarm (Txfolded back)		Green	Green	Green
VSWR alarm	Green	Green	Green	Green

**Operational Alarm**

An operational alarm is indicated by all 4 LEDs periodically flashing red (no green flashes). This alarm can indicate the radio has detected an error which may not be recoverable by the user. Depending on why the operational alarm has occurred, the event log can be referred to, which may help diagnose why operation alarm is active.

<b>QR450/QB450/QP450</b>				
Operation Alarm	Red	Red	Red	Red

## Connecting Antennas

The RF antenna system should be installed in accordance with the manufacturer’s instructions and local regulatory requirements.

- The RF (Antenna) connector on the QR450 is a TNC type female connector.
- The RF (Antenna) connectors on the QB450 and the QP450 are N-Type female connectors.

Good quality, low loss, feeder cable, should be considered according to the length of the cable run. also, use a short, flexible patch cable between the radio and lightning arrester or flange mount of the radio cabinet/enclosure. Ensure all external connections are waterproofed.

## Communication Ports

### Ethernet Ports (ETH)

The ETH ports are 10/100 Base-T compliant, using RJ-45 sockets. These sockets support both TIA/EIA-568-A & B wiring as they have Auto MDI/MDIX Auto Sensing. This means you can use both straight-through and cross-over type CAT-5 or better patch cables. All RJ45 connectors should utilise mating plugs that include an integral locking tab.



If termination of a cable is required, then the following wiring arrangement should be followed (Compliant with TIA/EIA-568-A).

Maximum differential voltage : 5v, 50mA max through each differential pair.

If 100-BaseT connection speed is required, CAT-6 Shielded cable should be used for installation to comply with ETSI EMC directives.

Pin	Pair	Wire	Color
1	3	tip	 white/green
2	3	ring	 green
3	2	tip	 white/orange
4	1	ring	 blue
5	1	tip	 white/blue
6	2	ring	 orange
7	4	tip	 white/brown
8	4	ring	 brown



**Serial Ports - COM 1/2**

The Q data radios feature a 9 pin miniature D-Shell (DE-9) Female connector that supports two individual serial port connections. Each serial port is associated with an embedded serial terminal server that provides the serial to TCP/IP or UDP/IP connectivity.

- COM 1 uses pins 2, 3, 7 & 8 with pin 5 as the common ground.
- COM 2 uses pins 4 & 6 with pin 5 as the common ground.
- An RSSI output is available on pin 9 which is useful for antenna alignment.

Pin out specs

- (1) Pin 2, 6 & 8 are outputs rated at +/- 6v, 65mA max.
- (2) Pin 3, 4 & 7 are inputs rated at +/- 15v, 5mA max.
- (3) Pin 9 is an analog voltage output to indicate the radio's live RSSI measurement.
- (4) Connecting wires should be #22 AWG (0.33mm<sup>2</sup>) or larger.

**QB450 & QP450**



**QR450**



Pin	RS-232 Mode		RS-485 Mode	
	Name	Input/Output	Name	Input/Output
1	COM 1 DCD	Output	Not Used	-
2	COM 1 RxD	Output	B/Z (Inverting)	Input/Output
3	COM 1 TxD	Input	A/Y (Non-Inverting)	Input/Output
4	COM 2 TxD	Input	Not Used	-
5	GND	-	Not Used	-
6	COM 2 RxD	Output	Not Used	-
7	COM 1 RTS	Input	Not Used	-
8	COM 1 CTS	Output	Not Used	-
9	RSSI	Output	RSSI	Output

## Activating Transmitter

Data sent to either of the radio’s communication ports (Ethernet or Serial Port) will cause the radio to key up it’s transmitter and send the data over the air. However, to test the transmitter with external test equipment (Tx power, VSWR or Frequency), or to test another radio’s receiver, the Q data radio provides a means to manually control the activation of the transmitter.

To access the transmit test tool, access the radio’s web user interface and browse to: Maintenance -> Transmit Test. This will display the transmit test tool page.

The transmitter can now be controlled via this page. To key up the transmitter, press the ‘Turn ON’ button. By default this will enable a Modulated Carrier for 60 seconds. During this time, the Tx LED should illuminate solid RED to indicate the transmitter is active.

## Transmit Test

Transmitter State	<input type="button" value="Turn on"/>
Transmit Carrier	<input type="text" value="Modulated"/>
Transmit Idle Time (s)	<input type="text" value="60"/>
Power Level (dBm)	<input type="text" value="30"/> <input type="button" value="+"/> <input type="button" value="-"/>
Frequency Trim (Hz)	<input type="text" value="0"/> <input type="button" value="+"/> <input type="button" value="-"/>
	<input type="button" value="Save and apply"/>

if the power or frequency is adjusted, and it is desired to retain this value, the Save and apply button should be pressed to activate the changes in the radio.

## Factory Default

The factory default IP address of the Q data radios is **192.168.2.15**. If you want to perform configuration changes on the Q data radio and are not aware of the configured IP address, you may need to activate a factory reset. Alternatively, COM 1 can provide access to the radio’s configuration via Text User Interface (as long as this port remains at the default configuration). default interface settings are: 19200, N, 8, 1, No Handshaking.

A factory reset will cause all previous configuration settings to be erased and returned to the factory default values. A factory default can be initiated by applying DC power to the radio (wait up to 3 minutes for the unit to fully boot up, indicated by a solid GREEN Power LED), depress the factory default switch using a paper clip or similar object and keep the switch depressed for 6 seconds or until all four LEDs illuminate solid GREEN and begin flashing, indicating the radio will return to the factory default settings. Wait for up to 4 minutes for the factory default reset process to complete.



## Digital I/O

Three channels of digital user inputs and outputs (Digital User I/O) can be read/written to via TView+ Diagnostics or SNMP. Digital user I/O is available on the following products:

- QB450 Full Duplex Radio
- QH450 Hot Standby Full Duplex Radio
- QP450 Hot Standby Half Duplex Radio

Information on how to control and monitor this I/O using TView+ Diagnostics can be found in Part G - TView+ Management Suite - Remote Diagnostics & Network Controller.

SNMP object descriptions for digital I/O can be found within the advanced section of this manual.

### Inputs

Three user Inputs are available. They have identical interface characteristics. Some form of switching contact (i.e: switch, relay) is normally used to change the state of the input. Both an isolated and non-isolated input configuration is possible.

Typical input drivers include: dry contact (relay), electronic control or driven control. Each input can support either type of driver.

Reading the status of a user input while the circuit is CLOSED will report the input as being ON.

Reading the status of a user input while the circuit is OPEN (or not connected) will report the input as being OFF.

### Typical Input Drivers

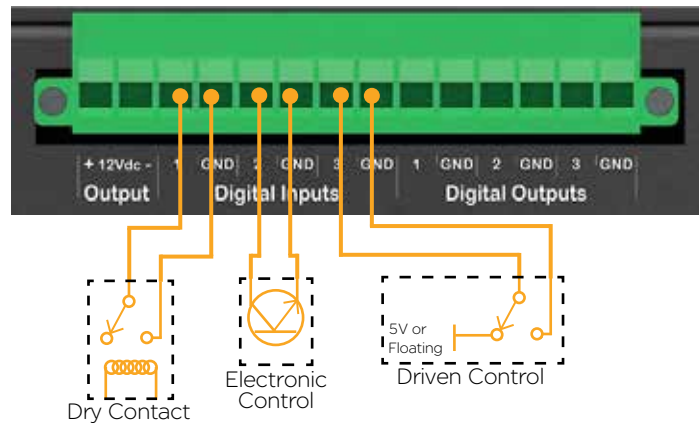

### Outputs

Three user outputs (open collector) are available. They have identical interface characteristics.

### Power Specifications

Maximum Voltage allowed across each output is 30V DC.

Maximum current allowed through each output is 1A. External resistors or a current limited supply should be used to keep the current below this value.

When the OUTPUT is OFF, The circuit will be OPEN. When the OUTPUT is ON, The circuit will be CLOSED.

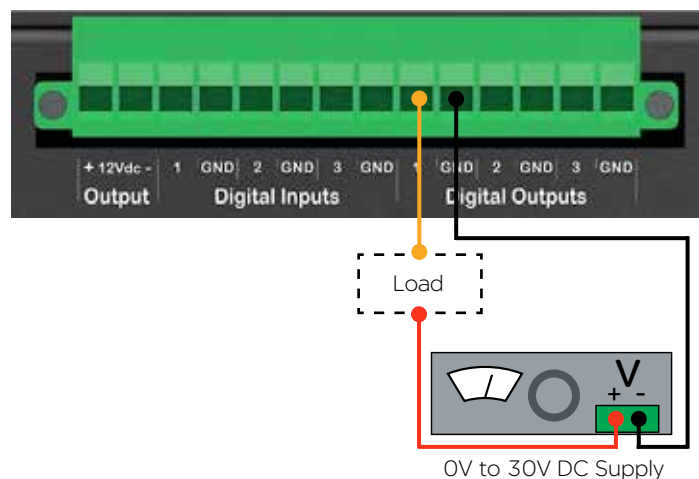

## Connecting to Web User Interface (WUI)

Q data radios provide an embedded web server which provides access to the Web User Interface (WUI). The WUI can be used to perform configuration changes on the radio. To change a configuration parameter in a Q data radio, connect a PC to one of the Ethernet ports (ETH 1 or ETH 2) and direct a browser to the IP address of the Q data radio. It is strongly recommended that you follow these guidelines for successful connection to the radio:

(1) Ensure the Q data radio is powered up and has fully booted. This is indicated by a solid GREEN power LED. It takes approximately 2 minutes from applying DC power for the Q data radio. Once the radio is fully booted, it may be indicating a user alarm. For example, if the radio's antenna port is incorrectly terminated, the radio will indicate a high VSWR alarm. Regardless of this user alarm, the radio can still be browsed to.

(2) Disconnect the PC from any other Internet/LAN networks, as this may create a conflict in IP addresses or the Q data radio IP might not fall within the subnet mask specified by the network.

(3) Connect the PC's Ethernet Port to one of the Ethernet Ports (ETH 1 or ETH 2) using an RJ-45 patch cable. Cross over cables will also work (Ethernet ports support MDI/MDIX). An active connection is indicated on the radio by solid green and amber illumination on the LEDs which are fixed to the physical Ethernet port you are connected to.

(4) Ensure the PC LAN Port is configured for a suitable IP address. If you are using Windows 7, this can be done by configuring the LAN settings via the Control Panel. Navigate to the Windows "Start" button and open Control Panel -> Network and Sharing Center -> Change adapter setting -> Double click on the LAN port you are using -> Properties -> Double click 'TCP/IPv4'. You should see the window shown.

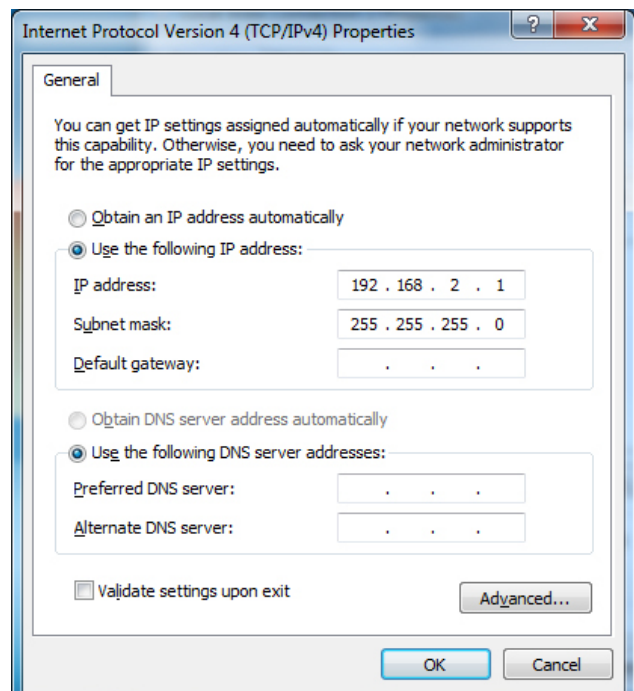

Ensure "Obtain IP Address Automatically" is NOT selected. It is recommended that you manually specify a compatible IP Address. In this example, a factory default radio is being configured. The IP address of that radio is 192.168.2.15 and a compatible IP address for the PC would be 192.168.2.1. Click OK to accept the changes.

Check with your Network Administrator before allocating IP addresses as each LAN/WAN network is different.

(5) Now open the web browser and insert the IP address of the Q data radio into the URL. In this case, we type "192.168.2.15", the browser should now display the home page of the radio. (Shown below).

You may need to disable a web proxy (if in use) or disable or modify the local firewall to help ensure the security.



## Resolving Ethernet Connection Issues

Here are some basic tips to help you along the way with Ethernet configuration issues. The Windows operating system (and others) comes complete with many useful tools. First, you need to open a command window. This can be done by clicking on “Start” then “Run” and entering “CMD” and clicking OK.

### Obtaining IP information about your PC

If you need to find out more information about your computer’s Ethernet IP configuration, network gateways and DNS servers, you can use a tool called “IPConfig”. Simply type “IPconfig /all” into the command window.

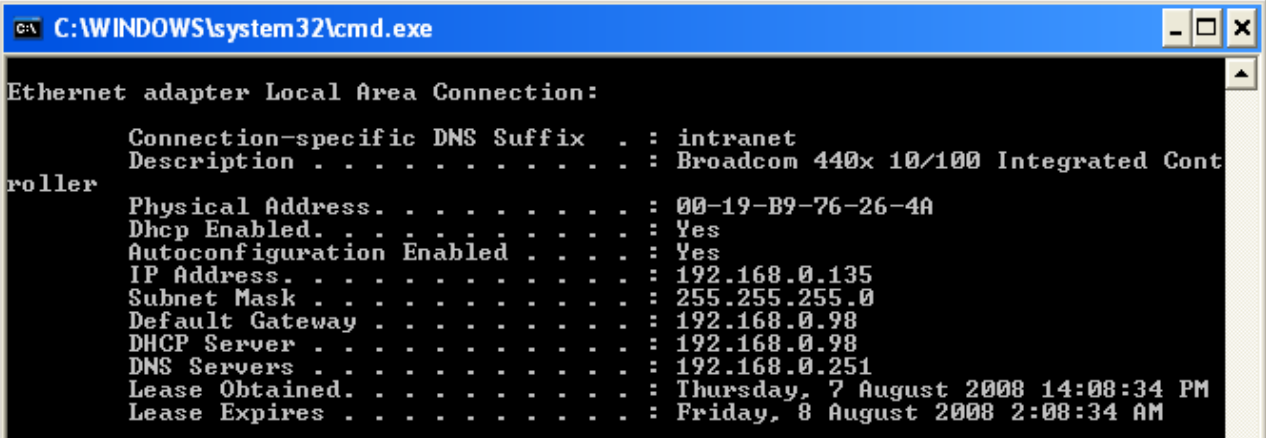

```

C:\WINDOWS\system32\cmd.exe

Ethernet adapter Local Area Connection:

    Connection-specific DNS Suffix . : intranet
    Description . . . . . : Broadcom 440x 10/100 Integrated Cont
roller
    Physical Address. . . . . : 00-19-B9-76-26-4A
    Dhcp Enabled. . . . . : Yes
    Autoconfiguration Enabled . . . . : Yes
    IP Address. . . . . : 192.168.0.135
    Subnet Mask . . . . . : 255.255.255.0
    Default Gateway . . . . . : 192.168.0.98
    DHCP Server . . . . . : 192.168.0.98
    DNS Servers . . . . . : 192.168.0.251
    Lease Obtained. . . . . : Thursday, 7 August 2008 14:08:34 PM
    Lease Expires . . . . . : Friday, 8 August 2008 2:08:34 AM
  
```

### Checking IP connectivity

A reliable way to check IP connectivity to a device is using the “Ping” utility. Type “ping xxx” where xxx is the complete IP address of the destination device you want to check. Ping will either respond with latency results (as shown) or say “timed out” if no connection was possible.

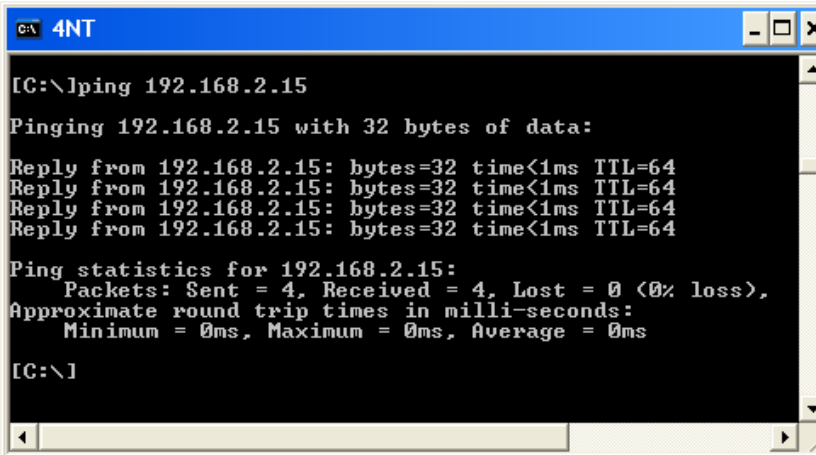

```

C:\ 4NT

[C:\>ping 192.168.2.15

Pinging 192.168.2.15 with 32 bytes of data:

Reply from 192.168.2.15: bytes=32 time<1ms TTL=64
Reply from 192.168.2.15: bytes=32 time<1ms TTL=64
Reply from 192.168.2.15: bytes=32 time<1ms TTL=64
Reply from 192.168.2.15: bytes=32 time<1ms TTL=64

Ping statistics for 192.168.2.15:
    Packets: Sent = 4, Received = 4, Lost = 0 (0% loss),
    Approximate round trip times in milli-seconds:
        Minimum = 0ms, Maximum = 0ms, Average = 0ms

[C:\>]
  
```

### Repeated connections to multiple devices with same IP address

A common issue experienced when attempting to configure multiple radios with the same IP address (such as factory default radios). The issue is due to invalid MAC table entries. If you change the Ethernet connection between two devices with the same IP address quickly, you may need to reset the MAC look up table in the PC. You can do this by typing “arp -d” in the command window.

# Part G– Quick Start Guide

## Step-by-Step Point to Point Setup

### Introduction

This document describes the 10 key steps required for:

- Connecting and configuring a pair of Q data radios.
- Performing basic diagnostics and health checks
- Connecting user equipment such as Host Software and/or RTUs

### Typical Bench setup

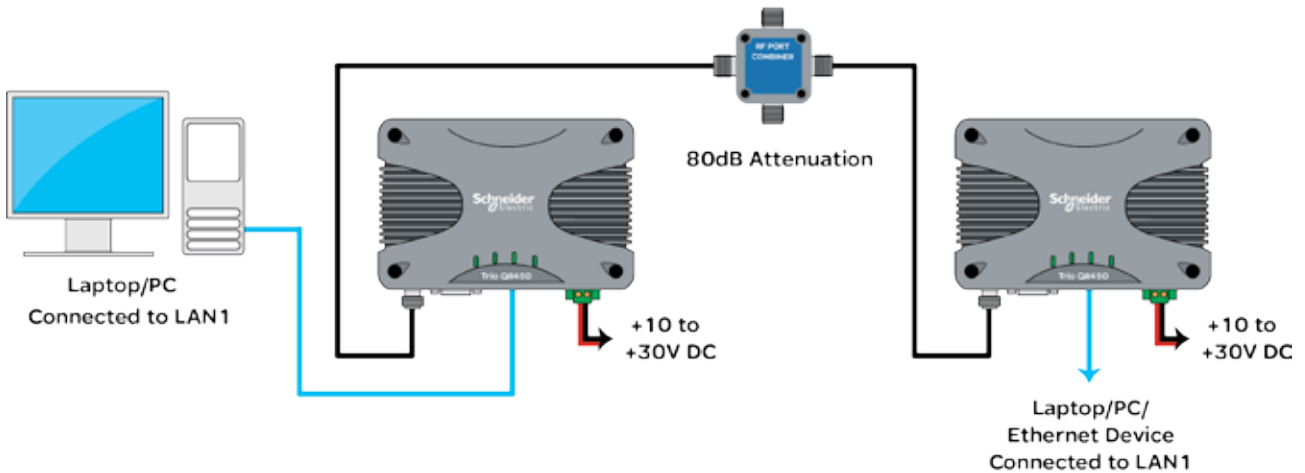

### Step 1 - RF and DC power connection

#### RF Connection

Bench testing is typically performed over short distances, so RF signals need to be significantly attenuated. Using dummy loads or whip antennas is not recommended.

A suitable method for attenuation of RF signals is to use a 4 Port RF Attenuator (Part Number TBUR4PORTATTEN). An attenuator accurately reduces RF signal level, simulating a real world, long distance RF link. Other types of RF attenuators can be used providing the total attenuation is between 80dB to 100dB. Check the attenuator power ratings against the configured Tx power of the radio.

If the TX power of each radio is set to 20dBm (100mW) then, low power, low cost attenuators can be used.

#### DC Power Connection

Ensure each radio is wired using the correct polarity and that power supply is regulated and has adequate current delivering capacity. See the Quick reference guide section of this manual to confirm the power supply requirements you require for the product you are using.

### Step 2 - Power Up Radios

Apply DC power to the radios. The radio will begin a boot up process. This process can take up to 2 minutes (during this time frame, the 'Pwr' LED will periodically flash GREEN, indicating that the boot up process is still in progress).

Once the boot up process has completed, the 'Pwr' LED should be solid GREEN. If there is no LED indication, re-check the DC polarity and ensure the DC voltage is between operating voltages.

If these checks are correct they you may need to inspect the internal fuse. Consult the maintenance section of this manual for further information on fuse replacement.

### Step 3 - Setup for Radio Configuration

#### IP Address and Factory Default

The factory default IP address of the Q data radios is **192.168.2.15**. If you want to perform configuration changes on the Q data radio and are not aware of the configured IP address, you may need to activate a factory reset. Alternatively, COM 1 can provide access to the radio's configuration via Text User Interface (as long as this port remains at the default configuration). default interface settings are: 19200, N, 8, 1, No Handshaking.

A factory reset will cause all previous configuration settings to be erased and returned to the factory default values. A factory default can be initiated by applying DC power to the radio (wait up to 3 minutes for the unit to fully boot up, indicated by a solid GREEN Power LED), depress the factory default switch using a paper clip or similar object and keep the switch depressed for 6 seconds or until all four LEDs illuminate solid GREEN and begin flashing, indicating the radio will return to the factory default settings. Wait for up to 4 minutes for the factory default reset process to complete.

#### Connection to Embedded Web User Interface (WUI) - HTTP

Connect the PC Ethernet Port to one of the Ethernet Ports (ETH1 or ETH2). To verify you can communicate with the QR450 you should first ping the radio.

Open up a command window on the PC by going to the "Start" -> Run and typing "CMD" then OK. Then type "ping 192.168.2.15" which is the default address of the radio. The radio should respond to the ping as shown below. If this is not the case, refer to the 'Resolving Ethernet Connection Issues' section in Part F of this manual.

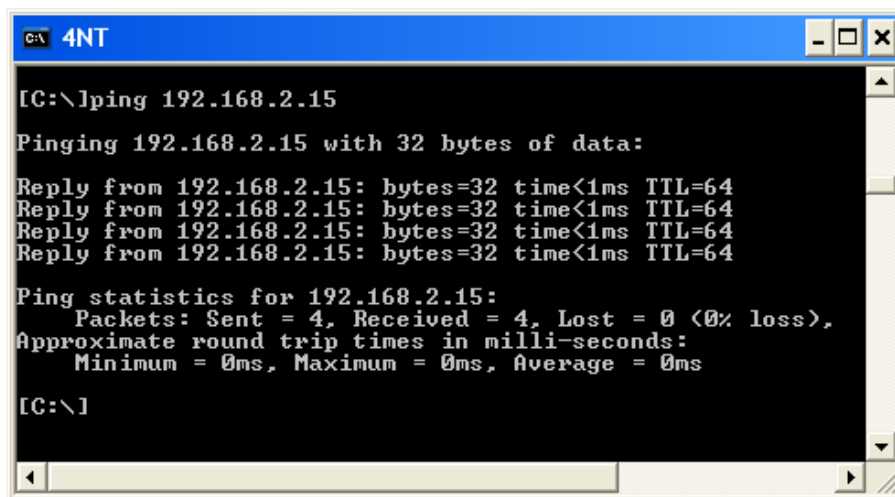

```

C:\>ping 192.168.2.15

Pinging 192.168.2.15 with 32 bytes of data:

Reply from 192.168.2.15: bytes=32 time<1ms TTL=64
Reply from 192.168.2.15: bytes=32 time<1ms TTL=64
Reply from 192.168.2.15: bytes=32 time<1ms TTL=64
Reply from 192.168.2.15: bytes=32 time<1ms TTL=64

Ping statistics for 192.168.2.15:
    Packets: Sent = 4, Received = 4, Lost = 0 (0% loss),
    Approximate round trip times in milli-seconds:
        Minimum = 0ms, Maximum = 0ms, Average = 0ms

C:\>

```

Q Data Radios can also be configured via a Text User Interface (TUI). Console protocols such as Telnet, SSH or a serial connection may be used. For further details on making configuration changes via the TUI, refer to the advanced configuration section of this manual.

### Step 4 - Start Web Browser on your PC

Start a web browser and insert the IP address of the radio into the URL. In this case, type "192.168.2.15" and the configuration page is now displayed in the browser.



Browse to the "Wizards" section of the WUI by clicking: -> Setup -> Wizards.



**Step 5 - Activate Entry Point - PTP Wizard**

Select Point to Point with Half Duplex Entry Point.

Select 'Entry Point radio' and click on the "Start The Wizard" button.

The Wizard now prompts the user to configure the minimum parameters to achieve point to point operation. For each configuration item, help text is provided on the HTML programmer interface. If you are manually specifying IP addresses, ensure you record them for future reference. You will need to know the IP address of each radio in future steps.

After configuration of all items are complete, activate the configuration by clicking on the "Activate Configuration" button in the top right corner.

**Shared IP Address (Optional Configuration - For Hot Standby units only)**

Radio A and Radio B (within the QP) can be configured to 'share' an IP address. This is a separate IP address from each radio's unique IP address. The shared IP address can be used to access the current 'online' radio.

The shared IP address should be configured in each individual internal radio as the same IP address.

To configure the shared IP address, go to: Setup -> Basestation -> General and enable Shared IP Mode.

Shared IP Mode  Enabled  Disabled

Shared IP

**Step 6 - Activate Remote - PTP Wizard**

Repeat steps (3) to (5) for the Remote radio. When in Step 5, select the 'Remote radio' button and click on the 'Start The Wizard' button.

**Step 7 - Verify Modem Operation**

The radio configuration & RF link can now be verified for correct operation. First, check that the remote radio can correctly decode a transmitted signal. This is done by energising the transmitter (modulated carrier) of the entry point radio. Refer to the instructions about this in the quick reference guide section of this manual.

With the transmitter energised, inspect the LED status on each radio. The entry point radio should have a solid RED 'Pwr/Tx' LED. The remote radio should a solid GREEN 'Sync/RxSig' LED. If this LED is not SOLID green it may indicate incorrect configuration or inadequate signal strength and the setup should be checked. Repeat this test with the Remote radio transmitting.

**Step 8 - Packet Transmission Test**

This tool provides a useful way to test a radio communications link by transmitting data packets between two units in a loop-backed mode.

You can find this tool in the "Diagnostics" tab, then click on the "Packet Transmission Test" sub-menu.

Enter the "Destination IP Address" field with the IP address of the of the target radio that you want to ping. Ensure the "Number of Packets" is set to 1000. Now click on the "Start Packet Test" button. The radio will indicate the packet test has started and is currently running and both units will have flashing Tx LEDs indicating data is being transmitted.

When the test is complete, a message stating "Packet transmission test completed" will be shown and the test results summarised in the "Test Results" section.

The test results show TX & RX Packets, Lost Packets and the Packet Error Rate.





## Step 9- Embedded Diagnostics Testing

### 8.1 Review Diagnostics

Connect the web browser to the Entry Point radio using the IP address recorded in Step 5. Once loaded, click on the Diagnostics tab, then select the summary sub-menu. This will display the Diagnostics summary page. Review the diagnostics parameters checking for abnormal items such as high VSWR (high TX reverse power) and lower than expected radio RSSI (Received Signal Strength).

Follow this step again for the Remote radio.

#### Summary

Unit	
Date	Mon Nov 24 18:14:28 1975
Up Time (sec)	2585.37
CPU Load (%)	7
Supply Voltage (V)	13.7
Radio Temperature (C)	40.3
Radio Temperature (F)	104.54

#### LAN

ETH 1 Rx Packets	317
ETH 1 Rx Bytes	38864
ETH 1 Tx Packets	101
ETH 1 Tx Bytes	27379
ETH 2 Rx Packets	0
ETH 2 Rx Bytes	0
ETH 2 Tx Packets	0
ETH 2 Tx Bytes	0

#### Radio

Radio Rx Packets	1
Radio Rx Bytes	21
Radio Tx Packets	195
Radio Tx Bytes	18794
Radio Forward Power (dBm)	30.0
Radio Reverse Power (dBm)	28.6
Radio VSWR	> 10.0:1
Radio RSSI (dBm)	-120.1
Radio Rx Frequency Offset (Hz)	0.3

## Step 10 - Commissioning Record

After a packet transmission test has been performed, a Commissioning Record can be prepared. This facility is activated by clicking on the "Commissioning Record" button.

It is recommended that the radio is configured to use the current date (either time configured manually or obtained from an NTP server) otherwise the date / time shown will not be correct.

The user can enter an appropriate Unit Name and Location for reference purposes. Additionally, a comment may be added noting the type of antenna in use. Once this information has been added, the web page can be printed (using the print facility in the web browser). It may be useful to print the commissioning record to PDF for future reference.

This now completes the requirements for setting up a half duplex, Point to Point Q Data Radio Link. The radios are now ready for application testing. The application can be connected to either ETH1 or ETH2 or both.

## Step-by-Step eDiags Setup

e-diagnostics (also known as eDiags) is a feature of the TView+ diagnostics software that encapsulates the TView+ diagnostics protocol in an Ethernet UDP/IP packet. Together with the eDiags server embedded into each Q data radio, the user can monitor a Q data radio network using the TView+ diagnostics software over an Ethernet LAN/WAN. A typical use diagram is shown below.

For more information on the features, benefits and technical details of the TView+ diagnostics software, refer to the TView+ diagnostics user manual.

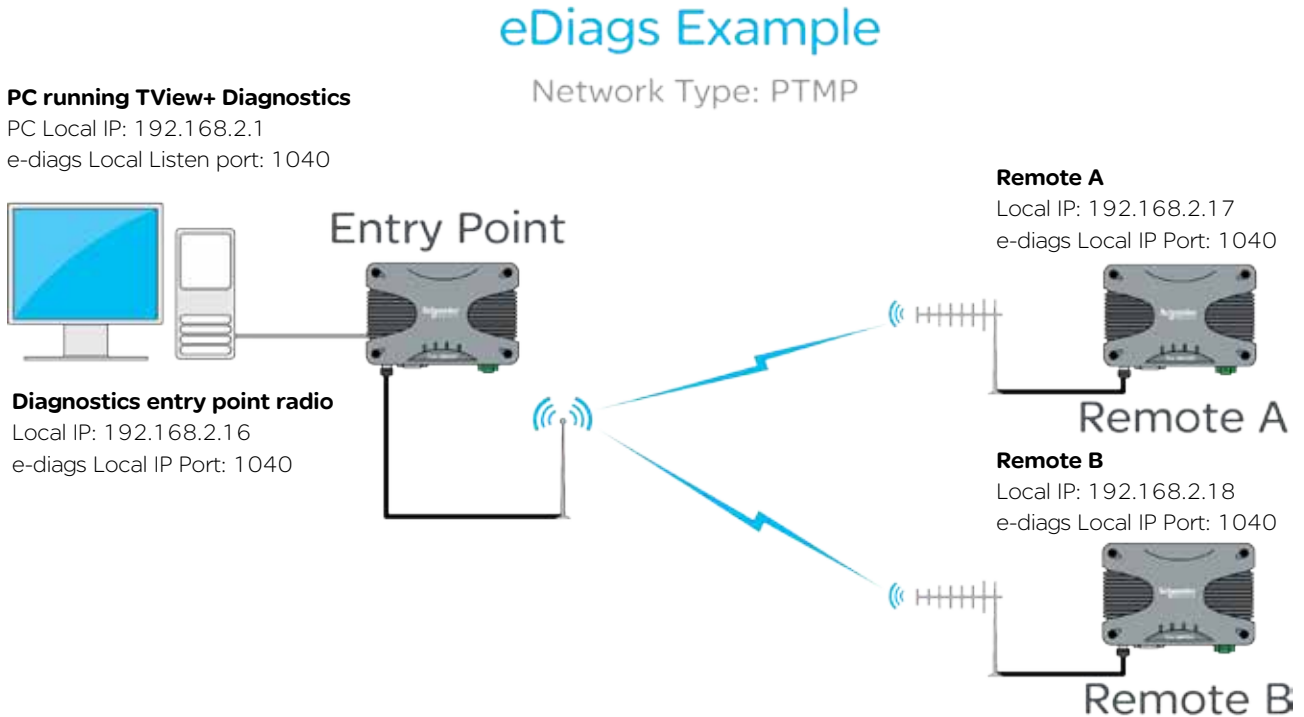

The following instructions will explain how to poll Q data radios using eDiags over a wireless network.

(1) Enable eDiags within each radio that is required to be polled. Configure the following parameter in each radio:

- Local Port number - This will be the port number the eDiags session (within the PC) will address all eDiags data to (example uses: 1040)

(2) Ensure the TView+ Diagnostics software has been installed on the PC

(3) Open the TView+ Diagnostics software on the PC and configure the following items (for detailed instructions on the TView+ Diagnostics software, refer to the TView+ Diagnostics user manual):

- Create a list (database) of Q data radios that are required to be polled for diagnostics. Each data base entry should have the communications port set to eDiags (Ethernet) and configured to use the IP address and eDiags port number of the corresponding radio. Each serial number entered needs to be correct. Other information can also be specified.
- Define the IP address and local listening port number for the eDiags session (controller address and port number). This can be configured in Settings -> eDiags Port settings. The IP address and port number configured, needs to match the controller IP address and controller port number specified within the eDiags settings within each of the radios (they should all have common settings).

This now completes the requirements for configuring eDiags. The operation of eDiags for a typical poll/response diagnostics transaction is as follows:

(1) The TView+ Diagnostics software constructs a UDP/IP data gram which targets the embedded eDiags server of each radio configured within the database.

(2) The UDP datagram is placed onto the LAN/WAN which routes the datagram onto the radio network.

(3) The entry point radio will respond to any poll addressed to it's own IP address and eDiags port, or, will transmit the poll over the air to the targeted radio.

(4) The targeted radio will then respond to the poll, by transmitting a response, which will be sent back to the controller address (the Diagnostics PC).

## System Topology Configuration

### Transparent Bridge Mode

#### Introduction

The following Diagrams are designed to provide configuration information on typical topologies. The channel bandwidth and Tx/Rx frequencies are not shown within the diagrams, as they depend on the users license.

The following diagrams show '/24' after an IP address. This short hand addressing indicates the device's subnet mask. '/24' equals a subnet mask of 255.255.255.0

#### Point to Point - Full Duplex

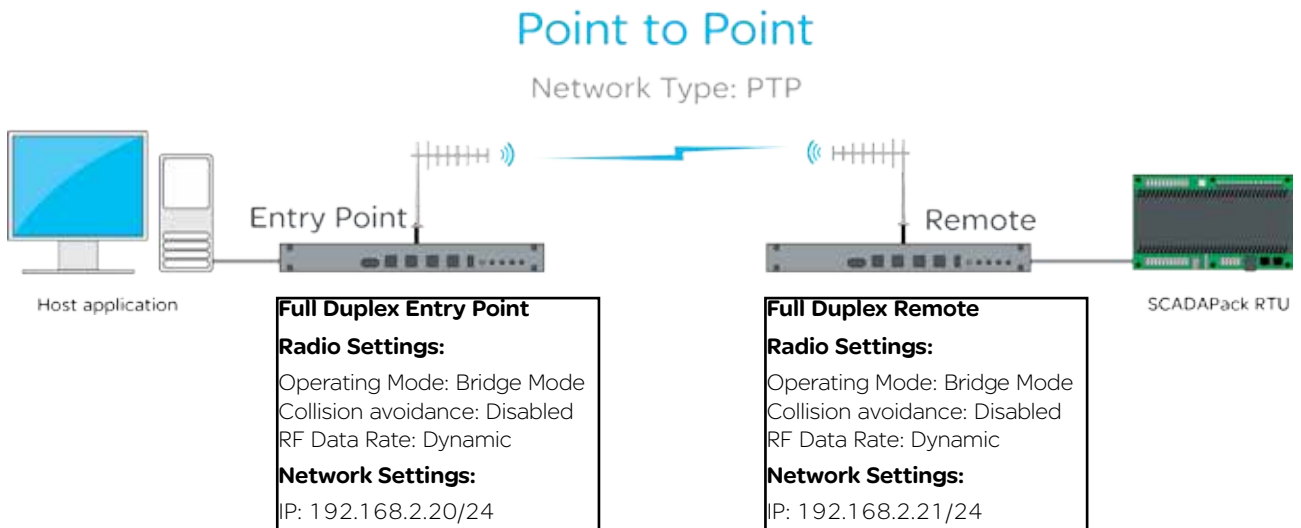

#### Point to Point - Half Duplex

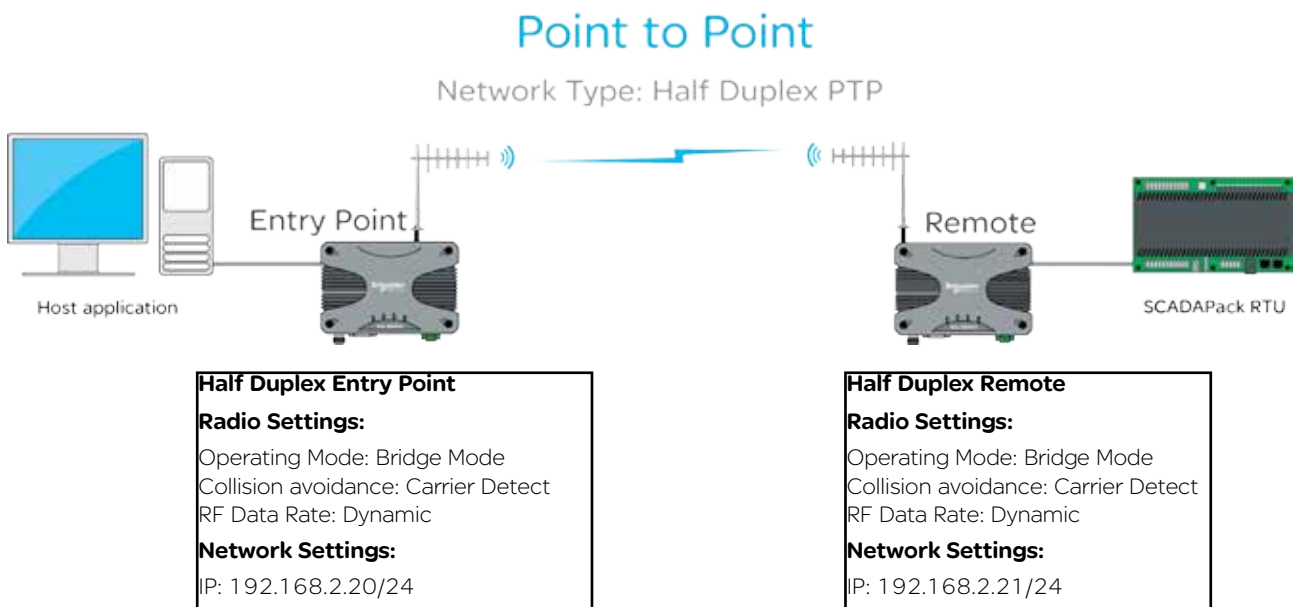

Point to Multipoint - Full Duplex Entry Point

# Point to Multipoint

Network Type: PTMP

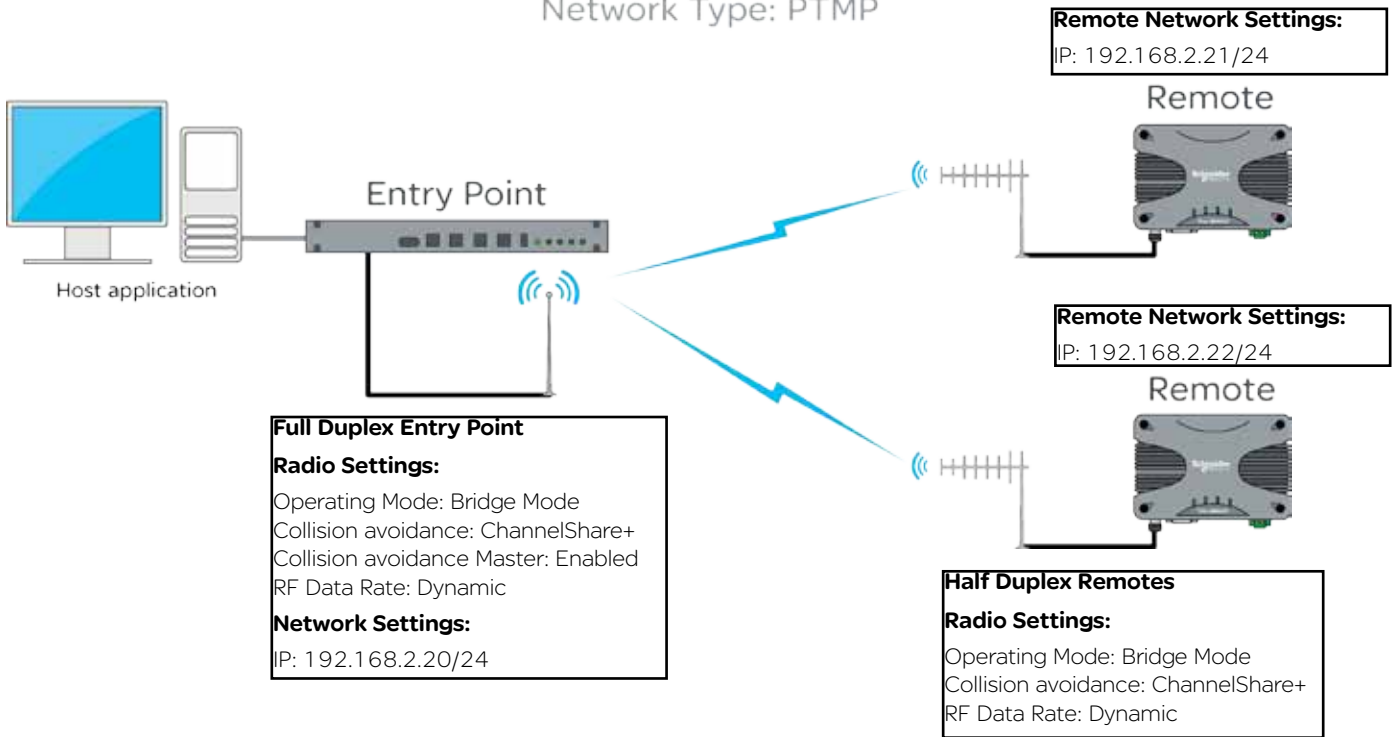

Point to Multipoint - Half Duplex Entry Point

# Point to Multipoint

Network Type: PTMP

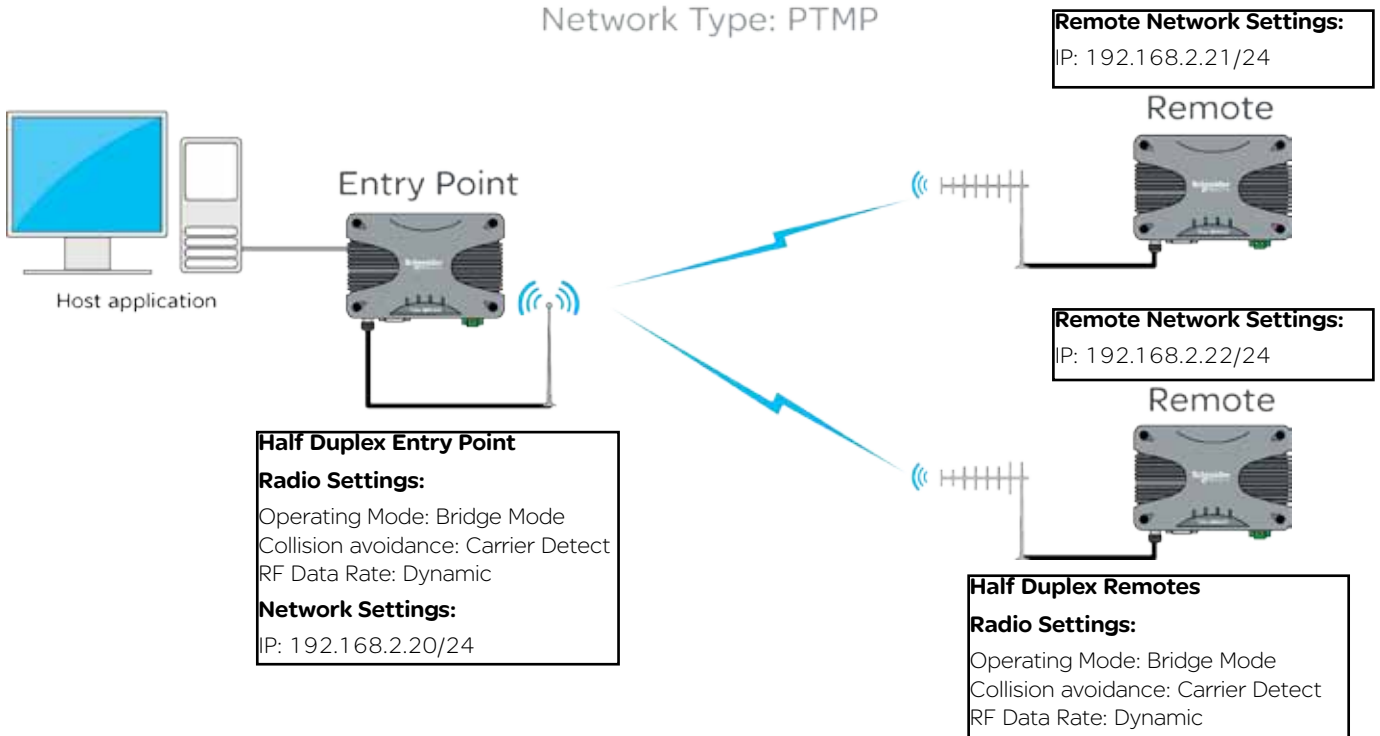

Point to Multipoint via Repeater - Full Duplex Repeater

## Point to Multipoint via Repeater

Network Type: PTMP/R

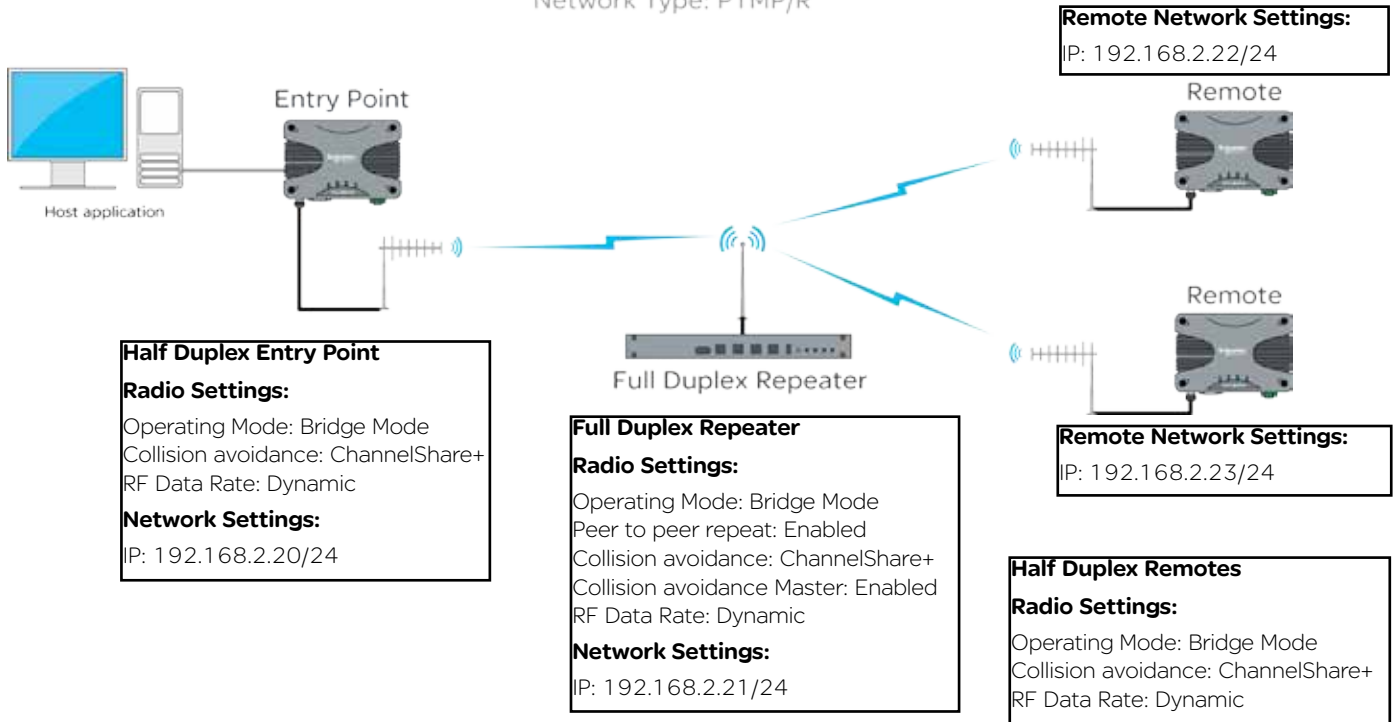

Point to Multipoint via Repeater - Half Duplex Repeater

## Point to Multipoint via Repeater

Network Type: PTMP/R

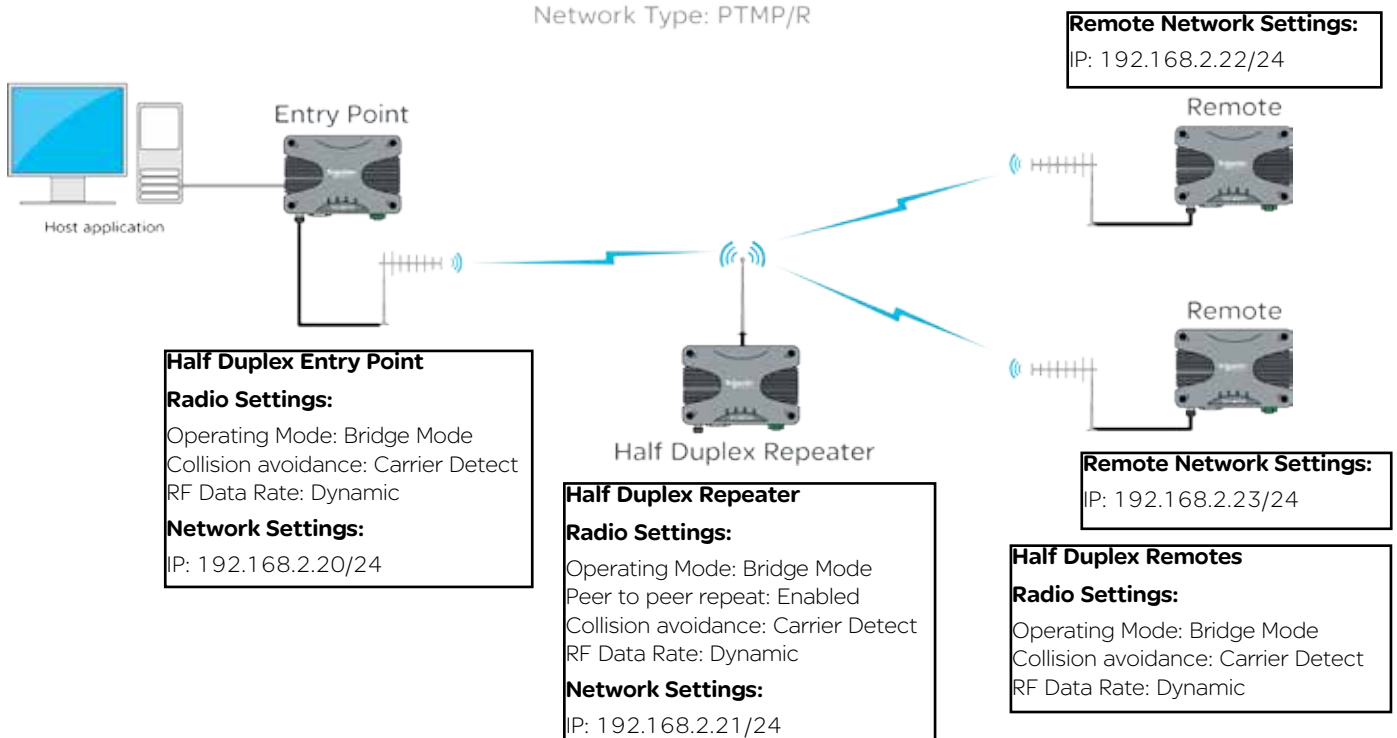

Multipoint to Multipoint

## Multipoint to Multipoint (Simplex)

Network Type: MPTMP

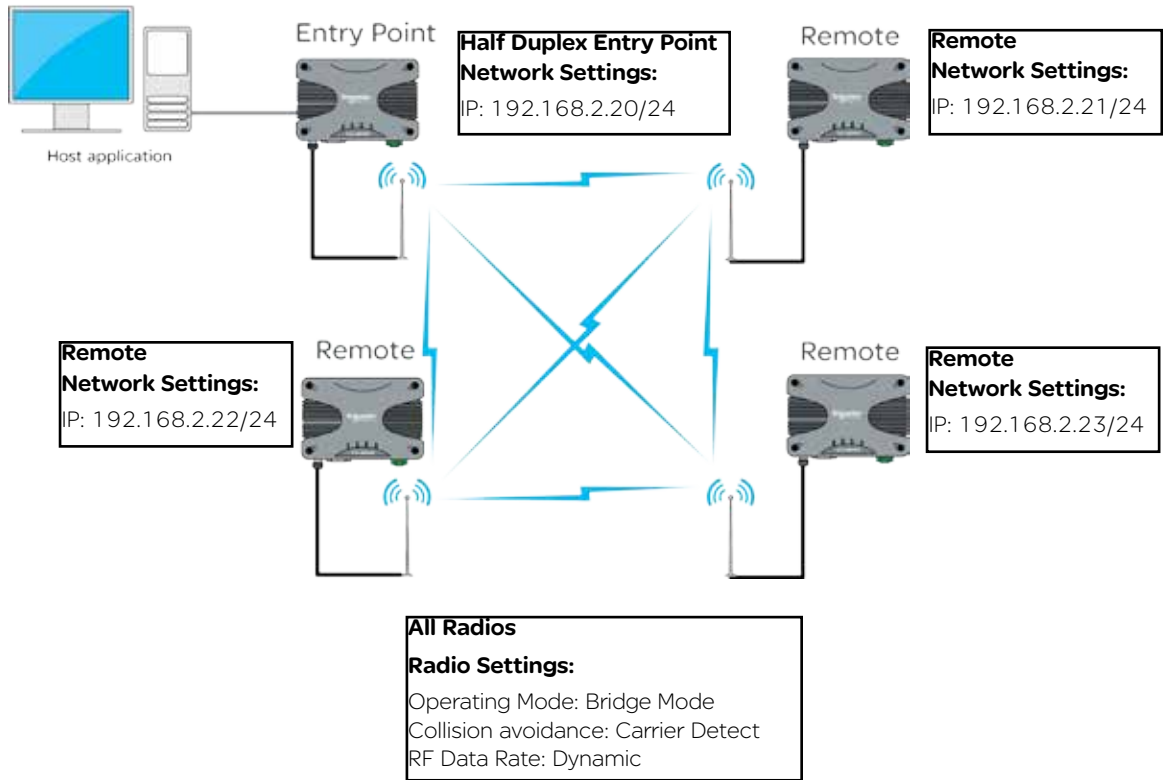

**Router Mode**

**Introduction**

The following Diagrams are designed to provide configuration information on typical topologies. The channel bandwidth and Tx/Rx frequencies are not shown within the diagrams, as they depend on the users license.

The following diagrams show '/24' after an IP address. This short hand addressing indicates the device's subnet mask. '/24' equals a subnet mask of 255.255.255.0. Short hand addressing can be used when writing a static route.

**Point to Multipoint - Full Duplex Entry Point**

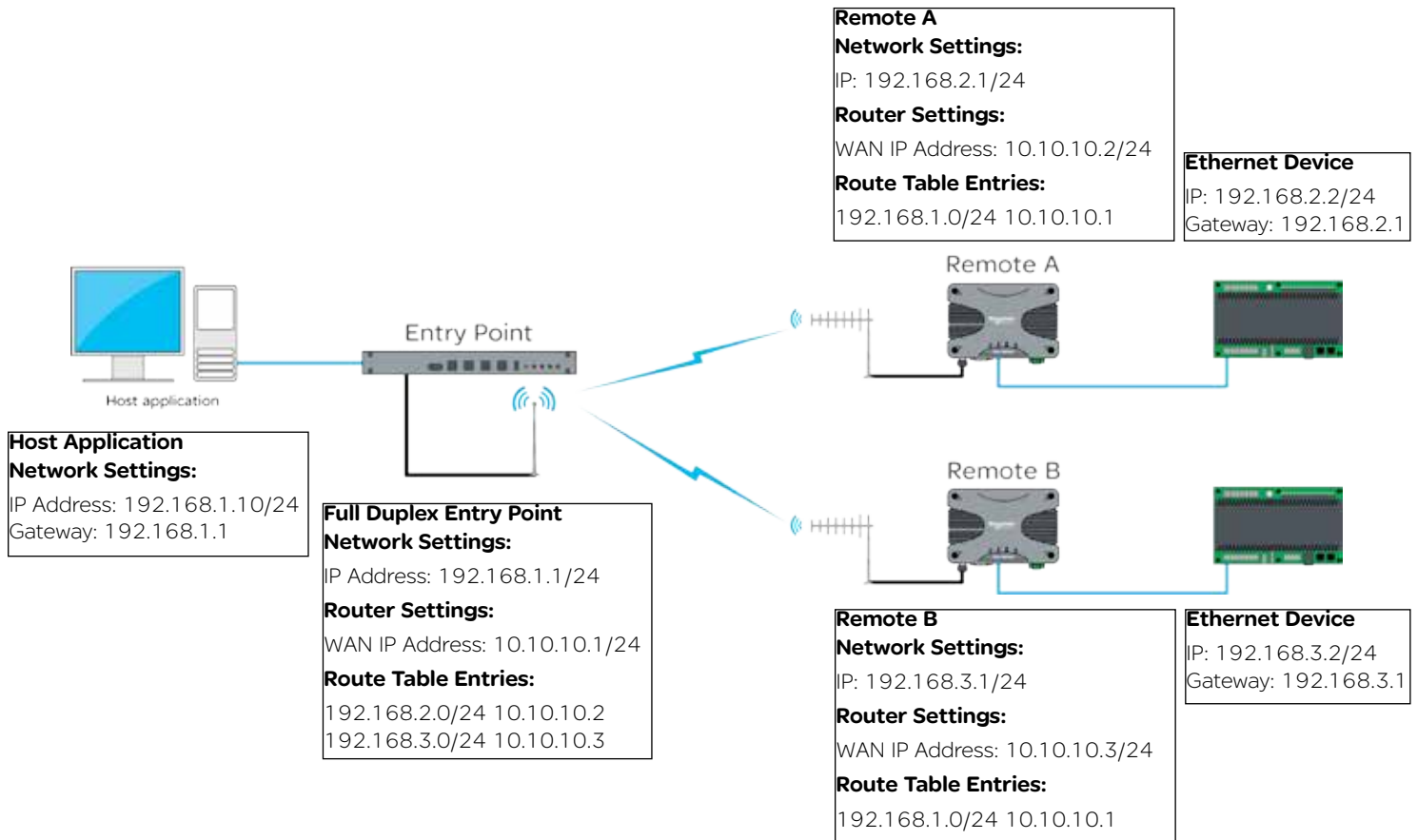

**IP Route Configuration Example - Full Duplex Entry Point**

In relation to the diagram above (Point to Multipoint - Full Duplex Entry Point) the following example shows how the IP Routing configuration would appear within the Full Duplex Entry Point radio.

**IP Routing**

---

WAN IP Address:

WAN Mask:

Static Routes:

192.168.2.0 255.255.255.0 10.10.10.2	Remove
192.168.3.0 255.255.255.0 10.10.10.3	Remove/Add

Each static route contains three parts: Network Address, Subnet Mask and Gateway.

The format of a static route can be either of the following: (Each yellow box shown requires a single space between them).



Point to Multipoint via multiple Repeaters

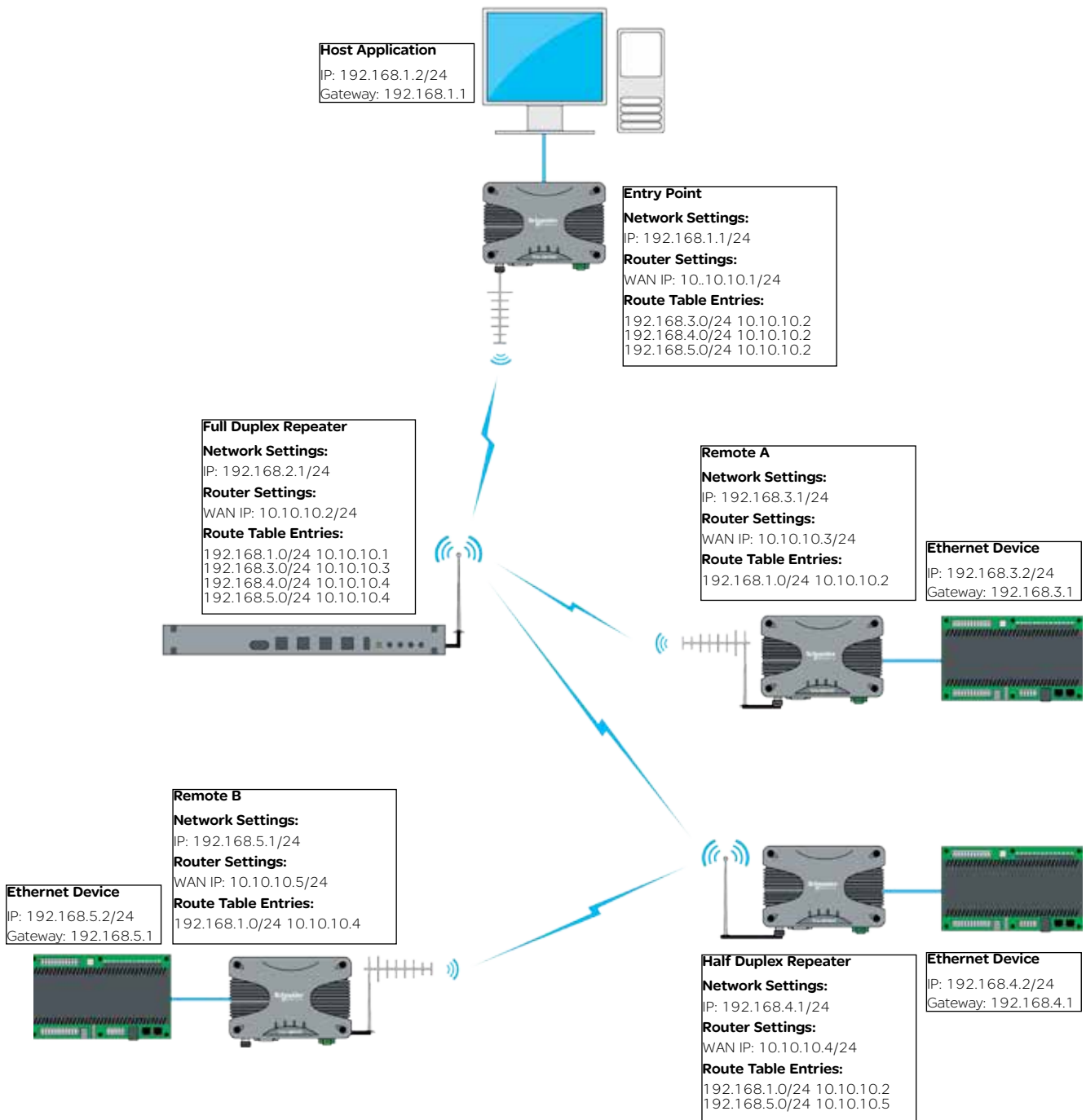



## Serial and MODBUS

### Introduction

Point to Point serial connectivity can be achieved by using the serial device server embedded within the Q data radios radio. The serial device server has three protocols available, each with their own benefits:

**TCP:** Establishes a session based connection, providing high reliability on data delivery.

**UDP:** Consumes low bandwidth and provides a low latency connection.

**PPP:** Provides a virtual Ethernet connection over a serial link.

### Serial data transport via TCP

Connect the PC's Ethernet port to ETH1 or ETH2 of the radio being configured and using a web browser, browse to the radio's configuration page by entering the IP address the unit into the browser's URL bar. Once the configuration has been activated, repeat the process for the remaining radio.

To access the parameters below, browse to the "Setup" tab and select the "COM1" option under "Configuration".

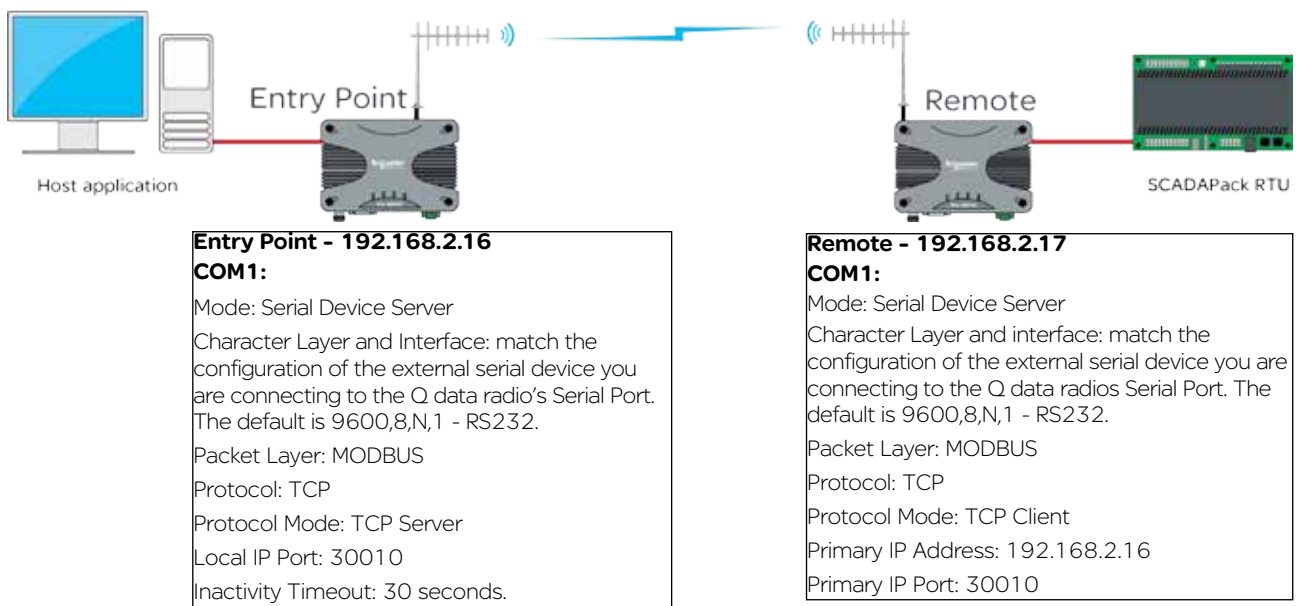

### Serial data transport via UDP

Connect the PC's Ethernet port to ETH1 or ETH2 of the radio being configured and using a web browser, browse to the radio's configuration page by entering the IP address the unit into the browser's URL bar. Once the configuration has been activated, repeat the process for the remaining radio.

To access the parameters below, browse to the "Setup" tab and select the "COM1" option under "Configuration".

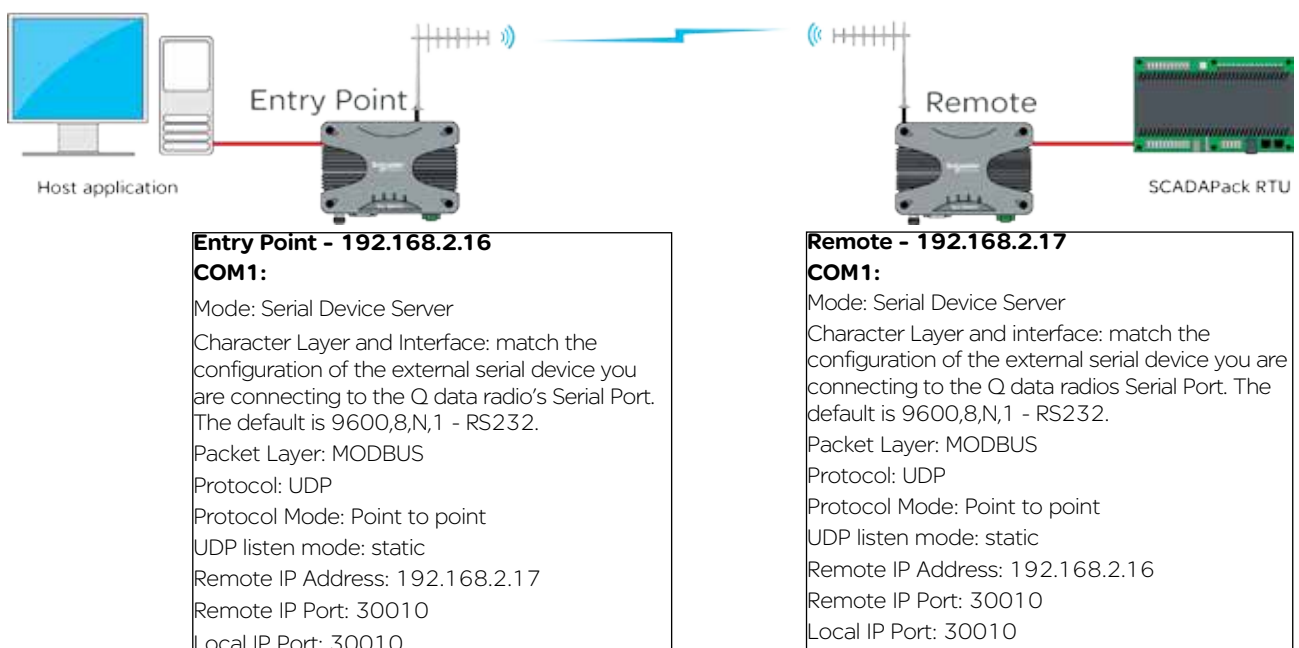

## Serial data transport via PPP

Connect the PC's Ethernet port to ETH1 or ETH2 of the radio being configured and using a web browser, browse to the radio's configuration page by entering the IP address the unit into the browser's URL bar. Once the configuration has been activated, repeat the process for the remaining radio.

To access the parameters below, browse to the "Setup" tab and select the "COM1" option under "Configuration".

The example uses the following IP addresses for external PPP Clients: 'Host Application - 192.168.2.20' 'External Device (RTU) - 192.168.2.30'

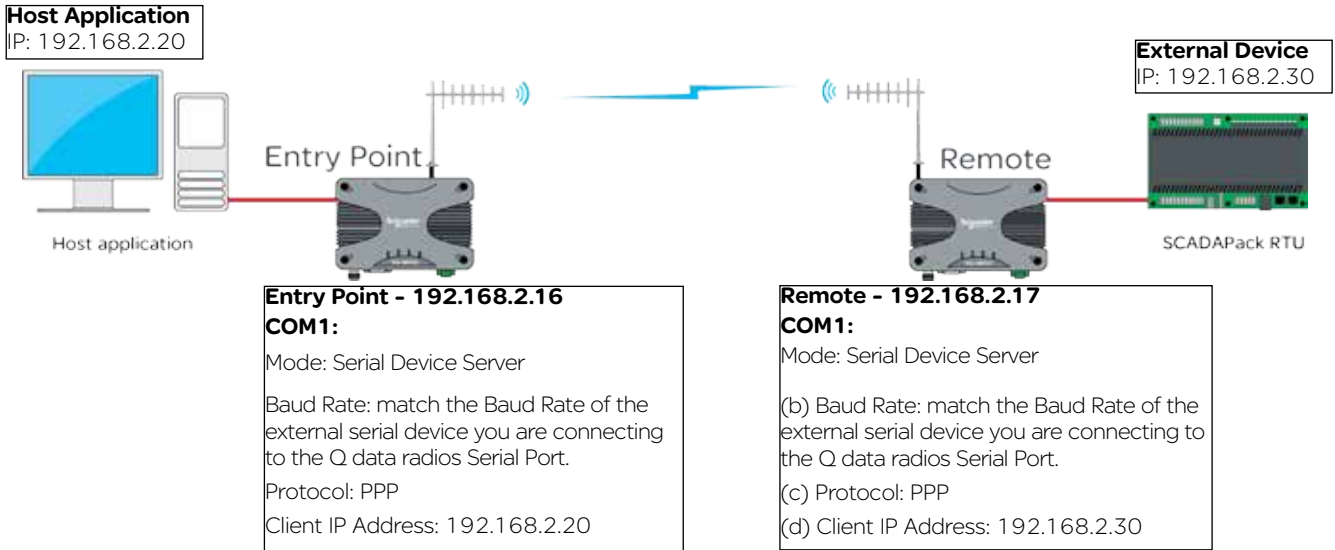

## Point to MultiPoint Serial to Serial Link Setup

### Introduction

Point to Multipoint serial connectivity can be achieved by using the serial device server embedded within the Q data radios. The serial device server can be used in UDP mode, to achieve a point to multipoint serial link.

### Serial data transport via UDP

Connect the PC's Ethernet port to ETH1 or ETH2 of the radio being configured and using a web browser, browse to the radio's configuration page by entering the IP address the unit into the browser's URL bar. Once the configuration has been activated, repeat the process for the remaining radio/s.

To access the parameters below, browse to the "Setup" tab and select the "COM1" option under "Configuration".

The allocated IP addresses for this example are 'Entry Point- 192.168.2.16', 'Remote A - 192.168.2.17', 'Remote B - 192.168.2.18'.... (additional remotes can use incremental IP allocation from Remote B).

**Entry Point - 192.168.2.16**  
**COM1:**  
 Mode: Serial Device Server  
 Character Layer and Interface: match the configuration of the external serial device you are connecting to the Q data radios Serial Port. The default is 9600,8,N,1 - RS232.  
 Packet Layer: MODBUS  
 Protocol: UDP  
 Protocol Mode: Point to Multipoint  
 Node Type: Point  
 Remote Multicast IP Address: 224.240.1.1  
 Remote IP Port: 30010  
 Local IP Port: 30010

**Remote A - 192.168.2.17**  
**COM1:**  
 Mode: Serial Device Server  
 Character Layer and interface: match the configuration of the external serial device you are connecting to the Q data radios Serial Port. The default is 9600,8,N,1 - RS232.  
 Packet Layer: MODBUS  
 Protocol: UDP  
 Protocol Mode: Point to Multipoint  
 Node Type: Multi-Point  
 Remote IP Address: 192.168.2.16  
 Remote IP Port: 30010  
 Local Multicast IP Address: 224.240.1.1  
 Local IP Port: 30010

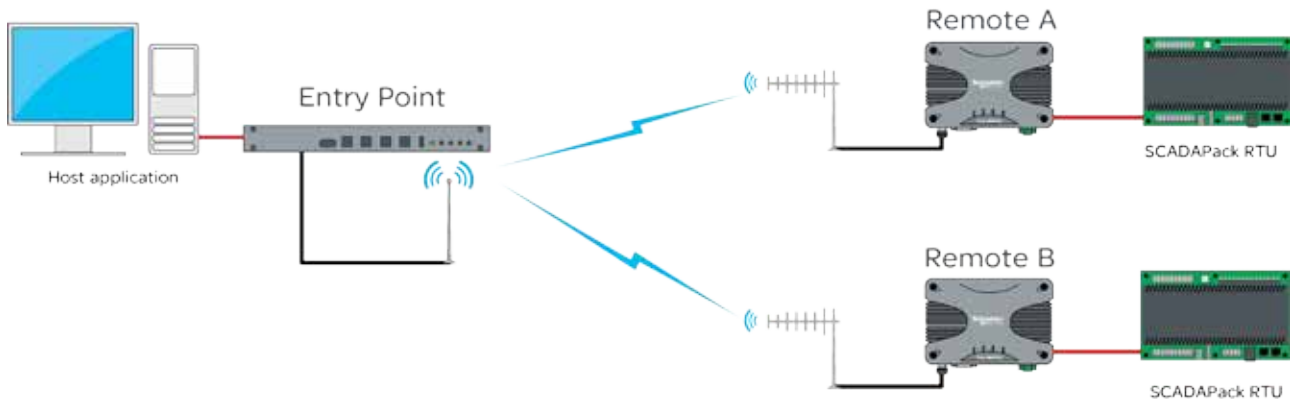

**Remote B - 192.168.2.18**  
**COM1:**  
 Mode: Serial Device Server  
 Character Layer and interface: match the configuration of the external serial device you are connecting to the Q data radios Serial Port. The default is 9600,8,N,1 - RS232.  
 Packet Layer: MODBUS  
 Protocol: UDP  
 Protocol Mode: Point to Multipoint  
 Node Type: Multi-Point  
 Remote IP Address: 192.168.2.16  
 Remote IP Port: 30010  
 Local Multicast IP Address: 224.240.1.1  
 Local IP Port: 30010

## MODBUS Gateway

### Introduction

Point-to-Point (PTP) with MODBUS TCP to MODBUS RTU can be performed by using the MODBUS gateway feature embedded within the Q data radios.

#### MODBUS TCP to MODBUS RTU - Point to point

Connect the PC's Ethernet port to ETH1 or ETH2 of the radio being configured and using a web browser, browse to the radio's configuration page by entering the IP address the unit into the browser's URL bar. Once the configuration has been activated, repeat the process for the remaining radio/s.

To access the parameters below, browse to the "Setup" tab and select the "COM1" option under "Configuration".

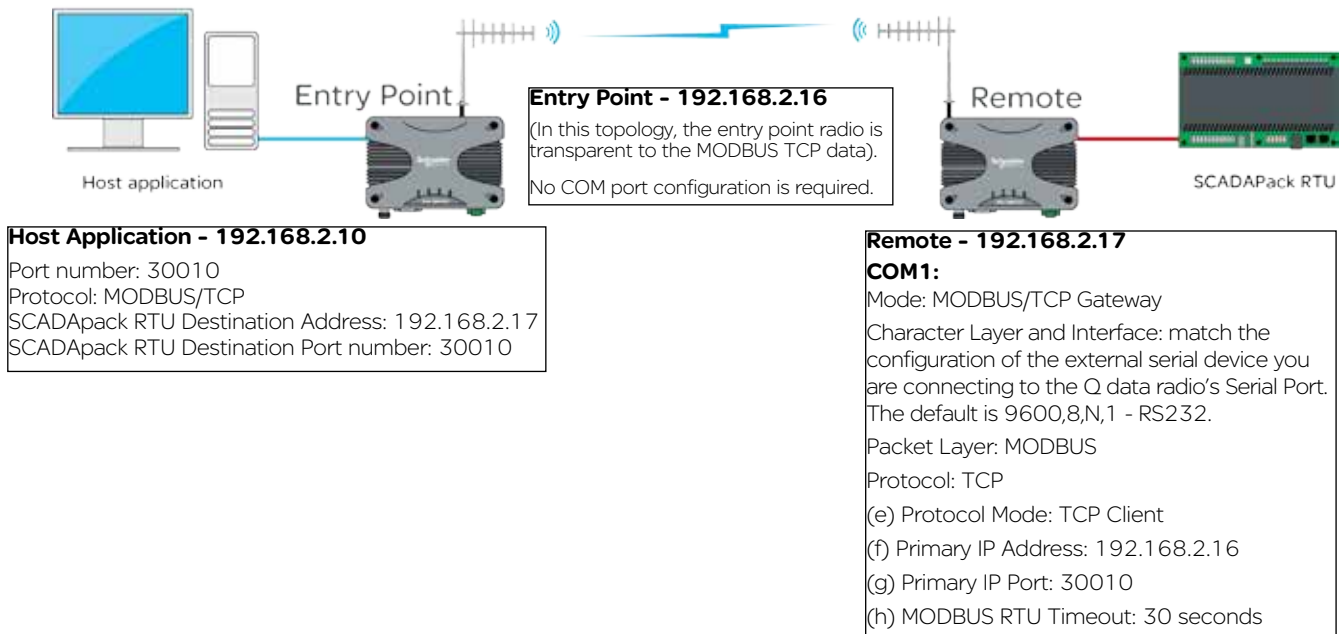

**MODBUS TCP to MODBUS RTU - Point to multipoint**

**Introduction**

Point to multipoint (PTMP) with MODBUS TCP to MODBUS RTU can be performed by using the MODBUS gateway feature embedded within the Q data radios.

**MODBUS TCP to MODBUS RTU - Point to multipoint**

Connect the PC's Ethernet port to ETH1 or ETH2 of the radio being configured and using a web browser, browse to the radio's configuration page by entering the IP address the unit into the browser's URL bar. Once the configuration has been activated, repeat the process for the remaining radio/s.

To access the parameters below, browse to the "Setup" tab and select the "COM1" option under "Configuration".

**Host Application - 192.168.2.10**  
 Port number: 30010  
 Protocol: MODBUS/TCP  
 Site A - RTU Destination Address: 192.168.2.17  
 Site A - RTU Destination Port number: 30010  
 Site B - RTU Destination Address: 192.168.2.18  
 Site B - RTU Destination Port number: 30010

**Remote A - 192.168.2.17**  
**COM1:**  
 Mode: MODBUS/TCP Gateway  
 Character Layer and Interface: match the configuration of the external serial device you are connecting to the Q data radio's Serial Port. The default is 9600,8,N,1 - RS232.  
 Packet Layer: MODBUS  
 Protocol: TCP  
 Protocol Mode: TCP Server  
 Local IP Port: 30010  
 Inactivity Timeout: 30 seconds.  
 MODBUS RTU Timeout: 30 seconds

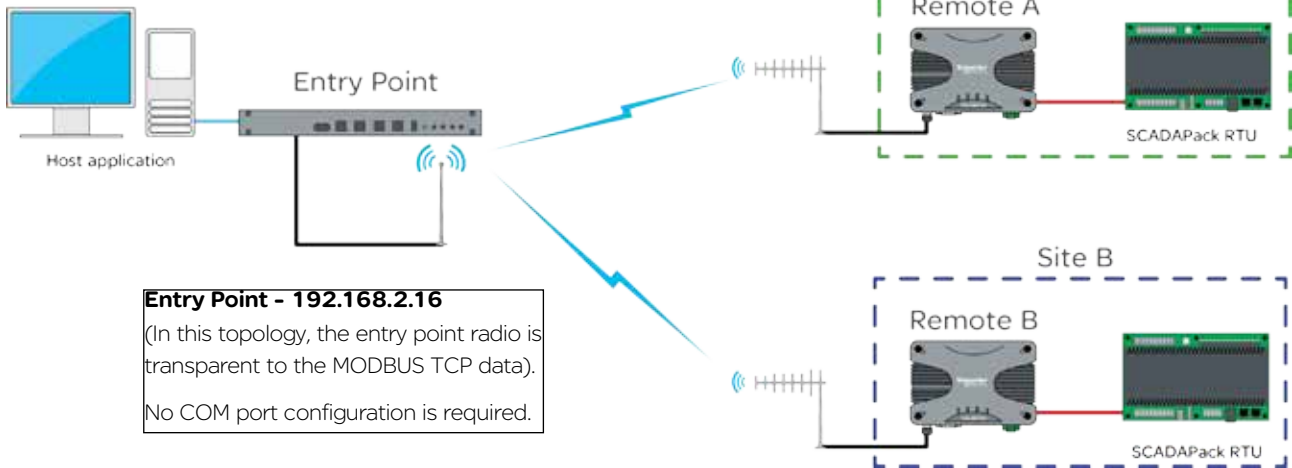

**Entry Point - 192.168.2.16**  
 (In this topology, the entry point radio is transparent to the MODBUS TCP data).  
 No COM port configuration is required.

**Remote B - 192.168.2.18**  
**COM1:**  
 Mode: MODBUS/TCP Gateway  
 Character Layer and Interface: match the configuration of the external serial device you are connecting to the Q data radio's Serial Port. The default is 9600,8,N,1 - RS232.  
 Packet Layer: MODBUS  
 Protocol: TCP  
 Protocol Mode: TCP Server  
 Local IP Port: 30010  
 Inactivity Timeout: 30 seconds.  
 MODBUS RTU Timeout: 30 seconds

## Single Frequency (Simplex) Mode

### Introduction

Half Duplex Trio Q data radios can operate in a single frequency (Simplex) mode. This means the transmitting and receiving frequencies are the same single frequency. See the diagram below.

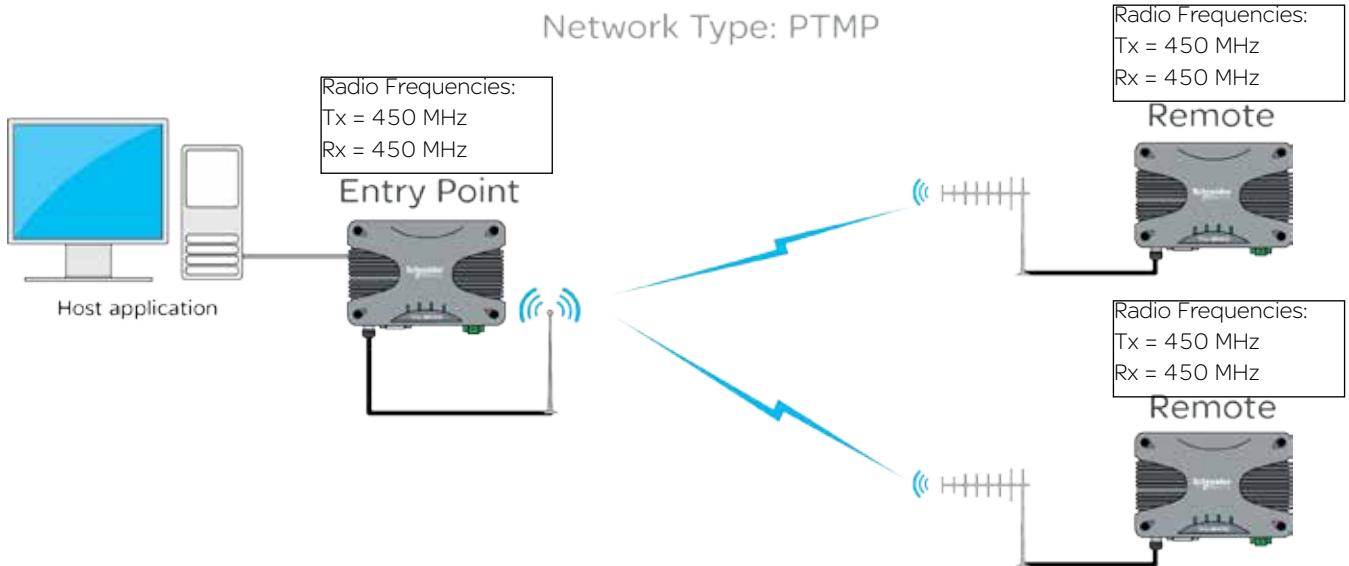

### Configuration

Single frequency operation also requires parameters to be configured which relate to the system topology.

System Topology: Select between Point to MultiPoint (PTMP), Point to MultiPoint via Repeater (PTMP via Repeater) or Point to Point (PTP). Every radio in a simplex radio system should have same system topology selected.

### System Topology

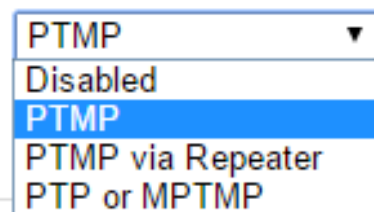

Topology Function: Each radio in a simplex radio system will have its own topology function. Select between Entry Point, Repeater or Remote.

### Topology Function

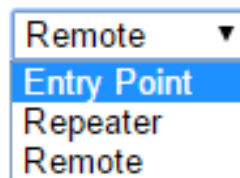

## E-Series Emulation Mode

### Introduction

The Diagram below shows a typical E-Series PTMP via Repeater topology, where the remote sites have been replaced with half duplex Q data radios. Configuration values which are fundamental to a successful radio link are shown below to provide an example on how to configure the Q data radios in E-Series emulation mode. Single frequency or two frequency systems can utilise E-Series emulation mode.

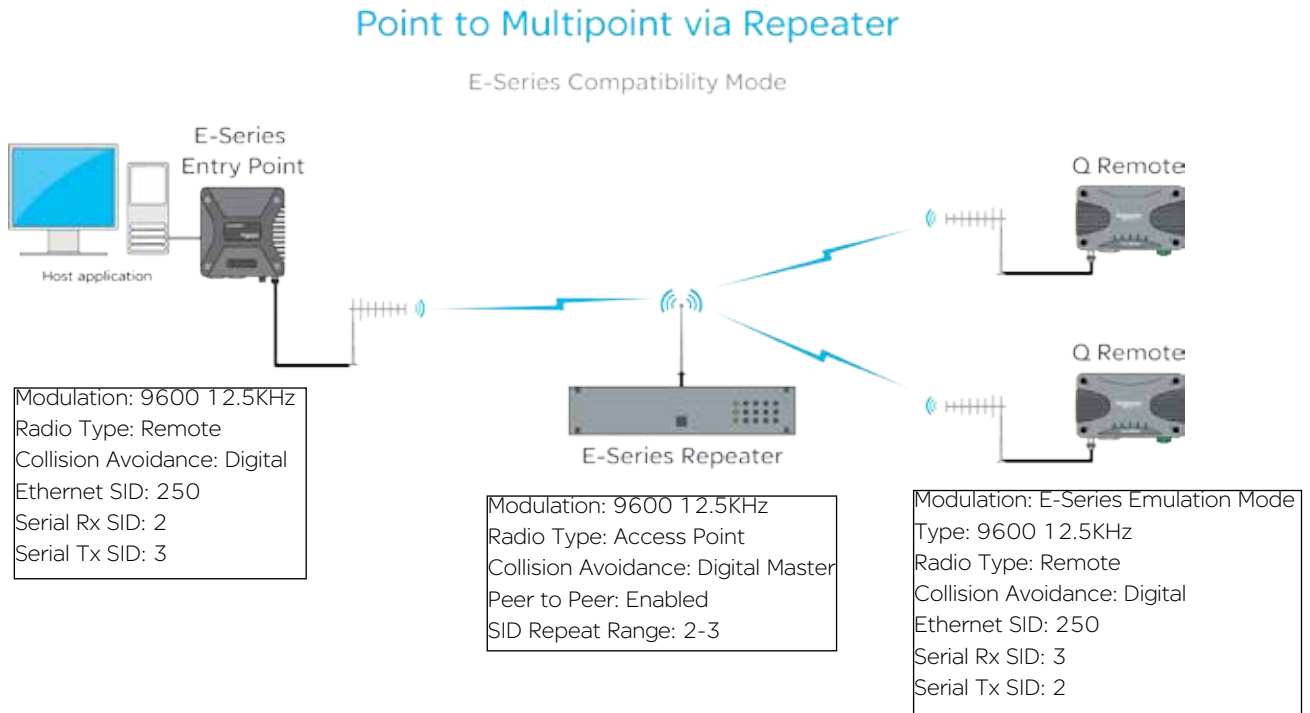

### Configuration

The configuration parameters shown in the diagram above can be accessed within the Q data radio within the following locations:

**Modulation** (Setup -> Radio -> Modulation) provides the compatibility options of: Q data Radio Mode or E-Series Emulation Mode.

#### Compatibility

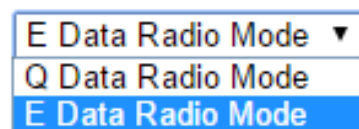

**Type** (Setup -> Radio -> Modulation) provides the bandwidth/data rate options of:

- 9600 12.5KHz ACA 4 Level
- 19200 25KHz ACA 4 Level

These options may differ, depending on the region approval of the radio (ACMA/ETSI/FCC).

#### Type

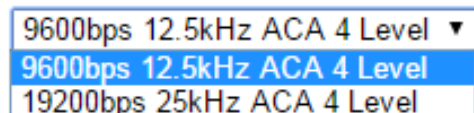

**Radio Type** (Setup -> Radio -> System Parameters) provides the options of:

- Access Point
- Remote

#### Radio Type

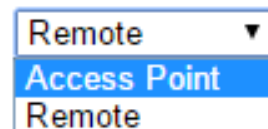

**Ethernet Stream ID (SID)** (Setup -> Radio -> System Parameters) provides the configuration option of Ethernet SID to be used

Ethernet SID

**Serial Rx/Tx SIDs** (Setup -> Serial Com 1 (or 2)) provides the configuration options of the Serial SIDs to be used

Rx SID

---

Tx SID

Radio configuration is still performed via WUI or TUI (not via TView+ Programmer).

For detailed information on E-Series parameters, refer to the E-Series user manual.



# Part H – Advanced

## Connectivity

### Text User Interface (TUI)

The Text user interface can be accessed via; a serial connection, a Telnet session or a SSH session.

#### TUI Interface - Serial Console

The serial TUI interface is accessed via the COM 1/2 interface as shown in the diagram below. By default, the TUI can be accessed via COM 1 (Pins 2,3 & 5) .

Text User Interface:

- Com 1
- Port Speed : 19200 bps
- Format : 8, N, 1

Connection to the PC requires a strait-through serial cable with Pins 2,3 & 5 connected. Hardware handshaking is not enabled by default within the Q data radios, so unless handshaking is a requirement, no other connections are required.

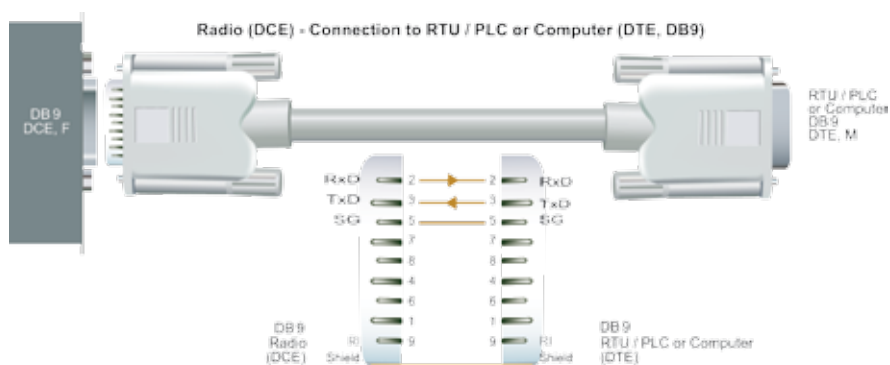

Once the Q data radio is connected to the PC via a strait through serial cable, use a serial console tool to create a serial communications connection to the TUI. The following example uses a software package called 'PuTTY'. PuTTY is a freely available Serial console, SSH and telnet client. PuTTY can be downloaded from: <http://www.putty.org/>

Once installed, open PuTTY to display the configuration window.

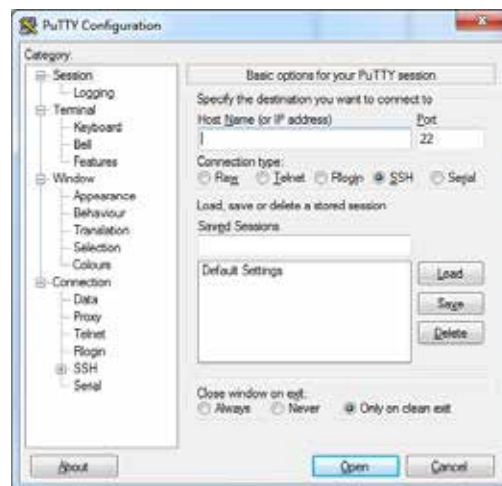

Within the 'Category' section, go to: Connection > Serial. Within the serial line configuration section configure the serial port you will be using to interface to the Q data radio to the following settings:

- Speed (baud): 19200
- Data bits: 8
- Stop bits: 1
- Parity: None
- Flow control: None

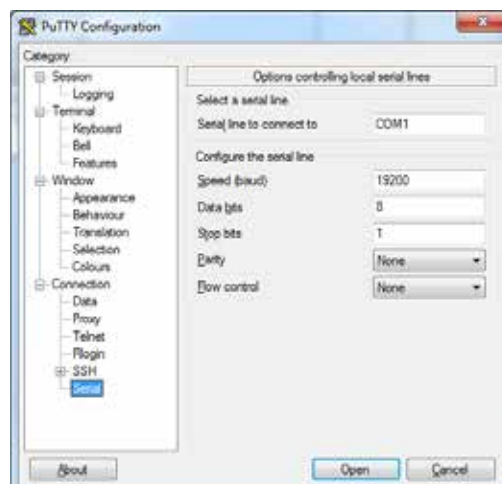

## TUI Interface - Telnet session

The text user interface can be accessed via Telnet. This is convenient if you are remotely connected to a Q data radio via an Ethernet network. The Telnet interface requires much less bandwidth compared to the web user interface, which results in higher speed access to configuration parameters and diagnostics. Most computer operating systems come with integrated Telnet software. For Windows based operating system, you can initiate a Telnet session using the command line interface.

Before you can connect to the text user interface (TUI) via Telnet, ensure that the Telnet interface within the Q data radio is enabled. By default, the Telnet service is enabled. The Telnet service can be enabled/disabled using the Web user interface. Enable the interface via the “Configuration -> Security” menu item as shown below.

Telnet Terminal

Enable  Disable

**Telnet Terminal:**

Set to enable Telnet Sessions.

To start a Telnet session, open a command window via “Start -> Run” and type “Telnet xxx.xxx.xxx.xxx” where xxx is the IP address of the target radio. See example below.

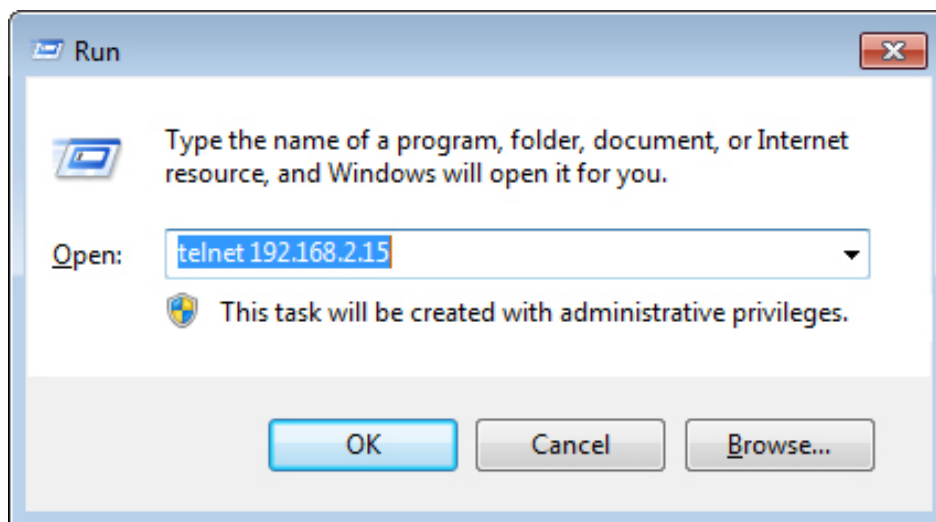

If the Telnet connection was successful, the following screen will be displayed.

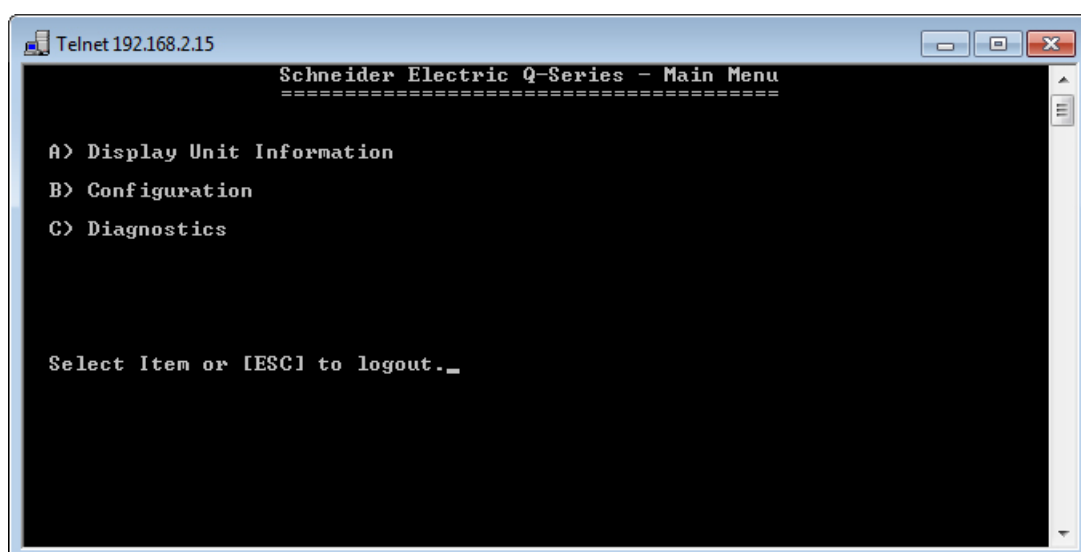

If security password protection has been enabled, you will first need to enter the appropriate user name and password.

The TUI is divided into three distinct areas :

(1) Unit Information - Displays unique unit information about the radio such as serial number, currently configured IP address and firmware pack version identification.

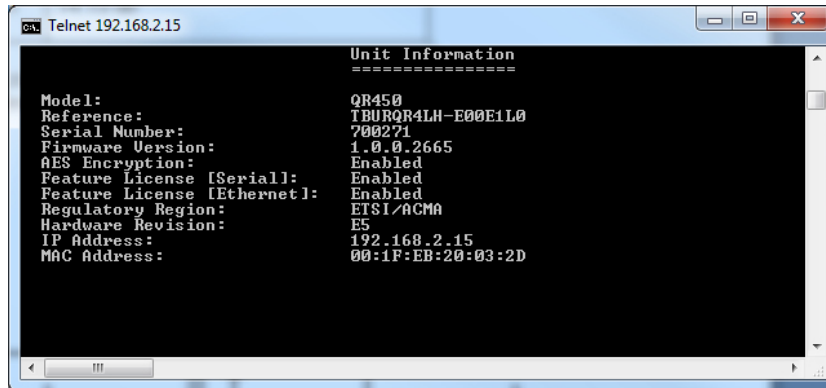

```

Unit Information
=====
Model:           QR450
Reference:       TBUR0R4LH-E00E1L0
Serial Number:   700271
Firmware Version: 1.0.0.2665
AES Encryption: Enabled
Feature License [Serial]: Enabled
Feature License [Ethernet]: Enabled
Regulatory Region: ETSI/ACMA
Hardware Revision: E5
IP Address:      192.168.2.15
MAC Address:     00:1F:EB:20:03:2D
  
```

(2) Configuration - Provides access to the configuration of Network Parameters, Radio configuration, Serial interfaces, eDiags, Security, SNMP and IP routing.

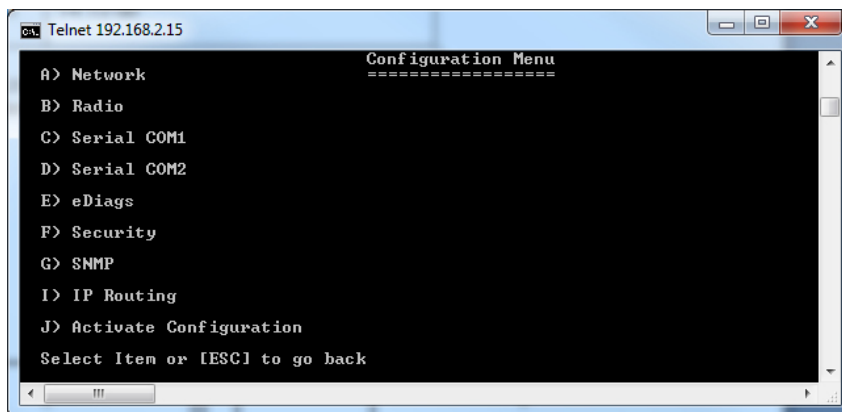

```

Configuration Menu
=====
A) Network
B) Radio
C) Serial COM1
D) Serial COM2
E) eDiags
F) Security
G) SNMP
I) IP Routing
J) Activate Configuration
Select Item or [ESC] to go back
  
```

(3) Diagnostics - Provides access to the Diagnostics facilities in the radio.

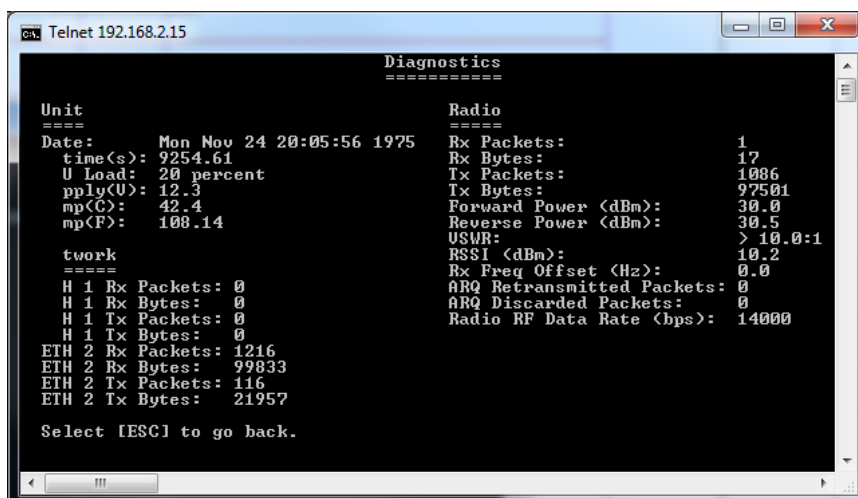

```

Diagnostics
=====
Unit                               Radio
====                               =====
Date:      Mon Nov 24 20:05:56 1975  Rx Packets:      1
time(s):   9254.61                    Rx Bytes:         17
U Load:    20 percent                  Tx Packets:      1086
pply(U):   12.3                        Tx Bytes:        97501
mp(C):     42.4                        Forward Power <dBm>: 30.0
mp(F):     100.14                      Reverse Power <dBm>: 30.5
                                                USWR:            > 10.0:1
                                                RSSI <dBm>:      10.2
                                                Rx Freq Offset <Hz>: 0.0
                                                ARQ Retransmitted Packets: 0
                                                ARQ Discarded Packets: 0
                                                Radio RF Data Rate <bps>: 14000

twork
====
H 1 Rx Packets: 0
H 1 Rx Bytes: 0
H 1 Tx Packets: 0
H 1 Tx Bytes: 0
ETH 2 Rx Packets: 1216
ETH 2 Rx Bytes: 99833
ETH 2 Tx Packets: 116
ETH 2 Tx Bytes: 21957

Select [ESC] to go back.
  
```

## Secure Shell (SSH)

Secure Shell (SSH) provides a secure alternative to standard Telnet. To access the Q data radio's Text User Interface (TUI) via the embedded SSH server, use an SSH client. The following example shows how to access a Q data radio's TUI using a commonly used Windows SSH client called PuTTY.

Before you can connect to the TUI via SSH, ensure that the SSH server within the Q data radio is enabled (set to SSH Terminal to Enable). For security reasons, the SSH server is disabled by default. It can be enabled via the web user interface. Enable the interface via the "Configuration -> Security" menu item as shown.

Upon enabling SSH, you will also be required to fill out a user name and password. Ensure you record this user name and password for future use.

In order for the SSH client to know it is communicating with the device it is addressing (not a "man in the middle"), the client will attempt to first authenticate the server.

Administration	
Security	<input checked="" type="radio"/> Enable <input type="radio"/> Disable
Login name	<input type="text" value="admin"/>
Password	<input type="text"/>
Confirm Password	<input type="text"/>
Telnet Terminal	<input checked="" type="radio"/> Enable <input type="radio"/> Disable
SSH Terminal	<input checked="" type="radio"/> Enable <input type="radio"/> Disable

The client will take the following process to authenticate the server:

- The client requests the device finger print from the server it is trying to connect to.
- Once the client has received the server's finger print, it will check it's own records to see whether it already has this finger print in memory.
- If it does have the finger print on record, the connection between the client and the server should automatically begin.
- If the client does not have the finger print in memory, a security alert will appear, advising the user that either an attacker could be intercepting the device as it does not have the finger print on record, or it is a new device that it has not connected to before.



As there is no way of differentiating between a "man in the middle" attack or a first time connection due to the finger print not stored on the client's records, it is advised that the SSH server (Q data radio) is always connected locally to the client and read before they are deployed in the field. This will allow the client to store the server's finger print on record and will help prevent any chances of undetected "man in the middle" attacks.

Once a finger print has been stored into memory, it can be extracted from the registry (Putty example only)

HKEY\_CURRENT\_USER\Software\SimonTatham\Putty\SSHHostKeys.

This can then be deployed into another client PC if required.

Configure the SSH client (in this case PuTTY) to interface correctly with the embedded Q data radio's SSH server.

The Port number for the embedded Q data radio's SSH terminal is 22. This is a standard and is not user definable.

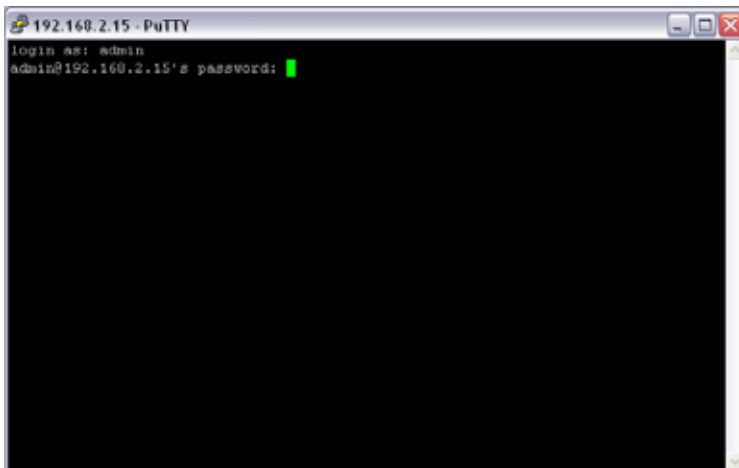
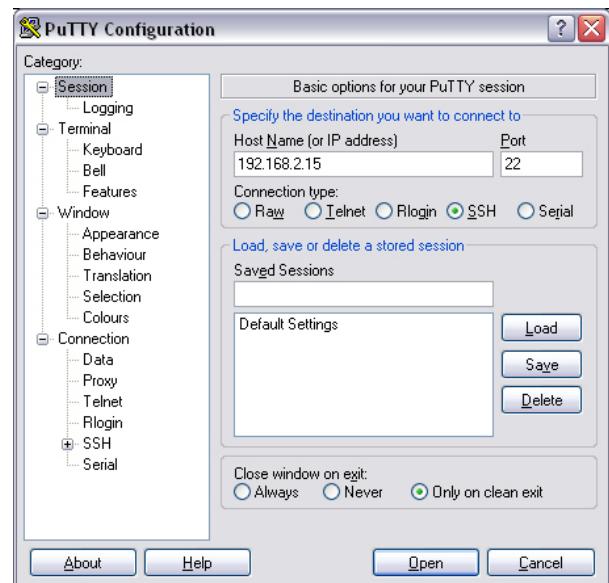

The SSH terminal also requires a user name and password to be configured. Upon logging into the Q data radio via SSH, the user will be prompted for the user name and password.

Once the correct user name and password have been entered, the Q data radio will grant access to the TUI main menu.



## Web User Interface (WUI)

The Web User Interface can be access via a HTTP connection or a HTTPS connection. For instructions on how to access the WUI via a HTTP connection, refer to the Quick Reference Guide section within this manual.

## HTTP Secure (HTTPS)

The Q data radio’s web user interface can be accessed through a secure HTTP (HTTPS) connection.

There are multiple steps required to establish a successful HTTPS connection to a Q data radio, which include:

- Enabling HTTPS within the Q data radio.
- Loading a signed, digital certificate into the Q data radio. This may be generated by a certificate server (i.e. Active directory) or can be self-generated by the Q data radio.
- Resolving web browser issues.

Once the above steps have been completed, enter “HTTPS://xxx.xxx.xxx.xxx” where ‘x’ is the unit’s IP address, into the web browsers URL bar and press enter.

### Enabling HTTPS within a Q data radio:

Browse to the unit’s Security page (Setup -> Security) and under the Administration heading, you are able to enable/disable HTTPS. You also have the option to disable HTTP access once HTTPS is enabled.

#### Administration

Security	<input type="radio"/> Enable <input checked="" type="radio"/> Disable	<b>Security:</b> Enable administration security.
Telnet Terminal	<input checked="" type="radio"/> Enable <input type="radio"/> Disable	<b>Telnet Terminal:</b> Set to enable Telnet Sessions.
Https Access	<input checked="" type="radio"/> Enable <input type="radio"/> Disable	<b>Https Access:</b> Enable secure https (https) access.
Http Access	<input checked="" type="radio"/> Enable <input type="radio"/> Disable	<b>Http Access:</b> Enable insecure http access.

### Loading a digitally signed certificate into a Q data radio:

#### Certificate Management Server:

A certificate can be generated and signed from a certificate management server. Once a certificate is signed, it should then be loaded into the Q data radio. An example of commonly used certificate management server is Active directory. For each individual unit, a unique certificate is required. Certificates used are bound to each unit by its IP address and serial number. If the IP address of a unit is changed, the certificate needs to be re-generated and re-loaded back into the Q data radio.

#### HTTP SSL Certificate

Upload Certificate:

To load a signed certificate into a Q data radio via the WUI, browse to the Security Management page (Maintenance -> Security management) and select the ‘Browse’ button.

Verify the correct file has been selected, then press the ‘Upload’ button.

Once the certificate has been successfully uploaded, a message will appear and information about the certificate will be visible within the current certificate section.

Unless the certificate management server has been linked to the web browser as a trusted certificate server, the browser may display security messages upon entry to the Q data radio WUI via HTTPS. To add exceptions into the browser for these security messages see the instructions on the following page.

#### Self signed certificate:

A self signed certificate can easily be generated from within the Q data radio. To generate a self signed certificate, browse to the security update page (Maintenance -> Security maintenance) and select the ‘Generate’ button.

Once the self signed certificate has been created, a message will appear and information about the certificate will be visible within the current certification section.

#### HTTP SSL Certificate

Upload Certificate:

Generate Certificate:

*Self-signed certificate generated successfully*

**Resolving web browser issues:**

Every web browser has a list of trusted Certification Authorities (CAs). When either a CA that is not included within the web browsers trusted list is used to sign a certificate, or a self signed certificate is used, a security message will appear within the web browser when an attempt to access a Q data radio’s WUI via HTTPS is made. See the example below (Example uses internet explorer 8).

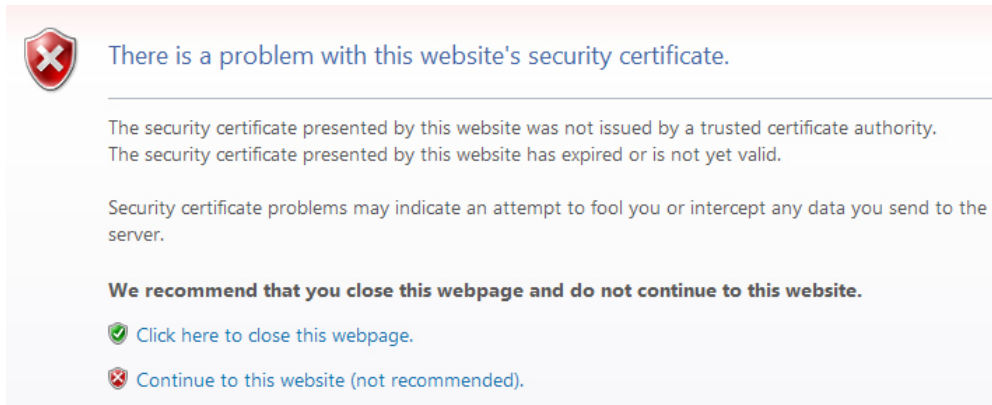

This security message is identifying the fact that the signer of the certificate being read is not within the browser’s trusted list. Pressing the ‘Continue to this website (not recommended)’ button will allow a HTTPS connection through to the Q data radio. The URL bar of the browser will still indicate that the certificate is still not trusted.

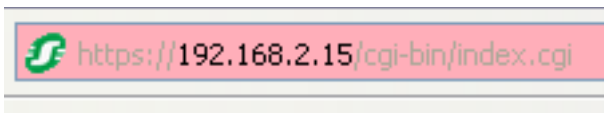

Although the Browser is identifying this, a secure connection should still be in place between the browser and the Q data radio. To add the signer to the browser’s trusted list, follow the steps shown below.

Click on the ‘Certificate Error’ window within the URL bar as shown. This will open a Certificate invalid window, click on the ‘View certificates’ button.

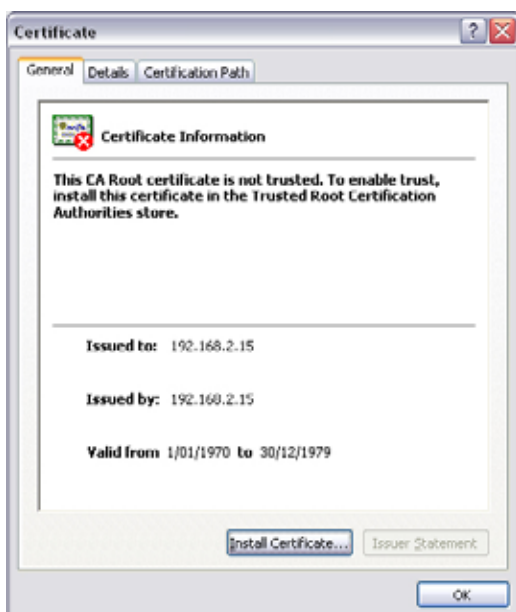
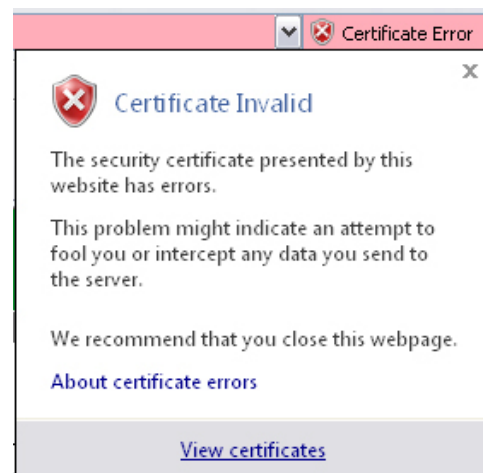

Once the ‘View certificates’ button is selected, a certificate information window will open. Once this window has opened, select the ‘Install Certificate..’ button.

If you cannot see the ‘Install Certificate..’ button, restart Internet explorer in administration mode. Do this by right clicking the Internet Explorer icon on the desktop and selecting ‘open in administrator mode’. If this selection is not available, speak to your system administrator.





This will start the certificate import wizard. Select the Next button.

Select the 'Place all certificates in the following store' option and press the 'Browse...' button.



Select the 'Trusted Root Certification Authorities' folder and press the 'OK' button.



Once the import directory has been selected, press the 'Finish' button.



A security message will appear providing information about the added certificate exception. Press the 'Yes' button to complete the installation process.





## Ease of Use

---















### Alarms

---

#### Introduction





The Q data radio can monitor the condition of various diagnostic and operating parameters (i.e DC volts, Tx Power, etc). The radio's active condition can be evaluated by observing the event history and alarms states.

The alarm states can be viewed within the Monitoring section of the Web User Interface (Monitoring -> Alarms and Events).

ID	ALARM	STATE	CURRENT VALUE
50	Global Alarm		
60	Base Health		
100	Frequency Offset		
110	Received Signal Strength Indication (RSSI)		
120	VSWR		< 1.5:1
130	Tx Power		30.3dBm
140	DC Supply		12.0V
150	Temperature		35.0 (Deg C)
160	Ethernet Link		
170	PLL Lock		
180	Fan		
190	Operational		
200	Rx Packet Comparison		
210	RSSI Comparison		

#### Alarm States

Depending on active values of monitored alarms, the alarm states can be displayed in different levels of severities, including:

 Disabled  Normal  Recovered  Warning  Critical

- **Disabled:** The alarm is not being monitored.
- **Normal:** The alarm value is in normal (acceptable) operating conditions.
- **Recovered:** The alarm has recovered from a warning or critical state, back into normal operating conditions, the alarm state will remain in a recovered state, until either, the alarms are reset (by clicking the reset alarms button at the top corner of the window) or the alarm state changes again.
- **Warning:** The alarm is within the warning threshold limits defined by the user.
- **Critical:** The alarm is outside of the hardware limits of the radio (alarms which can reach critical severity, can not be disabled).

**Configuration**

The diagram below provides an example of how an alarm state can be deemed 'Normal' or 'Critical'. The example shows the value thresholds for the normal and critical state of the DC supply in a QB. Once a DC supply measurement is taken, the behavior of the alarm state reporting structure is as follows:

- **Normal:** If the value falls within the green zone (11 to 30 VDC) the alarm state can display 'normal' as this is an acceptable operating value.
- **Critical:** If the value falls within the red zone (below 11 VDC or above 30 VDC) the alarm state can display 'critical' as these values are the hardware limits of the radio (the radio may switch off or self protect depending on the extremity of the critical value).

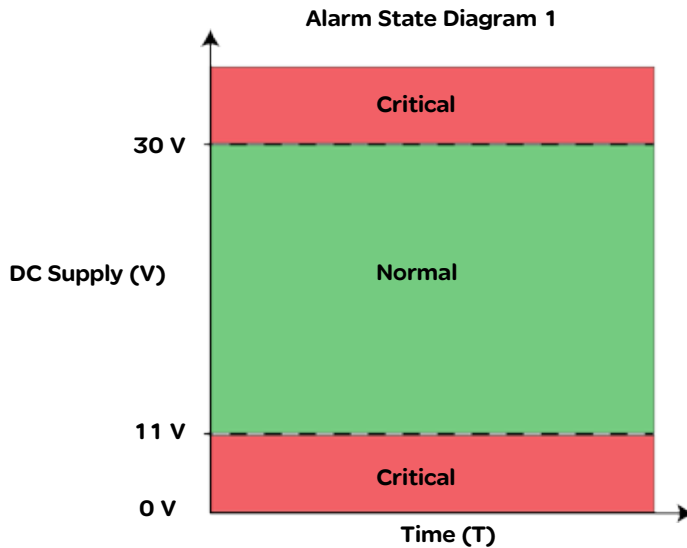

**Warning State**

Enable/Disable the warning state for the respective alarm being configured. The warning state can help prevent a critical alarm from occurring, by indicating an alarm value has been measured outside of 'normal' operating conditions, but, still within 'critical' operating conditions. This means a warning alarm can be active, before a critical alarm state is reached.

Once the warning alarm is enabled, a limit/threshold should be configured. The diagram below provides an example of how the warning alarm is implemented into the alarm state reporting structure for the DC supply in a QB. Once a DC supply measurement is taken, the behavior of the alarm state reporting structure is as follows:

- **Normal:** If the value falls within the green zone (12 to 28 V) the alarm state can display 'normal' as this is an acceptable operating value.
- **Warning:** If the value falls within the amber zone (11 to 12 V OR 28 to 30V) the alarm state can display 'warning' as this is has been configured by the user to be outside of normal operating conditions.
- **Critical:** If the value falls within the red zone (below 11 V or above 30 V) the alarm state can display 'critical' as these values are the hardware limits of the radio (the radio may switch off or self protect depending on the extremity of the critical value).

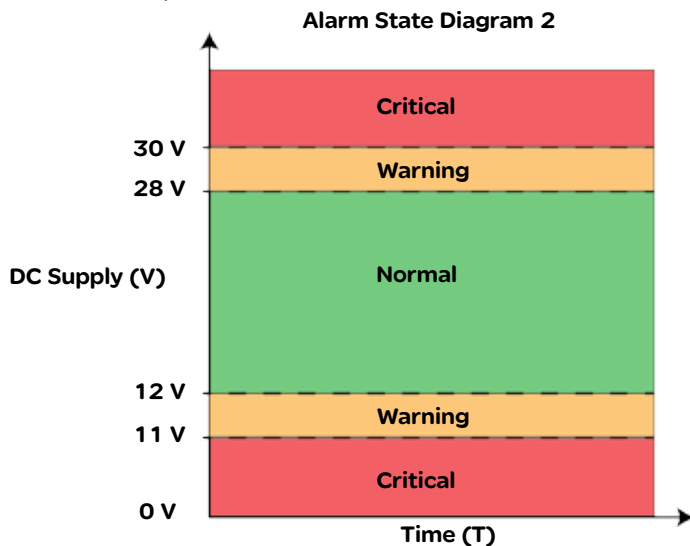

**DC Supply**

---

Warning Enable ▾

---

Upper

---

Lower

---

Alarm Output  Enable  Disable

## Alarm Specifications

To perform alarm configuration, go to: Setup -> Alarms

Global Alarm	
The global alarm reflects the highest severity state of all the alarm states being monitored. This can allow a user to monitor the global alarm state, and if/when the alarm state changes, a detailed review of the radio's operating condition can be performed.	
Subscriptions available	SNMP Notifications

Operational	
The operational alarm will display a critical state during situations that cannot be resolved by the user through factory default, configuration or firmware upgrade. While an operation alarm is critical, the radio's transmitter may become disabled.	
Subscriptions available	SNMP Notifications, Alarm Output

Temperature	
Units of measurement available	Celsius, Fahrenheit
State Change Hysteresis	1 Deg C (1.8 Deg F)
Subscriptions available	SNMP Notifications, Alarm Output
Critical Alarm	
Upper Critical Alarm Threshold	81 Deg C (177.8 Deg F)
Lower Critical Alarm Threshold	-40 Deg C (-40 Deg F)
Warning Alarm	
Default Upper Warning Alarm Threshold	70 Deg C (113 Deg F)
Default Lower Warning Alarm Threshold	-10 Deg C (14 Deg F)
Configurable Warning Alarm Threshold Range	-40 to 70 Deg C (-40 to 158 Deg F)

Frequency Offset	
Units of measurement available	Hz
State Change Hysteresis	5 Hz
Subscriptions available	SNMP Notifications
Warning Alarm	
Default Upper Warning Alarm Threshold	1000 Hz
Default Lower Warning Alarm Threshold	-1000 Hz
Configurable Warning Alarm Threshold Range	3000 to -3000 Hz

RSSI	
Units of measurement available	dBm
State Change Hysteresis	1 dBm
Subscriptions available	SNMP Notifications
Warning Alarm	
Default Upper Warning Alarm Threshold	-50 dBm
Default Lower Warning Alarm Threshold	-120 dBm
Configurable Warning Alarm Threshold Range	-140 to 0 dBm

<b>VSWR</b>	
Measurement taken	Ratio
Subscriptions available	SNMP Notifications, Alarm Output
<b>Critical Alarm</b>	
Upper Critical Alarm limit	10:1
<b>Warning Alarm</b>	
Default Warning Alarm Limit	3:1
Configurable Warning Alarm Limits	1.5:1, 2:1 or 3:1

<b>DC Supply</b>	
Units of measurement available	DC Volts
State Change Hysteresis	0.5V DC
Subscriptions available	SNMP Notifications, Alarm Output
<b>Critical Alarm</b>	
Upper Critical Alarm Threshold	30V DC
Lower Critical Alarm Threshold	10V DC
<b>Warning Alarm</b>	
Default Upper Warning Alarm Threshold	28V DC
Default Lower Warning Alarm Threshold	12V DC
Configurable Warning Alarm Threshold Range	10 to 30 V DC

<b>Ethernet Link</b>	
The Ethernet link monitor will send pings to a user defined IP address. The radio can raise a warning alarm, if a ping response is not received from the specified IP device.	
Subscriptions available	SNMP Notifications, Alarm Output
<b>Warning Alarm</b>	
Primary IP	The primary IP address to test
Secondary IP	The secondary IP address to test
Fail Threshold	The number of failed pings allowed before an alarm is raised
Retry Interval	The number of seconds to wait before retrying a failed ping

<b>Tx Power</b>	
Units of measurement available	dBm
State Change Hysteresis	2 dBm
Subscriptions available	SNMP Notifications
<b>Warning Alarm</b>	
A warning alarm can be raised if the radio detects a Tx power level which is +/- 2dBm of the target Tx power.	

<b>PLL Lock</b>	
A critical alarm can be raised if a PLL has been detected out of lock.	
Subscriptions available	SNMP Notifications, Alarm Output

**QB and Hot Standby Specific Alarm Specifications**

<b>Fan</b>	
A critical alarm can be raised if a fan alarm has been detected.	
Subscriptions available	SNMP Notifications, Alarm Output

<b>Base Health</b>	
The base health alarm is a warning indicator (alarm state can be either normal or warning), which is subscribed to the radio's alarm output. This can allow a user to monitor the base health alarm state, and if/when the alarm state changes, a detailed review of the radio's operating condition can be performed.	
Subscriptions available	SNMP Notifications

The following hot standby specific alarms can only be configured once HSC mode has been enabled within the radio. To enable HSC mode, go to: Setup -> Basestation

<b>Rx Packet Comparison</b>	
A hot standby radio can compare the amount of good packets received by radio A and radio B.	
A warning alarm can be raised if the differential between good packets received by the configured radio and good packets received by the alternate radio is greater than the specified differential. Primarily used in separate antenna arrangements.	
Subscriptions available	SNMP Notifications, Alarm Output
<b>Warning Alarm</b>	
Default Differential Value (%)	20 %

<b>RSSI Comparison</b>	
A hot standby radio can compare the level of RSSI received by radio A and radio B. A warning alarm can be raised if the reported RSSI of the configured radio is lower than the reported RSSI of the alternate radio by the specified margin (dB).	
An offset should be used where the configured radio has an expected reduced RSSI, compared to that of the alternate radio.	
The offset can help detect RSSI compare alarms more accurately within a Hot standby arrangement which utilises separate antennas for each radio.	
The Margin and Offset are configured as a negative number	
Subscriptions available	SNMP Notifications, Alarm Output
<b>Warning Alarm</b>	
Default Margin Value (dB)	-10 dB
Default Offset Value (dB)	0

## Alarm Subscription:

Services can be subscribed to alarm state changes for respective alarms. Depending on which service is enabled, a state change can either raise an alarm output, or, send a notification.

The diagram below provides an example of a DC supply dropping and recovering over time.

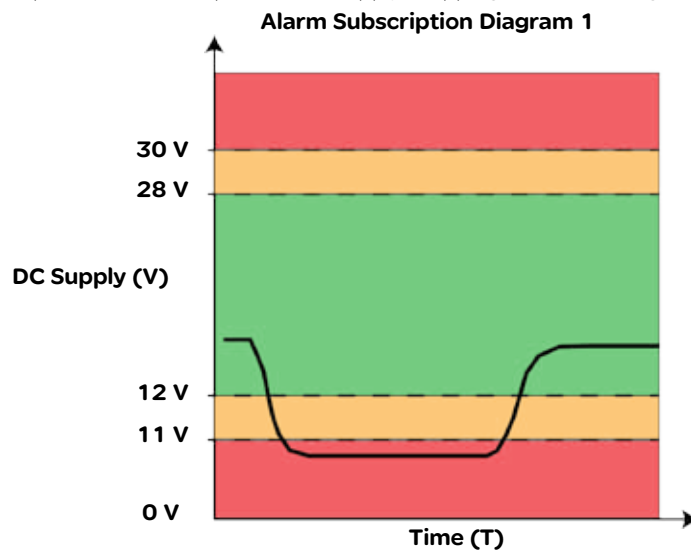

## SNMP

The SNMP notifications service can be subscribed to an alarm. This can cause an SNMP notification to be sent to the configured SNMP NMS each time a subscribed alarm changes state. Referring to the example above, an SNMP notification would be sent during each alarm state change.

The SNMP agent and notifications section should be enabled and configured (Setup -> SNMP) before the SNMP notification service can be subscribed to alarms (review the SNMP section for information on the SNMP agent configuration).

To subscribe the SNMP notification service to an alarm, go to Setup -> Alarms, and enable 'SNMP Notification' for the respective alarm being subscribed to.

### DC Supply

Warning	<input type="button" value="Enable"/>
Upper	<input type="text" value="28"/>
Lower	<input type="text" value="12"/>
SNMP Notification	<input checked="" type="radio"/> Enable <input type="radio"/> Disable
Alarm Output	<input type="radio"/> Enable <input checked="" type="radio"/> Disable

### Alarm Output

Available in QB & QP hardware only. The radio alarm output is an internal dual-state indicator (ON/OFF) which can control the dynamic changeover mechanism within a QH (QB with HSC mode enabled) and a QP.

By subscribing the alarm output service to an alarm, the alarm output will turn ON when any subscribed alarm has reached the highest level of alarm severity and will turn OFF when no subscribed alarms are in their highest level of alarm severity.

To subscribe the alarm output service to an alarm, go to Setup -> Alarms, and enable 'Alarm Output' for the respective alarm being subscribed to.

## DC Supply

Warning	Enable ▼
Upper	28
Lower	12
Alarm Output	<input checked="" type="radio"/> Enable <input type="radio"/> Disable

## Events

### Introduction

The Q data radios can log meaningful events that occur throughout the operation of the radio. These events are viewable within the monitoring section (Monitoring -> Alarms and Events).

Each event that is recorded includes the following information:

- **Time Stamp:** The time stamp is only accurate, when the time configuration has been set (Setup -> Network). If the time configuration has not been set, the default starting time for the radio will be used.
- **Event ID:** Each type of event has a unique event identification number. The event IDs and corresponding event descriptions are shown within tables on the following pages.
- **Severity:** There are different event severities depending on the respective event:
  - EVENT: This is an indicative event to record behaviour of the radio (i.e power up, firmware update).
  - NORMAL: This indicates that the recorded event is within acceptable operating conditions
  - WARNING: This indicates that the recorded event is within configured warning conditions
  - CRITICAL: This indicates that the recorded event may cause the radio to stop operating.
- **Notes:** Description of the event which has occurred.

The event log window can be cleared by selecting the 'Clear Logs' button at the top corner of the event log window.

Events				Clear Logs
24/11/1975 17:32:06	400	EVENT	Radio power up.	
24/11/1975 17:32:06	501	EVENT	Radio firmware installation successful	
26/11/1975 20:33:22	500	EVENT	Radio firmware installation activated. 1.2.6.3524 -> 1.2.6.3545	
24/11/1975 17:32:10	300	EVENT	Radio changed to online status.	
24/11/1975 17:32:08	301	EVENT	Radio changed to offline status.	
24/11/1975 17:32:06	400	EVENT	Radio power up.	
24/11/1975 17:32:10	300	EVENT	Radio changed to online status.	
24/11/1975 17:32:08	301	EVENT	Radio changed to offline status.	
24/11/1975 17:32:06	400	EVENT	Radio power up.	
24/11/1975 17:34:29	51	EVENT	Active critical alarms detected.	
24/11/1975 17:34:29	190	CRITICAL	Operational critical alarm detected.	
24/11/1975 17:33:21	300	EVENT	Radio changed to online status.	
24/11/1975 17:33:18	301	EVENT	Radio changed to offline status.	
24/11/1975 17:33:16	400	EVENT	Radio power up.	
24/11/1975 17:33:16	300	EVENT	Radio changed to online status.	

**Alarm Events:**

Event ID	Description
50	Active warning alarm detected
51	Active critical alarm detected
52	Active critical alarm cleared
53	Active warning alarm cleared
60	Base health alarm detected
61	Base health alarm cleared
100	Frequency offset warning detected
101	Frequency offset warning alarm cleared
110	Received signal level (RSSI) warning alarm detected
111	Received signal level (RSSI) warning alarm cleared
120	High VSWR warning alarm detected
121	High VSWR critical alarm detected
122	High VSWR critical alarm cleared
123	High VSWR warning alarm cleared
130	Transmit power target critical alarm detected
131	Transmit power target critical alarm cleared
140	DC supply warning alarm detected
141	DC supply critical alarm detected
142	DC supply critical alarm cleared
143	DC supply warning alarm cleared
150	Radio Temperature warning alarm detected
151	Radio Temperature critical alarm detected
152	Radio Temperature critical alarm cleared
153	Radio Temperature warning alarm cleared
160	Ethernet link warning alarm detected
161	Ethernet link warning alarm detected cleared
170	PLL Lock critical alarm detected
171	PLL Lock critical alarm cleared
180	FAN critical alarm detected
181	FAN critical alarm cleared
190	Operational critical alarm detected
191	Operational critical alarm cleared
200	Received good data warning alarm detected
201	Received good data warning alarm cleared
210	Good RSSI comparison warning alarm detected
211	Good RSSI comparison warning alarm cleared



**Hot Standby Specific Events:**

Event ID	Description
300	300 - Radio changed to online status
301	301 - Radio changed to offline status
310	310 - Radio forced to offline
311	311 - Radio forced to online
320	320 - Radio period change-over timer expired.

**Operational Events:**

Event ID	Description
400	Radio power up
401	User initiated radio reset
402	Watch dog initiated radio reset
403	NTP date/time locked
404	PTT timeout timer activated

**Management Events:**

Event ID	Description
500	Radio firmware installation activated
501	Radio firmware installation successful
502	Radio firmware installation unsuccessful
510	Factory default reset activated
511	Factory default reset successful
512	Factory default reset unsuccessful
520	Radio configuration change activated
521	Radio configuration change successful
522	Radio configuration change unsuccessful

## Base Station

---

### Introduction

Base station hardware (QP and QB) have specific configuration parameters for hardware specific features. To access these configuration parameters go to: Setup -> Basestation.

### HSC (Hot Standby Controller) Mode

Only configurable within a QB (a QP always has this enabled), this should be enabled when a QB is operating within a hot standby arrangement.

HSC Mode

Enable ▼

### Shared IP Address

Radio A and Radio B within a hot standby arrangement can be configured to 'share' an IP address. This is a separate IP address from each radio's unique IP address. The shared IP address can be used to access the current 'online' radio.

The shared IP address should be configured in radio A & B as the same IP address.

The shared IP address is only available once HSC mode is enabled (a QP always has HSC mode enabled).

Shared IP Mode

Enable  Disable

Shared IP

192.168.2.50

### General Purpose Digital I/O (GPIO)

The digital outputs can be configured to reflect the status of different operating conditions. By disabling either of the following parameters, the respective digital output can be set manually by the user (TView Diagnostics or SNMP can be used to set the digital output).

Output 1 Alternate Function - When enabled, digital output 1 will subscribe to the base health status (the base health alarm can reflect the status of the alarm output. See the alarms section for further detail). If the output is active, the base health alarm is in warning state.

Output 1 Alternate Function

Enable  Disable

Output 2 Alternate Function - When enabled, digital output 2 will reflect which radio of a hot standby arrangement is online.

When the output is inactive: Base A is online

When the output is active: Base B is online

Output 2 Alternate Function

Enable  Disable

**SNMP Notifications**

Configure basestation specific features to send SNMP notifications when a respective event occurs.

GPIO Inputs - By enabling SNMP notification on a GPIO input, the radio will send an SNMP notification to the NMS specified in the configured SNMP section (to access SNMP, go to: Setup -> SNMP), when the respective digital input state changes.

GPIO Input 1  Enable  Disable

GPIO Input 2  Enable  Disable

GPIO Input 3  Enable  Disable

Base Station Health - By enabling the Base Station Health SNMP notification, the radio will send an SNMP notification to the NMS specified in the configured SNMP section (to access SNMP, go to: Setup -> SNMP), when a change in alarm state for the base health alarm occurs.

Base Station Health  Enable  Disable

Base change over - By enabling the Base change over SNMP notification, the radio will send an SNMP notification to the NMS specified in the configured SNMP section (to access SNMP, go to: Setup -> SNMP), when a hot standby base change over occurs.

Base change over  Enable  Disable

**Advanced**

Periodic Switch Over Period - The period, in hours, after which the online base station will initiate an automatic switch over. This can be useful, to exercise each radio within a hot standby arrangement, to validate redundant link availability.

Setting a value of zero will disable this feature.

Periodic Switch Over Period

## Hot Standby Status

### Introduction

The active condition of a hot standby can easily be reviewed via the hot standby status window. To access this window, go to: Monitoring -> Hot Standby Status.

Alarms for a particular radio can be reset, by clicking the Reset button at the bottom of the respective radios alarms column.

## Hot Standby Status

Serial Number	790035	
Selection Mode	Site Forced	
Pending Switchover	<input type="checkbox"/>	
<b>Status</b>	<b>A</b>	<b>B</b>
Online	<input checked="" type="checkbox"/>	<input type="checkbox"/>
Health	<input checked="" type="checkbox"/>	<input type="checkbox"/>
<b>Alarms</b>	<b>A</b>	<b>B</b>
DC Supply	<input checked="" type="checkbox"/>	<input checked="" type="checkbox"/>
Tx Power <sup>1</sup>	<input type="checkbox"/>	<input type="checkbox"/>
Ethernet Link	<input type="checkbox"/>	<input type="checkbox"/>
Temperature	<input checked="" type="checkbox"/>	<input checked="" type="checkbox"/>
PLL lock <sup>1</sup>	<input checked="" type="checkbox"/>	<input checked="" type="checkbox"/>
Operational <sup>1</sup>	<input checked="" type="checkbox"/>	<input checked="" type="checkbox"/>
VSWR	<input checked="" type="checkbox"/>	<input checked="" type="checkbox"/>
Fan	<input checked="" type="checkbox"/>	<input checked="" type="checkbox"/>
RSSI Comparison <sup>2</sup>	<input checked="" type="checkbox"/>	<input type="checkbox"/>
Rx Packet Comparison <sup>2</sup>	<input checked="" type="checkbox"/>	<input type="checkbox"/>
	<input type="button" value="Reset"/>	<input type="button" value="Reset"/>

Not enabled  
 Normal  
 Recovered  
 Active

### Latched Alarms

Once some alarms within a radio have been detected in a their most severe state, the hot standby will no longer dynamically switch over to that radio, to help prevent switching over to a non-functional radio. These type of alarms are called 'Latching Alarms'.

Latching alarms may be reported in a recovered state, but will prevent the hot standby from dynamically changing over to the respective radio, until the alarms have been manually reset.

The list of latching alarms include:

- Tx Power
- PLL Lock
- Operational

A Manual changeover on the front panel switch, or remotely forces change-over, can over-ride, but not clear, a latched alarm.

## SNMP - Diagnostic objects and Notifications

---

### Introduction

The Q data radio's SNMP Interface supports:

- Supports RFC1 21 3 (Unit name, Unit Location, Firmware, Uptime, etc). Details about RFC1 21 3 and the SNMP parameters included in this standard can be found in this link : <http://www.ietf.org/rfc/rfc1 21 3.txt>
- Supports Radio and Ethernet Diagnostics (as seen in the HTML Diagnostics overview)
- SNMP V1 & V2c
- SNMP notifications which include traps and informs

### MIB Files

Distributed with the Q data radio firmware are two MIB files which provide structure definitions for the SNMP objects. The MIB files are suitable for importation into most common SNMP browsers. Definitions for each SNMP object are noted as comments in the MIB files. Only a summary of each object is noted in this user manual.

### SNMP user alarm detection

The Trio Q data radio range can detect a number of SNMP alarms which have been raised due to varying radio diagnostic values. These diagnostic values include:

- VSWR
- Supply Voltage
- Temperature
- RSSI
- Transmit Power

Each SNMP alarm for the diagnostic values shown above, has a maximum of three alarm states. Each one is also represented with a status number. The alarm states and corresponding numbers are as follows:

- **Normal state - 1:** The 'Normal' state will be displayed within an alarm when a diagnostics parameter is operating within normal limits.
- **User alarm state - 2:** A 'User alarm' state will be displayed when a diagnostics parameter within the Q data radio falls outside of the user defined alarm limits. User limits are configurable within the Q data radio.
- **Critical alarm state- 3:** A 'Critical alarm' state will be displayed when a diagnostics parameter within the Q data radio falls outside of the unit's hardware specification.

### SNMP critical alarm detection

The Trio Q data radio range can detect a number of SNMP alarms which have been raised due to the operational state of the radio. These operational states include:

- Transmitter PLL locked
- Receiver PLL locked
- Operational alarm detected
- Fan alarm detected (QB, QP & QH only)

Each SNMP alarm for the operational states shown above, has a maximum of two alarm states. Each one is also represented with a status number. The alarm states and corresponding numbers are as follows:

- **Yes state - 1:** The 'Yes' state will be displayed if the corresponding operational state is active/true.
- **No state - 2:** The 'No' state will be displayed if the corresponding operational state is inactive/false.

### Notifications

SNMP notifications are unsolicited SNMP messages designed to inform a user when an SNMP alarm state change has been detected. The Q data radio range supports two types of notifications:

- **Traps:** are low bandwidth consuming UDP notifications that have no requirement for a response. If the message is lost along the way to the destination IP address, the message will be lost.
- **Informs:** are essentially traps, that require a response from the destination IP address once a notification has been sent. This gives informs more reliability getting to a destination as the Q data radio range supports retries and time out periods.

## Summary of SNMP MIB Objects Supported

Object name	Object Identifier (OID)	Syntax	Object description
<b>General Group:</b>			
serialNumber	.1.3.6.1.4.1.33302.30.1.1.0	String	Serial number of the Q data radio
modelName	.1.3.6.1.4.1.33302.30.1.2.0	String	Model number of the Q data radio
hardwareRevision	.1.3.6.1.4.1.33302.30.1.3.0	String	Hardware revision of the Q data radio
firmwareRevision	.1.3.6.1.4.1.33302.30.1.5.0	String	The firmware revision the Q data radio
date	.1.3.6.1.4.1.33302.30.1.6.0	String	The date as reported by the Q data radio
time	.1.3.6.1.4.1.33302.30.1.7.0	String	The time as reported by the Q data radio
utcTimeOffset	.1.3.6.1.4.1.33302.30.1.8.0	String	Time offset from UTC for the Q data radio's local time zone
upTime	.1.3.6.1.4.1.33302.30.1.9.0	String	The uptime of the Q data radio
primaryNtpServer	.1.3.6.1.4.1.33302.30.1.10.0	String	Primary Network Time Protocol (NTP) domain name
cpuLoad	.1.3.6.1.4.1.33302.30.1.11.0	Integer	Average CPU utilisation (%) for the past 15 minutes
supplyVoltage	.1.3.6.1.4.1.33302.30.1.12.0	Integer	Supply Voltage of the Q data radio in mV
temperatureC	.1.3.6.1.4.1.33302.30.1.13.1.3.1	Integer	The internal temperature of the Q data radio (degrees C)
temperatureF	.1.3.6.1.4.1.33302.30.1.13.1.4.1	Integer	The internal temperature of the Q data radio (degrees F)
ipAddress	.1.3.6.1.4.1.33302.30.1.15.0	String	The IP address of the Q data radio.
<b>Radio Group:</b>			
radioReceivedPackets	.1.3.6.1.4.1.33302.30.2.3.0	Integer	Number of packets received from over the radio link
radioTrasnmittedPackets	.1.3.6.1.4.1.33302.30.2.4.0	Integer	Number of packets transmitted over the radio link
radioForwardPower	.1.3.6.1.4.1.33302.30.2.5.1.2.1	Integer	Level of transmit power (dBm)
radioReversePower	.1.3.6.1.4.1.33302.30.2.6.1.2.1	Integer	Level of reverse power (dBm)
radioVswr	.1.3.6.1.4.1.33302.30.2.7.1.2.1	Integer	VSWR
radioRssiValue	.1.3.6.1.4.1.33302.30.2.8.1.2.1	Integer	Radio RSSI value (dBm)
radioDataRate	.1.3.6.1.4.1.33302.30.2.15.0	Integer	The over-the-air data rate of the Q data radio. [Dynamic(0), 8000bps(1), 14000bps(2), 16000bps(3), 24000bps(4), 28000bps(5), 32000bps(6), 42000bps(7), 56000bps(8)]
txFrequency	.1.3.6.1.4.1.33302.30.2.18.0	Integer	Radio's transmit frequency (Hz).
rxFrequency	.1.3.6.1.4.1.33302.30.2.19.0	Integer	Radio's receive frequency (Hz).
muteThreshold	.1.3.6.1.4.1.33302.30.2.20.0	Integer	Radio's mute threshold (dBm).
rxGoodFrameCount	.1.3.6.1.4.1.33302.30.2.23.0	Integer	Good frames received.
rxGoodByteCount	.1.3.6.1.4.1.33302.30.2.24.0	Integer	Good bytes received.
rxBadFrameCount	.1.3.6.1.4.1.33302.30.2.25.0	Integer	Bad frames received.
rxAverageGoodFrameSize	.1.3.6.1.4.1.33302.30.2.26.0	Integer	Average received good frame size.
rxAverageFrameRate	.1.3.6.1.4.1.33302.30.2.27.0	Integer	Average receive frame rate.
rxChannelOccupancy	.1.3.6.1.4.1.33302.30.2.28.0	Integer	Receive channel occupancy.
rxSlidingChannelOccupancy	.1.3.6.1.4.1.33302.30.2.29.0	Integer	Sliding channel occupancy.
txByteCount	.1.3.6.1.4.1.33302.30.2.31.0	Integer	Transmitted byte counter.
txFrameCount	.1.3.6.1.4.1.33302.30.2.32.0	Integer	Transmit frame count.
txAverageFrameSize	.1.3.6.1.4.1.33302.30.2.33.0	Integer	Transmit average frame size.
txAverageFrameRate	.1.3.6.1.4.1.33302.30.2.34.0	Integer	Transmit average frame rate.
radioFrequencyError	.1.3.6.1.4.1.33302.30.2.36.0	Integer	Radio frequency error (Hz).

Object name	Object Identifier (OID)	Syntax	Object description
<b>Security Group:</b>			
snmpVersion	.1.3.6.1.4.1.33302.30.3.1.0	Integer	Default SNMP version
consoleLoginStatus1	.1.3.6.1.4.1.33302.30.3.2.0	Integer	Console login status for COM1
consoleLoginStatus2	.1.3.6.1.4.1.33302.30.3.3.0	Integer	Console login status for COM2
numberOfActiveTelnetSessions	.1.3.6.1.4.1.33302.30.3.4.0	Integer	Number of active Telnet sessions
telnetSessionTable	.1.3.6.1.4.1.33302.30.3.5	Integer	Table of Telnet and Ssh sessions
telnetSessionStatus	.1.3.6.1.4.1.33302.30.3.5.1.2*	Integer	Telnet or Ssh session status
telnetSessionIp	.1.3.6.1.4.1.33302.30.3.5.1.3*	String	Telnet or Ssh session remote ip address
encryptionStatus	.1.3.6.1.4.1.33302.30.3.11.0	Integer	Encryption status
<b>ETH Group:</b>			
interfaceName	.1.3.6.1.4.1.33302.30.4.1.1.2.x	String	Ethernet interface (row) name (where x is the Ethernet interface - 1 (ETH1), 2 (ETH2) or 3 (ETH3))
interfaceStatus	.1.3.6.1.4.1.33302.30.4.1.1.3.x	Integer	Ethernet interface status (where x is the Ethernet interface - 1 (ETH1), 2 (ETH2) or 3 (ETH3))
interfaceSpeed	.1.3.6.1.4.1.33302.30.4.1.1.4.x	Integer	Ethernet interface link speed (where x is the Ethernet interface: 1 (ETH1), 2 (ETH2) or 3 (ETH3))
interfaceMode	.1.3.6.1.4.1.33302.30.4.1.1.5.x	Integer	Ethernet interface link mode (where x is the Ethernet interface - 1 (ETH1), 2 (ETH2) or 3 (ETH3))
<b>Base Station Group:</b>			
digitalInputTable	.1.3.6.1.4.1.33302.30.6.2	Table of base station digital inputs.	
digitalOutputTable	.1.3.6.1.4.1.33302.30.6.3	Table of base station digital outputs.	
chassisFanStatusTable	.1.3.6.1.4.1.33302.30.6.4	Table of chassis fan status.	
internalOnlineModule	.1.3.6.1.4.1.33302.30.6.5.0	Internal current online module. When operating in full duplex mode, this is the primary unit. When operating in protected half duplex mode, this is the unit that is currently online.	

<b>Alarm Group:</b>			
operationalAlarm	.1.3.6.1.4.1.33302.30.5.1.0	Integer	Operational alarm
rxPllLocked	.1.3.6.1.4.1.33302.30.5.2.0	Integer	Receiver PLL lock status
radioVswrAlarmState	.1.3.6.1.4.1.33302.30.5.10.1.2.1	Integer	High VSWR Normal =Operating within normal conditions, UserAlarm =Operating outside of user specified limits, CriticalAlarm =Operating outside of specified operating limits.
externalSupplyVoltageAlarmState	.1.3.6.1.4.1.33302.30.5.11.0	Integer	External supply voltage Normal =Operating within normal conditions, UserAlarm =Operating outside of user specified limits, CriticalAlarm =Operating outside of factory specified operating limits.
temperatureAlarmState	.1.3.6.1.4.1.33302.30.5.12.0	Integer	Internal temperature. Normal =Operating within normal conditions, UserAlarm =Operating outside of user specified limits, CriticalAlarm =Operating outside of specified operating limits.
radioRssiAlarmState	.1.3.6.1.4.1.33302.30.5.13.1.2.1	Integer	RSSI Normal =Operating within normal conditions, UserAlarm =Operating outside of user specified limits.
radioTxPowerAlarmState	.1.3.6.1.4.1.33302.30.5.14.1.2.1	Integer	Tx Power Normal =Operating within normal conditions, UserAlarm =Operating outside of user specified limits
globalAlarmState	.1.3.6.1.4.1.33302.30.5.15.0	Integer	Global Monitored Alarm. Normal =All monitored parameters are operating within normal conditions, UserAlarm =One or more monitored parameters are operating outside of user specified limits, CriticalAlarm =One or more monitored parameters are operating outside of factory specified operating limits.
txPllLocked	.1.3.6.1.4.1.33302.30.5.17.0	Integer	Transmit PLL lock status
radioFrequencyAlarmState	.1.3.6.1.4.1.33302.30.5.18.0	Integer	Frequency error state. Normal =Operating within normal conditions, UserAlarm =Receive frequency error out of user specified limits.



## SNMP - User Alarm Object Specifications

Global alarm detection can change alarm state, based on the highest active alarm state (1 Normal state, 2 User alarm state, 3 Critical alarm state) of all the other SNMP alarm detection objects within the alarm group (with the exception of operational alarm).

Global Alarm Detection	
Name	globalAlarm
Alarm states	Normal (1), User alarm (2) and Critical alarm (3)

VSWR Alarm Detection	
Name	radioVswrAlarmState
Alarm states	Normal (1), User alarm (2) and Critical alarm (3)
User alarm limits	Optional limit, 1.5:1, 2:1 or 3:1
Critical alarm limits	hardware limit: >10:1.
Hysteresis	None

External Supply Voltage Alarm Detection	
Name	externalSupplyVoltageAlarmState
Alarm states	Normal (1), User alarm (2) and Critical alarm (3)
User alarm limits	Configurable upper and lower limit, 10000 to 30000 (mVDC)
Critical alarm limits	Lower hardware limit: 9500 (mVDC), Upper hardware limit: 30500 (mVDC)
Hysteresis	+/- 500 (mVDC)

Radio Temperature Alarm Detection	
Name	temperatureAlarmState
Alarm states	Normal (1), User alarm (2) and Critical alarm (3)
User alarm limits	Configurable upper and lower limit, -40 to +70 (Deg C)
Critical alarm limits	Upper hardware limit: +75 (Deg C). (No lower limit)
Hysteresis	+/- 5 (Deg C)

Radio RSSI Alarm Detection	
Name	radioRssiAlarmState
Alarm states	Normal (1) and User alarm (2)
User alarm limits	Configurable upper and lower limit, -140 to 0 (dBm)
Hysteresis	+/- 10 (dBm)

Radio Transmit Power Alarm Detection	
Name	radioTxPowerAlarmState
Alarm states	Normal (1) and User alarm (2)
User alarm limits	Configurable upper and lower limit, 0 to +40 (dBm)
Hysteresis	+/- 10 (dBm)

## SNMP - Critical Alarm Object Specifications

<b>Operational Alarm Detection</b>	
Name	operationalAlarm
Alarm states	Yes (1), No (2)
Alarm limits	No limits, if the radio go into a operational alarm state, the object changes alarm state to Yes (1). during normal operation, this alarm state in No (2)

<b>Receiver PLL Lock Alarm Detection</b>	
Name	rxPllLocked
Alarm states	Yes (1), No (2)
Alarm limits	No limits, if the radio detects the receiver PLL is out of lock, the object changes alarm state to Yes (1). during normal operation, this alarm state in No (2)

<b>Transmitter PLL Lock Alarm Detection</b>	
Name	txPllLocked
Alarm states	Yes (1), No (2)
Alarm limits	No limits, if the radio detects the transmitter PLL is out of lock, the object changes alarm state to Yes (1). during normal operation, this alarm state in No (2)

## SNMP - Notifications

Customisations can be made on which SNMP alarms will be detected, along with the user alarm limits which will trigger an alarm state change and can be sent as a notification.

To configure which alarms are to be detected or to configure the limits of a user alarm state change, see the user alarm management section found within the SNMP page of the Q data radio web user interface. Specifications on alarms which can be sent as notifications, can be found within the tables below:

### Global Alarm Detection Notification

The global alarm detection notification can be sent when the global alarm state is changed. The global alarm state will change based on the highest active alarm state (1 Normal state, 2 User alarm state, 3 Critical alarm state) of all of the alarm objects shown in the table below. When a global alarm detection notification is sent, the notification will include all of the alarm objects and their alarm states, shown in the table below.

Global Alarm Detection Notification				
Notification Name	notificationGloalAlarmChanged			
Notification OID	.1.3.6.1.4.1.33302.30.10.12			
Global Alarm Detection Notification Objects				
Name	OID	Position	Specific Code	Description
globalAlarmState	.1.3.6.1.4.1.33302.30.5.15.0	0	12	Global alarm state
externalSupplyVoltageAlarmState	.1.3.6.1.4.1.33302.30.5.11.0	1	12	Supply voltage alarm state
temperatureAlarmState	.1.3.6.1.4.1.33302.30.5.12.0	2	12	Temperature alarm state
rxPllLocked	.1.3.6.1.4.1.33302.30.5.2.0	3	12	Receiver PLL lock alarm state
txPllLocked	.1.3.6.1.4.1.33302.30.5.17.0	4	12	Transmit PLL lock alarm state
radioFrequencyErrorState	.1.3.6.1.4.1.33302.30.5.18.0	5	12	Radio frequency error alarm state
radioTxPowerAlarmState	.1.3.6.1.4.1.33302.30.5.14.1.2.1	6	12	Radio Tx power alarm state
radioVswrAlarmState	.1.3.6.1.4.1.33302.30.5.10.1.2.1	7	12	VSWR alarm state
radioRssiAlarmState	.1.3.6.1.4.1.33302.30.5.13.1.2.1	8	12	Radio RSSI alarm state

### Diagnostics Heartbeat Notification

The diagnostics heartbeat notification does not rely on a change of state in order to send a notification. Instead, the diagnostics heartbeat will send a notification periodically, based on a time period, specified by the user. In each notification sent, the values for each of the embedded objects (shown in the table below) will be sent.

Diagnostics Heartbeat Notification				
Notification Name	notificationDiagnostic			
Notification OID	.1.3.6.1.4.1.33302.30.10.13			
Diagnostics Heartbeat Notification Objects				
Name	OID	Position	Specific Code	Description
sysName	.1.3.6.1.2.1.1.5.0	0	13	System name
sysLocation	.1.3.6.1.2.1.1.6.0	1	13	System location
serialNumber	.1.3.6.1.4.1.33302.30.1.1.0	2	13	Radio serial number
modelName	.1.3.6.1.4.1.33302.30.1.2.0	3	13	Radio model number
supplyVoltage	.1.3.6.1.4.1.33302.30.1.12.0	4	13	Supply voltage value
sysUpTime	.1.3.6.1.2.1.1.3.0	5	13	System up time
globalAlarmState	.1.3.6.1.4.1.33302.30.5.15.0	6	13	Global alarm state
radioFrequencyError	.1.3.6.1.4.1.33302.30.2.36.0	7	13	Radio frequency error
temperatureC	.1.3.6.1.4.1.33302.30.1.13.1.3.1	8	13	Temperature value (Celsius)
temperatureF	.1.3.6.1.4.1.33302.30.1.13.1.4.1	9	13	Temperature value (Fahrenheit)
radioRssiValue	.1.3.6.1.4.1.33302.30.2.8.1.2.1	10	13	radio RSSI value
radioForwardPower	.1.3.6.1.4.1.33302.30.2.5.1.2.1	11	13	Radio Tx power value
radioVswr	.1.3.6.1.4.1.33302.30.2.7.1.2.1	12	13	VSWR value

Operational Alarm Detection Notification				
Notification Name	notificationOperationalAlarm			
Notification OID	.1.3.6.1.4.1.33302.30.10.1			
Operational Alarm Detection Notification Objects				
Name	OID	Position	Specific Code	Description
operationalAlarm	.1.3.6.1.4.1.33302.30.5.1.0	0	1	Operational alarm state

PLL Lock Alarm Detection Notification				
Notification Name	notificationPllLock			
Notification OID	.1.3.6.1.4.1.33302.30.10.2			
PLL Lock Notification Objects				
Name	OID	Position	Specific Code	Description
rxPllLocked	.1.3.6.1.4.1.33302.30.5.2.0	0	2	Receiver PLL lock alarm state
txPllLocked	.1.3.6.1.4.1.33302.30.5.17.0	1	2	Transmit PLL lock alarm state

VSWR Alarm Detection Notification				
Notification Name	notificationVswr			
Notification OID	.1.3.6.1.4.1.33302.30.10.4			
VSWR Notification Objects				
Name	OID	Position	Specific Code	Description
radioVswrAlarmState	.1.3.6.1.4.1.33302.30.5.10.1.2.1	0	4	VSWR alarm state
radioVswr	.1.3.6.1.4.1.33302.30.2.7.1.2.1	1	4	VSWR value

Temperature Alarm Detection Notification				
Notification Name	notificationTemperature			
Notification OID	.1.3.6.1.4.1.33302.30.10.5			
Temperature Notification Objects				
Name	OID	Position	Specific Code	Description
temperatureAlarmState	.1.3.6.1.4.1.33302.30.5.12.0	0	5	Temperature alarm state
temperatureC	.1.3.6.1.4.1.33302.30.1.13.1.3.1	1	5	Temperature value (Celsius)
temperatureF	.1.3.6.1.4.1.33302.30.1.13.1.4.1	2	5	Temperature value (Fahrenheit)

Supply Voltage Alarm Detection Notification				
Notification Name	notificationSupplyVoltage			
Notification OID	.1.3.6.1.4.1.33302.30.10.6			
Supply Voltage Notification Objects				
Name	OID	Position	Specific Code	Description
externalSupplyVoltageAlarmState	.1.3.6.1.4.1.33302.30.5.11.0	0	6	Supply voltage alarm state
supplyVoltage	.1.3.6.1.4.1.33302.30.1.12.0	1	6	Supply voltage value

RSSI Alarm Detection Notification				
Notification Name	notificationRssi			
Notification OID	.1.3.6.1.4.1.33302.30.10.7			
RSSI Alarm Detection Notification Objects				
Name	OID	Position	Specific Code	Description
radioRssiAlarmState	.1.3.6.1.4.1.33302.30.5.13.1.2.1	0	7	Radio RSSI alarm state
radioRssiValue	.1.3.6.1.4.1.33302.30.2.8.1.2.1	1	7	Radio RSSI value

Transmit Power Alarm Detection Notification				
Notification Name	notificationTxPower			
Notification OID	.1.3.6.1.4.1.33302.30.10.8			
Transmit Power Alarm Detection Notification Objects				
Name	OID	Position	Specific Code	Description
radioTxPowerAlarmState	.1.3.6.1.4.1.33302.30.5.14.1.2.1	0	8	Radio Tx power alarm state
radioForwardPower	.1.3.6.1.4.1.33302.30.2.5.1.2.1	1	8	Radio Tx power value

Frequency Error Alarm Detection Notification				
Notification Name	notificationFrequencyErrorChanged			
Notification OID	.1.3.6.1.4.1.33302.30.10.14			
Frequency Error Alarm Detection Notification Objects				
Name	OID	Position	Specific Code	Description
radioFrequencyErrorState	.1.3.6.1.4.1.33302.30.5.18.0	0	14	Radio frequency error alarm state
radioFrequencyError	.1.3.6.1.4.1.33302.30.2.36.0	1	14	Radio frequency error value

## SNMP - QB, QP &amp; QH Specific Notifications

Digital Input 1 Notification				
Notification Name	notificationDigitalInput1Notification			
Notification OID	.1.3.6.1.4.1.33302.30.10.20			
Digital Input 1 Notification Objects				
Name	OID	Position	Specific Code	Description
digitalInput	.1.3.6.1.4.1.33302.30.6.2.1.2.1	0	20	Digital input 1 value

Digital Input 2 Notification				
Notification Name	notificationDigitalInput2Notification			
Notification OID	.1.3.6.1.4.1.33302.30.10.21			
Digital Input 2 Notification Objects				
Name	OID	Position	Specific Code	Description
digitalInput	.1.3.6.1.4.1.33302.30.6.2.1.2.2	0	21	Digital input 2 value

Digital Input 3 Notification				
Notification Name	notificationDigitalInput3Notification			
Notification OID	.1.3.6.1.4.1.33302.30.10.22			
Digital Input 3 Notification Objects				
Name	OID	Position	Specific Code	Description
digitalInput	.1.3.6.1.4.1.33302.30.6.2.1.2.3	0	22	Digital input 3 value

Fan Alarm Detection Notification				
Notification Name	notificationFanAlarmChanged			
Notification OID	.1.3.6.1.4.1.33302.30.10.23			
Fan Alarm Detection Notification Objects				
Name	OID	Position	Specific Code	Description
chassisFanStatus	.1.3.6.1.4.1.33302.30.6.4.1.3.1	0	23	Fan 1 Status
chassisFanStatus	.1.3.6.1.4.1.33302.30.6.4.1.3.2	1	23	Fan 2 Status

## E-Series Mode Compatibility

---

The Trio Q data radio can be configured to operate in an E-Series radio network.

To configure the Q to operate in E-Series compatibility mode, browse into the radios configuration page and go to: Setup -> Radio. Within the Modulation section change Compatibility to E Data Radio Mode.

### Modulation

---

Compatibility

E Data Radio Mode ▼

Select the appropriate modulation type to suit the country of approval (FCC, ETSI, ACA), radio channel bandwidth (12.5kHz or 25kHz), Radio Mode (E Series) and over the air speed (9600bps or 19k2bps).

Type

9600bps 12.5kHz ACA 4 Level ▼

When E Data Radio Mode has been selected, the radio's configuration parameters will change to that of an E-Series radio. Radio configuration is still performed via WUI or TUI (not via TView+ Programmer).

For detailed information on E-Series parameters, refer to the E-Series user manual.

## Security

---

### AES Encryption

---

When encryption is enabled in a network, all data sent over the air is encrypted and can only be read by radios sharing the same Encryption Key. Encryption must be enabled in each radio in a network. The encryption key is 256 bits long and is entered as string or a hexadecimal number. For maximum security the chosen key should be one that is difficult for an intruder to guess.

Once written into the radio using the programmer, it is not possible to read the encryption key so care must be taken to record the key in a safe place.

#### Encryption Key: String

For a string type of key, use up to a maximum of 64 printable characters. Observe that the key is case sensitive.

Some examples are:

TRIO2012

Murray River Region

#### Encryption Key: Hexadecimal Number

Hexadecimal numbers can have a value of 0 to 15 and are represented by 0-9 and A, B, C, D, E or F.

A hexadecimal key begins with 0x and has up to 64 digits following.

Use an even number of hexadecimal digits.

Some examples are:

0x1234

0x123456789ABCDE

0x11111111222222223333333344444444 up to 64 digits

Configuration of AES is done via Setup -> Security

### Encryption

---

Encryption

AES ▼

Shared Key

.....



# Part I – Installation & Commissioning

## Introduction

All Q data radios need to be properly installed and commissioned in order to function reliably. Installers should be familiar with RF products / installations and are equipped with appropriate tools necessary to help ensure the ongoing reliability of a communications system.

This is a short form guide to assist with the correct installation and commissioning of Q data radios and help ensure that useful tests are made and recorded at each site for future reference should an issue arise.

Installers should check that each Q data radio has been programmed to suit their requirements before installation.

Installations play a role in network performance. The installation should be performed in a professional manner with careful consideration to the following items:

1. Adequate primary power cable - relative to the length of cable to minimise voltage drop.
2. Shielded CAT-5 or CAT-6 Ethernet patch cable between the Q data radio and any external Ethernet equipment.
3. Shielded RS-232 data cable between the Q data radio and any external RS-232 equipment.
3. Low loss coax used for antenna feed line.
4. Careful termination of RF connectors.
5. A suitable antenna for the requirement.
6. Suitable placement of the antenna.
7. Adequate signal strength from the master radio.

## TYPICAL INSTALLATION OVERVIEW

The following information should assist when installing and commissioning a Q data radio Ethernet system.

### DATA CONNECTION

In industrial environments connection to any external device should be by shielded CAT-5 or CAT-6 patch cable. A cables should be routed with strain relief.

### MOUNTING

The radio modem should be mounted in a cool, dry, and vibration free environment. Mounting of the unit should be in a location providing easy access to mounting screws and all connections. Q Data radios can operate within a -40 to +70°C (-40 to 158°F) ambient environment.

### POWER SUPPLY REQUIREMENTS (QR450)

Rated Operating Voltage: 10 to 30V DC  
 Input Power (Rx typical): 5 Watts  
 Input Power (Tx typical): (See table below)

Tx Power (dBm)	Typical Input Power (Watts)
30	22
37	37
40	51

The QR450 is supplied with a lock-in mating DC power connector which should be installed with the locking screws done up tightly (0.5 - 0.6 Nm / 4.42 - 5.31 ftin ).

Phoenix Contact Part Number 1777989.

The radio is designed to limit damage if the voltage exceeds 30V DC or if reverse polarity is applied. The field replaceable internal fuse has a 7 Amp rating.

### POWER SUPPLY REQUIREMENTS (QB450)

Operating Voltage: 11 to 30V DC (Dual Input)  
 Input Power (Rx typical): 35 Watts  
 Input Power (Tx typical): (See table below)

Tx Power (dBm)	Typical Input Power (Watts)
30	55
37	71
40	85

In high ambient temperature situations, the internal fans may operate, resulting in an increase of input power of up to 28 Watts.

Typical receive/standby input power is 35 Watts. The input power will vary in transmit mode according to RF output power level.

The QB450 is supplied with a lock-in mating DC power connector which should be installed with the locking screws done up tightly (0.5 - 0.6 Nm / 4.42 - 5.31 ftin ).

The radio is designed to limit damage if the voltage exceeds the operating voltage or if reverse polarity is applied. The field replaceable internal fuse has a 12 Amp rating.

**NOTICE**

**HAZARD OF EQUIPMENT DAMAGE**

The radio modem can be damaged if there is any potential difference between the chassis-ground, RS232 signal ground, power (-) input, or antenna coaxial shield. Before connecting any wiring, ensure all components are earthed to a common ground point.

**Failure to follow these instructions can result in equipment damage.**

Connect and secure the Antenna, Ethernet and Serial plugs BEFORE applying power to the unit. Lastly, before inserting the power plug, re-check that the terminals being used, polarity and voltage on the DC power plug is correct using a multimeter and check the power cable against the +/- label on the power input socket.

### COAX CABLE CONNECTION

Select the appropriate cable and connectors for each application; selection can impact on the performance of the system.

As an example, for each 3dB of cable and connector loss, half the transmitter power is lost and twice the receiver signal power is required to produce the same RF link performance.

In some installations where strong signals are present, a compromise of cable and connector cost may be acceptable.

All connector terminations should be performed as per the manufacturer's specifications; and if connectors are to be used outside, use a sealant such as amalgamating tape to seal connectors. Acetic cure silicon to seal the connectors is not advised.

Coax cables should not be stressed by tight bends, kinking or excessive flexing. Ensure that coax cables have sufficient strain relief and are secure. If large-diameter rigid or semi rigid cable is used, it is recommended to use a short length of high quality RG223 cable between the unit and main cable feed.

**ANTENNA INSTALLATION**

The selection of antennas and their placement can influence RF link quality.

Antennas are generally mounted to a vertical pole with either vertical or horizontal polarisation as per the license requirement.

Antennas should be mounted as high as practical and away from metal surfaces which can cause reflections.

As a typical generic example for selecting the suitable antenna type, Point to Multipoint (PTMP) systems generally employ high gain (3, 6, or 9dB gain) omni directional antennas at the Entry Point/Repeater sites and either omni directional whips (unity gain) or preferably high gain directional yagi antennas (9 or 14dB gain) at the remote sites.

**YAGI ANTENNAS**

Yagi antennas not only provide signal gain and directivity, but also provides protection from interfering signals which are outside the beam width of the antenna. Yagi antennas help provide optimum performance when communicating over very long distances.

Yagi antennas are polarised and need to be mounted either vertically (elements pointing from the ground to the sky) or horizontally (elements in parallel with the horizon).

When mounting yagi antennas with vertical polarisation, it should be noted that some antennas have a drain hole in the dipole (loop section of antenna). The small drain hole on one end of the dipole must be pointed towards the ground so that water will drain out of the antenna.

**OMNI DIRECTIONAL ANTENNAS**

Omni directional antennas provide a radiation pattern of equal strength through 360° in the horizontal plane. This makes them ideal for Entry Point /Repeater radio antennas in point to multipoint systems because they can reach a large populous of remote sites.

Omni directional antennas are also used at remote sites (although yagi antennas are preferred) and are typically ground independent whip type antennas. The main reason for using whips at remote sites is for aesthetics as they are far less obtrusive than a yagi.

Regardless of the type, antennas need to be mounted properly and in a suitable location as covered below.

**ANTENNA PLACEMENT**

Antenna placement is of paramount importance and plays a big part of the antennas and in turn systems performance.

When choosing antenna locations the aim is to find the largest path of unobstructed space and locate the antennas within that space. Locate the antennas as high as possible and clear of any obstructions.

Where possible, avoid mounting antennas:

1. Against or adjacent to steel structures.
2. In an area which will have intermittent obstructions - people walking past, vehicles driving past etc. That is, mount antennas well above such moving obstructions.
3. Near any electrical equipment.
4. Near metal beams, structures etc.
5. Inside any metal enclosures, tin sheds / warehouses etc. - (Some meshed wire fences act like a “brick wall” to RF transmissions).
6. Away from guard rails or support beams.
7. Above any pipe work or corrugated iron roofs.

Sometimes installations in such environments are unavoidable and where this is the case, certain care can be taken to still help ensure a reliable installation.

If tests indicate poor signal strength then the antennas at one or both ends of the link should be raised, and/ or moved clear of obstructing objects, or if directional antennas are employed they should be checked for correct directional orientation and polarisation (horizontal or vertical signal orientation).

**LED Indicators**

LED indicators are documented in Part E - Quick Reference Guide - Hardware of this User Manual. However, during the installation process check that the LED indicators are operating correctly.

**DC POWER**

If all the LEDs are off, no DC power is reaching the radio modem or the fuse is open. Successful power-up is indicated by the “Pwr/Tx” LED showing a continuous GREEN state.

When the transmitter is active the “Pwr/Tx” LED turns RED.

**Sync/No RX LED Indicator**



The “Sync/NoRx” LED is used to indicate the state of the receiver.

A solid or regular flashing GREEN LED shows that the modem is receiving decodable data.

A solid or flashing RED LED indicates the modem is receiving un-decodable data, this is typically from an unwanted source.

**ETH port LED Indicators**

See the table below for Ethernet port LED indicators.

ETH1/2 LEDs	
Ethernet port inactive, no cable connected	
Ethernet port active @ 10Mbps	
Ethernet port active @ 100Mbps	

**Optimising the Antenna for Rx Signal**

When using a directional antenna, it will be necessary to align the antenna to achieve optimal received signal. This can be done using TVView+ Diagnostics (measured RSSI) or by measuring the RSSI output on Pin 9 of the serial com port.

This can be done by using the (0-5Vdc) output on Pin 9 of the serial com port to indicate signal strength (RSSI). This voltage can be converted to dBm using the chart below.

The RSSI output is a latched value of the received signal which is updated every 100mS.

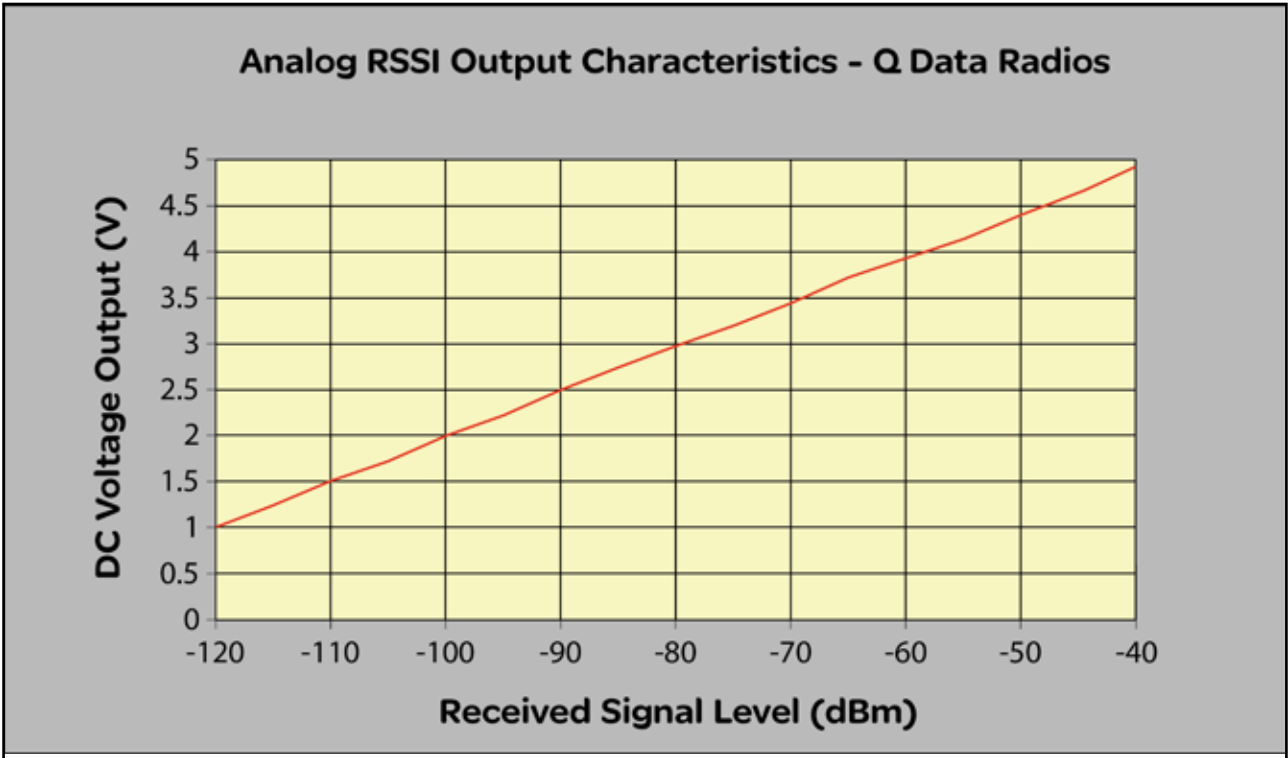
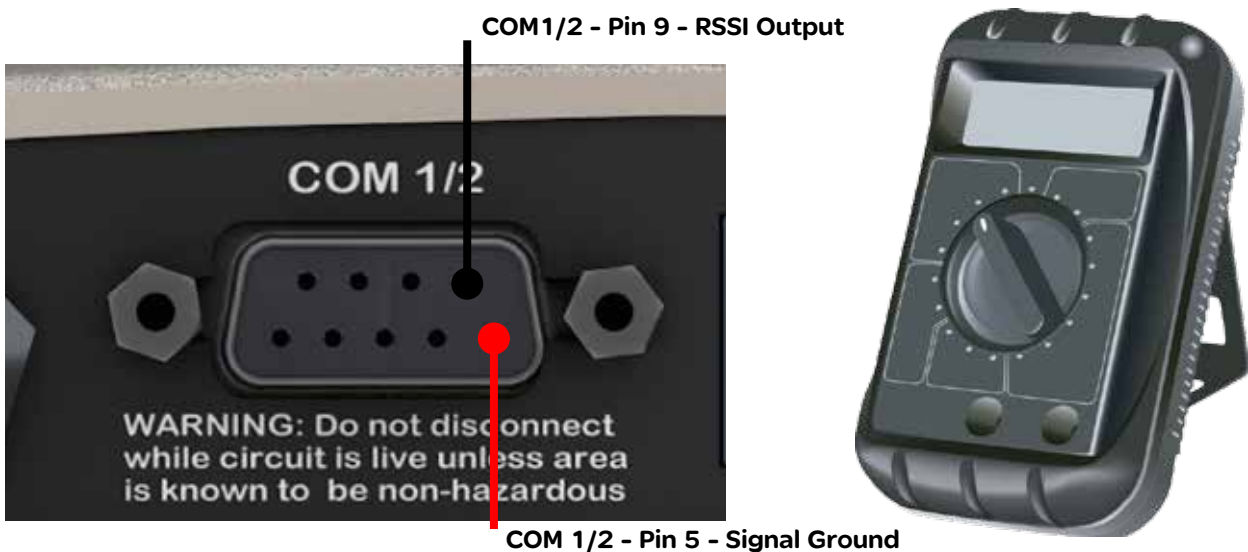

Chart is approximate only.



## Commissioning

When commissioning an Ethernet radio network, ensure that the incoming received signal strength (RSSI) is adequate to provide reliable communications.

In order for a system to operate reliably, an “adequate” signal level needs to be present which allows for fading and interference.

An adequate level is typically 20 to 30dB above the minimum threshold of the receiving device. Using the dynamic RF data rate can allow the minimum threshold specification to be taken from the lowest available data rate of the bandwidth being used.

Should this level not be achieved, then either;

1. A more suitable location to mount the antenna.
2. The antenna will need to be mounted higher in a more prominent location to achieve as close as possible to clear line of site.

## HTML Diagnostics

### Overview

After the Q data radios have been configured and installed, the next step in the commissioning process is to review the HTML diagnostics available in every radio. Diagnostic parameters available are shown in the image below:

Unit	
Date	Thu Jan 1 02:32:26 1970
Up Time (sec)	914674
CPU Load	0.64
Network	
Eth0 Rx Packets	0
Eth0 Rx Bytes	0
Eth0 Tx Packets	2
Eth0 Tx Bytes	166
Eth1 Rx Packets	0
Eth1 Rx Bytes	0
Eth1 Tx Packets	4
Eth1 Tx Bytes	216
Radio	
Radio Rx Packets	22948
Radio Rx Bytes	2456778
Radio Tx Packets	110
Radio Tx Bytes	47225
Radio Reverse Power (dBm)	12.0
Radio Forward Power (dBm)	20.2
Radio RSSI (dBm)	-58.6
Supply Volts	11.9
Radio Temperature (C)	26.1
Radio Synced	Yes
Last Sync Count	2
Failed Tokens	0
Retired Packets	0
Failed Packets	0

### Unit Specific:

Date: Specifies the current date and time. For the date and time to be correct the radio needs to be configured to synchronise with a NTP Time Server.

CPU Load: Specifies the amount of CPU load the linux based kernel is experiencing.

### Network Specific:

ETH 1 Rx Packets: The number of Ethernet packets received on ETH1.

ETH 1 Rx Bytes: The number of bytes received on ETH1.

ETH 1 Tx Packets: The number of Ethernet packets transmitted on ETH1.

ETH 1 Tx Bytes: The number of Ethernet packets received on ETH1.

(The same applies for ETH2)

### Radio Specific:

Radio Rx Packets: The number of packets received by the radio.

Radio Rx Bytes: The number of bytes received by the radio.

Radio Tx Packets: The number of packets transmitted by the radio.

Radio Tx Bytes: The number of bytes transmitted by the radio.

Radio Reverse Power (dBm) : TX Reverse power measured in dBm.

Radio Forward Power (dBm): TX Forward power measured in dBm.

Radio RSSI (dBm): The RSSI (Received Signal Strength Indicator) measured in dBm.

Supply Volts: The DC supply voltage measured in dBm.

Radio Temperature (C): The internal radio temperature measured in degrees Celsius.

Retired Packets: The number of packets that were discarded after ARQ retries and time outs were exhausted.

Failed Packets: The number of incoming packets that have failed CRC check and have been discarded.

# Part J – Firmware Updating and Maintenance

## Firmware Updating

### Introduction

Schneider Electric work towards providing enhancements and improvements to the firmware for the Q data radios. It is recommended that you keep the Q data radios up to date with the latest firmware releases.

The following instructions can be used to upgrade firmware in any Q Data Radio.

Using a standard web browser you can connect to a Q data radio and inspect the current firmware version which is displayed on the home page of the Web User Interface.

For new firmware updates which may be beneficial to your system, check the Schneider Electric licensed radio telemetry web site:  
<http://www.schneider-electric.com/products/ww/en/6000-telemetry-remote-scada-systems/6010-data-radios/61419-trio-licensed-radios/?BUSINESS=1>

Download the firmware pack from the website and store it on your PC or in a location on your computer network which can be accessed during the firmware update process.

Firmware updates can be performed on a unit connected locally to the PC or remotely via an operational radio link. For a local upgrade, it is recommended that all other cabling to the unit be disconnected prior to commencing the firmware update to minimise any interruption to the process or disturbances of signals on cables still connected.

For remote upgrades, ensure the radio link is operating correctly and other traffic using the link is minimised.

The firmware update process is two part. First, the firmware is transferred from the PC to the Q data radio via the HTML browser. This is called “uploading and unpacking” the firmware. This typically takes 8 to 9 minutes.

The second process involves the radio writing the new firmware into non-volatile memory and re-booting. This typically takes between 5 to 6 minutes, depending on how much firmware needs to be updated.

### Firmware Update Procedure

Ensure that an Ethernet patch cable is connected from the PC’s LAN port to an Ethernet port of the Q data radio, and the unit’s IP address is entered into the web browser. Check the serial number displayed in the HTML page against the Q data radio that you are about to update. The serial number can be found in center of the home page as shown across the page.



Serial Number: T00167  
 Model: TBRQR450-3700040  
 Firmware Version: 1.0.0.2478  
 Copyright © 2012 Schneider Electric. All Rights Reserved.

1. Click on the ‘Maintenance’ button located along the top of the page.
2. Select the ‘Firmware Management’ button along the left hand side of the page. The firmware upload page will now be displayed as shown below.



3. To select the new firmware pack you wish to upload, click on the Browse/Choose File button.
  4. Locate the .TPK file which contains the new firmware. Select the file and click on “Open”. The page should now display the name of the tpk file chosen in the upload firmware pack section.
  5. Click the ‘Upload Firmware’ button. If there is an existing firmware pack located in the Alternate Firmware section, the radio will display a message, indicating that the alternate pack is about to be over written by the new firmware pack. Click OK to continue.
  6. This process can take up to 10 minutes, wait until the new firmware pack is displayed within the Alternate Firmware section.
  7. Once the firmware has successfully uploaded and unpacked in to the alternate firmware location, click the ‘Activate Alternate’ button.
  8. During this phase, all 5 LED indicators will flash amber simultaneously. After 4 to 5 minutes the Q data radio will re-boot and the new firmware will be activated.
- After a successful activation, the new firmware pack should be displayed within the ‘Current Firmware’ section.

### Firmware Updating and Factory Default Information LEDs

In some circumstances a firmware update or factory default might be required. A special LED sequence is shown during this phase.

	COM 1 Rx/D / Tx/D	COM 2 Rx/D / Tx/D	Sync / RxSig	Pwr / Tx
Firmware upgrade	Amber	Amber	Amber	Amber
Factory Defaults	Green	Green	Green	Green

Firmware Upgrade: All LEDs flash AMBER (as shown in table above) - 1 second ON and 1 second OFF

Factory Default: (as shown in table above) will first illuminate all LEDs to a solid green state to indicate a factory default process has been initiated. Once the factory default process has begun, the LEDs will begin a sequence of flashing green LEDs until the process has been completed.



## Global Firmware Updating

### Introduction

The TView+ Programming software provides a facility to perform Global firmware updates to every Q data radio within a network over the RF channel. The Global firmware update facility uses two techniques to limit the impact on user data.

1. Data rate limiting which trickles the data onto the RF channel at 5% of the channel capacity.
2. Differential firmware packs dramatically reduce the size of the file needed to be sent over the RF channel.

The combination of these two features allows seamless operation of SCADA traffic while the update is in progress.

If every radio is being upgraded from the same version of firmware, the upgrade will take approximately 8 hours to complete at an RF speed of 9600bps.

### Minimum Programmer Requirements

TView+ Programming software Version 3.25.0 (Build 19) onwards

### Connection

Ethernet cable between the PC and the LAN port of the entry point radio.

### Configuration requirements - Radios

SNMP is the transport protocol utilised by the global firmware update tool. Before remote firmware updating can occur, enable SNMP (V1 or V2c but must all be the same) within all of the target Q data radios and have the read/write Community string set to the same password. This password will be later entered in the firmware upgrade window of TView. When setting up SNMP in the radios the read and read/write community strings need to be different otherwise SNMP writes will not work.

The firmware upgrade tool sends the firmware update messages to the networks broadcast address. The broadcast address of any Ethernet device is calculated from the IP address and Subnet Mask. This means that the subnet mask in the following places need to all match exactly the same:

- Each radio within the network being firmware upgraded
- The PC that is performing the global firmware upgrade
- The global firmware upgrade tool

### Configuration requirements - Firmware update tool

Open TView+ Programming suite and select the Firmware update button.

Select the “Q-Series Firmware Update” Button.

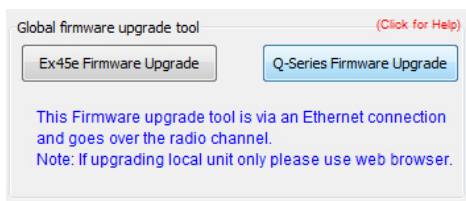

Once selected, the global firmware update tool will appear.

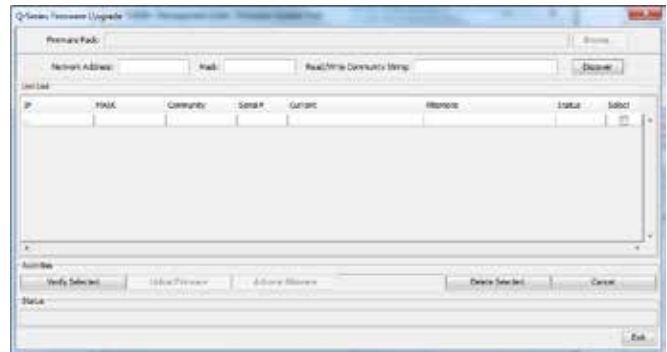

### Network Address:

This parameter defines the IP Address of the network. Otherwise known as Subnet IP, Base Address or Subnet ID (This is not the same as the Subnet ID found within the K/J series radios).

### Mask:

The mask to be applied to define the Subnet. Otherwise known as Netmask. Match up the Mask with the Subnet mask set within all of the target radios as well as that of the PC.

For information on how to determine what the network address and subnet mask is, see your network specialist or refer to a network calculator such as the one found at this address: (<http://ipcalc.nmonitoring.com/>).

- Example: If the radio IP addresses are all in the range 192.168.1.1 to 192.168.1.254 and the subnet mask is 255.255.255.0 then the Network Address is 192.168.2.0. If the system is more complex than this refer to “<http://ipcalc.nmonitoring.com/>”.

### Read/Write Community String:

Set the same Read/Write Community String within all of the target radios.

### Discover Button (Auto):

To avoid searching through the entire subnet range, a manual entry can be used instead of the auto discover button. If you wish to use the manual entry system, skip this step and see ‘Discover (Manual entry)’.

Once the Network Address, Mask & Read/Write Community String Parameters have been filled correctly, the “Discover” Button may be selected. The Status bar at the bottom of the window will begin searching for any unit that falls within the subnet Mask. Any units that are discovered will be populated within the Unit List window.

### Discover (Manual entry):

If you know all of the IP addresses, masks and read/write community strings of the units you wish to firmware upgrade in your network, a manual entry can be made instead of selecting the Discover button. Within the Unit List simply click inside the white blank box underneath ‘IP’ and fill in your unit’s IP address, once completed press enter and a new row will appear for an additional unit if required, this will continue to happen after every IP address added to the list. Now fill in the unit’s MASK and Community string.

**Verify Selected Button:**

Once the units have either been discovered automatically or have been manually entered, ensure that the units that require firmware upgrading are checked in the 'Select' column. Once the units are selected, click the "Verify Selected" button.

This will verify that each of the selected units will respond again. If the units were manually entered, the verification will also pull in the current and alternate firmware packs for each selected unit.

Once the verification is complete, open the new firmware pack into the firmware update tool.

During a firmware update, only a small patch file is applied to each radio. These patch files only contain the differences between current operating firmware and the new firmware being upgraded to. This provides the benefit of only sending small amounts of data over the radio channel, rather than an entire firmware pack.

As it is possible to have radios within the same network operating on different firmware packs, a number of different patch files may be required to be sent over the radio channel.

This means, during a global firmware update, the firmware update tool requires all firmware update patches at once. This can be done by providing the tool with the global firmware zip package (contains all firmware update patches).

The global firmware zip package is contained within the standard Q Data Radio firmware zip, which can be downloaded from the Licensed Trio radio section of the Schneider Electric website: <http://www.schneider-electric.com/products/ww/en/6000-telemetry-remote-scada-systems/6010-data-radios/61419-trio-licensed-radios/?BUSINESS=1>

To open the global firmware zip file within the tool, click the 'Browse...' button and select the firmware upgrade zip package. The global firmware update tool will then select the appropriate patch within the zip file for each radio within the unit list based on each current firmware pack.

Once the Firmware Pack is selected the upload may commence. This is done by selecting the 'Upload Firmware' button. This process will take some time.

After the Upload process is complete, the new firmware will be loaded into each radios alternate firmware pack waiting for activation, to active the new firmware click the 'Activate Alternate' button.

**Delete Selected Button:**

The 'Delete Selected' button allows the user to remove unwanted discovered or verified units from the Unit List.

## Fuse Replacement - QR450

### **⚠ WARNING**

#### HAZARD OF FIRE

Where an internal fuse is to be replaced, the replacement fuse must be of the specified type and current rating. Refer to fuse replacement instructions within the product user manual before servicing.

**Failure to follow these instructions can result in death or serious injury.**

#### QR450 Fuse Specification:

Current rating: 7A  
Fuse type: Fast Acting

Littelfuse part numbers 0453007.MRL, 0453007.NRL, 0453007.MRSN and 0453007.NRSN can be used.

These fuses can be obtained from the following suppliers.

Supplier	Part Number
Farnell	1677444
Element 14	1677444
Digikey	F3140TR-ND
Mouser	576-0453007.MR
Newark	20C2978

To access the internal fuse of the QR450, remove the lid. In order to remove the lid, remove the single 2.5mm hex head screw from underneath the unit.



The fuse in a QR450 is not soldered into place. Instead it is mounted within a fixed fuse holder.

To replace the fuse, the following instructions should be used.

- Remove the blown fuse. Remove the fuse using a pair of pliers and lifting upwards, as per below diagram.



- Fit the new Fuse. Using a pair of pliers and sit the fuse straight across the top of the fuse holder as per below diagram.

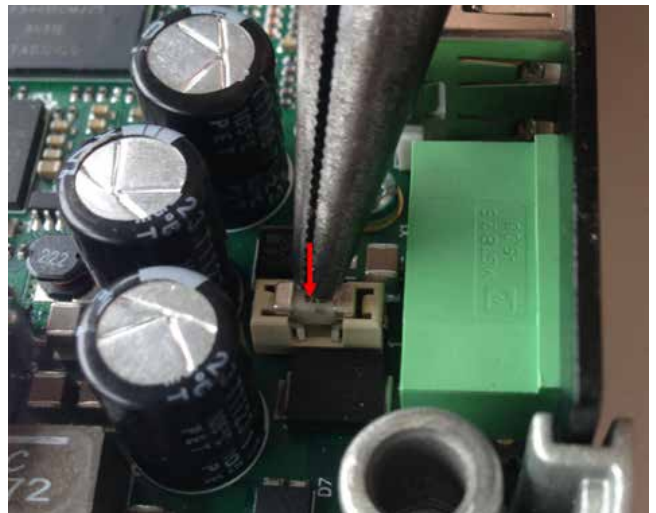

- Then, push down on to the centre of the fuse until it clicks down into place within the fuse holder.





# Part K – Open Source License Acknowledgements

CGIC, copyright 1996-2011 by Thomas Boutell and Boutell.Com, Inc. Permission is granted to use CGIC in any application, commercial or noncommercial, at no cost. HOWEVER, this copyright paragraph must appear on a “credits” page accessible in the public online and offline documentation of the program.

Modified versions of the CGIC library should not be distributed without the attachment of a clear statement regarding the author of the modifications, and this notification may in no case be removed.

Modifications may also be submitted to the author for inclusion in the main CGIC distribution.

Component	Version	License	Website
arping	2.09	<a href="#">GPLv2</a>	<a href="http://www.habets.pp.se/synscan/programs.php?prog=arping">http://www.habets.pp.se/synscan/programs.php?prog=arping</a>
avahi	0.6.29	<a href="#">LGPL</a>	<a href="http://avahi.org/">http://avahi.org/</a>
bash	4.2	<a href="#">GPLv2</a>	<a href="https://www.gnu.org/software/bash/">https://www.gnu.org/software/bash/</a>
bridge-utils	1.4	<a href="#">GPLv2</a>	<a href="http://www.linuxfoundation.org/collaborate/workgroups/networking/bridge">http://www.linuxfoundation.org/collaborate/workgroups/networking/bridge</a>
bsdiff	4.3	<a href="#">BSD</a>	<a href="http://www.daemonology.net/bsdiff/">http://www.daemonology.net/bsdiff/</a>
busybox	1.20.2	<a href="#">GPLv2</a>	<a href="http://www.busybox.net/">http://www.busybox.net/</a>
bzip2	1.0.6	<a href="#">BSD</a>	<a href="http://www.bzip.org/">http://www.bzip.org/</a>
curl	7.21.7	<a href="#">MIT</a>	<a href="http://curl.haxx.se/">http://curl.haxx.se/</a>
dropbear	0.53.1	<a href="#">MIT</a>	<a href="https://matt.ucc.asn.au/dropbear/dropbear.html">https://matt.ucc.asn.au/dropbear/dropbear.html</a>
ethtool	2.6.37	<a href="#">GPLv2</a>	<a href="https://www.kernel.org/pub/software/network/ethtool/">https://www.kernel.org/pub/software/network/ethtool/</a>
expat	2.0.1	<a href="#">BSD</a>	<a href="http://expat.sourceforge.net/">http://expat.sourceforge.net/</a>
gettext	0.16	<a href="#">GPLv2</a> and <a href="#">LGPLv2+</a>	<a href="https://www.gnu.org/software/gettext/">https://www.gnu.org/software/gettext/</a>
hostapd	0.7.3	<a href="#">GPLv2</a>	<a href="http://w1.fi/hostapd/">http://w1.fi/hostapd/</a>
iptables	1.4.11.1	<a href="#">GPLv2</a>	<a href="http://www.netfilter.org/projects/iptables/index.html">http://www.netfilter.org/projects/iptables/index.html</a>
libcgic	205	<a href="#">CGIC Basic License</a>	<a href="http://www.boutell.com/cgic/">http://www.boutell.com/cgic/</a>
libdaemon	0.14	<a href="#">GPLv2</a>	<a href="http://Opointer.de/lennart/projects/libdaemon/">http://Opointer.de/lennart/projects/libdaemon/</a>
libffi	3.0.9	<a href="#">BSD</a>	<a href="https://sourceware.org/libffi/">https://sourceware.org/libffi/</a>
libiconv	1.13.1	<a href="#">LGPL</a>	<a href="https://www.gnu.org/software/libiconv/">https://www.gnu.org/software/libiconv/</a>
libnet	1.1.2.1	<a href="#">BSD</a>	<a href="http://libnet.sourceforge.net/">http://libnet.sourceforge.net/</a>
lighttpd	1.4.29	<a href="#">BSD</a>	<a href="http://www.lighttpd.net/">http://www.lighttpd.net/</a>
Linux Kernel	2.6.38	<a href="#">GPLv2</a>	<a href="https://www.kernel.org/">https://www.kernel.org/</a>
lzo	2.05	<a href="#">GPLv2</a>	<a href="http://www.oberhumer.com/opensource/lzo/">http://www.oberhumer.com/opensource/lzo/</a>
makepasswd	0.5.1	<a href="#">GPL</a>	<a href="https://github.com/khorben/makepasswd">https://github.com/khorben/makepasswd</a>
net-snmp	5.7.1	<a href="#">BSD</a>	<a href="http://www.net-snmp.org/">http://www.net-snmp.org/</a>
ncurses	5.9	<a href="#">MIT</a>	<a href="https://www.gnu.org/software/ncurses/">https://www.gnu.org/software/ncurses/</a>
ntp	4.2.8	<a href="#">MIT/BSD</a>	<a href="http://www.ntp.org/">http://www.ntp.org/</a>
openssl	0.9.8za	<a href="#">OpenSSL</a>	<a href="https://www.openssl.org/">https://www.openssl.org/</a>
pcre	8.13	<a href="#">BSD</a>	<a href="http://www.pcre.org/">http://www.pcre.org/</a>
python	2.7.2	<a href="#">PSF</a>	<a href="https://www.python.org/">https://www.python.org/</a>
pyserial	2.5	<a href="#">PSF</a>	<a href="http://pyserial.sourceforge.net/">http://pyserial.sourceforge.net/</a>
socat	1.7.1.3	<a href="#">GPLv2</a>	<a href="http://www.dest-unreach.org/socat/">http://www.dest-unreach.org/socat/</a>
u-boot	2011-12	<a href="#">GPLv2+</a>	<a href="http://www.denx.de/wiki/U-Boot/WebHome">http://www.denx.de/wiki/U-Boot/WebHome</a>
uClibc	0.9.31	<a href="#">LGPL</a>	<a href="http://www.uclibc.org/">http://www.uclibc.org/</a>
wpa_supplicant	0.6.10	<a href="#">GPLv2</a>	<a href="http://w1.fi/wpa_supplicant/">http://w1.fi/wpa_supplicant/</a>
zlib	1.2.5	<a href="#">BSD</a>	<a href="http://www.zlib.net/">http://www.zlib.net/</a>

## Part L – Support Options

---

When e-mailing questions to our support staff, make sure you tell us the exact model number (and serial number if possible) of the Trio equipment you are working with. Include as much detail as possible about the situation including radio configuration files and system diagrams, also any tests that you have done which may help us to better understand the issue. If possible, include your telephone contact information should we wish to further clarify any issues.

### **Technical Support: The Americas, Europe, Middle East, Asia**

Available Monday to Friday 8:00am - 6:30pm Eastern Time  
Toll free within North America: 1-888-226-6876  
Direct Worldwide: +1-613-591-1943  
Email: SupportTRSS@schneider-electric.com

### **Technical Support: Australia**

Inside Australia: 1 300 369 233  
Email: au.help@schneider-electric.com