

# Clipsal® RF Gateway

SLC5800WCGD for Use With C-Bus™ Wired Networks and  
Clipsal® RF Wireless Control Systems

Instruction Bulletin  
Retain for future use.



## HAZARD CATEGORIES AND SPECIAL SYMBOLS

Read these instructions carefully and look at the equipment to become familiar with the device before trying to install, operate, service, or maintain it. The following special messages may appear throughout this bulletin or on the equipment to warn of potential hazards or to call attention to information that clarifies or simplifies a procedure.

ANSI Symbols Table

### **DANGER**

Danger indicates an immediately hazardous situation which, if not avoided, will result in death or serious injury.

### **WARNING**

Warning indicates a potentially hazardous situation which, if not avoided, can result in death or serious injury.

### **CAUTION**

Caution indicates a potentially hazardous situation which, if not avoided, can result in minor or moderate injury.

### **CAUTION**

Caution, used without the safety alert symbol, indicates a potentially hazardous situation which, if not avoided, can result in property damage or improper operation.

*NOTE: Provides additional information to clarify or simplify a procedure.*

## PLEASE NOTE

Electrical equipment should be installed, operated, serviced, and maintained only by qualified personnel. This document is not intended as an instruction manual for untrained persons. No responsibility is assumed by Square D for any consequences arising out of the use of this manual.

## Class B FCC Statement

This device complies with Part 15 of the FCC Rules. Operation is subject to the following two conditions: (1) this device may not cause harmful interference, and (2) this device must accept any interference received, including interference that may cause undesired operation.

This equipment has been tested and found to comply with the limits for a Class B digital device, pursuant to Part 15 of the FCC Rules. These limits are designed to provide reasonable protection against harmful interference in a residential installation. This equipment generates, uses, and can radiate radio frequency energy and, if not installed and used in accordance with the instructions, may cause harmful interference to radio communications. However, there is no guarantee that interference will not occur in a particular installation. If this equipment does cause harmful interference to radio or television reception, which can be determined by turning the equipment off and on, the user is encouraged to try to correct the interference by one or more of the following measures:

- Reorient or relocate the receiving antenna.
- Increase the separation between the equipment and receiver.
- Connect the equipment into an outlet on a circuit different from that to which the receiver is connected.
- Consult the dealer or an experienced radio/TV technician for help.

Changes or modifications to this device that are not expressly approved by Schneider Electric could void the user's authority to operate this equipment.

## ABOUT THE RF GATEWAY

The Clipsal® RF Gateway provides a C-Bus™ protocol communication bridge between a single Clipsal® RF wireless system and a single C-Bus wired network.

Using the Gateway, Clipsal RF wireless systems and C-Bus wired networks can communicate and interact with each other. The Gateway requires C-Bus Toolkit for setup.

Both network types use the same C-Bus protocol commands.

The Gateway allows:

- Control of a RF wireless system by scheduling or inputting controls from units on a C-Bus wired network or from software.
- Control of output units and electrical loads in one network type from input units in the other network type.

**Figure 1: Clipsal RF Gateway – Typical links between wired and wireless networks**

KEY:

A. Loads (e.g., lights)

B. RF Wireless System:  
includes input and output  
units (e.g., RF keypads, RF  
remotes, and RF plug  
adaptors)

C. Wired output units (e.g.,  
Dimmer)

D. RF Gateway

E. Wired input units (e.g.,  
touch screens, keypads, and  
occupancy sensors)

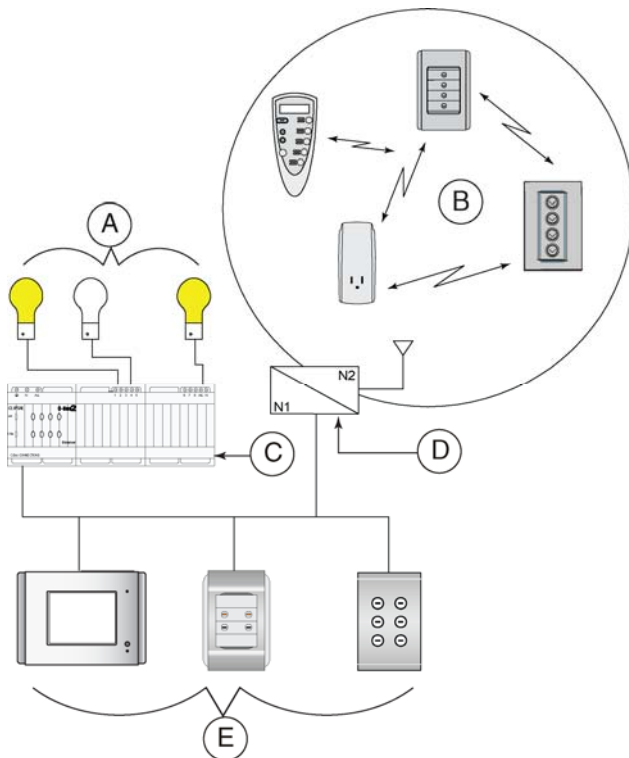

### About Clipsal® RF Wireless Systems

Clipsal® RF Wireless Wall Units include Switches, leading edge Dimmers, and Scene Controllers. The units are designed to replace standard wall switches and dimmers. Each Switch and Dimmer controls one load (lights or other appliances connected to its output). Wall Units can be operated by RF Wireless remote control, and have learn and scene capability.

## Before You Begin

Before you begin to set up a unit, verify that your order is complete by comparing the contents of the package with the appropriate items in the table below. Also verify that the catalog number on the box label matches your order.

## Contents of the Box

**Table 1: Contents of the Box**

<b>Part Number</b>	<b>Description</b>	<b>Quantity</b>
SLC5800WCGD	RF Gateway	1
	Adhesive feet	4
	C-Bus Network cable, 15.7 in. (400 mm)	1

## SAFETY PRECAUTIONS

This section contains important safety precautions that must be followed before attempting to install or maintain electrical equipment. Carefully read and follow the safety precautions below.

### DANGER

#### HAZARD OF ELECTRIC SHOCK, EXPLOSION, OR ARC FLASH

- Apply appropriate personal protective equipment (PPE) and follow safe electrical work practices. See NFPA 70E.
- This equipment must be installed and serviced by qualified electrical personnel.
- Turn off all electrical power supplying this equipment before working on or inside the equipment.
- Always use a properly rated voltage sensing device to confirm that power is off.
- Replace all devices, doors, and covers before turning on power to this equipment.

**Failure to follow these instructions will result in death or serious injury.**

## INSTALLATION INSTRUCTIONS

The RF Gateway can be installed horizontally or vertically. Either installation should allow for access to the Learn button on the base of the unit.

If placing the unit horizontally, you may attach the adhesive feet (provided) to the base of the unit to prevent the unit from sliding or scratching the surface.

If mounting the device on a wall, use the keyhole cutouts on the base of the unit. These have 1.6 inch (40 mm) mounting centers.

Position the antenna for desired reception.

To remove the unit from the wall, slide it up and pull it off of the screws.

**Figure 2: RF Gateway Orientation**

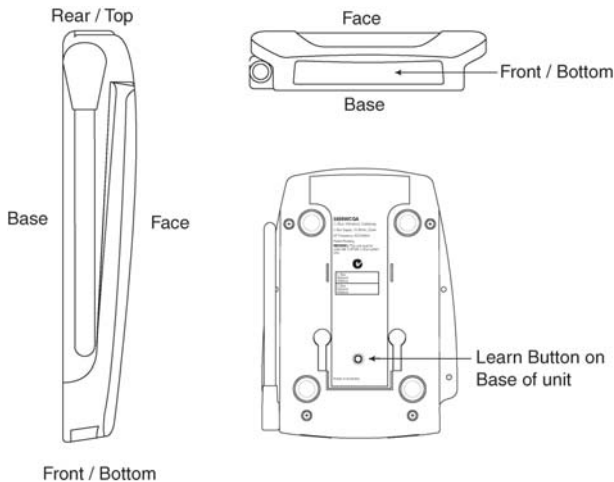



## Network Considerations

The RF Gateway can draw 32 mA from the C-Bus network. Determine the total network current load and verify that there will be enough C-Bus power to support all connected devices. Also verify that the amount of available power per C-Bus network is no more than 2A.

### Network Burden

One network burden is required for proper C-Bus operation, network termination, and biasing.

## CAUTION

### HAZARD OF IMPROPER OR UNSTABLE OPERATION

C-Bus networks require only one burden.

**Failure to follow this instruction can result in improper C-Bus network operation.**

The C-Bus system clock must be enabled in order to apply the network burden.

### Hardware Burden

The hardware burden can be used in one of two ways.

1. Install the hardware burden temporarily in order to enable the software burden, and then to remove the hardware burden.
2. Install the hardware burden and leave it installed as the network burden.

To install the hardware burden device, simply plug it into the C-Bus network RJ-45 receptacle.

*NOTE: Plug the hardware burden device only into C-Bus receptacles.*

**Figure 3: Hardware Burden Connection on the Unit**

KEY:

- A. RJ-45 C-Bus receptacle on the unit
- B. Hardware burden

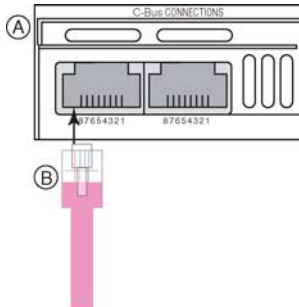

### Software Burden

The RF Gateway incorporates a software-selectable network burden. To enable a software-selectable burden, first install a hardware burden on the network and then enable the software burden using C-Bus Toolkit software. After the software burden is enabled, remove the hardware burden.

### C-Bus System Clock

The RF Gateway has a software-selectable C-Bus system clock with the capability to synchronize data communication on the C-Bus network. Typically the clock is disabled: Successful C-Bus network communications require only one active clock. A maximum of three C-Bus units per network can have the clock enabled. Refer to the C-Bus Toolkit software for additional information and to enable the RF Gateway system clock.

## Selecting a Location

It is important to select the right location to install the RF Gateway. Some considerations are listed below:

- Provide easy access to unit.
- Locate RF Gateway where it will not be subject to water, humidity, direct sunlight, or heavy dust.
- Do not cover unit.
- Only use RF Gateway indoors.
- Allow adequate ventilation.
- Ensure the Learn button, located on the base of the unit, can be accessed.
- The unit should be located centrally to other RF Wireless units so that all units are within range of each other. (See Electrical Specifications for information on the range.)
- If the installation will use the infrared sensor feature, place the unit in a location that allows the infrared receiver to be visible. Avoid obstructions that might impede infrared signals coming from a remote control.

## CONFIGURATION AND PROGRAMMING

Before using the RF Gateway, connect it to a C-Bus wireless and wired network. Connect to a wireless system using learn mode. Connect to a wired network using the C-Bus Toolkit software.

### Connecting to a RF Wireless Network

To link the RF Gateway to a Clipsal® RF Wireless system:

1. Press the Learn button on the base of the RF Gateway. An indicator light at the front of the RF Gateway starts flashing slowly. You now have 3 minutes to complete steps 2 and 3.
2. Press the Learn button on any networked wireless wall unit. The unit's Learn LED will flash to indicate it is in learn mode.
3. Double press the Learn button on the same wall unit. This transmits the network address to the RF Gateway. The slow flashing indicator light on the RF Gateway will flash quickly for about one second and then turn off to indicate that it has been linked to the wireless system. The RF Gateway will exit Learn mode automatically.
4. Press the Learn button on the wall unit to make the wall unit exit Learn mode.

## Connecting to a Wired Network

To connect the RF Gateway to a C-Bus wired network:

1. Remove the Wired C-Bus Connection Cover. To do so, first uninstall the unit (if it has been mounted on the wall) and position the base of the unit towards you. Push the cover straight up and out.

**Figure 4: Removing the C-Bus Connection Cover**

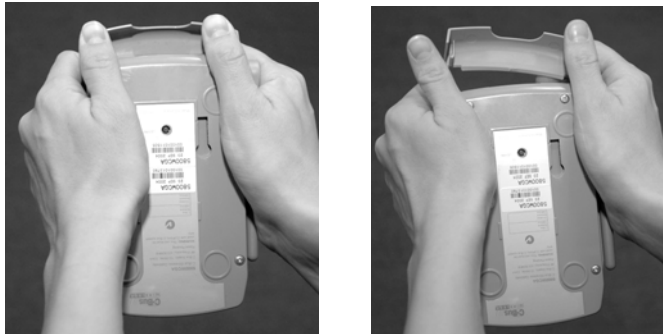

2. To connect the RF Gateway to the wired C-Bus network, plug the C-Bus cable into either of the RJ45 sockets as described in Wiring Guidelines and Connection to the C-Bus Network. (The Figure shows the location of the RJ45 sockets.)
3. Use the C-Bus Toolkit software to configure the wired side of the RF Gateway as described in Configuration.
4. Align the cover to the Gateway and snap the cover into the mounting slots on the Gateway.
5. Position the antenna for optimal reception.

**Figure 5: RF Gateway: Rear/Top View (cover removed)**

KEY:

- A. Wired C-Bus cover mounting slots
- B. RJ45 sockets
- C. Antenna

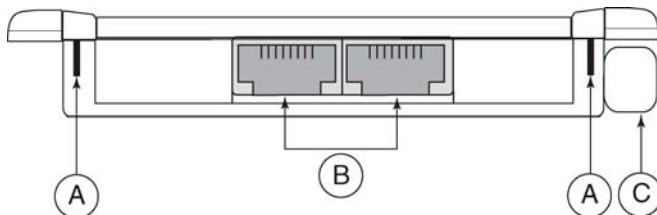

## Wiring Guidelines

Follow the guidelines below when working with the RF Gateway.

- Verify that the power supplying the system is turned OFF before handling electrical power conductors.
- Observe national and local electrical codes.
- Isolate the RF Gateway from the Class 1 wiring. Consult your national and local electrical codes for requirements about isolating Class 1 wiring and Class 2 wiring terminals.
- Prevent wire cuttings and debris from entering the unit.

## Megger® Testing Guidelines

Do not Megger® test C-Bus data cabling or terminals. Megger testing of data cabling or terminals can degrade the performance of the C-Bus network.

It will not harm the units if electrical power terminals only are Megger tested. But because units contain electronic components, the Megger readings will not be correct. To obtain valid readings, disconnect the power lines from the units.

# CAUTION

## HAZARD OF EQUIPMENT DAMAGE

Do not Megger® test C-Bus data cabling or terminals as it can degrade the performance of the C-Bus network.

**Failure to follow this instruction will result in damage to the C-Bus network.**

### Connection to the C-Bus Network

The C-Bus network is connected to the Clipsal RF Wireless Control System RF Gateway through two polarity sensitive RJ45 inputs located on the RF Gateway. Connect the unit to the C-Bus network with Category 5 unshielded twisted pair C-Bus network cable, and a wired RJ45 plug. Refer to the "Wiring Connections Key Diagram" figure, and the "RJ45 Pin Connections" table for wiring and pin connection information.

*NOTE: To clearly distinguish C-Bus from other UTP Cat5 cables, it is recommended to use a different colored cable, or clearly label the C-Bus UTP Cat5 cable.*

*NOTE: The Category 5 unshielded twisted pair C-Bus network cable and the wired RJ45 plug are provided by the installer.*

<b>WARNING</b>
<b>HAZARD OF ELECTRIC SHOCK, EXPLOSION, OR ARC FLASH</b>
Do not connect line voltage to any C-Bus terminal.
<b>Failure to follow this instruction can result in personal injury or equipment or property damage.</b>

**Figure 6: Wiring Connections Key Diagram**

KEY:

- A. C-Bus positive (+): blue + orange
- B. C-Bus negative (-): blue/white + orange/white
- C. Remote OFF: brown + brown/white\*
- D. Remote ON: green + green/white\*

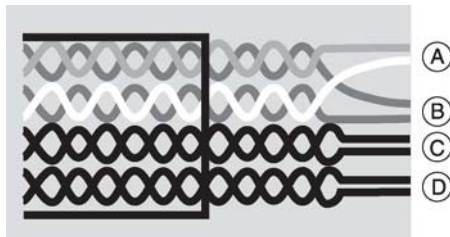

**Table 2: RJ45 Pin Connections**

RJ Pin	C-Bus Connection	Color
1	Remote ON*	Green/White
2	Remote ON*	Green
3	C-Bus Neg (-)	Orange/White
4	C-Bus Pos (+)	Blue
5	C-Bus Neg (-)	Blue/White
6	C-Bus Pos (+)	Orange
7	Remote OFF*	Brown/White
8	Remote OFF*	Brown

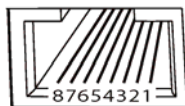

\*Not internally connected.

## Configuration

A RF Gateway consists of two separate internal sub-units, one for the wired network and one for the wireless system. Several gateways may be used within a wired C-Bus™ Network installation. When the installer scans the networks using C-Bus Toolkit software via a PC Interface, each Gateway identifies itself with one of four names, depending on its connection type (wired or RF wireless) and its position in the network (near or far side). See the names in the figure "Identifying Gateways When Scanning from a PC Interface."

To configure the RF Gateway on a wired network, use C-Bus Toolkit Software.

When configuring the wired side of the RF Gateway, note the following points.

- The Unit Address of the wired near side of the RF Gateway (GATEWLSN) must match the Network Address of the Clipsal RF wireless system being linked to.
- The Unit Address of the wireless far side of the RF Gateway (WGATE5F) must match the Network Address of the C-Bus wired network being linked to.

The figure is a diagram of an installation with two wired networks linked through a wireless system. The installation uses two Gateways. Four Gateway subunits show up if the installer scans the networks using C-Bus Toolkit software via the PC Interface (PCI).

**Figure 7: Identifying Gateways When Scanning from a PCI**

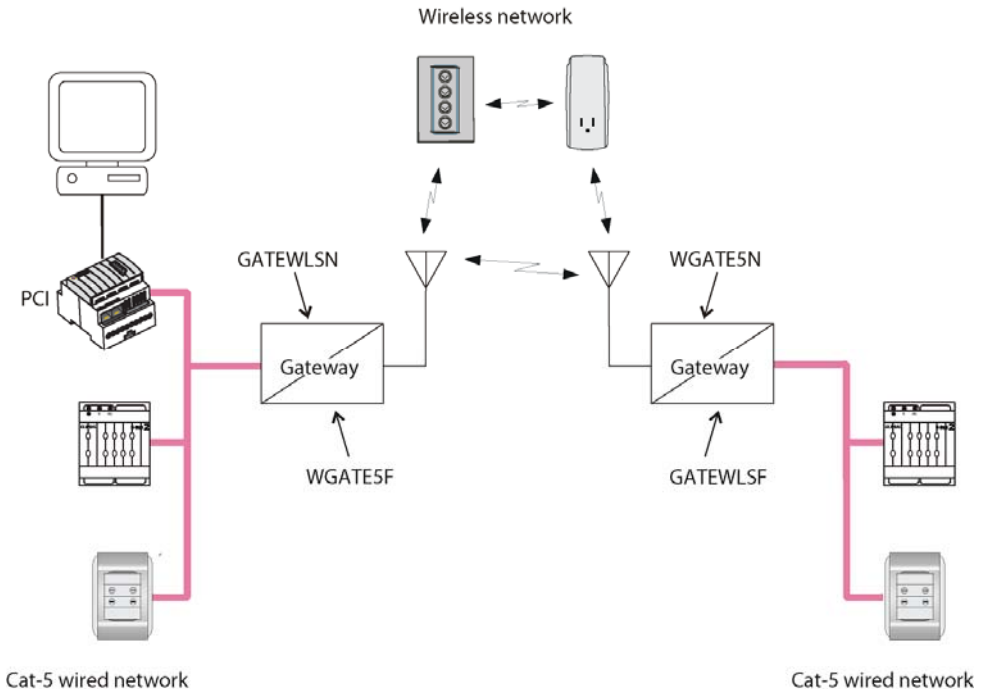



## Communication Options

The RF Gateway supports explicit routing of messages into and through both C-Bus™ wired networks and Clipsal® RF wireless systems. Such messages are used by control software such as the C-Bus Toolkit and control units such as the C-Touch Color Touch Screen.

Several options are available when using the C-Bus Toolkit software to edit the Gateway unit. The following options are included on the "Connections" tab:

- Send to adjacent network - This causes standard messages (such as button presses) on either side of the specified "Connect Applications" to be sent to the adjacent wired network or wireless system. When this option is enabled, a unit with a specific Group Address on the one side of the Gateway will be associated with units with the same Group Address on the other side (if units have the same Application Address).
- Send to other remote network - This allows standard messages on either side of the specified "Connect Applications" to be sent from the wireless system to a non-adjacent C-Bus network (possibly through one or more network bridges).
- Synchronize to wired - This option applies when the Gateway is powered up. It causes the Gateway to retrieve the levels of groups in the wired C-Bus network, and set the levels of corresponding groups in the wireless system to the same values.

## Status Reporting

Wired C-Bus networks use a status reporting system (known as an MMI). This provides automatic detection and correction of discrepancies between the states of grouped inputs and outputs. It also allows the C-Bus Toolkit software, and special C-Bus control units, to take a snapshot of the states of units or groups in the network.

RF Wireless systems use a different method of status reporting, which is slower but better suited to a radio transmission/reception environment. The Wireless C-Bus status reporting serves the same purpose as the wireless C-Bus MMI.

The Gateway translates between the two status reporting types, allowing the RF Wireless system to be scanned and browsed using the C-Bus Toolkit software.

After powering up, the Gateway may take up to 1 minute to obtain a complete view of the wireless system. Under some circumstances, the Gateway can take 30 to 60 seconds to recognize that a unit has been added to or removed from a wireless system.

When using the C-Bus Toolkit software to view units on a wireless system, an "Update" button is provided to cause the Gateway to rediscover all wireless units.

## CARE AND CLEANING INSTRUCTIONS

Follow the precautions below to properly clean and care for the unit.

- Clean regularly using a soft lint free cloth.
- Only use a mild, non-abrasive cleaner such as window cleaner lightly sprayed onto the lint free cloth to clean the unit.
- Ensure hands are dry and clean before operating the unit.
- Only use non-abrasive objects to operate the unit. Hard, sharp objects may cause damage.
- Leave the unit uncovered to allow adequate ventilation.
- Only use the unit indoors.
- Properly shade the unit so that it is not exposed to direct sunlight for extended periods.

## STATUS INDICATOR

The indicator lights (LED) are in the infrared sensor at the front/bottom of the RF Gateway.

**Figure 8: Location of Status Indicators**

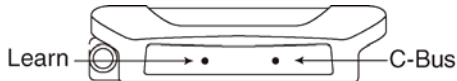

The C-Bus indicator LED shows the status of the C-Bus network at the unit. The table explains the meaning of each type of LED activity.

**Table 3: C-Bus LED Status**

C-Bus LED Activity	Meaning
Off	No C-Bus connection or insufficient power
Slow flashing	Normal connection to C-Bus network
Quick flashing	Confirms that the RF Gateway has been linked to the RF Wireless system. Lasts about 1 second after the link is established.

The Learn indicator LED comes on during Learn Mode.

## ELECTRICAL SPECIFICATIONS

**Table 4: Specifications**

Parameter	Description
C-Bus supply voltage	15 to 36 V DC, 32 mA
RF frequency	916 MHz
Transmitting power	5 mW
Typical range (range depends on building construction and the proximity to dense or metallic objects)	Timber frame / brick veneer construction 49.2 to 65.6 feet (15 to 20 m) Brick, stone, or steel frame construction 32.8 to 49.2 feet (10 to 15 m) Steel reinforced concrete construction 16.4 to 32.8 feet (5 to 10 m)
Maximum range (open air)	196.8 feet (60 m)
Operating temperature range	32 to 104 °F (0 to 40 °C)
Operating humidity range	10 to 95% RH (non-condensing)

## DIMENSIONS

**Table 5: RF Gateway Dimensions**

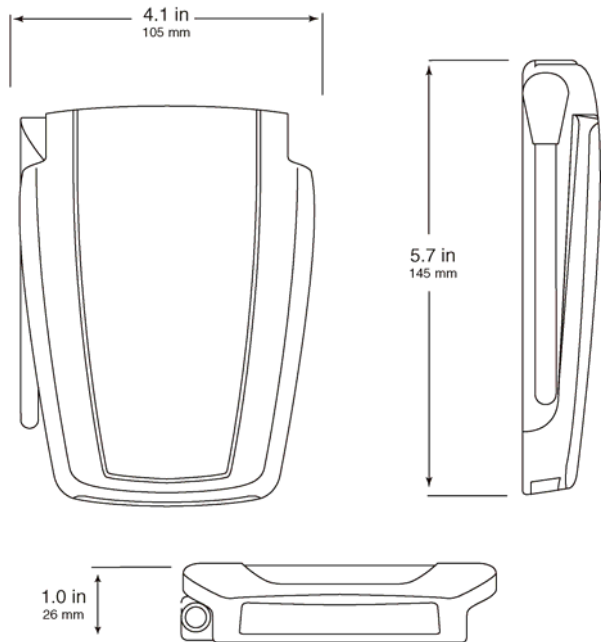

Parameter	Description
Dimensions (W x H x D)	4.1 x 5.9 x 1.0 inches (105 x 149 x 26 mm)
Weight	3.7 ounces (105 g)
Mounting centers	1.6 inches (40 mm)



## STANDARDS

The RF Gateway complies with the following Standards:

**Table 6: U.S. and Canadian Product Safety Standards and U.S. FCC Regulations**

Standards/Regulations	Title
 CSA C22.2 No. 205	Signal Equipment
 UL916	Energy Management Equipment
 FCC Part 15	Class B Digital Device for Home or Office Use



## **SUPPORT AND SERVICE**

Contact the Square D Customer Information Center for technical support by phone at 1-888-Square D (1-888-778-2733) or e-mail at [lightingcontrol.support@us.schneider-electric.com](mailto:lightingcontrol.support@us.schneider-electric.com).

Contact your local Square D service representative or Clipsal® certified installer for repairs or service to your network.

You may also find helpful information on our web site at [www.squaredlightingcontrol.com](http://www.squaredlightingcontrol.com).

**Schneider Electric, USA**  
320 Tech Park Drive, Suite 100  
La Vergne, TN, 37086  
1-888-SquareD (1-888-778-2733)  
[www.squaredlightingcontrol.com](http://www.squaredlightingcontrol.com)

Square D,  Clipsal, C-Bus, Saturn and Neo are trademarks or registered trademarks of Schneider Electric and/or its affiliates in the United States and/or other countries.

Electrical equipment should be installed, operated, serviced, and maintained only by qualified personnel. No responsibility is assumed by Schneider Electric for any consequences arising out of the use of this material.

© 2008 Schneider Electric. All Rights Reserved.