

## OPERATING INSTRUCTIONS

### KEEP PACKAGING AS IT CONTAINS IMPORTANT INFORMATION.

#### BATTERY INSTALLATION:

##### BATTERIES:

8 x AA(R6) batteries required

#### ATTENTION PARENTS

IT IS RECOMMENDED THAT THIS TOY AND ALL ACCESSORIES BE PERIODICALLY EXAMINED FOR POTENTIAL HAZARDS AND THAT ANY POTENTIALLY HAZARDOUS PARTS BE REPAIRED OR REPLACED.

#### CARE

Never drive the vehicle on a wet floor, on sand, grass, carpet, in mud, rain or snow. These can cause damage to the vehicle.

Do not expose the vehicle to extreme temperatures.

To protect the vehicle's wheel mechanisms from lint and hair, do not drive it on carpet.

Occasionally wipe the vehicle with a damp cloth remove any dirt/dust from wheels.

Do not use harsh chemicals to clean the vehicle.

Modifying or tampering with the vehicle or the transmitter's internal components can cause a malfunction.

#### HELPFUL HINTS

Running the vehicle continuously for long periods of time generates high levels of heat.

Heat causes wear and tear on the motor. When the vehicle's battery pack goes flat, let the vehicle cool at least 10 minutes before installing a newly charged battery pack. This helps keep heat levels down. If the vehicle's motor runs but does not respond to the transmitter, move the transmitter closer to the vehicle and try again.

If a CB radio is used nearby, it might interfere with control of the vehicle. If this happens, move the vehicle and transmitter away from the CB radio. The vehicle cannot be operated near devices with transmitters that use the same frequency. Check the packaging to see which frequency your vehicle uses.

If the vehicle moves slowly, and a recharged battery pack has been installed, check the wheel mechanisms for lint, thread, hair or dust.

#### INSERTING BATTERIES

##### VEHICLE

1. Turn over the vehicle and push the ON/OFF to "OFF" position. (See Diagram 1)
2. Open the battery cover. (See Diagram 1)
3. Insert 6 "AA" batteries by matching the (+) and (-) signs as indicated in the battery compartment. (See Diagram 2)
4. Replace the battery cover.

##### TRANSMITTER

1. Slide open the battery cover at the back of the transmitter and insert 2 "AA" batteries inside following the engraved sign. (See Diagram 3)
2. Replace the battery cover.

Note: Remove battery after you have finished using your vehicle.

## HOW TO PLAY

#### START TO PLAY

1. Build up antenna by passing the cable through the antenna tube provided and plug into the vehicle tightly. Otherwise, the vehicle will not work. (See Diagram 4)
2. Push the ON/OFF switch to the "ON" position of the vehicle. (See Diagram 5)

#### OPERATION

1. Operate the vehicle with the transmitter (See Diagram 6).
2. Turn OFF the vehicle and the transmitter after playing and remove all batteries from the transmitter and the car.

#### FRONT WHEELS STEERING ADJUSTMENT

1. If the vehicle does not run straight forwards, adjust the lever for satisfactory alignment on the underside of the vehicle. (See Diagram 7)
2. If the vehicle runs towards left, turn "Steering Alignment Lever" towards "R"
3. If the vehicle runs towards right, turn "Steering Alignment Lever" towards "L"

Keep packaging as it contains important information.

**CAUTION:** To prevent battery leakage:

Be sure to insert batteries correctly and always follow the product and battery manufacturers' instructions.

Never mix old and new batteries (replace all batteries at the same time).

Never mix Alkaline, standard (Carbon Zinc) or rechargeable batteries.

Only batteries of the same or equivalent type as recommended are to be used.

Do not use RECHARGEABLE batteries, unless specified.

Non-rechargeable batteries are not to be recharged.

Rechargeable batteries are to be removed from the product before being charged (if removable).

Rechargeable batteries are only to be charged under adult supervision (if removable).

Always remove exhausted or dead batteries from the product.

Remove batteries from product before extended storage.

The supply terminals are not to be short-circuited.

Batteries are to be inserted with correct polarity.

Batteries may explode or leak if misused.

**ATTENTION:** Battery / Batteries should be installed by an adult only.

**ATTENTION:** User should remove the battery from the item before disposal.

AA/LR6 or AAA/LR03 Batteries may present a choking hazard - keep away from young children.

This appliance is not intended for use by persons (including children) with reduced physical, sensory or mental capabilities, or lack of experience and knowledge, unless they have been given supervision or instruction concerning use of the appliance by a person responsible for their safety.

- The WEEE symbol if present indicates that this item contains electrical or electronic components which must be collected and disposed of separately.
- Never dispose of electrical or electronic waste in general municipal waste. Collect and dispose of such waste separately.
- Make use of the return and collection systems available to you, or your local recycling programme. Contact your local authority or place of purchase to find out what schemes are available.
- Electrical and electronic equipment contains hazardous substances which, when disposed of incorrectly, may leak into the ground. This can contribute to soil and water pollution which is hazardous to human health, and endanger wildlife.
- It is essential that consumers look to re-use or recycle electrical or electronic waste to avoid it going to landfill sites or incineration without treatment.

#### FCC Information

This equipment has been tested and found to comply with the limits for a Class B digital device, pursuant to Part 15 of the FCC Rules. These limits are designed to provide reasonable protection against harmful interference in a residential installation. This equipment generates, uses and can radiate radio frequency energy and, if not installed and used in accordance with the instructions, may cause harmful interference to radio communications. However, there is no guarantee that interference will not occur in a particular installation. If this equipment does cause harmful interference to radio or television reception, which can be determined by turning the equipment off and on, the user is encouraged to try to correct the interference by one or more of the following measures:

- Reorient or relocate the receiving antenna.
- Increase the separation between the equipment and receiver.
- Connect the equipment into an outlet on a circuit different from that to which the receiver is connected.

Consult your local retailer store or an experienced radio/TV technician for help. If you cannot eliminate the interference, the FCC requires that you stop using your product. Changes or modifications not expressly approved by the Responsible Party may cause interference and void the user's authority to operate the equipment.

FCC Note: The antenna installed on the equipment is a unique one. Installation of an unauthorized antenna on this equipment could void the user's authority to operate the equipment.



ENGLISH

**EZTEC**  
www.eztec.hk

EZ-TEC® IS A REGISTERED TRADEMARK OWNED BY SCIENTIFIC TOYS, LTD.

© 2016 SCIENTIFIC TOYS LTD. 1108, TOWER B,  
14 SCIENCE MUSEUM ROAD, TSIMSHATSUI, HONG KONG.  
PRINTED IN CHINA  
O.I. NO.5978

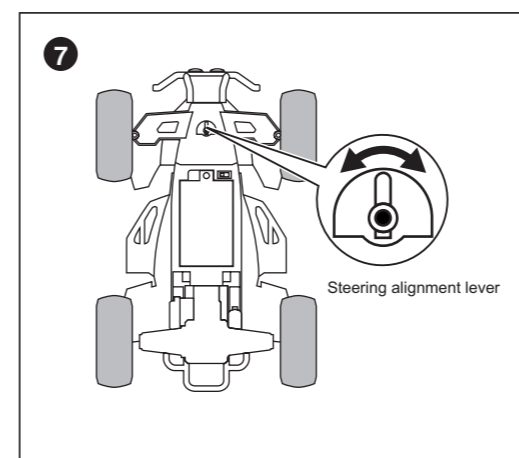
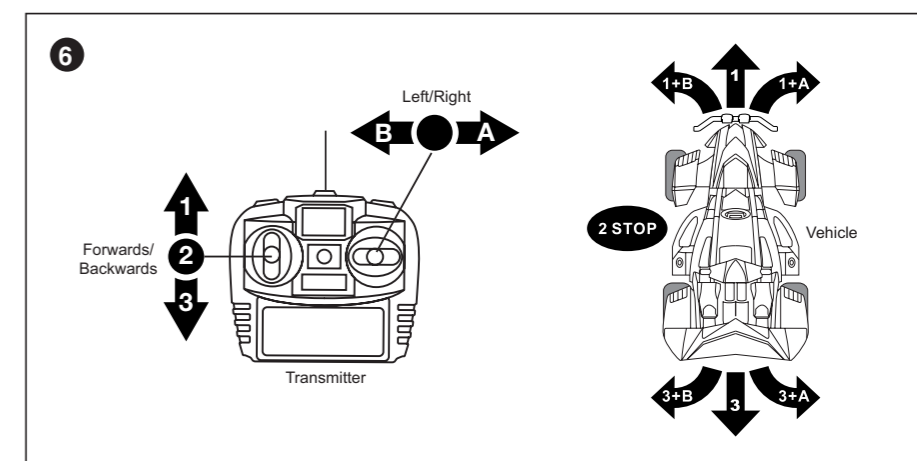
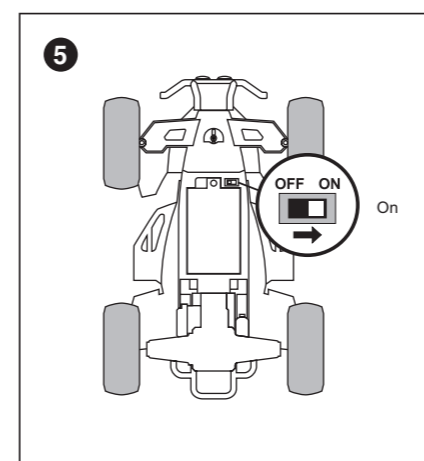
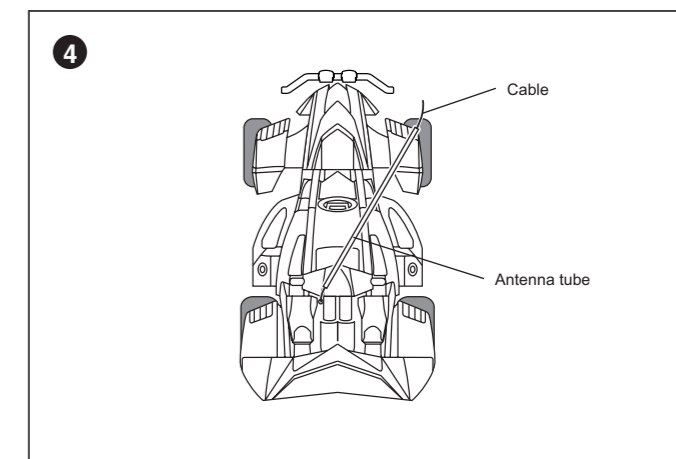
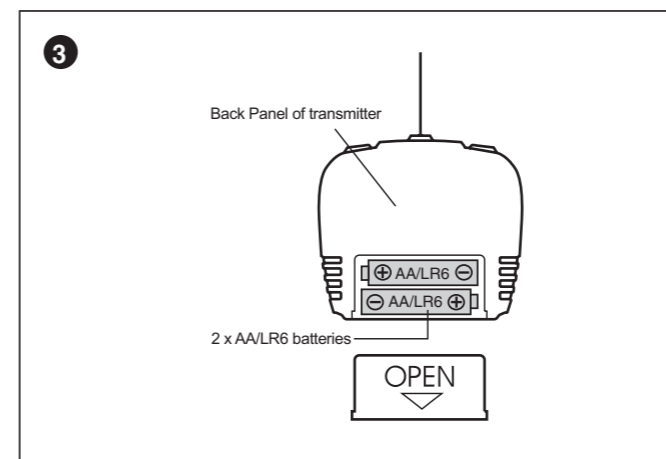
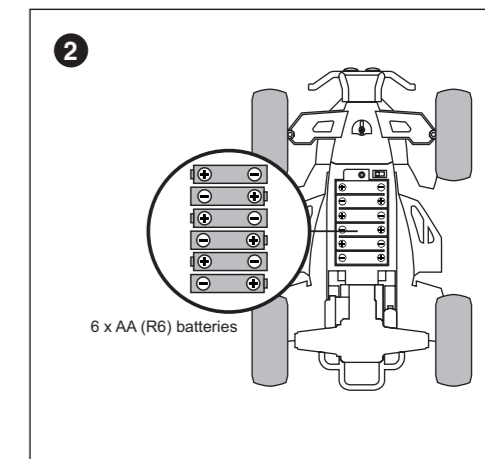
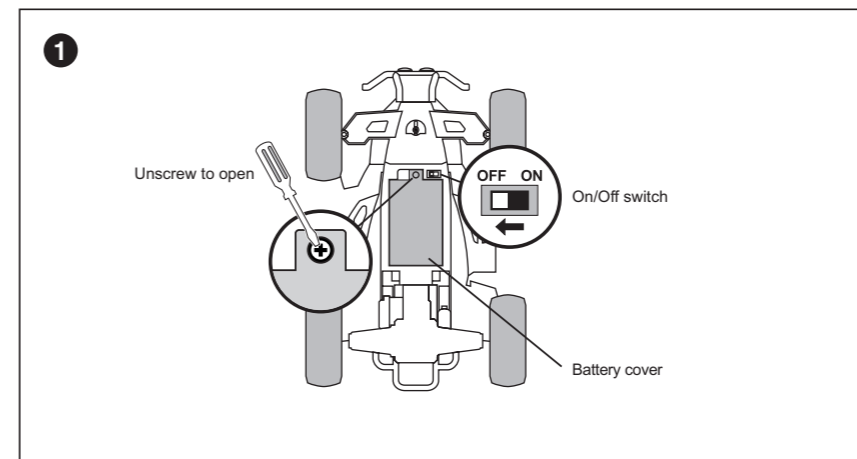

SIZE:210MM X 297MM

PN#65-5978-000-0100