



SL-60

2-3NM+ Solar Marine Lantern Installation & Service Manual

Table of Contents

Introduction	Page 4
Operating Principle	Page 4
Technology	Page 4
SL-60 Model	Page 5
Installation	Page 8
Selecting an Intensity/Power Setting	Page 10
Selecting a Flash Code	Page 11
Flash Codes	Page 12
Optional GPS Synchronisation	Page 17
Lantern Status	Page 18
Optional IR Remote Control	Page 20
Sealite IR Controller / Universal Remote Compatibility	Page 20
IR Controller Functions	Page 21
Test Mode / Configure.....	Page 21
Normal Operation.....	Page 21
Read	Page 21
Flash Code.....	Page 21
Flash Code Numbers	Page 21
Intensity.....	Page 22
Battery Status	Page 22
Operational Mode	Page 22
Lux	Page 23
Error / Acknowledge Indication	Page 24
Configuration Settings.....	Page 24
Hibernation Mode (Advanced Users).....	Page 25
Storage Mode (Advanced Users).....	Page 27
Maintenance and Servicing	Page 28
Troubleshooting	Page 29
Sealite LED Light Warranty	Page 30

Version No.	Description	Date	Approved
3.3	Re launch Catalogue	May 2009	K. Paton
3.4	Custom Manual	April 2010	K. Paton
3.5	Logo Update	May 2010	K. Paton
3.6	Warranty Update	July 2010	K. Paton
4.0	Update: Quality Logo	May 2011	J. Dore
4.1	Update: Spec Table	May 2012	J. Dore
4.2	Update: Photometrics	August 2012	J. Dore
5.0	Single LED	July 2015	J. Dore
5.1	Battery Voltages	December 2015	A. Burns
5.2	Contact details	January 2016	J. Dore



Introduction

Congratulations! By choosing to purchase a Sealite lantern you have become the owner of one of the most advanced LED marine lanterns in the world.

Sealite Pty Ltd has been manufacturing lanterns for over 25 years, and particular care has been taken to ensure your lantern gives years of service.

As a commitment to producing the highest quality products for our customers, Sealite has been independently certified as complying with the requirements of ISO9001:2008 quality management system.

Sealite lanterns comply with requirements of the US Coast Guard in 33 CFR part 66 for Private Aids To Navigation.

By taking a few moments to browse through this booklet, you will become familiar with the versatility of your lantern, and be able to maximise its operating function.

Operating Principle

The solar module of the lantern converts sunlight to an electrical current that is used to charge the battery. The battery provides power to operate the lantern at night.

The flasher unit has very low current requirements. A microprocessor drives an ultra bright LED through a DC/DC converter, which enables the LED's to operate within the manufacturer's specifications. The battery is protected from over-charging within the circuit to ensure maximum battery life.

On darkness, the microprocessor will initiate a program check and after approximately 1 minute begin flashing to the set code

Technology

Sealite is the world's fastest growing manufacturer of marine aids to navigation. We employ leading mechanical, optical, hardware & software engineers to create innovative products to service the needs of our customers worldwide, and offer the widest range of solar-powered LED lanterns in the marketplace.

Electronics

Sealite employs leading in-house electronic engineers in the design and development of software and related circuitry. All individual electronic components are sourced directly by Sealite procurement staff ensuring that only the highest quality components are used in our products.

LED Technology

All marine lanterns use the latest advancements in LED (Light Emitting Diode) technology as a light source. The major advantage of LED's over traditional light sources is well established in that they typically have an operational life in excess of 100,000 hours, resulting in substantial savings to maintenance and servicing costs.

Precision Construction

Commitment to investing in the design and construction of injection-moulded parts including optic lenses, light bases and a range of other components ensures that all Sealite products are of a consistent & superior quality.

Optical Performance

Sealite manufactures a range of marine LED lenses moulded from multi-cavity dies. Complex shapes such as the SL70, BargeSafe™ and 16-segment multi-focus lenses are a testament to the company's superior in-house lens manufacturing capabilities and outstanding optical performance.

Award-winning, Patented Technology

Several United States and Australian patent registrations are held on Sealite's range of innovative designs, with other regional patents pending in Canada, United Kingdom and Europe.

SL-60 Model

The Sealite SL-60 is the most popular and versatile 2-3NM+ solar marine light available. Made from tough, durable polycarbonate and using the latest high-intensity LEDs, no expense has been spared in the design and development of this lantern. Installation takes just minutes, and a permanent ON/OFF switch allows for easy storage.

The unit is ideal for navigation, hazard lighting, aquaculture, perimeter lighting and a range of other applications.

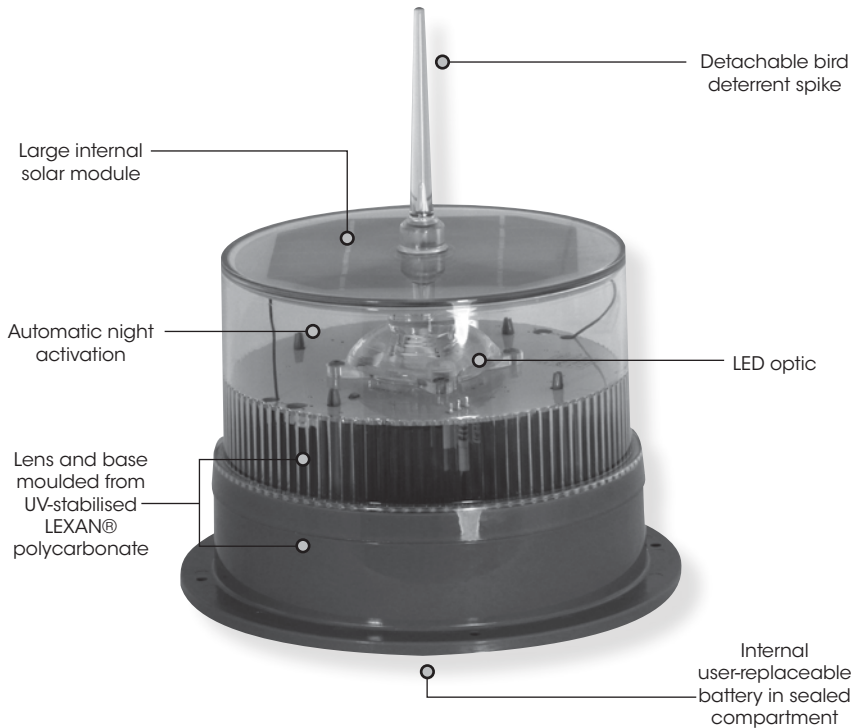

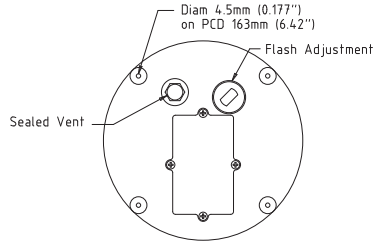
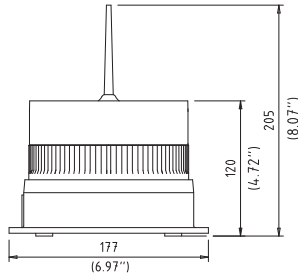

Standard Base

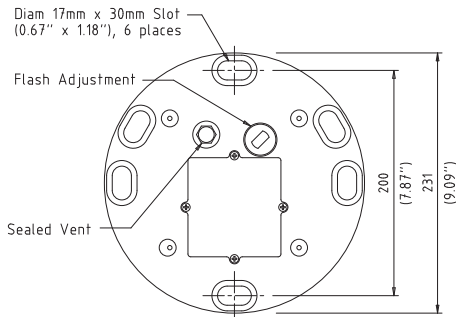

Optional 200mm Bolt Pattern Base

SPECIFICATIONS* * SL-60

Light Characteristics

Light Source	LED
Available Colours	Red, Green, White, Yellow, Blue
Typical Maximum Intensity (cd)†	Red - 24.7 Green - 26.6 White - 29.2 Yellow - 18.8
Visible Range (nm)	AT @ 0.74: 2-3+ AT @ 0.85: 2.3-3.5+
Horizontal Output (degrees)	360
Vertical Divergence (degrees)	7
Available Flash Characteristics	Up to 256 IALA recommended (user adjustable)
Intensity Adjustments	Adjustable in 25% increments
LED Life Expectancy (hours)	>100,000

Electrical Characteristics

Current Draw (mA)	Refer to Sealite Power Calculator
Circuit Protection	Integrated
Nominal Voltage (V)	3.6
Autonomy (days)	>20 (14 hour darkness, 12.5% duty cycle)
Temperature Range	-40 to 80°C

Solar Characteristics

Solar Module Type	Multicrystalline
Output (watts)	1.4

Power Supply

Battery Type	High grade NiMH
Battery Capacity (Ah)	4
Nominal Voltage (V)	3.6

Physical Characteristics

Body Material	LEXAN® Polycarbonate – UV-stabilised
Lens Material	LEXAN® Polycarbonate – UV-stabilised
Lens Diameter (mm/inches)	150 / 5 ⁷ / ₈
Lens Design	Single LED optic
Mounting	4 x 4.5mm mounting holes
Height (mm/inches)	205 / 8 ¹ / ₈
Width (mm/inches)	177 / 7
Mass (kg/lbs)	0.9 / 2 ¹ / ₈ (SL-60LB 1 / 2 ¹ / ₄ . SL-60-8AH 1 / 2 ¹ / ₄ . SL-60LB-8AH 1.1 / 2 ¹ / ₂ . SL-60LB-16AH 1.5 / 3 ¹ / ₈)
Product Life Expectancy	Up to 12 years

Certifications

CE	EN61000-6-3:1997. EN61000-6-1:1997
IALA	Signal colours compliant to IALA E-200-1
Quality Assurance	ISO9001:2008
Waterproof	IP68

Intellectual Property

Trademarks	SEALITE® is a registered trademark of Sealite Pty Ltd
Warranty*	3 years

Options Available

- IR Programmer
- GPS Synchronisation
- 8Ah battery
- 16Ah battery
- 200mm bolt pattern base
- 50mm pole mount adapter plate

• Specifications subject to change or variation without notice
* Subject to standard terms and conditions
† Intensity setting subject to solar availability



Installation

Charging the Battery

New lanterns should be left in the sun for 1-2 days to ensure battery is charged before placing in service. Please note, lantern will re-charge even when toggle switch is turned to 'OFF' position.

Preferred Installation Location

For best lantern performance, ensure solar modules are not covered and are in clear view of the sun with no shadows.

Lantern Operation

Lantern is activated by ON/OFF Switch. Intensity and flash settings need to be set prior to activation.

1. Remove the marked flash adjustment bung from the base of the lantern and set internal toggle switch to 'ON'.
2. The power and range settings of the lantern are adjusted by setting the DIP switches inside the lantern. Your lantern is normally set to maximum range (see 'Selecting an Intensity/Power Setting' section of this manual).
3. Set rotary switches to the required flash code (see 'Selecting a Flash Code' section of this manual).
4. Replace flash adjustment bung.
5. A sealed vent on the base allows air transfer without moisture intake, and should not be disturbed.
6. To test place dark cover (towel or jacket) on top of light to activate sensor, light will come on.
7. Ensure that the unit is bolted to an even, flat surface.

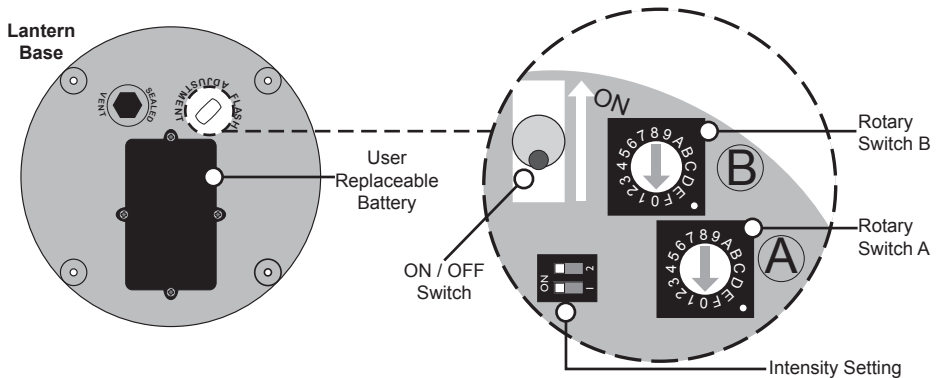



Press-fit Bird Deterrent Spike

This unit is equipped with a press-fit bird deterrent spike located on the top of the lantern.

Installation of the press-fit Bird Deterrent Spike

Prior to installing the bird spike, ensure the hole is free of dirt and debris.

Align the bottom hole of the bird spike with the tip at the top of the lantern and push until you have complete contact as shown in the photo below. Adhesives or locking compounds are not required.

Removal of the press-fit Bird Deterrent Spike

Grab the spike and remove as shown below. You may need to apply slight pressure to the area around the top of the lantern in order to remove the bird spike.

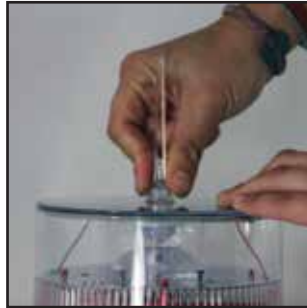

Selecting an Intensity/Power Setting

Intensity/power settings on Sealite lanterns operate via DIP switches, located near the rotary switches on the flasher unit. The intensity/power settings may be used to reduce the power consumption and intensity of the lantern. Setting the lantern to 25% intensity will reduce the power consumption to 25% of the normal 100% setting and the range by 20% - 40% depending on the maximum intensity. Refer to Sealite power calculator to confirm reduced range. This setting may be used to adjust the current draw of the light to local sunlight conditions.

The following diagrams indicate intensity/power settings:-

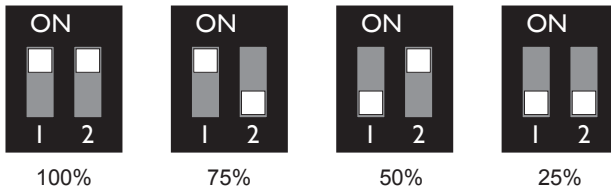

Intensity Setting	Power mA / hour
100%	85mA
75%	64mA
50%	43mA
25%	22mA

Power Consumption Calculator

Night Hours (use 13.7 if unknown)	Power mA/hour	Duty Cycle (e.g. 20% = 0.2)	Total power used per night (mA)
X	X	=	

Total power used per night (mAh)	Solar Panel Charge (mA)	Number of full sunlight hours required to break even (the amount of time it will take for the solar to replace what the light took out overnight)
/	176	=

If the number of Full Sunlight hours is less than 2.5-3.0 hours, please consider reducing the intensity (Power) or reducing the Duty Cycle.

Selecting a Flash Code - Rotary Switches A & B

All lanterns have 2 rotary switches marked A and B on the flasher unit. Turning the small arrows to the appropriate number or letter will set the code. The unit may take up to one minute to activate a new flash code. A comprehensive list of available flash codes is listed on in the 'Flash Codes' section of this manual.

Example:

SWITCH		FLASH CODE	ON	OFF
A	B			
A	0	FL 3 S	0.3	2.7

Note – if setting the lantern to a demanding duty-cycle such as steady-on, the power setting must be reduced to ensure reliable operation

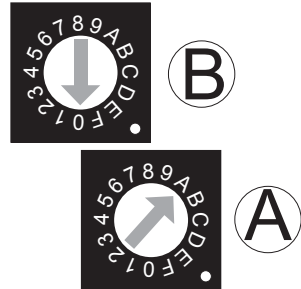

Flash Codes

The Sealite SL-60 may be set to any of 256 IALA recommended flash settings which are user-adjustable onsite without the need for external devices.

SEALITE® code reference is listed by number of flashes

**For the latest version of this document visit www.sealite.com,
or email info@sealite.com**

Symbols

FL	Flash followed by number Eg. FL 1 S, one flash every second
F	Fixed
Q	Quick flash
VQ	Very quick flash
OC	Occulting; greater period on than off
ISO	Isophase; equal period on and off
LFL	Long flash long
MO	Morse code () contains letter

For example, VQ (6) + LFL 10 S means 6 very quick flashes followed by a long flash, during a 10-second interval.

The amount of power your lantern draws through the night depends on the duty cycle, i.e. the amount of time on as a proportion to the timing cycle. For example, 0.5 seconds on and 4.5 seconds off equals a 10% duty cycle.

It is best to operate at the lowest duty cycle appropriate to the actual needs of the application.

Recommended Rhythm for Flashing Light - IALA Regions A and B

MARK DESCRIPTION	RHYTHM
Port Hand & Starboard Marks:	Any, other than Composite Group Flashing (2+1)
Preferred Channel Starboard:	Composite Group Flashing (2+1)
Preferred Channel Port:	Composite Group Flashing (2+1)
North Cardinal Mark:	Very quick or quick
East Cardinal Mark:	Very quick (3) every 5 seconds or quick (3) every 10 seconds
South Cardinal Mark:	Very quick (6) + long flash every 10 seconds or quick (6) + long flash every 15 seconds
West Cardinal Mark:	Very quick (9) every 10 seconds or quick (9) every 15 seconds
Isolated Danger Mark:	Group flashing (2)
Safe Water Mark:	Isophase, occulting, one long flash every 10 seconds or Morse Code "A"
Special Marks:	Any, other than those described for Cardinal, Isolated Danger or Safe Water Marks

SWITCH		IR Controller	FLASH CODE	ON	OFF
A	B				
0	0	0	F (Steady light)		
D	3	211	VQ 0.5 S	0.2	0.3
E	3	227	VQ 0.6 S	0.2	0.4
F	3	243	VQ 0.6 S	0.3	0.3
7	3	115	Q 1 S	0.2	0.8
8	3	131	Q 1 S	0.3	0.7
9	3	147	Q 1 S	0.4	0.6
A	3	163	Q 1 S	0.5	0.5
8	4	132	Q 1 S	0.8	0.2
B	3	179	Q 1.2 S	0.3	0.9
9	4	148	Q 1.2 S	0.5	0.7
C	3	195	Q 1.2 S	0.6	0.6
F	4	244	FL 1.5 S	0.2	1.3
1	0	16	FL 1.5 S	0.3	1.2
0	5	5	FL 1.5 S	0.4	1.1
0	4	4	FL 1.5 S	0.5	1.0
2	0	32	FL 2 S	0.2	1.8
3	0	48	FL 2 S	0.3	1.7
4	0	64	FL 2 S	0.4	1.6
5	0	80	FL 2 S	0.5	1.5
6	0	96	FL 2 S	0.7	1.3
7	0	112	FL 2 S	0.8	1.2
1	2	18	ISO 2 S	1.0	1.0
8	0	128	FL 2.5 S	0.3	2.2
9	0	144	FL 2.5 S	0.5	2.0
D	6	214	FL 2.5 S	1.0	1.5
1	5	21	FL 3 S	0.2	2.8
A	0	160	FL 3 S	0.3	2.7
2	5	37	FL 3 S	0.4	2.6
B	0	176	FL 3 S	0.5	2.5
3	5	53	FL 3 S	0.6	2.4
C	0	192	FL 3 S	0.7	2.3
D	0	208	FL 3 S	1.0	2.0
2	2	34	ISO 3 S	1.5	1.5
5	4	84	OC 3 S	2.0	1.0
E	2	226	OC 3 S	2.5	0.5
4	6	70	OC 3.5 S	2.5	1.0
4	5	69	FL 4 S	0.2	3.8
5	5	85	FL 4 S	0.3	3.7
E	0	224	FL 4 S	0.4	3.6
F	0	240	FL 4 S	0.5	3.5
6	5	101	FL 4 S	0.6	3.4
0	1	1	FL 4 S	0.8	3.2
1	1	17	FL 4 S	1.0	3.0
2	1	33	FL 4 S	1.5	2.5
3	2	50	ISO 4 S	2.0	2.0
3	6	54	OC 4 S	2.5	1.5
F	2	242	OC 4 S	3.0	1.0
3	1	49	FL 4.3 S	1.3	3.0
8	5	133	FL 5 S	0.2	4.8
4	1	65	FL 5 S	0.3	4.7
5	1	81	FL 5 S	0.5	4.5
9	5	149	FL 5 S	0.9	4.1
6	1	97	FL 5 S	1.0	4.0

SWITCH		IR Controller	FLASH CODE	ON	OFF
A	B				
7	1	113	FL 5 S	1.5	3.5
4	2	66	ISO 5 S	2.5	2.5
8	2	130	LFL 5 S	2.0	3.0
0	3	3	OC 5 S	3.0	2.0
1	3	19	OC 5 S	4.0	1.0
2	3	35	OC 5 S	4.5	0.5
C	6	198	FL 6 S	0.2	5.8
B	5	181	FL 6 S	0.3	5.7
C	5	197	FL 6 S	0.4	5.6
8	1	129	FL 6 S	0.5	5.5
9	1	145	FL 6 S	0.6	5.4
A	1	161	FL 6 S	1.0	5.0
7	5	117	FL 6 S	1.2	4.8
B	1	177	FL 6 S	1.5	4.5
5	2	82	ISO 6 S	3.0	3.0
9	2	146	LFL 6 S	2.0	4.0
6	4	100	OC 6 S	4.0	2.0
3	3	51	OC 6 S	4.5	1.5
4	3	67	OC 6 S	5.0	1.0
A	4	164	FL 7 S	1.0	6.0
9	6	150	FL 7 S	2.0	5.0
5	6	86	OC 7 S	4.5	2.5
D	5	213	FL 7.5 S	0.5	7.0
C	1	193	FL 7.5 S	0.8	6.7
E	5	229	FL 8 S	0.5	7.5
B	4	180	FL 8 S	1.0	7.0
6	2	98	ISO 8 S	4.0	4.0
A	2	162	LFL 8 S	2.0	6.0
6	6	102	OC 8 S	5.0	3.0
B	2	178	LFL 8 S	3.0	5.0
F	5	245	FL 9 S	0.9	8.1
C	4	196	FL 9 S	1.0	8.0
7	6	118	OC 9 S	6.0	3.0
0	6	6	FL 10 S	0.2	9.8
1	6	22	FL 10 S	0.3	9.7
D	1	209	FL 10 S	0.5	9.5
2	6	38	FL 10 S	0.8	9.2
E	1	225	FL 10 S	1.0	9.0
1	4	20	FL 10 S	1.5	8.5
C	2	194	LFL 10 S	2.0	8.0
D	2	210	LFL 10 S	3.0	7.0
7	2	114	ISO 10 S	5.0	5.0
2	4	36	LFL 10 S	4.0	6.0
8	6	134	OC 10 S	6.0	4.0
5	3	83	OC 10 S	7.0	3.0
6	3	99	OC 10 S	7.5	2.5
F	1	241	FL 12 S	1.2	10.8
D	4	212	FL 12 S	2.5	9.5
3	4	52	LFL 12 S	2.0	10.0
0	2	2	FL 15 S	1.0	14.0
4	4	68	LFL 15 S	4.0	11.0
7	4	116	OC 15 S	10	5.0
A	6	166	LFL 20 S	2.0	18.0
E	4	228	FL 26 S	1.0	25.0

SWITCH		IR Controller		FLASH CODE	ON	OFF	ON	OFF
A	B							
0	A	10	FL (2) 4 S	0.5	1.0	0.5	2.0	
E	B	235	VQ (2) 4 S	0.2	1.0	0.2	2.6	
1	A	26	FL (2) 4.5 S	0.3	1.0	0.3	2.9	
2	A	42	FL (2) 4.5 S	0.4	1.0	0.4	2.7	
3	A	58	FL (2) 4.5 S	0.5	1.0	0.5	2.5	
F	9	249	FL (2) 5 S	0.2	0.8	0.2	3.8	
2	C	44	FL (2) 5 S	0.2	1.2	0.2	3.4	
4	A	74	FL (2) 5 S	0.4	0.6	0.4	3.6	
0	7	7	FL (2) 5 S	0.5	1.0	0.5	3.0	
1	7	23	FL (2) 5 S	1.0	1.0	1.0	2.0	
9	B	155	Q (2) 5 S	0.3	0.7	0.3	3.7	
2	9	41	Q (2) 5 S	0.5	0.5	0.5	3.5	
5	A	90	FL (2) 5.5 S	0.4	1.4	0.4	3.3	
7	8	120	FL (2) 6 S	0.3	0.6	1.0	4.1	
A	A	170	FL (2) 6 S	0.3	0.9	0.3	4.5	
6	A	106	FL (2) 6 S	0.3	1.0	0.3	4.4	
7	A	122	FL (2) 6 S	0.4	1.0	0.4	4.2	
9	9	153	FL (2) 6 S	0.5	1.0	0.5	4.0	
2	8	40	FL (2) 6 S	0.8	1.2	0.8	3.2	
3	7	55	FL (2) 6 S	1.0	1.0	1.0	3.0	
3	9	57	Q (2) 6 S	0.3	0.7	0.3	4.7	
A	9	169	FL (2) 7 S	1.0	1.0	1.0	4.0	
7	B	123	FL (2) 8 S	0.4	0.6	2.0	5.0	
8	A	138	FL (2) 8 S	0.4	1.0	0.4	6.2	
4	7	71	FL (2) 8 S	0.5	1.0	0.5	6.0	
8	8	136	FL (2) 8 S	0.8	1.2	2.4	3.6	
5	7	87	FL (2) 8 S	1.0	1.0	1.0	5.0	
4	C	76	OC (2) 8 S	3.0	2.0	1.0	2.0	
5	C	92	OC (2) 8 S	5.0	1.0	1.0	1.0	
F	B	251	VQ (2) 8 S	0.2	1.0	0.2	6.6	
9	A	154	FL (2) 10 S	0.4	1.6	0.4	7.6	
6	7	103	FL (2) 10 S	0.5	1.0	0.5	8.0	
7	7	119	FL (2) 10 S	0.5	1.5	0.5	7.5	
6	9	105	FL (2) 10 S	0.5	2.0	0.5	7.0	
8	7	135	FL (2) 10 S	0.8	1.2	0.8	7.2	
B	9	185	FL (2) 10 S	1.0	1.0	1.0	7.0	
9	7	151	FL (2) 10 S	1.0	1.5	1.0	6.5	
4	9	73	Q (2) 10 S	0.6	0.4	0.6	8.4	
B	A	186	FL (2) 12 S	0.4	1.0	0.4	10.2	
C	9	201	FL (2) 12 S	0.5	1.0	0.5	10.0	
D	9	217	FL (2) 12 S	1.5	2.0	1.5	7.0	
A	8	168	FL (2) 15 S	0.5	1.5	2.0	11.0	
A	7	167	FL (2) 15 S	1.0	2.0	1.0	11.0	
8	B	139	Q (2) 15 S	0.2	0.8	0.2	13.8	
C	A	202	FL (2) 20 S	1.0	3.0	1.0	15.0	
D	A	218	FL (2) 25 S	1.0	1.0	1.0	22.0	

SWITCH		IR Controller		FLASH CODE	ON	OFF	ON	OFF	ON	OFF
A	B									
7	9	121	Q (3) 5 S	0.5	0.5	0.5	0.5	0.5	2.5	
5	9	89	VQ (3) 5 S	0.2	0.3	0.2	0.3	0.2	3.8	
0	C	12	VQ (3) 5 S	0.3	0.2	0.3	0.2	0.3	3.7	
E	9	233	VQ (3) 5 S	0.3	0.3	0.3	0.3	0.3	3.5	
3	C	60	FL (3) 6 S	0.5	1.0	0.5	1.0	0.5	2.5	
2	B	43	FL (2+1) 6 S	0.3	0.4	0.3	1.2	0.3	3.5	

SWITCH		IR Controller	FLASH CODE	ON	OFF	ON	OFF	ON	OFF
A	B								
A	B	171	Q (3) 6 S	0.3	0.7	0.3	0.7	0.3	3.7
F	A	250	FL (3) 8 S	0.5	1.0	0.5	1.0	0.5	4.5
0	B	11	FL (3) 9 S	0.3	1.0	0.3	1.0	0.3	6.1
B	7	183	FL (3) 9 S	0.8	1.2	0.8	1.2	0.8	4.2
B	8	184	FL (3) 10 S	0.3	0.7	0.3	0.7	0.9	7.1
C	8	200	FL (3) 10 S	0.4	0.6	0.4	0.6	1.2	6.8
C	B	203	FL (3) 10 S	0.5	0.5	0.5	0.5	0.5	7.5
C	7	199	FL (3) 10 S	0.5	1.5	0.5	1.5	0.5	5.5
D	B	219	FL (3) 10 S	0.6	0.6	0.6	0.6	0.6	7.0
D	7	215	FL (3) 10 S	1.0	1.0	1.0	1.0	1.0	5.0
3	8	56	FL (2+1) 10 S	0.5	0.7	0.5	2.1	0.5	5.7
8	9	137	OC (3) 10 S	5.0	1.0	1.0	1.0	1.0	1.0
B	B	187	Q (3) 10 S	0.3	0.7	0.3	0.7	0.3	7.7
D	8	216	FL (2 + 1) 10 S	0.5	0.5	0.5	0.5	1.5	6.5
1	B	27	FL (3) 12 S	0.5	1.5	0.5	1.5	0.5	7.5
E	A	234	FL (3) 12 S	0.5	2.0	0.5	2.0	0.5	6.5
E	7	231	FL (3) 12 S	0.8	1.2	0.8	1.2	0.8	7.2
B	6	182	FL (3) 12 S	1.0	1.0	1.0	3.0	1.0	5.0
4	8	72	FL (2+1) 12 S	0.8	1.2	0.8	2.4	0.8	6.0
5	8	88	FL (2+1) 12 S	1.0	1.0	1.0	4.0	1.0	4.0
1	8	24	FL (2+1) 13.5 S	1.0	1.0	1.0	4.0	1.0	5.5
F	7	247	FL (3) 15 S	0.3	1.7	0.3	1.7	0.3	10.7
9	D	157	FL (3) 15 S	0.4	1.0	0.4	1.0	0.4	11.8
0	8	8	FL (3) 15 S	0.5	1.5	0.5	1.5	0.5	10.5
F	8	248	FL (2+1) 15 S	0.6	0.3	0.6	0.3	1.4	11.8
0	9	9	FL (2+1) 15 S	0.7	0.5	0.7	0.5	1.9	10.7
1	9	25	FL (2+1) 15 S	0.7	0.7	0.7	0.7	2.1	10.1
6	8	104	FL (2+1) 15 S	1.0	2.0	1.0	5.0	1.0	5.0
1	C	28	VQ (3) 15 S	0.1	0.5	0.1	0.5	0.1	13.7
4	B	75	FL (3) 20 S	0.5	3.0	0.5	3.0	0.5	12.5
3	B	59	FL (3) 20 S	0.5	1.5	0.5	1.5	0.5	15.5
5	B	91	FL (3) 20 S	0.8	1.2	0.8	1.2	0.8	15.2
6	B	107	FL (3) 20 S	1.0	1.0	1.0	1.0	1.0	15.0

SWITCH		IR Controller	FLASH CODE	ON	OFF	ON	OFF	ON	OFF	ON	OFF
A	B										
B	F	191	VQ (4) 4 S	0.3	0.3	0.3	0.3	0.3	0.3	0.3	2.3
B	D	189	Q (4) 6 S	0.3	0.7	0.3	0.7	0.3	0.7	0.3	2.7
8	D	141	Q (4) 6 S	0.4	0.6	0.4	0.6	0.4	0.6	0.4	2.6
1	D	29	FL (4) 10 S	0.5	1.0	0.5	1.0	0.5	1.0	0.5	5.0
2	D	45	FL (4) 10 S	0.8	1.2	0.8	1.2	0.8	1.2	0.8	3.2
F	E	254	Q (4) 10 S	0.3	0.7	0.3	0.7	0.3	0.7	0.3	6.7
B	E	190	FL (4) 12 S	0.3	1.7	0.3	1.7	0.3	1.7	0.3	5.7
4	F	79	FL (4) 12 S	0.5	0.5	0.5	0.5	0.5	0.5	0.5	8.5
C	E	206	FL (4) 12 S	0.5	1.5	0.5	1.5	0.5	1.5	0.5	5.5
3	D	61	FL (4) 12 S	0.8	1.2	0.8	1.2	0.8	1.2	0.8	5.2
A	D	173	Q (4) 12 S	0.3	0.7	0.3	0.7	0.3	0.7	0.3	8.7
4	D	77	FL (4) 15 S	0.5	1.5	0.5	1.5	0.5	1.5	0.5	8.5
8	E	142	FL (4) 15 S	1.0	1.0	1.0	1.0	1.0	1.0	1.0	8.0
7	D	125	FL (4) 15 S	1.5	0.5	0.5	0.5	0.5	0.5	0.5	10.5
D	E	222	FL (4) 16 S	0.5	1.5	0.5	1.5	0.5	1.5	0.5	9.5
C	D	205	FL (4) 20 S	0.3	3.0	0.3	3.0	0.3	3.0	0.3	9.8
5	D	93	FL (4) 20 S	0.5	1.5	0.5	1.5	0.5	1.5	0.5	13.5
0	D	13	FL (4) 20 S	0.5	1.5	0.5	1.5	0.5	4.5	0.5	10.5
3	F	63	FL (4) 20 S	1.5	1.5	1.5	1.5	1.5	1.5	1.5	9.5
0	F	15	Q (4) 20 S	0.5	0.5	0.5	0.5	0.5	0.5	0.5	16.5
E	E	238	Q (4) 28 S	0.5	0.5	0.5	0.5	0.5	0.5	0.5	24.5
6	F	111	FL (4) 30 S	0.5	0.5	0.5	0.5	0.5	0.5	0.5	26.5

SWITCH		IR											
A	B	Controller	FLASH CODE	ON	OFF	ON	OFF	ON	OFF	ON	OFF	ON	OFF
D	D	221	Q (5) 7 S	0.3	0.7	0.3	0.7	0.3	0.7	0.3	0.7	0.3	0.7
E	D	237	Q (5) 10 S	0.3	0.7	0.3	0.7	0.3	0.7	0.3	0.7	0.3	0.7
E	8	232	FL (5) 12 S	0.5	1.5	0.5	1.5	0.5	1.5	0.5	1.5	0.5	1.5
5	F	95	FL (5) 20 S	0.5	0.5	0.5	0.5	0.5	0.5	0.5	0.5	0.5	0.5
9	F	159	FL (5) 20 S	0.8	1.2	0.8	1.2	0.8	1.2	0.8	1.2	0.8	1.2
9	E	158	FL (5) 20 S	1.0	1.0	1.0	1.0	1.0	1.0	1.0	1.0	1.0	1.0

SWITCH		IR													
A	B	Controller	FLASH CODE	ON	OFF	ON	OFF	ON	OFF	ON	OFF	ON	OFF	ON	OFF
A	F	175	FL (6) 15 S	0.3	0.7	0.3	0.7	0.3	0.7	0.3	0.7	0.3	0.7	0.3	0.7
7	F	127	FL (6) 15 S	0.5	1.0	0.5	1.0	0.5	1.0	0.5	1.0	0.5	1.0	0.5	1.0

SWITCH		IR															
A	B	Controller	FLASH CODE	ON	OFF	ON	OFF	ON	OFF	ON	OFF	ON	OFF	ON	OFF	ON	OFF
6	E	110	VQ (6) + LFL 10 S	0.2	0.3	0.2	0.3	0.2	0.3	0.2	0.3	0.2	0.3	0.2	0.3	0.2	0.3
7	E	126	VQ (6) + LFL 10 S	0.3	0.3	0.3	0.3	0.3	0.3	0.3	0.3	0.3	0.3	0.3	0.3	0.3	0.3
2	F	47	Q (6) + LFL 15 S	0.2	0.8	0.2	0.8	0.2	0.8	0.2	0.8	0.2	0.8	0.2	0.8	0.2	0.8
2	E	46	Q (6) + LFL 15 S	0.3	0.7	0.3	0.7	0.3	0.7	0.3	0.7	0.3	0.7	0.3	0.7	0.3	0.7
3	E	62	Q (6) + LFL 15 S	0.6	0.6	0.6	0.6	0.6	0.6	0.6	0.6	0.6	0.6	0.6	0.6	0.6	0.6
8	F	143	VQ (6) + LFL 15 S	0.3	0.3	0.3	0.3	0.3	0.3	0.3	0.3	0.3	0.3	0.3	0.3	0.3	0.3

SWITCH		IR																	
A	B	Controller	FLASH CODE	ON	OFF	ON	OFF	ON	OFF	ON	OFF	ON	OFF	ON	OFF	ON	OFF	ON	OFF
4	E	78	VQ (9) 10 S	0.2	0.3	0.2	0.3	0.2	0.3	0.2	0.3	0.2	0.3	0.2	0.3	0.2	0.3	0.2	0.3
5	E	94	VQ (9) 10 S	0.3	0.3	0.3	0.3	0.3	0.3	0.3	0.3	0.3	0.3	0.3	0.3	0.3	0.3	0.3	0.3
1	F	31	Q (9) 15 S	0.2	0.8	0.2	0.8	0.2	0.8	0.2	0.8	0.2	0.8	0.2	0.8	0.2	0.8	0.2	0.8
0	E	14	Q (9) 15 S	0.3	0.7	0.3	0.7	0.3	0.7	0.3	0.7	0.3	0.7	0.3	0.7	0.3	0.7	0.3	0.7
1	E	30	Q (9) 15 S	0.6	0.6	0.6	0.6	0.6	0.6	0.6	0.6	0.6	0.6	0.6	0.6	0.6	0.6	0.6	0.6

SWITCH		IR													
A	B	Controller	FLASH CODE	ON	OFF	ON	OFF	ON	OFF	ON	OFF	ON	OFF		
MORSE CODE () INDICATES LETTER															
7	8	120	MO (A) 6 S	0.3	0.6	1.0	4.1								
7	B	123	MO (A) 8 S	0.4	0.6	2.0	5.0								
8	8	136	MO (A) 8 S	0.8	1.2	2.4	3.6								
B	8	184	MO (U) 10 S	0.3	0.7	0.3	0.7	0.9	7.1						
C	8	200	MO (U) 10 S	0.4	0.6	0.4	0.6	1.2	6.8						
D	8	216	MO (U) 10 S	0.5	0.5	0.5	0.5	1.5	6.5						
9	8	152	MO (A) 10 S	0.5	0.5	1.5	7.5								
8	9	137	MO (D) 10 S	5.0	1.0	1.0	1.0	1.0	1.0						
A	8	168	MO (A) 15 S	0.5	1.5	2.0	11.0								
F	8	248	MO (U) 15 S	0.6	0.3	0.6	0.3	1.4	11.8						
0	9	9	MO (U) 15 S	0.7	0.5	0.7	0.5	1.9	10.7						
1	9	25	MO (U) 15 S	0.7	0.7	0.7	0.7	2.1	10.1						
7	D	125	MO (B) 15 S	1.5	0.5	0.5	0.5	0.5	0.5	0.5	10.5				



Optional GPS Synchronisation

The SL-60 is available with optional GPS synchronisation to provide the user with the ability to install independently operating lanterns that all flash in synchronisation.

No additional power supplies, aerials or control systems are required, and with its microprocessor-based system, the GPS option is specifically designed to provide maximum reliability and performance over a wide range of environmental conditions.

Operating Principle

Each light operates independently and requires no operator intervention. A minimum of 4 satellites need to be in view for the built-in GPS receiver to collect time data. At dusk, the light sensor will turn the light on. If time data is available the light will come on synchronised to every other light with the same selected flash code.

Synchronisation is achieved using an internal algorithm based on the highly accurate time base and time data received from the satellites. The satellite data is provided from a number of earth stations using atomic clocks as the time base. Continuous self-checking ensures that the light will continue to run in synchronisation.

Light Activation

At power-up the microprocessor checks that the internal GPS module is programmed correctly and is able to provide valid time base and time data.

Once outside with a clear view of the sky, valid data should become available within 20 minutes.

Daylight Operation

During daylight hours the microprocessor is in idle mode to reduce power consumption. Time data continues to be updated once per second. The microprocessor will automatically exit the idle mode as soon as dark conditions are detected.

Dark Operation

When dark conditions are detected the light:

- Checks for valid time data and is turned on after a delay based on the current time and the length of the selected flash code;
- If valid time data is not detected the light will turn on after approximately 10 seconds. This light will not be synchronised.
- If the light turns on unsynchronised it will continually check for valid time data. Once valid data is found the light will automatically synchronise.

Note: Lights will not synchronise if different flash codes are selected.



Lantern Status

Two status LED's on the main printed circuit board provide the operator with an indication of the lantern status.

There is one red and one yellow status LED. The red status LED is used to indicate the health of the lantern's power system. The yellow status LED is used to indicate the operational status of the lantern.

These indicator LED's can be viewed at the base of the lens.

All Sealite boards are fitted with two Indicator LED's. These are positioned near the Flash Code Rotary Switches. Use the table below to help determine operational status.

Yellow LED	Lantern Status	Lantern	Comment
OFF	Normal	OFF	Lantern is in Daylight and in Dusk till Dawn mode or in Standby Mode
Flashing ON 0.15 seconds OFF 0.15 seconds	Normal	OFF	Light is activating and will turn on after detecting 30 seconds of continuous darkness.
Flashing 2 x quick flashes every 2 seconds (Heartbeat)	Normal	ON	Lantern is in Normal operating condition. It is not connected to any GPS synchronisation.
Flashing ON 1.5 seconds OFF 1.5 seconds	Normal	ON	Normal operating condition. Lantern is synchronised to GPS-enabled lanterns.
Flashing 1 x quick flash every 2 seconds	Normal	ON	Lantern is 're-syncing' with GPS. The lantern re-sync's with the GPS every 15 minutes.
Flashing 2 x quick flashes every 11 seconds	Normal	ON	Lantern is a Hard Wire Synchronisation Slave.

Red LED	Lantern Status	Lantern	Comment
OFF	Normal		Normal Battery Voltage
Flashing once every 1.6 seconds	Battery Voltage is 3.5 – 3.6V		Battery Voltage is between 3.5 – 3.6V
Flashing twice every 2 seconds	Battery Voltage is 3.4 – 3.5V		Battery Voltage is between 3.4 – 3.5V
Flashing 3 x times every 2 seconds	Battery Voltage is 3.2 – 3.4V		Battery Voltage is between 3.2 – 3.4V
Flashing 4 x times every 2.5 seconds	Battery Voltage is less than 3.2V		Battery Voltage is at less than 3.2V
Fixed-on	Flat Battery (<3.2V)	OFF	Flat Battery cut-off is now operational and the lantern will be off. Battery must receive charge (above 3.5V) and lantern must see daylight for at least 1 minute before resuming normal operation.
Flashing ON 1.5 seconds OFF 1.5 seconds	Battery Voltage is above 4V		Battery Voltage is above 4V. this may indicate a problem with the solar regulator.

Optional IR Remote Control

The IR remote is used to communicate with Sealite lighting products that have an IR sensor fitted. The remote control is used for the following functions:

- Flash Code: read the current flash code, configure a new flash code.
- Lamp Intensity: read the current lamp intensity, configure a new intensity level.
- Ambient Light Thresholds: read the current light thresholds, configure new ambient light thresholds.
- Perform a battery health check.

On receiving a valid key signal from the IR Remote, the light will flash once. The user should wait until the light responds to each keypress before pressing another key. If there is no response to the keypress after 3 seconds, it has not been detected by the light and the key can be pressed again.

If an invalid key is detected, the light will flash quickly 5 times. In this case, the command will have to be restarted.

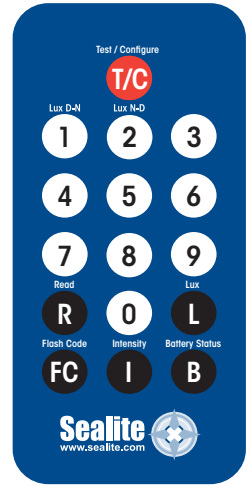

Sealite IR Controller / Universal Remote Compatibility

If you lose your Sealite IR Controller, the following Universal Remote Controller has been tested for compatibility: RCA Type RCR312WR programmed for Phillips TV Type Code 10054

Sealite Key	Universal Remote Key
T	Power
1	1
2	2
3	3
4	4
5	5
6	6
7	7
8	8
9	9
0	0
R	Channel+
L	Mute
FC	Volume+
I	Volume-
B	Channel-

IR Controller Functions

Test Mode / Configure



Pressing the T/C button for upto 5 seconds places the light in Test Mode. The light will flash once in response to the T/C button being pressed and then turn off.













Normal Operation

The light will return to normal operation once it has not detected a valid key press for 30 seconds. The light will flash once to indicate it is returning to normal operation.

Read

Pressing the Read followed by one of the configuration keys shall cause the light to flash the configured value.

Example Key Sequences:

- 

 The light flashes the 'IR Remote' number belonging to the currently set Flash Code. Refer to the Flash Code tables to match the 'IR Remote' flash number to the Flash Code.
- 

 The light flashes the current intensity setting: 1 flash for 25%, 2 for 50%, 3 for 75% and 4 for 100%.
- 

 The light flashes the current battery status.
- 

 The light flashes the sunset level in Lux, followed by a 2 second gap, followed by the sunrise level. Levels are in the range of 1 to 9.

Flash Code



This key sets the flash code on the light.

Example Key sequence:



This sets the flash code to value 123. The light responds by flashing the flash code value.

Flash Code Numbers

The lamp flashes numbers as follows: Hundreds, Tens, Ones. A value of 125 will be flashed as: 1 flash, followed by a delay, 2 flashes, followed by a delay, 5 flashes.

The flash for number 0 is one long flash.

For example if the current Flash Code is set to 51 via the AB switches, the lamp will flash number 081. For a flash code set to 01, the lamp will flash 001.

Intensity

This function sets the light intensity. Valid intensity values are 1 for 25%, 2 for 50%, 3 for 75% and 4 for 100%.



Example Key sequence:



This sets the light intensity to 25%.

Battery Status



This function reads the battery status. The response from the light is High Voltage: 4 flashes, Good Voltage: 3 flashes, Low Voltage 2 flashes, Cutoff Voltage or below: 1 flash.

Example Key sequence:



Operational Mode

Sets the Lanterns Operation mode:

- Dusk to Dawn ,
- Always On,
- Standby

Dusk to Dawn Mode: at Dusk the light sensors will turn on the light and then synchronise to every other light with the same selected flash code.

Always On: the light sensor is disabled and the light is turned on and then synchronised to every other light with the same selected flash code.

Standby Mode: manually forces the lantern to turn off, disables the GPS but with access to daylight it will still charge the battery pack.

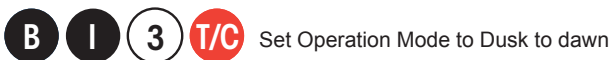
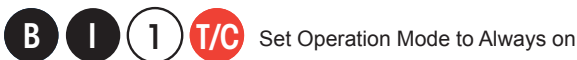

Lux



This key sets the ambient light threshold levels.

The format is



Where 'x' is the desired setting from the table below.

There are 5 programmable lux levels which are set together for the sunset and sunrise transitions.

Level	Sunset (Dusk)	Sunrise (Dawn)
1	64	100
2*	100	150
3	150	240
4	240	370
5	370	600
* Default / Factory Preset		

Example key sequence:



Assume the current Lux settings are at the factory preset values of 2.

This sets the ambient light level to be lower than the default 100 lux. The light will turn on when its surroundings are darker.

The light responds by acknowledgement with a long flash.



Error / Acknowledge Indication

If the key sequence is invalid, or an out of bounds value is attempted to be set, the light flashes 5 times for 1 second. (The command then needs to be sent from the start.)

Example key sequence: (Set the intensity level to 5 – undefined.)



The light flashes 5 times for 1 second.

When a key sequence has been entered successfully the light will respond acknowledgement with a long 1 second flash.

Configuration Settings

The intensity and flash codes can be changed using the switches on the lamp circuit board or with the IR Remote Control. The lamp intensity and flash code settings are set to the last detected change, carried out with the IR Remote Control or by changing the switch positions.

Example #1: If the intensity is set at 100% with the intensity switches, and is then set to 50% using the IR Remote Control, the intensity setting will change to 50%. If the intensity is then set to 75% using the switches, the new intensity value will be 75%.

In order to change intensity settings using the IR Remoter Control, the lamp must be powered.

The lamp can detect a change in switch settings if they are changed while the light is powered down.

Example #2: The flash code is set according to the switch settings: A=5, B = 1. The operator changes the flash code to 65 (A=4, B=1) using the IR Remote Control. The new flash code is now configured to A=4, B=1. The lamp is powered down and the operator changes the flash code switches to A=3, B=1 and powers on the light. The new flash code is now A=3, B=1. If the flash code is read from the light using the IR Remote Control, the lamp will flash 49 which is the corresponding number for switches A=3, B=1.

Use the IR Remote Control to read the current lamp intensity setting and flash code.

Hibernation Mode (Advanced users)



For situations where the lantern is put into storage for a known period, the IR Remote control can be used to configure the lantern into Hibernation Mode for a user programmable date range.

Hibernation Mode maximises conservation of the battery power by disabling the light (will not activate at night) and shutting off the GPS receiver to rely on the internal clock for date checking. The IR sensor is still monitored in hibernation mode. Power consumption is only bettered by physically disconnecting the battery supply.

Hibernation Mode is defined by a start date and end date that are programmed into the lantern via the IR Remote Control.

Using the IR Remote Control

The lantern must be in Test Mode prior to pressing any of the following key sequences. However, the lantern will return to Normal Operation if it has not detected a valid key press for a period of 15 seconds. When the lantern exits from Test Mode it will either enter Dusk to Dawn mode, Hibernation mode, or Storage Mode, if enabled.

Store Hibernation Mode Date Range

The following details the key press sequence that defines the start and end dates of Hibernation Mode:



where **ddmm** is the numerical representation of the month (01=January, 08=August) of the start date, and **DDMM** is the numerical representation of the end date.

e.g 9th of December is represented by the number sequence 0912.

The lantern will respond by flashing an acknowledge long flash.

This operation only stores the start & end dates into the lantern's memory and Hibernation Mode still must be enabled to commence its operation.

Enable Hibernation Mode

Pressing the following key sequence will enable (turn on) Hibernation Mode:



and the lantern will respond with a single flash.

The Lantern will take a new GPS reading, determine the calendar month, and then enter Hibernation Mode and depending on the current calendar month setting will either Hibernate or enter Dusk-to-Dawn mode.

By default, Hibernation mode is disabled. Note you can only use this command once a valid hibernation start & end date has been stored in the lantern.

Disable Hibernation / Hibernation Modes

Pressing the following key sequence will disable (turn off) both Hibernation Mode and Seasonal Hibernation:



and the lantern will respond with a single long flash.

The Lantern will disable Hibernation Mode and enter Dusk-to-Dawn Mode.

Momentarily Wake Up from Hibernation Mode

Pressing the  button will wake up the lantern.

At which point the lantern will remain awake for a further 15 seconds to process other commands from the IR Controller. If no IR commands are received for a period of 15 seconds, the lantern will return to Hibernation mode.

Read Stored Hibernation Dates

By pressing the following key sequence the lantern will respond with the stored start and end dates for Hibernation:



Read Hibernation Mode Status

By pressing the following key sequence the lantern will respond with status of Hibernation mode.



Where:

- A single long flash = hibernation mode is Enabled
- Two quick flashes = hibernation mode is Disabled.

User Case Example: Configuring the lantern for Hibernation

In this example, we want the lantern to hibernate each year from Dec 10th, through to February 15th, and the lantern is located inside a storage warehouse.

The required key sequence is:

Command	IR Controller Key Press
Store the Hibernation Date Range	<p>A sequence of eleven circular buttons: black 'L', black 'I', white '1', white '0', white '1', white '2', white '1', white '5', white '0', white '2', and red 'T/C'.</p>
Enable Hibernation	<p>A sequence of four circular buttons: black 'L', black 'I', white '1', and red 'T/C'.</p>



Storage Mode (Advanced users)

For situations where the lantern is put into storage and it will not have access to daylight, the IR Remote control can be used to configure the lantern into Storage Mode.

You have four minutes to put it a dark environment otherwise it will exit this mode

The lantern will not respond to IR commands. To exit this mode, expose the lantern to daylight for at least 15seconds.

The lantern will automatically enter Storage Mode if it has not detected any light for 20 hours.

Enter Storage Mode

By pressing the following key sequence the lantern will enter Storage Mode:



The lantern will leave storage mode when exposed to daylight or if the power switch is turned OFF and ON again.



Maintenance and Servicing

Designed to be maintenance free, the SL-60 requires minimal attention, though the following maintenance and servicing information is provided to help ensure the life of your Sealite product.

1. **Cleaning Solar Panels** - occasional cleaning of the solar panels may be required. Using a cloth and warm soapy water, wipe off any foreign matter before rinsing the panels with fresh water.
2. **Battery Check** - inspection of batteries should be performed every three years (minimum) to ensure that the charger, battery and ancillary electronics are functioning correctly. Using a voltage meter, check that the battery voltage is at least 3.6 volts under 100MA load, and ensure all terminals are clear of foreign matter.

Replacing the battery- Don't throw the unit out!!

The SL-60 lanterns are the only compact marine lantern with a double sealed battery compartment. This provides the user with the ability to change the battery after years of operation.

1. Remove the marked flash adjustment bung from the base of the lantern and set internal toggle switch to 'OFF'.
2. Unscrew small screws to remove battery plate.
3. Remove battery from SL-60 case and unscrew positive and negative leads.
4. Discard old battery in a safe manner.
5. Reattach positive and negative leads to new battery and then place back into case.
6. Reattach battery plate and switch lantern 'ON' via internal switch. Close the bung.
7. To test place dark cover (towel or jacket) on top of light to activate sensor, light will come on.

Care must be taken to observe the polarity of the battery before the leads are re-connected, and ensure the replacement battery is correctly fitted. Always discard old batteries in a safe manner.

Long Term Storage Instructions

If the SL-60 is to be placed in storage for an extended period, being more than 5 months, please follow the below steps.

1. The 3.6V NiMH Battery must be stored in a fully charged condition.
2. Remove the Flash Adjustment plug and turn the ON/OFF switch to the OFF position.
3. Remove the battery cover and disconnect the Positive (+) Terminal.
4. Fold the Terminal away from the Negative Battery Terminal.
5. Replace the Battery Cover
6. Replace the Flash Adjustment Plug.

All batteries will discharge over time and the rate of discharge is dependent on temperature. If the light is being stored in temperatures greater than 40°C the battery will discharge faster.

Please check battery every 3-6 months and recharge if necessary.

Recharging the Battery

1. Remove the Battery Cover and connect the Positive Terminal.
2. Remove the Flash Adjustment Plug and turn the ON/OFF switch to the ON position.
3. Reconnect the battery and place unit in the sun for 2-4 days

Or

Reconnect battery and place in front of a halogen lamp for 2-3 days. (Do not place the halogen light too close to the solar panel or the panel may be overheated)

Check the battery voltage regularly to make sure the unit is charging correctly.

After the battery has been recharged, switch the light OFF.

Trouble Shooting

Problem	Remedy
Lantern will not activate.	<ul style="list-style-type: none"> • Ensure internal toggle switch is set to the 'ON position. • Ensure lantern is in darkness. • Wait at least 60 seconds for the program to initialise in darkness. • Ensure switch setting is on a valid code (See <i>Flash Codes</i> section of this manual). • Ensure battery terminals are properly connected. • Ensure battery voltage is above 3.4volts.
Timing codes will not change.	<ul style="list-style-type: none"> • Turn rotary switches several times to ensure contacts are clear.
Lantern will not operate for the entire night.	<ul style="list-style-type: none"> • Expose lantern to direct sunlight and monitor operation for several days. Sealite products typically require 1.5 hours of direct sunlight per day to retain full autonomy. From a discharged state, the lantern may require several days of operational conditions to 'cycle' up to full autonomy. • Reducing the light output intensity or duty cycle (flash code) will reduce current draw on the battery. • Ensure solar module is clean and not covered by shading during the day.
Lantern is constantly on during the day.	<ul style="list-style-type: none"> • Ensure the flash code is not set to F F. This flash code is for testing purposes only and will be steady on for 24 hours a day.



Sealite LED Light Warranty V2.2

Activating the Warranty

Upon purchase, the Sealite Pty Ltd warranty must be activated for recognition of future claims. To do this you need to register on-line. Please complete the Online Registration Form at:

www.sealite.com

Sealite Pty Ltd will repair or replace your LED light in the event of electronic failure for a period of up to three years from the date of purchase, as per the terms & conditions below.

Sealite Pty Ltd will repair or replace any ancillary or accessory products in the event of failure for a period of up to one year from the date of purchase, as per the terms & conditions below.

The unit(s) must be returned to Sealite freight prepaid.

Warranty Terms

1. Sealite Pty Ltd warrants that any Sealite marine products fitted with telemetry equipment including but not limited to AIS, GSM, GPS or RF ("Telemetry Products") will be free from defective materials and workmanship under normal and intended use, subject to the conditions hereinafter set forth, for a period of twelve (12) months from the date of purchase by the original purchaser.
2. Sealite Pty Ltd warrants that any BargeSafe™ Series of LED barge light products ("BargeSafe™ Products") will be free from defective materials and workmanship under normal and intended use, subject to the conditions hereinafter set forth, for a period of twelve (12) months from the date of purchase by the original purchaser.
3. Sealite Pty Ltd warrants that any LED area lighting products ("Area Lighting Products") but not including sign lighting products will be free from defective materials and workmanship under normal and intended use, subject to the conditions hereinafter set forth, for a period of twelve (12) months from the date of purchase by the original purchaser.
4. Sealite Pty Ltd warrants that any ancillary products and accessories, not mentioned in other clauses in this section, will be free from defective materials and workmanship under normal and intended use, subject to the conditions hereinafter set forth, for a period of twelve (12) months from the date of purchase by the original purchaser.
5. Sealite Pty Ltd warrants that any LED sign lighting products ("Sign Lighting Products") will be free from defective materials and workmanship under normal and intended use, subject to the conditions hereinafter set forth, for a period of three (3) years from the date of purchase by the original purchaser.
6. Sealite Pty Ltd warrants that any Sealite marine lighting products other than the Telemetry Products, BargeSafe™ Products, and Area Lighting Products ("Sealite Products") will be free from defective materials and workmanship under normal and intended use, subject to the conditions hereinafter set forth, for a period of three (3) years from the date of purchase by the original purchaser.
7. Sealite Pty Ltd will repair or replace, at Sealite's sole discretion, any Telemetry Products, BargeSafe™ Products, Area Lighting Products or Sealite Products found to be defective in material and workmanship in the relevant warranty period so long as the Warranty Conditions (set out below) are satisfied.
8. If any Telemetry Products, BargeSafe™ Products, Area Lighting Products or Sealite Products are fitted with a rechargeable battery, Sealite Pty Ltd warrants the battery will be free from defect for a period of one (1) year when used within original manufacturer's specifications and instructions.
9. Buoy products are covered by a separate 'Sealite Buoy Warranty'.

Warranty Conditions

This Warranty is subject to the following conditions and limitations;

1. The warranty is applicable to lanterns manufactured from 1/1/2009.
2. The warranty is void and inapplicable if:
 - a. the product has been used or handled other than in accordance with the instructions in the owner's manual and any other information or instructions provided to the customer by Sealite;
 - b. the product has been deliberately abused, or misused, damaged by accident or neglect or in being transported; or
 - c. the defect is due to the product being repaired or tampered with by anyone other than Sealite or

- authorised Sealite repair personnel.
3. The customer must give Sealite Pty Ltd notice of any defect with the product within 30 days of the customer becoming aware of the defect.
 4. Rechargeable batteries have a limited number of charge cycles and may eventually need to be replaced. Typical battery replacement period is 3-4 years. Long term exposure to high temperatures will shorten the battery life. Batteries used or stored in a manner inconsistent with the manufacturer's specifications and instructions shall not be covered by this warranty.
 5. No modifications to the original specifications determined by Sealite shall be made without written approval of Sealite Pty Ltd.
 6. Sealite lights can be fitted with 3rd party power supplies and accessories but are covered by the 3rd party warranty terms and conditions.
 7. The product must be packed and returned to Sealite Pty Ltd by the customer at his or her sole expense. Sealite Pty Ltd will pay return freight of its choice. A returned product must be accompanied by a written description of the defect and a photocopy of the original purchase receipt. This receipt must clearly list model and serial number, the date of purchase, the name and address of the purchaser and authorised dealer and the price paid by the purchaser. On receipt of the product, Sealite Pty Ltd will assess the product and advise the customer as to whether the claimed defect is covered by this warranty.
 8. Sealite Pty Ltd reserves the right to modify the design of any product without obligation to purchasers of previously manufactured products and to change the prices or specifications of any product without notice or obligation to any person.
 9. Input voltage shall not exceed those recommended for the product.
 10. Warranty does not cover damage caused by the incorrect replacement of battery in solar lantern models.
 11. This warranty does not cover any damage or defect caused to any product as a result of water flooding or any other acts of nature.
 12. There are no representations or warranties of any kind by Sealite or any other person who is an agent, employee, or other representative or affiliate of Sealite, express or implied, with respect to condition of performance of any product, their merchantability, or fitness for a particular purpose, or with respect to any other matter relating to any products.

Limitation of Liability

To the extent permitted by acts and regulations applicable in the country of manufacture, the liability of Sealite Pty Ltd under this Warranty will be, at the option of Sealite Pty Ltd, limited to either the replacement or repair of any defective product covered by this Warranty. Sealite will not be liable to Buyer for consequential damages resulting from any defect or deficiencies.

Limited to Original Purchaser

This Warranty is for the sole benefit of the original purchaser of the covered product and shall not extend to any subsequent purchaser of the product.

Miscellaneous

Apart from the specific warranties provided under this warranty, all other express or implied warranties relating to the above product is hereby excluded to the fullest extent allowable under law. The warranty does not extend to any lost profits, loss of good will or any indirect, incidental or consequential costs or damages or losses incurred by the purchaser as a result of any defect with the covered product.

Warrantor

Sealite Pty Ltd has authorised distribution in many countries of the world. In each country, the authorised importing distributor has accepted the responsibility for warranty of products sold by distributor. Warranty service should normally be obtained from the importing distributor from whom you purchased your product. In the event of service required beyond the capability of the importer, Sealite Pty Ltd will fulfil the conditions of the warranty. Such product must be returned at the owner's expense to the Sealite Pty Ltd factory, together with a photocopy of the bill of sale for that product, a detailed description of the problem, and any information necessary for return shipment.

Other Sealite Products Available



**Marine Lanterns
(1-19NM)**



**Monitoring
& Control Systems**



Bridge & Barge Lights



**Marine Buoys
(up to 3mt in diameter)**



Area Lighting



**Mooring Systems
& Accessories**



Sealite
www.sealite.com

AUSTRALIA
t: +61 (0)3 5977 6128

USA
t: +1 (603) 737 1311

UNITED KINGDOM
t: +44 (0) 1502 588026

