

EPSON

GPS Sports Monitor

ProSense

J-307

User Manual

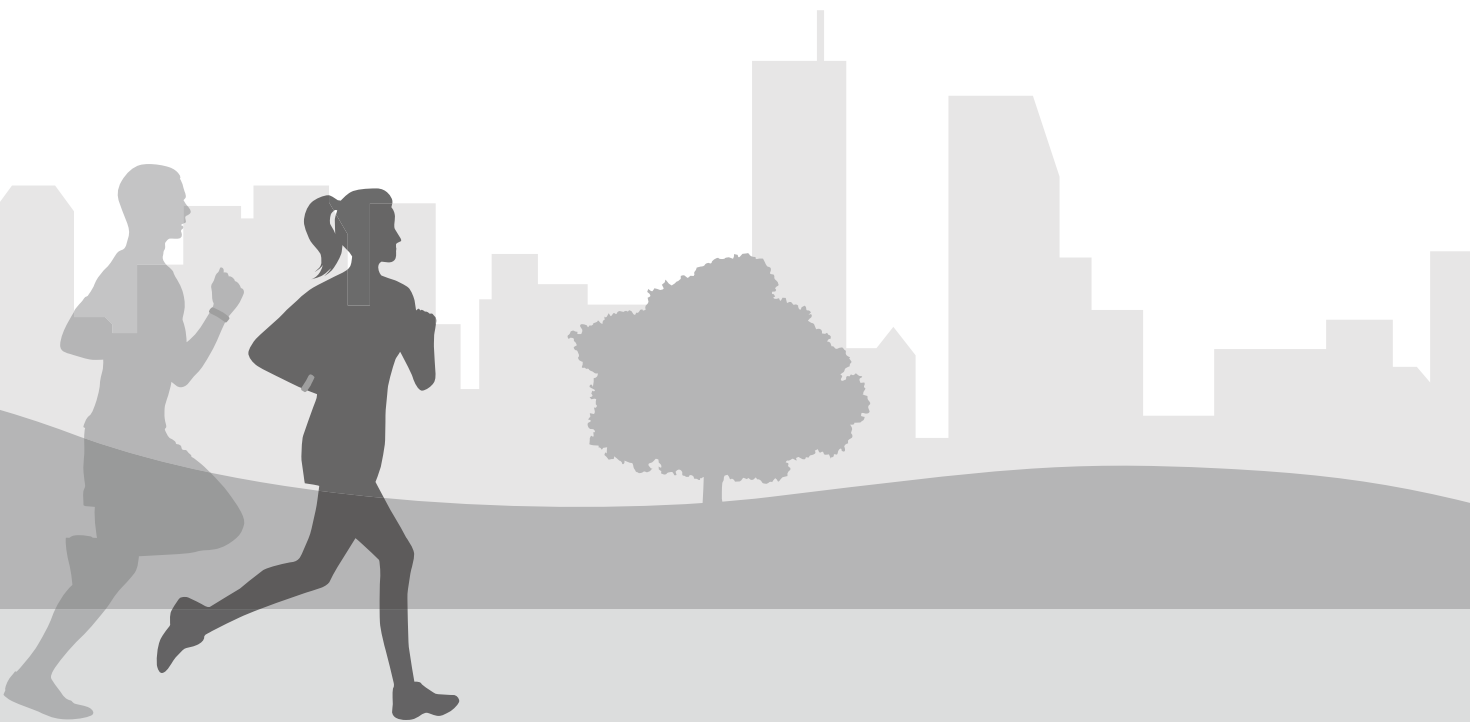

Welcome

Features

Measuring a variety of activities



Measure running, walking, bike riding, swimming and other activities, and display the results.

- ❑ Measure distance, pace, routes, and other information.
[🔗 "Measurable items" on page 33](#)
- ❑ Measure the time that has elapsed since each start (split time) and lap times.
[🔗 "Measuring workouts" on page 32](#)
- ❑ Check the measured results/data.
[🔗 "Stopping and saving measuring" on page 38](#)

This device features many other functions.

- ❑ Measure pulse (heart rate). (Pulse measurement function):
[🔗 "Measuring Pulse \(Heart Rate\) during Exercise" on page 30](#)
- ❑ AT Lap:
 Device records your lap times for distances you have set beforehand.
[🔗 "Recording laps automatically \(AT Lap\)" on page 44](#)
- ❑ AT Pause:
 The device automatically stops measuring when you stand still and then restarts measuring once you start moving again.
[🔗 "Pausing and resuming measuring automatically \(AT Pause\)" on page 46](#)
- ❑ Training:
 The device measures specific time and distance goals that you configure./
[🔗 "Measuring preconfigured time and distances \(Training\)" on page 48](#)
- ❑ Notifications:
 The device vibrates to notify you when a lap time is recorded, when a target distance has been reached, etc.
[🔗 "Vibration" on page 76](#)

Welcome

Measuring activity



Measure various daily activities such as desk work, household chores, and so on.

- ❑ Measure distance, number of steps, calories burnt, and other information.
[☞ “Measuring Daily Activity \(Meas. Activity\)” on page 61](#)
- ❑ Set a target number of steps and view your daily progress.
[☞ “Configuring a target number of steps” on page 65](#)
- ❑ View the past seven days worth of activity data.
[☞ “Checking your activity” on page 64](#)

Changing device settings



Device settings can be configured to individual preferences.

- ❑ Contrast:
 This setting is used to adjust the screen contrast.
[☞ “Contrast” on page 76](#)
- ❑ AT Light:
 This setting is used to turn on the light automatically when transitioning to different screens.
[☞ “BACKLIGHT” on page 76](#)
- ❑ Initialization:
 This setting initializes the device memory and information.
[☞ “Initializing the device” on page 88](#)

Other features

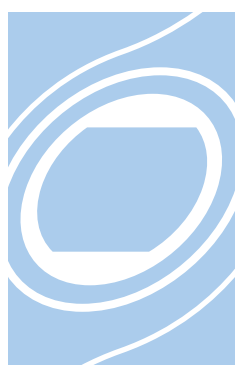

- ❑ This device supports the Quasi-Zenith Satellite System (QZSS).
- ❑ This device is equipped with a stride sensor so that your distance and pace can still be measured when in locations with poor GPS signal reception, such as in tunnels or indoors.
[☞ “About the stride sensor” on page 29](#)
- ❑ With the Epson View companion application, you can view and manage your workout and activity data from your PC or smartphone.
[☞ “Managing data with the companion application” on page 59](#)

Contents

Contents

| | |
|--|-----------|
| Welcome..... | 2 |
| Features..... | 2 |
| Overview of the ProSense..... | 7 |
| Brief description of the ProSense..... | 8 |
| Brief description of the User's Guide and Startup Guide..... | 9 |
| Descriptions in the User's Guide..... | 9 |
| Conventions used in operation procedures..... | 9 |
| Caution..... | 10 |
| Using this Device Safely..... | 11 |
| Symbols in this Manual..... | 11 |
| Product precautions..... | 11 |
| USB Charging clip precautions..... | 12 |
| Notes on electromagnetic waves..... | 13 |
| Included items and optional accessories..... | 14 |
| Included items..... | 14 |
| Optional accessories..... | 14 |
| Setup..... | 15 |
| Charging the device..... | 16 |
| Button functions..... | 19 |
| Configuring initial settings..... | 21 |
| Configuring the device directly..... | 22 |
| Device screens..... | 23 |
| Screen display..... | 23 |
| Battery levels..... | 24 |
| Locking and unlocking the buttons..... | 25 |
| Locking the buttons..... | 25 |
| Turning the device on and off..... | 26 |
| Turning on the device..... | 26 |
| Device sensors..... | 27 |
| GPS signal reception (GPS positioning)..... | 27 |
| About the stride sensor..... | 29 |
| Measuring Pulse (Heart Rate) during Exercise..... | 30 |
| Measuring Your Workout..... | 31 |
| Measuring workouts..... | 32 |
| Measurable activities..... | 32 |
| Measurable items..... | 33 |
| Measurement preparation (selecting the Activity Type)..... | 36 |
| Starting measuring..... | 37 |
| Pausing and resuming measuring..... | 37 |
| Stopping and saving measuring..... | 38 |





Contents

| | |
|---|-----------|
| Checking data during measuring. | 39 |
| Recording lap times during measuring. | 40 |
| Changing Measure Set (GPS measurement settings). | 41 |
| Configuring settings. | 41 |
| List of Measure Set. | 43 |
| Recording laps automatically (AT Lap). | 44 |
| Pausing and resuming measuring automatically (AT Pause). | 46 |
| Measuring preconfigured time and distances (Training). | 48 |
| Setting and measuring paces (target pace). | 50 |
| Setting time/distance training sessions with high/low intensity intervals(interval training). | 51 |
| Using A-GPS to reduce the GPS positioning time. | 52 |
| Configuring the operation of the backlight during measuring. | 52 |
| Configuring workout notifications. | 52 |
| Measuring time (Stopwatch). | 54 |
| | |
| Checking Workout Measurement Data. | 55 |
| Checking history data from previous measurement. | 56 |
| Measurement data that can be checked in recall. | 57 |
| Deleting measurement data from the history. | 58 |
| Managing data with the companion application. | 59 |
| Starting wireless communication. | 60 |
| | |
| Measuring Daily Activity (Meas. Activity). | 61 |
| Track activity measurement function. | 62 |
| Using track activity measurement function effectively. | 62 |
| Measuring activity. | 63 |
| Checking your activity. | 64 |
| Activity data you can check. | 64 |
| Checking current activity (Track Activity screen). | 64 |
| Checking previous activity data (Recall screen). | 65 |
| Configuring a target number of steps. | 65 |
| Checking your target number of steps progress. | 66 |
| Stop measuring your activity. | 67 |
| | |
| Usage Examples for Some Typical Scenarios. | 68 |
| Measuring marathons and walking sessions. | 69 |
| Configuring training workouts for races. | 70 |
| Configuring racing goals. | 71 |
| Checking your daily condition (Activity). | 72 |
| | |
| Changing Device Settings. | 73 |
| Changing device settings. | 74 |
| Configuring the device from a smartphone. | 74 |
| Configuring the device from a PC. | 74 |
| Configuring the device directly. | 75 |

Contents

| | |
|---|-----------|
| Settings. | 76 |
| Bluetooth. | 76 |
| Activity. | 76 |
| Vibration. | 76 |
| Display. | 76 |
| System. | 77 |
| Turn Off. | 77 |
| Certification. | 78 |
| | |
| Regular Maintenance. | 79 |
| Cleaning the device. | 80 |
| Main device and band. | 80 |
| Waterproof performance. | 82 |
| Batteries. | 82 |
| Internal rechargeable device battery. | 82 |
| Disposing of the device. | 82 |
| Problem solving. | 83 |
| Updating the firmware. | 86 |
| Checking the firmware version. | 86 |
| Updating the firmware. | 86 |
| Performing system resets. | 87 |
| Initializing the device. | 88 |
| | |
| Appendix. | 89 |
| Product specifications. | 90 |
| Device specifications. | 90 |
| Option specifications. | 91 |
| Understanding the icons. | 92 |
| Glossary. | 93 |
| Trademarks. | 95 |

Overview of the ProSense

-  ["Brief description of the ProSense" on page 8](#)
-  ["Brief description of the User's Guide and Startup Guide" on page 9](#)
-  ["Using this Device Safely" on page 11](#)
-  ["Included items and optional accessories" on page 14](#)

Overview of the ProSense

Brief description of the ProSense

This device is a sports watch designed with GPS functionality to measure and record running and other workout activity. This device also tracks and records other types of daily activity. With the Epson View companion application, you can analyze, review, and manage your workout and activity data from your PC or smartphone. You can also create and track training plans in efforts to accomplish longer term goals such as completing marathons.

Overview of the ProSense



Brief description of the User's Guide and Startup Guide

Thank you for your purchase of the GPS Sports Monitor "ProSense".

To ensure correct use of the device, make sure to read the included Startup Guide and then refer to the User's Guide as necessary.

Keep the included Startup Guide easily available when you need help with the device.

Descriptions in the User's Guide

| | |
|---|---|
|  Warning | This symbol represents precautions or instructions that must be followed. Incorrect handling due to the disregard of this information may result in product failure or incorrect operation. |
|  Caution | Indicates additional explanations and related information. |
| Menu Name | Indicates menu items displayed on the screen of the device. |
| START/STOP button | Indicates the device buttons. |
|  | Indicates related pages. Click the link in blue text to display the related page. |

Conventions used in operation procedures

| Actual procedure | Procedure as described in this document |
|--|---|
| Press the ENTER button. ▼ Press the UP or DOWN button and then select Profile . ▼ Press the ENTER button. | Press the ENTER button > press the UP or DOWN button > select Profile > and then press the ENTER button. |

Overview of the ProSense

Caution

- ❑ Unapproved copying of part or all of this guide is strictly forbidden.
- ❑ The content of this guide is subject to change without prior notice.
- ❑ Although every effort has been made to ensure the accuracy of this guide, contact us if you have any questions or notice any errors in descriptions in the content of this guide.
- ❑ Despite the preceding clause, we cannot accept any responsibility for mishandling due to errors in this guide.
- ❑ We cannot accept any responsibility for malfunctions and so on that occur due to ignoring the content of this guide, the device being handled inappropriately, repairs or modifications performed by a third party that is not our company or appointed by our company.

Overview of the ProSense

Using this Device Safely

Make sure to read the included "Using this Device Safely" document before using the product to ensure safe use.

Incorrect handling may result in product failure or incorrect operation.



- Keep the included Startup Guide and the User's Guide (this document) easily available when you need help resolving issues with the device.
- Confirm the laws and regulations of the applicable country when traveling to other countries with this device.**
- This product is not a medical device. Use this device as a workout aid.

Symbols in this Manual





The following symbols are used in this guide to indicate potentially dangerous operations or handling. Make sure you understand these warnings before using the product.

| |
|---|
|  Warning This symbol indicates information that, if ignored, could possibly result in serious personal injury. |
|---|



| |
|---|
|  Caution Ignoring these instructions and mishandling this device could cause injury or damage to property. |
|---|



| | |
|---|--|
|  | This symbol indicates an action that should be done. |
|  | This symbol indicates an action that must not be done. |

Product precautions





|  Warning | |
|--|---|
|  | Do not overexert yourself or work to exhaustion. Always seek medical attention immediately if you are feeling unwell or for any injury. |
|  | Do not watch the device while exercising. Doing so may result in tumbling or slipping. Pay close attention to your surroundings while using the device. |
| | Do not use while scuba diving. |
|  | Use of this device may result in allergic reactions, itchiness of the skin, or irritation. If your skin has a reaction to the device, first try loosening the belt and reposition the device. If the situation does not improve, immediately stop use of the device and seek medical attention. |

Overview of the ProSense

|  Warning | |
|--|--|
|  | Do not use or store this device in the following environments. Doing so may result in electric shock, fire, or product malfunction and damage. |
| | <ul style="list-style-type: none"> <input type="checkbox"/> Locations exposed to extreme temperature/humidity <input type="checkbox"/> Near volatile substances <input type="checkbox"/> Dusty places <input type="checkbox"/> Near a fire <input type="checkbox"/> Near sources of magnetic energy such as TVs, speakers, and magnetic necklaces |
| | Do not attempt to disassemble or repair this product. Doing so may cause electric shock or other accident. |
| | Do not leave this product within reach of young children. |
| | Use this product at your own risk. Seiko Epson shall not be liable for damages caused to the owner of the device or any third party. |

|  Caution | |
|--|--|
|  | If you sweat while wearing this device, remove the device and then completely wipe sweat and any dirt off your wrist and the device. Continuing to wear the device while wet with sweat or dirty may cause itchiness and irritation. |
| | This device is water resistant up to 5 bars of pressure. Do not press any buttons while the device is underwater. This may effect the quality of the waterproofing. |
| | Do not use the device while in a bath or sauna. Steam, soap, and minerals in the water could degrade water resistance or cause rust. |

USB Charging clip precautions

|  Warning | |
|--|---|
|  | Do not use a damaged USB Charging clip. Doing so may result in fire or product malfunction./ |
| | Do not use the USB Charging clip if dusty or dirty. Doing so may result in fire. |
| | Do not use the USB Charging clip if you notice any smoke, odor, or abnormal noise. Doing so may result in fire. If some abnormalities occur during use, immediately disconnect the USB Charging clip cable and contact a repair center. |
| | Do not use USB Charging clip if any foreign substances or water/other liquids get inside the device. Doing so may result in electric shock or fire./ If this happens, immediately disconnect the USB Charging clip cable and contact a repair center. |
|  | Disconnect the cable when the USB Charging clip is not in use. Metal or dust/foreign matter collecting on the terminals may result in burns or fire. |
|  | Do not use the USB Charging clip to charge other devices. This device must be charged only with the USB Charging clip. Do not use any other charging method. Doing so may result in product malfunction, electric shock, or fire. |

Overview of the ProSense

Notes on electromagnetic waves

This device is equipped with Bluetooth® Smart technology. This function enables wireless communication of measurement data between the device and a smartphone.

This device has been classified as a low electronic data communication system based on Radio Law. Therefore, this device does not require a radio station license. The following acts may be punishable by law.

- Disassembling or remodeling the device
- Removing the verification or certification number for the device

Frequency

This device uses the frequency bands 2.402 to 2.480 GHz. Other wireless devices may use the same frequency. Note the following points to avoid wireless interference with other wireless devices.

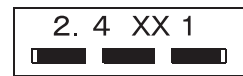



Precautions when performing wireless communication

This device operates on the 2.4 GHz band.

This device operates in the same frequency bandwidth as industrial, scientific, and medical devices such as microwave ovens and mobile object identification (RF-ID) systems (licensed premises radio stations, amateur, and unlicensed specified low-power radio stations (hereafter "other radio stations")) used in factory production lines.

1. Before using this device, make sure there are no "other radio stations" being used in the vicinity.
2. If this device causes RF interference between the device and "other radio stations", promptly move to a different location, stop using the device, and contact your local reseller to ask for advice on preventing interference (for example setting up partitions).
3. In addition, when harmful radio wave interference occurs between the device and "other radio stations", and refer to "Contacting us about this product" to contact our service centre.

|  Warning | |
|--|---|
|  | If you notice any abnormalities on your skin and so on, stop using the device immediately and contact a specialist. |
| | In areas in which usage is restricted, such as on airplanes and in hospitals, follow the rules and regulations provided (such as in-flight announcements). |
|  | Do not use the device if you have a surgically implanted medical device such as a cardiac pacemaker. |
| | Do not bring the device into an operating room, intensive care unit, and so on, and do not use the device near medical equipment. Radio waves from the device may interfere with electronic medical equipment causing the equipment to malfunction and cause an accident. |

Included items and optional accessories

Included items

Make sure you check that all of the following items have been supplied with this product. If any of these items are missing, contact your local reseller.

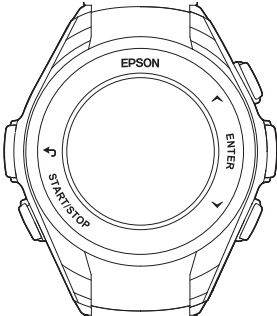
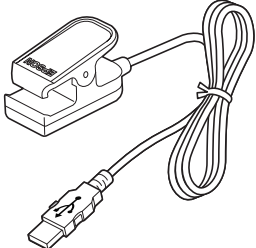
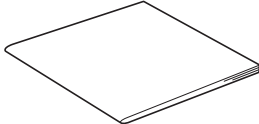





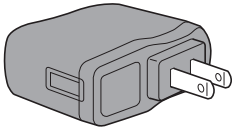
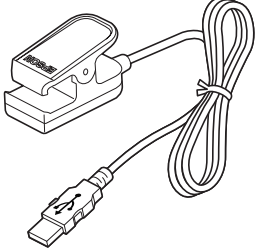

| Device | USB Charging clip (charging and communication device) | Notes on Usage Startup Guide Warranty |
|--|---|---|
|  |  |  |

Optional accessories

You can purchase the following optional extras. Contact your local reseller for more information.

| AC adapter | USB Charging clip (charging and communication device) |
|---|--|
|  |  |

Setup

-  ["Charging the device" on page 16](#)
-  ["Button functions" on page 19](#)
-  ["Configuring initial settings" on page 21](#)
-  ["Device screens" on page 23](#)
-  ["Battery levels" on page 24](#)
-  ["Locking and unlocking the buttons" on page 25](#)
-  ["Turning the device on and off" on page 26](#)
-  ["Device sensors" on page 27](#)

Charging the device

! Important

- ❑ Charge this device before using it for the first time.
- ❑ Use the specified USB Charging clip.
- ❑ Do not attach the USB Charging clip to a wet or dirty device.
Doing so may cause corrosion or malfunction of the device or USB Charging clip contact points, or communication failures.

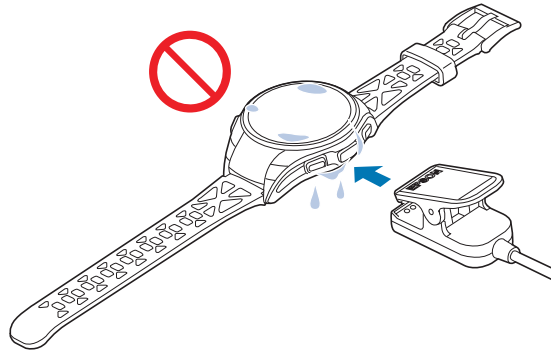

- ❑ Charge in environments with ambient temperatures of 5 to 35°C. Attempting to charge the device in any other environment causes the following charge error screen to appear and the device to stop charging. When it returns to a suitable temperature, charging resumes.

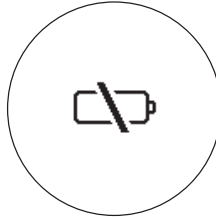

- ❑ Bluetooth is enabled when the USB Charging clip is attached to the device. Disable Bluetooth when not in use.
[👉 “ON/OFF” on page 76](#)

1 Attach the USB Charging clip to the device.

Turn the device over so that the glass faces down. Hold the device up and then attach the USB Charging clip so that the triangle marks on the back side of the device and the USB Charging clip are in alignment.

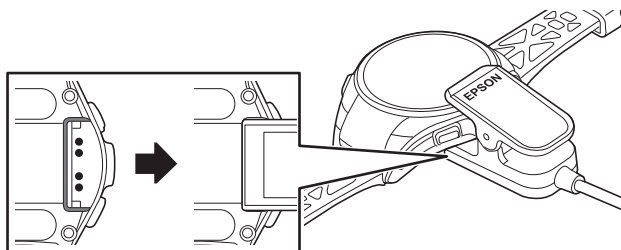

Setup

2

Start charging the device.

Two charging methods are available.

■ Using the AC adapter to charge the device

Connect the USB plug of the USB Charging clip to the USB port in the AC adapter and then connect the AC adapter to an electrical outlet.

We recommend using the optional AC adapter to charge the device. Using an incompatible AC adapter may result in failure to charge or improper operation.

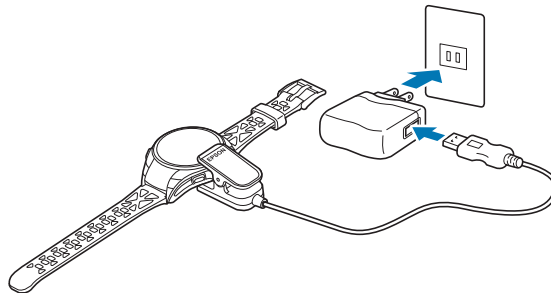

■ Using a PC to charge the device

Connect the USB plug of the USB Charging clip to the USB port in the PC.

This method will not necessarily be successful with all computers. Do not use a USB hub or other intermediate device. Connect the USB Charging clip directly to the PC.

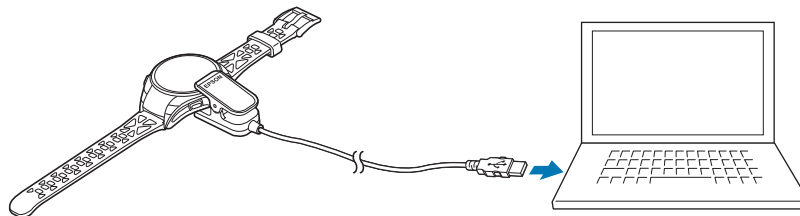

Charging will start automatically once devices are properly connected. The typical average time to fully charge the device is 2.5 to 3.5 hours. This can vary depending on conditions.

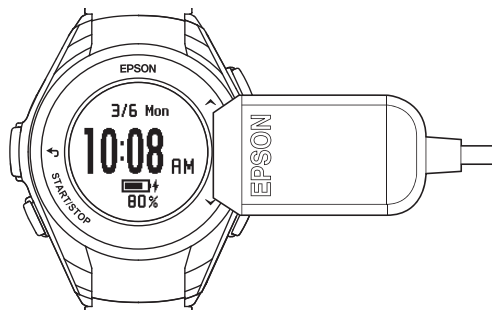

Note

You can use the Epson View companion application to configure initial settings from the PC while charging the device. Visit the following website to download Epson View, create an account, and learn how to use the application to configure the device and perform other operations.

<https://view.epson.com/>

Setup

- 3** Check that charging is complete.

Charging is complete once the "Remove clip to setup your watch" message appears.

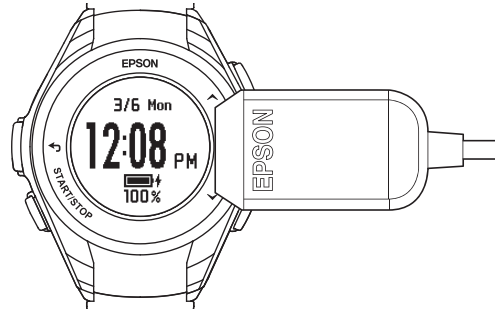

Note

- Once the device is fully charged, the overcharge prevention feature engages. The device will not be damaged even if you continue to charge the battery.
- The Time screen appears when configuring initial settings while charging the device.

- 4** After the device is fully charged, disconnect the USB Charging clip from the device. Disconnect the cable from the USB port in the PC or AC adapter.

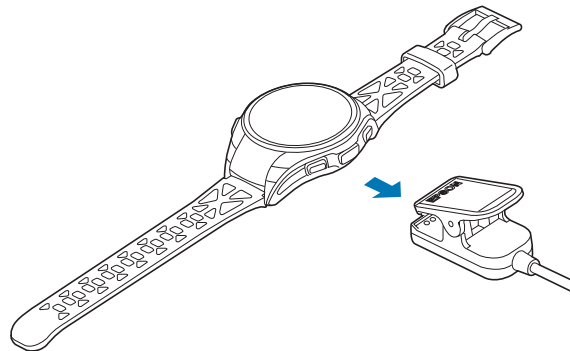



Setup



Button functions



This device is operated using the **BACK** button, **START/STOP** button, **UP** button, **ENTER** button, and **DOWN** button. These buttons have different functions depending on the displayed screen. The following table describes the button functions for each screen.

| Button | Function | | |
|--------|---|--|--|
| | Time screen/Track Activity screen* | Measurement screen | Menu/Settings screen |
| 1 |  <p>Pressing the button at the Track Activity screen displays the Time screen. Pressing and holding the button at the Track Activity screen also displays the Time screen.</p> |  <p>Pressing and holding the button while no measurement is in progress displays the Time screen.</p> |  <p>Pressing the button displays the previous screen. Pressing and holding the button displays the Time screen.</p> |
| 2 | <p>Pressing the button displays the Measurement screen.</p> <p>Pressing and holding the button turns on the device.</p> | <p>Pressing the button starts, pauses, and resumes measuring.</p> | - |
| 3 | <p>Pressing the button displays the Track Activity screen and the General Settings screen. Pressing and holding the button locks and unlocks the buttons.</p> | <p>Pressing the button switches between Measurement screens. Pressing and holding the button locks and unlocks the buttons.</p> | <p>Pressing the button selects the next option up.</p> <p>This button is also used to increase values. When entering values, pressing and holding the button increases values quickly.</p> |
| 4 | - | <p>During measuring: Records a lap time.</p> <p>Not during measurement: Pressing the button displays the Menu screen.</p> | <p>Pressing the button selects the highlighted option.</p> |

Setup

| Button | Function | | |
|--------|--|---|---|
| | Time screen/Track Activity screen [*] | Measurement screen | Menu/Settings screen |
| |  |  |  |
| 5 | Pressing the button displays the activity type for the next measurement or displays the Workout Recall screen. | Pressing the button switches between Measurement screens. | Pressing the button selects the next option down. This button is also used to decrease values. When entering values, pressing and holding the button decreases values quickly. |

*When MEAS. ACTIVITY is set to ON.

The backlight turns on for 10 seconds whenever any button is pressed.

Configuring initial settings

Initial settings include personal details such as height and weight. Configuring this information improves accuracy of the recorded data. The initial settings process starts once the USB Charging clip is removed from the device.

Configuring the device directly

1 Set the display language

Select **LANGUAGE** and then press the **ENTER** button.



2 Select the configuration method

Press the **UP** or **DOWN** button > select **Set by Watch** > and then press the **ENTER** button.

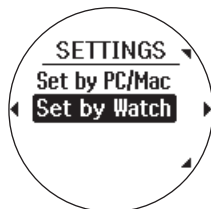

3 Enter your initial settings

Follow the on-screen instructions and enter your information for the initial settings.

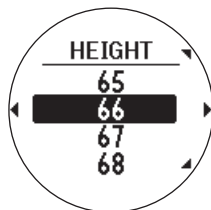

Initial settings include the following personal details.

- Height
- Weight
- Gender
- DOB
- Date and time (Year, Month, Day, AM/PM, Minutes, Seconds)*

- * To configure the date and time automatically, move to an outdoor location where there are no obstacles overhead and select **Set by GPS**.

Configuration is complete after you have finished configuring all settings and the Time screen appears.

Note

- If the device fails to acquire a GPS signal, press the **ENTER** button and configure manually, or move to another location and press the **BACK** button to start acquiring a GPS signal again.
- To edit settings or other information, press the **BACK** button to display the desired setting. The previous configuration has already been saved if you return to a setting.

Device screens

Screen display

Time screen



- 1: Current date and day
- 2: Current time
- 3: Total steps for the day and indicator of progress toward your target number of steps *
- 4: Icons that represent the status of GPS positioning, wireless communication, and battery level.

* Only when MEAS. ACTIVITY is set to **ON**.

Settings screen

Measurement screen

Activity screen

Setup

Battery levels

You can check how much charge remains from the battery icon below the time display.



Battery icon and standard usage times

| Usage function | | | | |
|----------------|---------------|--------------|--------------|-------------|
| GPS measuring | 5 to 10 hours | 2 to 5 hours | 1 to 2 hours | 0 to 1 hour |

Estimated battery life of time display operation only (no GPS measuring)

| Usage function | Maximum operation time ^{*2} |
|--|--------------------------------------|
| Meas. Activity is disabled, AUTO SLEEP is enabled ^{*1} , Bluetooth is disabled, AUTO SEARCH is disabled | 30 days |
| Meas. Activity is enabled, AUTO SLEEP is enabled ^{*1} , Bluetooth is enabled, AUTO SEARCH is disabled | 7 days |

*1 AUTO SLEEP is active for 14 hours per day (internal evaluation criteria).

*2 The operation time varies depending on the environment, which affects GPS reception, and device settings such as backlight settings.

Note

Even if the battery runs out, measurement data is stored in the main memory.

! Important

Nothing will appear in the screen when the battery level is low. If the device is left for a long time with a low battery, the performance of the rechargeable battery will deteriorate. **Make sure you charge the device at least once every six months** even when it is not being used.

Locking and unlocking the buttons

Locking the buttons



To lock the buttons, press and hold the **UP** button at the following screens.

- Time screen
- Activity screen
- Measuring screen

Unlocking the buttons

To unlock the buttons, press and hold the **UP** button.

Setup

Turning the device on and off

Turning on the device

Press and hold the **START/STOP** button for 2 seconds to turn on and start the device.



Turning off the device

Turn off the device if it will be unused for an extended period of time. To turn off the device, press the **ENTER** button at the Time screen and then select **MENU > Turn Off > Yes**.

 [“Turn Off” on page 77](#)

Device sensors

GPS signal reception (GPS positioning)

GPS positioning

GPS positioning is the process by which the device receives a GPS signal and timing information to measure routes, distance, pace, and other information.

To ensure accuracy of measurements, use the device under the following conditions in areas of good GPS signal reception.

Scenarios in which GPS positioning is used

- GPS measuring (Run or Walk measurements)
- Time synchronization (SETTINGS Set by GPS, System Update Time)

Good signal reception conditions



Locations where you cannot receive signals



Inside rooms or buildings, or underground



In tunnels



Under water

Locations that are difficult to receive signals



Locations with electronic interference, such as construction sites and heavy traffic



Near high-voltage wires or television towers, overhead electric wires for trains, and roads with skyscrapers



On water

Using the device for the first time

Before using the device for the first time after purchase, wait at least 15 minutes after initial GPS positioning outdoors with no obstructions overhead while the device displays the Measurement screen. This improves measurement accuracy.

Setup

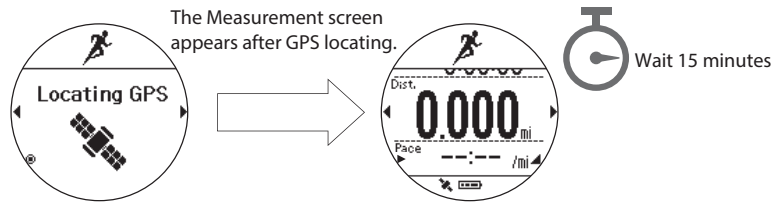

Note

- ❑ Refer to the following page for more information on GPS positioning.
 🔗 “Measurement preparation (selecting the Activity Type)” on page 36
- ❑ This process normally only needs to be performed once.
- ❑ Perform this process if the device has not been used for several months.

Note

The basic configuration of the GPS system is 24 satellites orbiting the Earth at an altitude of 20,000 km with at least four satellites traveling in six different orbits. The GPS receiver acquires data from four satellites and calculates the latitude, longitude, altitude, and time. You can start measuring once the GPS positioning has been performed and this information has been received. You can receive more detailed GPS navigation data (satellite orbital information) if you wait 15 minutes after initial GPS signal acquisition, which improves measuring accuracy.

However, note that GPS positioning is not 100% accurate or reliable at all times even with the more detailed GPS data because of atmospheric conditions and the usage environment.

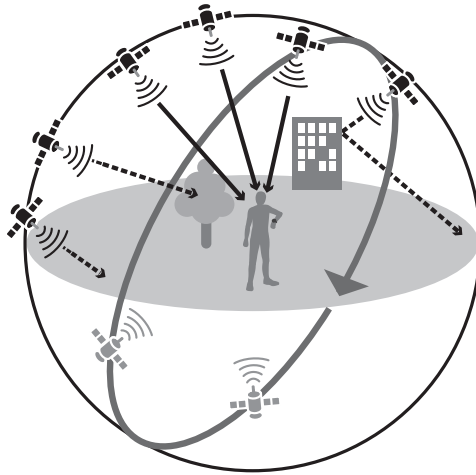

Note

AGPS - Reducing the GPS Positioning Time

You can reduce the GPS signal acquisition time by connecting the device with a smartphone and then retrieving GPS satellite information from a network server. Refer to the Epson View website for more information.

<https://view.epson.com/>

Setup

About the stride sensor

This device is equipped with a stride sensor. This sensor enables the device to continue measuring your distance and pace in locations with poor GPS signal reception, such as in tunnels or indoors.



Using the device for the first time

When using the device for the first time, run or walk for the specified time depending on the location as described in the following table to allow the device to acclimate to your stride.

| Location | Time |
|---------------------------------------|--------------------|
| Outside with no obstructions overhead | Approx. 10 minutes |
| Area with many buildings | Approx. 30 minutes |

Note

- ❑ *This process normally only needs to be performed once. However, note that information on your stride is initialized if the device is initialized. If this occurs, you need to perform the process to allow the stride sensor to acclimate to your stride again.*
- ❑ *When you mainly use the device for walking, set the activity type to **Walk**.*
🔗 “Measurement preparation (selecting the Activity Type)” on page 36
- ❑ *Significant measurement errors may occur if your stride differs significantly from that used during the stride sensor initialization session.*

Setup

Measuring Pulse (Heart Rate) during Exercise

Wear the device on your wrist and then press the [UP] button to see your pulse (heart rate).

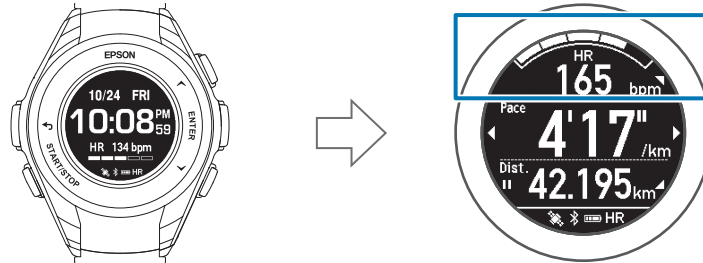









You can set five heart rate zones (within the range of the minimum and maximum heart rate) to suit the exercise intensity in User Settings.

The value in brackets () is the default setting.

| Setting items | Value | Explanation |
|---------------|---------------------------|-------------|
| HR Zone | Zone1 (30 to 100 bpm) | |
| | Zone2 (101 to 130 bpm) | |
| | Zone3 (131 to 160 bpm) | |
| | Zone4 (161 to 190 bpm) | |
| | Zone5 (191 to 240 bpm) | |

Measuring Your Workout

-  ["Measuring workouts" on page 32](#)
-  ["Checking data during measuring" on page 39](#)
-  ["Recording lap times during measuring" on page 40](#)
-  ["Changing Measure Set \(GPS measurement settings\)" on page 41](#)
-  ["Using A-GPS to reduce the GPS positioning time" on page 52](#)
-  ["Configuring the operation of the backlight during measuring" on page 52](#)
-  ["Configuring workout notifications" on page 52](#)
-  ["Measuring time \(Stopwatch\)" on page 54](#)

Measuring Your Workout

Measuring workouts

This device uses positional and time information received from GPS satellites to measure your distance, pace, and routes.

You can also measure split times and lap times during GPS measuring sessions.

Split time

Measures the elapsed time from the start.

Press the **START/STOP** button to start measuring. Press the **START/STOP** button again to stop the measuring.

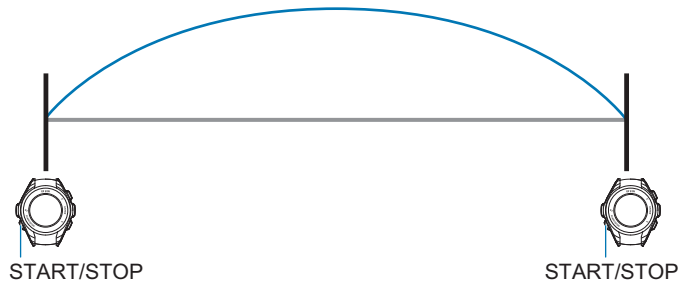

Lap time

Records the elapsed time for each lap.

Press the **ENTER** button during a measurement to record your lap time.

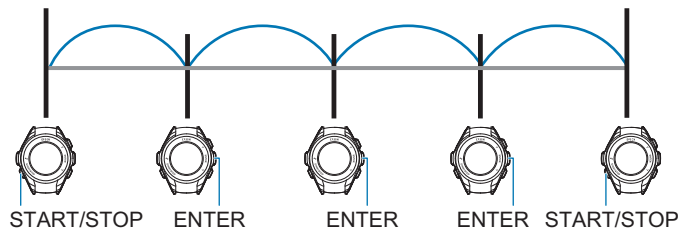

Note

When using the AT Lap function, laps are recorded automatically each time the preconfigured distance is reached.

[📖 “Recording laps automatically \(AT Lap\)” on page 44](#)

Measurable activities

| Workout | Explanation |
|-------------|-----------------------------------|
| Run | Jogging, running, marathons, etc. |
| Indoor run | Indoor running |
| Walk | Walking |
| Bike | Bike riding |
| Indoor bike | Indoor bike riding training |
| Treadmill | Using a treadmill indoors |
| Pool swim | Swimming or activities in a pool |

Measuring Your Workout

Measurable items

| Workout | Explanation |
|--------------------------------------|--|
| Split Time (Time) | Total time from the start of measurements |
| Distance (Dist.) | Total distance from the start of measurements |
| Pace (Pace) | Current pace (time per kilometer/mile) |
| Lap Time (LapTime) | Average lap time |
| Lap Pace (LapPace) | Average pace for each lap |
| Calories Burnt (Calories) | Calories burnt from the start of measurements |
| Steps (Steps) | Total number of steps since the start of measurements |
| Stride (Stride) | Current stride |
| Pitch (Pitch) | Current number of steps per minute |
| Heart rate (HR) | Current heart rate per minute |
| Time (Time of Day) | Current time |
| Estimated end distance ^{*2} | Estimated distance completed at the end of the configured time |
| Estimated end time ^{*3} | Estimated time at completion of the configured distance |

*2 When **Time** is set under **Training**

*3 When **Dist.** is set under **Training**

Measurement Screens

Press the **UP** or **DOWN** buttons at the Measurement screen to change through the different displays. Press the **ENTER** button to display the Lap screen.

Measuring Your Workout

| Screen | Settings screen | Screen 1 | Screen 2 | Screen 3 |
|-----------|--|--|---|---|
| Run | This screen displays the current settings. *1 <input type="checkbox"/> AT Lap <input type="checkbox"/> AT Pause <input type="checkbox"/> Training | <input type="checkbox"/> Time <input type="checkbox"/> Distance | <input type="checkbox"/> LapPace <input type="checkbox"/> Stride | <input type="checkbox"/> Pitch <input type="checkbox"/> Time of Day |
| Treadmill | | | <input type="checkbox"/> Calories <input type="checkbox"/> Time of Day | - |
| Walk | | | <input type="checkbox"/> Steps <input type="checkbox"/> Time of Day | <input type="checkbox"/> Calories <input type="checkbox"/> Time of Day |

Measuring Your Workout

| | Training screen ^{*2} | Interval screen | Race screen | Lap screen |
|-----------|--|-----------------|-------------|----------------------------------|
| Screen | | | | |
| Run | <input type="checkbox"/> TARGET TIME | | | <input type="checkbox"/> LapTime |
| Treadmill | <input type="checkbox"/> TARGET DIST. | | | <input type="checkbox"/> LapPace |
| Walk | <input type="checkbox"/> Estimated end time (only when a target distance has been set) <input type="checkbox"/> Estimated end distance (only when a target time has been set) | - | - | |

*1 Does not appear during measuring.

*2 Appears only when a **Time** or **Dist.** has been set.

Note

The training parameters/information that appears on screens 1 through 3 and the Lap screen can be changed.

Refer to the Epson View companion application for more information.

<https://view.epson.com/>

Measuring Your Workout

Measurement preparation (selecting the Activity Type)

At the Time screen, press the **DOWN** button to select the activity type.



The following table lists the available activities.

| Activity Type | Explanation |
|-----------------------|-----------------------------------|
| Running (Run) | Jogging, running, marathons, etc. |
| Walking (Walk) | Walking |
| Treadmill (Treadmill) | Jogging or running on a treadmill |

The device will begin GPS positioning once an activity is selected. The Measurement screen appears once the GPS positioning is complete.

Note

The device will display the Measurement screen without performing GPS positioning when **Treadmill** is selected.

Important

- ❑ Make sure the screen is facing up and you are outside with no obstructions overhead when performing GPS positioning.
 - 🔗 “GPS signal reception (GPS positioning)” on page 27
- ❑ If the device fails to acquire a GPS signal, the “Locating GPS Failed” message appears. Press the **BACK** button to try and acquire the GPS signal again. To continue your measurement without using GPS positioning, press the **ENTER** button.
- ❑ To start your measurement without waiting for the device to finish GPS positioning, press the **START/STOP** button at the screen that appears while the device acquires the GPS signal. The device will not be able to track your route while the device is still performing GPS positioning. The device will begin tracking your route as soon as it finishes GPS positioning.

🔗 “Measurable items” on page 33

Measuring Your Workout

Starting measuring

At the Measurement screen, press the **START/STOP** button to start the measuring.



! Important

- ❑ The oldest data will be overwritten when the device runs out of storage space used for measurement data. We recommend that you use the Epson View companion application to upload data after each measuring.

 [“Managing data with the companion application” on page 59](#)

- ❑ The maximum measurement time for each split lap is 13 hours. If these times are exceeded, measuring is stopped.
- ❑ The maximum number of measuring sessions is 64.

Note

The device will return to the Time screen after one hour of no operation before measuring is started or during paused measuring. The data for the paused measuring up to the point of the pause will be saved.

Pausing and resuming measuring



You can pause the measuring by pressing the **START/STOP** button during the measuring. You can then resume the measuring by pressing the **START/STOP** button again.

Measuring Your Workout

Stopping and saving measuring

1 Display the Stop menu

Press the **ENTER** button while the measuring is paused to display the Stop menu.



2 Save the data

Press the **UP** or **DOWN** button > select **Save** > and then press the **ENTER** button.



The Measurement Results screen appears with the following information.

- Activity type and date
- Measurement time
- Distance
- Split time
- Average pace
- Average stride
- Calories burnt
- Steps
- Total number of laps

Use the **UP** and **DOWN** buttons to change through the different displays./

Note

Select **Delete** if you do not want to save the data.

To resume the measuring, select **Resume** or press the **START/STOP** button.

You can return to the Time screen by waiting 15 seconds or pressing the **ENTER** button.

Measuring Your Workout

Checking data during measuring

Three different screens are available during measuring. Press the **UP** and **DOWN** buttons to switch between these screens.

The information that appears depends on the selected activity.

| | Screen 1 | Screen 2 | Screen 3 |
|-----------|--|---|---|
| Screen | | | |
| Run | <input type="checkbox"/> Time <input type="checkbox"/> Distance | <input type="checkbox"/> LapPace <input type="checkbox"/> Stride | <input type="checkbox"/> Pitch <input type="checkbox"/> Time of Day |
| Treadmill | | <input type="checkbox"/> Calories <input type="checkbox"/> Time of Day | - |
| Walk | | <input type="checkbox"/> Steps <input type="checkbox"/> Time of Day | <input type="checkbox"/> Calories <input type="checkbox"/> Time of Day |

Recording lap times during measuring

Press the **ENTER** button during measuring to record a lap.

The Display Lap screen appears for a few seconds when a lap is recorded.

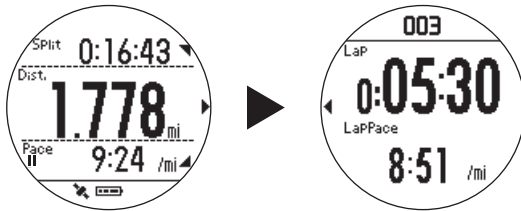
**Note**

The Display Lap screen will also appear when you have reached the distance set for the AT Lap function.

[🔗](#) “Recording laps automatically (AT Lap)” on page 44

Changing Measure Set (GPS measurement settings)

Various user-configurable measurement settings are available.

Configuring settings

- 1 Display the Workout menu
Press the **ENTER** button at the Measurement screen.



Note
This menu can also be displayed from the paused measurement screen.

Press the **UP** or **DOWN** button > select **Settings** > and then press the **ENTER** button.

- 2 Display the Settings screen
Press the **UP** or **DOWN** button > select the desired setting > and then press the **ENTER** button.

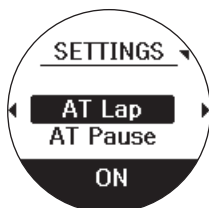

Note
The available settings vary depending on the activity.
☞ “List of Measure Set” on page 43

Measuring Your Workout

3 Configure settings

Press the **UP** or **DOWN** button > select the desired option > and then press the **ENTER** button.

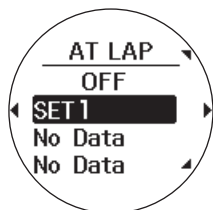
**4** Finish the configuration

Once you have configured all desired settings, press the **BACK** button to display the Measurement screen.

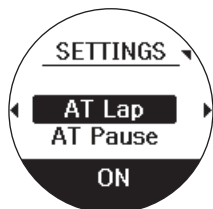
**Note**

- ❑ If you configured settings while measuring is paused, press the **BACK** button twice to display the paused measurement screen.
- ❑ You can also configure settings from a PC using Epson View. Refer to the following website for more information.

<https://view.epson.com/>

List of Measure Set

AT Lap

This function automatically records laps each time a preconfigured distance is reached.

 [“Recording laps automatically \(AT Lap\)” on page 44](#)

AT Pause (only for Run activity sessions)

This function automatically pauses your measuring when you stop running and resumes your measuring when you start running again.

 [“Pausing and resuming measuring automatically \(AT Pause\)” on page 46](#)

Training

This function measures your performance in regards to preconfigured time and distance goals and also has a mode that helps you maintain a preconfigured pace.

 [“Measuring preconfigured time and distances \(Training\)” on page 48](#)

Interval (only for Run activity sessions)

Interval training is the repetition of sprints followed by periods of rest.

You can set target times and distances to create a full workout.

The device will vibrate to notify you when to switch between each sprint and rest period.

 [“Setting time/distance training sessions with high/low intensity intervals\(interval training\)” on page 51](#)

Race (only for Run activity sessions)

This feature allows you to set a target pace so that the device will vibrate to notify you when you have deviated from the target pace.

 [“Setting and measuring paces \(target pace\)” on page 50](#)

Measuring Your Workout

Recording laps automatically (AT Lap)

This function automatically records laps each time a preconfigured distance is reached.

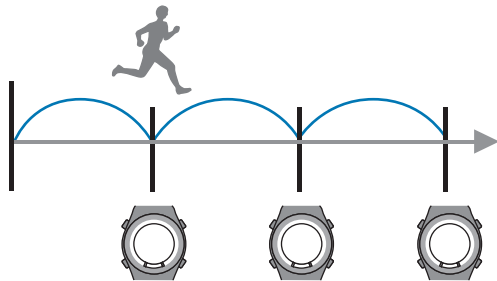

1 Display the Workout menu

Press the **ENTER** button at the Measurement screen.



Note

This menu can also be displayed from the paused measurement screen.

*Press the **UP** or **DOWN** button > select **Settings** > and then press the **ENTER** button.*



2 Display the Settings screen

Press the **UP** or **DOWN** button > select **AT Lap** > and then press the **ENTER** button.

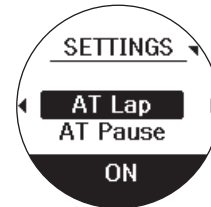

Measuring Your Workout

3 Configure settings

Press the **UP** or **DOWN** button > select **Time** or **Dist.** > and then press the **ENTER** button.

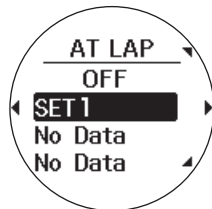
**Note**

To disable this function, select **OFF**.

4 Finish the configuration

Once you have configured all desired settings, press the **BACK** button to display the Measurement screen.

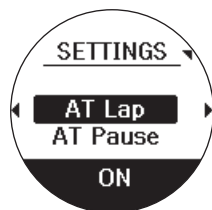
**Note**

If you configured settings while the measurement is paused, press the **BACK** button twice to display the paused measurement screen.

Measuring Your Workout

Pausing and resuming measuring automatically (AT Pause)

This function automatically pauses your measuring when you stop running and resumes your measuring when you start running again.

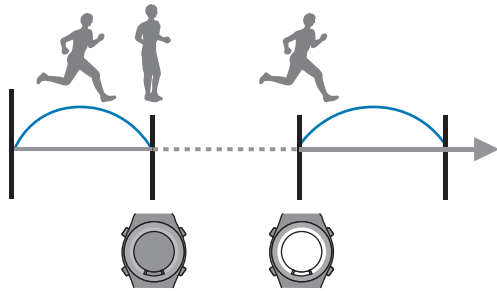

1 Display the Workout menu

Press the **ENTER** button at the Measurement screen.



Note

This menu can also be displayed from the paused measurement screen.

*Press the **UP** or **DOWN** button > select **Settings** > and then press the **ENTER** button.*



2 Display the Settings screen

Press the **UP** or **DOWN** button > select **AT Pause** > and then press the **ENTER** button.

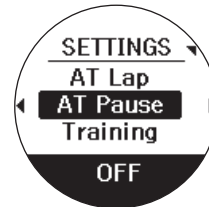

Measuring Your Workout

3 Configure settings

Press the **UP** or **DOWN** button > select **ON** > and then press the **ENTER** button.

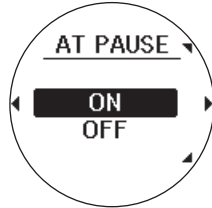
**Note**

To disable this function, select **OFF**.

4 Finish the configuration

Once you have configured all desired settings, press the **BACK** button to display the Measurement screen.

**Note**

*If you configured settings while the measurement is paused, press the **BACK** button twice to display the paused measurement screen.*

Measuring preconfigured time and distances (Training)

Training

This function measures your performance in regards to preconfigured time and distance goals and also has a mode that helps you maintain a preconfigured pace.

Time training

You configure a training time to create a timed training session.

During the session, you can check the running time and estimated end distance.

 [“Measuring Preconfigured Time and Distances \(Time/Dist.\)” on page 49](#)

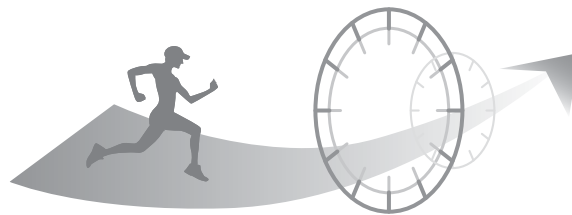

Distance training

You configure a distance to create a distance training session.

During the session, you can check the current distance and estimated arrival times.

 [“Measuring Preconfigured Time and Distances \(Time/Dist.\)” on page 49](#)



Race training (only for Run activity sessions)

This feature allows you to set a target pace so that the device will vibrate to notify you when you have deviated from the target pace.

 [“Setting and measuring paces \(target pace\)” on page 50](#)

Interval training (only for Run activity sessions)

Interval training is the repetition of sprints followed by periods of rest.

You can set target times and distances to create a full workout.

The device will vibrate to notify you when to switch between each sprint and rest period.

 [“Brief description of interval training” on page 51](#)

Measuring Your Workout

Measuring Preconfigured Time and Distances (Time/Dist.)

1 Display the Workout menu

Press the **ENTER** button at the Measurement screen.



Note

This menu can also be displayed from the paused measurement screen.

*Press the **UP** or **DOWN** button > select **Settings** > and then press the **ENTER** button.*



2 Display the Settings screen

Press the **UP** or **DOWN** button > select **Training** > and then press the **ENTER** button.



3 Configure settings

Press the **UP** or **DOWN** button > select **Time** or **Dist.** > and then press the **ENTER** button.



Note

*To disable this function, select **OFF**.*

4 Finish the configuration

Once you have configured all desired settings, press the **BACK** button to display the Measurement screen.

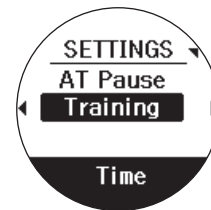

Note

*If you configured settings while the measurement is paused, press the **BACK** button twice to display the paused measurement screen.*

Setting and measuring paces (target pace)

This feature allows you to set a target pace (time per kilometer) so that the device will vibrate to notify you when you have deviated from the target pace.

This feature is only available for **Run** activity sessions.

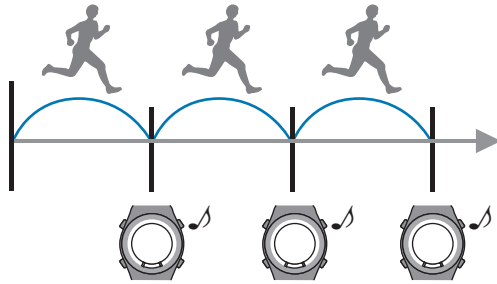
**Note**

The target pace can also be configured from a PC if you use the Epson View PC application. In this scenario, you can configure a different target pace for each lap/interval. Refer to the "Application User's Guide" for more information.

Configuring paces

Measuring

See the following page for information on measuring.

 ["Measuring workouts" on page 32](#)

Setting time/distance training sessions with high/low intensity intervals (interval training)

Brief description of interval training

Interval training is the repetition of sprints (high intensity) followed by periods of rest (low intensity).

You can set target times and distances to create a full workout.

The device will vibrate and trigger a sound to notify you when to switch between each sprint and rest period./

Sprint: High-intensity training periods

Rest: Low-intensity training periods

Number of intervals: Number of intervals of the sprint and rest periods

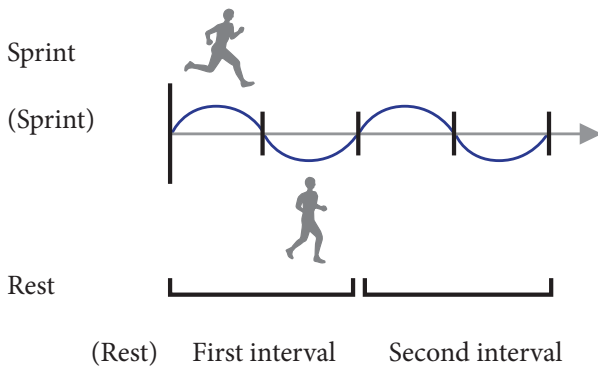

Setting conditions in your interval sessions

Note

Interval settings can also be configured from a PC if you use the PC application. [Epson View](#)

You can freely configure the number of intervals when using the PC application. Refer to the "Application User's Guide" for more information.

Setting interval conditions

Measuring

Important

- Make sure the screen is facing up and you are outside with no obstructions overhead when performing GPS positioning.

[🔗 "GPS signal reception \(GPS positioning\)" on page 27](#)

- It usually takes less than two minutes for the device to complete GPS positioning.

Measuring Your Workout

Using A-GPS to reduce the GPS positioning time

You can reduce the GPS positioning time before your walking or running session by updating the GPS information in the device./

Connect the device to a PC or smartphone and start Epson View to automatically update the GPS information in the device.

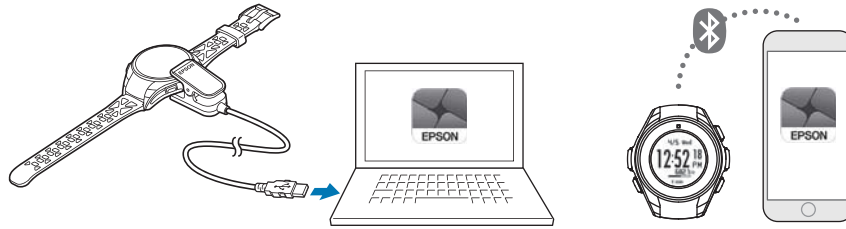

! Important

- Downloading GPS information may incur separate communication charges for which the user is responsible.
- You do not need to be outside to update the GPS information via Epson View.

Configuring the operation of the backlight during measuring

You can enable the backlight to remain on during the entire measurement.

This is useful when using the device at night.

 [“BACKLIGHT” on page 76](#)

Note

- Using the device with the backlight constantly on reduces the continuous GPS tracking time by approximately two hours.
- The backlight turns off momentarily while the device vibrates as lap or other notification. The backlight turns back on after the device stops vibrating.

Configuring workout notifications

The device can vibrate as notification such as when you complete laps or your target distance in Training mode.

The device alerts users of the following notifications.

- Completion of laps in AT Lap mode
- Pausing and resuming of measuring in AT Pause mode
- Completion of target distance or target time in Training mode

Measuring Your Workout

❑ Deviation from the target pace range in Training mode

 [“Vibration” on page 76](#)

Measuring time (Stopwatch)

Use this feature to measure only time without using GPS measuring.

Note

- ❑ *Stopwatch data is not stored in the device.*
- ❑ *This function cannot measure distance, pace, or other GPS measuring activity.*

1 Display the screen

At the Time screen, press the **DOWN** button and then select **Stopwatch**.

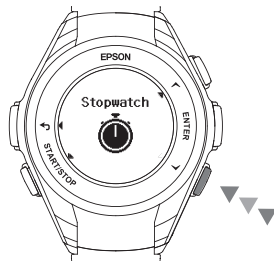

2 Starting measuring

Press the **START/STOP** button to start the stopwatch.



Button functions

START/STOP button: Starts and stops the stopwatch./

ENTER button:



Records the lap time. (During measuring)

Resets the stopwatch. (When the measuring is paused)

UP and **/DOWN** buttons when the measuring is paused:

Check recorded laps.

Checking Workout Measurement Data

-  ["Checking history data from previous measurement" on page 56](#)
-  ["Deleting measurement data from the history" on page 58](#)
-  ["Managing data with the companion application" on page 59](#)

Checking history data from previous measurement

You can check measured data on the recall screen.

Checking Workout Measurement Data

Measurement data that can be checked in recall

The following measurement data can be checked.



| Icons | |
|-------|----------------------|
| | Run activity |
| | Indoor run activity |
| | Walk activity |
| | Bike activity |
| | Indoor bike activity |
| | Treadmill activity |
| | Pool swim activity |

| Measurement data parameters | |
|-----------------------------|----------------------|
| - | Date measured |
| - | Start time/End time |
| | Distance |
| | Split time |
| | Average pace |
| | Average stride |
| HR | Heart rate |
| | Calories burnt |
| | Steps |
| | Total number of laps |

Deleting measurement data from the history

Two methods are available to delete measurement data from the history.

- ❑ Use the following procedure to delete measurement data from the history.
- ❑ To delete the entire history and all measurement data, initialize the device. Refer to the following page for more information.

 [“Initializing the device” on page 88](#)

Checking Workout Measurement Data

Managing data with the companion application

EPSON View companion application:

With this application, you can review workout measurement data and activity data from your PC.

With this application, you can review workout measurement data and activity data from your smartphone and PC.

Visit the following website to download Epson View, create an account, and learn how to upload data and perform other operations.

PC: <https://view.epson.com/>

Smartphone: Use the following QR code to access the website.

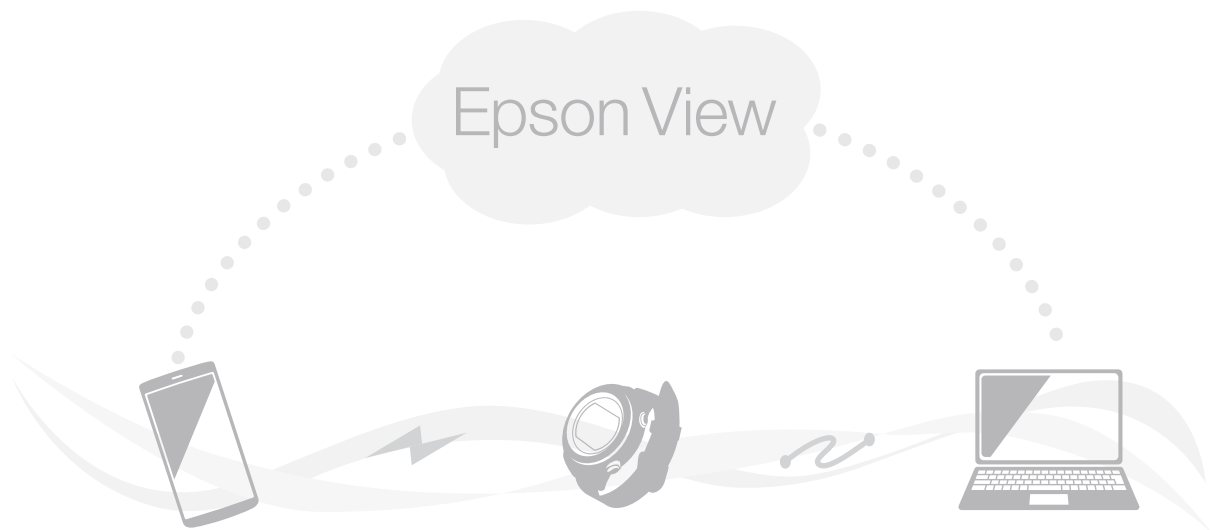

Checking Workout Measurement Data

Starting wireless communication

This section describes the procedure to start wireless communication so that the device can be paired with a smartphone.





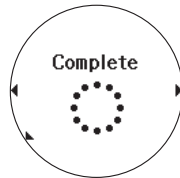

Note

- ❑ To delete the smartphone pairing, display the Settings menu, select **Smartphone** and then **Forget Device**.

The following screen appears once the pairing has been deleted. Select **Pairing Completed** to complete the operation.



Measuring Daily Activity (Meas. Activity)

-  ["Track activity measurement function" on page 62](#)
-  ["Measuring activity" on page 63](#)
-  ["Checking your activity" on page 64](#)
-  ["Configuring a target number of steps" on page 65](#)
-  ["Checking your target number of steps progress" on page 66](#)
-  ["Stop measuring your activity" on page 67](#)

Measuring Daily Activity (Meas. Activity)

Track activity measurement function

This device is equipped with functionality to measure different activities.

The device can measure daily activity such as number of steps and calories burnt while the device is worn.

Measured data is aggregated on a per-day basis and is viewable on the device or the companion application.

Data on the number of steps derived from GPS measuring, distance, calories burnt, and sleep is included in the activity data.

Using track activity measurement function effectively

Configure a target number of steps per data so that you can check your progress on the device.

 [“Configuring a target number of steps” on page 65](#)

 [“Checking your activity” on page 64](#)



Measuring Daily Activity (Meas. Activity)

Measuring activity

1 Display the General Settings screen

At the Time screen, press the **UP** button > select **Settings** > and then press the **ENTER** button.

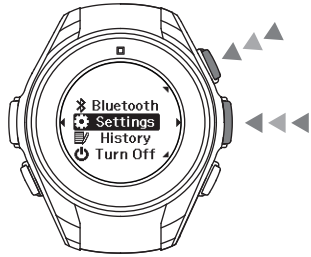

2 Display the Activity screen

Press the **UP** or **DOWN** button > select **Activity** > and then press the **ENTER** button.

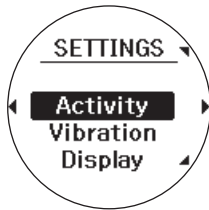

3 Display the track activity measurement screen

Press the **UP** or **DOWN** button > select **Meas. Activity** > and then press the **ENTER** button.



4 Configure settings

Press the **UP** or **DOWN** button > select **ON** > and then press the **ENTER** button.



5 Finish the configuration

Press the **BACK** button to display the Time screen.



Note

The number of steps appears on the Time screen when **MEAS. ACTIVITY** is set to **ON**.

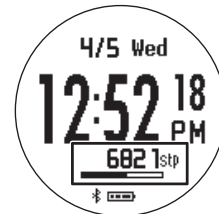

Measuring Daily Activity (Meas. Activity)





Checking your activity

Activity data you can check

The following two types of data can be checked.

- Current activity data (Track Activity screen)
- Past seven days worth of activity data (Recall screen)



| Measurement item | |
|---|-------------------|
|  | Steps |
| - | Recovery time |
|  | Mind balance |
|  | Sleep measurement |
|  | Calories |
|  | Distance |
| HR | Heart rate |
| - | Exercise |

Checking current activity (Track Activity screen)

At the Time screen, press the **UP** button to display the Track Activity screen. Press the **UP** or **DOWN** buttons to change through the different display parameters. Press the **ENTER** button at the Track Activity screen to display a graph of the past seven days worth of activity data. Press the **BACK** button to return to the Track Activity screen. At the Steps screen, press the **DOWN** button to return to the Time screen.

Note

Activity is measured on a per-day basis with a cutover time of midnight between each day.

Measuring Daily Activity (Meas. Activity)

Checking previous activity data (Recall screen)

**Important**

The device stores the past seven days worth of activity data. Older data is overwritten by the oldest data first. For this reason, we recommend that you upload data to the Epson View companion application on a timely basis.

[↗](#) “Managing data with the companion application” on page 59

Note

Activity data cannot be deleted from the **History**. To delete the activity data, initialize the device.

[↗](#) “Initializing the device” on page 88

Configuring a target number of steps

- You can track your progress towards your daily target number of steps when **Meas. Activity** is set to **ON**.
- The default target number of steps is 10,000 steps/day.

Checking your target number of steps progress

If you configure a target number of steps, the device displays a target number of steps progress indicator on the Time screen.







Stop measuring your activity

Note

Note: When Track Activity is set to OFF, the Track Activity icon  is removed from the bottom right of the Time screen (to the right of the battery icon).

The device will no longer measure your number of steps, calories burnt, or distance.

Usage Examples for Some Typical Scenarios

-  ["Measuring marathons and walking sessions" on page 69](#)
-  ["Configuring training workouts for races" on page 70](#)
-  ["Configuring racing goals" on page 71](#)
-  ["Checking your daily condition \(Activity\)" on page 72](#)

Usage Examples for Some Typical Scenarios

Measuring marathons and walking sessions

Configuring training workouts for races

Configuring racing goals

Usage Examples for Some Typical Scenarios

Checking your daily condition (Activity)

Changing Device Settings

 ["Changing device settings" on page 74](#)

 ["Settings" on page 76](#)

 ["Turn Off" on page 77](#)

Changing Device Settings

Changing device settings

This section describes the procedures to configure the device.

Configuring the device from a smartphone

You can configure this device using a smartphone.

Download and refer to the Application User's Guide for more information.

http://www.epson.jp/support/support_menu/ks/121.htm

Note

A wireless connection must be established between the device and a smartphone to configure the device using a smartphone.

 [“Starting wireless communication” on page 60](#)

Configuring the device from a PC

1 Connect the device to the PC

Attach the USB Charging clip to the device and connect the USB plug into a USB port on the PC.

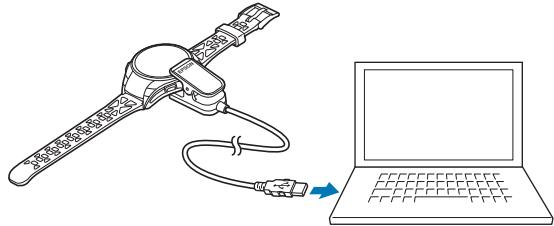

2 Configure settings

Start the Epson View companion application on the PC and configure the initial settings. Follow the on-screen instructions and enter your information.



3 Synchronize the device

After entering your initial settings, click **Next** to synchronize the device.

\\The configuration is complete once the Time screen appears on the device. Remove the USB Charging clip from the device.

Note

Visit the following website for more information on using Epson View.

 <https://view.epson.com/>

Changing Device Settings

Configuring the device directly

- 1 Display the **MENU**
At the Time screen, press the **ENTER** button.
- 2 Display the Settings screen
Press the **UP** or **DOWN** button > select **Settings** > and then press the **ENTER** button.



- 3 Select the desired setting
Press the **UP** or **DOWN** button > select a setting > and then press the **ENTER** button.

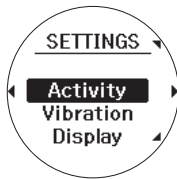

Some settings must be configured in more detail. In such cases, completely configure the setting.

- 4 Select an option/configure a value
Press the **UP** or **DOWN** button > select a setting > and then press the **ENTER** button.



Some settings must be configured in more detail. Follow the on-screen instructions.

Note

Press and hold the **UP** or **DOWN** button when entering values to increase values quickly.

 "Button functions" on page 19

- 5 Finish the configuration
Press and hold the **BACK** button.

Changing Device Settings

Settings

Bluetooth

ON/OFF

This setting is used to enable and disable Bluetooth.

Options: ON, OFF

Pairing

This is used to connect with a smartphone.

Select the device to be connected and then operate the smartphone.

Forget Device

This setting is used to delete the connection information for the smartphone. Select the desired device and then select **Forget Device**.

Activity

Step Target

This setting is used to enter a target number of steps.

Options: 100 to 30,000 steps in 100-step increments.

Meas. Activity

This setting is used to enable and disable the track activity measurement function.

Options: ON, OFF

Vibration

Alarm

This setting is used to enable and disable alarms, and configure the alarm time.

Options: ON (00:00 to 23:59), OFF

Notifications

These settings are used to enable and disable notifications such as smartphone reception of phone calls and email messages when the device is paired with a smartphone.

Non-Workout

This setting is used to enable and disable notifications at the Time screen.

Options: ON, OFF

Workout

This setting is used to enable and disable notifications at the Measurement screen.

Options: ON, OFF

Alert

This setting is used to enable or disable vibration of the device as notification such as when you complete laps or your target distance in training mode.

Options: ON, OFF

Display

Contrast

Set the contrast for the screen.

Options: High, Normal, Low

BACKLIGHT

These settings are used to configure the conditions at which the backlight turns on.

- Movement of the wrist wearing the device (Wrist turn)

Options: ON, OFF

- Pressing of any button (Button Push)

Options: ON, OFF

- During measuring (Workout)

Options: All Time, OFF

Changing Device Settings

- Triggering of a notification such as completion of a lap or target distance in Training mode (Notifications)

Options: ON, OFF

When a specified time has passed, the light automatically turns off. The backlight remains on until the end of measuring when **Workout** is selected for **All Time**.

Note

- Using the device with the backlight constantly on reduces the continuous GPS tracking time by approximately two hours.
- The backlight turns off momentarily while the device vibrates as lap or other notification. The backlight turns back on after the device stops vibrating.

AUTO SLEEP

When you leave the device for a while, this function automatically puts the device into sleep status.

Options: ON, OFF

System

Language

Set the display language.

Options: English, 日本語

Clock Set

UPDATE TIME

This setting is used to configure the current time.

Options: Set by GPS, Manual

- Set by GPS:**

The time is set in accordance with GPS positioning. This process will take a few minutes.

GPS signals cannot be received while indoors. Make sure the screen is facing up and you are **outside with no obstructions overhead**. If the device fails to complete GPS positioning after two

minutes elapses, we recommend that you select Cancel, move to a different location, and try again.

- Manual:**

Configure the time manually on the device directly.

Options: Year, Month, Date, Hour and Minutes

Time Format

Set the format for the display time.

Options: 12 Hour, 24 Hour

Display Seconds

This setting is used to enable and disable the display of seconds.

Options: ON, OFF

Auto Search

When this setting is enabled, the device will periodically perform GPS positioning whenever a measurement is in progress to reduce the initial GPS signal acquisition time before starting your next measurement.

Options: ON, OFF

RESET

Initializing the device resets all settings to their defaults (Profile/Settings), resets the stride sensor, and deletes all measurement and activity data (History).

Options: Yes, No

 [“Initializing the device” on page 88](#)

VER.INFO

Displays the firmware version information.

Turn Off







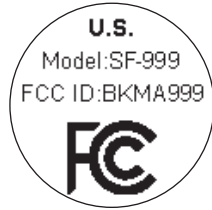

This is used to turn off the device. To turn the device on again, press and hold the **START/STOP** for 2 seconds.

Certification

This displays the device certifications.



Regular Maintenance

-  ["Cleaning the device" on page 80](#)
-  ["Waterproof performance" on page 82](#)
-  ["Batteries" on page 82](#)
-  ["Disposing of the device" on page 82](#)
-  ["Problem solving" on page 83](#)
-  ["Updating the firmware" on page 86](#)
-  ["Performing system resets" on page 87](#)
-  ["Initializing the device" on page 88](#)

Cleaning the device

Main device and band

Periodically cleaning with water

Clean the main device with water after each use or periodically. Wipe completely dry with a dry cloth after washing.

The band can be washed with a diluted mild detergent.

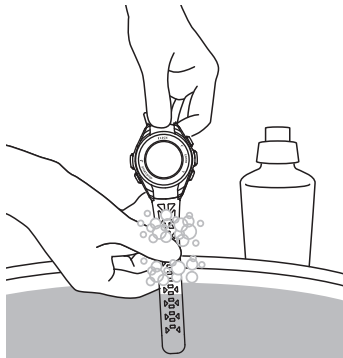

! Important

- ❑ Do not press any buttons or scrub the glass too strongly while cleaning the device. Doing so may cause malfunction or scratching of the glass.
- ❑ Do not press any buttons while the device is underwater. Doing so may result in failure.
- ❑ This strap is made from polyurethane and after years of use the color may fade or it may lose its elasticity.

Cleaning contact points

If you experience problems charging the device or using the connection, use a damp cotton swab to clean the contact points on the device and USB Charging clip.

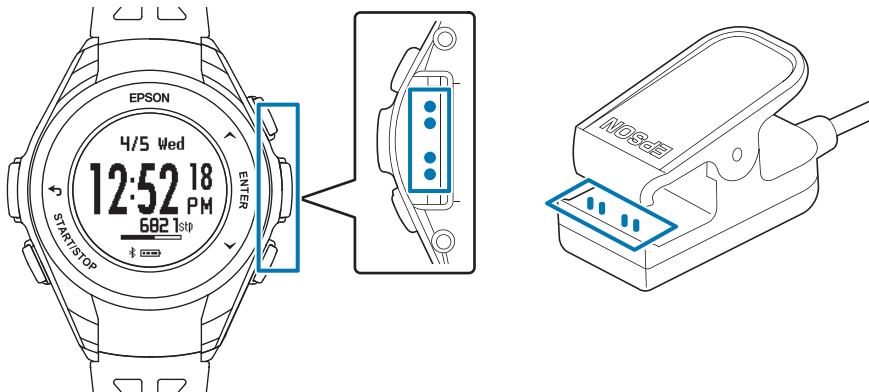

Regular Maintenance



Important

- ❑ *Do not attach the USB Charging clip to the device while contact points are wet or dirty. Doing so may cause corrosion or malfunction of the contact points, or communication failures.*
- ❑ *Do not clean using organic solvents such as benzine, thinner, alcohol, or detergent. This could cause the product to degrade.*

Waterproof performance

Batteries

Internal rechargeable device battery

You cannot replace the built-in rechargeable battery yourself. If the battery does not retain its charge for as long as it used to due to prolonged use, the battery has likely reached the end of its service life. In this situation, contact your local reseller or our repair center to replace the battery for a fee.

The average service life of the battery is four years. This varies depending on usage conditions.

Disposing of the device

When disposing of this device, follow your local laws and regulations.



Li-ion





Regular Maintenance

Problem solving

Check each item.

| Problem | | Solution |
|---------------|---|---|
| Basic actions | The screen is not displayed. | You cannot start using the device immediately after purchase until the device is charged. Try charging the device first. Also, nothing is displayed if the battery runs out. Make sure you charge the battery before use. ☞ "Charging the device" on page 16 |
| | The device does not react even after performing an operation. | Is the battery running low? Charge the battery. ☞ "Battery levels" on page 24 If the device does not operate after charging, try resetting the system. ☞ "Performing system resets" on page 87 |
| | The screen turns off or turns blue during use. | Perform a system reset. ☞ "Performing system resets" on page 87 |
| | The clock turns off. | When you leave the device for a while, it enters sleep status and the time display turns off. This is not a malfunction as the display is restored the next time a button is pressed or you move the device. If the display is not restored, the battery is running low. Charge the device. ☞ "Charging the device" on page 16 Note that the clock does not turn off if AUTO SLEEP is disabled. ☞ "AUTO SLEEP" on page 77 |
| | The time is not set correctly. | Set "Time Adjust" from Sys. Settings. ☞ "UPDATE TIME" on page 77 If the hour is different, check the time zone and daylight-saving time. ☞ "Clock Set" on page 77 |
| | Measurement stops while exercising. | When exercising slowly, such as when walking, we recommend turning off the AT Pause function. ☞ "Pausing and resuming measuring automatically (AT Pause)" on page 46 |

Regular Maintenance

| Problem | | Solution |
|------------------|---|---|
| GPS | GPS signal reception is weak or failing. | <p>Perform GPS positioning again with the device outside with no obstructions overhead for 15 minutes.</p> <p> “GPS signal reception (GPS positioning)” on page 27</p> <p>Go to a location outside with no obstructions overhead. GPS signals cannot be received while indoors. Obstacles partially blocking the sky, such as tall buildings and mountain sides, can also interrupt signal reception, which results in reduced distance accuracy.</p> |
| | GPS signal reception is weak or interrupted. | <p>Even when a signal is being received, it may be interrupted depending on the running environment.</p> <p>Wear the device on the outside of your arm. Also, make sure the strap is tightened.</p> |
| Charging | The device does not charge after attaching the USB Charging clip. | <p>Check the USB Charging clip connection.</p> <p>Clean the contact points of the device and USB Charging clip.</p> <p> “Main device and band” on page 80</p> <ul style="list-style-type: none"> <input type="checkbox"/> The charge screen may not appear for 1 to 2 minutes after attaching the USB Charging clip when the battery is completely exhausted. This is not a malfunction. <input type="checkbox"/> A malfunction may have occurred if you cannot charge the device even after checking the points above. If this happens, immediately stop trying to charge the device and send the main device and USB Charging clip to our repair center. |
| | The charge error screen is displayed. | Charge in environments with ambient temperatures of 5 to 35°C. |
| | The main device and USB Charging clip become hot during the charging process. | There may be a malfunction. Stop charging the device immediately and contact our repair center. |
| Water resistance | Can I use the device when swimming? | This device is water resistant up to 5 bars of pressure and can be used while swimming. However, do not press any buttons while the device is underwater. The device cannot receive GPS signals while underwater. |
| | The inside of the glass becomes cloudy. | <p>Condensation may occur in the device due to differences in temperature between the device and the open air. Temporary condensation does not have any effect on the device. You may continue using the device in this situation. <u>If the condensation remains for a long time, water may have entered the device.</u></p> <p>Send the device to our repair center.</p> |
| Communication | The device is not recognized by the PC when connected. | <p>Check the connection between the PC (USB port) and USB Charging clip (USB plug). Clean the contact points of the device and USB Charging clip.</p> <p> “Main device and band” on page 80</p> <p>Perform a system reset.</p> <p> “Performing system resets” on page 87</p> |

Regular Maintenance

| Problem | | Solution |
|-----------------|---|---|
| Web application | An error screen appears and communication is interrupted during data exchanges with the PC. | Do not move the device and USB Charging clip during communication processes. Avoid communicating data under environments where static electricity can be easily generated. If an error occurs, try reconnecting the USB Charging clip and attempting the communication again. |

If you are still having communication errors after performing this troubleshooting, contact our service center.

Updating the firmware

You may be able to resolve problems that occur by updating the firmware.

Download and use the latest version.



Important

The device and all settings/history data are initialized when the firmware is updated. Refer to the following page of the Epson website for more information on updates.

http://www.epson.jp/dl_soft/category/121.htm

Before updating the firmware, upload your measurement data to the Epson View companion application.

 "Managing data with the companion application" on page 59

Note

Check the following if the ProSense firmware update tool does not start.

- An instance of the ProSense firmware update tool is already started preventing the starting of another instance.
- The USB Charging clip attached to the device is correctly connected to the PC.

Refer to the download page on the Epson website for more information on firmware update procedures.

Checking the firmware version

Updating the firmware

- 1 The latest firmware version is available for download from the following URL.

http://www.epson.jp/dl_soft/category/121.htm

Select your device model and follow the on-screen instructions to download the firmware.

- 2 Attach the USB Charging clip to the device and then connect the cable directly to a USB port on the PC.

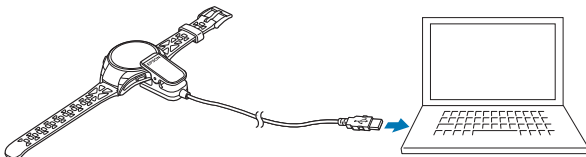

- 3 Execute the downloaded file.
The ProSense firmware update tool starts.
Follow the on-screen instructions to update the firmware.

Regular Maintenance

Performing system resets

Perform a system reset if operation becomes unstable.

Press the UP, ENTER, and DOWN buttons simultaneously.

The screen is reset and the device restarts.

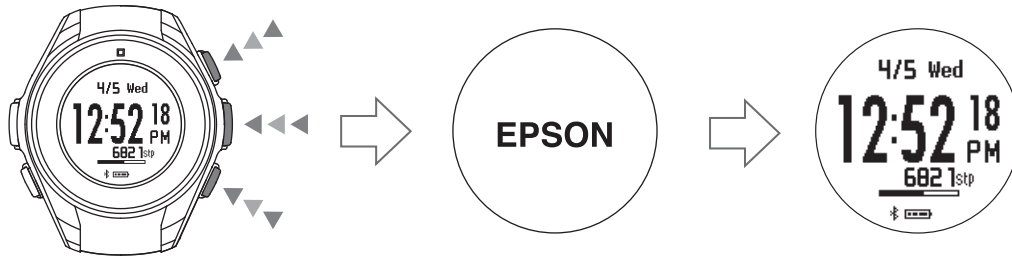

Note

Measurement data is not recorded if a system reset is performed while measuring.

The following shows the differences between a system reset and initializing.

○: Data and settings are retained.

-: Data and settings are not retained. (Settings must be reconfigured.)

| Data/Settings | System reset | Initialize |
|--|--------------|------------|
| Workout settings | ○ | - |
| Recall | ○ | - |
| Screen settings | | |
| System | ○ | - |
| Profile | ○ | - |
| Today's Activity Data | - | - |
| Target number of steps configured for Activity | ○ | - |
| User stride data | ○ | - |
| Pairing | | |
| Time information | ○ | - |

Regular Maintenance

Initializing the device

If you want to delete all measurement data and clear the device's memory, you need to initialize the device.

- 1** Display the menu
At the Time screen, press the **ENTER** button.
- 2** Select **Settings**
Press the **UP** or **DOWN** button > select **Settings** > and then press the **ENTER** button.

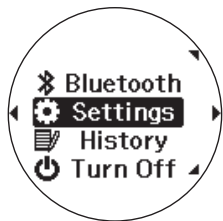

- 3** Select **System**
Press the **UP** or **DOWN** button > select **System** > and then press the **ENTER** button.

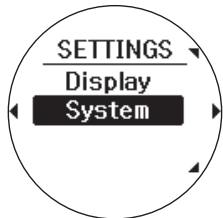

- 4** Select **Reset**
Press the **UP** or **DOWN** button > select **Reset** > and then press the **ENTER** button.



- 5** Initializing the device
Press the **UP** or **DOWN** button > select **Yes** > and then press the **ENTER** button.

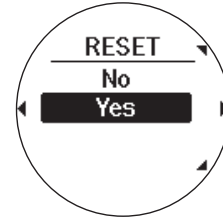





Once the initialization is complete, the device will restart and display the Initial Settings screen. Initialize the device.

[👉 “Configuring initial settings” on page 21](#)

Refer to the following page for more information on initialization.

[👉 “Performing system resets” on page 87](#)

Appendix

-  ["Product specifications" on page 90](#)
-  ["Understanding the icons" on page 92](#)
-  ["Glossary" on page 93](#)
-  ["Trademarks" on page 95](#)

Appendix

Product specifications

Device specifications

| | | |
|--|--|--|
| Model No. | | - |
| Size (thickness) | | 14.0mm |
| Weight | | Approximately 40 g |
| Water resistance | | Water resistant up to 5 bars of pressure |
| Operating time | Clock display (when Track Activity enabled, Auto Sleep enabled, Bluetooth enabled, and Auto Search disabled) | Up to 7 days *1 *2 |
| | Clock display (when Track Activity disabled, Auto Sleep enabled, Bluetooth disabled, and Auto Search disabled) | Up to 30 days *1 *2 |
| | GPS enabled (when Track Activity is disabled) | Up to 13 hours *2 |
| Operating temperature | | -5 to 50°C |
| Maximum measurement time | | Approx. 13 hours |
| Maximum number of daily activity records | | Current day + past 6 days |
| Maximum number of measurement records | | 64 |
| Number of lap records | | Maximum of 200 per split Total maximum of 512 |
| Heart rate measurement | | ○ |
| Pitch/Stride measurement | | ○ |
| Display range | Distance/Lap distance | 0.000 to 999.99 km/0.000 to 999.99 mi |
| | Pace/Lap Pace/Average Pace | 0'01" to 30'00"/km, 0'01" to 45'00"/mi |
| | Split/Lap time | 0:00'00" to 13:00'00" |
| | Pitch/Average Pitch | 0 to 255 spm |
| | Stride/Average stride | 0 to 255 cm / 0 to 100 inches |
| | Steps | 0 to 999,999 steps |
| | Calories burnt | 0 to 9,999 kcal |
| | Heart rate | 30 to 240 bpm |
| | Estimated end time | 0:00'00" to 11:59 PM'59" |
| | Estimated end distance | 0.000 to 999.99 km/0.000 to 999.99 mi |
| USB Charging clip | Operating temperature range | 5 to 35°C |

Appendix

*1 The device periodically receives a GPS signal to reduce the initial GPS positioning time.

Auto Sleep is active for 14 hours per day (internal evaluation criteria)

*2 Operating time varies depending on GPS signal reception quality and device settings.

The operating time is significantly reduced when GPS signal reception is poor, such as indoors. (Some settings that affect battery life include backlight settings.)

Option specifications

You can purchase the following optional extras. Contact your local reseller for more information.

USB charging clip



















| | |
|-----------------------------|-----------|
| Operating temperature range | 5 to 35°C |
|-----------------------------|-----------|

AC adapter specifications

| | |
|--------|------------------|
| Input | 100 VAC 50/60 Hz |
| Output | 5 VDC / 1.0 A |

Appendix

Understanding the icons

| Icons | Name |
|---|---|
|  | Run mode (measuring while running) |
|  | Walking mode (measuring while walking) |
|  | Treadmill mode (measuring treadmill workout sessions) |
|  | Device is acquiring a GPS signal (GPS On) |
|  | GPS positioning |
|  | Average pace |
|  | Lap |
|  | Distance |
|  | Calories burnt |
|  | Stopwatch |
|  | Split time |
|  | AT Lap |
|  | Manual Lap |
|  | Steps |
|  | Average stride |
|  | Charging |
|  | USB communication in progress |
|  | Buttons are locked |
|  | Buttons are unlocked |

Glossary

| Definition | Term |
|--|--|
| <p>A system that is used to calculate current positions via a GPS receiver that receives signals from satellites orbiting the earth. This function allows you to accurately understand positional and time information.</p> <p> "GPS signal reception (GPS positioning)" on page 27</p> | GPS function |
| Distance from the measurement start point to the current time. | Distance |
| Target time per km | Target Pace |
| The device is water resistant up to 5 bars of pressure. | Water resistant up to 5 bars of pressure |
| The display automatically turns off after a certain time of no user operation. | Auto Sleep |
| The total time from starting to stopping the workout. | Split time |
| This companion application allows you to use a smartphone or PC browser to review session and measurement data from your device. | Epson View |
| This function automatically pauses your measuring when you stop running and resumes your measuring when you start running again. | AT Pause |
| This function automatically records laps once a certain distance has been reached. | AT Lap |
| This function measures various daily activity including number of steps, distance, and calories burnt. | Track Activity |
| This function turns on the light automatically when transitioning to different screens. | AT Light |
| <p>This sensor uses stride and acceleration data accumulated when GPS is in use so that the device can estimate distance traveled when you are in locations of poor GPS signal reception, such as tunnels.</p> <p> "About the stride sensor" on page 29</p> | Stride sensor |

Appendix

| Definition | Term |
|--|----------|
| Your current pace acquired from GPS information. | Pace |
| Your pace for the current lap. | Lap pace |
| Your time for the lap. | Lap time |

Appendix

Trademarks

- ❑ EPSON and EXCEED YOUR VISION are registered trademarks of the Seiko Epson Corporation.
- ❑ Microsoft and Windows are registered trademarks of the Microsoft Corporation in the United States of America and other countries.
- ❑ OS X and macOS are registered trademarks of Apple Inc. in the United States of America and other countries.
- ❑ iPhone is a trademark of Apple Inc.
- ❑ Android and Google Play are trademarks of Google Inc.
- ❑ The Bluetooth[®] word mark and logos are registered trademarks of Bluetooth SIG, Inc. Seiko Epson Corporation uses these trademarks under the terms of license.
- ❑ QR Code is a registered trademark of DENSO WAVE INCORPORATED.
- ❑ Other product names are the trademarks or registered trademarks of their respective companies.

EPSON



GPS Sports Monitor

ProSense

J-307

http://www.epson.jp/support/support_menu/ks/121.htm

XXXXXXXXXX ©2017 Seiko Epson Corporation. All rights reserved.