

L

Seychelles

<short.bk> Rev. A

A5 size
7/10/98

SHORT.TOC
Pass 0

Proof Sign-off:

K.Nishi

N.Nomoto

K.Norum

FCC Compliance Statement For United States Users

This equipment has been tested and found to comply with the limits for a Class B digital device, pursuant to Part 15 of the FCC Rules. These limits are designed to provide reasonable protection against harmful interference in a residential installation. This equipment generates, uses, and can radiate radio frequency energy and, if not installed and used in accordance with the instructions, may cause harmful interference to radio or television reception. However, there is no guarantee that interference will not occur in a particular installation. If this equipment does cause interference to radio and television reception, which can be determined by turning the equipment off and on, the user is encouraged to try to correct the interference by one or more of the following measures.

- ▶ Reorient or relocate the receiving antenna.
- ▶ Increase the separation between the equipment and receiver.
- ▶ Connect the equipment into an outlet on a circuit different from that to which the receiver is connected.
- ▶ Consult the dealer or an experienced radio/TV technician for help.

WARNING

The connection of a non-shielded equipment interface cable to this equipment will invalidate the FCC Certification of this device and may cause interference levels which exceed the limits established by the FCC for this equipment. It is the responsibility of the user to obtain and use a shielded equipment interface cable with this device. If this equipment has more than one interface connector, do not leave cables connected to unused interfaces. Changes or modifications not expressly approved by the manufacturer could void the user's authority to operate the equipment.

For Canadian Users

This Class B digital apparatus complies with Canadian ICES-003.

Cet appareil numérique de la classe B est conforme à la norme NMB-003 du Canada.

Proof Sign-off:
K.Nishi _____
N.Nomoto _____
K.Norum _____

Seychelles

<short.bk> Rev. A

A5 size
7/10/98

SHORT.TOC
Pass 0

R

Safety Instructions	5
Important Safety Instructions	5
A Few Precautions	6
Warnings, Cautions, and Notes	8
Setting Up Your Printer	9
System Requirements	9
Printer Parts and Control Panel Functions	11
Attaching the Paper Support	14
Plugging in the Printer	14
Installing the Ink Cartridges	15
Connecting the Printer to Your PC	19
Installing the Printer Software in Your PC	20
Connecting the Printer to Your Macintosh	22
Installing the Printer Software in Your Macintosh	24
Selecting Your Printer in the Chooser	26
Loading Paper	28
Printing Your First Page for Windows	30
Printing Your First Page for Macintosh	32
Loading Special Paper	34
Replacing Ink Cartridges	39
Maintenance	45
Checking the Print Head Nozzles	45
Cleaning the Print Head	46
Aligning the Print Head	48
Troubleshooting	51
Error Indicators	52
Where to Get Help	53
Options and Consumable Products	61

Proof Sign-off:

K. Nishi

N. Nomoto

K. Norum

Seychelles

short.bk

A5 size
7/10/98

Rev. A

FRONT.FM
Pass 2

R

All rights reserved. No part of this publication may be reproduced, stored in a retrieval system, or transmitted in any form or by any means, electronic, mechanical, photocopying, recording, or otherwise, without the prior written permission of SEIKO EPSON CORPORATION. The information contained herein is designed only for use with this EPSON printer. EPSON is not responsible for any use of this information as applied to other printers.

Neither SEIKO EPSON CORPORATION nor its affiliates shall be liable to the purchaser of this product or third parties for damages, losses, costs, or expenses incurred by the purchaser or third parties as a result of: accident, misuse, or abuse of this product or unauthorized modifications, repairs, or alterations to this product, or (excluding the U.S.) failure to strictly comply with SEIKO EPSON CORPORATION's operating and maintenance instructions.

SEIKO EPSON CORPORATION shall not be liable for any damages or problems arising from the use of any options or any consumable products other than those designated as Original EPSON Products or EPSON Approved Products by SEIKO EPSON CORPORATION.

SEIKO EPSON CORPORATION shall not be held liable for any damage resulting from electromagnetic interference that occurs from the use of any interface cables other than EPSON Approved Products by SEIKO EPSON CORPORATION.

EPSON and EPSON ESC/P are registered trademarks and EPSON ESC/P 2, ESC/P Raster and EPSON Stylus are trademarks of SEIKO EPSON CORPORATION.

Microsoft and Windows are registered trademarks of Microsoft Corporation.

General Notice: Other product names used herein are for identification purposes only and may be trademarks of their respective owners. EPSON disclaims any and all rights in those marks.

Copyright © 1998 by SEIKO EPSON CORPORATION, Nagano, Japan.



Printed on Recycled Paper.

Safety Instructions

Important Safety Instructions

Read all of these instructions before using your printer. Also be sure to follow all warnings and instructions marked on the printer.

- Do not block or cover the openings in the printer's cabinet.
- Do not insert objects through the slots. Take care not to spill liquid on the printer.
- Use only the type of power source indicated on the printer's label.
- Connect all equipment to properly grounded power outlets. Avoid using outlets on the same circuit as photocopiers or air control systems that regularly switch on and off.
- Avoid electrical outlets controlled by wall switches or automatic timers.
- Keep the entire computer system away from potential sources of electromagnetic interference, such as loudspeakers or the base units of cordless telephones.
- Do not use a damaged or frayed power cord.
- If you use an extension cord with the printer, make sure the total ampere rating of the devices plugged into the extension cord does not exceed the cord's ampere rating. Also, make sure the total ampere rating of all devices plugged into the wall outlet does not exceed the wall outlet's ampere rating.
- Do not attempt to service the printer yourself.

When handling the ink cartridges

- Keep ink cartridges out of the reach of children.
- If ink gets on your skin, wash it off with soap and water. If it gets in your eyes, flush them immediately with water.
- Do not shake an ink cartridge; this can cause leakage.
- Install the ink cartridge immediately after you remove it from its package. Leaving the cartridge unpacked for a long time before use may result in reduced print quality.
- Once you install an ink cartridge, do not open the clamp or remove the cartridge except to replace it with a new one. The cartridge may become unusable otherwise.
- Do not use an ink cartridge beyond the date printed on the cartridge carton. For best results, use up the ink cartridges within six months of installing them.
- Do not dismantle the ink cartridges or try to refill them. This could damage the print head.

When choosing a place for the printer

- Place the printer on a flat, stable surface that is larger than the printer. The printer will not operate properly if it is tilted or at an angle.
- Avoid places subject to rapid changes in temperature and humidity. Also keep it away from direct sunlight, strong light, or heat sources.
- Avoid places subject to shocks and vibrations.
- Place the printer near a wall outlet where the plug can be easily unplugged.

Setting Up Your Printer

System Requirements

For PCs

To use your printer, you need Microsoft® Windows® 95, Windows® 98, Windows® NT 4.0, or DOS; and a shielded, twisted-pair parallel cable. If you want connect your printer to a USB port, you need a Windows 98 pre-installed PC equipped with a USB port; and a shielded USB cable.

Your computer should also meet the following system requirements:

Minimum system	Recommended system
i486/25 MHz for Windows 95 and NT 4.0 i486/66 MHz for Windows 98	Pentium or higher processor
16MB RAM	32MB RAM or more for Windows 95 and 98 64MB or more for Windows NT 4.0
10MB hard disk space for Windows 95 and 98 20MB for Windows NT 4.0	50MB or more free disk space for Windows 95, and 98 100MB or more for Windows NT 4.0
VGA monitor	VGA or better monitor

Your computer dealer can help you update your system if it does not meet these requirements.

- *The memory requirements above are for printing on Letter size paper. These requirements may vary depending on the size of the paper, the type of application you are using, and the complexity of the document you want to print.*





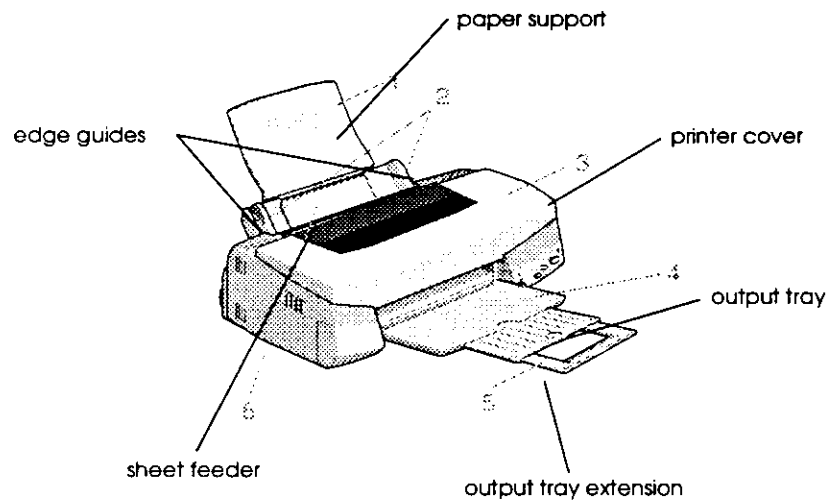

In addition to these system and memory requirements, you also need 10MB of free hard disk space to install your printer software. To print, you need extra hard disk space amounting to about double the size of the file you want to print.

Printer Parts and Control Panel Functions





















Buttons

Button	Function
 Power	Turns the printer on and off. Clears the printer's memory if pressed twice while the power is on.
 Load/Eject	Loads or ejects paper if pressed and released within 2 seconds. Resumes printing if pressed and released after a paper out error.
 Cleaning	Moves the print head to the ink cartridge replacement position if pressed for 3 seconds while the  or  ink out light is flashing or on. Returns the print head to its home position after ink cartridge replacement. Performs print head cleaning if pressed for 3 seconds when the  or  ink out light is off.

Lights

Light Status	Printer Status
 	Printer is on.
 	Receiving data, replacing an ink cartridge, charging ink, or cleaning the print head.
 	Paper out. Load paper in the sheet feeder; then press the  load/eject button to resume printing.
 	Paper jam. Take all the paper out of the feeder, and reload the paper. If the light continues to flash, turn off the printer and gently pull all the paper out of the printer.
 	Ink low. The black ink cartridge is nearly empty. Obtain a black ink cartridge (S020187).
 	Ink out. The black ink cartridge is empty. Replace the black ink cartridge (S020187).
 	Ink low. The color ink cartridge is nearly empty. Obtain a color ink cartridge (S020193).
 	Ink out. The color ink cartridge is empty. Replace the color ink cartridge (S020193).

■ = on, □ = flashing

Installing the Ink Cartridges

Before installing the ink cartridges, note the following.



Warning:

The ink cartridges are self-contained units. Under ordinary use, ink will not leak from a cartridge. If ink does get on your hands, wash them thoroughly with soap and water. If ink gets into your eyes, flush them immediately with water.

Note:

- Do not open the ink cartridge packages until just before you install them, or the ink may dry up.*
- Use the ink cartridges packed with your printer the first time you install ink cartridges, otherwise the printer may not charge ink properly.*

Install the ink cartridges as follows:

1. Lower the output tray; then open the printer cover.

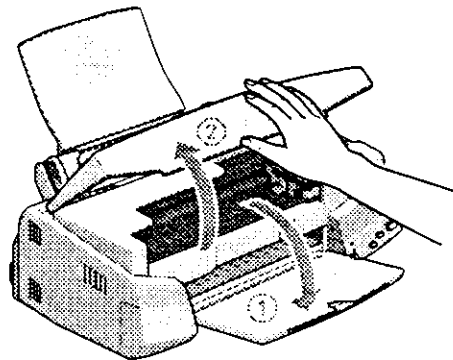

4. Open the ink cartridge packages that came with your printer. Next, remove only the yellow tape seals from each cartridge.

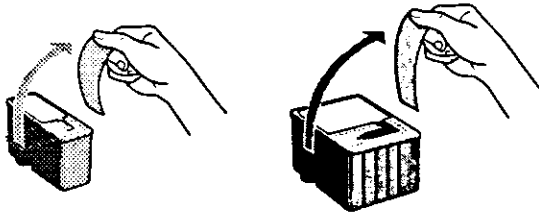

Caution:

- Remove the yellow tape seals from the cartridges before installing them; otherwise the cartridges may become unusable.
- Do not remove the blue portion of the tape seals from the cartridges; otherwise the cartridges may become clogged and cannot print.
- Do not remove the tape seals from the bottom of the cartridges; otherwise, ink will leak.

5. Place the cartridges gently into their holders with the labels face-up. The color ink cartridge, which is larger, goes on the right and the black goes on the left. Do not press down on the cartridges.

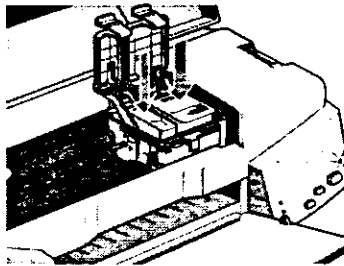

Note:

Install both ink cartridges. If either of the cartridges is not installed, the printer will not work.

8. Close the printer cover.

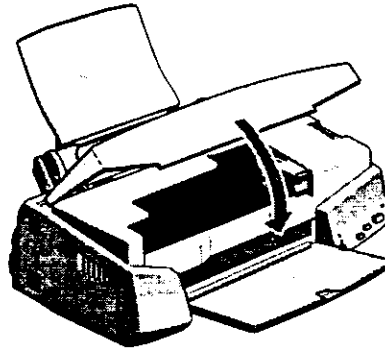

Now you are ready to connect the printer to your computer. To connect the printer to your PC, see the next section. To connect the printer to a Macintosh, see "Connecting the Printer to Your Macintosh" on page 22.

Connecting the Printer to Your PC

Note:

To connect and use the USB connector, see the USB User's Guide shipped with your printer.

Connecting to a parallel interface

To connect the printer to your computer using the built-in parallel interface, you need a shielded, twisted-pair parallel cable.

Follow these steps to connect your printer.

1. Make sure both the printer and computer are turned off.

- Utilities**
The Nozzle Check, Head Cleaning, and Print Head Alignment utilities help you keep your printer in top operating condition.
- EPSON Status Monitor 2**
EPSON Status Monitor 2 notifies you of printer errors and displays printer status information such as the amount of ink remaining. The Status Monitor also guides you when replacing ink cartridges.
- HIGH QUALITY IMAGES (for Windows 95 and NT 4.0 only)**
HIGH QUALITY IMAGES allows you to quickly and easily see the kind of high-quality printout available from the EPSON Stylus Photo 750.

If you are using the floppy disk version of the software, make a backup copy of the EPSON printer software disk before you begin installation. If you wish to make a floppy disk version of the printer software on your CD-ROM, you can use the Driver disk creation utility included on the CD. See "Installing in Windows 95, 98, and NT 4.0" on page 21, or "Installing in Windows 98 with USB interface" on page 22.

Installing in Windows 95, 98, and NT 4.0

1. Insert the printer software CD shipped with your printer in the CD-ROM drive. The Installer dialog box appears. (For floppy disk users, insert the disk in a disk drive, then double-click the drive icon and double-click the Setup.exe icon.)
2. Click Install to start the printer software installation.
3. When the installation is complete, click OK.

Note:

- If the New Hardware Found screen or any other Wizard appears when you turn on your computer, click CANCEL and follow the steps above.*

1. Make sure both your printer and Macintosh are switched off.
2. Connect one end of the interface cable to the serial connector on the back of the printer.

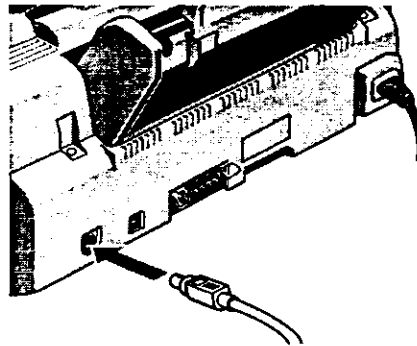

3. Connect the other end of the interface cable to either the modem port or printer port on the Macintosh. The ports are marked with the following icons.



modem port

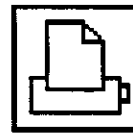

printer port

See the next section for instructions on installing the printer software. You must install the printer software before using your printer.

Note :

If you wish to make a floppy disk version of the printer software included on your CD-ROM, insert the printer software CD-ROM, then click the Driver disk creation utility button and follow the on-screen instructions.



ColorSync 2.0 and Profiles

Matches the colors in your printout with the colors displayed on your screen automatically. Use this when printing scanned photographs or computer graphics.

If you are using the floppy disk version, make a backup copy of the EPSON Macintosh printer software disk before you begin installation.



Caution:

Turn off all virus protection programs before you install your printer software.

Follow these steps to install your printer software:

1. Turn on your Macintosh and insert the software CD in the CD-ROM drive. (If you use the floppy disk version, insert it in a disk drive.)
2. The EPSON printer software disk opens automatically.
3. If a single installer icon appears, double-click the icon. If separate folders containing installer icons for several languages appear, double-click the folder for your preferred language, then double-click the installer icon inside it.



After you install the printer software, you need to open the Chooser to select your printer. You have to choose the printer the first time you use it or whenever you want to switch to another printer. Your Macintosh will always print using the last printer selected.

Note:

If you are using a Macintosh Quadra 950 or 900, you need to choose Compatible in the Serial Switch dialog box before selecting your printer from the Chooser. To open the Serial Switch dialog box, choose Control Panel from the Apple menu, then choose Serial Switch.

1. Make sure the printer is connected to your Macintosh and is turned on.
2. Choose Chooser from the Apple menu. Then click your printer's icon and the port your printer is connected to.

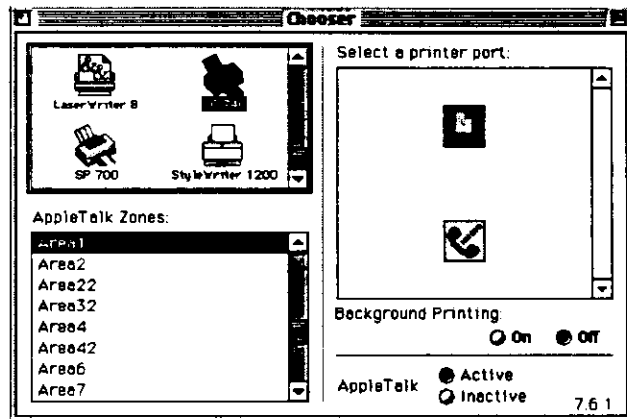

Note:

- If you are using an iMac computer, you must select the USB port.*



1. Lower the output tray and slide out the extension. Next, slide the left edge guide so that the distance between the edge guides is slightly wider than the width of your paper.

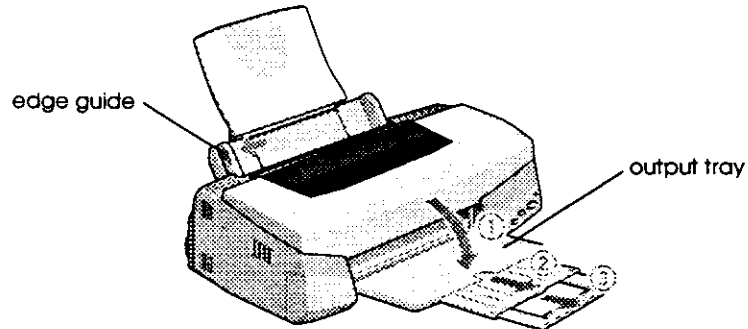

2. Fan a stack of paper; then tap it on a flat surface to even the edges.
3. Load the stack of paper with the printable side up and the right edge of the paper resting against the right side of the sheet feeder. Then slide the left edge guide against the edge of the paper.

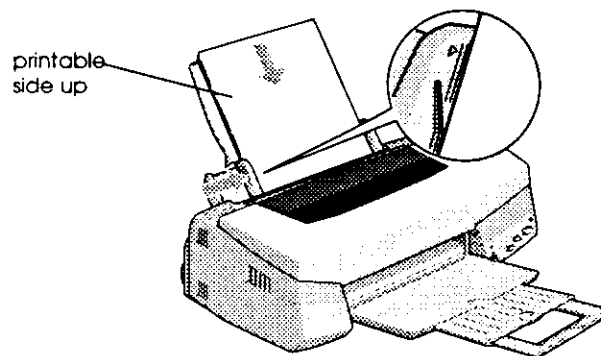

Note:

- Always load paper into the sheet feeder short edge first.

3. Make sure your printer is selected and then click Properties, or Options. You may need to click a combination of these buttons. The driver settings window appears.

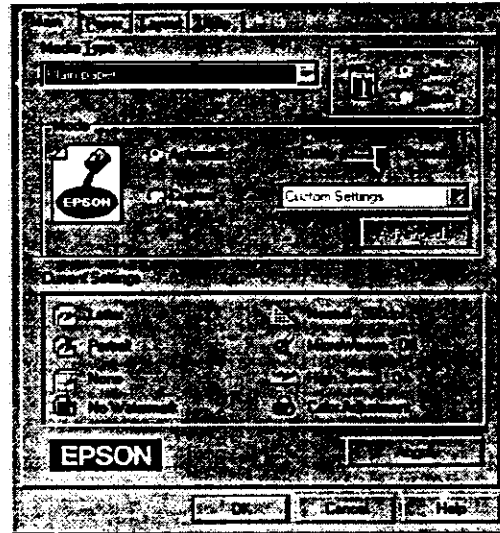



4. Click the MAIN tab if necessary, then click anywhere in the Media Type box and select the media you loaded in the printer.
5. Select COLOR as the Ink setting.
6. Make sure the Mode option is set to Automatic.

When Automatic is selected, the printer software optimizes other settings according to the Media Type and Ink settings you make.
7. Click OK at the bottom of the window. You return to the Print dialog box (or a similar dialog box).
8. Click Close, OK, or Print to print. You may need to click a combination of these buttons.

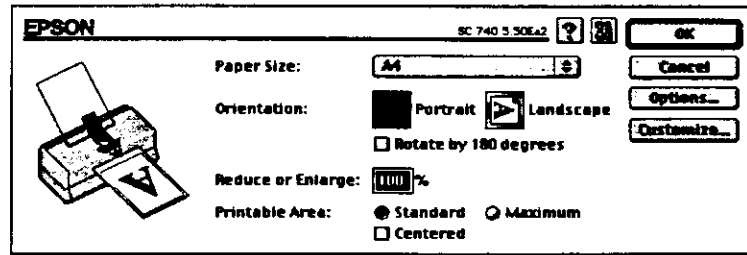
3. Choose Page Setup from the File menu. This brings up the dialog box shown below.



4. Select the paper size you loaded in the printer from the Paper Size list.
5. Select  Portrait or  Landscape as the Orientation option.
6. After making your settings, click the OK button to close the Page Setup dialog box.

You cannot print from the Page Setup dialog box. You can only print from the Print dialog box.

7. Choose Print from the File menu. This brings up the dialog box shown below.

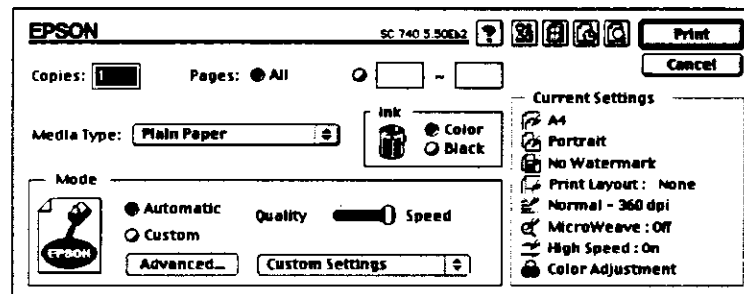



1. Lower the output tray and slide out the extension. Next, slide the left edge guide so that the distance between the edge guides is slightly wider than the width of your paper.

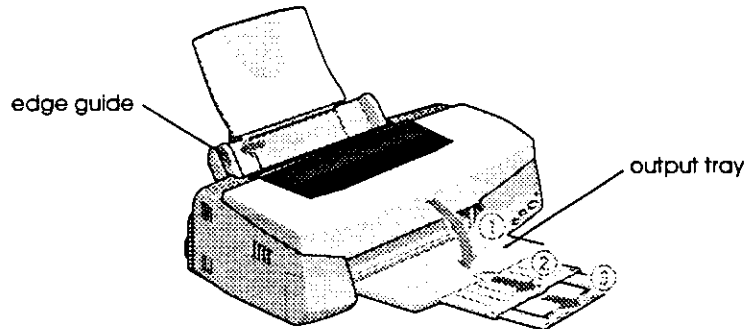

2. Fan a stack of paper; then tap it on a flat surface to even the edges.
3. Load the stack of paper with the printable side up and the right edge of the paper resting against the right side of the sheet feeder. Then slide the left edge guide against the edge of the paper.

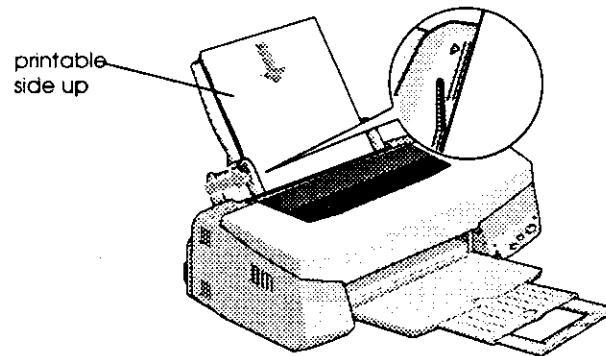

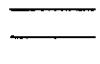

- ❑ Loading capacity for envelopes and EPSON special media is explained below.

Envelopes

Up to 10 envelopes.

Note:

If the total thickness of the stack of envelopes exceeds 10 mm, press each envelope flat before loading.

360 dpi Ink Jet Paper
and Photo Quality
Ink Jet Paper

Up to the arrow mark on the left edge guide.

Photo Quality Ink Jet
Card, Ink Jet Note
Card, and Ink Jet
Greeting Card

Up to 30 index cards. Always place the included support sheet under the cards.

Photo Quality
Glossy Film

One sheet at a time for best results. Always put a support sheet* or a sheet of plain paper under the glossy film.
If you wish to print with multiple sheets, load only up to 20 sheets and set the minimum top margin of the page to 30 mm.

Ink Jet
Transparencies

Up to 30 transparencies. Always put a sheet of plain paper under the stack of transparencies.

Photo Quality
Self Adhesive Sheet

One sheet at a time.







Replacing Ink Cartridges

Using the printer's control panel

The printer's indicator lights will inform you when it is time to obtain a replacement ink cartridge and when it is time to replace an empty cartridge.

This table describes the status of the lights on your printer and the actions you need to take.

Lights	Action
	Obtain a replacement black ink cartridge (S020187).
	Replace the empty black ink cartridge.
	Obtain a replacement color ink cartridge (S020193).
	Replace the empty color ink cartridge.

■ = on, □ = flashing



Caution:

- EPSON recommends the use of genuine EPSON ink cartridges. Other products not manufactured by EPSON may cause damage to your printer not covered by EPSON's warranties.
- Leave the old cartridge installed in the printer until you have obtained a replacement. Otherwise, ink remaining in the print head nozzles may dry out.

Note:

If the ink runs out, you cannot continue printing until you replace the empty cartridge, even though the other ink cartridge still contains ink.

To replace an ink cartridge using the printer's control panel, follow these steps.



- Lift up the clamp that holds the cartridge you want to replace as far as it will go. When you do, the cartridge will rise partly out of the cartridge holder.

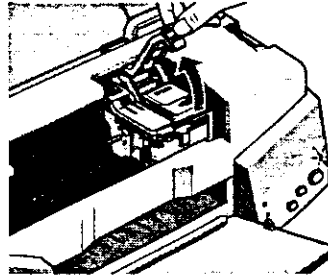

The illustration shows color ink replacement. To replace black ink, lift up only the smaller clamp on the left.



Caution:

Once you open the ink cartridge clamp, the ink cartridge becomes unusable and cannot be reinstalled even if ink remains.

- Lift the cartridge out of the printer and dispose of it properly. Do not take the used cartridge apart or try to refill it.



Warning:

If ink gets on your hands, wash them thoroughly with soap and water. If ink gets into your eyes, flush them immediately with water.

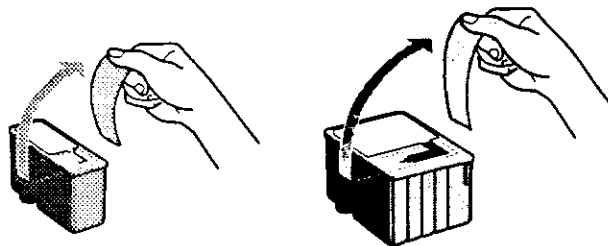

- Remove the ink cartridge from its protective bag. Next, remove only the yellow tape seal from the cartridge.







Caution:

Once you install the cartridges, do not open their clamps again until you replace the ink cartridges. Otherwise, the cartridges may become unusable.

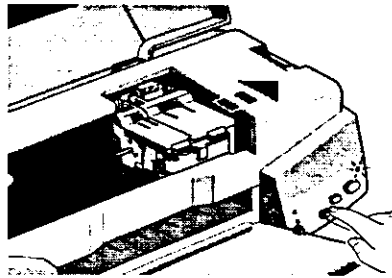
9. Press the  cleaning button. The printer moves the print head and begins charging the ink delivery system. This process takes about 1 minute to complete. When the ink charging process is finished, the printer returns the print head to its home position and the  power light stops flashing.



Caution:

The  power light continues to flash while the printer performs the ink charging operation. Never turn off the printer while this light is flashing. Doing so can result in incomplete charging of ink.

10. Close the printer cover.



Maintenance



Checking the Print Head Nozzles

If you find that the printed image is unexpectedly faint or dots in the printed image are missing, you may be able to solve these problems by checking the print head nozzles.





You can check the print head nozzles from your computer with the Nozzle Check utility in the printer software, or from the printer itself by using the printer's control panel buttons.

Note:

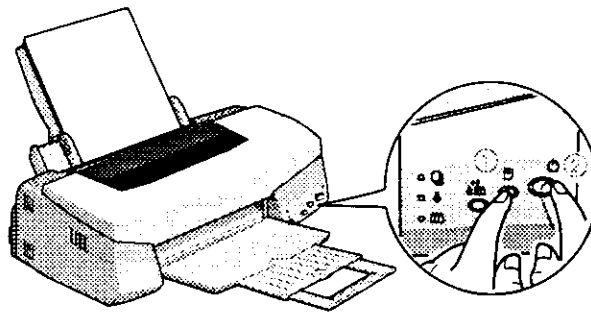

Do not start the Nozzle Check utility while printing is in progress; otherwise your printout may be marred.

1. Hold down the  load/eject button and press the  power button to turn on the printer. Then release both buttons.



- Print head cleaning uses both color and black ink. To avoid wasting ink, clean the print head only if print quality declines.*
 - Use the Nozzle Check utility to confirm that the print head needs to be cleaned. This saves ink.*
 - When the  or  ink out light is flashing or on, you cannot clean the print head. Replace the appropriate ink cartridge first.*
 - Do not start the Head Cleaning or Nozzle Check utility while printing is in progress; otherwise your printout may be marred.*
1. Make sure that the  power light is on and that both the  and  ink out lights are off.

Note :

If the  or  ink out light is flashing or on, you cannot clean the head, and this operation will start the ink cartridge replacement procedure. If you do not want to replace an ink cartridge at this moment, press the  cleaning button to return the print head to its home position.

2. Hold down the  cleaning button for three seconds.

The printer starts cleaning the print head and the  power light begins flashing. Print head cleaning takes about one minute to complete.



2. Access the printer software window. If you need instructions, see "Accessing the printer software" in the online Reference Guide.
3. Click the Utility tab, then click the Print Head Alignment button.
4. Follow the messages on your screen to align the print head.

For Macintosh users





1. Make sure A4 or wider paper is loaded in the sheet feeder.
2. Click the Utility icon button in the Print dialog box. Then click the Print Head Alignment button.
3. Follow the messages on your screen to align the print head.

Proof Sign-off:
K. Nishi _____
N.Nomoto _____
K.Norum _____

Seychelles
short.bk **Rev. A**
A5 size TRBLE.FM
7/10/98 Pass 2

R

Troubleshooting

	Ink Low (color ink cartridge)	
	The color ink cartridge is nearly empty.	Obtain a replacement color ink cartridge (S020193).
	Ink Out (color ink cartridge)	
	The color ink cartridge is empty.	Replace the color ink cartridge with a new one (S020193). See "Replacing Ink Cartridges" on page 39.
	Carriage Error	
	The print head carriage is caught by jammed paper or other foreign material and cannot return to the home position.	<p>Turn off the printer. After a few seconds, turn it on again. The printer will eject any jammed paper.</p> <p>If the paper is not ejected, turn off the printer. Open the printer cover and remove any paper from the paper path by hand.</p> <p>If the error is not cleared, contact your dealer.</p>
	Unknown Printer Error	
	An unknown printer error has occurred.	<p>Turn off the printer, and after a few seconds, turn it on again.</p> <p>If the error is not cleared, contact your dealer.</p>

■ = on, □ = off, □ = flashing

Where to Get Help

If your printer is not operating properly and you cannot solve the problem using the troubleshooting information in your printer documentation, contact customer support services for assistance.

We will be able to help you much more quickly if you give us the following information:

To use Faxon EPSON, call 01442 227332 in the UK or 0044 1442 227332 from the Republic of Ireland using a touch-tone phone. You will be asked to follow a simple routine to register your document request. Once you have entered your telephone and fax numbers, Faxon EPSON will fax a copy of the document catalogue to your fax machine.

When you have found the documents that you need in the catalogue, call Faxon EPSON again and enter the document ID numbers. The documents will be faxed to you automatically.

Bulletin Board Service for latest drivers and utilities

You can call the EPSON Bulletin Board Service on 01442 227479 in the UK or 0044 1442 227479 from the Republic of Ireland. No membership is required. Make sure that your communications software is set to 8 data bits, 1 stop bit, no parity bit, ANSI terminal mode emulation, and a modem speed of up to 28.8 Kbps. Downloading protocols supported include Xmodem, Ymodem and Zmodem. See the documentation that came with your communications software and modem for more information.

When you first connect to the Bulletin Board Service, you will be asked for your name, company name, phone number and a password (which you can invent yourself).

Customer and Warranty Support

Our Customer and Warranty Support teams can be contacted by calling 0870 163 7766 in the UK or 0044 0870 163 7766 from the Republic of Ireland. They can provide the following services:

- Technical information on installing, configuring, and operating your EPSON products
- Arranging for faulty EPSON products to be repaired within the warranty period

Internet URL <http://www.epson.com.au>

Access the EPSON Australia World Wide Web pages. Worth taking your modem here for the occasional surf! You can get the same information as offered on the EPSON FAXBACK and the EPSON Bulletin Board plus more.

Your dealer

Don't forget that your dealer can often help identify and resolve problems. The dealer should always be the first call for advice on problems. They can often solve problems quickly and easily as well as give you advice on the next step to take.

EPSON Helpdesk

EPSON Helpdesk is provided as a final backup to make sure our clients have access to advice. Operators on the Helpdesk can aid you in diagnosing hardware and software problems. They can also advise you on the latest EPSON products and where the nearest dealer or service agent is located. Many types of queries are answered here.

The Helpdesk numbers are:

Phone: (02) 9903 9040

Fax: (02) 9903 9189

We encourage you to have all the relevant information on hand when you ring. The more information you prepare, the faster we can help solve the problem. This information includes the *User's Guide* for your EPSON product, type of computer, operating system, application programs, and any other information you feel is required.

Proof Sign-off:
K. Nishi _____
N. Nomoto _____
K. Norum _____

Seychelles

short.bk

A5 size
7/10/98

Rev. A

TRBLE.FM
Pass 2

R

Technical Support Hotline

You can also contact our technical staff at the following telephone and fax numbers:

Phone: (852) 2585-4399

Fax: (852) 2827-4383

For Philippines Users

To obtain technical support as well as other after sales services, users are welcome to contact the EPSON Philippines Representative Office at the telephone and fax numbers below:

Phone: (632) 813-6552

Fax: (632) 813-6545

BBS: (632) 814-0595

Options and Consumable Products

Interface cables

You can use any interface cable that meets the following specifications. See your computer manual for any additional requirements.

- Parallel Interface Cable (shielded) C83602* from D-SUB 25-pin (computer) to 36-pin Amphenol 57 Series (printer)
- USB Interface Cable (shielded) C83623* from Series A 4-pin (computer) to Series B 4-pin (printer) (This cable not supplied in all locations.)

Note :

The asterisk () is a substitute for the last digit of the product number, which varies by country.*



Caution:

Use only the interface cables listed above. Using other cables not covered by EPSON warranties may cause the printer to malfunction.

Ink cartridges

Black ink cartridge	S020187
Color ink cartridge	S020193

EPSON special media

Most plain paper works well in your printer. In addition, EPSON offers specifically designed media for ink jet printers to meet most high-quality printing needs.

EPSON 360 dpi Ink Jet Paper (A4)	S041059
	S041025

Proof Sign-off:
K. Nishi
N. Nomoto
K. Norum

Seychelles

short.bk

A5 size
7/10/98

Rev. A

OPTION.FM
Pass 2

R

EPSON Panoramic Photo Paper (210 × 594 mm) S041145
EPSON Iron-On Cool Peel Transfer Paper (A4) S041154
EPSON Iron-On Cool Peel Transfer Paper (Letter) S041153
S041155

Note:

The availability of special media varies by country.

Proof Sign-off:
K. Nishi
N.Nomoto
K.Norum

Seychelles
html.bk

A5 size
7/10/98

(2271074c1=Rev.A
2/3)
~~Pro-Rev. A~~
FRONT.FM
Pass 2

R

Product Information

Declaration of Conformity

According to ISO/IEC Guide 22 and EN 45014

Manufacturer	SEIKO EPSON CORPORATION
Address	3-5, Owa 3-chome, Suwa-shi, Nagano-ken 392-8502 Japan
Representative	EPSON EUROPE B.V.
Address	Prof. J. H. Bavincklaan 5 1183 AT Amstelveen The Netherlands

Declares that the Product:

Product Name	Ink Jet Printer
Model	P112A

Conforms to the following Directive(s) and Norm(s):

Directive 89/336/EEC	EN 55022 Class B EN 61000-3-2 EN 61000-3-3 EN 50082-1 IEC 801-2 IEC 801-3 IEC 801-4
Directive 73/23/EEC	EN 60950

September 1998

Safety Instructions

ENERGY STAR Compliance



As an ENERGY STAR Partner, EPSON has determined that this product meets the ENERGY STAR guidelines for energy efficiency.

The International ENERGY STAR Office Equipment Program is a voluntary partnership with the computer and office equipment industry to promote the introduction of energy-efficient personal computers, monitors, printers, fax machines, and copiers in an effort to reduce air pollution caused by power generation.

For United Kingdom Users

Use of options

EPSON (UK) Limited shall not be liable against any damages or problems arising from the use of any options or consumable products other than those designated as Original EPSON Products or EPSON Approved Products by EPSON (UK) Limited.

Safety information



Warning:

This appliance must be earthed. Refer to rating plate for voltage and check that the appliance voltage corresponds to the supply voltage.

Important:

The wires in the mains lead fitted to this appliance are coloured in accordance with the following code:

System Requirements

For PCs

To use your printer, you need Microsoft® Windows® 95, Windows® 98, Windows® NT 4.0, or DOS; and a shielded, twisted-pair parallel cable. If you want connect your printer to a USB port, you need a Windows 98 pre-installed PC equipped with a USB port; and a shielded USB cable.

Your computer should also meet the following system requirements:

Minimum system	Recommended system
i486/25 MHz for Windows 95 and NT 4.0 i486/66 MHz for Windows 98	Pentium or higher processor
16MB RAM	32MB RAM or more for Windows 95 and 98 64MB or more for Windows NT 4.0
10MB hard disk space for Windows 95 and 98 20MB for Windows NT 4.0	50MB or more free disk space for Windows 95, and 98 100MB or more for Windows NT 4.0
VGA monitor	VGA or better monitor

Your computer dealer can help you update your system if it does not meet these requirements.

- *The memory requirements above are for printing on Letter size paper. These requirements may vary depending on the size of the paper, the type of application you are using, and the complexity of the document you want to print.*

In addition to these system and memory requirements, you also need 10MB of free hard disk space to install your printer software. To print, you need extra hard disk space amounting to about double the size of the file you want to print.



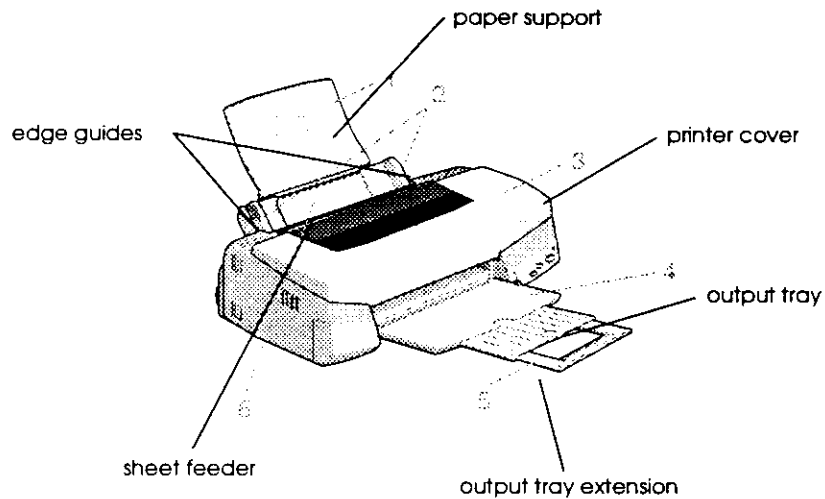



Printer Parts and Control Panel Functions







1. paper support
2. edge guides
3. printer cover
4. output tray



Buttons

Button	Function
 Power	Turns the printer on and off. Clears the printer's memory if pressed twice while the power is on.
 Load/Eject	Loads or ejects paper if pressed and released within 2 seconds. Resumes printing if pressed and released after a paper out error.
 Cleaning	Moves the print head to the ink cartridge replacement position if pressed for 3 seconds while the  or  ink out light is flashing or on. Returns the print head to its home position after ink cartridge replacement. Performs print head cleaning if pressed for 3 seconds when the  or  ink out light is off.

Lights

Light Status	Printer Status
	Printer is on.
	Receiving data, replacing an ink cartridge, charging ink, or cleaning the print head.
	Paper out. Load paper in the sheet feeder; then press the  load/eject button to resume printing.



Options and Consumable Products

Interface cables

You can use any interface cable that meets the following specifications. See your computer manual for any additional requirements.

- Parallel Interface Cable (shielded) C83602* from D-SUB 25-pin (computer) to 36-pin Amphenol 57 Series (printer)
- USB Interface Cable (shielded) C83623* from Series A 4-pin (computer) to Series B 4-pin (printer) (This cable not supplied in all locations.)

Note:

The asterisk (*) is a substitute for the last digit of the product number, which varies by country.



Caution:

Use only the interface cables listed above. Using other cables not covered by EPSON warranties may cause the printer to malfunction.

Proof Sign-off:
K. Nishi
N.Nomoto
K.Norum

Seychelles
html.bk

A5 size
7/10/98

Pre-Rev. A

OPTION.FM
Pass 2

R

EPSON Photo Quality Glossy Film (A4)	S041071
EPSON Photo Quality Glossy Film (Letter)	S041072
EPSON Photo Quality Glossy Film (A6)	S041107
EPSON Photo Quality Glossy Paper (A4)	S041126
EPSON Photo Quality Glossy Paper (Letter)	S041124
EPSON Ink Jet Transparencies (A4)	S041063
EPSON Ink Jet Transparencies (Letter)	S041064
EPSON Photo Paper (A4)	S041140
EPSON Photo Paper (Letter)	S041141
EPSON Photo Paper (4 × 6")	S041134
EPSON Photo Paper Cards (A4)	S041177
EPSON Photo Stickers 16 (A6)	S041144
EPSON Photo Stickers 4 (A6)	S041176
EPSON Panoramic Photo Paper (210 × 594 mm)	S041145
EPSON Iron-On Cool Peel Transfer Paper (A4)	S041154
EPSON Iron-On Cool Peel Transfer Paper (Letter)	S041153
	S041155

あり

Note:

The availability of special media varies by country.

Printer Specifications

Printing

Printing method	On-demand ink jet
Nozzle configuration	Monochrome (black) 48 nozzles Color (cyan, magenta, yellow, light cyan, light magenta) 240 nozzles (48 (each color) × 5)

Printable columns and printing speeds:

Character mode:

Character Pitch	Printing Column	LQ Printing Speed
10 cpi*	80	200 cps**
12 cpi	96	240 cps
15 cpi	120	300 cps
17 cpi (10 condensed)	137	342 cps
17 cpi (10 condensed)	160	400 cps

*cpi stands for "characters per inch".

**cps stands for "characters per second".

Raster graphics mode:

Horizontal resolution	Printable width	Available dots	CR speed
180 dpi*	209.8 mm (8.26 inches)	1488	20 ips**
360 dpi	209.8 mm (8.26 inches)	2976	20 ips
720 dpi	209.8 mm (8.26 inches)	5952	20 ips

*dpi stands for "dots per inch".

**ips stands for "inches per seconds".

Proof Sign-off:

K. Nishi
N.Nomoto
K.Norum

Seychelles

html.bk

A5 size
7/10/98

Pre-Rev. A

SPEC.FM
Pass 2

R

Envelopes:

Size	No. 10 (104 mm × 240 mm) DL (110 mm × 220 mm) C6 (114 mm × 162 mm) 132 mm × 220 mm
Paper types	Plain bond paper, air mail
Thickness	0.16 mm to 0.52 mm (0.006 to 0.02 inch)
Weight	45 g/m ² (12 lb) to 75 g/m ² (20 lb)

Index cards:

Size	A6 (105 mm × 148 mm) 5 × 8" (127 mm × 203 mm) 8 × 10" (203 mm × 254 mm)
Paper types	Special papers distributed by EPSON

Transparencies, glossy film, glossy paper:

Size	A4 (210 mm × 297 mm) Letter (216 mm × 279 mm) A6 (105 mm × 148 mm)* * Glossy film only
Paper types	Special papers distributed by EPSON

Self adhesive sheets:

Size	A4 (210 mm × 297 mm)
Paper types	Special papers distributed by EPSON

Photo paper:

Size	A4 (210 mm × 297 mm) Letter (216 mm × 279 mm) 4 × 6" (102 mm × 152 mm) Panoramic (210 mm × 594 mm)
Paper types	Special papers distributed by EPSON

Envelopes

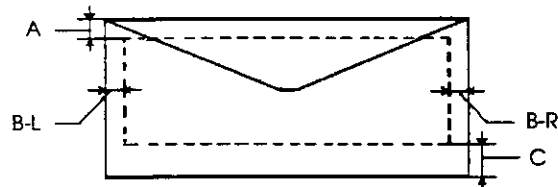

- A The minimum top margin is 3.0 mm (0.12").
When loading multiple sheets of EPSON Photo Quality Glossy Film, the minimum top margin is 30.0 mm (1.2").
- B-L The minimum left margin is 3.0 mm (0.12").
- B-R The minimum right margin is as follows:
3.0 mm (0.12") for single sheets and C6 envelopes.
9.0 mm (0.35") for letter and legal size.
7.0 mm (0.28") for DL envelopes.
28.0 mm (1.10") for No. 10 envelopes.
- C The minimum bottom margin is 14.0 mm (0.55").
- * You can extend the minimum bottom margin to 3 mm by selecting Maximum as the Printable Area setting on the printer driver's Paper menu (for Windows) or Page Setup dialog box (for Macintosh). However, print quality may decline in the expanded area. Before printing large jobs using this setting, print a single sheet to confirm printout quality.

Note:

Always load paper into the sheet feeder short edge first. Load envelopes flap edge first with the flap side down.

**Caution:**

- EPSON recommends the use of original EPSON ink cartridges only. Other products not manufactured by EPSON may cause damage to your printer not covered by EPSON's warranties.
- Do not use an ink cartridge if the date on the package has expired.

Mechanical

Paper feed method	Friction
Paper path	Sheet feeder, rear entry
Sheet feeder capacity	About 100 sheets at 64 g/m ² (17 lb) paper
Dimensions	Storage Width: 429 mm (16.9 inches) Depth: 261 mm (10.3 inches) Height: 167 mm (6.6 inches)
	Printing Width: 429 mm (16.9 inches) Depth: 609 mm (24.0 inches) Height: 292 mm (11.5 inches)
Weight	5.2 kg (11.5 lb) without the ink cartridges

Proof Sign-off:

K. Nishi
N. Nomoto
K. Norum

Seychelles

html.bk

A5 size
7/10/98

Pre-Rev. A

SPEC.FM
Pass 2

R

Safety Approvals

Safety standards:

U.S. model	UL 1950, CSA 22.2 950
European model	EN60950 (VDE)

EMC:

U.S. model	FCC part 15 subpart B class B
European model	EN 55022 (CISPR Pub. 22) class B EN 50082-1 EN 61000-3-2 EN 61000-3-3
Australian model	AS/NZS 3548 class B

Interface Specifications

Your printer is equipped with an 8-bit parallel interface, a serial interface, and a USB interface.

Parallel interface

The built-in parallel interface has the following characteristics:

Proof Sign-off:

K. Nishi
N.Nomoto
K.Norum

Seychelles

html.bk

A5 size
7/10/98

Pre-Rev. A

SPEC.FM
Pass 2

R

Connector	8-pin mini-DIN
Recommended cable	Apple System Peripheral-8 cable (part number M0197)

USB interface

The printer's built-in USB interface is based on the standards specified in Universal Serial Bus Specifications Revision 1.0 and Universal Serial Bus Device Class Definition for Printing Devices Version 1.0. This interface has the following characteristics:

Standard	Based on Universal Serial Bus Specifications Revision 1.0, Universal Serial Bus Device Class Definition for Printing Devices Version 1.0
Bit rate	12 Mbps (full speed device)
Data encoding	NRZI
Adaptable connector	USB Series B
Recommended cable length	2 meters

Optional USB Cable

The specifications below apply to the optional USB cable (C83623*).

USB Series-A (4-pin) Plug Connector

USB Series-B (4-pin) Plug Connector

1.8 's long

Glossary

The following definitions apply specifically to printers.

application

A software program that helps you carry out a particular task, such as word processing or financial planning.

ASCII

American Standard Code for Information Interchange. A standardized coding system for assigning numerical codes to letters and symbols.

banding

The horizontal lines that sometimes appear when printing graphics. This occurs when the print head is misaligned. See also *MicroWeave*.

bit

A binary digit (0 or 1), which is the smallest unit of information used by a printer or computer.

brightness

The lightness or darkness of an image.

buffer

The portion of the printer's memory used to store data before printing it.

byte

A unit of information consisting of eight bits.

characters per inch (cpi)

A measure of the size of text characters, sometimes referred to as pitch.

CMYK

Cyan (blue-green), magenta, yellow, and black. These colored inks are used to create the subtractive system array of printed colors.

color matching

A method of processing color data so that colors displayed on a computer screen closely match colors in printouts. A variety of color-matching software is available. See also *ColorSync*.

ColorSync

Macintosh software that is designed to help you get WYSIWIG (what you see is what you get) color output. This software prints colors as you see them on your screen.

cpi

See *characters per inch*.



font

A style of type designated by a family name.

grayscale

A scale of shades of gray from black to white. Grayscale is used to represent colors when printing with black ink only.

halftones

Patterns of black or colored dots used to reproduce an image.

halftoning

Method of using dot patterns to represent an image. Halftoning makes it possible to produce varying shades of gray using only black dots, or a nearly infinite array of colors using only a few colors of dots. See also *halftones*.

high speed printing

Printing in which images are printed in both directions. This provides faster printing.

initialization

Returns the printer to its defaults (fixed set of conditions). This happens every time you turn on the printer or reset the printer.

Ink Cartridge

The cartridge contains ink.

Ink Jet

A method of printing in which each letter or symbol is formed by precisely spraying ink onto paper.

interface

The connection between the computer and the printer. A parallel interface transmits data one character or code at a time. A serial interface transmits data one bit at a time.

interface cable

The cable that connects between the computer and the printer.

local printer

The printer which is connected to the computer's port directly by interface cable.

media

Materials upon which data is printed, such as envelopes, plain paper, special paper, and transparency film.

memory

The part of the printer's electronic system that is used to store information (data). Some information is fixed and is used to control how the printer operates. Information that is sent to the printer from the computer is stored in memory temporary. See also *RAM* and *ROM*.

ROM

Read Only Memory. A portion of memory that can only be read and cannot be used for data storage. ROM retains its contents when you turn off the printer.

RGB

Red, green, and blue. These colors, in phosphors irradiated by the computer monitor's electron gun, are used to create the additive array of screen colors.

serial interface

See *interface*.

spool

The first step in printing, in which the printer driver converts the print data into codes that your printer understands. This data is then sent to the printer directly or to the print server.

spool manager

The software program that converts print data into codes that your printer understands. See also *spool*.

status monitor

The software program that allows you to check the printer's status.

subtractive colors

Colors produced by pigments that absorb some colors of light and reflect others. See also *CMYK*.

USB interface

Universal Serial Bus. This interface enables the user to connect up to 127 peripheral devices (such as keyboards, mice, and printers) to the computer through a single, general purpose port. The use of USB hubs allows you to add additional ports. See also *interface*.

WYSIWIG

What-you-see-is-what-you-get. This term is used to describe printout that looks exactly like it appears on screen.



How To

Using the Printer Software for Windows

Printer Software Introduction

The printer software includes a printer driver and printer utilities. The printer driver lets you choose from a wide variety of settings to get the best results from your printer. The printer utilities help you check the printer and keep it in top condition.

For information on how to access the printer software, see "Accessing the printer software".

For information on using the printer driver, see "Making Changes to Printer Driver Settings".

Online help provides more information about the printer software. See "Getting Information Through Online Help" for instructions on accessing help.

Note:

The specific features available in the printer software vary depending on the version of Windows you are using.

From Windows applications

Open the File menu and choose Print or Print Setup. Then click Printer, Setup, Options, or Properties. (Depending on your application, you may need to click a combination of these buttons.) You see the printer software window.

From My Computer

1. Double-click the My Computer icon, then double-click the Printers folder.
2. For Windows 95 and Windows 98, right-click your printer icon, then click Properties. For Windows NT 4.0, right-click your printer icon, then click Document Defaults. You see the printer software window.

Making Changes to Printer Driver Settings



The printer software features the following printer driver setting menus.

Main Media Type, Ink, Mode

Paper Paper size, Copies, Orientation, Printable Area

Layout Proportional Printing, Print Layout, Watermark

The settings on the Main menu are arranged to give you three levels of control over the printer driver, as explained below.

Automatic setting	The quickest and easiest way to start printing. See  Using the Automatic setting  .
-------------------	-----------------------------------------------------------------------------------------------------------------------------------------------------------------------------------------------------------------------------------------------------------

Proof Sign-off:

K. Nishi
N. Nomoto
K. Norum

Seychelles
html.bk

A5 size
7/10/98

Pre-Rev. A

SOFTW.FM
Pass 2

R

Photo Quality Ink Jet Paper

EPSON Photo Quality Ink Jet Paper (A4)	S041061 S041026
EPSON Photo Quality Ink Jet Paper (Letter)	S041062 S041029
EPSON Photo Quality Ink Jet Paper (Legal)	S041067 S041048
EPSON Photo Quality Ink Jet Card (A6)	S041054
EPSON Photo Quality Ink Jet Card (5 x 8 $\frac{1}{2}$)	S041121
EPSON Photo Quality Ink Jet Card (8 x 10 $\frac{1}{2}$)	S041122
EPSON Photo Quality Self Adhesive Sheet (A4)	S041106
EPSON Ink Jet Note Cards A6 (with envelopes)	S041147
EPSON Ink Jet Greeting Cards 5 x 8 $\frac{1}{2}$ (with envelopes)	S041148
EPSON Ink Jet Greeting Cards 8 x 10 $\frac{1}{2}$ (with envelopes)	S041149

Photo Paper

EPSON Photo Quality Glossy Paper (A4)	S041126
EPSON Photo Quality Glossy Paper (Letter)	S041124
EPSON Photo Paper (A4)	S041140
EPSON Photo Paper (Letter)	S041141
EPSON Photo Paper (4 x 6 $\frac{1}{2}$)	S041134
EPSON Panoramic Photo Paper (210 x 594 mm)	S041145
EPSON Photo Paper Cards (A4)	S041177

Photo Quality Glossy Film

EPSON Photo Quality Glossy Film (A4)	S041071
EPSON Photo Quality Glossy Film (Letter)	S041072
EPSON Photo Quality Glossy Film (A6)	S041107
EPSON Photo Stickers 16 (A6)	S041144
EPSON Photo Stickers 4 (A6)	S041176

- *Most Windows applications feature paper size and page layout settings that override similar settings on the printer driver. However, if your application does not, you should also verify the settings on the printer driver's Paper menu.*

Using the Custom settings

The Custom settings let you make a wide range of changes with a single click of the mouse. In the Custom settings list, you'll find ready-made settings provided by EPSON designed to match a particular kind of printout, such as graphs and charts for a presentation or images taken by a digital camera.

You can also create your own settings and add them to this list. See "Using the Advanced settings" for details.

The Custom settings list includes the following ready-made settings:

Digital Camera	Good for printing scanned images or images taken with a digital camera.
Text/Graph	Good for printing presentation documents such as graphs and charts.
PhotoEnhance3	Best for printing video images or scanned images. This setting automatically adjusts the contrast, saturation, and brightness of the original image data to produce sharper, more vivid color printouts. PhotoEnhance3 does not affect your original image data. Note: <i>Printing with PhotoEnhance3 selected may increase print time depending on your computer system and the amount of data contained in your image.</i>
Economy	Good for printing drafts of text
ICM (For Windows 95, and 98)	ICM means Image Color Matching. This feature automatically adjusts printout colors to match colors on your screen.

1. Click the Custom button on the Main menu and then click Advanced. The following dialog box appears:

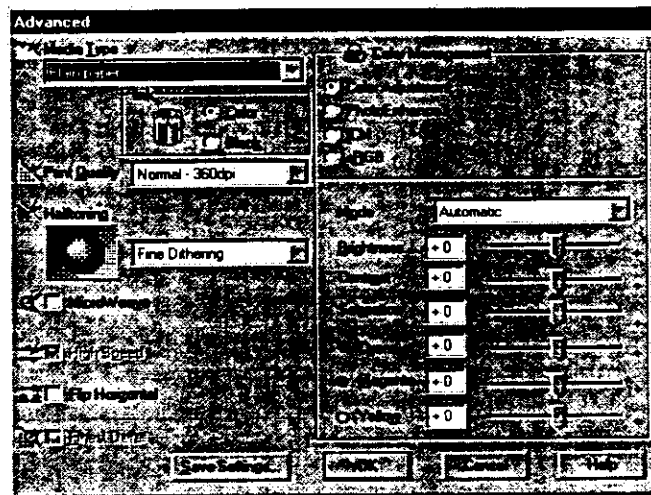

2. Select the Media Type you loaded in the printer. For details, see "Making the Media Type setting".
3. Choose Color or Black in the Ink option.
4. Select a Print Quality setting.
5. Make other settings as needed. For details, see online help.

Note:

Some settings are enabled or disabled depending on the Media Type, Ink, and Print Quality settings you make.

6. Click OK to apply your settings and return to the Main menu. If you want to return to the Main menu without applying your settings, click Cancel.

Modifying the printout style

You can modify your printout style using a variety of printer driver settings located on the Paper and Layout menus.

On the Paper menu, you can specify the orientation of your printout, and adjust the printable area. On the Layout menu, you can have the size of your document automatically fitted to the paper size, print 2 or 4 pages of your document on one sheet, and put a watermark on your document.

Adjusting page orientation and printable area

You can adjust the page orientation and printable area from the Paper menu.

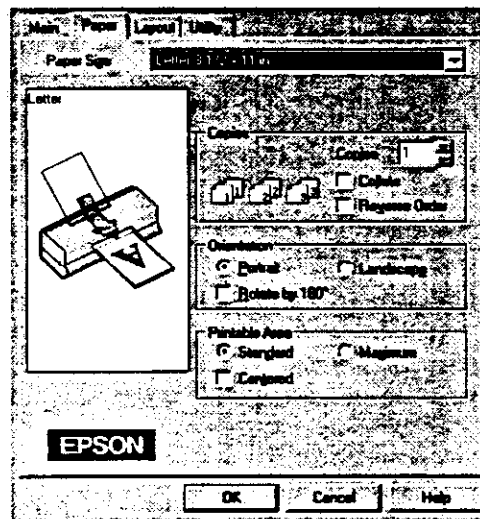

To change the orientation of your printout, select Portrait (tall) or Landscape (wide). If you need to print close to the bottom of the page, click the Rotate by 180° check box.

Fit to Page	Proportionally enlarges or reduces the size of your document to make it fit the paper size you select in the Paper Size list on the Paper menu.
Custom	Lets you define the percentage you want to enlarge or reduce an image. Click the arrows next to the Proportion box to select from 10% to 400%.

Printing 2 or 4 pages on one sheet

To print 2 or 4 pages of your document on one sheet of paper, use the Print Layout options on the Layout menu.

2 Pages 4 Pages	Prints 2 or 4 pages of your document on a single piece of paper.
Page Order	Allows you to select the order of the pages you want to print.
Print page frames	Allows you to print a frame around each page on the sheet of paper.

Printing a watermark on your document

To print a watermark on your document, click the Watermark check box on the Layout menu.

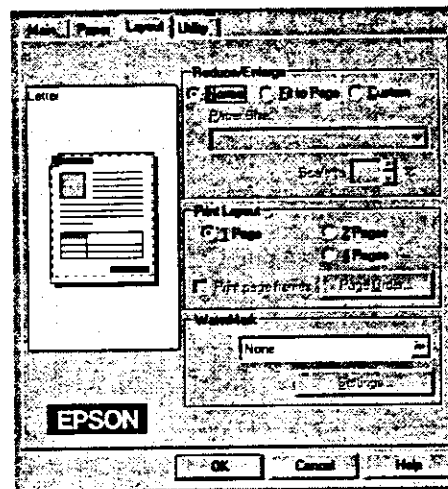

Increasing the Print Speed

General tips

Printing color images using higher print quality settings takes longer than printing black-and-white images with normal print quality, because the volume of data in a high-quality color document is much greater. For this reason, it is important to be selective in your use of color and print quality settings if you also require a faster print speed.

Even if your document requires the highest print quality and extensive use of color, it may still be possible to optimize the print speed by adjusting other printing conditions. Keep in mind that changing some conditions to increase the print speed may also lower print quality.

The following table shows the factors that inversely affect print speed and print quality (increasing one will decrease the other).

Print quality Print speed	Lower Faster	Higher Slower
Printer driver settings		
Print Quality	Economy, Normal - 360 dpi	Photo - 1440 dpi
High Speed	On	Off
Halftoning	No Halftoning	Error Diffusion
Finest Detail	On	Off
Data characteristics		
Image size	Small	Large
Resolution	Low	High

Proof Sign-off:
K. Nishi _____
N. Nomoto _____
K. Norum _____

Seychelles
html.bk

A5 size
7/10/98

Pre-Rev. A

SOFTW.FM
Pass 2

R

High Speed Copies

Turn this on to print multiple copies of your document faster.

Show Progress Meter

Turn this on to display printing progress while printing.

EPSON Printer Port (For Windows 95 and 98 only)

Turn this on to speed up the data transfer rate to EPSON printers.

Enable DMA transfer (For Windows 95 and 98 only)

If your computer has a parallel port which supports ECP mode, you can enable DMA transfer to help you speed up printing. See your computer manual to determine if it supports ECP mode and DMA transfer.

To determine whether you need to enable DMA transfer, compare the message below the EPSON Printer Port setting to this table, and take the recommended action.

Message	Action
High Speed (DMA) Transfer enabled.	DMA transfer is already enabled. Click OK to close the dialog box.
For higher data transfer rates, use DMA Transfer.	Follow the steps below this table to enable DMA transfer.



4. Click the Resources tab and click the Use automatic settings check box to deselect the Automatic Setting. Write down the Input/Output Range settings shown in the Resource settings box.

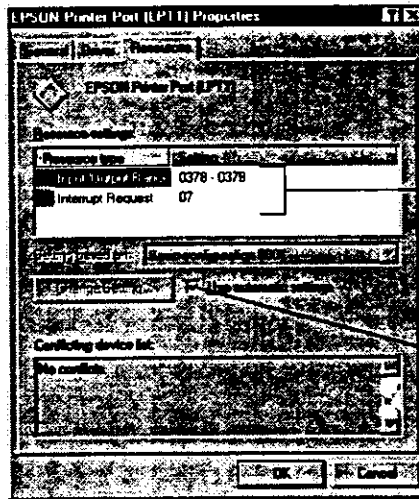

Write down
these settings

Click here to remove
checkmark



If your computer has a parallel port which supports ECP mode, you can make certain print speed settings with the Port Configuration dialog box. Before making settings, make sure that the ECP mode has been selected in your computer settings. For details about ECP mode, see your computer manual.

To access the Port Configuration dialog box, double-click the My Computer icon, double-click the Printer icon, right-click your printer icon, and select Properties. The printer driver window appears. Click the Port tab, then click the Configure Port button.

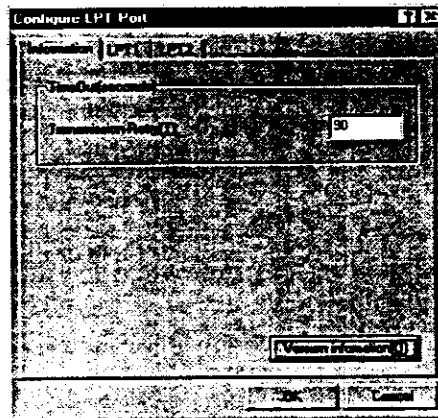

Click the LPT port tab for the port to which your printer is connected, then click the Port Configuration button.

Using the Printer Software for Macintosh

Printer Software Introduction

The printer software includes a printer driver and printer utilities. The printer driver lets you choose from a wide variety of settings to get the best results from your printer. The printer utilities help you check the printer and keep it in top condition.

You can get more information about the printer software by clicking the help icon button in the printer software dialog boxes.

For information on using the printer driver, see "Making Changes to Printer Driver Settings".

EPSON printer utilities allow you to check the current printer status and do some printer maintenance from your screen. To access the utilities, click the Utility icon button in the Print dialog box, then click the button for the utility you want to use.

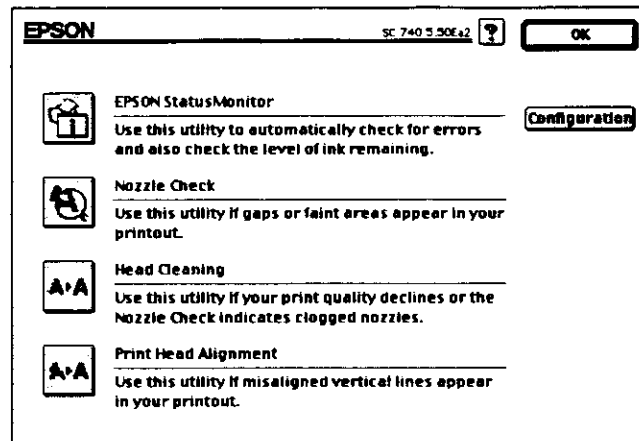

In addition to making groups of settings that affect overall print quality, you can also change page setup and layout using the Page Setup and the Layout dialog boxes. For information on page setup options, see "Changing the page setup". For information on page layout options, see "Modifying the layout".

Making the Media Type setting

The Media Type setting determines what other settings are available, so you should always make this setting first.

In the Print dialog box, select the Media Type setting that matches the paper you loaded in the printer. Find your paper in the list below, then select a corresponding Media Type setting (shown in bold). For some kinds of paper, you have several Media Type settings to choose from.

Plain Paper

- Plain paper
- Envelopes

360 dpi Ink Jet Paper

EPSON 360 dpi Ink Jet Paper (A4)	S041059 S041025
EPSON 360 dpi Ink Jet Paper (Letter)	S041060 S041028
EPSON Iron-On Cool Peel Transfer Paper (A4)	S041154
EPSON Iron-On Cool Peel Transfer Paper (Letter)	S041153 S041155

Photo Quality Ink Jet Paper

EPSON Photo Quality Ink Jet Paper (A4)	S041061 S041026
EPSON Photo Quality Ink Jet Paper (Letter)	S041062 S041029

フォントサイズ
変更予定

Using the Automatic setting

When Automatic is selected as the Mode setting in the Print dialog box, the printer driver takes care of all detailed settings based on the current Media Type and Ink settings. To make the Ink setting, click **Color** to print in color, or **Black** to print in black-and-white or grayscale. To make the Media Type setting, see "Making the Media Type setting".

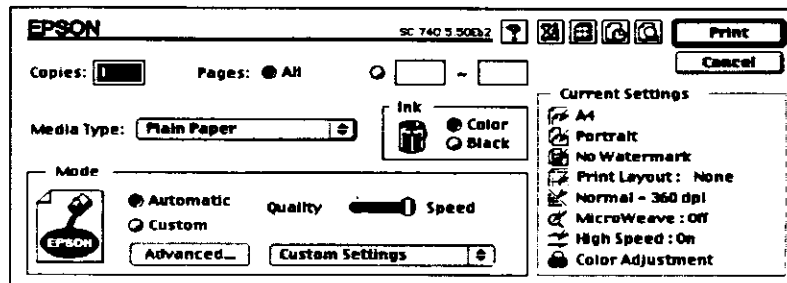

Note:

Depending on the media you choose in the Media Type list while Automatic is selected, a slide bar appears in the Mode box that lets you choose Quality or Speed. Select Quality when print quality is more important than speed.

Using the Custom settings

The Custom settings let you make a wide range of changes with a single click of the mouse. In the Custom settings list, you'll find ready-made settings provided by EPSON designed to match a particular kind of printout, such as graphs and charts for a presentation or images taken by a digital camera.

You can also create your own settings and add them to this list. See "Using the Advanced settings".

Using the Advanced settings

The Advanced settings give you complete control over your printing environment. Use these settings to experiment with new printing ideas, or to fine-tune a range of print settings to meet your individual needs. Once you are satisfied with your new settings, you can give them a name and add them to the Custom settings list.

1. Click the Custom button in the Print dialog box and then click the Advanced button. The Advanced dialog box appears.

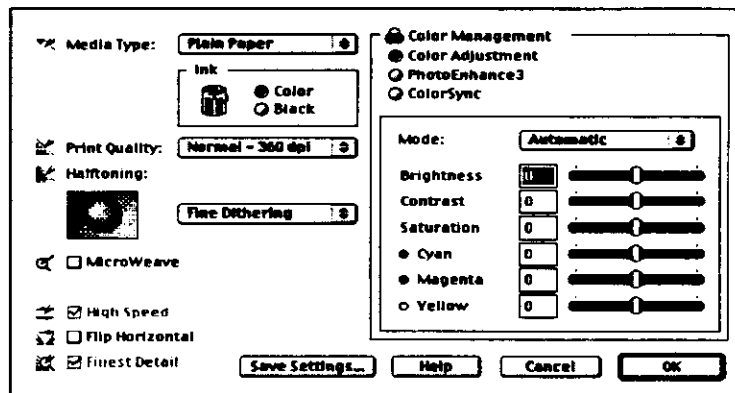

2. Select the Media Type that you loaded in the printer. For details, see "Making the Media Type setting".
3. Choose Color or Black in the Ink option.
4. Select the Print Quality setting.
5. Make other settings. For details, see online help.

Note:

Some settings are enabled or disabled depending on the Print Quality, Media Type, and Ink settings you make.



Using your saved settings

To select your settings, click Custom in the Print dialog box, then select your setting in the Custom settings list, located below and to the right of the Custom button.

If you change the Media Type or Ink option when one of your customized settings is selected in the settings list, the selection shown in the list returns to Custom Settings. The customized setting that was previously selected is not affected by this change. To return to your customized setting, simply reselect it in the list.

Changing the page setup

In the Page Setup dialog box, you can change the paper size, specify the orientation of your printout, and adjust the printable area.

Choose Page Setup from the File menu of your application. The Page Setup dialog box appears:

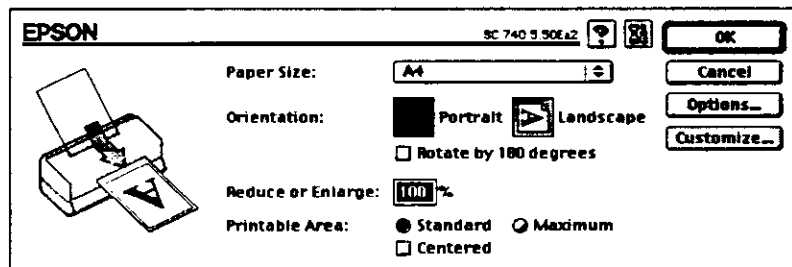



2. To define a new paper size, click **New**. The dialog box changes to allow you to enter a name for the new size.

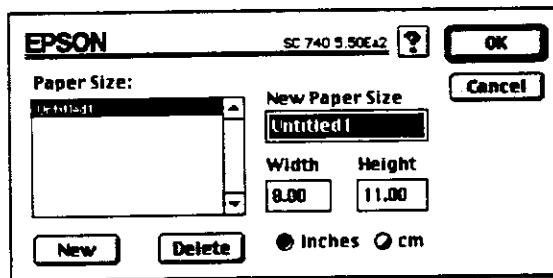

3. Type the paper size name in the New Paper Size box.
4. Specify the measurement unit as either Inches or cm.
5. Type in the width and the height.
6. Click **OK**. You return to the Page Setup dialog box.

You can define up to 8 paper sizes. The paper size names you create will appear in the Paper Size menu in the Page Setup dialog box.

To delete a custom paper size, click **Customize** in the Page Setup dialog box, select its name from the list in the Custom Paper dialog box, and click **Delete**.



Select the watermark you want to print from the Watermark list; then select its position, size, color, and intensity. The position and size of the watermark can be changed by dragging it with your mouse in the preview window on the left.

You can also create your own custom watermarks by adding PICT files to the Watermark list. Follow these steps:

1. Click the Add/Delete button to the right of the Watermark list. The following dialog box appears:

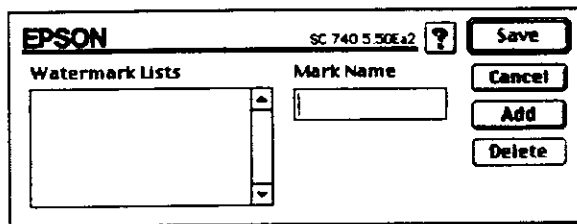

2. Click Add. Select the image file you want to add and click Open.

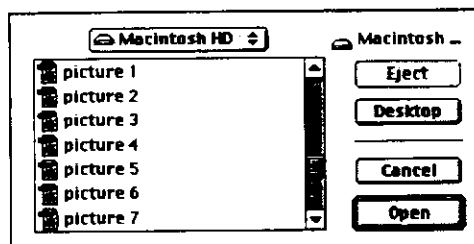

1. Click the Background Printing icon button in the Print dialog box. The Background Printing dialog box appears.

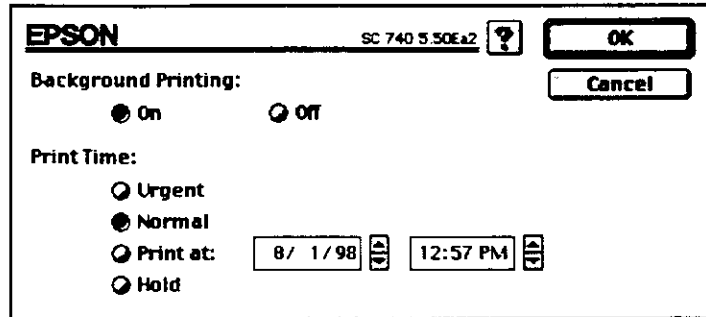

2. Click On to turn on background printing, if necessary.
3. Select Urgent, Normal, Print at:, or Hold from the Print Time list.

If you select Print at:, use the arrows beside the date and time boxes to specify the date and time you want to print the document.

Note:

Make sure the computer and printer are turned on at the date and time you specified.

4. Click OK. The Background Printing dialog box closes.
5. In the Print dialog box, make sure your print settings are as you want them, then click Print.

Note:

You can check or change the priority of print jobs using the EPSON Monitor3 utility. See "Controlling Background Printing" on page 114 for details.

Printing on Special Paper

Paper Handling

Loading Plain Paper

Follow these steps to load plain paper in the printer.

1. Lower the output tray and slide out the extension. Next, slide the left guide so that the distance between the edge guides is slightly wider than the width of your paper.
2. Fan a stack of paper; then tap it on a flat surface to even the edges.
3. Load the stack of paper with the printable side up and the right edge of the paper resting against the right side of the sheet feeder. Then slide the left edge guide against the edge of the paper.

Note:

- Always load paper into the sheet feeder short edge first.*
- Make sure the paper stack fits under the arrow mark inside the edge guide.*

Loading Special Paper and Other Media

You can use most plain bond paper to achieve good results. However, coated paper and glossy paper give you better results because they reduce the amount of ink that is absorbed.

- Loading capacity for envelopes and EPSON special media is explained below.

Envelopes

Up to 10 envelopes.

Note:

If the total thickness of the stack of envelopes exceeds 10 mm, press each envelope flat before loading.

360 dpi Ink Jet Paper
and Photo Quality
Ink Jet Paper

Up to the arrow mark on the left edge guide.

Photo Quality Ink Jet
Card, Ink Jet Note
Card, and Ink Jet
Greeting Card

Up to 30 index cards. Always place the included support sheet under the cards.

Photo Quality
Glossy Film

One sheet at a time for best results. Always put a support sheet* or a sheet of plain paper under the glossy film.
If you wish to print with multiple sheets, load only up to 20 sheets and set the minimum top margin of the page to 30 mm.

Ink Jet
Transparencies

Up to 30 transparencies. Always put a sheet of plain paper under the stack of transparencies.

Photo Quality
Self Adhesive Sheet

One sheet at a time.

Proof Sign-off:

K. Nishi
N. Nomoto
K. Norum

Seychelles
html.bk

A5 size
7/10/98

Pre-Rev. A

PAPER.FM
Pass 2

R

Note:

Return the adjust lever to the "0" position before printing on media of normal thickness. Leaving the lever in the "+" position may cause gaps in the printed image.

- When you print on the reverse side of Ink Jet Card whose front side has already been printed on with Maximum selected as the Printable Area setting, flatten the cards or curl them slightly toward the opposite side before loading. Set the adjust lever to "+" position before printing.

About special media cleaning sheets

Cleaning sheets packaged with EPSON special media should not be used with this printer. The cleaning function performed by these sheets is not necessary with this type of printer, and the sheets could jam in the printer.

Loading Envelopes

When printing on envelopes, please note the following:

- You can load up to 10 envelopes into the sheet feeder.

Note:

The folding quality and thickness of envelopes varies widely. If the total thickness of the stack of envelopes exceeds 10 mm, press each envelope in the stack flat before loading.

Loading

- Load the paper printable side up with the perforated margins positioned as shown in the illustration.

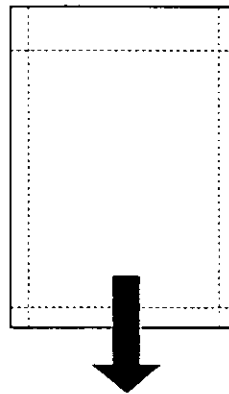

loading position

- Use flat, undamaged paper. If the paper or the support sheet is curled, flatten it before loading to avoid paper feeding problems.
- Always place the included support sheet under the stack of Photo Paper, but do not print on it.
- You can load up to 20 sheets of Photo Paper into the sheet feeder.
- To print on the coated (whiter) side of Photo Paper, select Photo Paper as the Media Type setting and EPSON PhotoPaper 4X6 in as the Paper Size setting in your printer driver.



Removing the perforated margins

- To remove the perforated margins, fold the paper back and forth a few times along the perforations, then carefully tear the margins off.

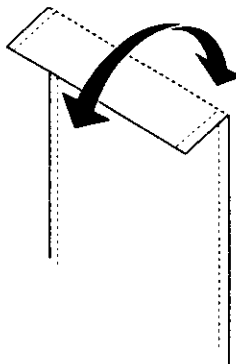

- You may also remove the margins by cutting along the perforations.

Storing

- Return unused paper to the original package as soon as you finish printing, and avoid storing it in places exposed to high temperature, humidity, or direct sunlight.
- EPSON recommends storing your printouts in a resealable plastic bag and keeping them away from high temperature, humidity, and direct sunlight.

Checking Printer Status and Managing Print Jobs for Macintosh

Using the EPSON StatusMonitor

The StatusMonitor utility monitors the printer. If it detects a printer error, it will inform you with an error message.

You can also use this utility to check ink levels before printing.

To use the StatusMonitor, click the EPSON StatusMonitor button in the Utility dialog box. The following dialog box appears:

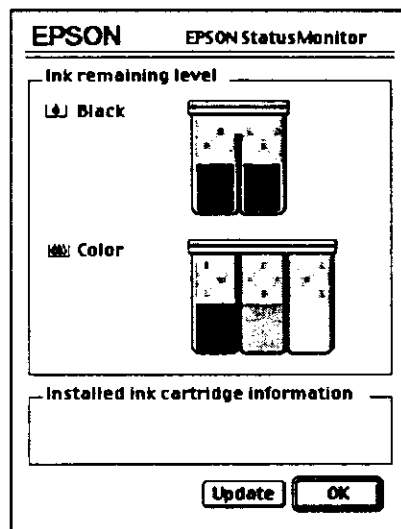

Note:

To access the Utility dialog box, see "" on page 86.

The StatusMonitor checks the amount of ink remaining when opened. To update the ink-level information, click the Update button.

Controlling Background Printing

After you send a print job to the printer, you can use the EPSON Monitor3 utility to check, control, or cancel print jobs that are queued for printing. This utility also shows the status of the job currently being printed.

Using EPSON Monitor3

To use EPSON Monitor3, you must first turn on Background Printing in the Chooser or in the Background Printing dialog box. Then, after sending a print job to the printer, select Epson Monitor3 from the Application menu at the right end of the menu bar. This opens a dialog box similar to the following:

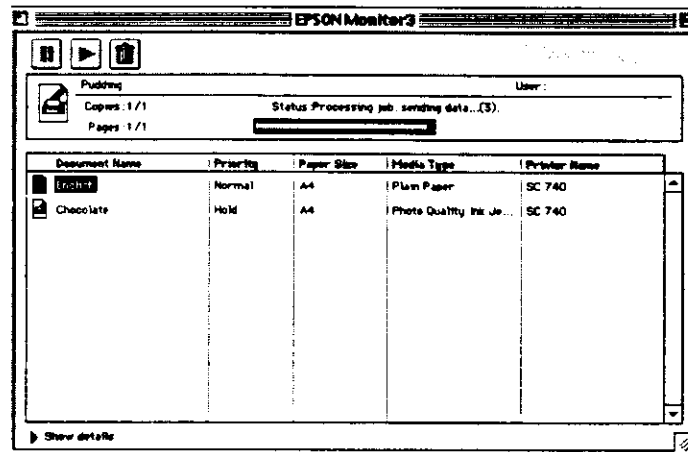

Note:

You can also open EPSON Monitor3 by double-clicking the EPSON Monitor3 icon in the Extensions folder.



Note:

You can also change the priority of print jobs whose print times were previously set in the printer driver's Background Printing dialog box.

1. Click the Show details arrow at the bottom of the EPSON Monitor3 dialog box, then click a document name in the Document Name box. You will see an extended dialog box similar to the one below.

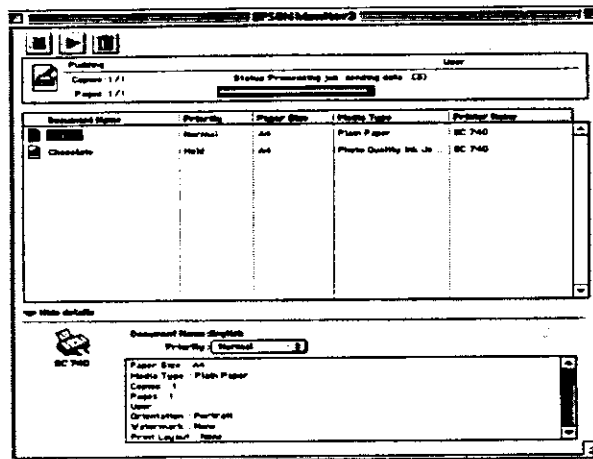

2. Select Urgent, Normal, Hold, or Print Time from the Priority list.

If you select Print Time, a dialog box will appear where you can specify the date and time that you want to print the document.

Checking Printer Status and Managing Print Jobs for Windows

Using the Progress Meter

When you send a print job to the printer, the Progress Meter appears on your computer screen.

Progress Meter

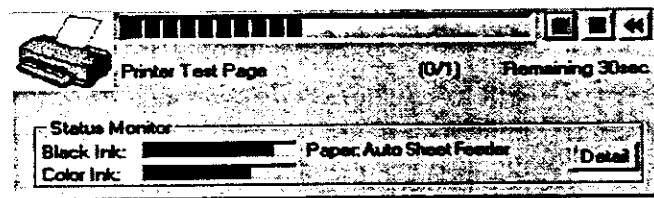

This meter shows the progress of the current print job and provides printer status information when bidirectional communication between the printer and computer is established.

Use these buttons to cancel, pause and resume, and restart selected print jobs from the Progress Meter.



Stop Cancels printing



Pause Pauses printing until you press it again



Reprint Restarts printing from the current page, reprints the whole document, or holds the document for printing later

If you click the Detail button, you can open the Printer Status window to obtain more detailed information.



Note:

- If you have not installed the Status Monitor yet, see "Installing the Status Monitor 2 utility".*
- Before using the Status Monitor, be sure to read the README file located in the EPSON Status Monitor 2 folder in the Epson folder on your hard drive.*

Installing the Status Monitor 2 utility

Note:

If you installed the Status Monitor when you installed the printer software, you do not need to install it again.

To use the Status Monitor 2, you need to install the software as described below:

1. Make sure Windows is running. Insert the printer software CD-ROM in the CD-ROM drive. (For printer software floppy disk users, insert the floppy disk in a disk drive.)
2. If a dialog box appears, click Quit.
3. Click Start, and select Run.
4. Type D:\ and specify your preferred language by typing English, Francais, German, Italian, Portugal, or Spanish followed by \status2.
5. Click OK, then follow the instructions on the screen.

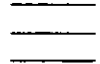

You see the Status Monitor 2 window:

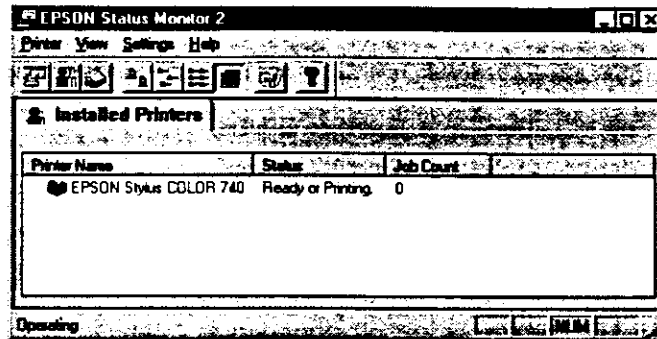

The EPSON Status Monitor 2 window displays this information:

Printer icon	The color of the printer icon indicates the current printer status. Green: Ready Yellow: Some kind of maintenance is necessary Red: Error has occurred Dimmed: Communication problem between Status Monitor 2 and printer
Printer Name	The name of the EPSON printer connected directly to your computer appears in this column.
Status	Brief messages appear here regarding the current status of the printer.
Job Count	Shows the number of jobs waiting to print. Note: To get more information, choose Job Status on the Printer menu or click the Job Status button on the tool bar.

Note:

- You can add or delete printers from the list. To save computer memory, delete printers you do not need to monitor. (This does not remove the printer driver from your computer.) Choose Add Printer or Delete Printer on the Settings menu.

- Current Status**
Provides you with detailed printer status information, a graphic display, and status messages. If a printer error occurs, troubleshooting tips appear in the bottom message box. When ink runs low, clicking the Replace Ink Cartridge button displays cartridge replacement instructions. If you are using Windows 95 or 98, this also causes the print head to move to the cartridge replacement position.
- Consumables**
Provides a graphic display of the amount of ink remaining.
- Printer information**
Provides you with information about network connections and other printer resources (for printers connected over a network).

For details, see the Status Monitor's online help.

Making monitoring settings

From the Status Monitor window, you can make monitoring settings such as selecting the monitoring interval and turning on or off background monitoring.

1. Make sure the Status Monitor is active. (It is active if a printer-shaped icon appears on the taskbar at the bottom of your computer screen.) If the Status Monitor is inactive, open the EPSON Status Monitor 2 window from Start, as described in "Accessing EPSON Status Monitor 2". Then point to Background Monitoring on the Settings menu and click Monitor from restart or Monitor now.

Note:

The Background Monitoring and Status Alert settings are not available while the Status Monitor is inactive.

Proof Sign-off:

K. Nishi
N.Nomoto
K.Norum

Seychelles

html.bk

A5 size
7/10/98

Pre-Rev. A

STATSW.FM
Pass 2

R

3. Click OK to save your settings.

Note:

If you want the Status Alert dialog box to appear in front of other windows on the desktop, right-click the background monitoring icon and choose Show on Top.

Network Printing

For Windows 95 and 98 Users

This section tells you how to set up your printer so that other computers on the network can use it. First, you need to set up the printer as a shared printer on the computer to which the printer is connected.

Then, you need to install the printer software on the other computers on the network and specify the network path from these computers to the printer.

Setting up your printer as a shared printer

Follow these steps to share a printer connected directly to your computer with other computers on a network:

1. Click Start, point to Settings, then click Control Panel.
2. Double-click Network.
3. Click File and Print Sharing.

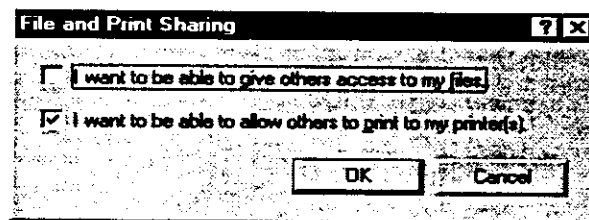

4. Click the I want to be able to allow others to print to my printer(s) check box and click OK.
5. In the Network window, click OK.

1. Install the printer software in the computer you want to print from. For instructions, see "Installing the Printer Software in Your PC" in the *Setup & Daily Use* guide.
2. Double-click the My Computer icon.
3. Double-click the Printers folder.
4. Right-click the icon of your printer, and click Properties.
5. Click the Details tab. Then click the Add Port button.

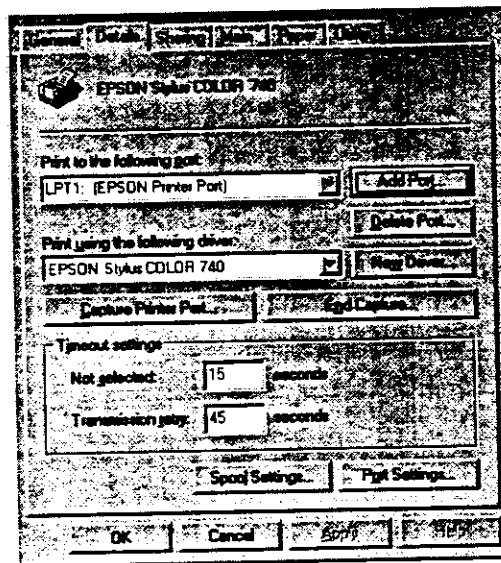

For Windows NT 4.0 Users

This section tells you how to set up your printer so that other computers on the network can use it. First, you need to set up the printer as a shared printer on the computer to which the printer is connected.

Then, you need to install the printer software on the other computers on the network and specify the network path from these computers to the printer.

Setting up your printer as a shared printer

Follow these steps to share a printer that is connected directly to your computer with others on a network.

1. Double-click the My Computer icon, then double-click the Printers folder and select your printer.
2. Click Sharing on the File menu.

4. Click the Network printer radio button. Click Next.
5. Double-click the icon of the computer that is directly connected to the printer. Then click the printer's icon.

Note:

Be sure to confirm all network settings with the network administrator.

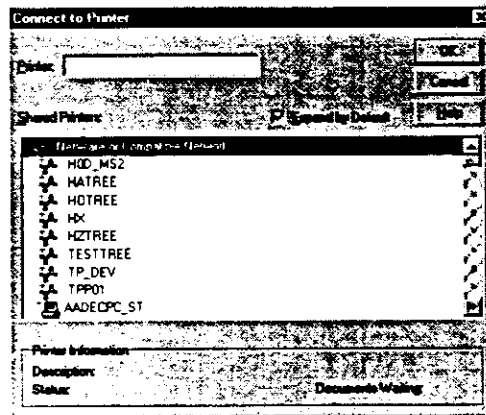

6. Click OK and follow the messages on the screen.





Replacing Ink Cartridges

Replacing an Empty Ink Cartridge









Using the printer's control panel

The printer's indicator lights will inform you when it is time to obtain a replacement ink cartridge and when it is time to replace an empty cartridge.

Note:

If you need to replace an ink cartridge when the  and  lights are off, see "Replacing an Old or Damaged Ink Cartridge" on page 135.

This table describes the status of the lights on your printer and the actions you need to take.



Lights	Action
 	Obtain a replacement black ink cartridge (S020187).
 	Replace the empty black ink cartridge.
 	Obtain a replacement color ink cartridge (S020193).
 	Replace the empty color ink cartridge.



Caution:

Do not move the print head by hand. Always use the  cleaning button to move it. Otherwise you may damage the printer.

Note:

If you press the  cleaning button for three seconds when the  and  ink out lights are off, the printer starts cleaning the print head.

4. Lift up the clamp that holds the cartridge you want to replace as far as it will go. When you do, the cartridge will rise partly out of the cartridge holder. Then lift the cartridge out of the printer and dispose of it properly. Do not take the used cartridge apart or try to refill it.



Warning:

If ink gets on your hands, wash them thoroughly with soap and water. If ink gets into your eyes, flush them immediately with water.





Caution:

Once you open the ink cartridge clamp, the ink cartridge becomes unusable and cannot be reinstalled even if ink remains.



Caution:

Once you install the cartridges, do not open their clamps again until you replace the ink cartridges. Otherwise, the cartridges may become unusable.

7. Press the  cleaning button. The printer moves the print head and begins charging the ink delivery system. This process takes about 1 minute to complete. When the ink charging process is finished, the printer returns the print head to its home position and the  power light stops flashing.



Caution:



The  power light continues to flash while the printer performs the ink charging operation. Never turn off the printer while this light is flashing. Doing so can result in incomplete charging of ink.

8. Close the printer cover.

Using the Status Monitor

If you have installed EPSON Status Monitor 2 in your computer, you can monitor the remaining ink level from your computer and view on-screen instructions for replacing a low or empty ink cartridge.



3. Hold down the  load/eject button for three seconds, the print head moves to the replace position. The  power light begins flashing.

4. Lift the appropriate ink cartridge clamp. Dispose of the empty ink cartridge properly.

5. Remove the yellow tape seal from the new cartridge and place the cartridge gently into the cartridge holder. Do not press down on the cartridge.

6. Press the ink cartridge clamp down until it locks in place.



Caution:

Once you install the cartridges, do not open their clamps again until you replace the ink cartridges. Otherwise, the cartridges may become unusable.

7. Press the  load/eject button again. The printer moves the print head back to its home position and charges ink in the system.

Maintenance

Checking the Print Head Nozzles

If you find that the printed image is unexpectedly faint or dots in the printed image are missing, you may be able to solve these problems by checking the print head nozzles.

You can check the print head nozzles from your computer with the Nozzle Check utility in the printer software, or from the printer itself by using the printer's control panel buttons.

Note:

Do not start the Nozzle Check utility while printing is in progress; otherwise your printout may be marred.

Using the Nozzle Check Utility

For Windows users

1. Access the printer software window. If you need instructions, see "Accessing the printer software" on page 49.
2. Click the Utility tab, then click the Nozzle Check button.
3. Follow the messages on your screen.

For Macintosh users



1. Access the Page Setup dialog box.
2. Click the Utility icon button, then click the Nozzle Check button.
3. Follow the messages on your screen.

Cleaning the Print Head

If you find that the printed image is unexpectedly faint or dots in the printed image are missing, you may be able to solve these problems by cleaning the print head, which ensures that the nozzles are delivering ink properly.



You can clean the print head from your computer with the Head Cleaning utility in the printer software, or from the printer itself by using the printer's control panel buttons.

Note:



- Print head cleaning uses both color and black ink. To avoid wasting ink, clean the print head only if print quality declines.*
- Use the Nozzle Check utility to confirm that the print head needs to be cleaned. This saves ink.*
- When the  or  ink out light is flashing or on, you cannot clean the print head. Replace the appropriate ink cartridge first.*
- Do not start the Head Cleaning or Nozzle Check utility while printing is in progress; otherwise your printout may be marred.*

Using the Head Cleaning utility

For Windows users

1. Make sure that both  and  ink out lights are off.

Note:



If the  or  ink out light is flashing, you can not clean the print head. Replace the appropriate ink cartridge first.

2. Access the printer software window. If you need instructions, see "Accessing the printer software" on page 49.
3. Click the Utility tab, then click the Head Cleaning button.

If print quality hasn't improved after repeating this procedure four or five times, one or both of your ink cartridges may be old or damaged and may need to be replaced. To replace an ink cartridge before it is empty, see "Replacing an Old or Damaged Ink Cartridge" on page 135.

If the print quality still has not improved after replacing the ink cartridges, contact your dealer.

For Macintosh users

1. Make sure that the printer is on, and the  and  ink out lights are off.
2. Click the Utility icon button in the Print dialog box. Then click the Head Cleaning button.
3. Follow the on-screen messages.

The  power light flashes while the printer performs the cleaning cycle. This operation takes about one minute to complete.



Caution:

Never turn off the printer while  power light is flashing. Doing so may damage the printer.

4. When the  power light stops flashing, click the Confirmation button in the Head Cleaning dialog box to print a nozzle check pattern and to reset the cleaning cycle. Use the check pattern to confirm the head is clean.

If print quality hasn't improved after repeating this procedure four or five times, one or both of your ink cartridges may be old or damaged and may need to be replaced. To replace an ink cartridge before it is empty, see "Replacing an Old or Damaged Ink Cartridge" on page 135.

If the print quality still has not improved after replacing the ink cartridges, contact your dealer.

If print quality hasn't improved after repeating this procedure four or five times, one or both of your ink cartridges may be old or damaged and may need to be replaced. To replace an ink cartridge before it is empty, see "Replacing an Old or Damaged Ink Cartridge" on page 135.

If the print quality still has not improved after replacing the ink cartridges, contact your dealer.

Aligning the Print Head

If you notice a misalignment of vertical lines, you may be able to solve this problem from your computer using the Print Head Alignment utility in your printer software.

Note:

Do not start the Print Head Alignment utility while printing is in progress; otherwise your printout may be marred.

For Windows users

1. Make sure paper is loaded in the sheet feeder.



Caution:

Use paper at least 210 mm (8.27 inches) wide; for example, A4 size paper loaded short edge first. Otherwise, the print head will spray ink directly onto the platen.

2. Access the printer software window. If you need instructions, see "Accessing the printer software" on page 49.
3. Click the Utility tab, then click the Print Head Alignment button.
4. Follow the messages on your screen to align the print head.

For Macintosh users



Caution:

- Never use alcohols or thinners to clean the printer; these chemicals can damage the components as well as the case.
- Be careful not to get water on the printer mechanism or electronic components.
- Do not use a hard or abrasive brush.
- Do not spray the inside of the printer with lubricants; unsuitable oils can damage the mechanism. Contact your dealer or a qualified service person if lubrication is needed.

Transporting the Printer

If you need to transport your printer some distance, carefully repack it using the original box and packing materials as follows:

1. Open the printer cover and make sure that the print head is in the home (far right) position. If not turn on the printer and wait until the print head returns to the home position. Turn off the printer and then close the printer cover.



Caution:

Leave the ink cartridges installed when you transport the printer. Removing the cartridges during transport can damage the printer.

2. Unplug the power cord from the electrical outlet; then disconnect the interface cable from the printer.
3. Remove the paper from the sheet feeder and remove the paper support.
4. Push in the output extension tray, and then raise the output tray.
5. Attach the protective materials to the printer.



Problem Solver



Diagnosing the Problem

Troubleshooting printer problems is best handled in two easy steps: first diagnose the problem, then apply likely solutions until the problem is fixed.

The information that you need to diagnose the most common problems is provided by the printer's control panel lights and by the Status Monitor utility. You can also print an operation check page to determine whether the problem comes from the printer or the computer.

Error indicators

You can identify many common printer problems with the lights on your printer's control panel. If your printer stops working and the lights are on or flashing, use the following table of panel light patterns to diagnose the problem, then follow the recommended corrective measures.

Lights	Problem and Solution	
	Paper Out	
	No paper is loaded in the printer.	Load paper in the sheet feeder; then press the  load/eject button to turn this light off. The printer resumes printing.
	The paper is not loaded correctly.	Remove and reload the paper; then press the  load/eject button to turn this light off.



<ul style="list-style-type: none"> ■ ■ ■ ■ 	Carriage Error	
	<p>The print head carriage is caught by jammed paper or other foreign material and cannot return to the home position.</p>	<p>Turn off the printer. After a few seconds, turn it on again. The printer will eject any jammed paper.</p> <p>If the paper is not ejected, turn off the printer. Open the printer cover and remove any paper from the paper path by hand.</p> <p>If the error is not cleared, contact your dealer.</p>
<ul style="list-style-type: none"> ■ ■ ■ ■ 	Unknown Printer Error	
	<p>An unknown printer error has occurred.</p>	<p>Turn off the printer, and after a few seconds, turn it on again. If the error is not cleared, contact your dealer.</p>

Status Monitor 2

For Windows, you can check the printer's current status with the Status Monitor 2. This utility's Printer Status window provides status messages and a graphic display showing the current state of the printer. The graphic display can depict the following conditions:

	<p>Ready to print.</p>
--	------------------------

2. Disconnect the cable from the printer's interface connector.



If you use the parallel interface, first, unlock the wire clips on both sides of the interface connector and remove the ground connector, if necessary. Then disconnect the cable from the printer's interface connector.

3. Load paper into the sheet feeder.



Caution:





Use paper at least 210 mm (8.27 inches) wide; for example, A4 size paper loaded short edge first. Otherwise, the print head will spray ink directly onto the platen during the operation check and smear any documents you print afterwards.

4. Hold down the  load/eject button and press the  power button to turn on the printer. Then release both buttons.



Print Quality Could Be Better

Click the caption under the illustration that best resembles your printout.

 <p>ÒHorizontal bandingÓ on page 161</p>	 <p>ÒVertical misalignment or bandingÓ on page 162</p>
 <p>ÒIncorrect or missing colorsÓ on page 162</p>	 <p>ÒFaint printout or gapsÓ on page 163</p>
 <p>ÒBlurry or smeared printoutÓ on page 164</p>	

If you are having print quality problems, try the solutions offered here.

Horizontal banding



Try one or more of these solutions:

- Select Automatic mode in your printer driver. If you are using Windows 95 or 98, you can activate "<As_auto.htm>Automatic Mode" now.
- Make sure the printable side of the paper is face up in the sheet feeder.

- Make sure the printable side of the paper is face up in the sheet feeder.
- Run the Head Cleaning utility. Windows 95 and Windows 98 users can start the "<As_head.htm>Head Cleaning Utility" now. If colors are still incorrect or missing, replace the color ink cartridge. If the problems persists, replace the black ink cartridge. See "Replacing an Old or Damaged Ink Cartridge" on page 135.
- Adjust the color settings in your application software or your printer driver. For instructions, see "Using the Advanced settings" on page 56 for Windows or "Using the Advanced settings" on page 78 for Macintosh.

Faint printout or gaps

Try one or more of these solutions:

- Run the Head Cleaning utility to clear any clogged ink nozzles. For Windows 95 and Windows 98, you can start the "<As_head.htm>Head Cleaning Utility" now.
- Select Automatic mode in your printer driver. For Windows 95 and Windows 98, you can activate "<As_auto.htm>Automatic Mode" now.
- Make sure your paper is not damaged, dirty, or too old.
- Check the  and  ink out lights. If a light is flashing, replace the ink cartridge. See "Replacing an Empty Ink Cartridge" on page 128.

Blurry or smeared printout

Try one or more of these solutions:

- Set the adjust lever to the "+" position, and make sure the Media Type setting is set correctly in your printer driver.

Printer Doesn't Print

If one of the following problems has occurred, try the solutions listed for the problem.

All lights are off

- Press the  power button and make sure the printer is on.
- Turn off the printer and make sure the power cord is plugged in securely.
- Make sure your outlet works and is not controlled by a wall switch or timer.

Lights came on and then went out

The printer's voltage may not match the outlet rating. Turn off the printer and unplug it immediately. Then, check the printer labels.

If the voltage doesn't match, **DO NOT PLUG YOUR PRINTER BACK IN**. Contact EPSON. See "Where to Get Help" on page 173.

Only the power light is on

Try one or more of these solutions:

- Turn off the printer and computer. Make sure the printer's interface cable is plugged in securely.
- Make sure there's no packing material in the printer.
- Turn off the printer and computer and disconnect the printer's interface cable. Then print a operation check page. See "Running a printer operation check" on page 158.
- If the check page prints, make sure the printer software and your application software is installed correctly.

All lights are flashing

Follow these steps:

1. Remove any paper in the printer.
2. Turn the printer off, wait a few seconds, and then turn it on again.
3. If the lights still flash, turn the printer off and check the inside of the printer for any foreign objects or pieces the paper. Remove all foreign objects and paper, then turn on the printer again.
4. If the lights still flash, contact EPSON. See "Where to Get Help" on page 173.

Paper Doesn't Feed Correctly

If one of the following problems has occurred, try the solutions listed for the problem.

Paper doesn't feed

Remove the stack of paper and check that:

- The paper isn't curled or creased.
- The paper isn't too old. See the instructions that came with the paper for more information.
- Paper isn't loaded above the arrow on the left edge guide.
- The paper isn't jammed inside. If it is, remove the jammed paper.

1. If the paper doesn't eject fully, press the  load/eject button. Also check the paper size setting in your application or printer driver.
2. If the paper is wrinkled when it comes out, it may be damp or too thin. Load a new stack.

Note:

Store any unused paper in its original packaging in a dry area. See "Paper" on page 197 for specifications.

Printouts Are Not What You Expected

If one of the following problems has occurred, try the solutions listed for the problem.

Incorrect or garbled characters

Try one or more of these solutions:

- Select your printer as the default printer in Windows. For Windows 95 and Windows 98, you can activate the "<As_defa.htm>default printer" on page 16 setting now.
- Clear any stalled print jobs from the Spool Manager. Windows 95 and Windows 98 users can "<As_jobs.htm>Clear all print jobs" on page 17 now.
- Turn off the printer and computer. Make sure the printer's interface cable is plugged in securely.
- If you are using Windows NT 4.0, try to uninstall the EPSON Printer Port. Click Start, point to Programs, then point to EPSON Printers, and point to EPSON Printer Port Uninstall. Follow the messages on the screen.



- Run the Head Cleaning utility to clear any clogged nozzles. For Windows 95 and Windows 98, you can start the "<As_head.htm>Head Cleaning Utility" now.

After trying one or more of these solutions, run a printer operation check to check your results. See "Running a printer operation check" on page 158.

Printout has smears on the bottom edge

Try one or more of these solutions:

- If the paper is curled toward the printable side, flatten it or curl it slightly toward the opposite side.
- Set the adjust lever to the "+" position.

Printing is too slow

Try one or more of these solutions:

- To increase speed, select Automatic mode and then set the slide bar to the Speed setting. For instructions, see "Using the Automatic setting" on page 53 for Windows or "Using the Automatic setting" on page 76 for Macintosh.
- Don't run too many applications at the same time. Close any applications you are not using at the moment.
- Delete unnecessary files to make room on your hard disk drive.

Note:

Your computer may not have enough memory. For further tips, See "Increasing the Print Speed" on page 62.

Proof Sign-off:
K. Nishi
N.Nomoto
K.Norum

Seychelles
html.bk

A5 size
7/10/98

Pre-Rev. A

TRBLE.FM
Pass 2

R

- "For United Kingdom and the Republic of Ireland Users" on page 174
- "For Australian Users" on page 176
- "For Singapore Users" on page 178
- "For Hong Kong Users" on page 178
- "For Philippines Users" on page 179

For United Kingdom and the Republic of Ireland Users

If you purchased your printer in the UK or the Republic of Ireland, EPSON (UK) Limited provides a range of customer services and technical support.

World Wide Web

If you can connect to the Internet and have a Web browser, you can access our Web site at <http://www.epson.co.uk>. Here you will find information on the latest EPSON products, software drivers, on-line user guides, and answers to frequently asked questions.

Faxon EPSON

Contact Faxon EPSON Faxback Service for support information including troubleshooting tips, switch settings, and driver information.

To use Faxon EPSON, call 01442 227332 in the UK or 0044 1442 227332 from the Republic of Ireland using a touch-tone phone. You will be asked to follow a simple routine to register your document request. Once you have entered your telephone and fax numbers, Faxon EPSON will fax a copy of the document catalogue to your fax machine.

Pre Sales Enquiry Desk

The Enquiry Desk team can be contacted by calling 0800 220546 in the UK or 1 800 409132 from the Republic of Ireland, by faxing 01442 227271 in the UK or 0044 1442 227271 from the Republic of Ireland, and via Email at info@epson.co.uk. They can provide the following information:

- Pre Sales information and literature on new EPSON products (also available via our world wide web site at <http://www.epson.co.uk>)
- Where to purchase genuine EPSON consumables, accessories, and options

For Australian Users

EPSON Australia wishes to provide you with a high level of Customer Service. As well as the user's guide, we provide the following sources for obtaining information:

EPSON FAXBACK

EPSON FAXBACK will fax you the latest specifications and pricing for most EPSON products offered in Australia. There is also technical information including details of the latest software and drivers available. Phone (02) 9903 9075 and the system will guide you through a number of choices before faxing the information to your fax machine.

EPSON Bulletin Board System

This is where you can download the latest software and drivers. Visit the BBS to check out the latest versions. If you have a modem, phone (02) 9417 5090.

Proof Sign-off:
K. Nishi _____
N. Nomoto _____
K. Norum _____

Seychelles

html.bk

A5 size
7/10/98

Pre-Rev. A

TRBLE.FM
Pass 2

R

For Singapore Users

Contact the telephone and fax numbers below:

Phone (065) 337-7911

Fax (065) 334-1185

For Hong Kong Users

To obtain technical support as well as other after-sales services, users are welcome to contact EPSON Hong Kong Limited.

Internet home page

EPSON Hong Kong has established a local home page in both Chinese and English on the Internet to provide users with the following information:

- Product information
- Answers to Frequently Asked Questions (FAQs)
- Latest versions of EPSON printer drivers

Users can access our World Wide Web home page at:
<http://www.epson.com.hk>

Electronic bulletin board system

An electronic bulletin board system (BBS) is also available to obtain printer information and the latest versions of printer drivers. You can log on to the following number for the BBS service:

BBS (852) 2827-4244

Proof Sign-off:
E. Ohtera K. Nishi _____
N. Nomoto _____
K. Norum _____

USB Guide

Rev. 6A

A5 size
7/10/98

Usb.fm
Pass 0

R

USB User's Guide

If you connect your EPSON printer to your computer using a shielded USB cable, see this guide.

Connecting the USB Cable

Note:

Install the ink cartridges before connecting the cable. See your printer manual.

Note for Window 98:

Before connecting a shielded USB cable, make sure that the Universal Serial Bus Controller is working properly on the Device Manager of Windows 98. For details, see your computer manual.

1. Turn off your printer, if necessary.
2. Plug one end of a shielded USB cable to the USB connector on the back of the printer.
3. Plug the other end into the computer's USB connector.

Note:

If you use a USB hub, EPSON recommends you to connect the printer to the first tier of the hub, otherwise the printer may malfunction. If the printer does not work properly with the USB hub, please connect the printer to the computer's USB port directly.

Note for Windows 98:

After connecting the printer to your computer, you must install the EPSON USB Printer Device Driver and the printer software.

Note for iMac:

After connecting the printer to your computer, you must install the printer software.



- When the following dialog box appears, click Specify a location and type D:\win98 (if the CD-ROM drive has a drive letter other than "D", substitute the appropriate letter). Then click Next.

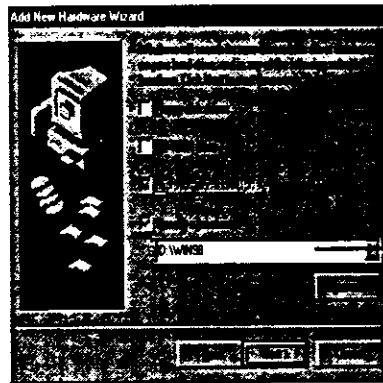

- After finishing the USB printer device driver installation, printer software installation automatically starts and the following dialog boxes appear. Click Finish, then click Next.

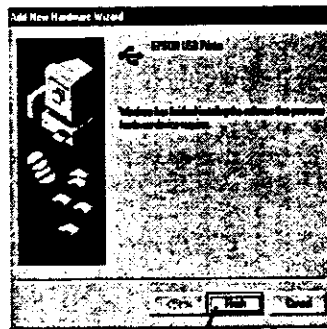

Click here.

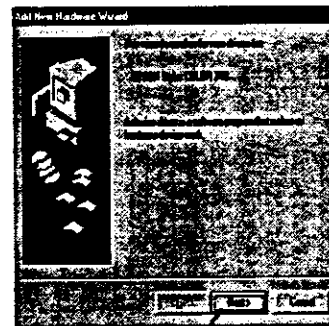

Then click here.

For iMac

After connecting the printer to your Macintosh, you are ready to install the printer software included in the "Printer Software for EPSON Stylus Photo 750" CD-ROM shipped with your printer. For how to install the printer software, see "Installing the Printer Software in Your Macintosh" in the Setup & Daily Use Guide. Then select your printer in the Chooser as follows:

To use the USB port, you need to open the Chooser to select your printer. You have to choose the printer the first time you use it or whenever you want to switch to another printer. Your Macintosh will always print using the last printer selected.

1. Make sure the printer is connected to your Macintosh and is turned on.
2. Choose Chooser from the Apple menu. Then click your printer's icon and the USB port.
3. Click Background Printing radio buttons to turn background print on or off.
4. When background printing is on, you can use your Macintosh while it is preparing a document for printing. You must turn on background printing to use the EPSON Monitor3 utility to manage print jobs.
5. Close the Chooser.

Proof Sign-off:

E. Ohtera

N. Nomoto

K. Norum

USB Guide
Rev. C

A5 size
7/10/98

Usb.fm
Pass 0

R

Troubleshooting

This section helps you solve problems that may occur when using the printer connected with a USB cable.

Cannot install the USB Printer Device Driver (for Windows 98)

Try one or more of these solutions:

- Make sure your computer is a Windows 98 pre-installed model (see "System Requirements" on page 2).
- Make sure that the Universal Serial Bus Controller is working properly in the Device Manager. For details, see your computer manual. If it is not working properly, contact your computer dealer.

Printer does not work correctly

Try one or more of these solutions:

- Use the recommended USB cable as described in "System Requirements" on page 2.
- If you use a USB hub, connect the printer to the first tier of the hub, or connect the printer to the computer's USB port directly.
- Try reinstalling the USB Printer Device Driver and the printer software. First, uninstall the EPSON Printer Software using Add/Remove Programs in Windows 98, then uninstall the EPSON USB Printer Devices. Next, re-install the software as described in "For Windows 98" on page 4.

- When the dialog box below appears, click Next and follow the instructions on the screen.

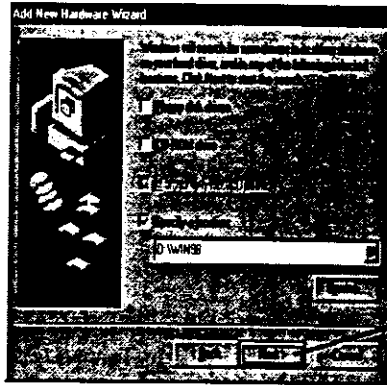

- To confirm that installation was successful, check to see if "EPSON USB Printer Devices" appears in the Device Manager. Click Start, point to Settings, and click Control Panel. Then double-click System and click the Device Manager tab.

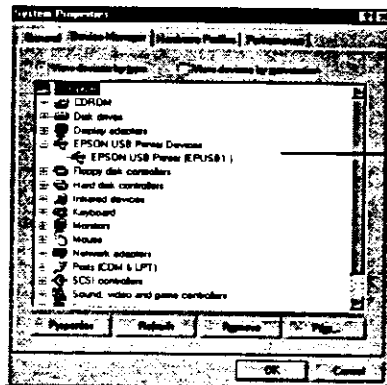

Now you can use your printer. For instructions on using your printer, see your printer manual.

For Windows 98

The USB Printer Device Driver is included in the Printer Software CD-ROM shipped with your printer.

The installation program for the USB Printer Device Driver also allows you to install the printer software. You do not need to install the printer software separately.

1. Make sure Windows 98 is running.
2. Turn on your printer. The following dialog box appears.



3. Follow the instructions on the screen.

System Requirements

To use your printer through the printer's built-in USB port, you need the following:

- Microsoft® Windows 98® pre-installed PC equipped with a USB port (for Windows 98)
- iMac computer (for iMac)
- USB Interface Cable (shielded) C83623* from Series A 4-pin (computer) to Series B 4-pin (printer)

**Caution:**

Using other cables not covered by EPSON warranties (especially cables more than 1.8 meters long) may cause the printer to malfunction.

Note:

- The asterisk (*) is a substitute for the last digit of the product number, which varies by country.*
- Depending on the country, this cable may not be available.*
- 10MB hard disk space to install the USB Printer Device Driver and the printer software (for Windows 98)
- ??MB hard disk space to install the printer software (for iMac)

L

Seychelles

html.bk

A5 size
7/10/98

Pre-Rev. A

TRBLE.FM
Pass 2

Proof Sign-off:

K. Nishi

N.Nomoto

K.Norum

Technical Support Hotline

You can also contact our technical staff at the following telephone and fax numbers:

Phone (852) 2585-4399

Fax (852) 2827-4383

For Philippines Users

To obtain technical support as well as other after sales services, users are welcome to contact the EPSON Philippines Representative Office at the telephone and fax numbers below:

Phone (632) 813-6552

Fax (632) 813-6545

BBS (632) 814-0595

L**Seychelles****html.bk**A5 size
7/10/98**Pre-Rev. A**TRBLE.FM
Pass 2

Proof Sign-off:

K. Nishi
N.Nomoto
K.Norum_____

Internet URL <http://www.epson.com.au>

Access the EPSON Australia World Wide Web pages. Worth taking your modem here for the occasional surf! You can get the same information as offered on the EPSON FAXBACK and the EPSON Bulletin Board plus more.

Your dealer

Don't forget that your dealer can often help identify and resolve problems. The dealer should always be the first call for advice on problems. They can often solve problems quickly and easily as well as give you advice on the next step to take.

EPSON Helpdesk

EPSON Helpdesk is provided as a final backup to make sure our clients have access to advice. Operators on the Helpdesk can aid you in diagnosing hardware and software problems. They can also advise you on the latest EPSON products and where the nearest dealer or service agent is located. Many types of queries are answered here.

The Helpdesk numbers are:

Phone (02) 9903 9040

Fax (02) 9903 9189

We encourage you to have all the relevant information on hand when you ring. The more information you prepare, the faster we can help solve the problem. This information includes the *User's Guide* for your EPSON product, type of computer, operating system, application programs, and any other information you feel is required.

L

Seychelles

html.bk

A5 size
7/10/98

Pre-Rev. A

TRBLE.FM
Pass 2

Proof Sign-off:

K. Nishi

N.Nomoto

K.Norum

When you have found the documents that you need in the catalogue, call Faxon EPSON again and enter the document ID numbers. The documents will be faxed to you automatically.

Bulletin Board Service for latest drivers and utilities

You can call the EPSON Bulletin Board Service on 01442 227479 in the UK or 0044 1442 227479 from the Republic of Ireland. No membership is required. Make sure that your communications software is set to 8 data bits, 1 stop bit, no parity bit, ANSI terminal mode emulation, and a modem speed of up to 28.8 Kbps. Downloading protocols supported include Xmodem, Ymodem and Zmodem. See the documentation that came with your communications software and modem for more information.

When you first connect to the Bulletin Board Service, you will be asked for your name, company name, phone number and a password (which you can invent yourself).

Customer and Warranty Support

Our Customer and Warranty Support teams can be contacted by calling 0870 163 7766 in the UK or 0044 0870 163 7766 from the Republic of Ireland. They can provide the following services:

- Technical information on installing, configuring, and operating your EPSON products
- Arranging for faulty EPSON products to be repaired within the warranty period

A full list of EPSON Customer and Warranty Support services is available on the technical support section of our world wide web pages at <http://www.epson.co.uk/support/> and on Faxon EPSON Faxback service in document number 5085.

- If you upgraded from Windows 95 to Windows 98, uninstall the printer software using Add/Remove Programs in Windows, then install the software again.

Updating to Windows 98

If you upgraded from Windows 95 to Windows 98, uninstall the printer software using the Add/Remove Programs icon in the Windows Control Panel, then install the printer software again.

Where to Get Help

If your printer is not operating properly and you cannot solve the problem using the troubleshooting information in your printer documentation, contact customer support services for assistance.

We will be able to help you much more quickly if you give us the following information:

Serial number of your printer

(The serial number label is on the back of the printer.)

Printer model

Brand and model of your computer

Printer software version

(Click About in your printer driver.)

Windows version you are using

Software application(s) you normally use with your printer and their version number(s)

Select your country:

Incorrect margins

Try one or more of these solutions:

- Check the margin settings in your application software.
- Make sure the margins are within the printable area of the page. See "Paper" on page 197 for specifications.
- For Windows, check the settings in the Paper dialog box. Make sure they're correct for the paper size you're using.

For Macintosh, check the settings in the Page Setup dialog box. Make sure they're correct for the paper size you're using.

Inverted image

Turn off the Flip Horizontal setting in the printer driver, or the "Mirror" setting in your application software. For instructions, see online help for the printer driver or for your application.

For Macintosh, see also "Using the Advanced settings" on page 78.

Blank pages print

Try one or more of these solutions:

- Select your printer as the default printer in Windows. For Windows 95 and Windows 98, you can activate the "<As_defa.htm>default printer" on page 16 setting now.
- For Windows, check the settings in the Paper dialog box. Make sure they're correct for the paper size you're using.

For Macintosh, check the settings in the Page Setup dialog box. Make sure they're correct for the paper size you're using.

Then load paper again. Make sure you follow any special loading instructions that came with your paper. See also "Printing on Special Paper" on page 89.

Multiple pages feed

Remove the stack of paper and:

- Make sure the paper is not too thin. See "Paper" on page 197 for specifications.
- Fan the edges of the stack to separate the sheets, then reload the paper.

If too many copies of a document are printing, check the Copies settings in both the printer driver and your application. For instructions, see "Modifying the printout style" on page 58 for Windows or "Modifying the layout" on page 83 for Macintosh.

The paper jams

Turn off your printer, open the cover, and remove all the paper from inside, including any torn pieces. Then load paper again.

If your paper jams frequently, make sure you:

- Use smooth, high-quality paper, loaded with the printable side up.
- Fan the stack before loading it.
- Don't load paper above the arrow mark on the left edge guide.
- Adjust the left edge guide to fit your paper.

Paper isn't ejected fully or is wrinkled

Try one or more of these solutions:

Note:





If you're trying to print a large image, your computer may not have enough memory to print.

- If you are using Windows NT 4.0, try to uninstall the EPSON Printer Port. Click Start, point to Programs and EPSON Printers, then click EPSON Printer Port Uninstall. Follow the messages on the screen.
- Clear any stalled print jobs from the Spool Manager. For Windows 95 and Windows 98, you can "<As_jobs.htm>Clear all print jobs" now.
- If the printer sounds like it's trying to print, but can't, run the Head Cleaning utility. For Windows 95 and Windows 98, you can start the "<As_head.htm>Head Cleaning Utility" now.
- If the above doesn't work, replace the ink cartridges. See "Replacing Ink Cartridges" on page 127 for instructions.



Paper out light is flashing or on

- If the paper out light is flashing, remove any paper that may be jammed in the printer.
- If the paper out light is on, load more paper in the sheet feeder.

One of the ink out lights is flashing or on

- If the  or  ink out light is flashing, ink is low. Prepare a replacement cartridge.
- If the  or  light is on, ink is out. Replace the corresponding cartridge. See "Replacing an Empty Ink Cartridge" on page 128.

- If the paper is curled toward the printable side, flatten it or curl it slightly toward the opposite side.
 - Make sure your paper is dry and the printable side is face up. Also, make sure you're using a correct paper type. See "Paper" on page 197 for specifications.
 - Select Automatic mode in your printer driver. For Windows 95 and Windows 98, you can activate "<As_auto.htm>Automatic Mode" now.
 - Remove each sheet from the output tray as it's printed, especially if you're using transparencies.
 - If you're printing on glossy media or transparencies, place a support sheet (or a sheet of plain paper) beneath the stack. Or load one sheet at a time.
 - Ink may have leaked inside the printer; wipe the inside of the printer with a soft, clean cloth.
-
-
- Run the Head Cleaning utility. For Windows 95 and Windows 98, you can start the "<As_head.htm>Head Cleaning Utility" now.
 - Run the Print Head Alignment utility. For Windows 95 and Windows 98, you can start the "<As_alig.htm>Print Head Alignment Utility" now.

- Run the Head Cleaning utility to clear any clogged ink nozzles. If you are using Windows 95 or 98, you can start the "<As_head.htm>Head Cleaning Utility" now.
- Check the  and  ink out lights. If a light is flashing, replace the ink cartridge. See "Replacing an Empty Ink Cartridge" on page 128.
- Make sure the Maximum Printable Area setting in your printer driver is turned off. When this setting is on, banding may occur in the expanded area.

Vertical misalignment or banding

Try one or more of these solutions:

- Run the Head Cleaning utility to clear any clogged ink nozzles. For Windows 95 or 98, you can start the "<As_head.htm>Head Cleaning Utility" now.
- Turn off the High Speed setting in your printer driver. For instructions, see the printer driver's online help for Windows. For Macintosh, see "Using the Advanced settings" on page 78.
- Run the Print Head Alignment utility. For Windows 95 or 98, you can start the "<As_alig.htm>Print Head Alignment Utility" now.

Incorrect or missing colors

Try one or more of these solutions:

- Change the ink setting in your printer driver to Color. For instructions, see "Using the Automatic setting" on page 53 for Windows or "Using the Automatic setting" on page 76 for Macintosh.
- Select Automatic mode in your printer driver. For Windows 95 or 98, you can activate "<As_auto.htm>Automatic Mode" now.





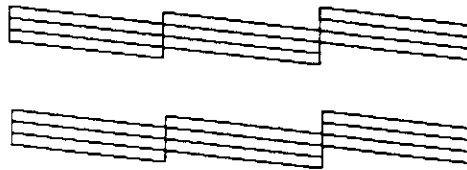

The printer prints an operation check page including the version of your printer's ROM, the ink counter code, and a nozzle check pattern. Here is a typical printout:

W01283 I02382 0AD6



イラスト修正
予定

5. Press the  power button to turn off the printer after it finishes printing the operation check page.
 - Compare the quality of the printed check page with the sample shown above. If there are no print quality problems, such as gaps or missing segments in the test lines, the printer itself is all right and the problem probably lies in the printer software settings, application settings, the interface cable (be sure to use a shielded cable), or the computer itself.
 - If the check page does not print satisfactorily, there is a problem with the printer. For example, if any segment of the printed lines is missing, this could be a clogged ink nozzle or a misaligned print head.

	Paper is not loaded correctly.
	Paper is jammed.
	Black ink is out.
	Color ink is out.
	A communication error has occurred.
	Other error has occurred.









When ink is out, click the Replace Ink Cartridge button in the Printer Status window and the Status Monitor will lead you step-by-step through the cartridge replacement procedure.

Running a printer operation check

Performing a printer operation check can help you determine whether the problem comes from the printer or the computer.

To print a printer operation check page, follow these steps:

1. Make sure both the printer and computer are turned off.

<ul style="list-style-type: none"> ■  ■  ■  	Paper Jam	
	<p>Paper has jammed in the printer.</p>	<p>Take all the paper out of the feeder, and reload the paper; then press the  load/eject button to turn this light off. If the light continues to flash, turn off the printer and gently pull all the paper out of the printer. If it tears and pieces remain inside the printer, open the printer cover and remove the pieces of paper. Turn on the printer and try again.</p>
<ul style="list-style-type: none"> ■  	Ink Low (black ink cartridge)	
	<p>The black ink cartridge is nearly empty.</p>	<p>Obtain a replacement black ink cartridge (S020187).</p>
<ul style="list-style-type: none"> ■  	Ink Out (black ink cartridge)	
	<p>The black ink cartridge is empty.</p>	<p>Replace the black ink cartridge with a new one (S020187). See "Replacing an Empty Ink Cartridge" on page 128 for details.</p>
<ul style="list-style-type: none"> ■  	Ink Low (color ink cartridge)	
	<p>The color ink cartridge is nearly empty.</p>	<p>Obtain a replacement color ink cartridge (S020193).</p>
<ul style="list-style-type: none"> ■  	Ink Out (color ink cartridge)	
	<p>The color ink cartridge is empty.</p>	<p>Replace the color ink cartridge with a new one (S020193). See "Replacing an Empty Ink Cartridge" on page 128 for details.</p>

L

Seychelles

html.bk

A5 size
7/10/98

Pre-Rev. A



MAINT.FM
Pass 2

Proof Sign-off:



K. Nishi
N.Nomoto
K.Norum

6. Repack the printer and power cord in the original box.
7. Keep the printer level during transport.

Using the control panel buttons

1. Make sure that the  power light is on and that both the  and  ink out lights are off.

Note:

If the  or  ink out light is flashing or on, you cannot clean the head, and this operation will start the ink cartridge replacement procedure. If you do not want to replace an ink cartridge at this moment, press the  cleaning button to return the print head to its home position.

2. Hold down the  cleaning button for three seconds.

The printer starts cleaning the print head and the  power light begins flashing. Print head cleaning takes about one minute to complete.



Caution:

Never turn off the printer while the  power light is flashing. Doing so may damage the printer.

3. When the  power light stops flashing, print a few lines from a document to confirm that the head is clean and to reset the cleaning cycle.

4. Follow the messages on your screen.

The  power light flashes while the printer performs the cleaning cycle. It takes about one minute to complete.



Caution:

Never turn off the printer while the  power light is flashing. Doing so may damage the printer.

5. When the  power light stops flashing, click Print nozzle check pattern in the Head Cleaning dialog box, or print a few lines from a document, to confirm that the head is clean and to reset the cleaning cycle.

Nozzle check pattern:

Good sample

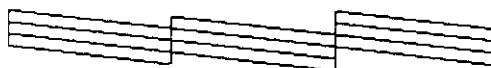
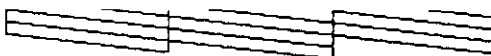

W01283 I02382 OAD6

イラスト修正
済

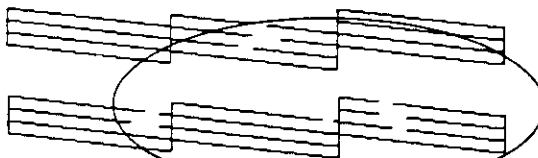

Print head needs to be cleaned



W01283 I02382 OAD6

In the check pattern, if you find that any segments are missing from the test lines, you may need to repeat the head cleaning and print the nozzle check pattern again.

Using the control panel buttons

1. Hold down the  load/eject button and press the  power button to turn on the printer. Then release both buttons.

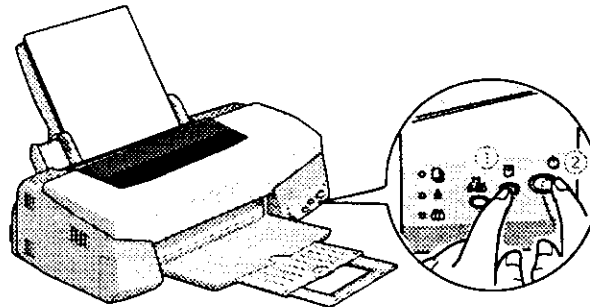

The printer prints an operation check page including your printer's ROM version information, the ink counter code, and a nozzle check pattern. Here is a typical printout:

W01283 I02382 0AD6

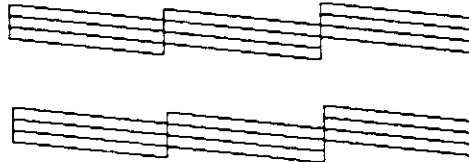

1324修正
修正

2. Press the  power button to turn off the printer after it finishes printing the nozzle check pattern.

If the nozzle check page does not print satisfactorily, for example, if any segment of the printed lines is missing, there is a problem with the printer. This could be a clogged ink nozzle or a misaligned print head. See "Cleaning the Print Head" on page 142 for details on cleaning the print head. For information on aligning the print head, see "Aligning the Print Head".

L

Seychelles

html.bk

A5 size
7/10/98

Pre-Rev. A



INK.FM
Pass 2

Proof Sign-off:

K. Nishi
N.Nomoto
K.Norum



Caution:



The  power light continues to flash while the printer performs the ink charging operation. Never turn off the printer while the  power light is flashing. Doing so can result in incomplete charging of ink.



When an ink cartridge is low or empty, click the Replace Ink Cartridge button in the Status Monitor's Printer Status window and follow the on-screen instructions. If you are using Windows 95 or 98, the print head will also move to the ink cartridge replacement position.

For more information on installing and using the Status Monitor, see "Using EPSON Status Monitor 2" on page 103.

Replacing an Old or Damaged Ink Cartridge

In some circumstances you may need to replace an ink cartridge before it is empty. For example, if the quality of your printouts remains poor even after repeatedly cleaning and aligning the print head, one or both of the ink cartridges may be old or damaged and should be replaced.

To replace an ink cartridge before the  or  ink out light flashes, follow these steps.

If the  or  ink out light is flashing or is on, replace the empty ink cartridge as described in "Replacing an Empty Ink Cartridge" on page 128.



Caution:

- Once you remove an ink cartridge, it becomes unusable and cannot be reinstalled even if ink remains.
 - Leave the old cartridge installed in the printer until you are ready to replace it with a new one.
1. Make sure the printer is on. The  power light should be on, but not flashing.
 2. Lower the output tray; then open the printer cover.

5. Remove the ink cartridge from its protective bag. Next, remove only the yellow tape seal from the cartridge.

**Caution:**

- You must remove the yellow tape seal from the cartridge. Leaving the tape on when you install the cartridge will permanently damage it.
 - Do not remove the blue portion of the tape seal from the top of the cartridge; otherwise, the cartridge may become clogged and cannot print.
 - Do not remove the tape seal from the bottom of the cartridge; otherwise, ink will leak.
6. Place the ink cartridge gently into the cartridge holder with the label on the cartridge face up. Then press the ink cartridge clamp down until it locks in place. Do not press down on the cartridge itself.





**Caution:**

- EPSON recommends the use of genuine EPSON ink cartridges. Other products not manufactured by EPSON may cause damage to your printer not covered by EPSON's warranties.
- Leave the old cartridge installed in the printer until you have obtained a replacement. Otherwise, ink remaining in the print head nozzles may dry out.

Note:

If the ink runs out, you cannot continue printing until you replace the empty cartridge, even though the other ink cartridge still contains ink.

To replace an ink cartridge using the printer's control panel, follow these steps.

1. Make sure the printer is on. The  power light should be on, but not flashing. (Determine which cartridge needs to be replaced as indicated by the  black and  color ink out light.)
2. Lower the output tray at the front of the printer, then open the printer cover.
3. Hold down the  cleaning button for three seconds until the print head moves left slightly to the cartridge replacement position and the  power light begins flashing.

L

Seychelles

html.bk

A5 size
7/10/98

Pre-Rev. A

NETWRK.FM
Pass 2

Proof Sign-off:

K. Nishi

N.Nomoto

K.Norum

3. Click Shared and enter the Share Name.

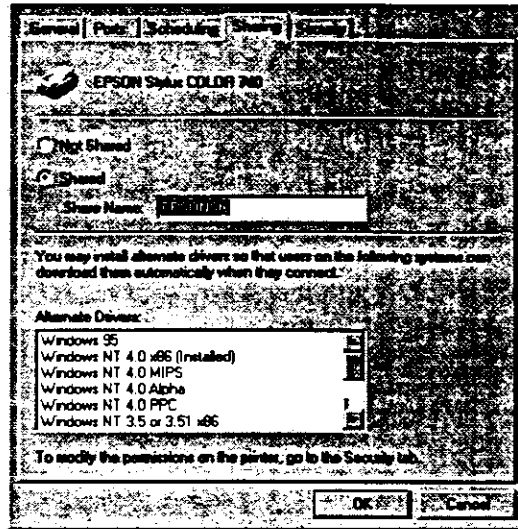

Accessing the printer through a network

To access your printer from another computer on a network, you need to install the printer software in the computer you want to print from, then set the network path to the printer. Follow these steps.

Note:

Your printer must be set up as a shared resource on the computer to which it is directly connected before you can access it from another computer. For instructions, see "Setting up your printer as a shared printer".

1. Install the printer software in the computer you want to print from. For instructions, see "Installing the Printer Software in Your PC" in the *Setup & Daily Use* guide.
2. Click Start, point to Settings, and click Printers.
3. Double-click the Add Printer icon.

6. Click Browse.

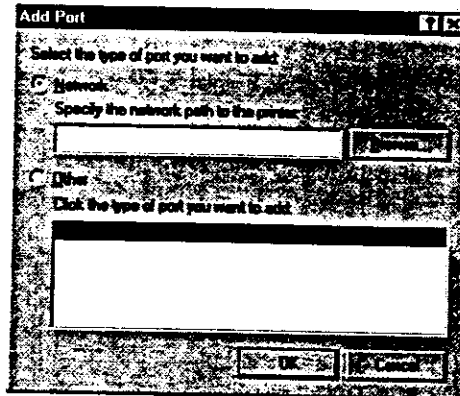

7. Double-click the icon of the computer that is directly connected to the printer. Then click the printer's icon.

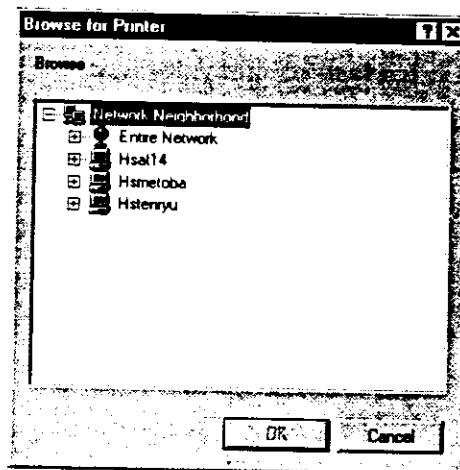

8. Click OK and follow the messages on the screen.

6. In Control Panel, double click Printers.
7. Select your printer, and choose Sharing from the File menu.
8. Click Shared As, enter printer information as needed, then click OK.

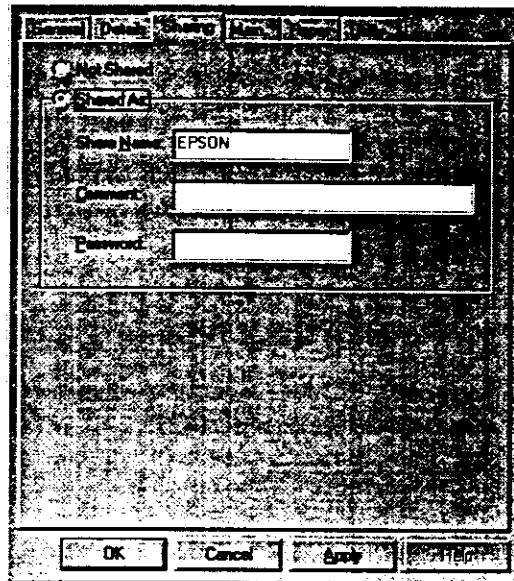

Accessing the printer through a network

To access your printer from another computer on a network, you need to install the printer software in the computer you want to print from, then set the network path to the printer. Follow these steps.

Note:

Your printer must be set up as a shared resource on the computer to which it is directly connected before you can access it from another computer. For instructions, see "Setting up your printer as a shared printer".

L

Seychelles

html.bk

A5 size
7/10/98

Pre-Rev. A

STATSW.FM
Pass 2

Proof Sign-off:

K. Nishi

N.Nomoto

K.Norum

2. Select the printer you want to monitor from the Installed Printers list, and then click Monitoring Preferences on the Settings menu. The dialog box below appears.

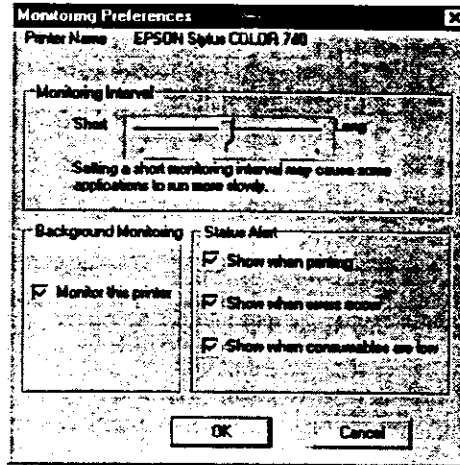

You can make the following settings:

- Monitoring Interval
You can adjust the monitoring interval by dragging the slider.

Note:

Setting a short monitoring interval may slow down some applications.

- Background Monitoring
If turned on, the Status Alert dialog box automatically appears to inform you of the printer status while you are using some application programs. Use the Status Alert options to select when you want the Alert dialog box to appear.
- Status Alert
You can specify when you want the Status Alert dialog box to appear.

- You can rearrange the order of the printers in the list. Click the Printer Name, Status, or Job Count title bar to change the order of the printers.
- You can control the contents of the Status Monitor 2 window using the View menu. See the Status Monitor's online help.

Printer Status window

To get more detailed information, you can access the Printer Status window by double-clicking the printer name, by selecting the printer and then choosing Printer Status on the Printer menu, or by selecting the printer and then clicking the Printer Status button on the tool bar.

If you access the Printer Status window as described above, the following window appears:

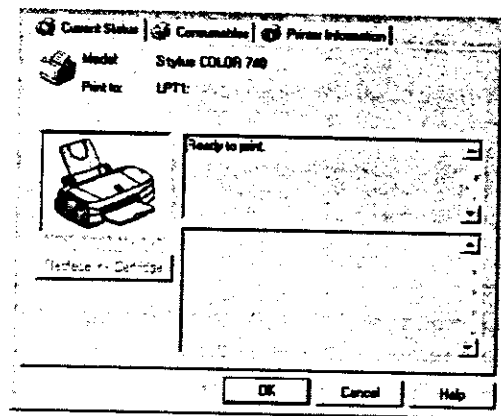

Note:

You can also access the Printer Status window from the Status Alert dialog box or the EPSON Status Monitor 2 utility. See "Making monitoring settings" for information on the Status Alert dialog box.

You can open the three menus described below by clicking the tabs at the top of the Printer Status window:

Note:

If the dialog box below appears, and if your EPSON Stylus ^{PHOTO}~~COLOR~~ 750 is connected directly to your computer, select Monitor local printers. If it is connected through a network, select Monitor Windows shared printers. Then click Next.

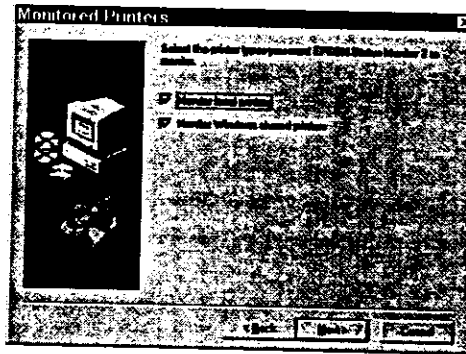
**Accessing EPSON Status Monitor 2**

There are two ways to access EPSON Status Monitor 2:

- Double-click the printer-shaped background monitoring icon on the taskbar at the bottom of your computer screen.

Note:

You must restart your computer after installing EPSON Status Monitor 2 to view the background monitoring icon.

- Click Start, point to Programs, click Epson, and then click EPSON Status Monitor 2.

Note:

The Progress Meter does not appear when Show Progress is turned off in the Speed & Progress dialog box. See "Speed & Progress" on page 67 for information.

Using the EPSON Spool Manager

The EPSON Spool Manager is similar to Windows Print Manager. If it receives two or more print jobs at one time, it puts them in a line (with printers on a network this may be called a print queue) in the order received. When a print job reaches the top of the line, the EPSON Spool Manager sends the job to the printer.

For Windows 95 and 98

Click the EPSON Stylus ^{PHOTO} COLOR 750 button after it appears on the taskbar. You can see the status and information for the print jobs and also you can cancel, pause and resume, or restart selected print jobs from the Spool Manager.

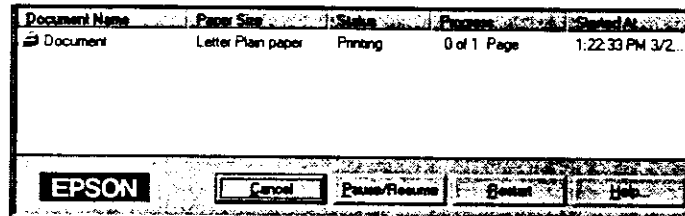

Using EPSON Status Monitor 2

If you installed the Status Monitor utility, you can get detailed information on the printer status.

L

Seychelles

html.bk

A5 size
7/10/98

Pre-Rev. A

STATSM.FM
Pass 2

Proof Sign-off:

K. Nishi

N.Nomoto

K.Norum

L

Seychelles
html.bk

A5 size
7/10/98



Pre-Rev. A

STATSM.FM
Pass 2

Proof Sign-off:

K. Nishi
N.Nomoto
K.Norum

Use these buttons to pause, resume, and cancel printing for documents selected in the dialog box.

-  **Pause** Pauses printing and moves the document to the end of the print queue
-  **Resume** Resumes printing from the current page
-  **Cancel** Cancels printing and deletes the document from the print queue

If you click the Show details arrow, an extension similar to the one below appears at the bottom of the EPSON Monitor3 dialog box. The extended dialog box displays detailed information on a selected document's printer driver settings.

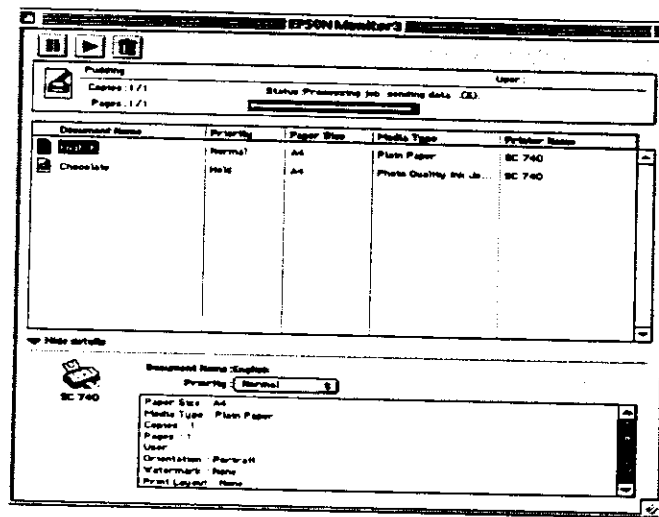

Changing the priority of print jobs

To change the priority of print jobs in a print queue, follow the steps below.

Making Configuration Settings

If you want to change the way the StatusMonitor utility monitors your printer, click the Configuration button in the Utility dialog box. The Configuration Settings dialog box appears.

The options in this dialog box allow you to make the following settings:

Error notification	Choose how the StatusMonitor notifies you in case of an error.
Warning	Choose how the StatusMonitor notifies you if a warning message becomes necessary.
Temporary Spool folder	Choose the folder for temporary spooling of print data.
Temporary High Speed Copies folder	Choose the folders for multiple-copy print data storage.
Check for errors before starting to print.	Select this check box if you want to check for errors before starting to print.
Check the ink level before starting to print.	Select this check box if you want to check the ink level before starting to print.

L

Seychelles

html.bk

Pre-Rev. A

A5 size
7/10/98

PAPER.FM
Pass 2

Proof Sign-off:

K. Nishi

N.Nomoto

K.Norum

Note:

The outside edge of your image might be cut off when you remove the perforated margins.

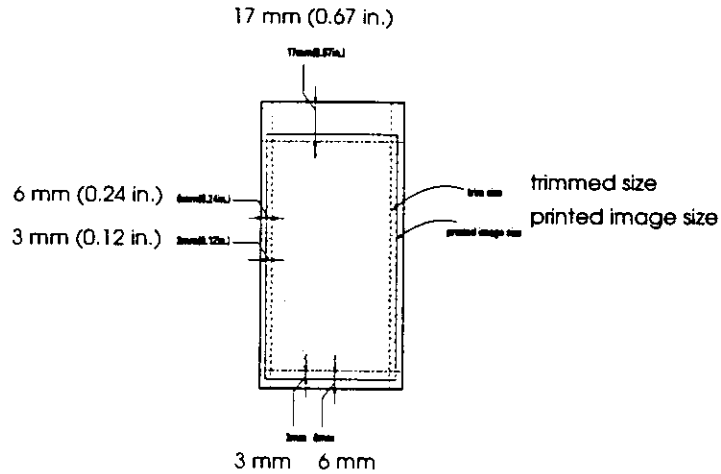

1520 x 1122 mm
変更 (横方向にのみ)
予定

- You can also print with black ink on the non-coated side (EPSON logo side) of Photo Paper. To print on this side, select 360 dpi Ink Jet Paper as the Media Type setting and then select EPSON Photo Paper 4X6 in as the Paper Size setting.
- Cut or tear the paper at the perforation only after printing. Do not cut, tear, or fold the paper before printing.

Photo Paper

Up to 20 sheets. For 4 x 6 inch Photo Paper, always put a support sheet* under the stack of Photo Paper.

Photo Stickers 16 and Photo Stickers 4

One sheet at a time. Always put the included Support Sheets A and B under the stack of Photo Stickers.

Panoramic Photo Paper and Iron-On Cool Peel Transfer Paper

One sheet at a time.

*Take care not to not print on support sheets loaded under special media.

- If the paper is curled, make sure to flatten it or curl it slightly toward the opposite side before loading. Printing on curled paper may smear your printout, especially when printing with Maximum selected as the Printable Area setting.

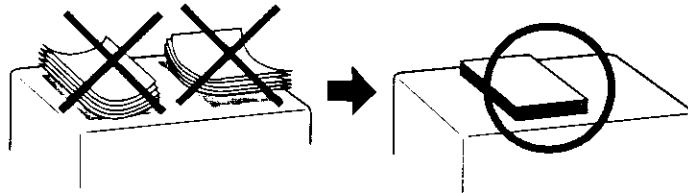

- If ink smears on your documents, set the adjust lever to the "+" position. To change the setting, open the printer cover and position the lever as shown in the illustration.

EPSON provides special media that are formulated for the ink used in EPSON ink jet printers. EPSON recommends you to use media distributed by EPSON to ensure high-quality results. See "EPSON special media" on page 182 for a complete list of these products.

When loading special paper distributed by EPSON, read the instruction sheets packed with your special media first and keep the following in mind.

- Make sure the printable side of the paper is face up when loading media into the sheet feeder. See the instruction sheets packed with the media to determine which side is the printable surface. Some media have cut corners to help identify the correct loading direction, as shown in the illustration.

191...?

Note:

If you extend the printable area with the Maximum setting in the printer driver, the cut corner on special paper may mar your printout.

- Make sure the paper stack fits under the arrow mark located on the inside surface of the left edge guide.

Previewing your printout

This feature allows you to see how your document will look before actually printing it. Follow these steps:

1. Make your printer driver settings.
2. Click the Preview icon button in the Print dialog box. The Print button changes into a Preview button.

Note:

To change the Preview button back into a Print button, simply click the Preview icon button again.

3. Click Preview. The Preview dialog box appears and displays a preview of your document.

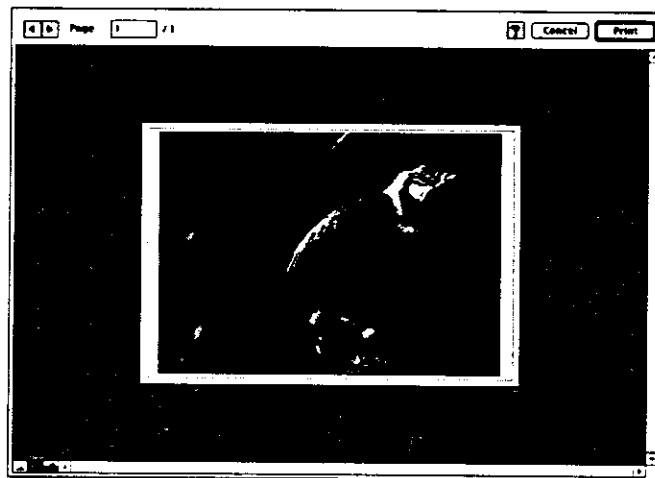

4. If you are satisfied with the previewed image, click Print.

If you are not satisfied with the appearance of the image, click Cancel. The Preview and Print dialog boxes close with the current print settings preserved. Open the Print dialog box again to make more changes to the print settings.

3. Enter a name for the watermark, and click Save.

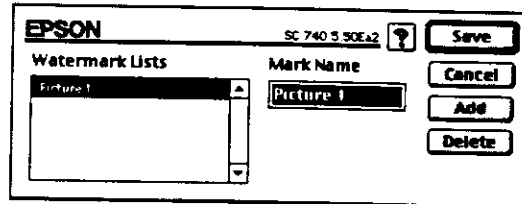

Your custom watermark will appear in the Watermark list.

Printing 2 or 4 pages on one sheet

You can print two or four pages on a sheet of paper by selecting 2 Pages or 4 Pages in the Print Layout box. You can also choose to print a frame around each page on the sheet of paper.

Print Order

You can determine the order in which you print multiple copies of your document: Collated (printed a set at a time), or in Reverse order.

Setting the print time

You can specify the time that you want the printer to start printing your document. Follow these steps:

Modifying the layout

You can modify the page layout of your document using the printer driver settings located in the Layout dialog box, shown below. To open this dialog box, click Print on the File menu of your application and click the Layout icon button in the Print dialog box.

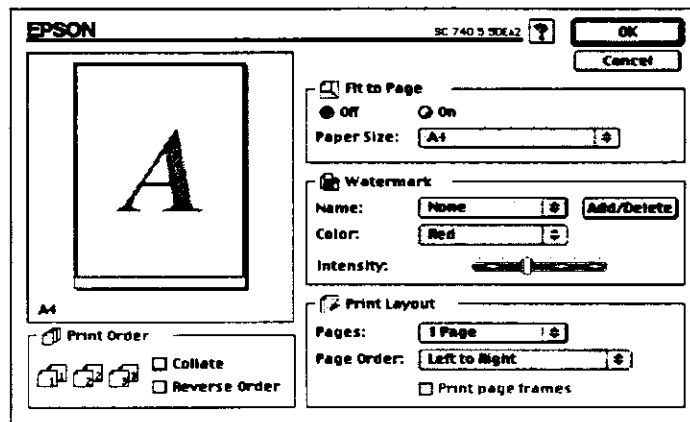

You can use the options in the Layout dialog box to fit your document to the paper size, to put a watermark on your document, or to print 2 or 4 pages of your document on one sheet.

Fitting your document to the paper size

Selecting this setting proportionally enlarges or reduces the size of the image to make it fit the paper size you selected in the Paper Size list. To use this function, click On and select the paper size you loaded in the printer.

Printing a watermark on your document

Selecting this function enables you to print a watermark in the background of your printed documents or images.

You can change the following settings:

Paper size	Select the paper size you want to use. If you want to define a custom paper size, see "Defining a custom paper size".
Orientation	Use this setting to specify the direction of printing on the page: Portrait (tall) or Landscape (wide). If you need to print close to the bottom of the page, click Rotate by 180 degrees.
Reduce or Enlarge	Use this setting to reduce or enlarge the size of your image.
Printable area	Select Maximum to increase the printable area. Note: <i>Print quality may decline at the edges of the expanded printable area. Print a single sheet to confirm quality before printing large jobs using this setting. Also, make sure the paper loaded in the sheet feeder is not curled.</i> Click Centered to position your printout at equal distances from the edges of the paper.

Defining a custom paper size

If your paper size is not included in the paper size list in the Page Setup dialog box, follow the steps below to define a custom paper size.

1. In the Page Setup dialog box, click Customize. The following dialog box appears:

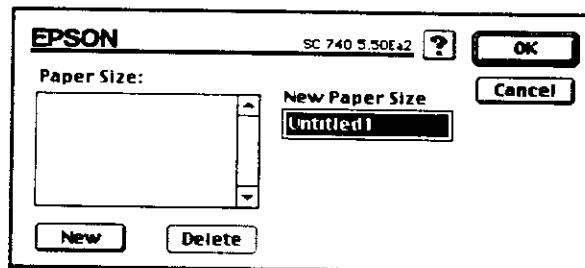

- Click OK to apply your settings and return to the Print dialog box. Click Cancel to return to the Print dialog box without applying your settings. To save your Advanced settings, see the next section.

Saving your settings

To save your Advanced settings as a group, click Save Settings in the Advanced dialog box. The Custom Settings dialog box appears:

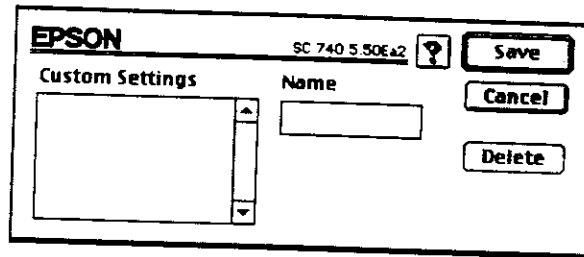

Type a unique name (up to 16 characters) for your settings in the Name box, and click Save.

You can save up to 10 groups of settings. You can select your saved group of settings from the settings list in the Print dialog box.

Note:

- The names of the ready-made settings provided by EPSON cannot be applied to your new settings.
- To delete a setting, select the setting in the Custom Settings dialog box and click Delete.
- You cannot delete the ready-made settings from the Custom Settings list.

The Custom settings list includes the following ready-made settings:

PhotoEnhance3	Best for printing video images or scanned images. This setting automatically adjusts the contrast, saturation, and brightness of the original image data to produce sharper, more vivid color printouts. PhotoEnhance3 does not affect your original image data. Note: <i>Printing with PhotoEnhance3 selected may increase print time depending on your computer system and the amount of data contained in your image.</i>
Digital Camera	Good for printing scanned images or images taken with a digital camera.
Text/Graph	Good for printing presentation documents such as graphs and charts.
Economy	Good for printing drafts of text.
ColorSync	This feature automatically adjusts printout colors to match colors on your screen.

Follow these steps to select a Custom setting.

1. First, verify the Media Type and Ink settings. For details, see "Making the Media Type setting".
2. Click the Custom radio button in the Print dialog box. This activates the Custom settings list, located below and to the right of the Custom radio button.
3. From the Custom settings list, select the most appropriate setting for the type of document or image you will print.
4. When you choose a Custom setting, other settings such as Print Quality, Halftoning, and Color are set automatically. Changes are shown in the Current Settings display on the right side of the Print dialog box.

EPSON Photo Quality Ink Jet Paper (Legal)	S041067
	S041048
EPSON Photo Quality Ink Jet Card (A6)	S041054
EPSON Photo Quality Ink Jet Card (5 x 8)	S041121
EPSON Photo Quality Ink Jet Card (8 x 10)	S041122
EPSON Photo Quality Self Adhesive Sheet (A4)	S041106
EPSON Ink Jet Note Cards A6 (with envelopes)	S041147
EPSON Ink Jet Greeting Cards 5 x 8 (with envelopes)	S041148
EPSON Ink Jet Greeting Cards 8 x 10 (with envelopes)	S041149

Photo Paper

EPSON Photo Quality Glossy Paper (A4)	S041126
EPSON Photo Quality Glossy Paper (Letter)	S041124
EPSON Photo Paper (A4)	S041140
EPSON Photo Paper (Letter)	S041141
EPSON Photo Paper (4 x 6)	S041134
EPSON Panoramic Photo Paper (210 x 594 mm)	S041145
EPSON Photo Cards (A4)	S041177

Photo Quality Glossy Film

EPSON Photo Quality Glossy Film (A4)	S041071
EPSON Photo Quality Glossy Film (Letter)	S041072
EPSON Photo Quality Glossy Film (A6)	S041107
EPSON Photo Stickers 16 (A6)	S041144
EPSON Photo Stickers 4 (A6)	S041176

Ink Jet Transparencies

EPSON Ink Jet Transparencies (A4)	S041063
EPSON Ink Jet Transparencies (Letter)	S041064

Note:

The availability of special media varies by country.

Making Changes to Printer Driver Settings

You will find the printer driver settings in the following dialog boxes:

- Print dialog box** (click Print on the File menu of your application or click Options in the Page Setup dialog box)
- Page Setup dialog box** (click Page Setup on the File menu of your application)
- Layout dialog box** (click the Layout icon button in the Print dialog box)
- Background Printing dialog box** (click the Background Printing icon button located in the Print dialog box)
- Preview dialog box** (click the Preview icon button and then click Preview in the Print dialog box)

The settings are arranged to give you three levels of control over the printer driver, as explained below.

Automatic setting	The quickest and easiest way to start printing. See "Using the Automatic setting".
Custom settings	Choose from a list of ready-made settings suited to the kind of document you want to print. You can also add your own settings to this list. See "Using the Custom settings".
Advanced settings	Allows you to make detailed settings to fit your individual needs. You can also add your settings to the Custom settings list. See "Using the Advanced settings".

Note:

If your printer is connected to LPT1, only the LPT1 tab is available.

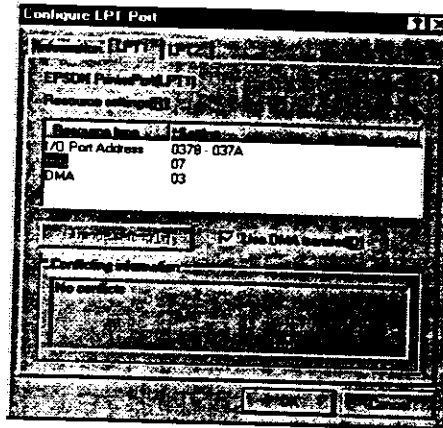
**Resources Settings (IRQ and DMA)**

If you have connected your printer to LPT2 or LPT3, making IRQ and DMA settings here may help you speed up printing. Input the same configuration numbers for IRQ and DMA which you have made with your expansion board. See your computer manual to determine the settings for IRQ and DMA.

Use DMA transfer

Using DMA transfer to send print data to the computer may help you speed up printing. If the Use DMA Transfer check box is dimmed, you first need to enable DMA transfer in your computer settings. For details, see your computer manual.

5. Select a basic configuration setting from the Setting based on list that uses the same Input/Output Range settings as those you wrote down in Step 4, and make sure the Direct Memory Access channel and Interrupt Request numbers are allocated and displayed. Confirm also that the Conflicting device list box shows No conflicts.
6. Click OK to save the settings.

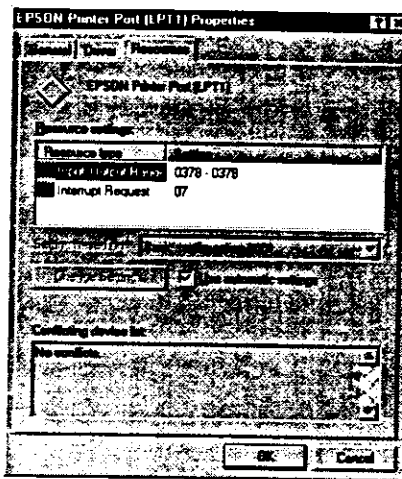

7. Reopen the Speed & Progress dialog box to verify whether DMA transfer has been enabled.

Note:

You may not be able to use DMA transfer on some computers even after you make the settings explained above. Consult your computer maker for information on the DMA transfer capability of your computer.

Using Port Configuration (Windows NT 4.0 only)**Note:**

Port settings for Windows NT 4.0 can only be made by network administrators.

Message	Action
(No message)	<p>Your system's parallel port setting does not allow DMA transfer. However, if you change the parallel port setting to ECP or Enhanced using your computer's BIOS Setup program, you may be able to use DMA transfer. Consult your computer manual or computer maker for instructions. Once you change the parallel port setting, follow the steps below this table to enable DMA transfer.</p> <p>Note: <i>Before you run the BIOS Setup program, uninstall the printer driver using Add/Remove Programs in the Control Panel. After running the BIOS Setup program, reinstall the printer driver.</i></p>

If you need to enable DMA transfer, follow these steps.

1. Double-click the My Computer icon and double-click the Control Panel.
2. Double-click the System icon and click the Device Manager tab.
3. Double-click the Ports (COM & LPT) icon and double-click LPT1. If you have connected your printer to a port other than LPT1, double-click the appropriate port icon.

The table below shows the factors related to print speed only.

	Print speed	
	Faster	Slower
Printer driver settings		
Ink	Black	Color
Collate*	Off	On
Flip Horizontal*	Off	On
Reverse Order*	Off	On
Data characteristics		
Variety of colors	Grayscale**	Full color
Hardware resources		
System speed	Fast	Slow
HDD free space	Large	Small
Memory free space	Large	Small
Software status		
Running applications	One	Many
Virtual memory	Not in use	In use

* Varies depending on the printer driver and application software you are using.

** Grayscale means using black ink only to print varying shades of gray, from pure black to pure white.

Using Speed & Progress

You can make certain print speed settings with the Speed & Progress dialog box. To access this dialog box, click Speed & Progress on your printer software's Utility menu.

If you want to change the watermark, click the Watermark Settings button. Then you can select from a list of predefined watermarks, or select a bitmap (.BMP) file as your own custom watermark. You can also change the size, color, and position of your watermark.

Getting Information Through Online Help

Your printer software has an extensive online help feature, which provides you with instructions on printing, making printer driver settings, and using printer utilities.

Accessing help from your application

Open the File menu and choose Print or Print Setup. Then click Printer, Setup, Options, or Properties. (Depending on your application, you may need to click a combination of these buttons.) Click the Help button at the bottom of the Main, Paper, Layout, and Utility menus for help related to the items on that menu.

Also you can get specific help related to any item on a menu by right-clicking the item, then clicking the What's This? prompt.

Accessing help from Windows 95, 98, and NT 4.0

Click the Start button, point to Programs and Epson (for Windows 95 and 98) or EPSON Printers (for Windows NT 4.0), and then click EPSON Stylus Photo 750 Help. You see the help contents window.

Use the options in the Printable Area box to adjust the total area available for printing. If you want to center the printout, click Center. If you need to increase the printable area, click Maximum.

Note:

- When Maximum is selected, the print quality may decline at the edges of the printout. Before printing large jobs using this setting, print a single sheet to confirm quality.
- When Maximum is selected, make sure the paper loaded in the sheet feeder is not curled.

Fitting your document to the paper size

To fit the size of your document to the size of the paper you will print on, use the Reduce/Enlarge options on the Layout menu.

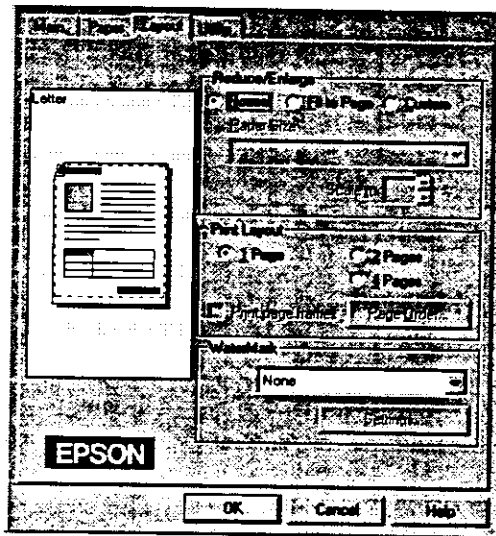

Normal	Prints your document at its normal size.
--------	------------------------------------------

To save your Advanced settings, click Save Settings in the Advanced settings dialog box. The Custom Settings dialog box appears:

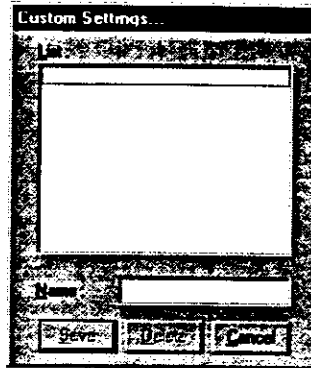

Type a unique name for your settings in the Name box, and click the Save button. Your settings will be added to the Custom settings list.

Note:

- The names of the ready-made settings provided by EPSON cannot be applied to your new settings.
- To delete a setting, select the setting in the Custom Settings dialog box and click Delete.
- You cannot delete the ready-made settings from the Custom Settings list.

When you select your saved settings in the Custom settings list, be aware that making new settings, for example Media Type and Ink settings, may change your custom settings. This may cause unexpected results in your printout. If this happens, reselect your saved settings and try printing again.

sRGB	Best for color matching with other sRGB devices.
------	--------------------------------------------------

Follow the steps below to select a Custom setting.

1. Click the Custom button on the Main menu.
2. From the Custom settings list, select the most appropriate setting for the type of document or image you will print.
3. When you choose a setting, other settings such as Print Quality, Halftoning, and Color Adjustment are set automatically. Changes are shown in the Current Settings display at the bottom of the Main menu.
4. Before printing, be sure to verify the Media Type and Ink settings, as they may be affected by the Custom setting you select. See "Making the Media Type setting".

Using the Advanced settings

The Advanced settings give you complete control over your printing environment. Use these settings to experiment with new printing ideas, or to fine-tune a range of print settings to meet your individual needs. Once you are satisfied with your new settings, you can give them a name and add them to the Custom settings list.

Follow the instructions below to make and save Advanced settings.

Note:

The printer driver screens that appear in this procedure are for Windows 95 and 98. The Windows NT 4.0 printer driver screens differ only slightly.

Ink Jet Transparencies

EPSON Ink Jet Transparencies (A4)

S041063

EPSON Ink Jet Transparencies (Letter)

S041064

Note:

The availability of special media varies by country.

Using the Automatic setting

When Automatic is selected on the Main menu, the printer driver takes care of all detailed settings based on the current Media Type and Ink settings. To make the Ink setting, click **COLOR** to print in color, or **BLACK** to print in black-and-white or grayscale. To make the Media Type setting, see "Making the Media Type setting".

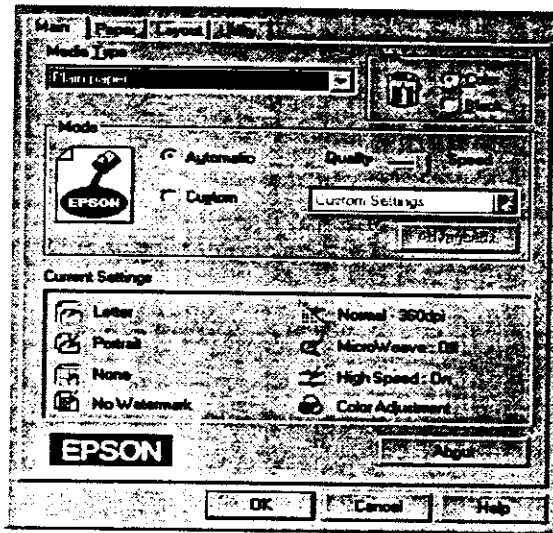

Note:

- Depending on the media you choose in the Media Type list while Automatic is selected, a slide bar appears in the Mode box that lets you choose Quality or Speed. Select Quality when print quality is more important than speed.

Custom settings	Choose from a list of ready-made settings suited to the kind of document you want to print. You can also add your own settings to this list. See "Using the Custom settings".
Advanced settings	Allows you to make detailed settings to fit your individual needs. You can also add your settings to the Custom settings list. See "Using the Advanced settings".

In addition to making groups of settings that affect overall print quality, you can also modify individual aspects of the print style and layout using the Paper and Layout menus. See "Modifying the printout style".

Making the Media Type setting

The Media Type setting determines what other settings are available, so you should always make this setting first.

On the Main menu, select the Media Type setting that matches the paper you loaded in the printer. Find your paper in the list below, then select a corresponding Media Type setting (shown in bold). For some kinds of paper, you have several Media Type settings to choose from.

Plain Paper

Plain paper
Envelopes

360 dpi Ink Jet Paper

EPSON 360 dpi ink Jet Paper (A4)	S041059 S041025
EPSON 360 dpi Ink Jet Paper (Letter)	S041060 S041028
EPSON Iron-On Cool Peel Transfer Paper (A4)	S041154
EPSON Iron-On Cool Peel Transfer Paper (Letter)	S041153 S041155

フォントサイズ
変更予定

To use the printer utilities, click the Utility tab in the printer software window, then click the button for the utility you want to use.

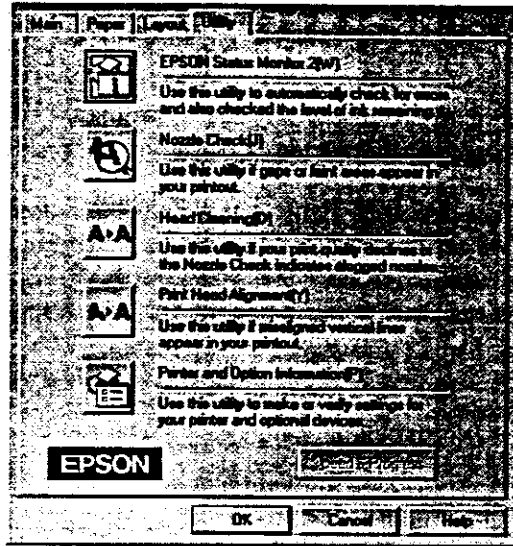

Note:

- The letter in parentheses after the utility name indicates the shortcut key for that utility. Press Alt and the letter on the keyboard to open that utility.
- While printing is in progress, pressing any of the utility buttons, except the EPSON Status Monitor button, may mar your printouts.

Accessing the printer software

You can access the printer software from most Windows applications, or from My Computer on the Windows desktop.

L

Seychelles

html.bk

Pre-Rev. A

A5 size
7/10/98

GLOSS.FM
Pass 2

Proof Sign-off:

K. Nishi

N.Nomoto

K.Norum

MicroWeave

Printing in which images are printed in finer increments to reduce the possibility of banding and to produce laser-like images. See also *banding*.

monochrome

This means printing with only one color of ink, which is generally black ink.

nozzle

Fine tubes in the print head through which ink is sprayed on the page. Print quality may decline if the print head nozzles are clogged.

operation check

A method for checking the operation of the printer. When you perform a printer operation check, the printer prints the ROM version, code page, ink counter code, and a nozzle check pattern.

parallel interface

See interface.

port

An interface channel through which data is transmitted between devices.

printable area

The area of a page on which the printer can print. It is smaller than the physical size of the page due to margins.

printer driver

A software program that sends commands for using the features of a particular printer. Often shortened to "driver".

printing mode

The number of dots per inch used to represent an image. Your printer has three printing mode settings: Fine (720 dpi), Normal (360 dpi), and Economy.

print queue

If your printer is connected to a network, print jobs that are sent to the printer while it is busy are stored in a waiting line, or print queue, until they can be printed.

RAM

Random Access Memory. The portion of the printer's memory used as a buffer and for storing user-defined characters. All data stored in RAM is lost when the printer is turned off.

reset

To return a printer to its defaults by turning the printer off and then back on.

resolution

The number of dots per inch used to represent an image.

default

A value or setting that takes effect when the equipment is turned on, reset, or initialized.

dithering

A halftoning method in which dots are arranged in an orderly pattern. Dithering works best for printing images with solid colors, such as charts and graphs. See also *halftoning*.

DMA

Direct Memory Access. A data transfer feature that by-passes a computer's CPU and allows direct communication between a computer and peripheral devices (like printers), and between one peripheral device and another.

dot matrix

A method of printing in which each letter or symbol is formed by a pattern (matrix) of individual dots.

dpi

Dots per inch. The dpi measures the resolution. See also *resolution*.

drive

A memory device, such as CD-ROM, hard disk, or floppy disk. In Windows, a letter is assigned to each drive for easy management.

driver

A software program that sends instructions to a computer peripheral to tell it what to do. For example, your printer driver accepts print data from your word processor application and sends instructions to the printer on how to print this data.

economy printing

Printing in which images are printed with fewer dots to save ink.

error diffusion

Error diffusion blends individual colored dots with the colors of the surrounding dots to create the appearance of natural colors. By blending colored dots, the printer can achieve excellent colors and subtle color gradation. This method is best suited for printing documents that contain detailed graphics or photographic images.

ESC/P 2

The enhanced version of the ESC/P printer command language. Commands in this language produce laser-like features, such as scalable fonts and enhanced graphics printing.

Finest detail

This printer driver setting automatically makes your printout sharper and clearer, especially for text. Be aware that this may increase the time required for printing.

L

Seychelles

html.bk

Pre-Rev. A

A5 size
7/10/98

SPEC.FM
Pass 2

Proof Sign-off:

K. Nishi

N.Nomoto

K.Norum

Forward channel

Data format	8-bit parallel, IEEE-1284 compatibility mode
Synchronization	STROBE pulse
Handshake timing	BUSY and ACKNLG signals
Signal level	TTL compatible
Connector	57-30360 Amphenol connector or equivalent

Reverse channel

Transmission mode	IEEE-1284 Nibble mode
Adaptable connector	57-30360 Amphenol connector or equivalent
Synchronization	Refer to the IEEE-1284 specification
Handshaking	Refer to the IEEE-1284 specification
Signal level	IEEE-1284 Level 1 device
Data transmission timing	Refer to the IEEE-1284 specification

Serial interface

The printer's built-in serial interface is based on the RS-423 standard. This interface has the following characteristics:

Standard	Based on RS-423
Synchronization	Synchronous
Bit rate	Approx. 1.8M bps
Handshaking	X-ON/X-OFF and DTR protocol
Word format	Data bit: 8 bits Parity bit: None Start bit: 1 bit Stop bit: 1 bit

Ink Cartridges

	7
Black ink cartridge (S02018 9)	
Color	Black
Print capacity*	540 pages (A4, text at 360 dpi)
Cartridge life	2 years from production date (within 6 months after opening package, at 25°C (77°F))
Temperature	Storage: -20 to 40°C (-4 to 104°F) 1 month at 40°C (104°F) Transit: -30 to 60°C (-22 to 140°F) 1 month at 40°C (104°F) 120 hours at 60°C (140°F) Freezing:** -16°C (3.2°F)
Dimensions	19.8 mm (W) × 52.7 mm (D) × 38.5 mm (H)

	3
Color ink cartridge (S02019 1)	
Color	Cyan, Magenta, Yellow, Light Cyan, and Light Magenta
Print capacity*	220 pages (A4, 360 dpi, 5% duty each color)
Cartridge life	2 years from production date (within 6 months of opening the package at 25°C (77°F))
Temperature	Storage: -20 to 40°C (-4 to 104°F) 1 month at 40°C (104°F) Transit: -30 to 60°C (-22 to 140°F) 1 month at 40°C (104°F) 120 hours at 60°C (140°F) Freezing:** -18°C (-0.4°F)
Dimensions	51.4 mm (W) × 52.7 mm (D) × 38.5 mm (H)

*The print capacity may vary, depending on how often you use the print head cleaning function and how often you use the printer.

**Ink thaws and is usable after approximately 3 hours at 25°C (77°F).

Photo Stickers:

Size	A6 (105 mm × 148 mm) with 16 frames
Paper types	Special paper distributed by EPSON

Note:

- Poor quality paper may reduce print quality and cause paper jams or other problems. If you encounter problems, switch to a higher grade of paper.
- Do not load curled or folded paper.
- Use paper under normal conditions:
Temperature 15 to 25°C (59 to 77°F)
Humidity 40 to 60% RH
- EPSON Photo Quality Glossy Film and Self Adhesive Sheets should be stored under the following conditions:
Temperature 15 to 30°C (59 to 86°F)
Humidity 20 to 60% RH

Printable area

Single sheets (including panoramic size) and index cards

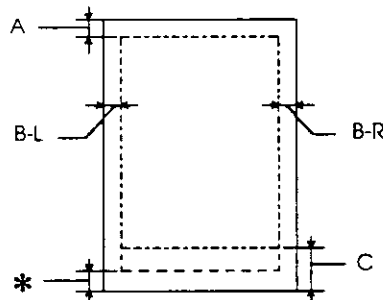

Resolution	Maximum 1440 dpi × 720 dpi
Print direction	Bidirectional with logic seeking
Control code	ESC/P 2 and raster graphics code EPSON Remote
Input buffer	64KB
Character tables	1 italic and 10 graphics character tables. (26 graphics character tables are available in certain countries.)
Character sets	14 international character sets and 1 legal character set

Paper

Note:

Since the quality of any particular brand or type of paper may be changed by the manufacturer at any time, EPSON cannot attest to the quality of any non-EPSON brand or type of paper. Always test samples of paper stock before purchasing large quantities or printing large jobs.

Single sheets:

Size	A4 (210 mm × 297 mm) A5 (148 mm × 210 mm) B5 (182 mm × 257 mm) Letter (216 mm × 279 mm) Half letter (139.7 mm × 215.9 mm) Legal (216 mm × 356 mm) Executive (184.2 mm × 266.7 mm)
Paper types	Plain bond paper, special papers distributed by EPSON
Thickness (for plain bond paper)	0.08 mm to 0.11 mm (0.003 to 0.004 inch)
Weight (for plain bond paper)	64 g/m ² (17 lb) to 90 g/m ² (24 lb)

L

Seychelles

html.bk

A5 size
7/10/98

Pre-Rev. A

OPTION.FM
Pass 2

Proof Sign-off:

K. Nishi

N.Nomoto

K.Norum





Ink cartridges

Black ink cartridge	S020187
Color ink cartridge	S020193

EPSON special media

Most plain paper works well in your printer. In addition, EPSON offers specifically designed media for ink jet printers to meet most high-quality printing needs.

EPSON 360 dpi Ink Jet Paper (A4)	S041059 S041025
EPSON 360 dpi Ink Jet Paper (Letter)	S041060 S041028
EPSON Photo Quality Ink Jet Paper (A4)	S041061 S041026
EPSON Photo Quality Ink Jet Paper (Letter)	S041062 S041029
EPSON Photo Quality Ink Jet Paper (Legal)	S041067 S041048
EPSON Photo Quality Ink Jet Card (A6)	S041054
EPSON Photo Quality Ink Jet Card (5 × 8")	S041121
EPSON Photo Quality Ink Jet Card (8 × 10")	S041122
EPSON Photo Quality Self Adhesive Sheet (A4)	S041106
EPSON Ink Jet Note Cards A6 (with envelopes)	S041147
EPSON Ink Jet Greeting Cards 5 × 8" (with envelopes)	S041148
EPSON Ink Jet Greeting Cards 8 × 10" (with envelopes)	S041149

	Paper jam. Take all the paper out of the feeder, and reload the paper. If the light continues to flash, turn off the printer and gently pull all the paper out of the printer.
	Ink low. The black ink cartridge is nearly empty. Obtain a black ink cartridge (S020187).
	Ink out. The black ink cartridge is empty. Replace the black ink cartridge (S020187).
	Ink low. The color ink cartridge is nearly empty. Obtain a color ink cartridge (S020193).
	Ink out. The color ink cartridge is empty. Replace the color ink cartridge (S020193).

5. output tray extension

6. sheet feeder

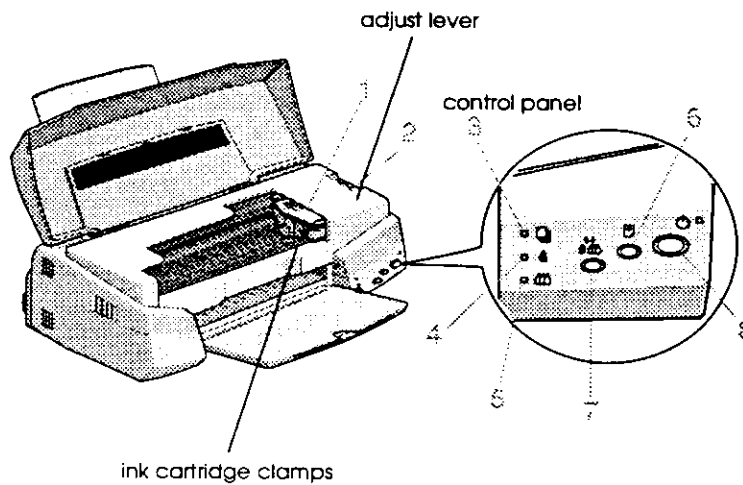

1. ink cartridge clamps
2. adjust lever
3. paper out light
4. black ink out light
5. color ink out light
6. load/eject button
7. cleaning button
8. power light and button

For Macintosh computers

To use this printer, your Apple® Macintosh® must meet the following system requirements. You also need a standard Apple System Peripheral-8 cable (8-pin mini-circular connector) or equivalent.

If you want connect your printer to a USB port, you need an iMac computer with a USB port; and a shielded USB cable.

Applicable computer models (as of September 1, 1998)

Macintosh LC475, LC575, LC630
 Macintosh Quadra Series
 Macintosh Centris Series
 Macintosh PowerBook™ Series (PowerBook 190, 520, 540, 550 or later)
 Macintosh PowerBook Duo 280, 2300c/100
 Macintosh Performa 475, 575, 588, 630, 5210 or later
 Power Macintosh Series
 iMac Series (for USB)

Environment

Minimum system	Recommended system
System 7.5.1	System 7.6 or later
5MB of available memory 10MB of available memory when background printing is turned on.	12MB or more of available memory 21MB of available memory when background printing is turned on.

Note:

- The amount of available memory varies according to the number and kind of applications that are open. To see how much memory is available, choose About This Macintosh from the Apple menu and refer to the memory size (listed in kilobytes) under "Largest Unused Block" (1,024K=1MB).*

Green and yellow — Earth
Blue — Neutral
Brown — Live

If you have to fit a plug:

As the colours of the mains lead of this appliance may not match coloured markings used to identify the terminals in a plug, please proceed as follows:

The green and yellow wire must be connected to the terminal in the plug which is marked with the letter E or the earth symbol (G).

The blue wire must be connected to the terminal in the plug marked with the letter N.

The brown wire must be connected to the terminal in the plug marked with the letter L.

If damage occurs to the plug, replace the cord set or consult a qualified electrician.

Replace fuses only with a fuse of the correct size and rating.

Warnings, Cautions, and Notes



Warnings must be followed carefully to avoid bodily injury.



Cautions must be observed to avoid damage to your equipment.

Notes contain important information and useful tips on the operation of your printer.

L

Seychelles

html.bk

A5 size
7/10/98

Pre-Rev. A

FRONT.FM
Pass 2

Proof Sign-off:

K. Nishi

N.Nomoto

K.Norum

H. Horiuchi

President of EPSON EUROPE B.V.

L

Seychelles
short.bk

Rev. A

A5 size
7/10/98

OPTION.FM
Pass 2

Proof Sign-off:

K. Nishi
N.Nomoto
K.Norum

L**Seychelles****short.bk****Rev. A**A5 size
7/10/98OPTION.FM
Pass 2

Proof Sign-off:

K. Nishi

N.Nomoto

K.Norum

EPSON 360 dpi Ink Jet Paper (Letter)	S041060 S041028
EPSON Photo Quality Ink Jet Paper (A4)	S041061 S041026
EPSON Photo Quality Ink Jet Paper (Letter)	S041062 S041029
EPSON Photo Quality Ink Jet Paper (Legal)	S041067 S041048
EPSON Photo Quality Ink Jet Card (A6)	S041054
EPSON Photo Quality Ink Jet Card (5 × 8")	S041121
EPSON Photo Quality Ink Jet Card (8 × 10")	S041122
EPSON Photo Quality Self Adhesive Sheet (A4)	S041106
EPSON Ink Jet Note Cards A6 (with envelopes)	S041147
EPSON Ink Jet Greeting Cards 5 × 8" (with envelopes)	S041148
EPSON Ink Jet Greeting Cards 8 × 10" (with envelopes)	S041149
EPSON Photo Quality Glossy Film (A4)	S041071
EPSON Photo Quality Glossy Film (Letter)	S041072
EPSON Photo Quality Glossy Film (A6)	S041107
EPSON Photo Quality Glossy Paper (A4)	S041126
EPSON Photo Quality Glossy Paper (Letter)	S041124
EPSON Ink Jet Transparencies (A4)	S041063
EPSON Ink Jet Transparencies (Letter)	S041064
EPSON Photo Paper (A4)	S041140
EPSON Photo Paper (Letter)	S041141
EPSON Photo Paper (4 × 6")	S041134
EPSON Photo Paper Cards (A4)	S041177
EPSON Photo Stickers 16 (A6)	S041144
EPSON Photo Stickers 4 (A6)	S041176

*9/15

L

**Seychelles
short.bk**

Rev. A

A5 size
7/10/98

TRBLE.FM
Pass 2

Proof Sign-off:

K. Nishi

N.Nomoto

K.Norum

For Singapore Users

Contact the telephone and fax numbers below:

Phone: (065) 337-7911

Fax: (065) 334-1185

For Hong Kong Users

To obtain technical support as well as other after-sales services, users are welcome to contact EPSON Hong Kong Limited.

Internet home page

EPSON Hong Kong has established a local home page in both Chinese and English on the Internet to provide users with the following information:

- Product information
- Answers to Frequently Asked Questions (FAQs)
- Latest versions of EPSON printer drivers

Users can access our World Wide Web home page at:
<http://www.epson.com.hk>

Electronic bulletin board system

An electronic bulletin board system (BBS) is also available to obtain printer information and the latest versions of printer drivers. You can log on to the following number for the BBS service:

BBS: (852) 2827-4244

A full list of EPSON Customer and Warranty Support services is available on the technical support section of our world wide web pages at <http://www.epson.co.uk/support/> and on Faxon EPSON Faxback service in document number 5085.

Pre Sales Enquiry Desk

The Enquiry Desk team can be contacted by calling 0800 220546 in the UK or 1 800 409132 from the Republic of Ireland, by faxing 01442 227271 in the UK or 0044 1442 227271 from the Republic of Ireland, and via Email at info@epson.co.uk. They can provide the following information:

- Pre Sales information and literature on new EPSON products (also available via our world wide web site at <http://www.epson.co.uk>)
- Where to purchase genuine EPSON consumables, accessories, and options

For Australian Users

EPSON Australia wishes to provide you with a high level of Customer Service. As well as the user's guide, we provide the following sources for obtaining information:

EPSON FAXBACK

EPSON FAXBACK will fax you the latest specifications and pricing for most EPSON products offered in Australia. There is also technical information including details of the latest software and drivers available. Phone (02) 9903 9075 and the system will guide you through a number of choices before faxing the information to your fax machine.

EPSON Bulletin Board System

This is where you can download the latest software and drivers. Visit the BBS to check out the latest versions. If you have a modem, phone (02) 9417 5090.

L

**Seychelles
short.bk**

A5 size
7/10/98

Rev. A

TRBLE.FM
Pass 2

Proof Sign-off:

K. Nishi

N.Nomoto

K.Norum

Serial number of your printer

(The serial number label is on the back of the printer.)

Printer model

Brand and model of your computer

Printer software version

(Click ABOUT in your printer driver.)

Windows version you are using

Software application(s) you normally use with your printer
and their version number(s)

For United Kingdom and the Republic of Ireland Users

If you purchased your printer in the UK or the Republic of Ireland, EPSON (UK) Limited provides a range of customer services and technical support.

World Wide Web



If you can connect to the Internet and have a Web browser, you can access our Web site at <http://www.epson.co.uk>. Here you will find information on the latest EPSON products, software drivers, on-line user guides, and answers to frequently asked questions.

Faxon EPSON

Contact Faxon EPSON Faxback Service for support information including troubleshooting tips, switch settings, and driver information.

Error Indicators

You can identify many common printer problems with the lights on your printer's control panel. If your printer stops working and the lights are on or flashing, use the following table of panel light patterns to diagnose the problem, then follow the recommended corrective measures.

Lights	Problem and Solution	
■ ●	Paper Out	
	No paper is loaded in the printer.	Load paper in the sheet feeder; then press the  load/eject button to turn this light off. The printer resumes printing.
	The paper is not loaded correctly.	Remove and reload the paper; then press the  load/eject button to turn this light off.
□ ● □ ▲ □ ●	Paper Jam	
	Paper has jammed in the printer.	Take all the paper out of the feeder, and reload the paper; then press the  load/eject button to turn this light off. If the light continues to flash, turn off the printer and gently pull all the paper out of the printer. If it tears and pieces remain inside the printer, open the printer cover and remove the pieces of paper. Turn on the printer and try again.
□ ●	Ink Low (black ink cartridge)	
	The black ink cartridge is nearly empty.	Obtain a replacement black ink cartridge (S020187).
■ ●	Ink Out (black ink cartridge)	
	The black ink cartridge is empty.	Replace the black ink cartridge with a new one (S020187). See "Replacing Ink Cartridges" on page 39.

L

Seychelles
short.bk

Rev. A

A5 size
7/10/98

MAINT.FM
Pass 2

Proof Sign-off:

K. Nishi

N.Nomoto

K.Norum

**Caution:**

Never turn off the printer while the  power light is flashing. Doing so may damage the printer.

3. When the  power light stops flashing, print a few lines from a document to confirm that the head is clean and to reset the cleaning cycle.

If print quality hasn't improved after repeating this procedure four or five times, one or both of your ink cartridges may be old or damaged and may need to be replaced. To replace an ink cartridge before it is empty, see "Replacing an Old or Damaged Ink Cartridge" in the online Reference Guide.

If the print quality still has not improved after replacing the ink cartridges, contact your dealer.

Aligning the Print Head

If you notice a misalignment of vertical lines, you may be able to solve this problem from your computer using the Print Head Alignment utility in your printer software.

Note:

Do not start the Print Head Alignment utility while printing is in progress; otherwise your printout may be marred.

For Windows users

1. Make sure paper is loaded in the sheet feeder.

**Caution:**

Use paper at least 210 mm (8.27 inches) wide; for example, A4 size paper loaded short edge first. Otherwise, the print head will spray ink directly onto the platen.

The printer prints an operation check page including your printer's ROM version information, the ink counter code, and a nozzle check pattern. Here is a typical printout:

W01289 I02382 0AD6

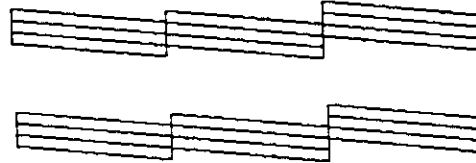

} 修正予定

The above sample is in black and white, but the actual test prints in color (CMYK).

2. Press the  power button to turn off the printer after it finishes printing the nozzle check pattern.

If the nozzle check page does not print satisfactorily, for example, if any segment of the printed lines is missing, there is a problem with the printer. This could be a clogged ink nozzle or a misaligned print head. See the next section for details on cleaning the print head. For information on aligning the print head, see "Aligning the Print Head" on page 48.

Cleaning the Print Head

If you find that the printed image is unexpectedly faint or dots in the printed image are missing, you may be able to solve these problems by cleaning the print head, which ensures that the nozzles are delivering ink properly.

You can clean the print head from your computer with the Head Cleaning utility in the printer software, or from the printer itself by using the printer's control panel buttons.

L

Seychelles
short.bk

Rev. A

A5 size
7/10/98

INK.FM
Pass 2

Proof Sign-off:
K. Nishi
N.Nomoto
K.Norum

**Caution:**



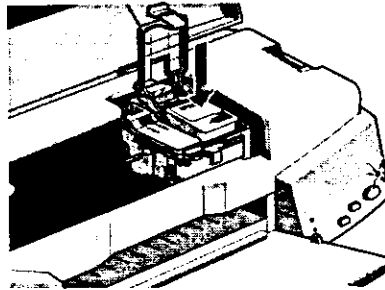

- You must remove the yellow tape seal from the cartridge. Leaving the tape on when you install the cartridge will permanently damage it.
 - Do not remove the blue portion of the tape seal from the top of the cartridge; otherwise, the cartridge may become clogged and cannot print.
 - Do not remove the tape seal from the bottom of the cartridge; otherwise, ink will leak.
7. Place the ink cartridge gently into the cartridge holder with the label on the cartridge face up. Do not press down on the cartridge.

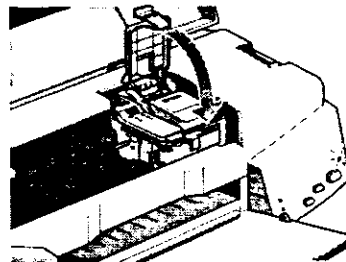



8. Press the ink cartridge clamp down until it locks in place.



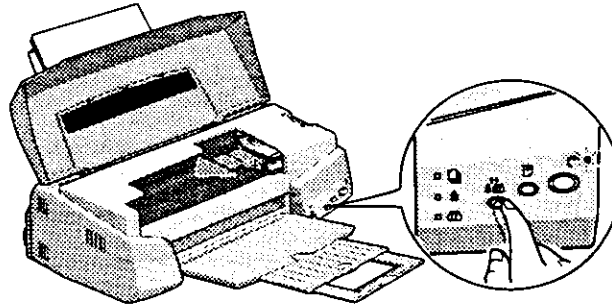

The illustration shows color ink replacement. To replace black ink, press down the smaller clamp on the left.

1. Make sure the printer is on. The  power light should be on, but not flashing. (Determine which cartridge needs to be replaced as indicated by the  black and  color ink out light.)
2. Lower the output tray at the front of the printer, then open the printer cover.
3. Hold down the  cleaning button for three seconds until the print head moves left slightly to the cartridge replacement position and the  power light begins flashing.

**Caution:**

Do not move the print head by hand. Always use the  cleaning button to move it. Otherwise you may damage the printer.

Note:

If you press the  cleaning button for three seconds when the  and  ink out lights are off, the printer starts cleaning the print head.

L

Seychelles
short.bk

A5 size
7/10/98

Rev. A

SETUP.FM
Pass 2

Proof Sign-off:

K. Nishi
N.Nomoto
K.Norum

Photo Paper

Up to 20 sheets. For 4 × 6 inch Photo Paper, always put a support sheet* under the stack of Photo Paper.

Photo Stickers 16
and Photo Stickers 4

One sheet at a time. Always put the included Support Sheets A and B under the stack of Photo Stickers.

Panoramic Photo
Paper and Iron-On
Cool Peel Transfer
Paper

One sheet at a time.

*Take care not to not print on support sheets loaded under special media.

L

Seychelles
short.bk

A5 size
7/10/98

Rev. A

SETUP.FM
Pass 2

Proof Sign-off:

K. Nishi

N.Nomoto

K.Norum

Note:

- Make sure the printable side of the paper is face up when loading media into the sheet feeder. See the instruction sheets packed with the media to determine which side is the printable surface. Some media have cut corners to help identify the correct loading direction, as shown in the illustration.*
- Always load paper into the sheet feeder short edge first.*
- Make sure the paper stack fits under the arrow mark inside the edge guide.*

8. Select the media you loaded in the printer from the Media Type list.
9. Select Color as the Ink option.
10. Make sure the Mode option is set to Automatic.

When Automatic is selected, the printer software optimizes other settings according to the Media Type and Ink settings you make.

11. Click Print to start printing.

Congratulations! Your EPSON printer is now fully setup and ready to help you create wonderful printouts. For further information about your printer, see the online Reference Guide. For details about the printer software, see online help. To learn more about color printing, see the online Color Guide.

Loading Special Paper

If you want to use plain paper, see "Loading Paper" on page 28.

Follow these steps to load special paper in the printer.

You can also print on ink jet paper, photo-quality glossy film or paper, photo paper, transparencies, envelopes, index cards, and adhesive sheets. For details on using such media, see "Printing on Special Paper" in the online Reference Guide.

L

**Seychelles
short.bk**

A5 size
7/10/98

Rev. A

SETUP.FM
Pass 2

Proof Sign-off:

K. Nishi _____
N.Nomoto _____
K.Norum _____

While printing, the EPSON Progress Meter will appear, showing the printing progress and the status of your printer. For details, see "Checking Printer Status and Managing Print Jobs for Windows" in the online Reference Guide.

Congratulations! Your EPSON printer is now fully setup and ready to help you create wonderful printouts. For further information about your printer, see the online Reference Guide. For details about the printer software, see online help. To learn more about color printing, see the online Color Guide.

Printing Your First Page for Macintosh

After loading the paper, you are ready to print your first page. In order to check the operation of your printer, we recommend printing the README file located on your printer software CD. The README file contains the latest information about your printer software.

If you choose to print your own document instead, check the Paper Size setting in your application software, then print the document as explained from step 3, below.

Note:

For details on how to use your application, see your application manual.

Follow these steps to print the README file:

1. Insert the printer software CD.
2. Open the EPSON folder and double-click the README file.

- Make sure the paper stack fits under the arrow mark inside the edge guide.*

Printing Your First Page for Windows

After loading the paper, you are ready to print your first page. In order to check the operation of your printer, we recommend printing the README file provided with your printer software. The README file contains the latest information about your printer software.

If you choose to print your own document instead, check the Paper Size setting in your application software, then print the document as explained from step 2, below.

Note :

For details on how to use your application, see your application manual.

Follow these steps to print the README file:

1. Click Start, point to Programs, point to Epson (for Windows 95, and 98) or EPSON Printers (for Windows NT 4.0), and then click EPSON Stylus Photo 750 Readme.
2. Click Print on the File menu. The Print dialog box appears.

If you are using an AppleTalk network, an alert message may appear when you click the port. In this case, reselect the other port, or make AppleTalk setting inactive then select the port again.

3. Click the Background Printing radio buttons to turn background printing on or off.

When background printing is on, you can use your Macintosh while it is preparing a document for printing. You must turn on background printing to use the EPSON Monitor3 utility to manage print jobs.

4. Close the Chooser.

For information on opening and using the software, see "Printing Your First Page for Macintosh" on page 32. See also "Using the Printer Software for Macintosh" in the online Reference Guide.

Loading Paper

Follow these steps to load plain paper in the printer.

You can also print on ink jet paper, photo-quality glossy film or paper, photo paper, transparencies, envelopes, index cards, and adhesive sheets. For details on using such media, see "Loading Special Paper" on page 34, or "Printing on Special Paper" in the online Reference Guide.

4. After the initial screen appears, click Continue. The following dialog box appears.

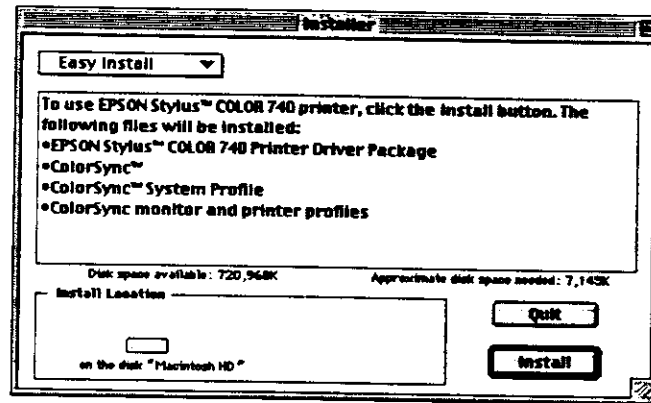

5. If you want to install all of the printer software included on your printer software CD-ROM, make sure the Install Location box shows the correct disk drive and click Install.

If you are low on disk space, select Custom Install from the pop-up menu and click Serial Driver Package. Confirm the destination for installation, then click Install.

Note:

Click the  icon to get information on each component.

6. When a message appears informing you that installation is finished, click Restart to complete the installation and restart your computer.

Selecting Your Printer in the Chooser

For information on opening and using the software, see "Printing Your First Page for Macintosh" on page 32. See also "Using the Printer Software for Macintosh" in the online Reference Guide.

Installing the Printer Software in Your Macintosh

After connecting the printer to your Macintosh, you are ready to install the printer software included in the "Printer Software for EPSON Stylus Photo 750" CD-ROM shipped with your printer.

Your printer software includes:

- EPSON Printer Driver Package**

SP750

This is the printer driver software that runs your printer. With it, you can make settings such as media type, print quality, speed, and paper size.

EPSON Monitor3

Monitors and manages background printing jobs. You must turn on background printing in the Chooser to use this utility.

StatusMonitor

Keeps track of the current status of your printer, and alerts you when printer errors occur.

Nozzle Check

Checks the print head for clogging.

Head Cleaning

Cleans the print head to maintain the best print quality.

Print Head Alignment

Adjusts the print head so that vertical and horizontal lines are aligned.

- Installation time varies depending on your computer.*

For information on opening and using the software, see "Printing Your First Page for Windows" on page 30. See also "Using the Printer Software for Windows" in the online Reference Guide.

If you use your printer on a network, see "Network Printing" in the online Reference Guide.

Installing in Windows 98 with USB interface

If you connected your printer using the USB interface, you need to install the EPSON USB Printer Device Driver and the printer software included in the printer software CD-ROM. Follow the instructions in the *USB User's Guide* that came with your printer.

Note:

If you wish to make a floppy disk version of the printer software included on your CD-ROM, insert the printer software CD-ROM, then click the Driver disk creation utility button and follow the on-screen instructions.

For information on opening and using the software, see "Printing Your First Page for Windows" on page 30. See also "Using the Printer Software for Windows" in the online Reference Guide.

Connecting the Printer to Your Macintosh

Note:

To connect to an iMac computer using the USB port, see the USB User's Guide shipped with your printer.

To use the printer's built-in serial interface, you will need an Apple System Peripheral-8 cable.

Follow these steps to connect the printer:

2. Plug the cable connector securely into the printer's interface connector. Then squeeze the wire clips together until they lock in place on both sides. If your cable has a ground wire, connect it to the ground connector below the interface connector.

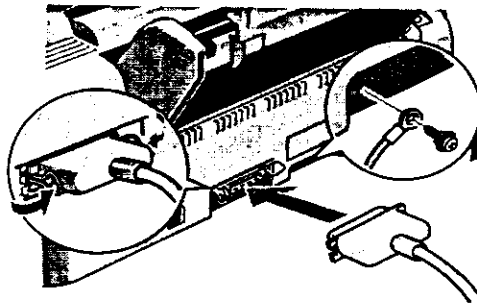

3. Plug the other end of the cable into the computer's parallel interface. If there is a ground wire at the computer end of the cable, connect it to the ground connector at the back of the computer.

See "Installing the Printer Software in Your PC" on page 20 for instructions on installing the printer software. You must install the printer software before using your printer.

Installing the Printer Software in Your PC

After connecting the printer to your computer, you need to install the software included on the "Printer Software for EPSON Stylus Photo 750" CD-ROM shipped with your printer.

Your printer software includes:

- Printer driver**
The printer driver is the software that runs, or "drives," your printer. With it, you can make settings such as media type, print quality, speed, and paper size.

6. Press the ink cartridge clamps down until they lock in place.

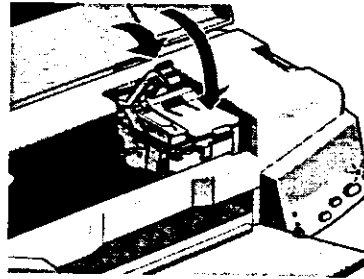
**Caution:**

Once you install the ink cartridges, do not open their clamps again until you replace the ink cartridges. Otherwise, the cartridges may become unusable.

7. Press the  cleaning button. The printer moves the print head and begins charging the ink delivery system.

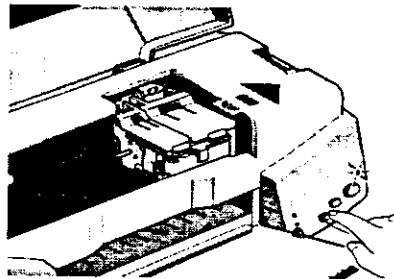



The ink charging process may take about one minute to complete, during which time the  power light flashes and the printer produces a variety of mechanical sounds. These sounds are normal. When the ink delivery system has been charged, the print head returns to its home (far right) position.

**Caution:**

Never turn off the printer while the  power light is flashing.

2. Turn on the printer.

The print head moves slightly to the left, which is the ink cartridge install position. The  power light flashes and the  ink out lights come on.

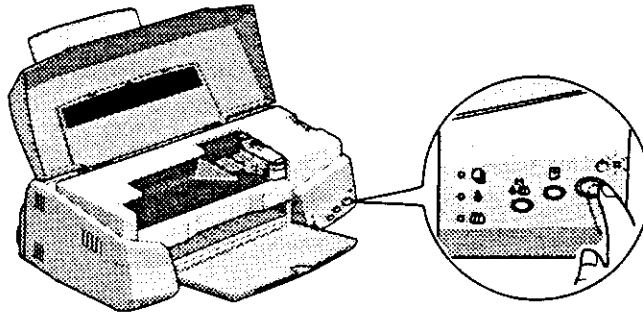
**Caution:**

Do not move the print head by hand. Otherwise you may damage the printer.

3. Lift up the ink cartridge clamps.

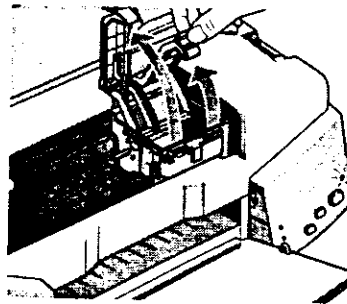

Attaching the Paper Support

Insert the paper support into the slots at the rear of the printer.

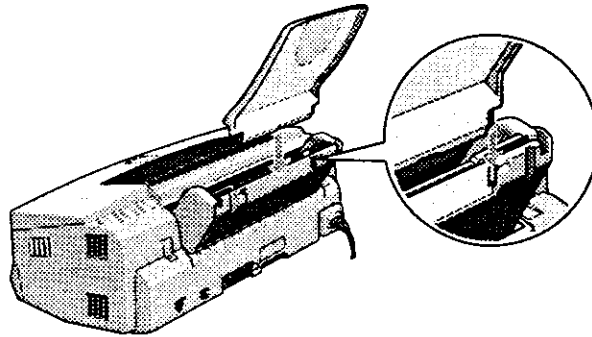

Plugging in the Printer

1. Make sure that the printer is turned off. It is off when the  power button protrudes slightly from the surface of the control panel.
2. Check the label on the back of the printer to make sure the voltage required by the printer matches that of the electrical outlet you will be plugging it into. Also, make sure that you have the correct power cable for your power source.



Caution:

It is not possible to change the printer's voltage. If the rated voltage and your outlet voltage do not match, contact your dealer for assistance. Do not plug in the power cord.

3. If the power cord is not attached to the printer, connect it to the AC inlet on the back of the printer.
4. Plug the power cord into a properly grounded electrical outlet.

L

Seychelles
short.bk

Rev. A

A5 size
7/10/98

SETUP.FM
Pass 2

Proof Sign-off:

K. Nishi

N.Nomoto

K.Norum

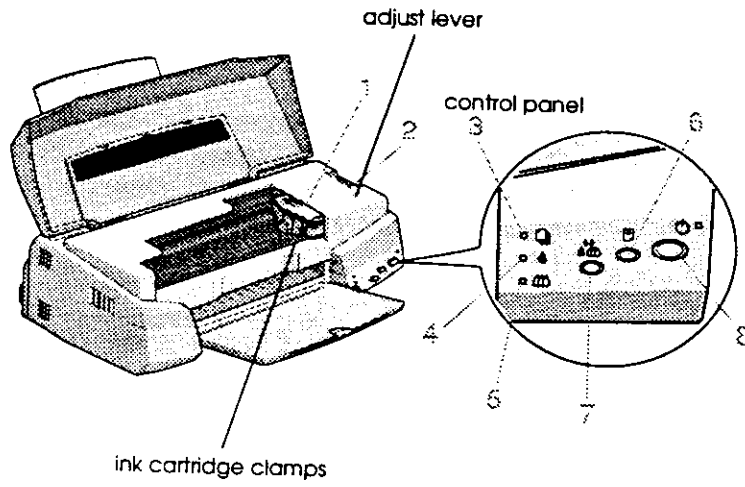

For Macintosh computers

To use this printer, your Apple® Macintosh® must meet the following system requirements. You also need a standard Apple System Peripheral-8 cable (8-pin mini-circular connector) or equivalent.

If you want connect your printer to a USB port, you need an iMac computer with a USB port; and a shielded USB cable.

Applicable computer models (as of September 1, 1998)

Macintosh LC475, LC575, LC630

Macintosh Quadra Series

Macintosh Centris Series

Macintosh PowerBook™ Series (PowerBook 190, 520, 540, 550 or later)

Macintosh PowerBook Duo 280, 2300c/100

Macintosh Performa 475, 575, 588, 630, 5210 or later

Power Macintosh Series

iMac Series (for USB)

Environment

Minimum system	Recommended system
System 7.5.1	System 7.6 or later
5MB of available memory 10MB of available memory when background printing is turned on.	12MB or more of available memory 21MB of available memory when background printing is turned on.

Note:

- The amount of available memory varies according to the number and kind of applications that are open. To see how much memory is available, choose About This Macintosh from the Apple menu and refer to the memory size (listed in kilobytes) under "Largest Unused Block" (1,024K=1MB).

L

**Seychelles
short.bk**

A5 size
7/10/98

Rev. A

SAFETY.FM
Pass 2

Proof Sign-off:

K. Nishi

N.Nomoto

K.Norum

Placez l'imprimante près d'une prise de contact où la fiche peut être débranchée facilement.

Warnings, Cautions, and Notes



Warnings must be followed carefully to avoid bodily injury.



Cautions must be observed to avoid damage to your equipment.

Note:

contain important information and useful tips on the operation of your printer.

- Unplug the printer and refer servicing to qualified service personnel under the following conditions:

The power cord or plug is damaged; liquid has entered the printer; the printer has been dropped or the cabinet damaged; the printer does not operate normally or exhibits a distinct change in performance.



- If you plan to use the printer in Germany, observe the following:

To provide adequate short-circuit protection and over-current protection for this printer, the building installation must be protected by a 16 Amp circuit breaker.

Bei Anschluß des Druckers an die Stromversorgung muß sichergestellt werden, daß die Gebäudeinstallation mit einem 16 A-Überstromschalter abgesichert ist.

A Few Precautions

When using the printer

- Do not put your hand inside the printer or touch the ink cartridges during printing.
- Do not move the print head by hand; otherwise you may damage the printer.
- Always turn the printer off using the  power button. When this button is pressed, the  power light flashes briefly then goes off. Do not unplug the printer or turn off the power to the outlet until the  power light stops flashing.
- Before transporting the printer, make sure the print head is in the home (far right) position and the ink cartridges are in place.