

User's Manual

EPSON Stylus Color 900

P120A

FCC ID : BKMFBP120A

Proof Sign-off:
Y.Yano _____
N.Nomoto _____
K.Pipa _____

Lancaster
short.bk

A5 size
8/21/98

Rev.A

SAFETY.FM
Pass 1

R

FCC Compliance Statement For United States Users

This equipment has been tested and found to comply with the limits for a Class B digital device, pursuant to Part 15 of the FCC Rules. These limits are designed to provide reasonable protection against harmful interference in a residential installation. This equipment generates, uses, and can radiate radio frequency energy and, if not installed and used in accordance with the instructions, may cause harmful interference to radio or television reception. However, there is no guarantee that interference will not occur in a particular installation. If this equipment does cause interference to radio and television reception, which can be determined by turning the equipment off and on, the user is encouraged to try to correct the interference by one or more of the following measures.

- ▶ Reorient or relocate the receiving antenna.
- ▶ Increase the separation between the equipment and receiver.
- ▶ Connect the equipment into an outlet on a circuit different from that to which the receiver is connected.
- ▶ Consult the dealer or an experienced radio/TV technician for help.

WARNING

The connection of a non-shielded equipment interface cable to this equipment will invalidate the FCC Certification of this device and may cause interference levels which exceed the limits established by the FCC for this equipment. It is the responsibility of the user to obtain and use a shielded equipment interface cable with this device. If this equipment has more than one interface connector, do not leave cables connected to unused interfaces. Changes or modifications not expressly approved by the manufacturer could void the user's authority to operate the equipment.

For Canadian Users

This Class B digital apparatus complies with Canadian ICES-003.

Cet appareil numérique de la classe B est conforme à la norme NMB-003 du Canada.

L

Lancaster
short.bk

A5 size
8/21/98

Rev.A

FRONT.FM
Pass 1

Proof Sign-off:

Y.Yano

N.Nomoto

K.Pipa

STYLUS COLOR 900

All rights reserved. No part of this publication may be reproduced, stored in a retrieval system, or transmitted in any form or by any means, electronic, mechanical, photocopying, recording, or otherwise, without the prior written permission of SEIKO EPSON CORPORATION. The information contained herein is designed only for use with this EPSON printer. EPSON is not responsible for any use of this information as applied to other printers.

Neither SEIKO EPSON CORPORATION nor its affiliates shall be liable to the purchaser of this product or third parties for damages, losses, costs, or expenses incurred by the purchaser or third parties as a result of: accident, misuse, or abuse of this product or unauthorized modifications, repairs, or alterations to this product, or (excluding the U.S.) failure to strictly comply with SEIKO EPSON CORPORATION's operating and maintenance instructions.

SEIKO EPSON CORPORATION shall not be liable for any damages or problems arising from the use of any options or any consumable products other than those designated as Original EPSON Products or EPSON Approved Products by SEIKO EPSON CORPORATION.

SEIKO EPSON CORPORATION shall not be held liable for any damage resulting from electromagnetic interference that occurs from the use of any interface cables other than EPSON Approved Products by SEIKO EPSON CORPORATION.

EPSON and EPSON ESC/P are registered trademarks and EPSON ESC/P 2, ESC/P Raster and EPSON Stylus are trademarks of SEIKO EPSON CORPORATION.

Microsoft and Windows are registered trademarks of Microsoft Corporation.

General Notice: Other product names used herein are for identification purposes only and may be trademarks of their respective owners. EPSON disclaims any and all rights in those marks.

Copyright © 1998 by SEIKO EPSON CORPORATION, Nagano, Japan.



Printed on Recycled Paper.

Safety Instructions

Important Safety Instructions

Read all of these instructions before using your printer. Also be sure to follow all warnings and instructions marked on the printer.

- Do not block or cover the openings in the printer's cabinet.
- Do not insert objects through the slots. Take care not to spill liquid on the printer.
- Use only the type of power source indicated on the printer's label.
- Connect all equipment to properly grounded power outlets. Avoid using outlets on the same circuit as photocopiers or air control systems that regularly switch on and off.
- Avoid electrical outlets controlled by wall switches or automatic timers.
- Keep the entire computer system away from potential sources of electromagnetic interference, such as loudspeakers or the base units of cordless telephones.
- Do not use a damaged or frayed power cord.
- If you use an extension cord with the printer, make sure the total ampere rating of the devices plugged into the extension cord does not exceed the cord's ampere rating. Also, make sure the total ampere rating of all devices plugged into the wall outlet does not exceed the wall outlet's ampere rating.
- Do not attempt to service the printer yourself.

L

Lancaster
short.bk

A5 size
8/21/98

Rev.A

SAFETY.FM
Pass 1

Proof Sign-off:

Y.Yano
N.Nomoto
K.Pipa

- Unplug the printer and refer servicing to qualified service personnel under the following conditions:

The power cord or plug is damaged; liquid has entered the printer; the printer has been dropped or the cabinet damaged; the printer does not operate normally or exhibits a distinct change in performance.



- If you plan to use the printer in Germany, observe the following:

To provide adequate short-circuit protection and over-current protection for this printer, the building installation must be protected by a 16 Amp circuit breaker.

Bei Anschluß des Druckers an die Stromversorgung muß sichergestellt werden, daß die Gebäudeinstallation mit einem 16 A-Überstromschalter abgesichert ist.

A Few Precautions

When using the printer

- Do not put your hand inside the printer or touch the ink cartridges during printing.
- Do not move the print head by hand; otherwise you may damage the printer.
- Always turn the printer off using the  power button. When this button is pressed, the  power light flashes briefly then goes off. Do not unplug the printer or turn off the power to the outlet until the  power light stops flashing.
- Before transporting the printer, make sure the print head is in the home (far right) position and the ink cartridges are in place.

Proof Sign-off:
Y.Yano
N.Nomoto
K.Pipa

Lancaster
short.bk

A5 size
8/21/98

Rev.A

SAFETY.FM
Pass 1

R

When handling the ink cartridges

- Keep ink cartridges out of the reach of children. Do not allow children to drink or otherwise handle the cartridges.
- If ink gets on your skin, wash it off with soap and water. If it gets in your eyes, flush them immediately with water.
- Do not shake an ink cartridge; this can cause leakage.
- Install the ink cartridge immediately after you remove it from its package. Leaving the cartridge unpacked for a long time before use may result in reduced print quality.
- Once you install an ink cartridge, do not open the clamp or remove the cartridge except to replace it with a new one. The cartridge may become unusable otherwise.
- Do not use an ink cartridge beyond the date printed on the cartridge carton. For best results, use up the ink cartridges within six months of installing them.
- Do not dismantle the ink cartridges or try to refill them. This could damage the print head.

When choosing a place for the printer

- Place the printer on a flat, stable surface that is larger than the printer. The printer will not operate properly if it is tilted or at an angle.
- Avoid places subject to rapid changes in temperature and humidity. Also keep it away from direct sunlight, strong light, or heat sources.
- Avoid places subject to shocks and vibrations.

L

**Lancaster
short.bk**

A5 size
8/21/98

Rev.A

SAFETY.FM
Pass 1

Proof Sign-off:

Y.Yano

N.Nomoto

K.Pipa

- Place the printer near a wall outlet where the plug can be easily unplugged.

Note for French-speaking users:

Placez l'imprimante près d'une prise de contact où la fiche peut être débranchée facilement.

Warnings, Cautions, and Notes



Warnings must be followed carefully to avoid bodily injury.



Cautions must be observed to avoid damage to your equipment.

Notes contain important information and useful tips on the operation of your printer.

Setting Up Your Printer

System Requirements

For PCs

To use your printer, you need Microsoft® Windows® 3.1, Windows® 95, Windows® 98, Windows® NT 4.0, or DOS; and a shielded, twisted-pair parallel cable. If you want to connect your printer to a USB port, you need a Windows 98 pre-installed PC equipped with a USB port; and a shielded USB cable.

Your computer should also meet the following system requirements.

Minimum system	Recommended system
i386/25 MHz processor for Windows 3.1 i486/25 MHz for Windows 95 and NT 4.0 i486/66 MHz for Windows 98	Pentium or higher processor
16MB RAM	32MB RAM or more for Windows 3.1, 95 and 98 64MB or more for Windows NT 4.0
10MB hard disk space for Windows 95 and 98 20MB for Windows 3.1 and NT 4.0	50MB or more free disk space for Windows 3.1, 95, and 98 100MB or more for Windows NT 4.0
VGA monitor	VGA or better monitor

Your computer dealer can help you update your system if it does not meet these requirements.

L

Lancaster
short.bk

A5 size
8/21/98

Rev.A

SETUP.FM
Pass 1

Proof Sign-off:

Y.Yano

N.Nomoto

K.Pipa

For Macintosh computers

You can use this printer with the following Apple® Macintosh® computers. You also need a standard Apple System Peripheral-8 cable (8-pin mini-circular connector) or equivalent.

Applicable computer models (as of September 1, 1998)

Macintosh LC475, LC575, LC630

Macintosh Quadra Series

Macintosh Centris Series

Macintosh PowerBook™ Series (PowerBook 190, 520, 540, 550 or later)

Macintosh PowerBook Duo 280, 2300c/100

Macintosh Performa 475, 575, 588, 630, 5210 or later

Power Macintosh Series

iMac Series (for USB)

If you want to connect your printer to a USB port, you need an iMac computer with a USB port, and a shielded USB cable.

Your Macintosh must also meet the following system requirements.

Environment

Minimum system	Recommended system
System 7.5.1	System 7.6 or later
5MB of available memory 10MB of available memory when background printing is turned on.	12MB or more of available memory 21MB of available memory when background printing is turned on.

Proof Sign-off:
Y.Yano
N.Nomoto
K.Pipa

Lancaster
short.bk

A5 size
8/21/98

Rev.A

SETUP.FM
Pass 1

R

Note:

- The amount of available memory varies according to the number and kind of applications that are open. To see how much memory is available, choose About This Macintosh from the Apple menu and refer to the memory size (listed in kilobytes) under "Largest Unused Block" (1,024K=1MB).*
- The memory requirements above are for printing on Letter size paper. These requirements may vary depending on the size of the paper, the type of application you are using, and the complexity of the document you want to print.*

In addition to these system and memory requirements, you also need 10MB of free hard disk space to install your printer software. To print, you need extra hard disk space amounting to about double the size of the file you want to print.

L

Lancaster
short.bk

A5 size
8/21/98

Rev.A





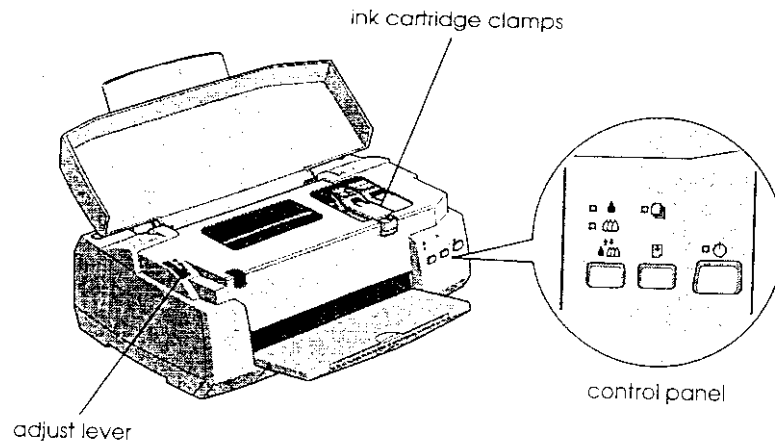
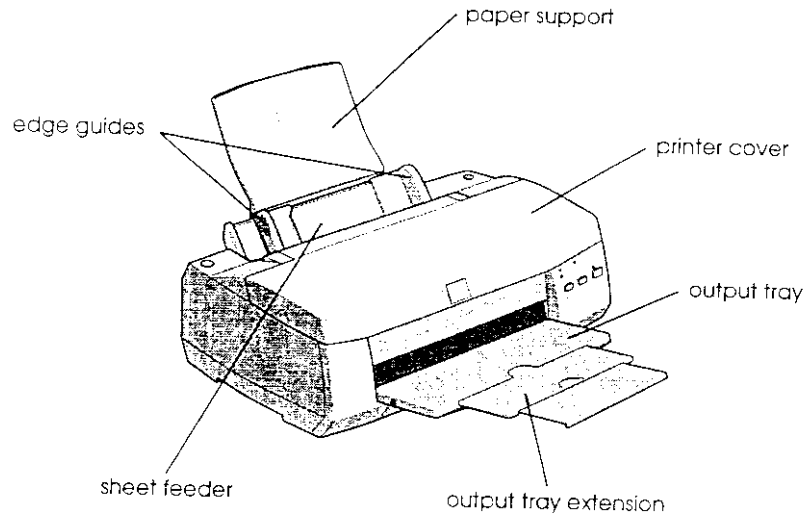

SETUP.FM
Pass 1

Proof Sign-off:
Y.Yano
N.Nomoto
K.Pipa





Printer Parts and Control Panel Functions



Buttons

Button	Function
 Power	Turns the printer on and off. Clears the printer's memory if pressed twice while the power is on.
 Load/Eject	Loads or ejects paper if pressed and released within 2 seconds. Resumes printing if pressed and released after a paper out error.
 Cleaning	Moves the print head to the ink cartridge replacement position if pressed for 3 seconds while the  black or  color ink out light is flashing or on. Returns the print head to its home position after ink cartridge replacement. Performs print head cleaning if pressed for 3 seconds when the  black or  color ink out light is off.

Lights

Light	Printer Status
 Power	On when the printer is on. Flashes when receiving data, replacing an ink cartridge, charging ink, or cleaning the print head.
 Paper out	On when the printer is out of paper. Load paper in the sheet feeder; then press the  load/eject button to resume printing. Flashes when paper is jammed. Take all the paper out of the feeder, and reload the paper. If the light continues to flash, turn off the printer and gently pull all the paper out of the printer.
 Black ink out	On when black ink is low. The black ink cartridge is nearly empty. Flashes when black ink is out. The black ink cartridge is empty. Replace the black ink cartridge (1003).
 Color ink out	On when color ink is low. The color ink cartridge is nearly empty. Flashes when color ink is out. The color ink cartridge is empty. Replace the color ink cartridge (1005).

Attaching the Paper Support

Insert the paper support into the slots at the rear of the printer.

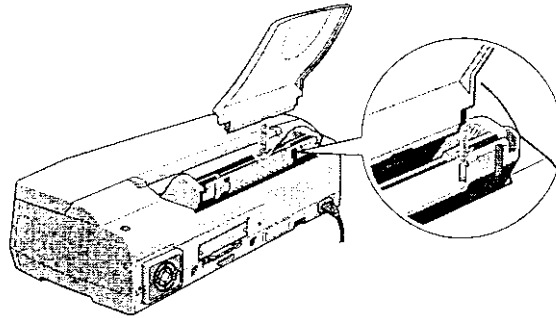

Plugging in the Printer

1. Make sure that the printer is turned off. It is off when the  power button protrudes slightly from the surface of the control panel.
2. Check the label on the back of the printer to make sure the voltage required by the printer matches that of the electrical outlet you will be plugging it into. Also, make sure that you have the correct power cable for your power source.

**Caution:**

It is not possible to change the printer's voltage. If the rated voltage and your outlet voltage do not match, contact your dealer for assistance. Do not plug in the power cord.

3. If the power cord is not attached to the printer, connect it to the AC inlet on the back of the printer.
4. Plug the power cord into a properly grounded electrical outlet.



Installing the Ink Cartridges

Before installing the ink cartridges, note the following.



Warning:

The ink cartridges are self-contained units. Under ordinary use, ink will not leak from a cartridge. If ink does get on your hands, wash them thoroughly with soap and water. If ink gets into your eyes, flush them immediately with water.

Note:

- Do not open the ink cartridge packages until just before you install them, or the ink may dry up.*
- Use the ink cartridges packed with your printer the first time you install ink cartridges; otherwise the printer may not charge ink properly.*

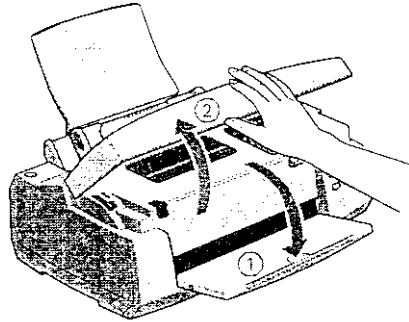

Install the ink cartridges as follows:

1. Lower the output tray; then open the printer cover.

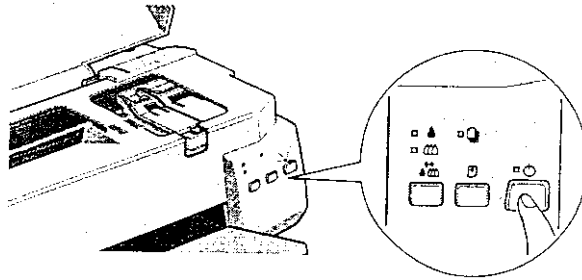

2. Turn on the printer by pressing the  power button.

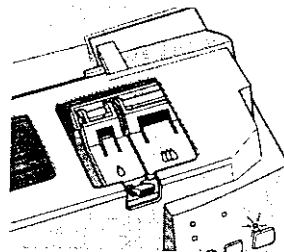

The print head moves slightly to the left, which is the black ink cartridge install position. The  power light flashes and the  black and  color ink out lights come on.

**Caution:**

Do not move the print head by hand. Otherwise you may damage the printer.



3. Lift up the black ink cartridge clamp.

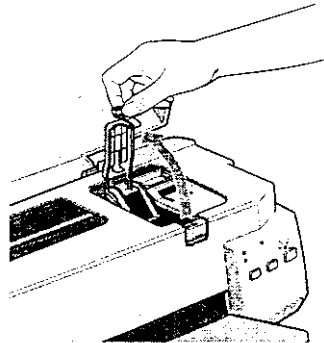

4. Open the ink cartridge packages that came with your printer.
Next, remove only the yellow tape seals from each cartridge.

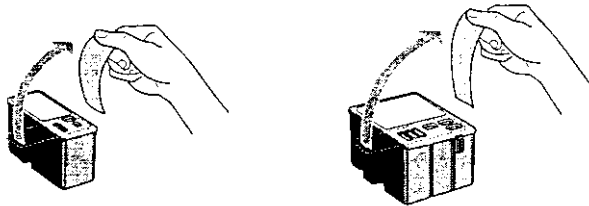

Caution:

- Remove the yellow tape seals from the cartridges before installing them; otherwise the cartridges may become unusable.
- Do not remove the blue portion of the tape seals from the cartridges; otherwise the cartridges may become clogged and cannot print.
- Do not remove the tape seals from the bottom of the cartridges; otherwise, ink will leak.

5. Place the black ink cartridge gently into their holders with the labels face-up. Do not press down on the cartridges.

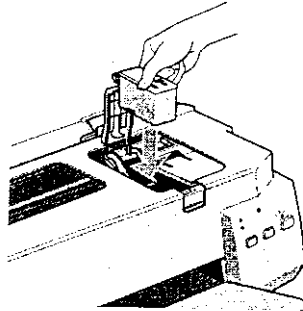
**Note:**

Install both ink cartridges. If either of the cartridges is not installed, the printer will not work.

6. Press the ink cartridge clamps down until they lock in place.

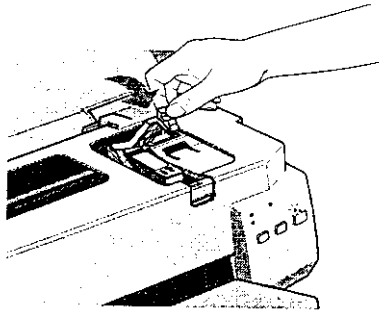
**Caution:**

Once you install the ink cartridges, do not open their clamps again until you replace the ink cartridges. Otherwise, the cartridges may become unusable.



7. Press the  cleaning button to install the color ink cartridge. The printer moves the print head to the color ink cartridge installation position.

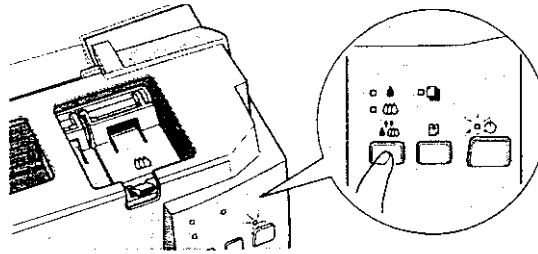

8. Lift up the ink cartridge clamp. Install the color ink cartridge as described in steps 5 and 6, substituting "color ink cartridge" for "black ink cartridge" where appropriate. Then go to step 9 to complete the ink cartridge installation.

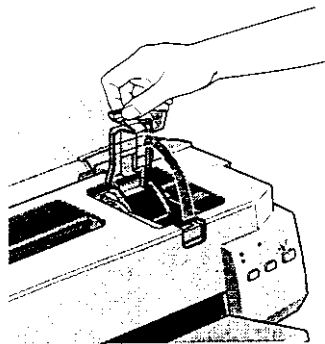

L

Lancaster
short.bk

A5 size
8/21/98

Rev.A

SETUP.FM
Pass 1

Proof Sign-off:



Y.Yano

N.Nomoto

K.Pipa

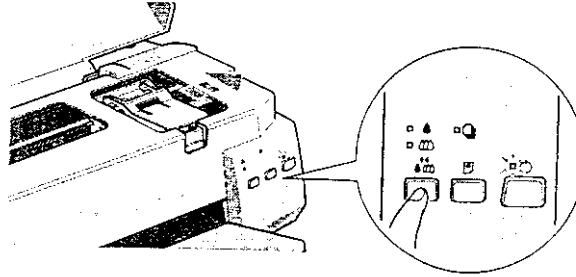
9. Press the  cleaning button. The printer moves the print head and begins charging the ink delivery system.



The ink charging process may take about one minute to complete, during which time the  power light flashes and the printer produces a variety of mechanical sounds. These sounds are normal. When the ink delivery system has been charged, the print head returns to its home (far right) position and the  power light comes on.



Caution:

Never turn off the printer while the  power light is flashing.

10. Close the printer cover.

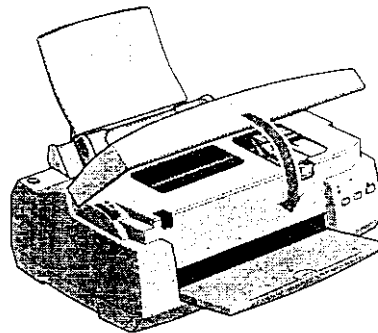



Now you are ready to connect the printer to your computer. To connect the printer to your PC, see the next section. To connect the printer to a Macintosh, see "Connecting the Printer to Your Macintosh" on page 22. If you plan to connect to your computer with a USB cable, follow the instructions in the *USB User's Guide* that came with your printer.

Connecting the Printer to Your PC

To connect the printer to your computer using the built-in parallel interface, you need a shielded, twisted-pair parallel cable.

Note:

*If you plan to connect with a USB cable, follow the instructions in the *USB User's Guide* that came with your printer.*

Follow these steps to connect your printer.

1. Make sure both the printer and computer are turned off.
2. Plug the cable connector securely into the printer's interface connector. Then squeeze the wire clips together until they lock in place on both sides. If your cable has a ground wire, connect it to the ground connector below the interface connector.

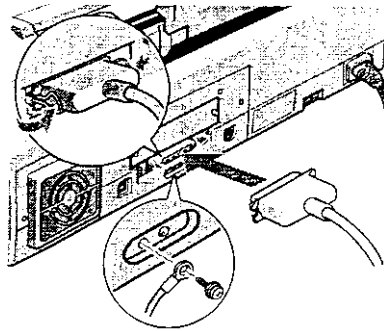

L

Lancaster
short.bk

A5 size
8/21/98

Rev.A

SETUP.FM
Pass 1

Proof Sign-off:

Y.Yano

N.Nomoto

K.Pipa

3. Plug the other end of the cable into the computer's parallel interface. If there is a ground wire at the computer end of the cable, connect it to the ground connector at the back of the computer.

Now see the next section for instructions on installing the printer software in your computer. You must install this software before using your printer.

Installing the Printer Software in Your PC

After connecting the printer to your computer, you need to install the software included on the "Printer Software for EPSON Stylus COLOR 900" CD-ROM shipped with your printer.

Your printer software includes:

- Printer driver**
The printer driver is the software that runs, or "drives," your printer. With it, you can make settings such as media type, print quality, speed, and paper size.
- Utilities**
The Nozzle Check, Head Cleaning, and Print Head Alignment utilities help you keep your printer in top operating condition.
- EPSON Status Monitor 2 (not for Windows 3.1)**
EPSON Status Monitor 2 notifies you of printer errors and displays printer status information such as the amount of ink remaining. The Status Monitor also guides you when replacing ink cartridges.

Proof Sign-off:
Y.Yano
N.Nomoto
K.Pipa

Lancaster
short.bk

A5 size
8/21/98

Rev.A

SETUP.FM
Pass 1

R

If you are using the floppy disk version of the software, make a backup copy of the EPSON printer software disk before you begin installation. If you wish to make a floppy disk version of the printer software on your CD-ROM, insert the printer software CD-ROM, (for Windows 3.1, then choose RUN from the File menu. In the Command Line box, type D:EPSETUP and click OK) then click the Driver disk creation utility button and follow the on-screen instructions.

Installing in Windows 95, 98, and NT 4.0

Follow the steps below to install the printer software in Windows 95, 98, and NT 4.0.

If you connected your printer using the USB interface, you need to install the EPSON USB Printer Device Driver and the printer software included in the printer software CD-ROM. Follow the instructions in the *USB User's Guide* that came with your printer.

1. Insert the printer software CD shipped with your printer in the CD-ROM drive. The Installer dialog box appears. (For floppy disk users, insert the disk in a disk drive. Then double-click the FD drive icon and double-click the Setup.exe icon.)

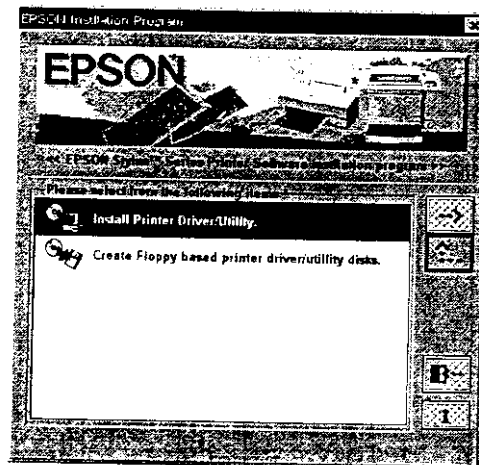

-
2. Click Install to start the printer software installation.
3. When the installation is complete, click OK.

EPSON Status Monitor 2 installation starts automatically. Follow the on-screen instructions.

Note:

- If the New Hardware Found screen or any other Wizard appears when you turn on your computer, click Cancel and follow the steps above.*
- Installation time varies depending on your computer.*

For information on opening and using the software, see "Printing Your First Page using Windows" on page 31. See also "Using the Printer Software for Windows" in the online Reference Guide.

If you use your printer on a network with Windows 95, 98, or NT 4.0, see "Network Printing" in the online Reference Guide.

Installing in Windows 3.1

Follow these steps to install the software in Windows 3.1.

1. Make sure Windows 3.1 is running and the Program Manager window is open.
2. Insert the printer software CD shipped with your printer in the CD-ROM drive. (If you use the floppy disk version, insert it in a disk drive.)

3. Choose Run from the File menu. The Run dialog box appears. In the Command Line box, type D:SETUP and click OK. If the CD-ROM drive has a drive letter other than "D" or if you are using the floppy disk version, substitute the appropriate letter.

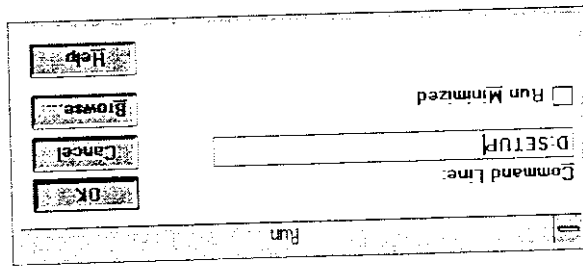

4. The installation program begins copying the printer software files.
 5. When the installation is complete, click OK to exit the installation program.
- The installation program automatically selects this printer as the default printer for Windows applications.
- For information on opening and using the software, see "Printing Your First Page using Windows" on page 31. See also "Using the Printer Software for Windows" in the online Reference Guide.

Connecting the Printer to Your Macintosh

To use the printer's built-in serial interface, you will need an Apple System Peripheral-8 cable.

Note:

- ❑ To connect to an iMac computer using the USB cable, follow the instructions in the USB User's Guide that came with your printer.
- ❑ If you want to use the optional LocalTalk Interface Card (C82312*) or Type B Ethernet Interface Card (C82357*), see "Using optional interface cards" on page 68.

Follow these steps to connect the printer.

1. Make sure both your printer and Macintosh are switched off.
2. Connect one end of the interface cable to the serial connector on the back of the printer.

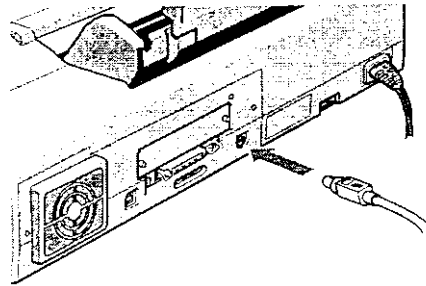

EPSON Monitors and manages background printing jobs. You must turn on background printing in the Chooser to use this utility.

Printer driver software that lets you use the printer on an AppleTalk network. With it, you can make settings such as media type, print quality, speed, and paper size.

Printer driver software that runs your printer if you are using the serial or USB interface. With it, you can make settings such as media type, print quality, speed, and paper size.

EPSON Printer Driver Package

Your printer software includes:

After connecting the printer to your Macintosh, you are ready to install the printer software included in the "Printer Software for EPSON Stylus COLOR 900" CD-ROM shipped with your printer.

Installing the Printer Software in Your Macintosh

Now see the next section for instructions on installing the printer software. You must install the printer software before using your printer.

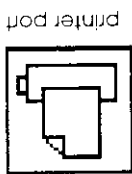

printer port



modem port

3. Connect the other end of the interface cable to either the modem port or printer port on the Macintosh. The ports are marked with the following icons.

StatusMonitor

Keeps track of the current status of your printer, and alerts you when printer errors occur.

Utilities

The Nozzle Check, Head Cleaning, and Print Head Alignment utilities help you keep your printer in top operating condition.

- Epson Namer**
Assigns a unique name to the printer so that you can use it on an AppleTalk network.
- ColorSync 2.0 and Profiles**
Matches the colors in your printout with the colors displayed on your screen automatically. Use this when printing scanned photographs or computer graphics.

If you are using the floppy disk version, make a backup copy of the EPSON Macintosh printer software disk before you begin installation.

**Caution:**

Turn off all virus protection programs before you install your printer software.

Follow these steps to install your printer software.

1. Turn on your Macintosh and insert the software CD in the CD-ROM drive. (If you use the floppy disk version, insert it in a disk drive.)
2. The EPSON printer software disk opens automatically.
3. If a single Installer icon appears, double-click the icon. If separate folders containing installer icons for several languages appear, double-click the folder for your preferred language, then double-click the Installer icon.

4. After the initial screen appears, click Continue. The following dialog box appears.

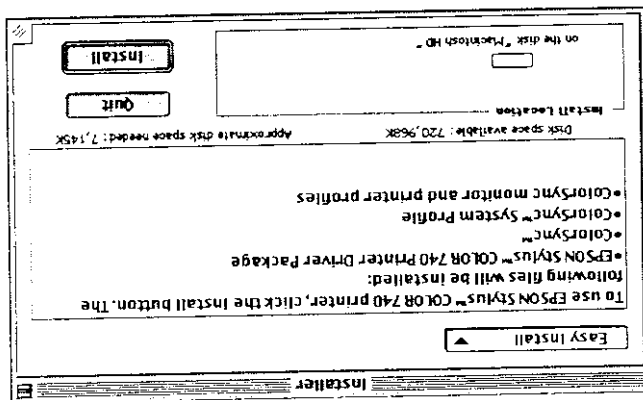

5. If you want to install all of the printer software included on your printer software CD-ROM, make sure the Install Location box shows the correct disk drive and click Install.

6. If you are low on disk space, select Custom Install from the pop-up menu and click Serial Driver Package. Confirm the destination for installation, then click Install.

Note:
Click the **I** icon to get information on each component.

7. When a message appears informing you that installation is finished, click Restart to complete the installation and restart your computer.

If you are going to use the optional LocalTalk Interface Card (C82312*) or Type B Ethernet Interface Card (C82357*), you need to assign a name to your printer using the EPSON Namer utility as described below. If you are using a serial interface, skip to "Selecting Your Printer in the Chooser" on page 26.

Assigning a name to the printer

Use the following procedure to assign a name:

1. Double-click the Epson Namer icon.

It is located on your hard disk drive if installed. If it is not installed, insert the printer software CD-ROM into your computer's CD-ROM drive and open the utility from there. (If you use the floppy disk version, insert it in a disk drive and open the utility from there.)

2. Click the SC900(AT) icon in the Device Types window.
3. If there are multiple AppleTalk zones at your site, select the zone where the printer is located.
4. Under New Name, enter a name for your printer. You should assign a name that clearly distinguishes your printer from others on the network.
5. Click Rename and then click Done to quit the EPSON Namer.

Selecting Your Printer in the Chooser

After you install the printer software, you need to open the Chooser to select your printer. You have to choose the printer the first time you use it or whenever you want to switch to another printer. Your Macintosh will always print using the last printer selected.

If you are using your computer's serial or USB interface, choose your printer driver as described in the following section, "Using a serial or USB interface connection" on page 27. If your system is connected to an AppleTalk network, see "Using the AppleTalk connection" on page 28.

Note:
If you are using a Macintosh Quadra 950 or 900, you need to choose Compatible in the Serial Switch dialog box before selecting your printer from the Chooser. To open the Serial Switch dialog box, choose Control Panel from the Apple menu, then choose Serial Switch.

Using a serial or USB interface connection

1. Make sure the printer is connected to your Macintosh and is turned on.
2. Choose Chooser from the Apple menu. Then click your printer's icon and the port your printer is connected to.

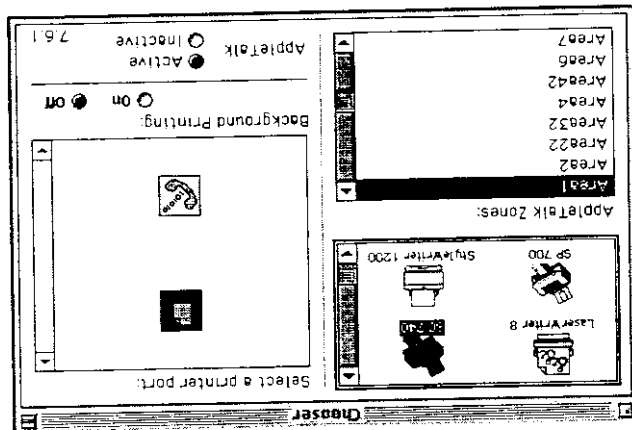

Note:

- If you are using an iMac computer, you must select the USB port.
- If you are using an AppleTalk network, an alert message may appear when you click the port. In this case, reselct the other port, or make the AppleTalk setting INACTIVE, then select the port again.

L

Lancaster
short.bk

A5 size
8/21/98

Rev.A

SETUP.FM
Pass 1

Proof Sign-off:

Y.Yano

N.Nomoto

K.Pipa

3. Click the Background Printing radio buttons to turn background printing on or off.

When background printing is on, you can use your Macintosh while it is preparing a document for printing. You must turn on background printing to use the EPSON Monitor3 utility to manage print jobs.

4. Close the Chooser.

For information on opening and using the software, see "Printing Your First Page using a Macintosh" on page 34. See also "Using the Printer Software for Macintosh" in the online Reference Guide.

Using the AppleTalk connection

1. Turn on your printer.
2. Choose Chooser from the Apple menu. Then click your printer's icon and select the AppleTalk zone you want to use. A list of all the printers connected to the selected zone appears on the right.

3. Click the name you assigned to your EPSON Stylus COLOR 900.
 4. Click the Background Printing radio buttons to turn background printing on or off.
When background printing is on, you can use your Macintosh while it is preparing a document for printing. You must turn on background printing to use the EPSON Monitor3 utility to manage print jobs.
 5. Close the Chooser.
- For information on opening and using the software, see "Printing Your First Page using a Macintosh" on page 34. See also "Using the Printer Software for Macintosh" in the online Reference Guide.

Loading Paper

Follow these steps to load A4 or Letter size plain paper.

You can also print on ink jet paper, photo-quality glossy film or paper, photo paper, transparencies, envelopes, index cards, and adhesive sheets. For details on using such media, see "Paper Handling" in the online Reference Guide.

1. Lower the output tray and slide out the extension. Next, slide the left edge guide so that the distance between the edge guides is slightly wider than the width of your paper.

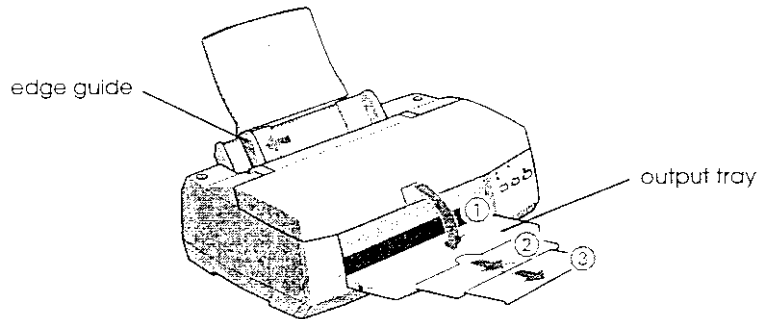

2. Fan a stack of paper; then tap it on a flat surface to even the edges.

3. Load the stack of paper with the printable side up and the right edge of the paper resting against the right side of the sheet feeder. Then slide the left edge guide against the edge of the paper.

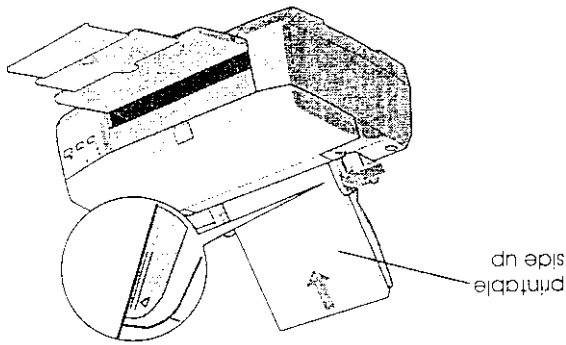

Note:

- Always load paper into the sheet feeder short edge first.
- Make sure the paper stack fits under the arrow mark inside the edge guide.

Printing Your First Page using Windows

After loading the paper, you are ready to print your first page. In order to check the operation of your printer, we recommend printing the README file provided with your printer software. The README file contains the latest information about your printer software.

If you choose to print your own document instead, select the appropriate Paper Size setting in your application software, then print the document as explained from step 3, below. (See your software manual for details on how to use your application.)

Follow these steps to print the README file.

1. Make sure A4 or Letter size paper is loaded in the printer.
2. Click Start, point to Programs, point to Epson (for Windows 95, and 98) or EPSON Printers (for Windows NT 4.0), and then click EPSON Stylus COLOR 900 Readme. If you are using Windows 3.1, open the EPSON program group from Program Manager and double-click EPSON Stylus COLOR 900 Readme.
3. Click Print on the File menu. The Print dialog box appears.
4. Make sure your printer is selected and then click Properties, or Options. You may need to click a combination of these buttons. The driver settings window appears.

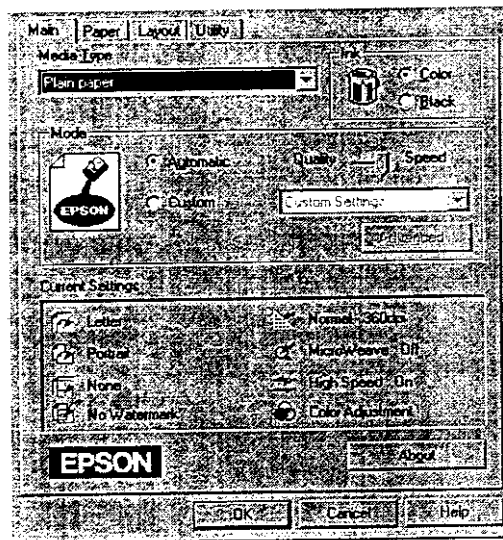

5. Click the Main tab if necessary, then click anywhere in the Media Type box and select Plain paper.
6. Select Color as the Ink setting.
7. Make sure the Mode option is set to Automatic.

When Automatic is selected, the printer software optimizes other settings according to the Media Type and Ink settings you make.

8. Click the Paper tab, then click anywhere in the Paper Size box and select the paper size you loaded in the printer.

9. Click OK at the bottom of the window. You return to the Print dialog box (or a similar dialog box).

10. Click Close, OK, or Print to print. You may need to click a combination of these buttons.

While printing, the EPSON Progress Meter (Windows 95, 98, and NT 4.0) or the EPSON Despooler dialog box (Windows 3.1) will appear, showing the printing progress and the status of your printer. For details, see "Monitoring and Managing Print Jobs for Windows" in the online Reference Guide.

After printing, check your results. If everything printed satisfactorily, your EPSON printer is now fully setup and ready to help you create wonderful printouts. If the printed image is unexpectedly faint or dots in the printed image are missing, you should check and clean the print head. See "Cleaning the Print Head" on page 49.

For further information about your printer, see the online *Reference Guide*. For details about the printer software, see online help. To learn more about color printing, see the online *Color Guide*.

Printing Your First Page using a Macintosh

After loading the paper, you are ready to print your first page. In order to check the operation of your printer, we recommend printing the README file located on your printer software CD. The README file contains the latest information about your printer software.

If you choose to print your own document instead, select the appropriate Paper Size setting in your application software, then print the document as explained from step 4, below. (See your software manual for details on how to use your application.)

Follow these steps to print the README file.

1. Make sure A4 or Letter size paper is loaded in the printer.
2. Insert the printer software CD.
3. Open the EPSON folder and double-click the README file.
4. Choose Page Setup from the File menu. The following dialog box appears.

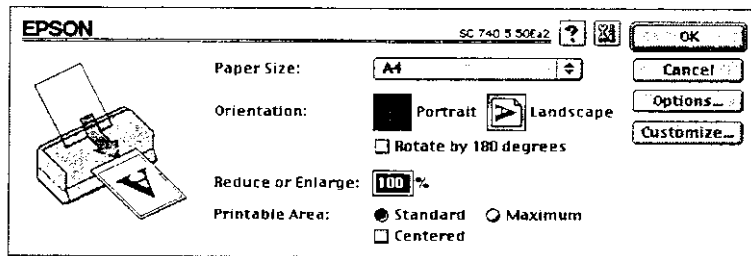

5. Select the paper size you loaded in the printer from the Paper Size list.
6. Select  Portrait as the Orientation option.

9. Select Plain Paper from the Media Type list.
 10. Select Color as the Ink option.
 11. Make sure the Mode option is set to Automatic.
- When Automatic is selected, the printer software optimizes other settings according to the Media Type and Ink settings you make.
12. Click Print to start printing.
- After printing, check your results. If everything printed satisfactorily, your EPSON printer is now fully setup and ready to help you create wonderful printouts. If the printed image is unexpectedly faint or dots in the printed image are missing, the print head may need cleaning. See "Cleaning the Print Head" on page 49.

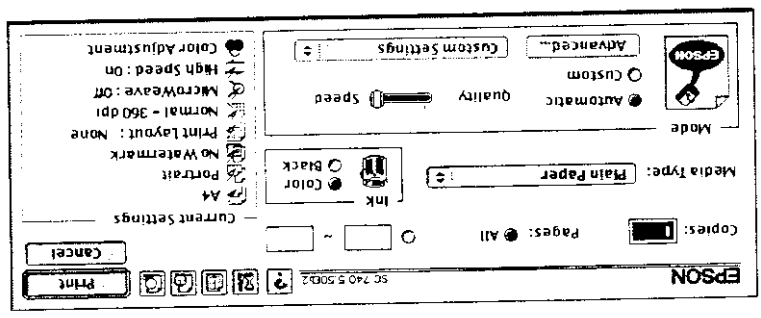

8. Choose Print from the File menu. The following dialog box appears.
- Note:*
You cannot print from the Page Setup dialog box. You can only print from the Print dialog box.
7. After making your settings, click OK to close the Page Setup dialog box.

L

Lancaster
short.bk

Rev.A

A5 size
8/21/98

SETUP.FM
Pass 1

Proof Sign-off:

Y.Yano _____

N.Nomoto _____

K.Pipa _____

For further information about your printer, see the online *Reference Guide*. For details about the printer software, see online help. To learn more about color printing, see the online *Color Guide*.



Loading Special Paper

You can print on a wide variety of special media, including ink jet paper, photo quality glossy film, photo paper, transparencies, envelopes, index cards, and adhesive sheets.

When loading special paper distributed by EPSON, read the instruction sheets packed with your special media first and keep the following in mind. For more details on using such media, see "Paper Handling" on page 93.

- Make sure the printable side of the paper is face up when loading media into the sheet feeder. See the instruction sheets packed with the media to determine which side is the printable surface. Some media have cut corners to help identify the correct loading direction, as shown in the illustration.

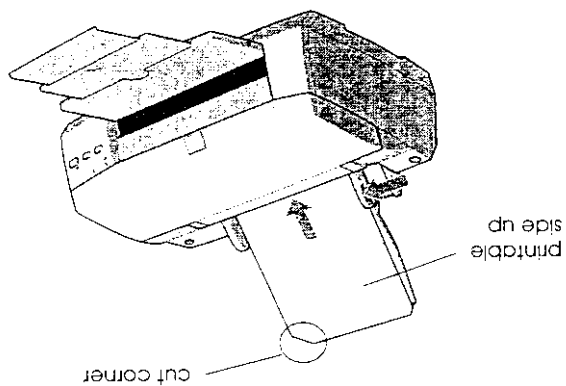

- Make sure the paper stack fits under the arrow mark located on the inside surface of the left edge guide.

- Loading capacity for envelopes and EPSON special media is explained below.

Envelopes

Up to 10 envelopes.

Note:

If the total thickness of the stack of envelopes exceeds 10 mm, press each envelope flat before loading.

360 dpi Ink Jet Paper
and Photo Quality Ink
Jet Paper

Up to the arrow mark on the left edge guide.

Photo Quality Ink Jet
Card, Ink Jet Note
Card, and Ink Jet
Greeting Card

Up to 30 index cards. Always place the included support sheet under the cards.

Photo Quality Glossy
Film

One sheet at a time for best results. Always put a support sheet* or a sheet of plain paper under the glossy film. If you wish to print with multiple sheets, load only up to 20 sheets and set the minimum top margin of the page to 30 mm.

Ink Jet Transparencies

Up to 30 transparencies. Always put a sheet of plain paper under the stack of transparencies.

Photo Quality Self
Adhesive Sheet

One sheet at a time.

Y. Yano
N. Nomoto
K. Pipa



short.bk

Rev.A
PAPER.FM
Pass 1

A5 size
8/21/98

Photo Paper

Up to 20 sheets. For 4 x 6 inch
Photo Paper, always put a
support sheet* under the
stack of Photo Paper.

One sheet at a time. Always
put the included Support
Sheets A and B under the
stack of Photo Stickers.

One sheet at a time.

Photo Stickers 16 and
Photo Sticker 4

Panoramic Photo Paper
and Iron-On Cool Peel
Transfer Paper

* Take care not to print on support sheets loaded under special media.

L

**Lancaster
short.bk**

A5 size
8/21/98

Rev.A

PAPER.FM
Pass 1

Proof Sign-off:





Y.Yano
N.Nomoto
K.Pipa

Replacing Ink Cartridges

Using the printer's control panel

The printer's indicator lights will inform you when it is time to obtain a replacement ink cartridge and when it is time to replace an empty cartridge.

This table describes the status of the lights on your printer and the actions you need to take.

Light	Action
	Replace the empty black ink cartridge.
	Obtain a replacement black ink cartridge (T003).
	Replace the empty color ink cartridge.
	Obtain a replacement color ink cartridge (T005).

■ = on, □ = flashing





Caution:

EPSON recommends the use of genuine EPSON ink cartridges. Other products not manufactured by EPSON may cause damage to your printer not covered by EPSON's warranties.

Leave the old cartridge installed in the printer until you have obtained a replacement. Otherwise, ink remaining in the print head nozzles may dry out.

Note:
You cannot continue printing with one ink cartridge empty, even if the other cartridge still contains ink. Before printing, replace the empty cartridge.

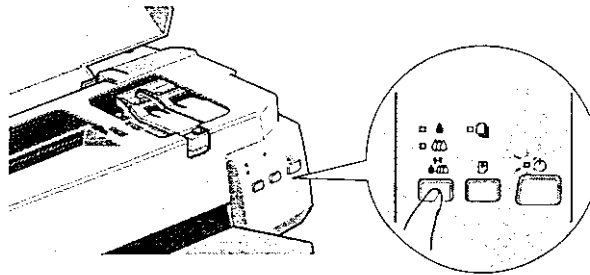

To replace an ink cartridge using the printer's control panel, follow these steps.

1. Make sure the printer is on. The  power light should be on, but not flashing. (Determine which cartridge needs to be replaced as indicated by the  black and  color ink out light.)
2. Lower the output tray at the front of the printer, then open the printer cover.
3. Hold down the  cleaning button for three seconds. The print head moves left, to the black or color cartridge replacement position depending on which ink is empty, and the  power light begins flashing.

**Caution:**

Do not move the print head by hand as this may damage the printer. Always use the  cleaning button to move it.

Note:

If you press the  cleaning button for three seconds when the  black and  color ink out lights are off, the printer starts cleaning the print head.



4. Lift up the clamp that holds the cartridge. The cartridge rises partly out of the cartridge holder.

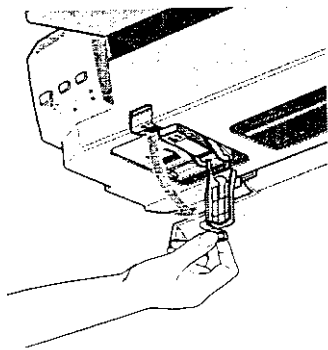

Caution:

Once you open the ink cartridge clamp, the ink cartridge becomes unusable and cannot be reinstalled, even if ink remains.



5. Lift the cartridge out of the printer and dispose of it properly. Do not take the used cartridge apart or try to refill it.

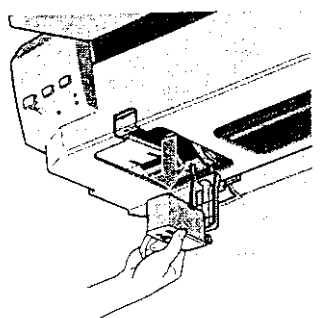

Warning:

If ink gets on your hands, wash them thoroughly with soap and water. If ink gets into your eyes, flush them immediately with water.



6. Remove the ink cartridge from its protective bag. Next, remove only the yellow tape seal from the cartridge.

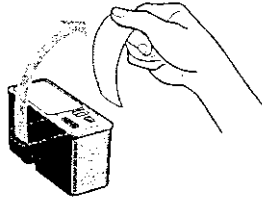

black ink cartridge (T003)

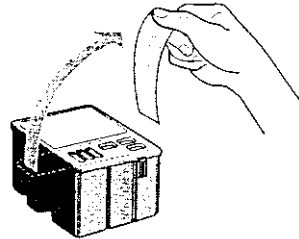

color ink cartridge (T005)

**Caution:**



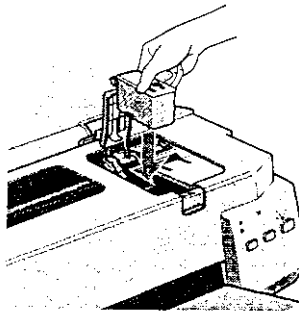

- You must remove the yellow tape seal from the cartridge. Leaving the tape on when you install the cartridge will permanently damage it.
 - Do not remove the blue portion of the tape seal from the top of the cartridge; otherwise, the cartridge may become clogged and cannot print.
 - Do not remove the tape seal from the bottom of the cartridge; otherwise, ink will leak.
7. Place the ink cartridge gently into the cartridge holder with the label on the cartridge facing up. Do not press down on the cartridge.

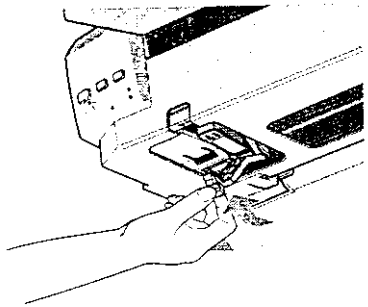

8. Press the ink cartridge clamp down until it locks in place.



Caution:  Once you install the ink cartridges, do not open their clamps again until you replace the cartridges. Otherwise, the cartridges may become unusable.

9. If you need to replace the color ink cartridge as well, press the  cleaning button. Then repeat steps 4 through 8.
10. Make sure the  black and  color ink out lights are off. Then press the  cleaning button. The printer moves the print head and begins charging the ink delivery system. This process takes about 1 minute to complete. When the ink charging process is finished, the printer returns the print head to its home position and the  power light stops flashing.

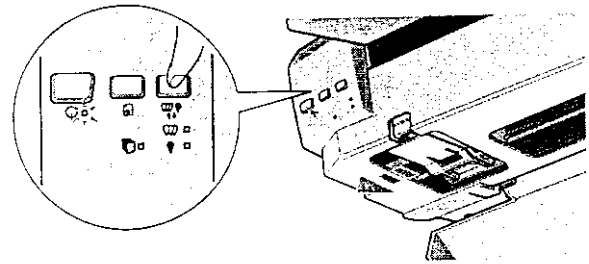

L

**Lancaster
short.bk**

A5 size
8/21/98

Rev.A

INK,FM
Pass 1

Proof Sign-off:

Y.Yano

N.Nomoto

K.Pipa



Caution:

The  power light continues to flash while the printer performs the ink charging operation. Never turn off the printer while this light is flashing. Doing so can result in incomplete charging of ink.

11. Close the printer cover.

Maintenance

Checking the Print Head Nozzles

If you find that the printed image is unexpectedly faint or dots in the printed image are missing, you may be able to identify the problem by checking the print head nozzles.

You can check the print head nozzles from your computer with the Nozzle Check utility in the printer software, or from the printer itself by using the printer's control panel buttons.

Using the Nozzle Check utility

Note:

Do not start the Nozzle Check utility while printing is in progress; otherwise your printout may be marred.



For Windows users

1. Make sure A4 or Letter size paper is loaded in the sheet feeder.
2. Click the Utility tab in the printer window, then click the Nozzle Check button.
3. Follow the messages on your screen.

For Macintosh users

1. Make sure A4 or Letter size paper is loaded in the sheet feeder.
2. Click the Utility icon button in the Print or Page Setup dialog box, then click the Nozzle Check button.
3. Follow the messages on your screen.

Using the control panel buttons

1. Make sure that A4 or Letter size paper is loaded in the sheet feeder.
2. Hold down the  load/eject button and press the  power button to turn on the printer. Then release both buttons.

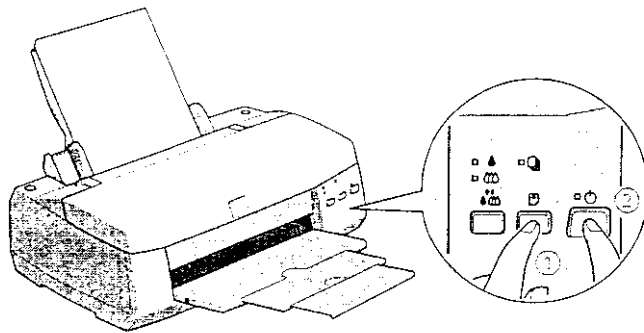

The printer prints an operation check page including your printer's ROM version information, the ink counter code, and a nozzle check pattern. Here are sample printouts.

The above sample is in black and white, but the actual test prints in color (CMYK).

If the nozzle check page does not print satisfactorily (for example, if any segment of the printed lines is missing) there is a problem with the printer. This could be a clogged ink nozzle or a misaligned print head. See the next section for details on cleaning the print head. For information on aligning the print head, see "Aligning the Print Head" on page 51.

Cleaning the Print Head

If you find that the printed image is unexpectedly faint or dots in the printed image are missing, you may be able to solve these problems by cleaning the print head, which ensures that the nozzles are delivering ink properly.

You can clean the print head from your computer with the Head Cleaning utility in the printer software, or from the printer itself by using the printer's control panel buttons.

Note:

- Print head cleaning uses both color and black ink. To avoid wasting ink, clean the print head only if print quality declines.

- Use the Nozzle Check utility to confirm that the print head needs to be cleaned. This saves ink.

- When the **black** or **color** ink out light is flashing or on, you cannot clean the print head. Replace the appropriate ink cartridge first.

- Do not start the Head Cleaning or Nozzle Check utility while printing is in progress; otherwise your printout may be marred.

Using the Head Cleaning utility

For Windows users

1. Make sure that both **black** and **color** ink out lights are off.



Note:

If the **black** or **color** ink out light is flashing, you can not clean the print head. Replace the appropriate ink cartridge first.



2. Click the Utility tab in the printer window, then click the Head Cleaning button.

3. Follow the messages on your screen.



For Macintosh users

1. Make sure that the printer is on, and the  black and  color ink out lights are off.
2. Click the Utility icon button in the Print or Page Setup dialog box, then click the Head Cleaning button.
3. Follow the on-screen messages.

Using the control panel buttons

1. Make sure that the  power light is on and that both the  black and  color ink out lights are off.

Note:

If the  black or  color ink out light is flashing or on, you cannot clean the head, and this operation will start the ink cartridge replacement procedure. If you do not want to replace an ink cartridge at this moment, press the  cleaning button to return the print head to its home position.

2. Hold down the  cleaning button for three seconds.

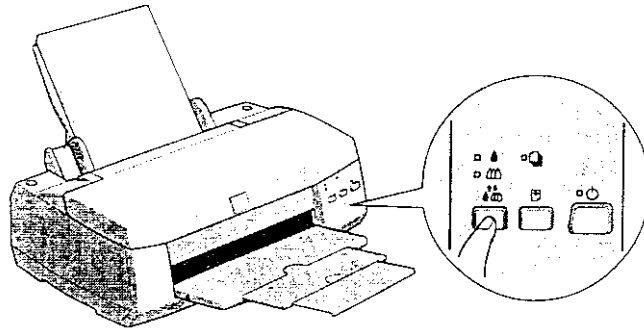

The printer starts cleaning the print head and the  power light begins flashing. Print head cleaning takes about one minute to complete.



Caution:

Never turn off the printer while the power light is flashing.
Doing so may damage the printer.

3. When the power light stops flashing, print a few lines from a document to confirm that the head is clean and to reset the cleaning cycle.

If print quality hasn't improved after repeating this procedure four or five times, turn the printer off and leave it alone overnight. Then do the head cleaning again.

If the print quality still has not improved, one or both of your ink cartridges may be old or damaged and may need to be replaced. To replace an ink cartridge before it is empty, see "Replacing an Old or Damaged Ink Cartridge" in the online Reference Guide.

If print quality remains a problem after replacing the ink cartridges, contact your dealer.

Note:

For constant best quality, it recommends to turn on the printer at least once a month.

Aligning the Print Head

If you notice a misalignment of vertical lines, you may be able to solve this problem from your computer using the Print Head Alignment utility in your printer software.

If you are using DOS, see "Aligning the print head" in your DOS User's Guide.

Note:

Do not start the Print Head Alignment utility while printing is in progress; otherwise your printout may be marred.

L

Lancaster
short.bk

A5 size
8/21/98

Rev.A

MAINT.FM
Pass 1

Proof Sign-off:

Y.Yano

N.Nomoto

K.Pipa

For Windows users

1. Make sure A4 or Letter size paper is loaded in the sheet feeder.
2. Click the Utility tab in the printer window, then click the Print Head Alignment button.
3. Follow the messages on your screen to align the print head.

For Macintosh users

1. Make sure A4 or Letter size paper is loaded in the sheet feeder.
2. Click the Utility icon button in the Print or Page Setup dialog box, then click the Print Head Alignment button.
3. Follow the messages on your screen to align the print head.

Troubleshooting

Error Indicators

You can identify many common printer problems with the lights on your printer's control panel. If your printer stops working and the lights are on or flashing, use the following table of panel light patterns to diagnose the problem, then follow the recommended corrective measures.

Problem and Solution	Lights
Paper Out Load paper in the sheet feeder; then press the \downarrow load/eject button to turn this light off. The printer resumes printing.	
Paper Jam Press the \downarrow load/eject button. The printer ejects the jammed paper and then resumes printing. If the error is not cleared, open the printer cover and remove the jammed paper then reload paper in the sheet feeder, and press the \downarrow load/eject button. The printer resumes printing.	
Ink Low (black ink cartridge) Obtain a replacement black ink cartridge (T003).	
Ink Out (black ink cartridge) Replace the black ink cartridge with a new one (T003). See "Replacing Ink Cartridges" on page 41.	

L

**Lancaster
short.bk**

A5 size
8/21/98

Rev.A





TRBLE.FM
Pass 1

Proof Sign-off:

Y.Yano

N.Nomoto

K.Pipa

	Ink Low (color ink cartridge)	
	The color ink cartridge is nearly empty.	Obtain a replacement color ink cartridge (T005).
	Ink Out (color ink cartridge)	
	The color ink cartridge is empty.	Replace the color ink cartridge with a new one (T005). See "Replacing Ink Cartridges" on page 41.
	Carriage Error	
	The print head carriage is caught by jammed paper or other foreign material and cannot return to the home position.	Turn off the printer. Open the printer cover and remove any paper from the paper path by hand. Then turn the printer back on. If the error is not cleared, contact your dealer.
	Unknown Printer Error	
	An unknown printer error has occurred.	Turn off the printer, and contact your dealer.

■ = on, □ = off, ◻ = flashing

Typical Problems and Solutions

Most printer problems have simple solutions. Define the problem from those below and apply the recommended solutions. For more information, see "Problem Solver" in the online Reference Guide.

Print quality problems

If you are having print quality problems, try the solutions offered here.

Horizontal banding

- Make sure the printable side of the paper is face up in the sheet feeder.
- Run the Head Cleaning utility to clear any clogged ink nozzles.



Vertical misalignment

- Make sure the printable side of the paper is face up in the sheet feeder.
- Run the Print Head Alignment utility.

- Turn off the High Speed setting in your printer driver. For instructions, see the printer driver's online help for Windows. For Macintosh, see "Using the Advanced settings" on page 96.

Color gaps

- Make sure your paper is not damaged, dirty, or too old.
- Run the Head Cleaning utility to clear any clogged ink nozzles.

- Check the  black and  color ink out lights. If a light is flashing, replace the ink cartridge. See "Replacing an Empty Ink Cartridge" on page 150.

Blurry or smeared printout

Try one or more of these solutions.

- Make sure the printable side of the paper is face up in the sheet feeder.
- Make sure your paper is not damaged, dirty, or too old.
- Set the adjust lever to the "+" position, and make sure the Media Type setting is set correctly in your printer driver.

Paper feed or paper jam problems

If the printer doesn't feed paper, feeds multiple pages, or paper is jammed, remove and reload the stack of paper, then press the  load/eject button. Also check the following:

- The paper isn't old or creased.
- Paper isn't loaded above the arrow on the left edge guide.
- The edge guides are set correctly.
- The paper isn't too thin or rough. Use paper that meets the paper requirements for this printer. See the online Reference Guide for paper specifications.

Canceling Printing

If the printouts are not what you expected, such as incorrect or garbled character or images, you may need to cancel printing. To cancel printing, follow the steps below.

For Windows

When you send a print job to the printer, the Progress Meter appears on your computer screen.

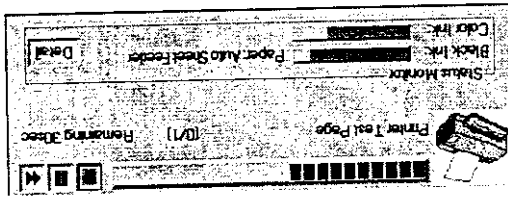



Click the  stop button to cancel printing.

For Macintosh

When background printing is on

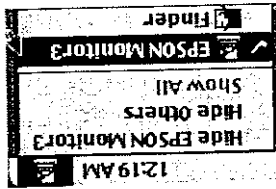

1. Press the  power button to turn off the printer.
2. Select EPSON Monitor3 from the application menu.

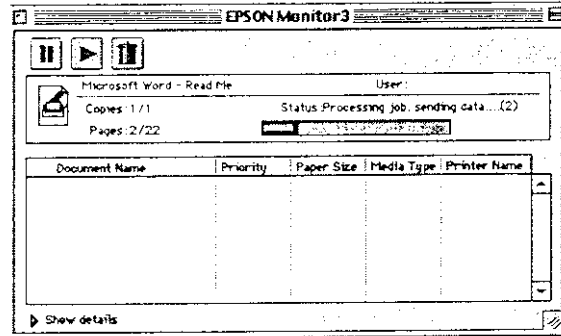

3. Click the  button, then click the  stop button to cancel the print job.



When background printing is off

1. Press the  power button to turn off the printer.
2. Hold down the  key on your keyboard and press the (period) key to cancel the print job.

Where to Get Help

If your printer is not operating properly and you cannot solve the problem using the troubleshooting information in your printer documentation, contact customer support services for assistance. Customer support will be able to help you much more quickly if you give them the following information.

Serial number of your printer
(The serial number label is on the back of the printer.)

Printer model

Brand and model of your computer

Printer software version

(Click About in your printer driver.)

Windows version you are using

Software application(s) you normally use with your printer and their version number(s)

For United Kingdom and the Republic of Ireland Users

If you purchased your printer in the UK or the Republic of Ireland, EPSON (UK) Limited provides a range of customer services and technical support.

World Wide Web

If you can connect to the Internet and have a Web browser, you can access our Web site at <http://www.epson.co.uk>. Here you will find information on the latest EPSON products, software drivers, on-line user guides, and answers to frequently asked questions.

L

**Lancaster
short.bk**

A5 size
8/21/98

Rev.A

TRBLE.FM
Pass 1

Proof Sign-off:

Y.Yano

N.Nomoto

K.Pipa

Faxon EPSON

Contact Faxon EPSON Faxback Service for support information including troubleshooting tips, switch settings, and driver information.

To use Faxon EPSON, call 01442 227332 in the UK or 0044 1442 227332 from the Republic of Ireland using a touch-tone phone. You will be asked to follow a simple routine to register your document request. Once you have entered your telephone and fax numbers, Faxon EPSON will fax a copy of the document catalogue to your fax machine.

When you have found the documents that you need in the catalogue, call Faxon EPSON again and enter the document ID numbers. The documents will be faxed to you automatically.

Bulletin Board Service for latest drivers and utilities

You can call the EPSON Bulletin Board Service on 01442 227479 in the UK or 0044 1442 227479 from the Republic of Ireland. No membership is required. Make sure that your communications software is set to 8 data bits, 1 stop bit, no parity bit, ANSI terminal mode emulation, and a modem speed of up to 28.8 Kbps. Downloading protocols supported include Xmodem, Ymodem and Zmodem. See the documentation that came with your communications software and modem for more information.

When you first connect to the Bulletin Board Service, you will be asked for your name, company name, phone number and a password (which you can invent yourself).

Proof Sign-off:
Y.Yano
N.Nomoto
K.Pipa

Lancaster
short.bk

A5 size
8/21/98

Rev.A

TRBLE.FM
Pass 1

R

Customer and Warranty Support

Our Customer and Warranty Support teams can be contacted by calling 0870 163 7766 in the UK or 0044 0870 163 7766 from the Republic of Ireland. They can provide the following services:

- Technical information on installing, configuring, and operating your EPSON products
- Arranging for faulty EPSON products to be repaired within the warranty period

A full list of EPSON Customer and Warranty Support services is available on the technical support section of our World Wide Web pages at <http://www.epson.co.uk/support/> and on Faxon EPSON Faxback service in document number 5085.

Pre Sales Enquiry Desk

The Enquiry Desk team can be contacted by calling 0800 220546 in the UK or 1 800 409132 from the Republic of Ireland, by faxing 01442 227271 in the UK or 0044 1442 227271 from the Republic of Ireland, and via Email at info@epson.co.uk. They can provide the following information:

- Pre Sales information and literature on new EPSON products (also available via our world wide web site at <http://www.epson.co.uk>)
- Where to purchase genuine EPSON consumables, accessories, and options

L

**Lancaster
short.bk**

A5 size
8/21/98

Rev.A

TRBLE.FM
Pass 1

Proof Sign-off:

Y.Yano
N.Nomoto
K.Pipa

For Australian Users

EPSON Australia wishes to provide you with a high level of Customer Service. As well as the user's guide, we provide the following sources for obtaining information:

EPSON FAXBACK

EPSON FAXBACK will fax you the latest specifications and pricing for most EPSON products offered in Australia. There is also technical information including details of the latest software and drivers available. Phone (02) 9903 9075 and the system will guide you through a number of choices before faxing the information to your fax machine.

EPSON Bulletin Board System

This is where you can download the latest software and drivers. Visit the BBS to check out the latest versions. If you have a modem, phone (02) 9417 5090.

Internet URL <http://www.epson.com.au>

Access the EPSON Australia World Wide Web pages. Worth taking your modem here for the occasional surf! You can get the same information as offered on the EPSON FAXBACK and the EPSON Bulletin Board plus more.

Your dealer

Don't forget that your dealer can often help identify and resolve problems. The dealer should always be the first call for advice on problems. They can often solve problems quickly and easily as well as give you advice on the next step to take.

Proof Sign-off:
Y.Yano _____
N.Nomoto _____
K.Pipa _____

Lancaster
short.bk

A5 size
8/21/98

Rev.A

TRBLE.FM
Pass 1

R

EPSON Helpdesk

EPSON Helpdesk is provided as a final backup to make sure our clients have access to advice. Operators on the Helpdesk can aid you in diagnosing hardware and software problems. They can also advise you on the latest EPSON products and where the nearest dealer or service agent is located. Many types of queries are answered here.

The Helpdesk numbers are:

Phone: (02) 9903 9040

Fax: (02) 9903 9189

We encourage you to have all the relevant information on hand when you ring. The more information you prepare, the faster we can help solve the problem. This information includes the *User's Guide* for your EPSON product, type of computer, operating system, application programs, and any other information you feel is required.

For Singapore Users

Contact the telephone and fax numbers below:

Phone: (065) 337-7911

Fax: (065) 334-1185

For Hong Kong Users

To obtain technical support as well as other after-sales services, users are welcome to contact EPSON Hong Kong Limited.

Internet home page

EPSON Hong Kong has established a local home page in both Chinese and English on the Internet to provide users with the following information:

L

**Lancaster
short.bk**

A5 size
8/21/98

Rev.A

TRBLE.FM
Pass 1

Proof Sign-off:

Y.Yano

N.Nomoto

K.Pipa

- Product information
- Answers to Frequently Asked Questions (FAQs)
- Latest versions of EPSON printer drivers

Users can access our World Wide Web home page at:
<http://www.epson.com.hk>

Electronic bulletin board system

An electronic bulletin board system (BBS) is also available to obtain printer information and the latest versions of printer drivers. You can log on to the following number for the BBS service:

BBS: (852) 2827-4244

Technical Support Hotline

You can also contact our technical staff at the following telephone and fax numbers:

Phone: (852) 2585-4399

Fax: (852) 2827-4383

For Philippines Users

To obtain technical support as well as other after sales services, users are welcome to contact the EPSON Philippines Representative Office at the telephone and fax numbers below:

Phone: (632) 813-6552

Fax: (632) 813-6545

BBS: (632) 814-0595

Options and Consumable Products

Options

The following interface cables and interface cards are available for your printer.

Interface cables

EPSON supplies several types of interface cables. You can use any interface cable that meets the following specifications. See your computer manual for any additional requirements.

- Parallel Interface Cable (shielded) C83602* from D-SUB 25-pin (computer) to 36-pin Amphenol 57 Series (printer)
- Serial Interface Cable C83603*/C83604* from D-SUB 25-pin (computer) to D-SUB 25-pin (printer)
- Serial Interface Cable C83605*/C83606* from D-SUB 9-pin (computer) to D-SUB 25-pin (printer)
- USB Interface Cable (shielded) C83623* from Series A 4-pin (computer) to Series B 4-pin (printer) (This cable is not supplied in all locations.)

Note:

The asterisk (*) is a substitute for the last digit of the product number, which varies by country.



Caution:

Use only the interface cables listed above. Using other cables not covered by EPSON warranties may cause the printer to malfunction.

L

**Lancaster
short.bk**A5 size
8/21/98**Rev.A**OPTION.FM
Pass 1

Proof Sign-off:

Y.Yano
N.Nomoto
K.Pipa_____

_____**Interface cards**

A number of optional interfaces are available to supplement the printer's built-in parallel and serial interfaces. See "Using optional interface cards" on page 68 for more information.

If you are not sure whether you need an optional interface or if you want to know more about interfaces, contact your dealer.

Serial Interface Card	C82305*/C82306*
32KB Serial Interface Card	C82307*/C82308*
32KB Parallel Interface Card	C80310*
32KB IEEE-488 Interface Card	C82313*
Twinax Interface Card	C82315*
Coax Interface Card	C82314*
LocalTalk Interface Card	C82312*
Type B Ethernet Interface Card	C82357*
Type B Bi-directional Parallel Interface Card	C82345*

Note:

The asterisk (*) is a substitute for the last digit of the product number, which varies by country.

Consumable products

The following ink cartridges and EPSON special media are available for your printer.

Proof Sign-off:

Y.Yano
N.Nomoto
K.Pipa

Lancaster
short.bk

A5 size
8/21/98

Rev.A

OPTION.FM
Pass 1

R

Ink cartridges

You can use the following cartridges with your printer.

Black ink cartridge	T003
Color ink cartridge	T005

EPSON special media

EPSON offers specifically designed media for ink jet printers to meet most high-quality printing needs.

EPSON 360 dpi Ink Jet Paper (A4)	S041059 S041025
EPSON 360 dpi Ink Jet Paper (Letter)	S041060 S041028
EPSON Photo Quality Ink Jet Paper (A4)	S041061 S041026
EPSON Photo Quality Ink Jet Paper (Letter)	S041062 S041029
EPSON Photo Quality Ink Jet Paper (Legal)	S041067 S041048
EPSON Photo Quality Ink Jet Card (A6)	S041054
EPSON Photo Quality Ink Jet Card (5 × 8")	S041121
EPSON Photo Quality Ink Jet Card (8 × 10")	S041122
EPSON Photo Quality Self Adhesive Sheet (A4)	S041106
EPSON Ink Jet Note Cards A6 (with envelopes)	S041147
EPSON Ink Jet Greeting Cards 5 × 8" (with envelopes)	S041148
EPSON Ink Jet Greeting Cards 8 × 10" (with envelopes)	S041149
EPSON Photo Quality Glossy Film (A4)	S041071
EPSON Photo Quality Glossy Film (Letter)	S041072
EPSON Photo Quality Glossy Film (A6)	S041107
EPSON Ink Jet Transparencies (A4)	S041063

EPSON Ink Jet Transparencies (Letter)	S041064
EPSON Photo Paper (A4)	S041140
EPSON Photo Paper (Letter)	S041141
EPSON Photo Paper (4 × 6")	S041134
EPSON Photo Paper Cards (A4)	S041177
EPSON Photo Stickers 16 (A6)	S041144
EPSON Photo Stickers 4 (A6)	S041176
EPSON Panoramic Photo Paper (210 × 594 mm)	S041145
EPSON Iron-On Cool Peel Transfer Paper (A4)	S041154
EPSON Iron-On Cool Peel Transfer Paper (Letter)	S041153 S041155

Note:

The availability of special media varies by country.

Using optional interface cards

Note the following when using optional interface cards.

- An optional LocalTalk or Ethernet interface card lets you use your printer on an AppleTalk network.
- To use the LocalTalk Interface Card (C82312*), you will need two LocalTalk Locking Connector Kits (DIN-8 version). Attach a connector box to the AppleTalk interface card on the printer and the other box to the printer port on the Macintosh. Then attach the LocalTalk cable between the two connector boxes. See the user's guide that comes with the connector kits for more details.
- To use the Type B Ethernet Interface Card (C82357*), see the user's guide that comes with the card for setup information.

Follow these steps to install an optional interface card.

1. Make sure the printer is turned off and all the printer's lights are off.
2. Unplug the power cord from the electrical outlet (and from the back of the printer, if your printer's power cord is removable).



Caution:
Do not install the interface card when the printer is connected to an electrical outlet. Doing so may damage the printer or your computer.

3. Turn the printer around so that its back faces you, and disconnect any existing interface cables.
4. Use a cross-head screwdriver to remove the two screws securing the shield plate to the optional interface slot; then lift off the plate. Be sure to keep both screws; you may need to use them again when you reinstall the shield plate.

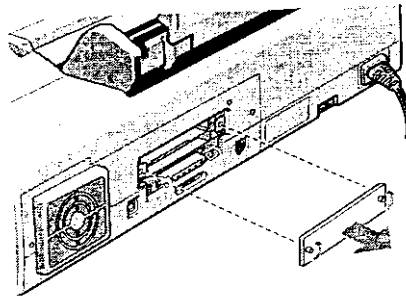

5. Be sure to set any switches and jumpers on the card. See the interface card's manual for details. If your interface card has a jumper labeled JG, make sure that you set it to on, or the card will not work properly.

6. Slide the interface card along the slots on both sides of the interface compartment. Push it in firmly to fully insert the connector at the rear of the interface card into the printer's internal socket.

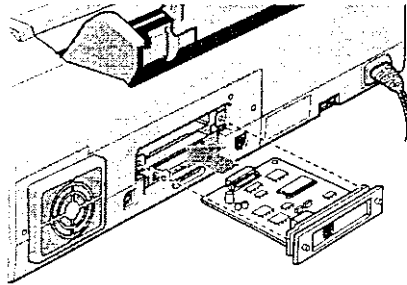

7. Secure the interface card in the slot with the two screws included with the interface card.
8. Connect the proper interface cable to the interface card and to your computer. If the cable has a grounding wire, connect it to one of the screws securing the parallel interface.

Also, if you are using more than one computer, reconnect the other interface cable.

9. Make sure the printer is turned off. Then plug in the power cord.

Proof Sign-off:
Yano _____
Nomoto _____
K.Pipa _____

Lancaster DOS
Rev. A

A5 size Dos.fm
8/20/98 Pass 1

R

DOS User's Guide

Installing the Printer Driver for DOS Programs	2
Changing the Print Settings	3
Using the default settings	4
Changing the default settings	7
Troubleshooting and Maintenance	10
Running a printer operation check.....	10
Problems and solutions	12
Ink cartridge problems.....	18
Cleaning the print heads	20
Aligning the print head	22
Cleaning the printer	23
Transporting the printer	24
Character Tables.....	25
International character sets	35
Characters available with ESC (^ command	36

Installing the Printer Driver for DOS Programs

Most DOS software programs include a driver for EPSON ESC/P 2™ printers, and require you to select the printer name from a list to install the printer driver. To take advantage of your printer's advanced built-in scalable fonts and graphics handling, you must select an appropriate driver.

If your printer is not included in the list, contact your software manufacturer to obtain updated software.

If the manufacturer does not have an updated printer driver for your printer, select an alternative printer name from those below, starting from the top.

When printing black only:

LQ-870/1170
LQ-570 (+)/1070(+)
SQ-870/1070
LQ-850
LQ-500

When printing black and color:

EPSON Stylus PRO
EPSON Stylus COLOR 500
EPSON Stylus COLOR II
LQ-860
LQ-2550

Note:

The drivers for the printers listed above do not provide all EPSON STYLUS COLOR 900 features, such as 720-dpi printing, 1440-dpi printing and MicroWeave.

DOS software varies greatly. See the printing section of your software manual for information on accessing the printer driver settings.

Proof Sign-off:
Yano _____
Nomoto _____
K.Pipa _____

Lancaster DOS Rev. A

A5 size
8/20/98

Dos.fm
Pass 1

R

Changing the Print Settings

You can change many print settings such as print direction and loading position. Because these settings take effect each time you turn on the printer, they are also called default settings.

The factory default settings are designed to meet the needs of most users, so you may not need to change them. The table below lists the features you can select in the default-setting mode.

Settings	Options
Print direction	Auto, Bi-D, Uni-D
Font	Courier, Roman, Sans Serif, Prestige, Script, Roman T, Sans Serif H, Draft
Pitch	10 cpi, 12 cpi, 15 cpi, 17.1 cpi, 20 cpi, Proportional
I/F mode	Auto, Parallel, Serial, Option
Auto I/F wait time	10 seconds, 30 seconds
Software	ESC/P 2, IBM X24E
Auto CR (IBM mode only)	Off, On
AGM (IBM mode only)	Off, On
Character table	Standard model: Italic, PC437, PC850, PC860, PC863, PC865, PC861, BRASCii, Abicomp, Roman 8, ISO Latin 1 All other models: Italic, PC437, PC437 Greek, PC850, PC853, PC855, PC852, PC857, PC866, PC869, MAZOWIA, Code MJK, ISO 8859-7, Bulgaria, ISO Latin 1T, PC774, Estonia, ISO 8859-2, PC866 LAT, PC866 UKR, PCAPTEC, PC708, PC720, PCAR864, PC860, PC861, PC865, PC858, ISO 8859-15
International character set for italic table	Italic U.S.A, Italic France, Italic Germany, Italic U.K, Italic Denmark1, Italic Sweden, Italic Italy, Italic Spain1
Auto line feed	Off, On
Network I/F mode	Off, On
Loading position	8.5 mm, 3 mm, Others
Economy	Off, On
Parallel I/F transfer rate	Fast, Normal

For more details, see the next section, "Using the default settings".
To change a setting, see "Changing the default settings" on page 7.

Note:

Most software controls the character table and auto line feed. If your software controls these features, you may never need to set them with the control panel.

Using the default settings

Print direction

Your printer has three direction settings: Auto, Bi-D, and Uni-D. Auto causes the printer to switch automatically between bidirectional (for text data) and unidirectional (for graphics data). Bi-D causes the print heads to print in both directions. This provides the fastest printing. Uni-D causes the print heads to print in one direction only. This provides maximum alignment for both graphics and character printing.

Note:

Most software controls this setting. If your software does, you may never need to set it with the control panel.

Font

Use this setting to select the default font.

Pitch

With this setting, you can specify the default character pitch (font size).

I/F (interface) mode

You may need to change the I/F mode so that your printer and computer can communicate properly. If you select Auto, the printer automatically selects the interface that is receiving data, and uses that interface until the end of the print job. This setting allows you to share the printer among multiple computers without changing the interface mode.

Check your computer documentation if you are not sure of the type of interface your computer requires.

Auto I/F (interface) wait time

If you select Auto as the I/F mode option, you can set the interface timeout to 10 seconds or 30 seconds. The printer does not accept data from another interface unless it receives no data from the current interface for the period set in Auto I/F wait time.

Software

Use this setting to specify the type of control codes you want to use to control the printer. If you select ESC/P 2, the printer emulates an EPSON ESC/P 2 printer. If you select IBM X24E, the printer operates as an IBM Proprinter™ X24E. If possible, select EPSON ESC/P 2 in your application programs. This will allow you to use the most advanced font and graphics handling available.

Auto CR

This feature is available when you select IBM X24E emulation as the Software setting. When Auto CR is on, the auto carriage return option performs a carriage-return line-feed (CR LF) operation whenever the print position exceeds the right margin. If this is off, the printer does not print characters beyond the right margin, and does not perform a linewrap until it receives a CR command.

AGM (Alternate Graphics Mode)

This feature is available when you select IBM X24E emulation as the Software setting. When AGM is on, the printer can use high-resolution 24-pin graphics commands. The default is off.

Character table

Character tables contain the characters and symbols used in different languages. The printer prints text based on the selected character table. For the available character tables, see "Character Tables" on page 25.

Auto line feed

When the Auto line feed feature is on, each carriage return (CR) code is accompanied by a line feed (LF) code. If your printed text is unexpectedly double-spaced, set this feature to Off. If text lines print on top of each other, set it to On.

Network I/F mode

If your printer is connected to a single computer, leave this feature off. If you want to share the printer with another computer, turn this feature on. When this feature is on, data may be present in the printer's buffer even though the printer is not printing. Always make sure the printer does not receive data before turning off the printer.

Loading position

If you want to print more lines on a page, set this feature to 3 mm. If you set the top margin with your software, that setting is added to the default-setting value.

Economy

When the Economy mode is on, the printer uses less ink by printing fewer dots per character. Use this mode for rough drafts only.

Parallel I/F transfer rate

This setting specifies the interface transfer rate. For most printing, leave this setting set to Fast. If you encounter problems, set it to Normal.



Changing the default settings

To change the printer's default settings, use the control panel buttons; the control panel lights show your selections.

1. Make sure the printer is turned off and A4 or Letter size paper is loaded in the sheet feeder.
2. Hold down the  cleaning button and turn on the printer to enter the default-setting mode.

The printer loads a sheet of paper and prints a brief summary and instructions. It instructs you to select the language that you want messages printed in (English, French, German, Italian, or Spanish).

3. Press the  cleaning button until the control panel lights indicate the language of your choice, as shown below.

Language			
English	<input type="checkbox"/>	<input type="checkbox"/>	<input checked="" type="checkbox"/>
French	<input type="checkbox"/>	<input checked="" type="checkbox"/>	<input type="checkbox"/>
German	<input type="checkbox"/>	<input checked="" type="checkbox"/>	<input checked="" type="checkbox"/>
Italian	<input checked="" type="checkbox"/>	<input type="checkbox"/>	<input type="checkbox"/>
Spanish	<input checked="" type="checkbox"/>	<input type="checkbox"/>	<input checked="" type="checkbox"/>
Portuguese	<input checked="" type="checkbox"/>	<input checked="" type="checkbox"/>	<input type="checkbox"/>

■ = On, □ = Off

4. Press the  load/eject button to print the current default settings and the next instructions in the language you selected. The printed instructions include submenu tables that list all of the settings you can change and show you how the control panel lights appear for each selection. Use the instruction sheets to change the settings from the control panel.

Lancaster DOS Rev. A

A5 size
8/20/98

Dos.fm
Pass 1

Proof Sign-off:

Yano _____

Nomoto _____

K.Pipa _____

5. After making your changes, exit the default-setting mode by turning off the printer.

Note:

You may exit the default-setting mode any time by turning off the printer. Any changes you have made remain in effect until you change them again.

If you want to check the current default settings, enter the default-setting mode again and print the current settings. Current settings are indicated with arrows.

Selecting fonts

Your printer has eight built-in character fonts including two EPSON fonts: EPSON Roman T and EPSON Sans Serif H.

(Roman T is similar to the Times™ font; Sans Serif H is similar to Helvetica™.)

To select a font, enter the default-setting mode. See "Changing the default settings" on page 7.

Note:

Font selections you make with your software override your printer's control panel selections. For best results, use your software to select fonts.

The table below shows the available fonts.

Fonts	Sample
EPSON Courier	
EPSON Roman T	
EPSON Sans Serif H	
EPSON Roman	
EPSON Sans Serif	
EPSON Prestige	
EPSON Script	
Draft	

Proof Sign-off:
Yano _____
Nomoto _____
K.Pipa _____

Lancaster DOS Rev. A

A5 size
8/20/98

Dos.fm
Pass 1

R

Note:

- Roman T and Sans Serif H fonts are available in proportionally spaced fonts only.*
- Some of the character tables might not be able to print with EPSON Roman T and EPSON Sans Serif H fonts. In these cases, selected character tables are printed with EPSON Roman.*

Scalable fonts

The size of the Roman, Sans Serif, Roman T, and Sans Serif H fonts can be selected from 8 to 32 points in 2-point increments through your software or by sending an ESC/P 2™ command. See the documentation that came with your software for information on selecting the size of scalable fonts.

EPSON
Roman

EPSON
Roman T

scalable sample

EPSON
Sans Serif

EPSON
Sans Serif H

Troubleshooting and Maintenance

This section describes what you can do if you are having problems printing. See also "Maintenance" and "Troubleshooting" in your *Setup & Daily Use* manual.

Running a printer operation check

Performing a printer operation check can help you determine whether the problem comes from the printer or the computer.

To print a printer operation check page, follow these steps.

1. Make sure both the printer and computer are turned off.
2. Unlock the wire clips on both sides of the interface connector, and remove the ground connector if necessary. Then disconnect the cable from the printer's interface connector.

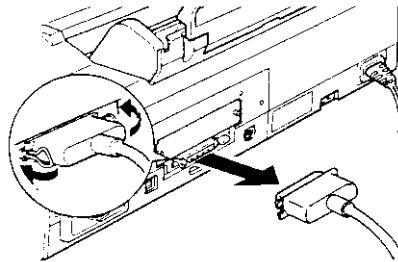

3. Make sure that A4 or Letter size paper is loaded in the sheet feeder.

Proof Sign-off:
Yano
Nomoto
K.Pipa





Lancaster DOS Rev. A

A5 size
8/20/98

Dos.fm
Pass 1

R

4. Hold down the  load/eject button and press the  power button to turn on the printer. Then release both buttons.

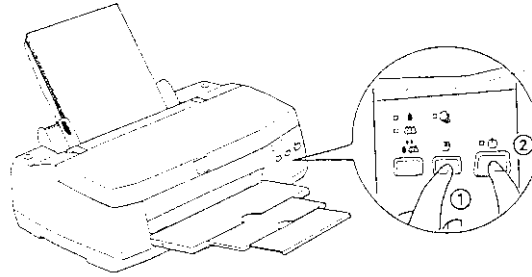

The printer prints an operation check page including the version of your printer's ROM, the ink counter code, the current code page, and a nozzle check pattern.

- If the operation check page results appear as shown in step 4, the printer itself is all right and the problem probably lies in the printer software settings, application settings, the interface cable (be sure to use a shielded cable), or the computer itself.

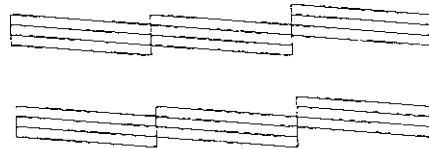

The above sample is in black and white, but the actual test prints in color (CMYK).

- If the operation check page does not print satisfactorily, for example, if any segment of the printed lines is missing, there is a problem with the printer. This could be a clogged ink nozzle or a misaligned print head.

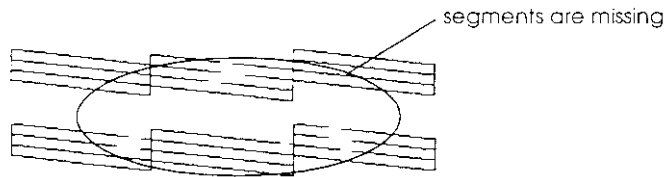

The above sample is in black and white, but the actual test prints in color (CMYK).

Problems and solutions



Most printer problems have simple solutions. Define the problem from those below and apply the recommended solutions.

Print quality problems

If you want to improve print quality, see the following problems and solutions.

Horizontal banding

Try one or more of these solutions:

- Make sure the printable side of the paper is face up in the sheet feeder.
- Clean the print heads to clear clogged ink nozzles. See "Cleaning the print heads" on page 20.
- Check the  black and  color ink out lights. If a light is flashing, replace an ink cartridge. See "Replacing Ink Cartridges" in your *Setup & Daily Use* manual.

Proof Sign-off:
Yano _____
Nomoto _____
K.Pipa _____

Lancaster DOS Rev. A

A5 size
8/20/98

Dos.fm
Pass 1

R



Vertical misalignment or banding

Try one or more of these solutions:

- Make sure the printable side of the paper is face up in the sheet feeder.
- Run the Print Head Alignment utility. See "Aligning the print head" on page 22.
- Clean the print heads to clear clogged ink nozzles. See "Cleaning the print heads" on page 20.

Color gaps

Try one or more of these solutions:

- Make sure your paper is not damaged, dirty, or old. Also, make sure the printable side of the paper is face up in the sheet feeder.
- Clean the print heads to clear clogged ink nozzles. See "Cleaning the print heads" on page 20.
- Check the  black and  color ink out lights. If a light is flashing, replace an ink cartridge. See "Replacing Ink Cartridges" in your *Setup & Daily Use* manual.

Incorrect or missing colors

Try one or more of these solutions:

- Make sure the printable side of the paper is face up in the sheet feeder.
- Clean the print heads. See "Cleaning the print heads" on page 20. If colors are still incorrect or missing, replace the ink cartridge.

Blurry or smeared printouts

Try one or more of these solutions:

- Make sure the paper is dry and the printable side is face up.
- If you're printing on thick media, such as envelopes or cards, set the adjust lever to the "+" position.
- If you're printing on glossy media or transparencies, place a support sheet (or a piece of plain paper) beneath the stack, or load one sheet at a time.
- Clean the print heads. See "Cleaning the print heads" on page 20.
- Run the Print Head Alignment utility. See "Aligning the print head" on page 22.
- Ink may have leaked inside the printer; wipe the inside of the printer as shown below with a soft, clean cloth.

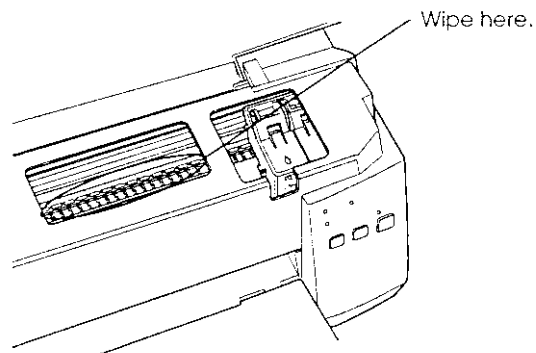

Printouts are not what you expected

If any of the following problems have occurred, see the solutions given below.

Incorrect or garbled characters

Turn off the printer and computer. Make sure the printer's interface cable is plugged in securely.

Proof Sign-off:
Yano
Nomoto
K.Pipa

Lancaster DOS
Rev. A

A5 size
8/20/98

Dos.fm
Pass 1

R

Incorrect margins

Check the margin settings in your application software.

Printing is too slow

Try one or more of these solutions:

- Don't run too many applications at the same time. Close any applications you are not currently using.
- Delete unnecessary files to make room on your hard disk drive.

Printer does not print

If any of the following problems have occurred, see the solutions given below.

All lights are off

- Press the  power button and make sure the printer is on.
- Turn off the printer and make sure the power cord is plugged in securely.
- Make sure the power outlet is working and is not controlled by a wall switch or timer.

Lights came on and then went out

The printer's voltage may not match the outlet rating. Turn off the printer and unplug it immediately. Then, check the printer labels.

If the voltage doesn't match, **DO NOT PLUG YOUR PRINTER BACK IN**. See "Where to Get Help" in your *Setup & Daily Use* manual.

Only the power light is on

Try one or more of these solutions:

- Turn off the printer and computer. Make sure the printer's interface cable is plugged in securely.
- Make sure there's no packing material in the printer.



- Turn off the printer and computer and disconnect the printer's interface cable. Then print an operation check page. See "Running a printer operation check" on page 10.
- If it prints, make sure the printer software and your application software is installed correctly.

Note:





If you're trying to print a large image, your computer may not have enough memory to print.

- If the above doesn't work, replace the ink cartridges. See "Replacing Ink Cartridges" in your *Setup & Daily Use* manual.

Paper out light is flashing or on

- If the  paper out light is flashing, remove the jammed paper.
- If the  paper out light is on, load more paper in the sheet feeder.

One of the ink out lights is flashing or on

- If the  black or  color ink out light is flashing, ink is low. Prepare a replacement cartridge.
- If the  black or  color light is on, ink is out. Replace the corresponding cartridge. See "Replacing Ink Cartridges" in your *Setup & Daily Use* manual.

All lights are flashing

Follow these steps.

1. Remove any paper in the printer.
2. Turn the printer off, wait a few seconds, and then turn it on again.
3. If the lights still flash, turn the printer off and check the inside of the printer for any foreign objects or pieces the paper. Remove all foreign objects and paper, then turn on the printer again.
4. If the lights still flash, contact EPSON. See "Where to Get Help" in your *Setup & Daily Use* manual.

Proof Sign-off:
Yano _____
Nomoto _____
K.Pipa _____

Lancaster DOS Rev. A

A5 size
8/20/98

Dos.fm
Pass 1

R

Paper doesn't feed correctly

If any of the following problems have occurred, see the solutions below.

Paper doesn't feed

Remove the stack of paper and check that:

- The paper isn't curled or creased.
- The paper isn't too old. See the instructions that came with the paper for more information.
- The paper isn't loaded above the arrow on the left edge guide.
- The paper isn't jammed inside. If it is, remove the jammed paper.

Multiple pages feed

Remove the stack of paper and:

- Make sure the paper is not too thin.
- Fan the edges of the stack to separate the sheets, then reload the paper.

The paper jams

Turn off your printer, open the cover, and remove all the paper from inside, including any torn pieces. Then load the paper again.

If the paper jams frequently, make sure you:

- Use smooth, high-quality paper, loaded with the printable side up.
- Fan the stack before loading it.
- Don't load paper above the arrow mark on the left edge guide.
- Adjust the left edge guide to fit your paper.

Paper isn't ejected fully or is wrinkled

Try one or more of these solutions:

- If the paper doesn't eject fully, press the \uparrow load/eject button. Also check the paper size setting in your application or printer driver.
- If the paper is wrinkled when it comes out, it may be damp or too thin. Load a new stack.

Note:

Store any unused paper in its original package in a dry area.

Ink cartridge problems

If output quality does not improve even after cleaning and aligning the print head, you may need to replace one or both of the ink cartridges.

To replace an ink cartridge before the \blacktriangle black or \blacklozenge color ink out light flashes, follow these steps:

If the \blacktriangle black or \blacklozenge color ink out light is flashing or is on, replace the empty ink cartridge as described in "Replacing Ink Cartridges" in your Setup & Daily Use manual.

Caution:



- Once you remove an ink cartridge, it becomes unusable and cannot be reinstalled even if ink remains.
- Leave the old cartridge installed in the printer until you are ready to replace it with a new one.

1. Make sure the printer is on. The \odot power light should be on, but not flashing.
2. Lower the output tray; then open the printer cover.

3. Hold down the load/eject button for five seconds; the print head moves to the black ink cartridge replace position. The power light begins flashing.

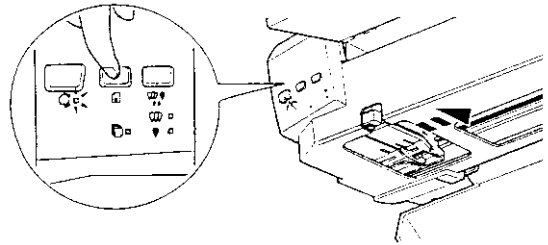

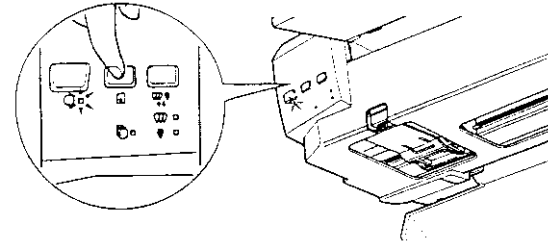

4. If you need to replace only the color ink cartridge, press the load/eject button to move the print head to the color ink cartridge replace position.



5. Lift the ink cartridge clamp. Then lift the cartridge out of the printer and dispose of the empty ink cartridge properly.
6. Remove the yellow tape seal from the new cartridge.
7. Place the cartridge gently into the cartridge holder. Do not press down on the cartridge.
8. Press the ink cartridge clamp down until it locks in place.



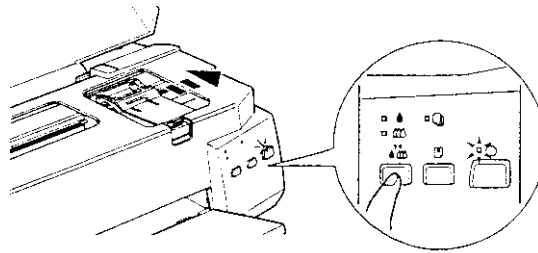

Caution: Once you install the cartridges, do not open their clamps again until you replace the ink cartridges. Otherwise, the cartridges may become unusable.

9. If you need to replace the color ink cartridge as well, press the  load/eject button. Then repeat steps 5 through 8.
10. Press the  cleaning button again. The printer moves the print head back to its home position and charges ink in the system.





Caution:

The  power light continues to flash while the printer performs the ink charging operation. Never turn off the printer while the  power light is flashing. Doing so can result in incomplete charging of ink.



Cleaning the print heads

If print quality diminishes, use the printer's built-in print head cleaning cycle to ensure that the nozzles are delivering ink properly.

To avoid wasting ink, clean the print head only if print quality declines.

1. Make sure that the printer is on and the  black and  color ink out lights are off.

Note:

The print head cannot be cleaned if the  black or  color ink out light is flashing or on. Replace the ink cartridges as needed before proceeding.



2. Hold down the  cleaning button for three seconds.

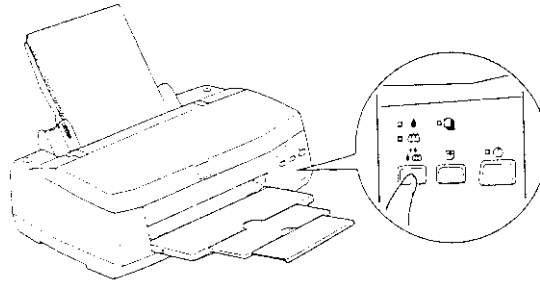

3. The printer starts cleaning the print head and the  power light begins flashing. Print head cleaning takes about one minutes to complete.



Caution:

Never turn off the printer while the  power light is flashing. Doing so may damage the printer.

4. When the  power light stops flashing, print a few lines from a document to confirm that the head is clean and reset the cleaning cycle.

If the print quality does not improve, repeat step 2, then print a few lines to check the output. If print quality hasn't improved after repeating this procedure four or five times, see "Problems and solutions" on page 12. If print quality still has not improved after following the recommendations listed in the troubleshooting section, contact your dealer.

Aligning the print head

If you find that the printed image is fuzzy or the vertical lines in your printout are not properly aligned, you may need to align the print head with the EPSON Print Head Alignment Utility. This utility aligns the print head to print images clearly. You may need to align the print head when you transport the printer or move it to a different place.

To use this utility, follow these steps.

1. Insert the EPSON Printer Software CD-ROM into your CD-ROM drive.
2. Type D:\SETUP at the DOS prompt. (If your CD-ROM driver has a different drive letter, or if you are using the floppy version, substitute the appropriate letter for D:\.)
3. Follow the directions on the screen. After running the setup program, change to the drive and directory that contains the utility (or set the path to the directory).
4. Type EPCALIB2 and press Enter. The following window appears.

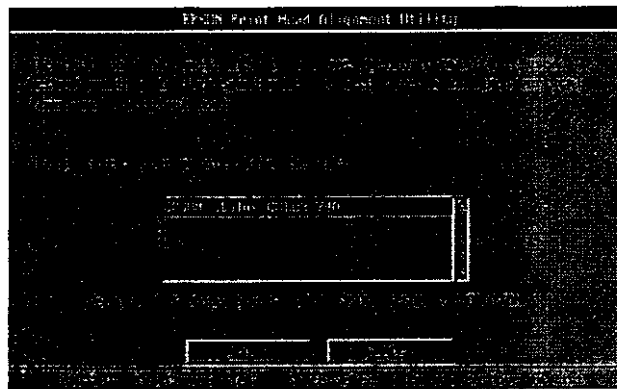

5. Make sure your printer is selected. Click Next, then follow the directions on the screen.

Cleaning the printer

To keep your printer operating at its best, clean it thoroughly several times a year.

1. Make sure the printer is turned off and all the printer's lights are off. Then unplug the power cord.
2. Remove any paper from the sheet feeder.
3. Use a soft brush to carefully clean away all dust and dirt.
4. If the outer case or the inside of the sheet feeder is dirty, clean it with a soft, clean cloth dampened with mild detergent. Keep the printer cover closed to prevent water from getting inside.
5. If the inside of the printer is accidentally soiled with ink, wipe it out with a damp cloth.



Warning:

Be careful not to touch the gears inside the printer.



Caution:

- Never use alcohols or thinners to clean the printer; these chemicals can damage the components as well as the case.*
- Be careful not to get water on the printer mechanism or electronic components.*
- Do not use a hard or abrasive brush.*
- Do not spray the inside of the printer with lubricants; unsuitable oils can damage the mechanism. Contact your dealer or a qualified service person if lubrication is needed.*

Transporting the printer

If you need to transport your printer a significant distance, carefully repack it using the original box and packing materials as follows:

1. Open the printer cover and make sure that the print head is in the home (far right) position. If not, turn on the printer and wait until the print head returns to the home position. Then turn off the printer and close the printer cover.



Caution:

Leave the ink cartridges installed during transportation, otherwise the printer may be damaged.

2. Unplug the power cord from the electrical outlet; then disconnect the interface cable from the printer.
3. Remove the paper from the sheet feeder and remove the paper support.
4. Push in the output extension tray, and then raise the output tray.
5. Attach the protective materials to the printer.
6. Repack the printer and power cord in the original box.
7. Keep the printer level during transport.

Proof Sign-off:
Yano
Nomoto
K.Pipa

Lancaster DOS
Rev. A

A5 size
8/20/98

Dos.frm
Pass 1

R

Character Tables

These character tables are selected with the default-setting mode or by using software commands.

All tables except the italic character table are the same as the PC437 table for hex codes 00 through 7F, so only the PC437 table is shown in its entirety. The rest of the tables show only the characters for hex codes 80 through FF.

The tables with an asterisk (*) after the table name are only available in certain areas.

PC437 (U.S./Standard Europe)

L

**Lancaster DOS
Rev. A**

A5 size
8/20/98

Dos.fm
Pass 1

Proof Sign-off:
Yano
Nomoto
K.Pipa

PC850(Multilingual)

PC860(Portuguese)

PC861(Icelandic)

PC863(Canadian-French)

Proof Sign-off:

Yano _____

Nomoto _____

K.Pipa _____

Lancaster DOS

Rev. A

A5 size
8/20/98

Dos.fm
Pass 1

R

PC865(Nordic)

BRASCII

Abicomp

Roman 8

L

Lancaster DOS
Rev. A

A5 size
8/20/98

Dos.fm
Pass 1

Proof Sign-off:

Yano

Nomoto

K.Pipa

ISO Latin 1

*PC437Greek(Greek)**

*PC852(East Europe)**

*PC853(Turkish)**

Proof Sign-off:

Yano

Nomoto

K.Pipa

Lancaster DOS

Rev. A

A5 size
8/20/98

Dos.fm
Pass 1

R

*PC855(Cyrillic)**

*PC857(Turkish)**

*PC866(Russian)**

*PC869(Greek)**

L

Lancaster DOS
Rev. A

A5 size
8/20/98

Dos.fm
Pass 1

Proof Sign-off:

Yano

Nomoto

K.Pipa

*MAZOWIA(Polish)**

*Code MJK (CSFR)**

*ISO 8859-7 (Latin/Greek)**

*ISO Latin 1T (Turkish)**

Proof Sign-off:

Yano _____

Nomoto _____

K.Pipa _____

Lancaster DOS

Rev. A

A5 size
8/20/98

Dos.fm
Pass 1

R

*Bulgaria**

*PC774 (LST 1283: 1993)**

*Estonia**

*ISO 8859-2**

Proof Sign-off:

Yano

Nomoto

K.Pipa

Lancaster DOS

Rev. A

A5 size

8/20/98

Dos.fm

Pass 1

R

*PC866 LAT. (Latvian)**

*PC866 UKR**

*PC APTEC(Arabic)**

*PC708(Arabic)**

Proof Sign-off:
Yano
Nomoto
K.Pipa

Lancaster DOS
Rev. A

A5 size
8/20/98

Dos.fm
Pass 1

R

PC720(Arabic)*

PC AR864(Arabic)*

PC858*

ISO 8859-15*

L

Lancaster DOS
Rev. A

A5 size
8/20/98

Dos.fm
Pass 1

Proof Sign-off:

Yano

Nomoto

K.Pipa

Italic

No characters are available for hex
code 15 in the italic character table.

Proof Sign-off:
Yano _____
Nomoto _____
K.Pipa _____

Lancaster DOS
Rev. A

A5 size
8/20/98

Dos.fm
Pass 1

R

International character sets

You can select one of the following international character sets with the default-setting mode or the ESC R command. For example, when you select "Italic France," the characters in the "France" row on the table below are used in the italic character table.

The following eight international character sets can be selected with the default-setting mode or with the ESC R command.

The following seven additional sets can be selected only with the ESC R command.

L

**Lancaster DOS
Rev. A**

A5 size
8/20/98

Dos.fm
Pass 1

Proof Sign-off:

Yano

Nomoto

K.Pipa

Characters available with ESC (^ command

To print the characters in the table below, use the ESC (^ command.
The characters in the right table are available with PC864 (Arabic),
PC AR864 (Arabic), and PC APTEC (Arabic).

Proof Sign-off:
Yano _____
Nomoto _____
K.Pipa _____

Lancaster DOS
Rev. A

A5 size
8/20/98

Dos.fm
Pass 1

R

EPSON

Proof Sign-off:
Y. Yano
N. Nomoto
K. Pipa

Lancaster USB Guide Rev.A

A5 size
8/21/98

Usb.fm
Pass 1

R

USB User's Guide

Read this guide if using a shielded USB cable to connect
your EPSON printer to your computer.

400xxxx
xxx-00

Proof Sign-off:
Y. Yano
N. Nomoto
K. Pipa

Lancaster USB Guide
Rev.A

A5 size
8/21/98

Usb.fm
Pass 1

R

System Requirements

To use your printer through the printer's built-in USB port, you need the following:

- Microsoft® Windows 98® pre-installed PC equipped with a USB port, or an Apple® iMac® computer.
- USB Interface Cable (shielded) C83623* from Series A 4-pin (computer) to Series B 4-pin (printer)



Caution:

Using other cables not covered by EPSON warranties (especially cables more than 1.8 meters long) may cause the printer to malfunction.

Note:

- The asterisk (*) is a substitute for the last digit of the product number, which varies by country.
- This cable may not be available in some countries.
- For PC's, 10MB of hard disk space to install the USB Printer Device Driver and the printer software
- For iMac computers, ??MB of hard disk space to install the printer software

L

Lancaster USB Guide Rev.A

A5 size
8/21/98

Usb.fm
Pass 1

Proof Sign-off:
Y.Yano
N.Nomoto
K.Pipa

Connecting the USB Cable

Follow the steps below to connect your printer.

Note:

- Install the ink cartridges before connecting the cable. See your printer manual.
 - For PC's, make sure that the Universal Serial Bus Controller is working properly in the Device Manager before connecting the USB cable. See your computer documentation for details.
1. Plug the appropriate end of the shielded USB cable into the USB port on the back of the printer. (The end of the cable that fits the printer is a different shape than the end that fits the computer.)

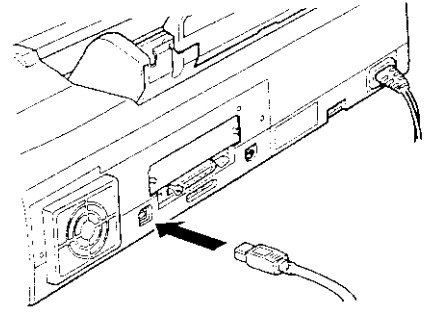

2. Plug the other end into the computer's USB port.

Note:

If you use a USB hub, EPSON recommends connecting the printer to the first tier of the hub, otherwise the printer may malfunction. If the printer does not work properly with the USB hub, connect the printer directly to the computer's USB port.

Proof Sign-off:
Y.Yano
N. Nomoto
K.Pipa

Lancaster USB Guide Rev.A

A5 size
8/21/98

Usb.fm
Pass 1

R

After connecting the printer to a PC, you must install the EPSON USB Printer Device Driver and the printer software. See "Installing the USB Software in Windows" on page 6.

After connecting the printer to an iMac computer, you must install the printer software and select the USB port for your printer in the Chooser. See "Installing the Printer Software in Your Macintosh" and "Selecting Your Printer in the Chooser" in the *Setup & Daily Use* guide.

L

**Lancaster USB Guide
Rev.A**

A5 size
8/21/98

Usb.fm
Pass 1

Proof Sign-off:
Y.Yano _____
N. Nomoto _____
K.Pipa _____

Installing the USB Software in Windows

The USB Printer Device Driver is included in the Printer Software CD-ROM shipped with your printer.

The installation program for the USB Printer Device Driver also allows you to install the printer software. You do not need to install the printer software separately.

1. Make sure Windows 98 is running.
2. Turn on your printer. The following dialog box appears.

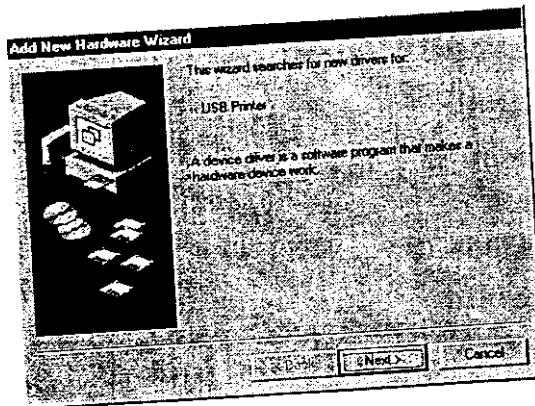

3. Click Next and follow the instructions on the screen.

- When the following dialog box appears, click Specify a location and type D:\win98 (if your CD-ROM drive has a drive letter other than "D", substitute the appropriate letter). Insert the printer software CD-ROM, then click Next.

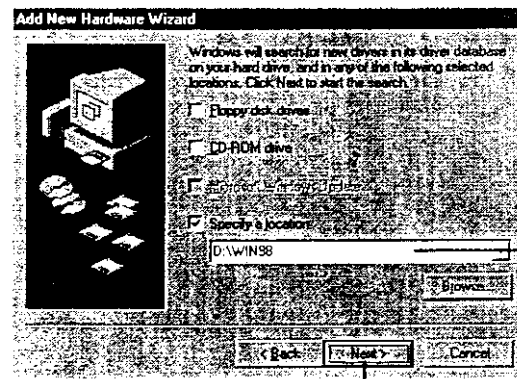

Type here.

Then click here.

- Click Next to begin the device driver installation.

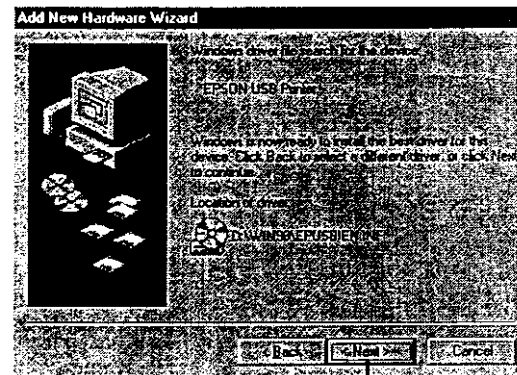

Click here.

L

Lancaster USB Guide Rev.A

A5 size
8/21/98

Usb.fm
Pass 1

Proof Sign-off:
Y.Yano
N.Nomoto
K.Pipa

6. After the installation is completed, the following dialog box appears. Click Finish.

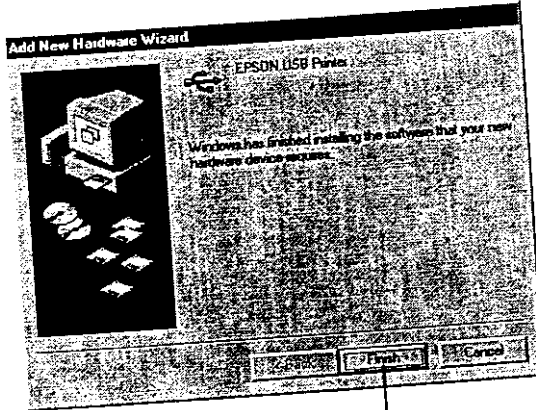

Click here.

7. The printer software installation automatically starts and the following dialog box appears. Click Next.

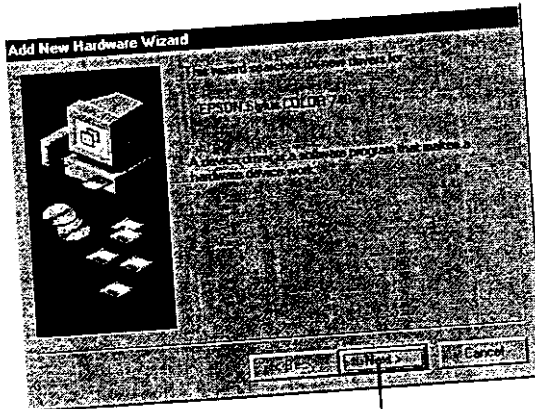

Click here.

8. When the dialog box below appears, click Next and follow the instructions on the screen.

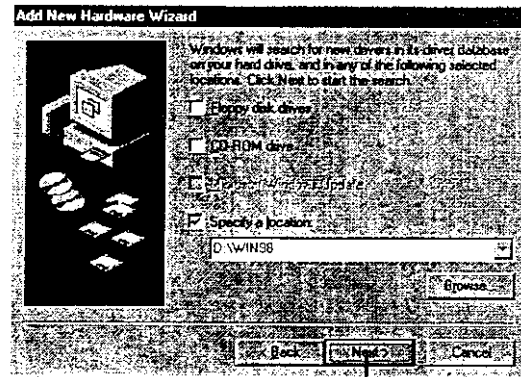

Click here.

After the printer software is installed, EPSON Status Monitor 2 installation starts automatically. Follow the on-screen instructions.

L

Lancaster USB Guide Rev.A

A5 size
8/21/98

Usb.fm
Pass 1

Proof Sign-off:
Y.Yano _____
N.Nomoto _____
K.Pipa _____

9. To confirm that installation was successful, check to see if "EPSON USB Printer Devices" appears in the Device Manager. Click Start, point to Settings, and click Control Panel. Then double-click System and click the Device Manager tab. Then double-click System and click the Device Manager tab.

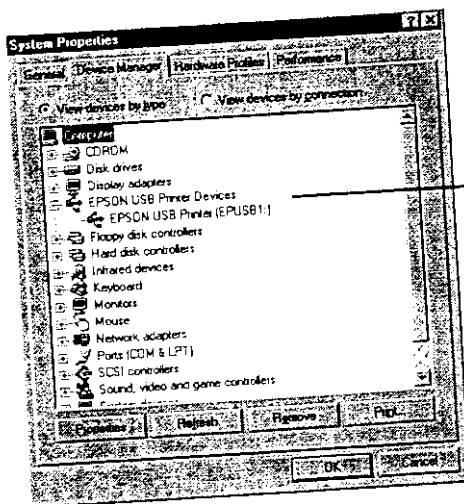

Check here.

Your printer is now ready to receive print jobs through the USB port. For instructions on using your printer, see your printer manual.

Troubleshooting

This section helps you solve problems that may occur when using the printer connected with a USB cable.

Cannot install the USB Printer Device Driver (for PC's)

Try one or more of these solutions:

- Make sure your computer is a Windows 98 pre-installed model.
- Make sure that the Universal Serial Bus Controller is working properly in the Device Manager. For details, see your computer documentation. If it is not working properly, contact your computer dealer.

Printer does not work correctly

Try one or more of these solutions:

- Use the recommended USB cable as described in "System Requirements" on page 3.
- If you use a USB hub, connect the printer to the first tier of the hub, or connect the printer to the computer's USB port directly.
- For PC's, try reinstalling the USB Printer Device Driver and the printer software. First, uninstall the EPSON Printer Software using Add/Remove Programs in the Control Panel, then uninstall the EPSON USB Printer Devices. Next, re-install the software as described in "Installing the USB Software in Windows" on page 6.

Proof Sign-off:
Y.Yano
N. Nomoto
K.Pipa

**Lancaster USB Guide
Rev.A**

A5 size
8/21/98

Usb.fm
Pass 1

R

EPSON