

ECOS-D Digital Simulcast Technology

Radio Base Station Guide

Installation, configuration and maintenance





REVISION TABLE		
Date	Revision	Comment
21/01/2015	2	P10 - changed frequency range for USA and Canada
20/11/2014	1	First issue

Information contained in this document may not be used, applied or reproduced for any purpose unless agreed by Selex ES S.p.A. in writing. Selex ES S.p.A. reserves the right to alter without notice the specification, design or conditions of supply of any product or service.

Selex ES logo is a trademark of Selex ES S.p.A.

Printed in Italy.

© Selex ES S.p.A. All Rights reserved.



Summary

1. Scope	4
2. First aid for electrical shock and safety rules	5
2.1 First aid for electrical shock	5
2.1.1 Artificial respiration	5
2.1.2 Treatment of burns.....	5
2.2 Product Safety and RF Exposure Compliance	7
2.2.1 RF Exposure Compliance	7
2.2.2 Electrostatic protection	7
3. Encoding criteria for all derived Products	8
4. Technical/Environmental Specification	10
5. Device Assembly and composition	12
5.1 Position of the connectors and switches	14
5.1.1 Archetype	14
6. Installation	15
6.1 Overview	15
6.1.1 Installation Pre-requisites	15
6.1.2 Unpack.....	16
6.1.3 Mechanical installation.....	16
6.1.4 Electrical wiring	18
6.1.5 Unit grounding.....	18
6.2 Power supplies interfaces	20
6.2.1 48 Vdc input	20
6.3 Radio Interfaces	23
6.3.1 TX N type connector	23
6.3.2 RX N type connector	24
6.3.3 Diversity receivers interfaces - Dual BNC type connector	25
6.4 Line interfaces	26
6.4.1 4W and 4W+E/M Link	26
6.4.2 E1 coax Link.....	33



6.4.3	AF in/out.....	35
6.4.4	LAN Interface.....	39
6.4.5	Serial Interface.....	41
6.4.6	Auxiliary Serial Interface	43
6.4.7	Digital Input/Output Interface	46
6.4.8	Local Microphone Interface	48
7.	Configuration	50
8.	Maintenance	50
8.1	Module features, alarms and troubleshooting.....	50
8.1.1	CORE module - CORE.....	50
8.1.2	4 Lines Interface module – LIF	53
8.1.3	Digital Interface module – DIF.....	54
8.1.4	Double Radio Receiver module – RRX.....	55
8.1.5	Switch module – SWITCH.....	57
8.1.6	DC/DC module – DC/DC.....	58
8.1.7	Radio Receiver and Transmitter module – RTX	58
8.1.8	Power Amplifier module – PA	60
8.2	Power modules maintenance precaution	62
8.3	Module removal	63
8.4	Back card removal.....	64
8.5	Local Maintenance Interface	65
8.6	Local Test AF Interface	67
8.7	Remote Maintenance Interface	69

1. Scope

This manual provides experienced technicians familiar with similar types of equipment with information which permit the installation and maintenance of the described product, whose characteristics are described in the Technical specification Section.

This document does not contain information of the maintenance and configuration software that are provided with the software itself.



Information contained in this document are valid only for the model named ECOSD RBS4000K U4110DA0C14W0E100S1V1G2, whose certification number is FCC ID: X5YF467DHDE-IP and IC: 12512A-F467DHDEIP, of the ECOS-D family of products, optional cards and ancillaries included. The technicians must use only the part of information related to the RBS really shipped.

2. First aid for electrical shock and safety rules

2.1 First aid for electrical shock

Do not touch the patient with bare hands until the circuit has been opened. Open the circuit by switching off the line switches. If that is not possible protect yourself with dry material and free the patient from the conductor.

2.1.1 Artificial respiration

It is important to start mouth resuscitation at once and to call a doctor immediately. Suggested procedure for mouth to mouth resuscitation method is described in Table 1.

2.1.2 Treatment of burns

This treatment should be used after the patient has regained consciousness. It can also be employed while artificial respiration is being applied (in this case there should be at least two persons present).

Warning

- Do not attempt to remove clothing from burnt sections
- Apply dry gauze on the burns
- Do not apply ointments or other oily substances.







Step	Description	Figure
1	Lay the patient on his back with his arms parallel to the body. If the patient is laying on an inclined plane, make sure that his stomach is slightly lower than his chest. Open the patients mouth and check that there is no foreign matter in mouth (dentures, chewing gum, etc.).	
2	Kneel beside the patient level with his head. Put an hand under the patient's head and one under his neck. Lift the patient's head and let it recline backwards as far as possible.	
3	Shift the hand from the patient's neck to his chin and his mouth, the index along his jawbone, and keep the other fingers closed together. While performing these operations take a good supply of oxygen by taking deep breaths with your mouth open.	
4	With your thumb between the patient's chin and mouth keep his lips together and blow into his nasal cavities	
5	While performing these operations observe if the patient's chest rises. If not it is possible that his nose is blocked: in that case open the patient's mouth as much as possible by pressing on his chin with your hand, place your lips around his mouth and blow into his oral cavity. Observe if the patient's chest heaves. This second method can be used instead of the first even when the patient's nose is not obstructed, provided his nose is kept closed by pressing the nostrils together using the hand you were holding his head with. The patient's head must be kept sloping backwards as much as possible.	
6	Start with ten rapid expirations, hence continue at a rate of twelve/ fifteen expirations per minute. Go on like this until the patient has regained consciousness, or until a doctor has ascertained his death.	

Table 1: First aid



2.2 Product Safety and RF Exposure Compliance

2.2.1 RF Exposure Compliance

The described product is intended for use in occupational/controlled conditions, where users have full knowledge of their exposure and can exercise control over their exposure to meet R&TTE and FCC/IC limits. This RBS is NOT authorized for any other use.

2.2.2 Electrostatic protection

When the equipment units are provided with the plate, shown in Figure 1 it means that they contain components electrostatic charge sensitive.



Figure 1 Electrostatic sensitive equipment

In order to prevent the units from being damaged while handling, it is advisable to wear an elasticised band (Figure 2) around the wrist ground connected through coiled cord (Figure 3) to the appropriate point on the RBS (Figure 4)

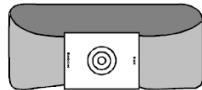

Figure 2 Antistatic band

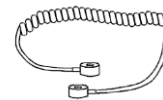
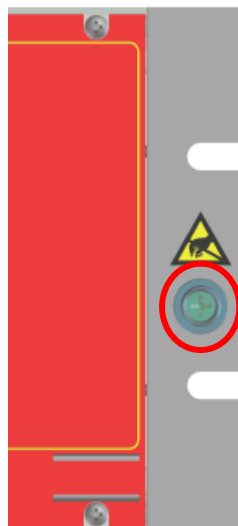

Figure 3 Coiled Cord



**Antistatic
contact point**

Figure 4 Antistatic contact point



3. Encoding criteria for all derived Products

The following table sets out the criteria for coding of products derived from the archetype, and is specific to an equipment ECOSD A2T-band 806-894 MHz 110W PA.

The model number for each products derived from the archetype, is obtained by assigning to the variables that make up (highlighted in green), one of the value shown in the table.

Tab. 2

General Code: ECOSD RBS4000K <u>aabbWAcde4WgE1hmSnVpGr</u>	
Frequency Band	<u>aa</u> aa = U4 (806 - 894 MHz) aa = 00 - indicates no part radio
RF Power	<u>bbbW</u> bbb = 110 - Pout 110W bbb = 000 - indicates no Power Amplifier module W = W → Configuration without RX Diversity W = D → Configuration with RX Diversity
Power Supply	<u>Acde</u> c = 0 - does not provide 12Vdc power supply d = 0 - indicates the absence of alternatives at 12Vdc powr supply d = C - indicates 48Vdc power supply e = 1 - indicates one power supply module e = 0 - indicates no power supply modules
4 Wires interfaces	<u>4Wg</u> g = 1 - indicates one LIF (Line Interface module) with back-card g = 0 indicates no Line Interface modules and no back-card
E1 Interfaces	<u>E1hm</u> h = C - indicates back-DIF (Digital Interface back-card) with coax connectors @75 Ohm unbalanced h = R - indicates back-DIF (Digital Interface back-card) with RJ45 connectors @120 Ohm balanced h = 0 - indicates no back-DIF m = 1 - indicates one Digital Interface module m = 0 - indicates no Digital Interface modules
Option Board - SOIP	<u>Sn</u> n = 1 - indicates one SOIP piggy-back on one CORE module n = 0 - indicates no SOIP piggy-back
Option Board - VOCODER	<u>Vp</u> p = 1 - indicates one VOCODER piggy-back on one CORE module



	p = 0 - indicates no VOCODER piggy-back
Synchronization - GPS receiver	Gr r = 1 - indicates one GPS receiver piggy-back on one CORE module (Master) r = 2 - indicates two GPS receiver piggy-back on one CORE module (Master) r = 0 - indicates no GPS receivers piggy-back



4. Technical/Environmental Specification

The main characteristic of the device are:

Radio Frequency:

Frequency range	806 – 894 MHz (851-869 MHz for USA and Canada)
Channel Spacing	12,5 – 25 kHz
Channel step	5 kHz – 6,25 kHz
RF Power	10 – 110 Watt (step 0,1 dB), continuous transmission
Modulation type	Dual mode Analog FM/PM (EN 300 086 – EN 300 113) 11K0F3E/11K0G3E 16K0F3E/16K0G3E Digital 4FSK (TS 102 361-1,2,3) 7K60FXD/7K60FXE C4FM 8K10F1D/8K10F1E
CTCSS	67 – 254.1 Hz (step 0,1 Hz)
DCS	yes
Antenna connector	50 Ohm
Emission mode	Duplex/Simplex
Receiver sensitivity	Analog FM (12,5 kHz): ≤ -112 dBm @ 20 dB SINAD psofo Digital 4FSK: ≤ -118 dBm @ BER = 5×10^{-2} Digital C4FM: ≤ -118 dBm @ BER = 5×10^{-2}

Power supply:

Input voltage	48 Vdc (35 ÷ 75 Vdc - galvanically insulated)
Current drain	
Stand-by	0,9 A max @ 48 Vdc
Transmit	7,0 A max @ 48 Vdc

NOTE: current drain values are for fully equipped devices.



Environmental condition:

Operating temperature	-30 - +60 °C (-22 - +140 °F) This is the temperature measured in close proximity to the device. If the device is mounted in a cabinet, the temperature within the cabinet is measured.
Humidity	should not exceed 90% relative humidity @ 50°C (122°F) non condensating
Air Quality	For equipment operating in an environmentally controlled environment with repeater(s) rack mounted, the airborne particle level must not exceed 25 µg/m ³ . For equipment operating in an area which is not environmentally controlled (repeater(s) cabinet mounted), air borne particle level must not exceed 90 µg/m ³ .
Equipment Ventilation	the repeater is equipped with two cooling fans that are used to provide forced convection cooling. Customer-supplied cabinets must be equipped with ventilation slots or openings in the front (for air entry) and back or side panels (for air to exit). If several repeaters are installed in a single cabinet, be sure ventilation openings surround each repeater to allow for adequate cooling. A minimum of ½ RU (4,4 cm – 0,8 inches) must be left among devices installed in the same cabinet.



5. Device Assembly and composition

Front overview.

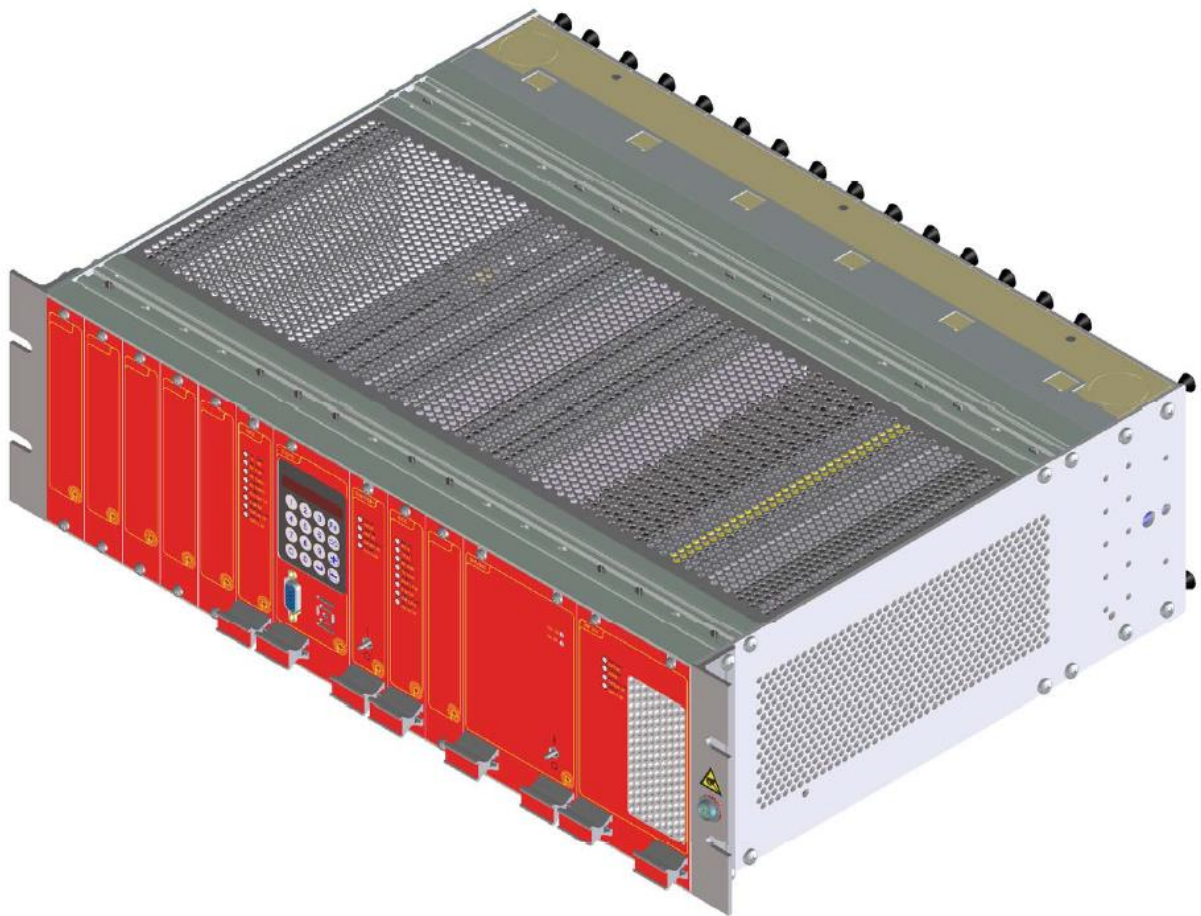



Rear overview.

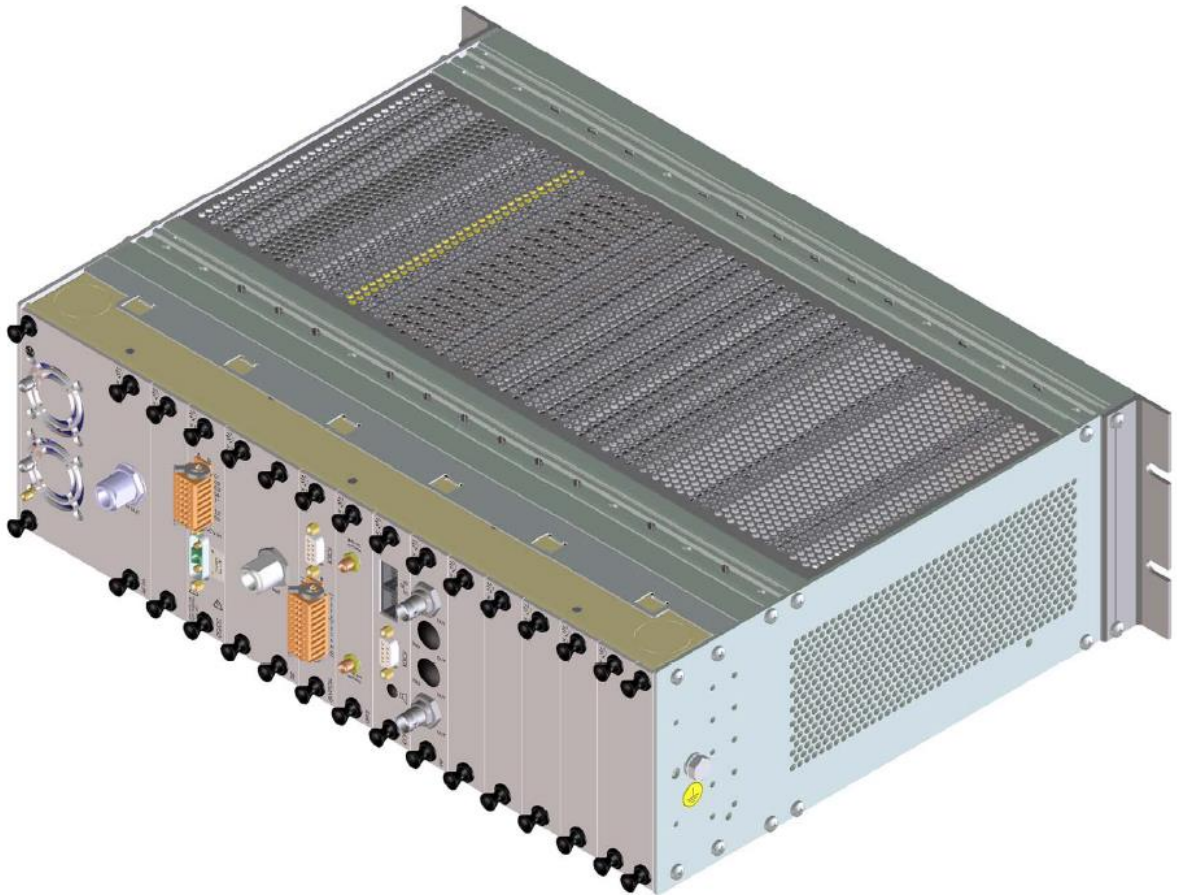



5.1 Position of the connectors and switches

5.1.1 Archetype

Front view:

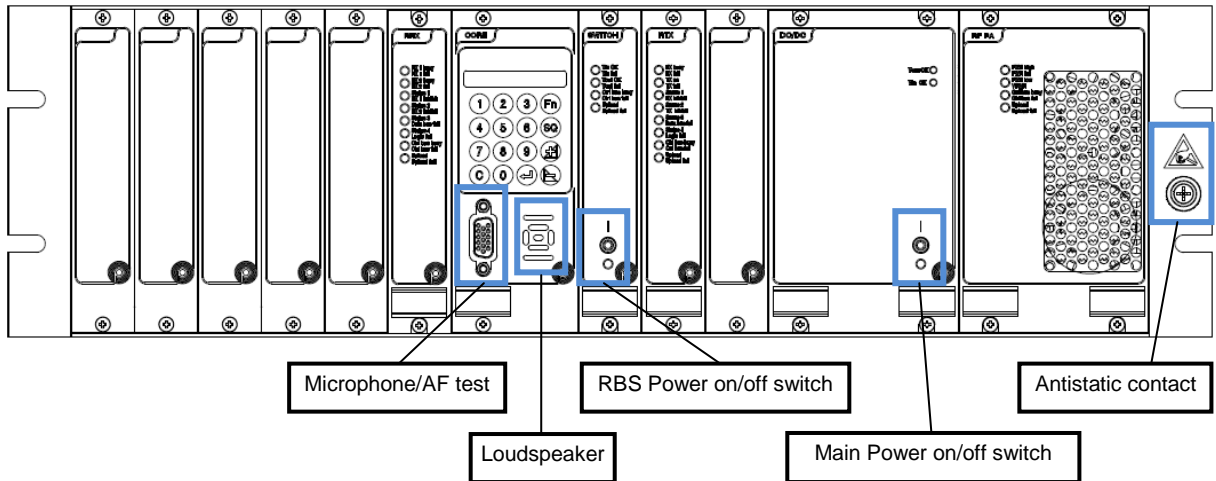

Rear view:

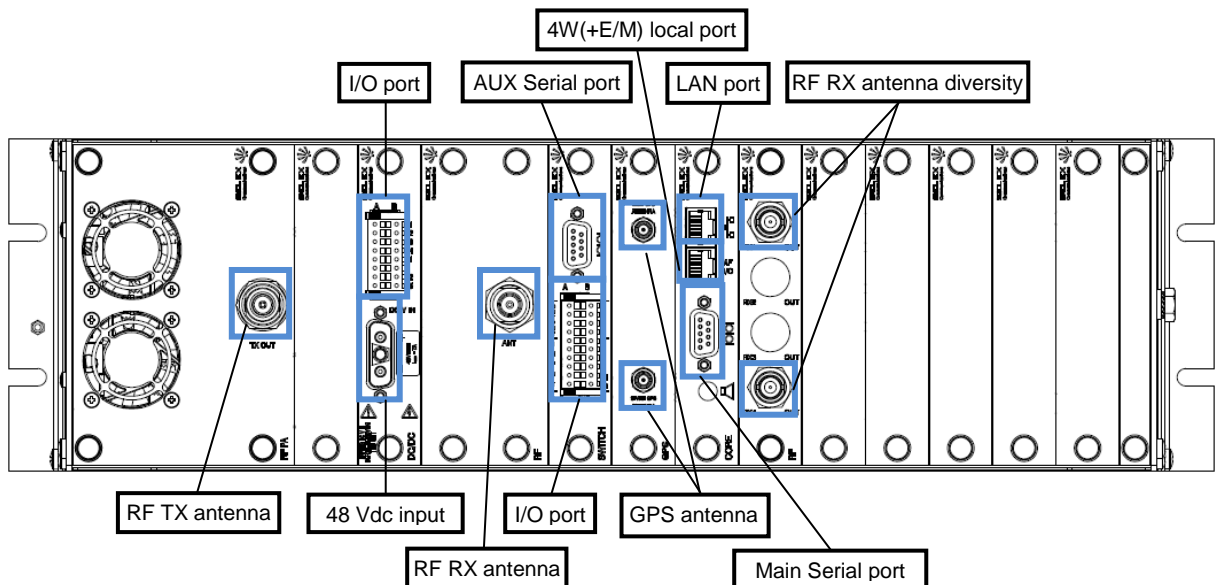



6. Installation

6.1 Overview

The device can be shipped preinstalled in a cabinet or not. If it is not shipped preinstalled in a cabinet, after unpacking, mechanical installation takes place, followed by electrical connections as described in this document. The device may be installed in any location suitable for electronic communications equipment, provided that the environmental conditions do not exceed the equipment specifications for temperature, humidity, and air quality and that the access to that location is restricted as described below:



- access can only be gained by service persons or by users who have been instructed about the reasons for the restrictions applied to the location and about any precautions that be taken; and
 - access is through the use of a tool or lock and key, or other means of security, and is controlled by the authority responsible for the location
-

6.1.1 Installation Pre-requisites

To ensures the best possible performance and reliability of the described equipment pre-installation planning is required. This includes considering the mounting location of the repeater in relation to input power and antennas. Also to be considered are site environment conditions, the particular mounting method and required tools and equipment.



To plan the installation, please pay particular attention to environmental condition at the site; ventilation requirements, grounding and lightning protection as described in this manual.



After that, following the instruction given in this manual:

- Unpack and inspect the equipment.
- Mechanical install the equipment at the site.
- Make necessary electrical wiring:
 - Unit Grounding
 - DC/DC input cabling
 - Coaxial cables to transmit and receive antennas
- Perform a post-installation function checkout test of the equipment to verify proper installation.
- Proceed to customize the repeater parameters per customer specifications (e.g. operating frequency, PL, codes, color code, etc.)

6.1.2 Unpack

Inspect the equipment for damage immediately after unpacking and make a report of the extent of any damage to the transportation company and to Selex ES S.p.A.

The following items are packed together:

- ECOS-D A2T Radio Base Station
- DC power cable
- This manual

6.1.3 Mechanical installation

The device is shipped in a box. Upon delivery, the equipment must be removed from the container (see Unpack section) and transferred to a rack or cabinet if not provided.

If the device is supplied without a cabinet it is designed to be fitted in a 19" cabinet using 3 RU of space.

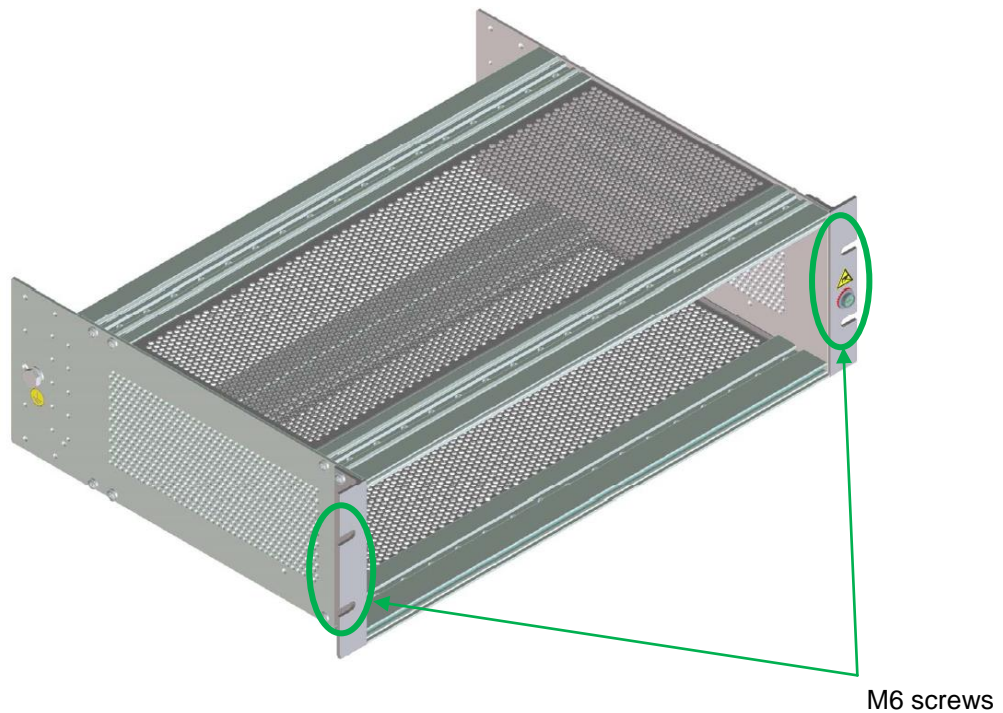

Customer-supplied cabinets and racks must have mounting rail and hole spacing compatible with EIA Universal 48.3 cm (19 inches) specifications. Cabinets must provide adequate ventilation and must meet the following criteria:

- 45.0 cm (17.71 inches) deep
- 48.3 cm (19 inches) wide
- 13.4 x 3 cm (15.75 inches) high
- Two mounting rails 5 cm (2 inches) from front cabinet with front mounting holes 5.7 cm (2.25 inches) apart (center to center).

The front of the device is provided with four holes for M6 screws (highlighted above in green) for each level. This permits to fasten the device to a 19" rack by means of 4 M6 screws for each level.

If several devices are installed in a single cabinet, be sure equipment have to be spaced at least by 1/2 RU (2,2 cm, 0,8 inches).to allow for adequate cooling.

Cabinets must have a least 15 cm (6 inches) of open space between the air vents and any wall or other cabinets. This allows adequate air flow.

When multiple cabinets (each equipped with several repeaters) are installed in an enclosed area, ensure appropriate ventilation and consider air conditioning or other climate control equipment to satisfy the temperature requirements.



6.1.4 Electrical wiring

The electrical wiring must be done using appropriate cables thus assuring the equipment responds to the electromagnetic compatibility standards.

The cable terminates to flying connectors which have to be connected to the corresponding connectors on the equipment rear panel.



The connector of the power cable supplied with the product is the means to disconnect the device from the power source.

Position and pin-out of the equipment connectors are available in the appropriate section in the following of this document.

6.1.5 Unit grounding



The device is equipped with a protection ground nut located on the lateral side panel of the device and identified by a ☺ label.

This nut must be used for a direct connection of the device to the site grounding, even if the device is included in a cabinet. All antenna cables and DC power cabling should be properly grounded and lightning protected. Failure to provide proper lightning protection may result in permanent damage to the radio equipment.



**Protection
ground
connection**

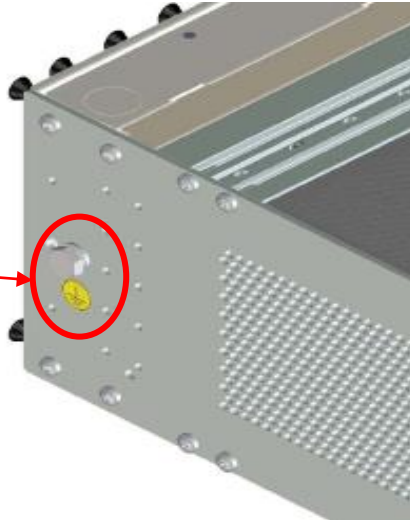

Figure 5 Ground screw

Interconnecting points	Type of connector terminating the cable	Type of cable/conductor
Ground	M6 nut	Section area ≥ 6 sq. mm

Note. Resistance between ground terminal and other metallic parts of the device verified applying between the two sides a current of 32 A for 4 minutes.



6.2 Power supplies interfaces

6.2.1 48 Vdc input

Use the connector marked in red to connect RBS to the output of the 48 VDC power supply. Each level must be connected separately the 48 VDC power supply. The RBS is galvanically insulated..

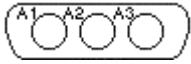

Interconnecting points	Type of connector terminating the cable	Type of cable/conductor
Power supply 35 – 75 Vdc	Polarised SUB-D 3W3 female connector	Section of each wire $\geq \square$ 4 sq.mm. (for length < 6 m)

D-SUB 3W3 female pinout	
PIN	
A1	Negative voltage
A2	Not used
A3	Positive voltage
	 <p>(soldering side view)</p>

Hereafter the power cable supplied with the 48 Vdc powered device is shown. The cable is provided with D-SUB 3W3 female connector and a 30A fuse.

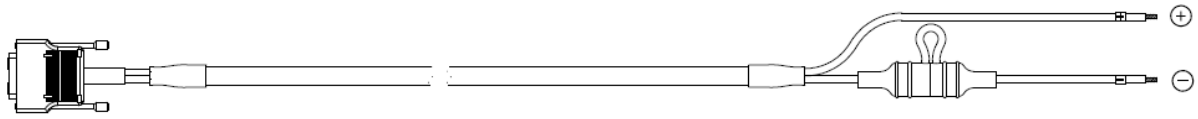

The 48Vdc Back Card hosts three 10A fuses. Position of FU1, FU2 and FU3 is indicated in the figure below.



Electrical characteristics of the fuses are described in the table below.

Ampere rating (A)	Voltage rating (V)	Nominal Melting ($I^2 A^2 \text{ Sec.}$)
10	125	26.46



The 'base board' within the SWITCH module hosts two 15A fuses. Position of FU2 and FU3 is indicated in the figure below.

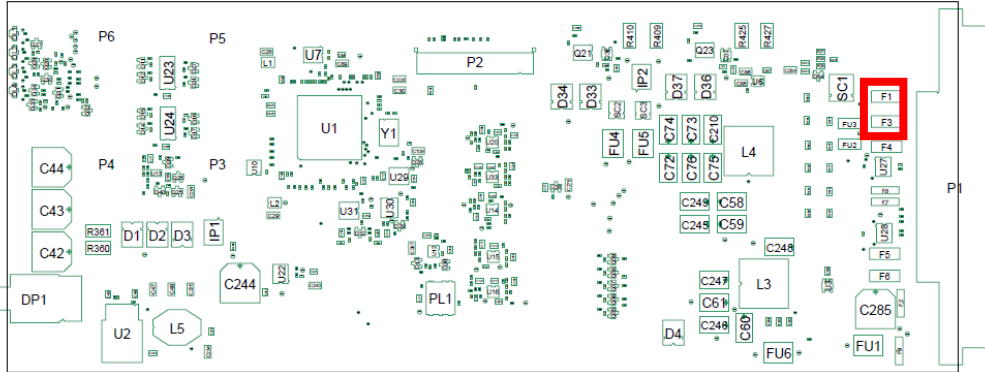

Electrical characteristics of the fuses are described in the table below.

Ampere rating (A)	Voltage rating (V)	Nominal Melting ($I^2 A^2 \text{ Sec.}$)
15	65	97.82



6.3 Radio Interfaces

6.3.1 TX N type connector

In RBS without branching and using duplex mode of operation connect the transmitter cable to the “TX OUT” connector as shown in the following figure.

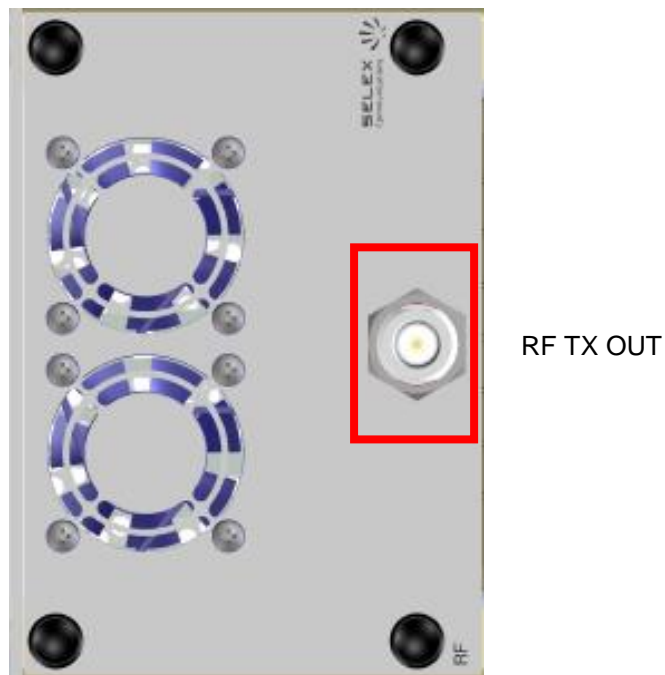

Interconnecting points	Type of connector terminating the cable	Type of cable/conductor
TX Antenna	N male connector	50 ohm coaxial cable with double shield



6.3.2 RX N type connector

In RBS without branching and using duplex mode of operation connect the transmitter cable to the “RX IN” connector as shown in the following figure.

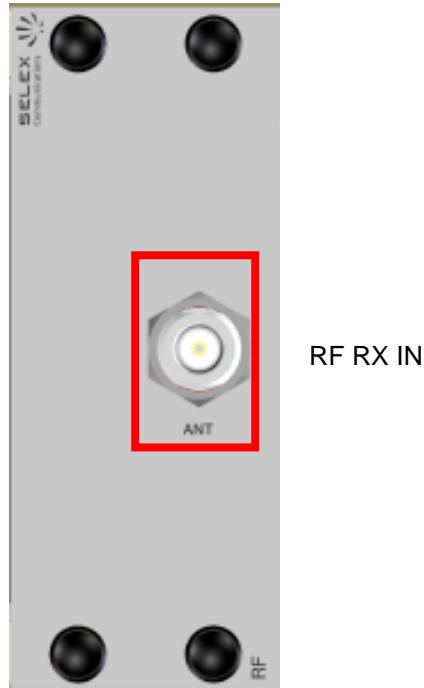

Interconnecting points	Type of connector terminating the cable	Type of cable/conductor
Antenna	N male connector	50 ohm coaxial cable with double shield



6.3.3 Diversity receivers interfaces - Dual BNC type connector

For applications with receiver diversity the connection to the antenna, through appropriate branching, is achieved through connectors labeled "RX1 OUT" and "RX2 OUT" as shown in the following figure.



Interconnecting points	Type of connector terminating the cable	Type of cable/conductor
Antenna	BNC male connector	50 ohm coaxial cable with double shield



6.4 Line interfaces

6.4.1 4W and 4W+E/M Link

If the RBS is equipped with a LIF module, on the rear panel, 4 4W+E/M connectors are present. The following figure shows the rear panel of the LIF module. Configuration of the feature of this four links is out of the scope of this manual. The electrical interface is described in this section. Usually these AF links are used to establish RBS to RBS links or RBS to RNFE links.

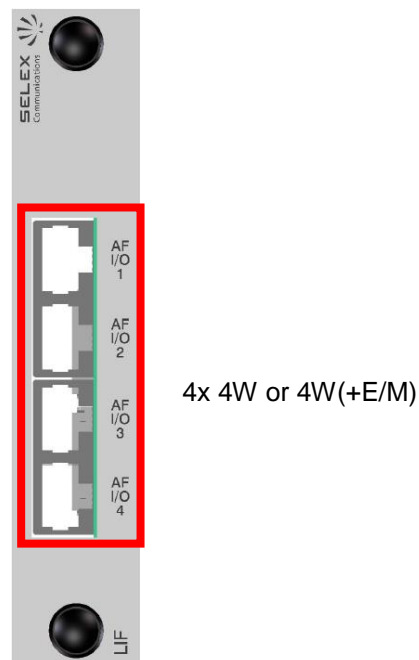

Interconnecting points	Type of connector terminating the cable	Type of cable/conductor
4W or 4W+E/M Link port	RJ45 male connector	AWG 24 Category 5



4W+E/M line RJ45 female pinout	
PIN	
1	Mouth (M+)
2	Mouth (M-)
3	Ear (E+)
4	AF_OUT (-)
5	AF_OUT (+)
6	Ear (E-)
7	AF_IN (-)
8	AF_IN (+)

4W+E/M and 4W line usage			
PIN		4W+E/M	4W
1	M (+)	Mouth signal +	not connected
2	M (-)	Mouth signal -	not connected
3	E (+)	Ear Signal +	not connected
4	AF_OUT (-)	600 Ohm Balanced OUT AF	600 Ohm Balanced OUT AF
5	AF_OUT (+)	600 Ohm Balanced OUT AF	600 Ohm Balanced OUT AF
6	E (-)	Ear Signal -	not connected
7	AF_IN (-)	600 Ohm Balanced IN AF	600 Ohm Balanced IN AF
8	AF_IN (+)	600 Ohm Balanced IN AF	600 Ohm Balanced IN AF

E/M pin usage			
PIN		Balanced	Unbalanced
1	M (+)	Mouth signal +	Mouth signal
2	M (-)	Mouth signal -	not connected
3	E (+)	Ear Signal +	Ear Signal
6	E (-)	Ear Signal -	not connected



4W cabling example: link between RBS A and RBS B

RJ-45, RBS A side		
M (+)	1	Not connected
M (-)	2	Not connected
E (+)	3	Not connected
AF_OUT (-)	4	White-blue
AF_OUT (+)	5	Blue
E (-)	6	Not connected
AF_IN (-)	7	White-orange
AF_IN (+)	8	Orange

RJ-45, RBS B side		
Not connected	1	M (+)
Not connected	2	M (-)
Not connected	3	E (+)
White-orange	4	AF_OUT (-)
Orange	5	AF_OUT (+)
Not connected	6	E (-)
White-blue	7	AF_IN (-)
Blue	8	AF_IN (+)

E/M Hardware Line settings

All the E/M signals share a common voltage reference. The four Mouth signals may be hardware configured independently. The four Ear signals share the same hardware configuration in couple of lines. For unbalanced settings connect the two communicating entities to the same ground.

E/M Type I Interface Model

E/M Type I is the original E/M lead signaling arrangement and it is the most common interface type in North America. The following diagram displays the sent signal states for active/not active signaling. The RBS grounds its M-lead to signal a seizure. The other device applies battery to its M-lead to signal a seizure. The RBS expects to see active conditions on the E-lead and signal active to the remote device on M-lead.

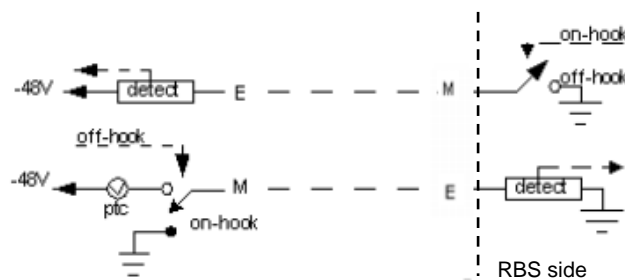

E/M Type II Interface Model

E/M Type II provides a four-wire fully-looped arrangement that provides full isolation between the trunks and signaling units. The following table displays the sent signal states for active/not active signaling. The RBS grounds its M-lead to signal a seizure. The other device applies battery to its M-lead to signal a seizure. The RBS expects to see active conditions on the E-lead and signal active to the remote device on M-lead.

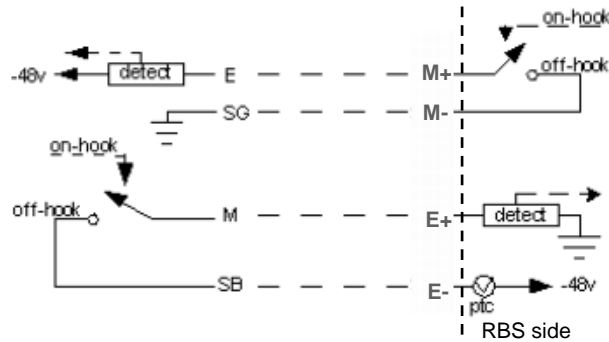

E/M Type V Interface Model

E/M Type V interface is a symmetrical two-wire lead arrangement that signals in both directions by means of open for not active and ground for active signalling. The following table displays the sent signal states for active/not active signalling. The RBS grounds its M-lead to signal a seizure. The other device applies battery to its M-lead to signal a seizure. The RBS expects to see active conditions on the E-lead and signal active to the remote device on M-lead.

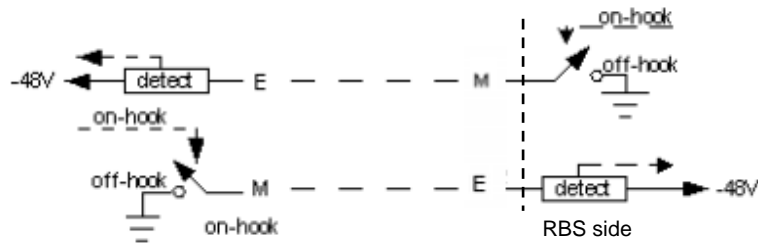

E/M Proprietary Type Interface Model

E/M Proprietary Type provides a four-wire fully-looped arrangement that provides full isolation between the trunks and signaling units. The following table displays the sent signal states for active/not active signalling. The RBS grounds its M-lead to signal a seizure. The other device applies battery to its M-lead to signal a seizure. The RBS expects to see active conditions on the E-lead and signal active to the remote device on M-lead.

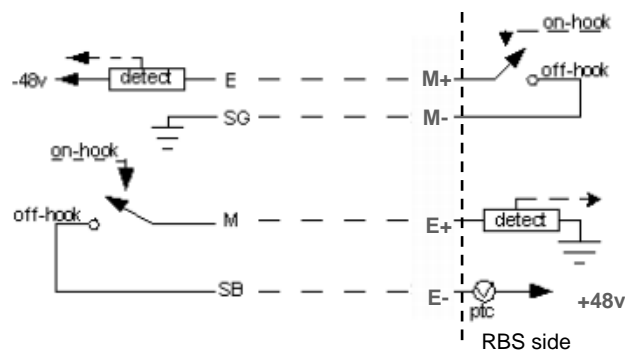



E/M Hardware settings						
		Type I (Unbalanced)	Type II (Balanced)	Type V (Unbalanced)	proprietary (Balanced)	
IP3	1	voltage reference	ON	OFF	OFF	ON
	2		ON	OFF	OFF	ON
IP5	1		OFF	ON	ON	OFF
	2		OFF	ON	ON	OFF
IP6	1	E line 3&4	ON	OFF	ON	OFF
	2	E line 1&2	ON	OFF	ON	OFF
IP7	1	M line 2	ON	OFF	ON	OFF
	2	M line 1	ON	OFF	ON	OFF
IP8	1	M line 4	ON	OFF	ON	OFF
	2	M line 3	ON	OFF	ON	OFF

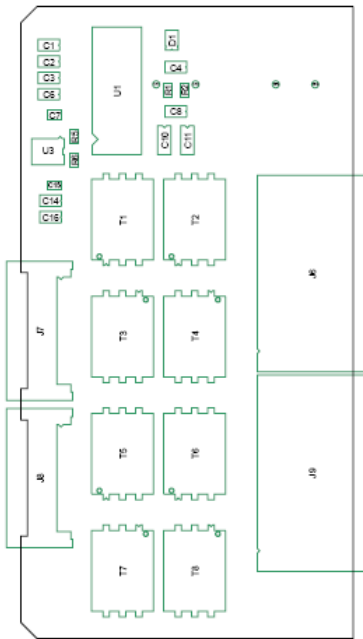

Top-side View

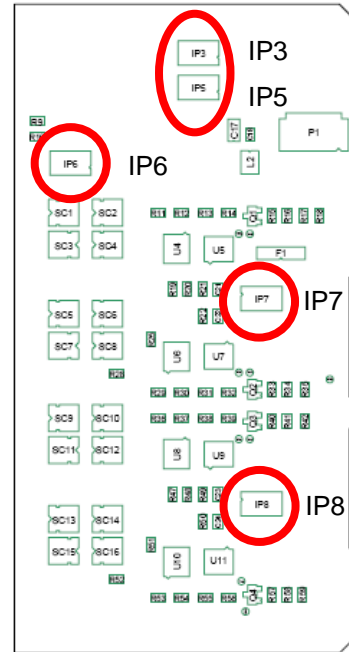

Bottom-side View

Back card deep switch positioning

Where, in the equipment described in this document, a 4 wires interface towards a common communication network is used, it is mandatory to use 4 (four) different copper pairs: two of them are



used to transfer from one to the other RBS the user payload and two of them are optionally used to transfer E and M criteria.

All the signals are exchanged using a balanced type of connection, avoiding any ground reference. For the two copper pairs used for exchanging the user payload, the impedance of the interface is 600 Ohm.

The characteristics of the pairs must be as follows:

Amplitude:

Amplitude characteristic of the media must comply with FIGURE 2/G.712 (ITU-T Rec.G.712 page 8). The mask is shown below. Anyway in the audio band from 300 Hz to 3400 Hz the response must be +/- 1,5 dB with respect to the nominal level of -10 dBm.

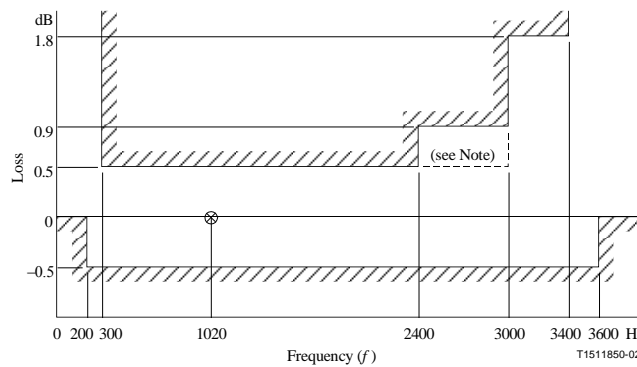

NOTE – In some applications in which several PCM channels may be connected in tandem, it may be necessary to extend the +0.5 dB limit from 2400 Hz to 3000 Hz.

Group delay:

Group delay characteristic of the media must comply with FIGURE 6/G.712 (ITU-T Rec.G.712 page 10). The mask is shown below.

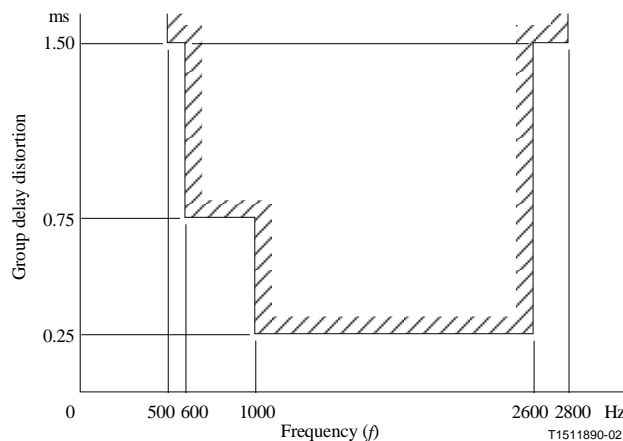

Insertion loss:



The insertion loss must be 0dB +/- 3 dB. This must be true also with regard to the aging of the media physically used.

Noise:

The characteristic of the media must comply with prescriptions contained in chapter 9 (noise) of book III.4-Rec.G.792 page 4 and following.

Diaphony:

The pairs of the media used to transport the user payload must have a diaphony attenuation greater than 40 dB.

E/M time response:

The response time of E/M criteria must be less than 100 msec.



6.4.2 E1 coax Link

If the RBS is equipped with a DIF module on the rear panel 4 E1 connectors are present. The following figure shows the rear panel of the DIF module. Configuration of the four links is out of the scope of this manual. Usually these E1 link are used to establish RBS to RBS links or RBS to RNFE links.

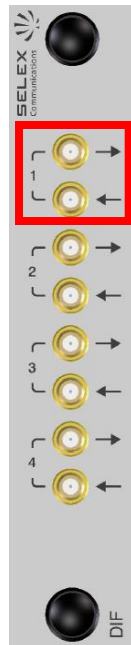

E1 coax Link

Interconnecting points	Type of connector terminating the cable	Type of cable/conductor
E1 link	1.0/2.3 male connector	75 ohm coaxial cable with double shield

Where, in the equipment described in this document, a E1 interface towards a common backbone is envisaged, in the followings the backbone features to be assured in order to make the ECOS-D simulcast networks to work properly are described:

- backbone must work in PDH/SDH technology with E1 stream (no TCP/IP – ethernet, fast ethernet – packet switched connections can be used to carry communications)
- backbone must guarantee:
 - fixed delay (max 20msec end-to-end)
 - Jitter must satisfy ITU-T G.823
 - Wander < $\pm 1 \mu\text{sec}$



- backbone device interface requirements:
 - Payload: E1 (2.048 Kbit/s) ITU-T G.703, coax 1.0/2.3 75Ohm or RJ45 120Ohm;
 - Frame: ITU-T G.704
- E1 links must support CAS signaling in TS16
- E1 links must transparently transport channel Sa-4 in TS0



6.4.3 AF in/out

If the RBS is equipped with a CORE back card module a 4W+E/M link if available. The following figure shows the rear panel of the CORE module. Configuration of this AF link is out of the scope of this manual. Usually it is used to provide an AF signal to a third party audio device.

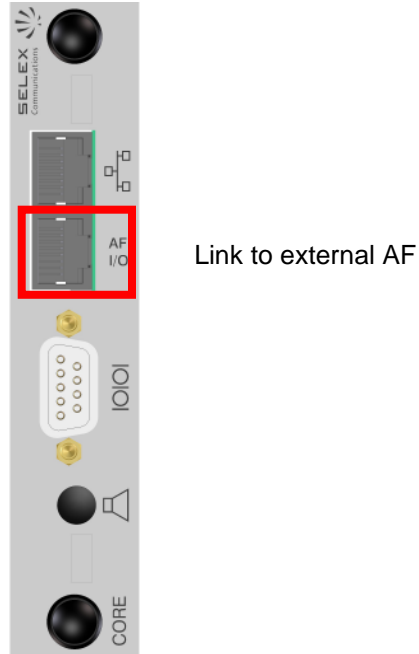

Interconnecting points	Type of connector terminating the cable	Type of cable/conductor
4W or 4W+E/M Link	RJ45 male connector	AWG 24 Category 5

AF 4W+E/M line RJ45 female pinout	
PIN	
1	Mouth (M+)
2	Mouth (M-)
3	Ear (E+)
4	AF_OUT (-)
5	AF_OUT (+)
6	Ear (E-)
7	AF_IN (-)
8	AF_IN (+)



4W+E/M line usage		
PIN		4W+E/M
1	M (+)	Mouth signal +
2	M (-)	Mouth signal -
3	E (+)	Ear Signal +
4	AF_OUT (-)	600 Ohm Balanced OUT AF
5	AF_OUT (+)	600 Ohm Balanced OUT AF
6	E (-)	Ear Signal -
7	AF_IN (-)	600 Ohm Balanced IN AF
8	AF_IN (+)	600 Ohm Balanced IN AF

E/M pin usage			
PIN		Balanced	Unbalanced
1	M (+)	Mouth signal +	Mouth signal
2	M (-)	Mouth signal -	not connected
3	E (+)	Ear Signal +	Ear Signal
6	E (-)	Ear Signal -	not connected

E/M Hardware Line settings

The four Mouth signals share the same hardware configuration. The four Ear signals share the same hardware configuration. For unbalanced settings connect the two communicating entities to the same ground.

E/M Type I Interface Model

E/M Type I is the original E/M lead signaling arrangement and it is the most common interface type in North America. The following diagram displays the sent signal states for active/not active signaling. The RBS grounds its M-lead to signal a seizure. The other device applies battery to its M-lead to signal a seizure. The RBS expect to see active conditions on the E-lead and signal active to the remote device on M-lead.

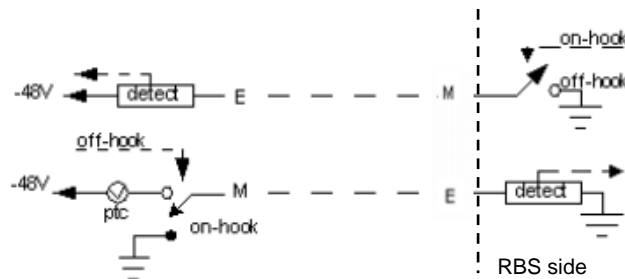



E/M Type II Interface Model

E/M Type II provides a four-wire fully-looped arrangement that provides full isolation between the trunks and signaling units. The following table displays the sent signal states for active/not active signaling. The RBS grounds its M-lead to signal a seizure. The other device applies battery to its M-lead to signal a seizure. The RBS expect to see active conditions on the E-lead and signal active to the remote device on M-lead.

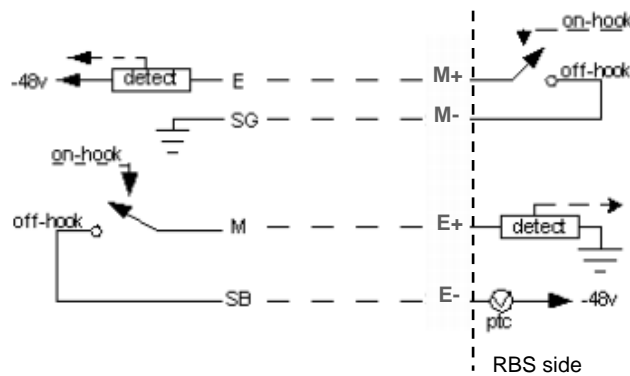

E/M Type V Interface Model

E/M Type V interface is a symmetrical two-wire lead arrangement that signals in both directions by means of open for not active and ground for active signalling. The following table displays the sent signal states for active/not active signaling. The RBS grounds its M-lead to signal a seizure. The other device applies battery to its M-lead to signal a seizure. The RBS expect to see active conditions on the E-lead and signal active to the remote device on M-lead.

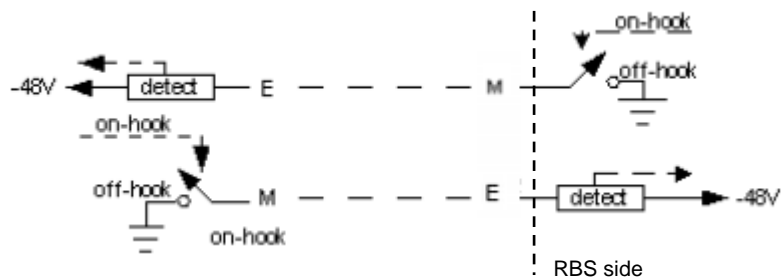

E/M Proprietary Type Interface Model

E/M Proprietary Type provides a four-wire fully-looped arrangement that provides full isolation between the trunks and signaling units. The following table displays the sent signal states for active/not active signaling. The RBS grounds its M-lead to signal a seizure. The other device applies battery to its M-lead to signal a seizure. The RBS expect to see active conditions on the E-lead and signal active to the remote device on M-lead.

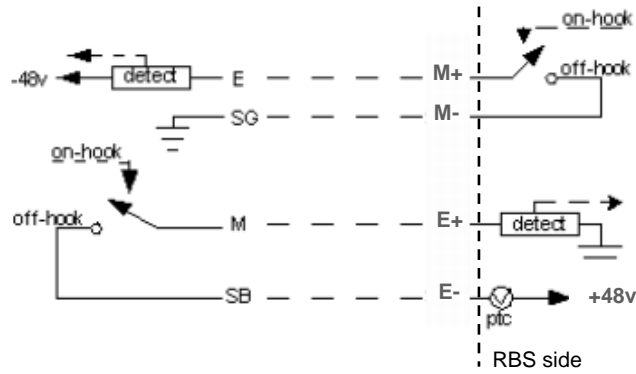

E/M Hardware settings					
		Type I (Unbalanced)	Type II (Balanced)	Type V (Unbalanced)	proprietary (Balanced)
IP1	1	ON	OFF	OFF	ON
	2	ON	OFF	OFF	ON
IP2	1	OFF	ON	ON	OFF
	2	OFF	ON	ON	OFF
IP3	1	OFF	OFF	OFF	OFF
	2	ON	OFF	ON	OFF



Back card deep switch positioning



6.4.4 LAN Interface

The LAN Interface is a 10BASE-T 100BASE-TX autosensing Ethernet interface with a standard RJ45 connector. Connect it to a hub/switch to provide LAN access to the feature of the RBS. Available features depend on the settings of the RBS.

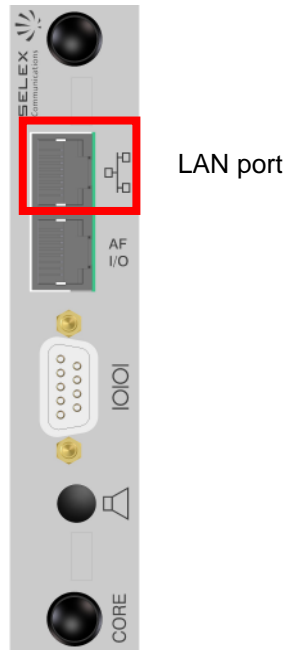

Interconnecting points	Type of connector terminating the cable	Type of cable/conductor
LAN	RJ45 male connector	AWG 24 Category 5

LAN RJ45 female pinout		
PIN		
1	RX+	Receive Data +
2	RX-	Receive Data -
3	TX+	Transmit Data +
4		not used
5		not used
6	TX-	Transmit Data -
7		not used
8		not used

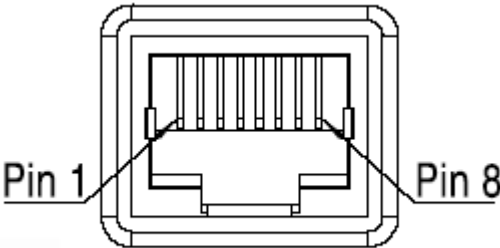



LAN RJ45 male cabling			
PIN		EIA/TIA 568A	EIA/TIA 568B
1	TX+	White/Green	White/Orange
2	TX-	Green	Orange
3	RX+	White/Orange	White/Green
4		Blue	Blue
5		White/Blue	White/Blue
6	RX-	Orange	Green
7		White/Brown	White/Brown
8		Brown	Brown

TOP:

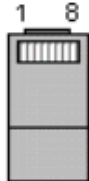

FRONT:



To connect the RBS to an Ethernet hub/switch use a straight cable (EIA/TIA 568A or EIA/TIA 568B on both ends).

To connect the RBS directly to an Ethernet host use a cross cable (EIA/TIA 568A on one end and EIA/TIA 568B on the other end).



6.4.5 Serial Interface

The Serial Interface is an RS232 interface with a standard female type D DCE connector. Connect it to a DTE to provide serial access to the RBS. Available features depend on the settings of the RBS.

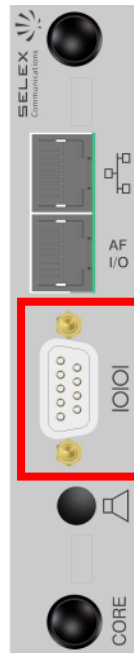

Serial Interface

Interconnecting points	Type of connector terminating the cable	Type of cable/conductor
RS232	Male type D connector with 9 pins and shielded holder	9 conductor cable with double brass sheath type interconductor



RS232

RS232 standards are defined by EIA/TIA (Electronic Industries Alliance /Telecommunications Industry Association). RS232 defines both the physical and electrical characteristics of the interface. RS232 is an Active LOW voltage driven interface and operates at +12V to -12V. RS232 is a serial interface for the transmission of point to point digital data. Description of the connector's pins is from DTE to DCE. The RBS acts as a DCE.

RS232 female pinout		
PIN		Mean
1		not used
2	RX	Data from DCE to DTE
3	TX	Data from DTE to DCE
4		not used
5	GND	Ground
6		not used
7	RTS	Ready To Send (from DTE)
8	CTS	Clear To Send (to DTE)
9		not used

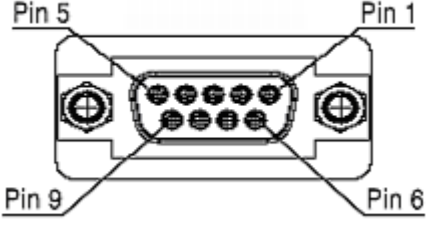

Complete RS232 female pinout (only on request)		
PIN		Mean
1		not used
2	RX	Data from DCE to DTE
3	TX	Data from DTE to DCE
4	DTR	Data Terminal Ready (from DTE)
5	GND	Ground
6	DSR	Data Set Ready (to DTE)
7	RTS	Ready To Send (from DTE)
8	CTS	Clear To Send (to DTE)
9		not used

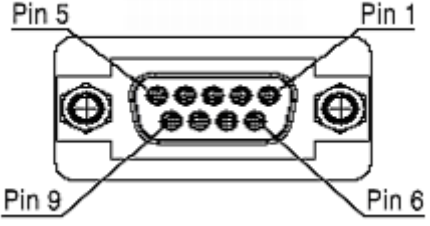



6.4.6 Auxiliary Serial Interface

The Auxiliary Serial Interface is an optional RS232, RS422 or RS485 interface with a standard female type D DCE connector. Connect it to a DTE to provide serial access to the RBS. Available features depend on the settings of the RBS.

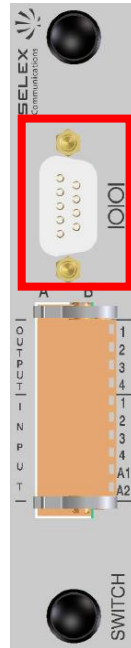

AUX Serial Interface

Interconnecting points	Type of connector terminating the cable	Type of cable/conductor
RS232 RS422 RS485	Male type D connector with 9 pins and shielded holder	9 conductor cable with double brass sheath type interconductor

Pinout of the three types of serial interface are described below.



RS232

RS232 standards are defined by EIA/TIA (Electronic Industries Alliance /Telecommunications Industry Association). RS232 defines both the physical and electrical characteristics of the interface. RS232 is an Active LOW voltage driven interface and operates at +12V to -12V. RS232 is a serial interface for the transmission of point to point digital data. Description of the connector's pins is from DTE to DCE. The RBS acts as a DCE.

RS232 female pinout		
PIN		Mean
1		not used
2	RX	Data from DCE to DTE
3	TX	Data from DTE to DCE
4		not used
5	GND	Ground
6		not used
7	RTS	Ready To Send (from DTE)
8	CTS	Clear To Send (to DTE)
9		not used

RS422

RS422 is a balanced serial interface for the transmission of point to point digital data. The advantage of a balanced signal is the greater immunity to noise. The EIA describes RS422 as a DTE to DCE interface for point-to-point connections. Description of the connector's pins is from DTE to DCE. The RBS acts as a DCE.

RS422 female pinout (only on request)		
PIN		Mean
1	GND	Ground
2	TX +	Data from DTE to DCE
3		not used
4	RX +	Data from DCE to DTE
5	GND	Ground
6		not used
7	TX -	Data from DTE to DCE
8		not used
9	RX -	Data from DCE to DTE



RS485

RS485 is a balanced serial interface for the transmission of digital data. The advantage of a balanced signal is the greater immunity to noise. Point to point or multi-point behaviour of this serial interface is software dependent and is out of the scope of this manual. Description of the connector's pins is from DTE to DCE. The RBS acts as a DCE.

RS485 female pinout (only on request)		
PIN		Mean
1		not used
2	RTX +	Data
3		not used
4		not used
5	GND	Ground
6		not used
7	RTX -	Data
8		not used
9		not used



6.4.7 Digital Input/Output Interface

The RBS manages 4 digital outputs. The connector is located on the rear of the RBS and is shown in red in the following figure.

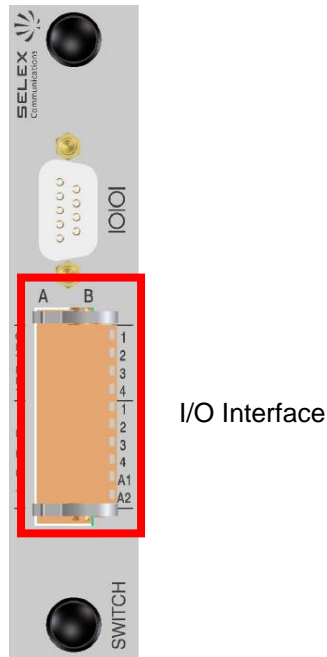

Interconnecting points	Type of connector terminating the cable	Type of cable/conductor
User I/O	Socket block B2L 3.5/20LH	Section of each wire \leq 1 sq.mm. (AWG 18)

I/O Socket block B2L male pinout		
type	contact	
out	1	power supply alarm (*)
out	2	temperature alarm (*)
out	3	synchronization alarm (*)
out	4	RF power alarm (*)
in	1	not used
in	2	not used
in	3	not used
in	4	not used
in	A1	not used
in	A2	not used

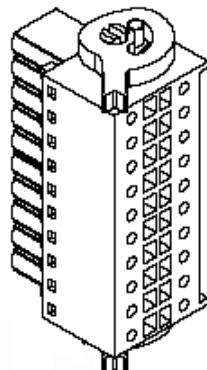



(*) The meaning of the digital outputs depends on the firmware release of the RBS.

In the shown example the meaning is as follows:

- ✓ Output 1: power supply alarm. When the RBS is supplied from battery the output is closed.
- ✓ Output 2: RBS temperature alarm. When the temperature is over a defined maximum value the output is closed.
- ✓ Output 3: RBS synchronization alarm. When the RBS loses synchronisation the output is closed.
- ✓ Output 4: RF power alarm. When the PA transmitting power is 3 dB below the right power level the output is closed.



6.4.8 Local Microphone Interface

The local microphone interface permits to connect a microphone to the RBS. Features related with PTT press and the AF of the microphone are out of the scope of this manual.

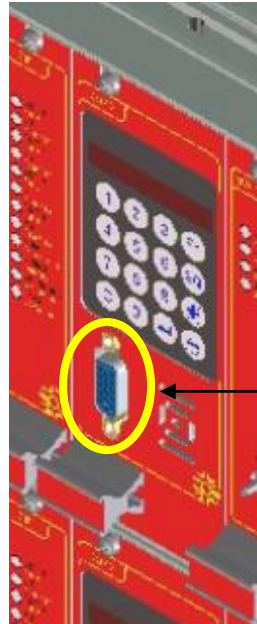

Local Microphone Interface

Interconnecting points	Type of connector terminating the cable	Type of cable/conductor
Microphone	Male type D high density connector with 15 pins	Section of each wire \leq 1 sq.mm. (AWG 18)



Microphone



D-SUB HD 15 female pinout		
PIN		Mean
1	GND	Ground
2		not used
3		not used
4		not used
5		not used
6	AF in	Audio Frequency input to RBS
7		not used
8		not used
9		not used
10		not used
11	PTT	Push To Talk input to RBS
12		not used
13	DGND	Digital Ground
14		not used
15	VDD	

(soldering side view)



7. Configuration

The hardware configuration, where applicable, is described in the installation section of this manual. Hardware configuration is limited only to hardware related characteristics such as electrical interfaces.

A parameter configuration must be done to adjust each device to the user need. This procedure is described in the manual of the configuration software. Please refer to it for more information.

A list of values for each parameter for each device is provided in a separate document on demand. Please refer to it to set the proper value for each parameter.

To connect the PC with the configuration software to the RBS follow the procedure described in the Local Maintenance Interface section.

8. Maintenance

8.1 Module features, alarms and troubleshooting

8.1.1 CORE module - CORE



The CORE module, for its versatility and potentiality, is the core of ECOS-D RBS. This module is equipped with devices for numerical computation (DSP, FPGA) and control (microprocessor).

The primary functionalities of the Core Module are:

- MMI (Man Machine Interface) to allow an operator to interact with the device
- Main Simulcast Management, implementing the voting algorithm, equalization and a matrix of AF signals.
- local and remote management of the device.

The module is able to receive the input reference source from multiple clock signals:

- Internal GPS receiver (up to 2)
- AF tone (eg, tone at 3400 Hz via from an external source through LIF or DIF module)
- 2,048 MHz (G.703)

The choice of input clock signal is performed according to a configurable logic that normally assigns higher priority to the GPS signal.

The module provides as its output the following clock signals to all the other modules of the RBS:

- RBS main reference clock (26 MHz)
- PPS main and / or spare



The CORE module can accommodate also two option boards:

- The SolP piggy back (Simulcast over IP) that allows the CORE module to manage IP link towards other RBS
- The Vocoder piggy back, that allows the CORE module to manage the digital voice

The CORE MMI makes available to a technical operator the following functionalities.

- Radio frequencies settings (RX e TX);
- RF transmission power settings (Hi / Low);
- Enable / disable of input/output lines (radio and wired);
- Speak and listen on selectable interfaces;
- Measures:
 - power supply (V);
 - RSSI (dBm);
 - RF transmit power (dBm);
- voted signal;
- Selection and management of Audio Frequency (AF) signals for test purposes;
- Lock / unlock of voice in local speaker (radio squelch or criterions);
- Speaker volume setting;
- Display brightness setting;
- Menu language setting;

The MMI is composed by a 8 characters display (each character is 5 x 7 pixels) and a Keypad

The keypad is composed by 16 buttons: SQ (Squelch), Fn (Function), +, -, ↵, C (cancel) and 0 ÷ 9. In the following a brief summary of their use is given.

- SQ** Use it to open/close the analog squelch of the device
- Fn** Use it to switch between stand-by mode and menu mode.
- + / -** These are multi-function buttons: they are used for navigation in menu, to up and down speaker volume and display brightness.
- ↵** in menu mode use it to confirm the choice.
- C** In menu mode use it to go back to previous menu.
- 0 ÷ 9** In menu mode use them to insert the value of parameters where required



The menu tree is described in the following table.

Menu level					
1	2	3	4	5	
1. Settings	1. Radio	1. View Freq.	RTX	1. Freq.RX	
			RRX	2. Freq.TX	
		2. RF Power	PA	1. Freq.RX1	
				2. Freq.RX2	
				1. Low	
			2. Hi		
	2. Display	1. Brightn.			
		2. Language	Italiano		
			English		
3. Network	1. IP Address				
		2. Net mask			
2. Spk/Lstn	1. RTX				
	LIF	1. L1			
		2. L2			
		3. L3			
		4. L4			
	2. DIF	1. L1			
		2. L2			
		3. L3			
		4. L4			
	3. CORE				
	3. Commands	1. Inhibit	RTX	1. RX	ON
					OFF
				2. TX	ON
				OFF	
RRX			1. RX1	ON	
				OFF	
			2. RX2	ON	
				OFF	
LIF			1. L1	ON	
				OFF	
			2. L2	ON	
				OFF	
		1. L3	ON		
			OFF		
		2. L4	ON		
			OFF		
2. Voice		1. Digital	1. TS 1		
			2. TS 2		
		2. Analog			
3. Stb. Inf.					
4. Measure	1. RSSI	RTX			
	2. DC				
	3. Voter				
	4. RF Power	PA			
	5. IP Link	ON			
		OFF			
5. AF Test	RTX				
6. Status	1. Monitor	ON			
		OFF			
	2. GPS FIX	M GPS			
		S GPS			
	3. Sync. Log	List			
		Cancel			
7. Diagnostic	1. Monitor	ON			



Menu level				
1	2	3	4	5
		OFF		
	2. Err Log	List		
		Cancel		

8.1.2 4 Lines Interface module – LIF



The "4 Lines Interface" (LIF) module is the module that is able to manage up to 4 lines with 4W interface + (E&M). This module is equipped with devices for numerical computation (DSP, FPGA) and control (microprocessor) combined with the electrical interfaces for the 4 wires lines.

The "Line Interface" (LIF) module is also able to manage redounded links over the 4 wires interfaces.

4 wires interfaces are used by the device to connect this Radio Base Station to up to other 4 Radio Base Stations to build a Simulcast network.

The front panel is provided with bi-color leds to help in troubleshooting the system. The table below describes the meaning of the leds:

LED	Color	Label	Description
1	Green	Line 1 RX	Line 1 on RX
	Red	Line 1 TX	Line 1 on TX
2	Green	Line 2 RX	Line 2 on RX
	Red	Line 2 TX	Line 2 on TX
3	Green	Line 3 RX	Line 3 on RX
	Red	Line 3 TX	Line 3 on TX
4	Green	Line 4 RX	Line 4 on RX
	Red	Line 4 TX	Line 4 on TX
5	Green	Status1	
	Red	DATA bus fail	failure MTCH of DSP
6	Green	Status2	
	Red	Logic fail	µP and DSP not communicate
7	Green	CTRL bus busy	Activity on Control Bus
	Red	CTRL bus fail	failure of BUS µP
8	Green	Upload	Ongoing download code
	Red	Upload Fail	Download code KO



8.1.3 Digital Interface module – DIF

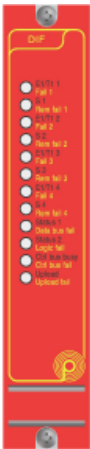

The "Digital Interface" (DIF) module is the module that is able to manage up to 4 digital E1 streams. This module is equipped with devices for numerical computation (DSP, FPGA) and control (microprocessor) combined with the electrical interfaces for the E1 streams.

The DIF module is also able to provide cross-connect and add / drop functionality over the 4 E1 streams.

The DIF module is the digital interface of the RBS with the outside world. As already said it handles the digital aggregated flows (compliant to E1 G.703/G704 standard). These link are used to carry voice and data information to / from other RBS to build a Simulcast network.

The device makes use of one of the 30 channels (64 kbit/s) available in a 2,048 Mb/s E1 for communications with other RBS and makes them available inside the station. The module has also the cross-connect and add / drop functionalities, being able to redirect all the 120 channels according to a predetermined matrix.

The front panel is provided with bi-color leds to help in troubleshooting the system. The table below describes the meaning of the leds:

LED	Color	Label	Description
1	Green	E1/T1 1	E1/T1 #1 link enabled and correctly operating
	Red	Fail 1	E1/T1 #1 link enabled and LOS alarm is present
	Red blink	Fail 1	E1/T1 #1 link enabled and LOF or LOFAS or BER > FW defined threshold alarm is present
2	Green blink	S1	E1/T1 #1 used as sync reference
	Red	Rem fail 1	E1/T1 #1 link enabled and AIS alarm is present
	Red blink	Rem fail 1	E1/T1 #1 link enabled and RAI or RAI-AS alarm is present
3	Green	E1/T1 2	E1/T1 #2 link enabled and correctly operating
	Red	Fail 2	E1/T1 #2 link enabled and LOS alarm is present
	Red blink	Fail 2	E1/T1 #2 link enabled and LOF or LOFAS or BER > FW defined threshold alarm is present
4	Green blink	S2	E1/T1 #2 used as sync reference
	Red	Rem fail 2	E1/T1 #2 link enabled and AIS alarm is present
	Red blink	Rem fail 2	E1/T1 #2 link enabled and RAI or RAI-AS alarm is present
5	Green	E1/T1 3	E1/T1 #3 link enabled and correctly operating
	Red	Fail 3	E1/T1 #3 link enabled and LOS alarm is present
	Red blink	Fail 3	E1/T1 #3 link enabled and LOF or LOFAS or BER > FW defined threshold alarm is present
6	Green blink	S3	E1/T1 #3 used as sync reference
	Red	Rem fail 3	E1/T1 #3 link enabled and AIS alarm is present
	Red blink	Rem fail 3	E1/T1 #3 link enabled and RAI or RAI-AS alarm is present
7	Green	E1/T1 4	E1/T1 #4 link enabled and correctly operating



	<i>Red</i>	Fail 4	E1/T1 #4 link enabled and LOS alarm is present
	<i>Red blink</i>	Fail 4	E1/T1 #4 link enabled and LOF or LOFAS or BER > FW defined threshold alarm is present
8	<i>Green blink</i>	S4	E1/T1 #4 used as sync reference
	<i>Red</i>	Rem fail 4	E1/T1 #4 link enabled and AIS alarm is present
	<i>Red blink</i>	Rem fail 4	E1/T1 #4 link enabled and RAI or RAI-AS alarm is present
9	<i>Green Blink</i>	Status 1	In a RBS with an upper E1 link when E1 link is out of service and the Radio local loop is enabled
	<i>Red</i>	Data bus fail	The multichannel data bus is out of frame sync
10	<i>Green</i>	Status 2	All the enabled channel on the E1 link arriving to the RBS are equalized
	<i>Red</i>	Logic fail	One of the these error is present: - DSP/uP/FPGA communication failure - FALC hardware failure - logic PLL unlock
	<i>Red blink</i>	Logic fail	One of the these error is present: - boot failure - EEPROM failure
11	<i>Green</i>	Control bus busy	Activity on the control bus
	<i>Red</i>	Control bus fail	control bus among the modules is in failure
	<i>Red blink</i>	Control bus fail	Bad message received
12	<i>Green</i>	Upload	Firmware upload in progress
	<i>Red</i>	Upload fail	Firmware upload failed

8.1.4 Double Radio Receiver module – RRX



The “Double Radio Receiver” (RRX) module module realizes a full duplex radio that work in the following frequency band commonly used in the LMR/PMR market: 806 ÷ 894 MHz.

It is able to operate with channel spacing of 12.5 kHz, 20/25 kHz.

Limitation on usable RF bands and channel spacing may apply due to local regulations.

This module is equipped with devices for numerical computation (DSP, FPGA) and control (microprocessor) combined with the radio receiver front-end and the transmitter driver.

The RRX module main functionalities are:

- Synchronization from external reference via CORE Master module
- Temperature control.
- Space Diversity

The front panel is provided with bi-color leds to help in troubleshooting the system. The table below describes the meaning of the leds:



LED	Color	Label	Description
1	Green	RX1 busy	RF signal present at the receiver 1
	Red	RX1 fail	Receiver 1 PLL unlock
	Red blink	RX1 fail	RX1 Equalizer failure
2	Green	RX2 busy	RF signal present at the receiver 2
	Red	RX2 fail	Receiver 2 PLL unlock
	Red blink	RX2 fail	RX2 Equalizer failure
3	Green	Status 1	RF signal with analog modulation present at the receiver 1
	Red	RX1 inhibit	Receiver 1 is in inhibited state
4	Green	Status 2	RF signal with analog modulation present at the receiver 2
	Red	RX2 inhibit	Receiver 2 is in inhibited state
5	Green	Status 3	Reserved
	Red	Data bus fail	The multichannel data bus is out of frame sync
6	Green	Status 4	Reserved
	Red	Logic fail	One of the these error is present: - DSP/uP communication failure - logic PLL unlock
	Red blink	Logic fail	One of the these error is present: - boot failure - EEPROM failure
7	Green	Control bus busy	Activity on the control bus
	Red	Control bus fail	control bus among the modules is in failure
	Red blink	Control bus fail	Bad message received
8	Green	Upload	Firmware upload in progress
	Red	Upload fail	Firmware upload failed



8.1.5 Switch module – SWITCH



The Switch module realizes a "solid state" switch (MOSFET) device for the distribution of the power necessary for the proper working of all the modules of the ECOS-D RBS. In particular its primary task is to distribute the 13.2 Vdc nominal voltage (Master voltage) and 7 Vdc nominal voltage (Slave voltage).

The 7 Vdc Slave voltage is used by all the other modules to power their logic. It is generated by the switch module for direct conversion from the 13.2 Vdc Master voltage.

The switch module provides:

- ON / OFF of all the modules on the same RBS
- Protection against Extra Current (short circuit or overload > 22 A ± 5%)
- Protection against Extra voltage (maximum input voltage equal to 30 Vdc ± 5%)
- Protection against voltages outside the guaranteed operating range [10.8 ÷ 15.6 Vdc].
- Protection against reverse polarity input voltage.
- Protection against over temperature inside the module itself ($\geq 100\text{ }^{\circ}\text{C} \pm 1\%$).

The front panel is provided with bi-color leds to help in troubleshooting the system. The table below describes the meaning of the leds:

LED	Color	Label	Description
1	Green	Vin OK	Normally operating
	Red	Vin fail	Input voltage out of range
2	Green	Vout ok	RBS internal voltage levels are correct
	Red	Vout fail	RBS internal voltage failure
3	Green	Control bus busy	Activity on the control bus
	Red	Control bus fail	control bus among the modules is in failure
	Red blink	Control bus fail	Bad message received
4	Green	Upload	Firmware upload in progress
	Red	Upload fail	Firmware upload failed



8.1.6 DC/DC module – DC/DC



The DC/DC module is a continue power voltage converter from an external power source (range $V_{in} = 35 \div 75$ Vdc) to the internal power level of ECOS-D devices. The converter, other than the power voltage conversion, is able to galvanically insulate (1500Vrms) the internal 13,2 Vdc power distribution from the external power source and a 28 Vdc power distribution to the 110W PA module.

LED	Color	Label	Description
1	Green	Vout OK	Normally operating
	Red	NA	
2	Green	Vin OK	Normally operating
	Red	NA	

8.1.7 Radio Receiver and Transmitter module – RTX



The “Radio Receiver and Transmitter” (RTX) module realizes a full duplex radio that work in the following frequency band commonly used in the LMR/PMR market: 806 ÷ 894 MHz.

It is able to operate with channel spacing of 12.5 kHz, 20/25 kHz.

Limitation on usable RF bands and channel spacing may apply due to local regulations.

This module is equipped with devices for numerical computation (DSP, FPGA) and control (microprocessor) combined with the radio receiver front-end and the transmitter driver.

The RTX module main functionalities are:

- Dynamic Dual mode radio operations with support of digital and analog modulation
- Synchronization from external reference via CORE Master module
- Temperature control.
- radio parameter compliant with: FCC part 90, FCC part 15B and TS 102 361



The front panel is provided with bi-color leds to help in troubleshooting the system. The table below describes the meaning of the leds:

LED	Color	Label	Description
1	Green	RX busy	RF signal present at the receiver
	Red	RX fail	Receiver PLL unlock
	Red blink	RX fail	RX Equalizer failure
2	Green	TX on	RF exciter correctly On Air
	Red	TX fail	RF exciter failure: - bad power out - ACP failure - Exciter PLL unlock
	Red blink	TX fail	TX dynamic equalizer failure
3	Green	Status 1	RF signal with analog modulation present at the receiver
	Red	RX inhibit	Receiver is in inhibited state
4	Green	Status 2	RF exciter correctly On Air with digital modulation
	Red	Tx inhibit	Exciter is in inhibited state
5	Green	Status 3	Reserved
	Red	Data bus fail	The multichannel data bus is out of frame sync
6	Green	Status 4	Reserved
	Red	Logic fail	One of the these error is present: - DSP/uP communication failure - logic PLL unlock
	Red blink	Logic fail	One of the these error is present: - boot failure - EEPROM failure
7	Green	Control bus busy	Activity on the control bus
	Red	Control bus fail	control bus among the modules is in failure
	Red blink	Control bus fail	Bad message received
8	Green	Upload	Firmware upload in progress
	Red	Upload fail	Firmware upload failed



8.1.8 Power Amplifier module – PA

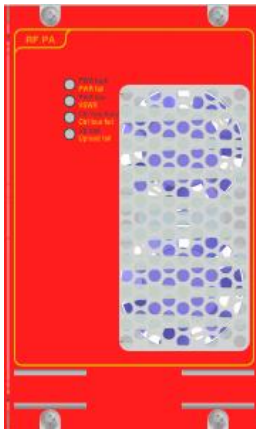

The “Power Amplifier” (PA) module is a wide band RF amplifier in UHF frequency band: 806 ÷ 894 MHz.

Their time of TX ramp up/down is less than 1200 µsec. This makes the module compatible with the stringent demands of digital transmission.

Thanks to a microprocessor mounted on board, the module is able to implement the PUFF technology (Powerful Universal Forming Function) for the shaping of transient power in order to obtain compliance with the rapid transient rules of ACP (Adjacent Channel Power).

The microprocessor also manages completely the operation of the module: this would remove any calibration procedures. All configuration changes are performed via software.

Other main functionalities are:

- continuous transmitter’s operations (100% duty cycle).
- Output power selectable between two values (Phi and Plo), each of which can be SW set to a nominal value between 10 and 110 Watts.
- final stage protected against excessive mismatching output power. In the case that VSWR remains above a set threshold (eg ReturnLoss = 5dB) for more than a fixed time, the module is able to send an alert and the output power will not exceed a safety value (eg ≤ 10watt).
- temperature threshold alarm: if the temperature remains above a set value for more than a fixed time, the module is able to send an alert and will ensure that the RF output power will not exceed a predetermined safe value.

The front panel is provided with bi-color leds to help in troubleshooting the system. The table below describes the meaning of the leds:

LED	Color	Label	Description
1	Green	PWR High	High Power level selected and correctly On Air
	Red	PWR fail	Emitted power less than a FW configured threshold (3 dB typical)
2	Green	PWR low	Low Power level selected and correctly On Air
	Red	VSWR	On Air and VSWR level is greater than FW configured threshold
3	Green	Control bus busy	Activity on the control bus



	<i>Red</i>	Control bus fail	control bus among the modules is in failure
	<i>Red blink</i>	Control bus fail	Bad message received
4	<i>Green</i>	Upload	Firmware upload in progress
	<i>Red</i>	Upload fail	Firmware upload failed



8.2 Power modules maintenance precaution

Before maintenance operations involving power supply modules the power cable must be removed.



The connector of the power cable supplied with the product is the means to disconnect the device from the power source.

If the purpose of the maintenance is the replacement of the SWITCH or DC/DC modules the following procedure must be followed:

48 Vdc powered devices:

- Switch off the device moving to the lower position the Main Power on/off switch, than the RBS Power on/off switch.

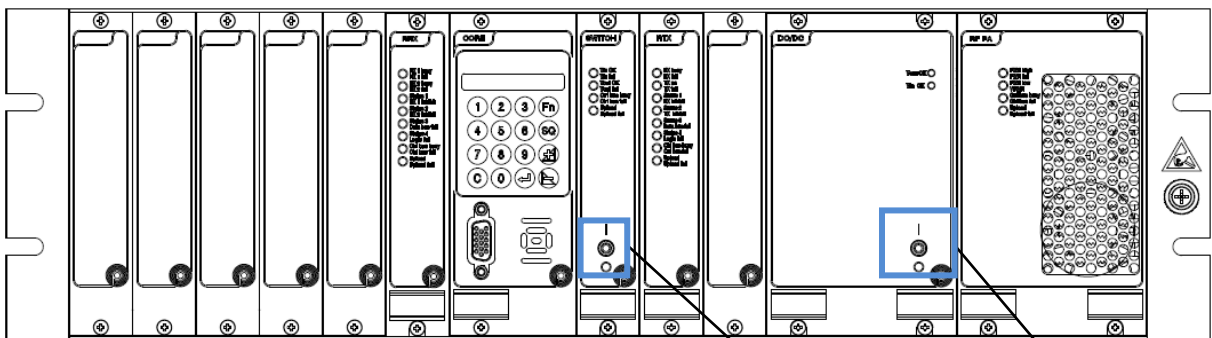

RBS Power on/off switch Main Power on/off switch

- unplug the 48Vdc D-SUB 3W3 connector

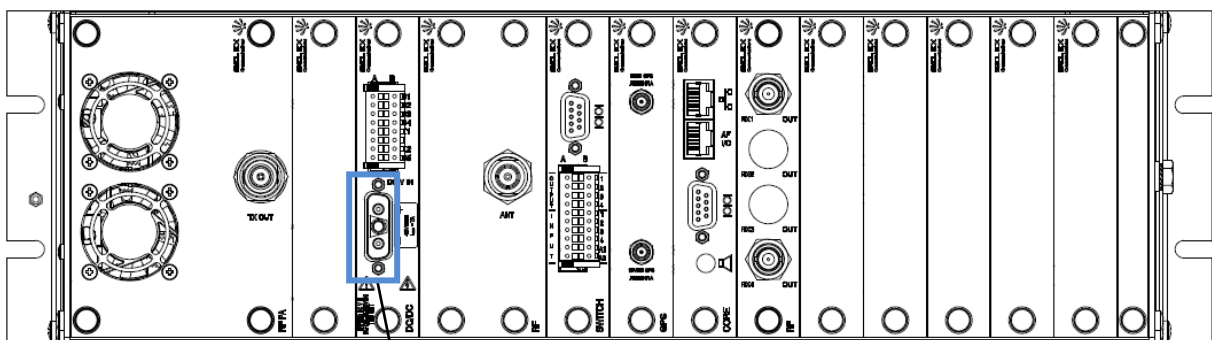

48 VDC input

- Remove the modules as described in section 8.3.



8.3 Module removal

To remove a module from the RBS follows the procedure described below.

1 – Unscrew the two (or four) screws marked in green on the front panel of the module

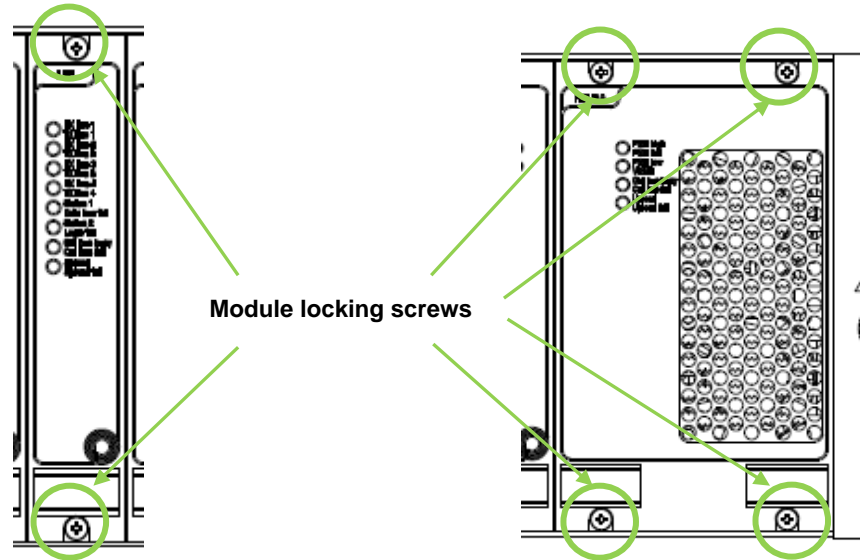

2 – From the front side of the RBS using the handle marked in green pull the module out.

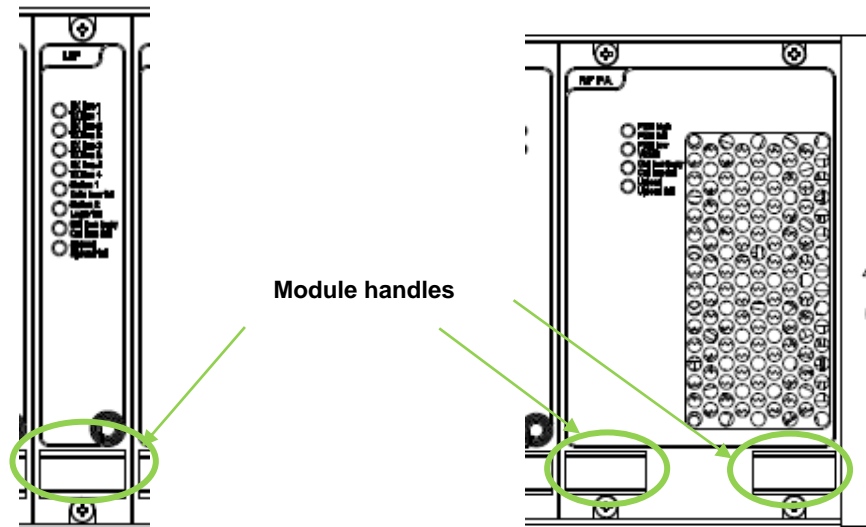



8.4 Back card removal

To remove a back card from the RBS follows the procedure described below.

1 – Unlock the two (or four) knobs marked in green on the panel of the back card

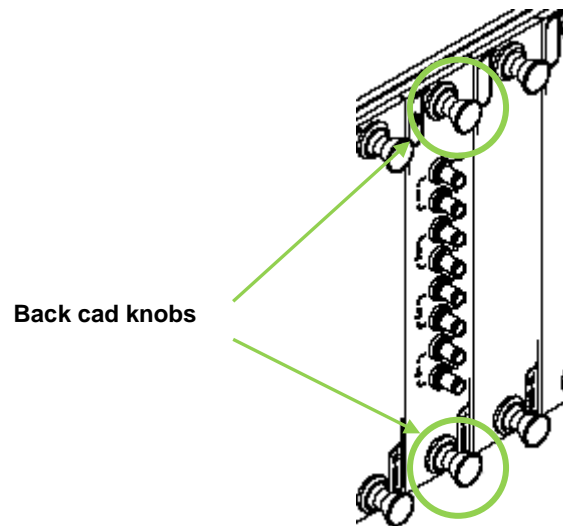

2 – From the rear side of the RBS using the same knobs pull the back card out.



8.5 Local Maintenance Interface

The local maintenance interface is located on the front panel of the RBS on the CORE module.

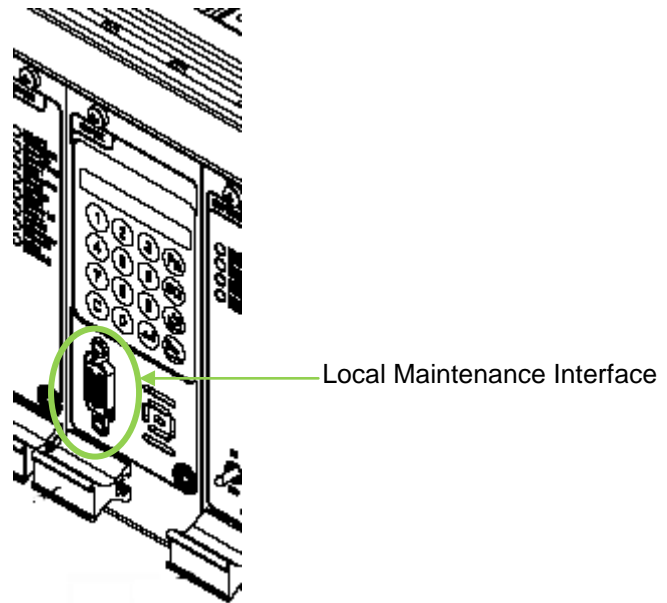

To perform local Maintenance and local configuration of the RBS, connect a PC to this connector using the appropriate LAN adapter.

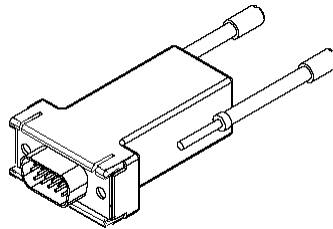

Maintenance LAN Adapter



D-SUB HD 15 female pinout		
PIN		Mean
1		not used
2		not used
3		not used
4		not used
5	TX-	Transmit Data -
6		not used
7	RX-	Receive Data -
8		not used
9	TX+	Transmit Data +
10		not used
11		not used
12	RX+	Receive Data +
13	DGND	Digital Ground
14	FLP	Front LAN Presence
15		not used

(soldering side view)

LAN RJ45 female pinout		
PIN		
1	RX+	Receive Data +
2	RX-	Receive Data -
3	TX+	Transmit Data +
4		not used
5		not used
6	TX-	Transmit Data -
7		not used
8		not used



8.6 Local Test AF Interface

The local Audio Frequency interface is located on the front panel of the RBS on the CORE module.

Use this interface to test the AF performance of the RBS.

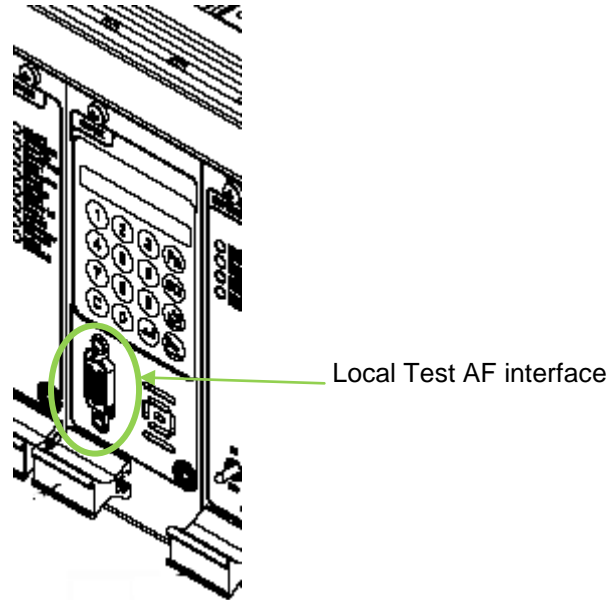

Interconnecting points	Type of connector terminating the cable	Type of cable/conductor
Microphone	Male type D high density connector with 15 pins	Section of each wire ≤ 1 sq.mm. (AWG 18)



D-SUB HD 15 female pinout		
PIN		Mean
1	GND	Ground
2	AF FO	Audio Frequency Output (no volume)
3		not used
4	AF out -	Audio Frequency output from RBS
5		not used
6	AF in	Audio Frequency input to RBS
7		not used
8		not used
9		not used
10	AF out +	Audio Frequency output from RBS
11	PTT	Push To Talk input to RBS
12		not used
13	DGND	Digital Ground
14		not used
15	VDD	

(soldering side view)



8.7 Remote Maintenance Interface

The Remote maintenance interface may be accessible directly or not on each RBS depending on the configuration of the system.

If the RBS is configured to be remotely controlled via the LAN interface; see the LAN interface section to correctly connect the RBS.

For more information about the remote maintenance procedure see the Network Management System (NMS) Manual, where supplied.



Intentionally left blank

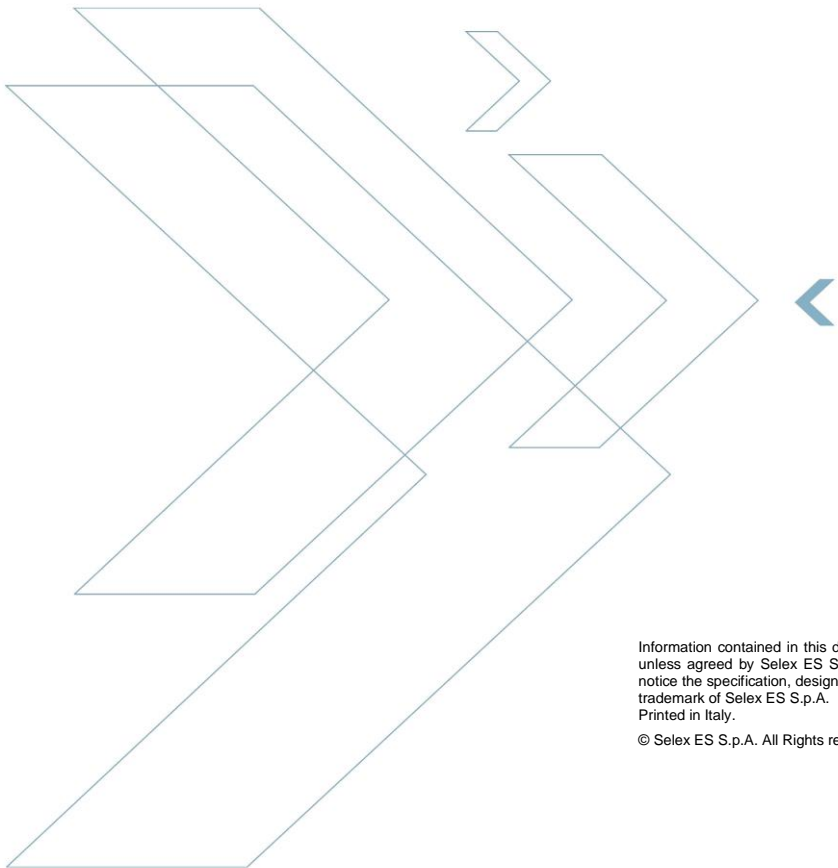

Information contained in this document may not be used, applied or reproduced for any purpose unless agreed by Selex ES S.p.A. in writing. Selex ES S.p.A. reserves the right to alter without notice the specification, design or conditions of supply of any product or service. Selex ES logo is a trademark of Selex ES S.p.A.
Printed in Italy.

© Selex ES S.p.A. All Rights reserved.