

11b/g Long Range Multi-Function AP

EOA3630



User's Manual

Version : 1.0

Table of Contents

11B/G LONG RANGE MULTI-FUNCTION AP	0
EOA3630	0
USER'S MANUAL	0
1 PRODUCT OVERVIEW	3
1.1 FEATURE.....	3
1.2 BENEFITS.....	4
1.3 PACKAGE CONTENTS	5
1.4 SYSTEM REQUIREMENT	6
1.5 HARDWARE OVERVIEW	6
2 EOA3630 MULTI-FUNCTION INSTRUCTION GUIDE	7
2.1 ACCESS POINT	7
2.2 ACCESS POINT WITH WDS FUNCTION.....	7
2.3 CLIENT BRIDGE	8
2.4 WDS BRIDGE.....	8
2.5 REPEATER	9
2.6 AP ROUTER	9
2.7 CLIENT ROUTER	10
3 COMPUTER CONFIGURATION INSTRUCTION	11
3.1 ASSIGN A STATIC IP.....	11
3.2 LOGGING METHOD.....	12
4 WIRELESS CONFIGURATION	13
4.1 SWITCHING OPERATION MODE	13
4.2 WIRELESS SETTINGS	14
4.2.1 Access Point Mode	14
4.2.2 Client Bridge Mode	16
4.2.3 WDS Bridge Mode.....	17
4.2.4 Repeater Mode	18
4.2.5 AP Router Mode.....	19
4.2.6 Client Router Mode	21
4.3 WIRELESS SECURITY SETTINGS	22
4.3.1 WEP.....	22
4.3.2 WPA-PSK	23
4.3.3 WPA2-PSK	23
4.3.4 WPA-PSK Mixed.....	24
4.3.5 WPA	25

4.3.6 WPA2	26
4.3.7 WPA Mixed.....	27
4.3.8 Radius Accounting.....	28
4.4 WIRELESS ADVANCED SETTINGS	29
4.5 WIRELESS MAC FILTER	30
4.6 WDS LINK SETTINGS	31
5 LAN SETUP	32
5.1 IP SETTINGS.....	32
5.2 SPANNING TREE SETTINGS	33
6 ROUTER SETTINGS	34
6.1 WAN SETTINGS.....	34
6.1.1 Static IP.....	34
6.1.2 DHCP (Dynamic IP).....	35
6.1.3 PPPoE (Point-to-Point Protocol over Ethernet).....	37
6.1.4 PPTP (Point-to-Point Tunneling Protocol).....	39
6.2 LAN SETTINGS (ROUTER MODE)	41
6.3 VPN PASS THROUGH	42
6.4 PORT FORWARDING.....	43
6.5 DMZ.....	44
7 INFORMATION STATUS	45
7.1 MAIN	45
7.2 WIRELESS CLIENT LIST.....	46
7.3 SYSTEM LOG	47
7.4 WDS LINK STATUS	48
7.5 CONNECTION STATUS	48
7.6 DHCP CLIENT TABLE	49
8 MANAGEMENT SETTINGS	50
8.1 ADMINISTRATION.....	50
8.2 MANAGEMENT VLAN	51
8.3 SNMP SETTINGS.....	52
8.4 BACKUP/RESTORE SETTINGS.....	53
8.5 FIRMWARE UPGRADE.....	53
8.6 TIME SETTINGS.....	54
8.7 LOG.....	55
8.8 DIAGNOSTICS	56
APPENDIX A – FCC INTERFERENCE STATEMENT.....	57
APPENDIX B – IC INTERFERENCE STATEMENT.....	58

1 Product Overview

Thank you for using EOA3630. It is a powerful, enhanced, enterprise scale product with 7 multi-functions Access Point, Access Point with WDS function, Client Bridge, WDS Bridge, Repeater, AP Router and Client Router.

EOA3630 is easily to install almost anywhere by wall mount kit and also support Power over Ethernet for quick installation. External N-type antenna provides better wireless signal quality and the antenna is upgradeable.

EOA3630 can manage power level control, Narrow bandwidth selection, Traffic shaping and Real-time RSSI indicator. EOA3630 is fully support of security encryption including WI-Fi Protected Access (WPA-PSK/WPA2-PSK), 64/128/152-bit WEP Encryption and IEEE 802.1x with RADIUS Accounting.

1.1 Feature

The following list describes the design of the EOA3630 made possible through the power and flexibility of wireless LANs:

a) Difficult-to-wire environments

There are many situations where wires cannot be laid easily. Historic buildings, older buildings, open areas and across busy streets make the installation of LANs either impossible or very expensive.

b) Temporary workgroups

Consider situations in parks, athletic arenas, exhibition centers, disaster-recovery, temporary offices and construction sites where one wants a temporary WLAN established and removed.

c) The ability to access real-time information

Doctors/nurses, point-of-sale employees, and warehouse workers can access real-time information while dealing with patients, serving customers and processing information.

d) Frequently changed environments

Show rooms, meeting rooms, retail stores, and manufacturing sites where frequently rearrange the workplace.

e) Wireless extensions to Ethernet networks

Network managers in dynamic environments can minimize the overhead caused by moves, extensions to networks, and other changes with wireless LANs.

f) Wired LAN backup

Network managers implement wireless LANs to provide backup for mission-critical applications running on wired networks.

g) Training/Educational facilities

Training sites at corporations and students at universities use wireless connectivity to ease access to information, information exchanges, and learning.

1.2 Benefits

Features	Benefits
High Speed Data Rate Up to 108Mbps	Capable of handling heavy data payloads such as MPEG video streaming
High Output Power	Extended excellent Range and Coverage
IEEE 802.11b/g Compliant	Fully Interoperable with IEEE 802.11b/IEEE 802.11g compliant devices
Watertight and Weatherproof	Avoid water invaded and weather corroded for different environment
Wall mount and mast mounting kit support	Building on any environment easily.
Detachable antenna support (N-Type)	Collocate with any antenna for user's environment
7 Multi-Function	Users can use different mode in various environment
Point-to-point, Point-to-multipoint Wireless Connectivity	Let users transfer data between two buildings or multiple buildings
Channel Bandwidth Selection	Using different bandwidth to reach varied distance
Support RSSI Indicator (CB mode)	Users can select the best signal to connect with AP easily
Power-over-Ethernet	Flexible Access Point locations and cost savings. EOA3630 must uses the adapter provided in the package.
Support Multi-SSID function (4 SSID) in AP mode	Allow clients to access different networks through a single access point and assign different policies and functions for each SSID by manager
WPA2/WPA/ WEP/ IEEE 802.1x support	Fully support all types of security types.
MAC address filtering in AP mode	Ensures secure network connection

PPPoE/PPTP function support (AP Router/CR mode)	Easy to access internet via ISP service authentication
SNMP Remote Configuration Management	Help administrators to remotely configure or manage the Access Point easily.
QoS (WMM) support	Enhance user performance and density
High Speed Data Rate Up to 108Mbps	Capable of handling heavy data payloads such as MPEG video streaming

1.3 Package Contents

Open the package carefully, and make sure that none of the items listed below are missing. Do not discard the packing materials, in case of return; the unit must be shipped in its original package.

- 1* Wireless Long Range Multi-Function AP (EOA3630)
- 1* 24V/0.6A Power Adapter
- 1* Mounting kit
- 1* QIG
- 1* CD (User Manual)
- 1* 5dBi 2.4GHz Dipole Antennas

Auction1: Using other Power Adapter than the one included with EOA3630 may cause damage of the device.

Auction2: Please refer below diagram to install the mounting kit.

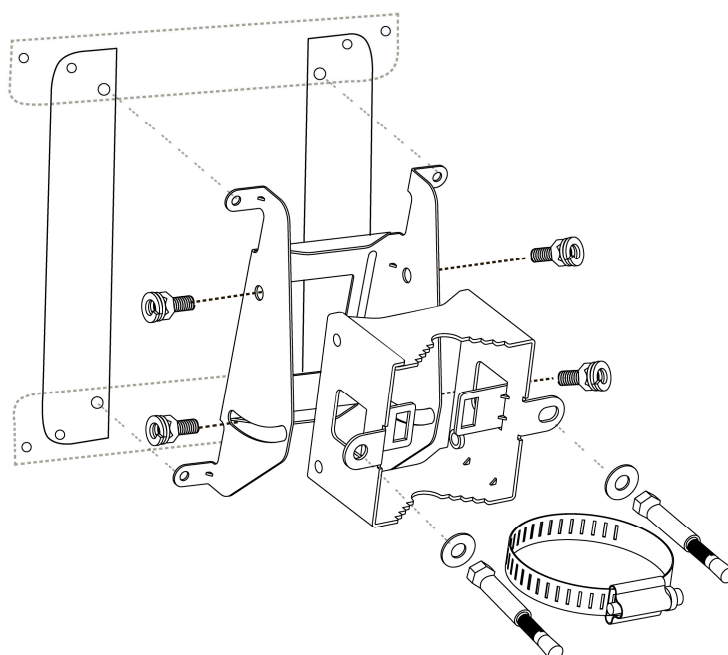

1.4 System Requirement

The following conditions are the minimum system requirement.

- A computer with an Ethernet interface and operating under Windows XP, Vista, 7 or Linux.
- Internet Browser that supports HTTP and JavaScript.

1.5 Hardware Overview

MCU	Atheros SoC, 180MHz
Memory	32MB SDRAM
Flash	8MB
Physical Interface	- LAN: One 10/100 Fast Ethernet RJ-45 - Reset Button
LEDs Status	1 x Power/ Status 1 x LAN (10/100Mbps) 1 x WLAN (Wireless is up) 3 x Link Quality (Client Bridge mode) <ul style="list-style-type: none">• Green: Good Quality• Yellow: Marginally Acceptable Quality• Red: Bad Quality
Power Requirements	Active Ethernet (Power over Ethernet) 24V / 0.6A
Regulation Certifications	FCC Part 15 / UL, ETSI 300 / 328 / CE

2 EOA3630 Multi-Function Instruction Guide

2.1 Access Point

In the Access Point Mode with WDS Function, EOA3630 function like a central connection for any stations or clients that support IEEE 802.11b/g and SuperG network. Stations and Client must configure the same SSID and Security Password to associate within the range. EOA3630 supports 4 different SSIDs to separate different clients at the same time.



2.2 Access Point with WDS Function

EOA3630 also supports WDS function in Access Point Mode without losing AP's capabilities. Configure others Access Point's Wireless MAC Address in both Access Point devices to enlarge the wireless area by enabling WDS Link Settings. WDS function can support up to 8 different AP's MAC addresses.

Auction: Not every Access Point device has support WDS in Access Point Mode. It is recommended using EOA3630 if you would like to use this service.



2.3 Client Bridge

In the Client Bridge Mode, the EOA3630 function like a wireless dongle. Connected to an Access Point wirelessly and surf internet whenever you want. Using Site Survey to scan all the Access Point within the range and configure its SSID and Security Password to associate with it. Connect your station to the LAN port of the EOA3630 via Ethernet.



2.4 WDS Bridge

In the WDS Bridge Mode, the EOA3630 can wirelessly connect different LANs by just simply configure each other's MAC Address and Security Settings. This mode is used when two wired LANs locate in small distance and want to communicate each other. The best solution is using EOA3630 wirelessly connect two wired LANs. WDS Bridge Mode can establish 16 WDS links, the connection diagram is like a Star.

Auction: WDS Bridge Mode is not function like Access Point. APs linked by WDS are using the same frequency channel, more APs connected together may lower throughput. Please be aware to avoid loop connection diagram, otherwise enable Spanning Tree Function.

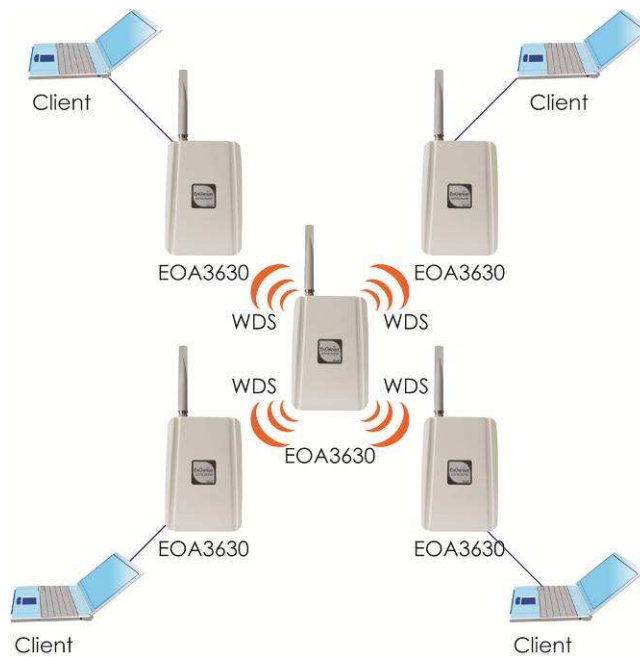

2.5 Repeater

In the Repeater Mode, the EOA3630 can extend the wireless coverage area of another Access Point or Wireless Router. Access Point or Wireless Router must be within the range and EOA3630 must use the same SSID, Security Password and Channel.



2.6 AP Router

In the AP Router Mode, the EOA3630 has DHCP server built inside that allows you to configure easily via wireless. AP Router Mode can also support four different SSIDs. Use wireless device to associate with EOA3630, connect an Ethernet through the WAN port. You can surf internet whenever you want

within the range.

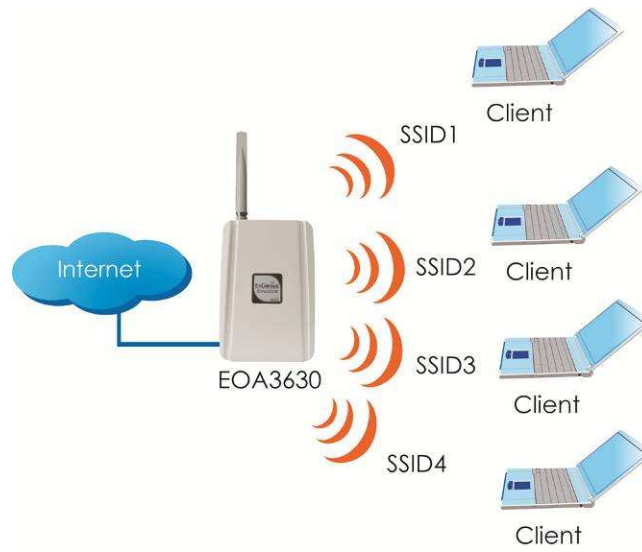

2.7 Client Router

In the Client Router Mode, the EOA3630 has DHCP Server build inside that allows many LANs automatically generate an IP address to share the same Internet. Connect an AP/WISP Wirelessly and connect to LANs via wired. Client Router Mode is act completely opposite to the AP Router Mode.



3 Computer Configuration Instruction

3.1 Assign a Static IP

In order to configure EOA3630, please follow the instruction below:

1. In the **Control Panel**, double click **Network Connections** and then double click on the connection of your **Network Interface Card (NIC)**. You will then see the following screen.

2. Select **Internet Protocol (TCP/IP)** and then click on the **Properties** button. This will allow you to configure the TCP/IP settings of your PC/Notebook

3. Select **Obtain an IP Address automatically** radio button and then enter the IP address and subnet mask. Ensure that the IP address and subnet mask are on the same subnet as the device.

4. Click on the **OK** button to close this window, and then close LAN properties window.

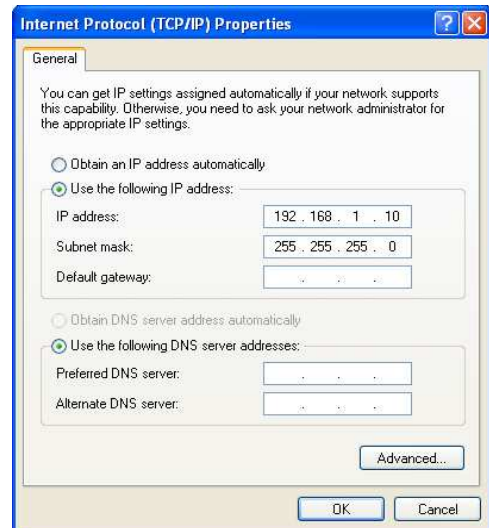
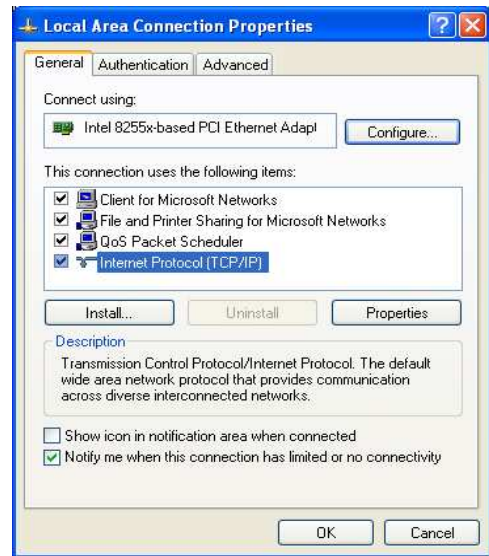

Auction: IP Address entered in the TCP/IP Properties needs to be at the same subnet of the EOA3630 IP Address. For example: EOA3630's default IP Address is **192.168.1.1** so the IP Address in the TCP/IP settings could be **192.168.1.10**.

3.2 Logging Method

After complete the IP settings from last section, you can now access the web-based configuration menu.

1. Open web browser

2. Enter IP **192.168.1.1** into you address filter.

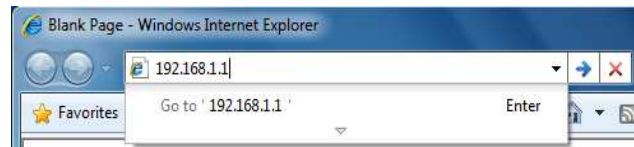

Auction: If you have changed the EOA3630 LAN IP address, make sure you enter the correct IP Address.

3. After connected to the EOA3630 successfully, browser will pop out a Windows Security window. Please enter the correct **Username** and **Password**.

4. The default Username and Password are both **admin**.



Auction: If you have changed the Username and Password, please enter your own Username and Password.

4 Wireless Configuration

4.1 Switching Operation Mode

The EOA3630 supports 6 different operation modes: Access Point, Client Bridge, WDS Bridge, Repeater, AP Router, and Client Router.

Click **System Properties** under System Section to begin.

Device Name: Specify a name for the device, but it is not the broadcast SSID.

Country/Region: United States.

Operation Mode: Select an operation mode via **Radio Button**.

Click **Apply** to save the changed.

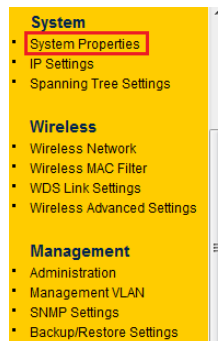

System Properties

Device Name	EOA3630
Country/Region	United States
Operation Mode	<input checked="" type="radio"/> Access Point <input type="radio"/> Client Bridge <input type="radio"/> WDS Bridge <input type="radio"/> Repeater <input type="radio"/> AP Router <input type="radio"/> Client Router

Note: If you would like to use Access Point with WDS Function mode, please select Access Point Mode and then enable WDS Link Settings function.

4.2 Wireless Settings

4.2.1 Access Point Mode

Wireless Network

[Home](#)
[Reset](#)

Wireless Mode	802.11b/g Mixed (2GHz/54Mbps) ▾
Channel / Frequency	Ch1-2.412GHz ▾ <input type="checkbox"/> Auto
AP Detection	<input type="button" value="Scan"/>

Current Profiles

SSID	Security	VID	Enable	Edit
EnGenius1	Open System/No Encryption	1	<input checked="" type="checkbox"/>	<input type="button" value="Edit"/>
EnGenius2	Open System/No Encryption	2	<input type="checkbox"/>	<input type="button" value="Edit"/>
EnGenius3	Open System/No Encryption	3	<input type="checkbox"/>	<input type="button" value="Edit"/>
EnGenius4	Open System/No Encryption	4	<input type="checkbox"/>	<input type="button" value="Edit"/>

Profile (SSID) Isolation	<input checked="" type="radio"/> No Isolation <input type="radio"/> Isolate all Profiles (SSIDs) from each other using VLAN (802.1Q) standard
--------------------------	--

Wireless Mode	Select the desired 802.11 standard modes or SuperG mode. There are four different modes and they are 802.11b, 802.11g Only, 802.11 b/g mixed and SuperG.
Channel / Frequency	The channel availability is based on the country's regulation.
Auto	Place a Check to enable Auto channel selection.
AP Detection	AP Detection can help to select a best channel by scan nearby area.
Current Profile	Configure up to four different SSIDs, it can help to divide group of clients to access the network. Press Edit to configure the profile and place a Check to enable extra SSID.
Profile Isolation	Restricted Client to communicate with different VID by Selecting the Radio button.

Auction: SuperG is a special feature in EOA3630. If the client does not support SuperG, it cannot establish a wireless connection successfully.

SSID Profile

Wireless Setting

SSID	<input type="text" value="EnGenius1"/> (1 to 32 characters)
VLAN ID	<input type="text" value="1"/> (1~4095)
Suppressed SSID	<input type="checkbox"/>
Station Separation	<input type="radio"/> Enable <input checked="" type="radio"/> Disable

Wireless Security

Security Mode	<input type="text" value="Disabled"/>
---------------	---------------------------------------

SSID	Specify the SSID for current profile.
VLAN ID	Specify the VLAN tag for current profile.
Suppressed SSID	Place a Check to hide the SSID. Client will not be able to see the broadcast SSID in Site Survey.
Station Separation	Select the Radio Button to allow / deny client to communicate each other.
Wireless Security	Please refer to the Wireless Security section.
Save / Cancel	Press Save to save the changes or Cancel to return previous settings.

4.2.2 Client Bridge Mode

Wireless Network

[Home](#)
[Reset](#)

Wireless Mode	802.11 b/g Mixed (2GHz/54Mbps) ▾
SSID	Specify the static SSID : <input type="text" value="EnGenius"/> (1 to 32 characters) Or press the button to search for any available WLAN Service. <input type="button" value="Site Survey"/>
Prefer BSSID	<input type="checkbox"/> <input type="text" value=""/> : <input type="text" value=""/> : <input type="text" value=""/> : <input type="text" value=""/> : <input type="text" value=""/> : <input type="text" value=""/>
WDS Client	<input type="radio"/> Enable <input checked="" type="radio"/> Disable

Wireless Mode	Select the desired 802.11 standard modes or SuperG mode. There are four different modes and they are 802.11b, 802.11g Only, 802.11 b/g mixed and SuperG.
SSID	Specify the SSID if known. SSID text box will be automatically fill in when select an AP in the Site Survey.
Site Survey	Using Site Survey to scan nearby APs and then select the AP to establish the connection.
Prefer BSSID	Specify the MAC address if known. Prefer BSSID text box will be automatically fill in when select an AP in the Site Survey.
WDS Client	Place a Radio button to Enable / Disable WDS Client.
Apply / Cancel	Press Apply to apply the changes or Cancel to return previous settings.

Site Survey

2.4GHz Site Survey

 :Infrastructure :Ad_hoc

BSSID	SSID	Channel	Signal	Type	Security	Network Mode
00:e0:4c:81:86:21	DinoNet	1	-86 dBm	B	WEP	<input checked="" type="checkbox"/>
00:13:77:c:6f:43	SMC	6	-105 dBm	G	NONE	<input checked="" type="checkbox"/>

Profile	After Site Survey, webpage will display all nearby area's Access Point. Click the BSSID if you would like to connect with it.
Wireless Security	Please refer to the Wireless Security section.

RefreshPress Refresh to scan again.

Auction: If the Access Point is suppressed its own SSID, SSID section will be blank, the SSID must be filled in manually.

4.2.3 WDS Bridge Mode

Wireless Network

[Home](#)[Reset](#)

Wireless Mode	802.11b/g Mixed (2GHz/54Mbps) ▼
Channel / Frequency	Ch1-2.412GHz ▼

Wireless Mode	Select the desired 802.11 standard modes or SuperG mode. There are four different modes and they are 802.11b, 802.11g Only, 802.11 b/g mixed and SuperG.
Channel / Frequency	The channel availability is based on the country's regulation.
Apply / Cancel	Press Apply to apply the changes or Cancel to return previous settings.

MAC Address	Enter the Access Point's MAC address that you would like to extend the wireless area into the MAC address filter.
Mode	Select Disable or Enable from the drop down list.
Apply / Cancel	Press Apply to apply the changes or Cancel to return previous settings.

Auction: The Access Point that you would like to extend the wireless area must enter your Access Point's MAC address. Not all Access Point supports this feature.

4.2.4 Repeater Mode

Wireless Network

[Home](#)
[Reset](#)

Wireless Mode	802.11 b/g Mixed (2GHz/54Mbps) ▾
SSID	Specify the static SSID : <input type="text" value="EnGenius"/> (1 to 32 characters) Or press the button to search for any available WLAN Service. <input type="button" value="Site Survey"/>
Prefer BSSID	<input type="checkbox"/> <input type="text" value=""/> : <input type="text" value=""/> : <input type="text" value=""/> : <input type="text" value=""/> : <input type="text" value=""/> : <input type="text" value=""/>
WDS Client	<input type="radio"/> Enable <input checked="" type="radio"/> Disable

Wireless Mode	Select the desired 802.11 standard modes or SuperG mode. There are four different modes and they are 802.11g Only, 802.11 b/g mixed and SuperG.
SSID	Specify the SSID if known. SSID text box will be automatically fill in when select an AP in the Site Survey.
Site Survey	Using Site Survey to scan nearby APs and then select the AP to establish the connection.
Prefer BSSID	Specify the MAC address if known. Prefer BSSID text box will be automatically fill in when select an AP in the Site Survey.
WDS Client	Place a Radio button to Enable / Disable WDS Client.
Apply / Cancel	Press Apply to apply the changes or Cancel to return previous settings.

Site Survey

2.4GHz Site Survey

 :Infrastructure :Ad_hoc

BSSID	SSID	Channel	Signal	Type	Security	Network Mode
00:e0:4c:81:86:21	DinoNet	1	-86 dBm	B	WEP	<input checked="" type="checkbox"/>
00:13:77:c:6f:43	SMC	6	-105 dBm	G	NONE	<input checked="" type="checkbox"/>

Profile	After Site Survey, webpage will display all nearby area's Access Point. Click the BSSID if you would like to connect with it.
Wireless Security	Please refer to the Wireless Security section.

Refresh

Press Refresh to scan again.

Auction: If the Access Point is suppressed its own SSID, SSID section will be blank, the SSID must be filled in manually.

4.2.5 AP Router Mode

Wireless Network

Home

Reset

Wireless Mode	802.11b/g Mixed (2GHz/54Mbps) ▾
Channel / Frequency	Ch1-2.412GHz ▾ <input type="checkbox"/> Auto
AP Detection	<input type="button" value="Scan"/>

Current Profiles

SSID	Security	VID	Enable	Edit
EnGenius1	Open System/No Encryption	1	<input checked="" type="checkbox"/>	<input type="button" value="Edit"/>
EnGenius2	Open System/No Encryption	2	<input type="checkbox"/>	<input type="button" value="Edit"/>
EnGenius3	Open System/No Encryption	3	<input type="checkbox"/>	<input type="button" value="Edit"/>
EnGenius4	Open System/No Encryption	4	<input type="checkbox"/>	<input type="button" value="Edit"/>

Profile (SSID) Isolation	<input checked="" type="radio"/> No Isolation <input type="radio"/> Isolate all Profiles (SSIDs) from each other using VLAN (802.1Q) standard
--------------------------	--

Wireless Mode

Select the desired 802.11 standard modes or SuperG mode. There are four different modes and they are 802.11b, 802.11g Only, 802.11 b/g mixed and SuperG.

Channel / Frequency

The channel availability is based on the country's regulation.

Auto

Place a **Check** to enable Auto channel selection.

AP Detection

AP Detection can help to select a best channel by scan nearby area.

Current Profile

Configure up to four different SSIDs, it can help to divide group of clients to access the network. Press **Edit** to configure the profile and place a **Check** to enable extra SSID.

Profile Isolation

Restricted Client to communicate with different VID by Selecting the Radio button.

Auction: SuperG is a special feature in EOA3630. If the client does not support SuperG, it cannot establish a wireless connection successfully.

SSID Profile

Wireless Setting

SSID	EnGenius1 (1 to 32 characters)
VLAN ID	1 (1~4095)
Suppressed SSID	<input type="checkbox"/>
Station Separation	<input type="radio"/> Enable <input checked="" type="radio"/> Disable

Wireless Security

Security Mode	Disabled ▼
---------------	------------

SSID	Specify the SSID for current profile.
VLAN ID	Specify the VLAN tag for current profile.
Suppressed SSID	Place a Check to hide the SSID. Client will not be able to see the broadcast SSID in Site Survey.
Station Separation	Select the Radio Button to allow / deny client to communicate each other.
Wireless Security	Please refer to the Wireless Security section.
Save / Cancel	Press Save to save the changes or Cancel to return previous settings.

4.2.6 Client Router Mode

Wireless Network

[Home](#)
[Reset](#)

Wireless Mode	802.11 b/g Mixed (2GHz/54Mbps) ▾
SSID	Specify the static SSID : <input type="text" value="EnGenius"/> (1 to 32 characters) Or press the button to search for any available WLAN Service. <input type="button" value="Site Survey"/>
Prefer BSSID	<input type="checkbox"/> <input type="text" value=""/> : <input type="text" value=""/> : <input type="text" value=""/> : <input type="text" value=""/> : <input type="text" value=""/> : <input type="text" value=""/>
WDS Client	<input type="radio"/> Enable <input checked="" type="radio"/> Disable

Wireless Mode	Select the desired 802.11 standard modes or SuperG mode. There are four different modes and they are 802.11b, 802.11g Only, 802.11 b/g mixed and SuperG.
SSID	Specify the SSID if known. SSID text box will be automatically fill in when select an AP in the Site Survey.
Site Survey	Using Site Survey to scan nearby APs and then select the AP to establish the connection.
Prefer BSSID	Specify the MAC address if known. Prefer BSSID text box will be automatically fill in when select an AP in the Site Survey.
WDS Client	Place a Radio button to Enable / Disable WDS Client.
Apply / Cancel	Press Apply to apply the changes or Cancel to return previous settings.

Site Survey

2.4GHz Site Survey

📶:Infrastructure 📶:Ad_hoc

BSSID	SSID	Channel	Signal	Type	Security	Network Mode
00:e0:4c:81:86:21	DinoNet	1	-86 dBm	B	WEP	📶
00:13:77:c:6f:43	SMC	6	-105 dBm	G	NONE	📶

Profile	After Site Survey, webpage will display all nearby area's Access Point. Click the BSSID if you would like to connect with it.
Wireless Security	Please refer to the Wireless Security section.

RefreshPress Refresh to scan again.

Auction: If the Access Point is suppressed its own SSID, SSID section will be blank, the SSID must be filled in manually.

4.3 Wireless Security Settings

Wireless Security Settings section will guide you to the entire Security modes configuration: WEP, WPA-PSK, WPA2-PSK, WPA-PSK Mixed, WPA, WPA2, and WPA Mixed.

We strongly recommend that uses WPA2-PSK as your security settings.

4.3.1 WEP

Wireless Security

Security Mode	WEP ▾
Auth Type	Open System ▾
Input Type	Hex ▾
Key Length	40/64-bit (10 hex digits or 5 ASCII char) ▾
Default Key	1 ▾
Key1	<input type="text"/>
Key2	<input type="text"/>
Key3	<input type="text"/>
Key4	<input type="text"/>

Security Mode	Select WEP from the drop down list to begin the configuration.
Auth Type	Select Auth Type in Open System or Shared .
Input Type	Select Input Type in Hex or ASCII .
Key Length	Select Key Length in 64/128/152 bit password length.
Default Key	Select the default index key for wireless security.
Key1	Specify password for security key index No.1.
Key2	Specify password for security key index No.2.
Key3	Specify password for security key index No.3.
Key4	Specify password for security key index No.4.

4.3.2 WPA-PSK

Wireless Security

Security Mode	WPA-PSK
Encryption	Auto
Passphrase	passphrase1 (8 to 63 characters) or (64 Hexadecimal characters)
Group Key Update Interval	3600 seconds(30~3600, 0: disabled)
Group Key Update Timeout	1 seconds(1~300)
Pairwise Key Update Timeout	1 seconds(1~300)

Security Mode	Select WPA-PSK from the drop down list to begin the configuration.
Encryption	Select Auto , TKIP or AES for Encryption type.
Passphrase	Specify the security password.
Group Key Update Interval	Specify Group Key Update Interval time.
Group Key Update Timeout	Specify Group Key Update Timeout time.
Pairwise Key Update Interval	Specify Pairwise Key Update Timeout time.

4.3.3 WPA2-PSK

Wireless Security

Security Mode	WPA2-PSK
Encryption	Auto
Passphrase	passphrase1 (8 to 63 characters) or (64 Hexadecimal characters)
Group Key Update Interval	3600 seconds(30~3600, 0: disabled)
Group Key Update Timeout	1 seconds(1~300)
Pairwise Key Update Timeout	1 seconds(1~300)

Save Cancel

Security Mode	Select WPA2-PSK from the drop down list to begin the configuration.
Encryption	Select Auto , TKIP or AES for Encryption type.

Passphrase	Specify the security password.
Group Key Update Interval	Specify Group Key Update Interval time.
Group Key Update Timeout	Specify Group Key Update Timeout time.
Pairwise Key Update Interval	Specify Pairwise Key Update Timeout time.

4.3.4 WPA-PSK Mixed

Wireless Security

Security Mode	WPA-PSK Mixed ▾
Encryption	Auto ▾
Passphrase	passphrase1 (8 to 63 characters) or (64 Hexadecimal characters)
Group Key Update Interval	3600 seconds(30~3600, 0: disabled)
Group Key Update Timeout	1 seconds(1~300)
Pairwise Key Update Timeout	1 seconds(1~300)

Security Mode	Select WPA-PSK Mixed from the drop down list to begin the configuration.
Encryption	Select Auto , TKIP or AES for Encryption type.
Passphrase	Specify the security password.
Group Key Update Interval	Specify Group Key Update Interval time.
Group Key Update Timeout	Specify Group Key Update Timeout time.
Pairwise Key Update Interval	Specify Pairwise Key Update Timeout time.

Auction: WPA-PSK Mixed means it allow both WPA-PSK and WPA2-PSK security types to establish wireless connection.

4.3.5 WPA

Wireless Security

Security Mode	WPA
Encryption	Auto
Radius Server	0 . 0 . 0 . 0
Radius Port	1812
Radius Secret	secret1
Group Key Update Interval	3600 seconds(30~3600, 0: disabled)
Group Key Update Timeout	1 seconds(1~300)
Pairwise Key Update Timeout	1 seconds(1~300)
Radius Accounting	Disable

Security Mode	Select WPA from the drop down list to begin the configuration.
Encryption	Select Auto , TKIP or AES for Encryption type.
Radius Server	Specify Radius Server IP Address.
Radius Port	Specify Radius Port number, the default port is 1812.
Radius Secret	Specify Radius Secret that is given by the Radius Server.
Group Key Update Interval	Specify Group Key Update Interval time.
Group Key Update Timeout	Specify Group Key Update Timeout time.
Pairwise Key Update Interval	Specify Pairwise Key Update Timeout time.
Radius Accounting	Select Enable or Disable Radius Accounting. The detail of Radius Accounting is at next section.

4.3.6 WPA2

Wireless Security

Security Mode	WPA2 ▾
Encryption	Auto ▾
Radius Server	0 . 0 . 0 . 0
Radius Port	1812
Radius Secret	secret1
Group Key Update Interval	3600 seconds(30~3600, 0: disabled)
Group Key Update Timeout	1 seconds(1~300)
Pairwise Key Update Timeout	1 seconds(1~300)
Radius Accounting	Disable ▾

Security Mode	Select WPA2 from the drop down list to begin the configuration.
Encryption	Select Auto , TKIP or AES for Encryption type.
Radius Server	Specify Radius Server IP Address.
Radius Port	Specify Radius Port number, the default port is 1812.
Radius Secret	Specify Radius Secret that is given by the Radius Server.
Group Key Update Interval	Specify Group Key Update Interval time.
Group Key Update Timeout	Specify Group Key Update Timeout time.
Pairwise Key Update Interval	Specify Pairwise Key Update Timeout time.
Radius Accounting	Select Enable or Disable Radius Accounting. The detail of Radius Accounting is at next section.

4.3.7 WPA Mixed

Wireless Security

Security Mode	WPA Mixed ▾
Encryption	Auto ▾
Radius Server	0 . 0 . 0 . 0
Radius Port	1812
Radius Secret	secret1
Group Key Update Interval	3600 seconds(30~3600, 0: disabled)
Group Key Update Timeout	1 seconds(1~300)
Pairwise Key Update Timeout	1 seconds(1~300)
Radius Accounting	Disable ▾

Security Mode	Select WPA Mixed from the drop down list to begin the configuration.
Encryption	Select Auto , TKIP or AES for Encryption type.
Radius Server	Specify Radius Server IP Address.
Radius Port	Specify Radius Port number, the default port is 1812.
Radius Secret	Specify Radius Secret that is given by the Radius Server.
Group Key Update Interval	Specify Group Key Update Interval time.
Group Key Update Timeout	Specify Group Key Update Timeout time.
Pairwise Key Update Interval	Specify Pairwise Key Update Timeout time.
Radius Accounting	Select Enable or Disable Radius Accounting. The detail of Radius Accounting is at next section.

Auction: WPA Mixed means it allow both WPA and WPA2 security types to establish wireless connection.

4.3.8 Radius Accounting

Radius Accounting	Enable ▾
Radius Accounting Server	0 . 0 . 0 . 0
Radius Accounting Port	1813
Radius Accounting Secret	secret1
Interim Accounting Interval	600 seconds(60~600)

Radius Accounting	Select Enable to begin configuration of Radius Accounting.
Radius Accounting Server	Specify Radius Accounting Server IP.
Radius Accounting Port	Specify Radius Accounting Server IP. The default port is 1813.
Radius Accounting Secret	Specify Radius Accounting Server Secret that is given by the Radius Accounting Server.
Radius Accounting Interval	Specify Radius Accounting Interval for updating information.

4.4 Wireless Advanced Settings

Wireless Advanced Settings

[Home](#)
[Reset](#)

Data Rate	Auto ▾
Transmit Power	20 dBm ▾
Fragment Length (256 - 2346)	2346 bytes
RTS/CTS Threshold (1 - 2346)	2346 bytes
Protection Mode	Disable ▾
WMM	Disable ▾
Channel Bandwidth	20MHz ▾
Distance (1-30km)	1 km

Wireless Traffic Shaping

Enable Traffic Shaping	<input type="checkbox"/>
Incoming Traffic Limit	0 kbit/s
Outgoing Traffic Limit	0 kbit/s

Data Rate	Select Data Rate from the drop down list.
Transmit Power	Select Transmit Power to increase or decrease Transmit Power.
Fragment Length	Specify package size during transmission. This value changed only when you experienced high error rate.
RTS/CTS Threshold	Specify Threshold package size for RTC/CTS.
Protection Mode	Select Disable or Enable Protection Mode.
WMM	Select Disable or Enable WMM function. WMM is based on the four Access Categories: voice, video, best effort and background. WMM function is not used to guarantee transmission speed.
Channel Bandwidth	Select Channel Bandwidth from the drop down list. Decrease channel bandwidth may cause lower throughput but less collision.
Distance	Specify distance range between AP and Clients. Longer distance may lose high connection speed.
Wireless Traffic Shaping	Place a Check to enable Wireless Traffic Shaping function.
Incoming Traffic Limit	Specify the wireless transmission speed for downloading.
Outgoing Traffic Limit	Specify the wireless transmission speed for uploading.

Auction: Changing Wireless Advanced Settings may cause insufficient wireless connection quality. Please remain all settings as default unless you have acknowledged all changing that you have made.

4.5 Wireless MAC Filter

Wireless MAC Filters is used to Allow or Deny wireless clients, by their MAC addresses, accessing the Network. You can manually add a MAC address to restrict the permission to access EOA3630. The default setting is Disable Wireless MAC Filters.

Wireless MAC Filter

Home
Reset

ACL Mode Disabled ▼

:
 :
 :
 :
 :

Add

#	MAC Address

Apply

0.

ACL Mode	ACL Mode can help to deny or allow certain Client to access the network. Select Disable, Deny MAC in the list or Allow MAC in the list from the drop down list.
MAC Address Filter	Specify the MAC address manually.
Add	Press Add to add the MAC address in the table.
Apply	Press Apply to apply the changes.

4.6 WDS Link Settings

WDS Link Settings is used to establish a connection between Access Points but the device is not losing Access Point function. AP has WDS function can extend the wireless coverage and allow LANs to communicate each other.

WDS Link Settings

[Home](#)
[Reset](#)

ID	MAC Address	Mode
1	: : : : :	Disable ▾
2	: : : : :	Disable ▾
3	: : : : :	Disable ▾
4	: : : : :	Disable ▾
5	: : : : :	Disable ▾
6	: : : : :	Disable ▾
7	: : : : :	Disable ▾
8	: : : : :	Disable ▾
9	: : : : :	Disable ▾
10	: : : : :	Disable ▾
11	: : : : :	Disable ▾
12	: : : : :	Disable ▾
13	: : : : :	Disable ▾
14	: : : : :	Disable ▾
15	: : : : :	Disable ▾
16	: : : : :	Disable ▾

[Apply](#) [Cancel](#)

MAC Address Enter the Access Point's MAC address that you would like to extend the wireless area.

Mode Select Disable or Enable from the drop down list.

Apply / Cancel Press **Apply** to apply the changes or **Cancel** to return previous settings.

Auction: The Access Point that you would like to extend the wireless area must enter your Access Point's MAC address. Not all Access Point supports this feature.

5 LAN Setup

This section will guide you to the Local Area Network (LAN) settings

5.1 IP Settings

This section is only available for **Non-Router Mode**. IP Settings allows you to LAN port IP address of the EOA3630.

Auction: Changing LAN IP Address will change LAN Interface IP address. Webpage will automatically redirect to the new IP address after Apply.

IP Settings

[Home](#)[Reset](#)

IP Network Setting	<input type="radio"/> Obtain an IP address automatically (DHCP) <input checked="" type="radio"/> Specify an IP address
IP Address	192 . 168 . 1 . 1
IP Subnet Mask	255 . 255 . 255 . 0
Default Gateway	0 . 0 . 0 . 0
Primary DNS	0 . 0 . 0 . 0
Secondary DNS	0 . 0 . 0 . 0

[Apply](#)[Cancel](#)

IP Network Setting	Select Radio button for Obtain an IP address automatically or Specify an IP address .
IP Address	Specify LAN port IP address.
IP Suet Mask	Specify Subnet Mask.
Default Gateway	Specify Default Gateway
Primary DNS	Specify Primary DNS
Secondary DNS	Specify Secondary DNS
Apply / Cancel	Press Apply to apply the changes or Cancel to return previous settings.

Auction: Obtain an IP address automatically is not a DHCP server. It means automatically get IP address when device connected to a device which has DHCP server.

5.2 Spanning Tree Settings

Spanning Tree Settings

[Home](#)[Reset](#)

Spanning Tree Status	<input type="radio"/> On <input checked="" type="radio"/> Off
Bridge Hello Time	<input type="text" value="2"/> seconds (1-10)
Bridge Max Age	<input type="text" value="20"/> seconds (6-40)
Bridge Forward Delay	<input type="text" value="15"/> seconds (4-30)
Priority	<input type="text" value="32768"/> (0-65535)

[Apply](#)[Cancel](#)

Spanning Tree Status	Select the Radio button to On or Off Spanning Tree function.
Bridge Hello Time	Specify Bridge Hello Time in second.
Bridge Max Age	Specify Bridge Max Age in second.
Bridge Forward Delay	Specify Bridge Forward Delay in second.
Priority	Specify the Priority number. Smaller number has greater priority.
Apply / Cancel	Press Apply to apply the changes or Cancel to return previous settings.

6 Router Settings

This section is only available for **AP Router Mode** and **Client Router Mode**.

6.1 WAN Settings

There are four different types of WAN connection: Static IP, DHCP, PPPoE and PPTP. Please contact your ISP to select the connection type.

6.1.1 Static IP

Select Static IP in WAN connection if your ISP gives all the information about IP address, Subnet Mask, Default Gateway, Primary DNS and Secondary DNS.

Internet Connection Type	Select Static IP to begin configuration of the Static IP connection.
Account Name	Specify Account Name that is provided by ISP.
Domain Name	Specify Domain Name that is provided by ISP.
MTU	Specify the Maximum Transmit Unit size. Suggest remain in Auto.
IP Address	Specify WAN port IP address.
IP Subnet Mask	Specify WAN IP Subnet Mask.
Gateway IP Address	Specify WAN Gateway IP address.
Primary DNS	Specify Primary DNS IP.
Secondary DNS	Specify Secondary DNS IP.
Discard Ping on WAN	Place a Check to Enable or Disable ping from WAN.
Apply / Cancel	Press Apply to apply the changes or Cancel to return previous settings.

Auction: If the router's MTU is set too high, packets will be fragmented downstream. If the router's MTU is set too low, the router will fragment packets unnecessarily and in extreme cases may be unable to establish some connections. In either case, network performance can suffer.

6.1.2 DHCP (Dynamic IP)

Select DHCP as your WAN connection type to obtain your IP address automatically. You will need to enter Account Name as your hostname and DNS (Optional).

WAN Settings

Home

Reset

Internet Connection Type

DHCP

Options

Account Name (if required)

Domain Name (if required)

MTU

Auto 1500

Domain Name Server (DNS) Address

Get Automatically From ISP

Use These DNS Servers

Primary DNS

0 . 0 . 0 . 0

Secondary DNS

0 . 0 . 0 . 0

WAN Ping

Discard Ping on WAN

Apply

Cancel

Internet Connection Type	Select DHCP to begin configuration of the DHCP connection.
Account Name	Specify Account Name that is provided by ISP.
Domain Name	Specify Domain Name that is provided by ISP.
MTU	Specify the Maximum Transmit Unit size. Suggest remain in Auto.
Get Automatically From ISP	Select the Radio button for get the DNS automatically from DHCP server.
Use These DNS Servers	Select the Radio button for setup the Primary DNS and Secondary DNS servers manually.
Discard Ping on WAN	Place a Check to Enable or Disable ping from WAN.
Apply / Cancel	Press Apply to apply the changes or Cancel to return previous settings.

Auction: If the router's MTU is set too high, packets will be fragmented downstream. If the router's MTU is set too low, the router will fragment packets unnecessarily and in extreme cases may be unable to establish some connections. In either case, network performance can suffer.

6.1.3 PPPoE (Point-to-Point Protocol over Ethernet)

Select PPPoE as your WAN connection type if your ISP provides Username and Password. PPPoE is a DSL service and please remove your PPPoE software from your computer, the software is not worked in EOA3630.

WAN Settings

Home

Reset

Internet Connection Type PPPoE

Options

MTU Auto 1492

PPPoE Options

Login

Password

Service Name (if required)

Connect on Demand: Max idle Time 1 Minutes

Keep Alive: Redial Period 30 Seconds

Get Automatically From ISP

Use These DNS Servers

Primary DNS 0 . 0 . 0 . 0

Secondary DNS 0 . 0 . 0 . 0

WAN Ping

Discard Ping on WAN

Apply

Cancel

Internet Connection Type Select **PPPoE** to begin configuration of the PPPoE connection.

MTU Specify the Maximum Transmit Unit size. Suggest remain in Auto.

Login Specify the **Username** that is given by your ISP.

Password Specify the **Password** that is given by your ISP.

Service Name Specify the **Service Name** that is given by your ISP.

Connect on Demand Select the Radio button to specify the maximum idle time. Internet connection will

	disconnect when it reach the maximum idle time, but it will automatically connect when user tries to access the network.
Keep Alive	Select the Radio button to keep internet connection always on. Specify the redial period once the internet lose connection.
Get Automatically From ISP	Select the Radio button for get the DNS automatically from DHCP server.
Use These DNS Servers	Select the Radio button for setup the Primary DNS and Secondary DNS servers manually.
Discard Ping on WAN	Place a Check to Enable or Disable ping from WAN.
Apply / Cancel	Press Apply to apply the changes or Cancel to return previous settings.

Auction: If the router's MTU is set too high, packets will be fragmented downstream. If the router's MTU is set too low, the router will fragment packets unnecessarily and in extreme cases may be unable to establish some connections. In either case, network performance can suffer.

6.1.4 PPTP (Point-to-Point Tunneling Protocol)

Select PPTP as your WAN connection type if your ISP provides information about IP Address, Subnet Mask, Default Gateway (Optional), DNS (Optional), Server IP, Username, and Password.

WAN Settings

[Home](#)[Reset](#)

Internet Connection Type PPTP

Options

MTU Auto 1460

PPTP Options

IP Address 192 . 168 . 2 . 1

Subnet Mask 255 . 255 . 255 . 0

Default Gateway 192 . 168 . 2 . 100

PPTP Server 0 . 0 . 0 . 0

Username

Password

Connect on Demand: Max idle Time 15 Minutes

Keep Alive: Redial Period 30 Seconds

Get Automatically From ISP

Use These DNS Servers

Primary DNS 0 . 0 . 0 . 0

Secondary DNS 0 . 0 . 0 . 0

WAN Ping

Discard Ping on WAN

[Apply](#)[Cancel](#)

Internet Connection Type Select **PPTP** to begin configuration of the PPTP connection.

MTU Specify the Maximum Transmit Unit size. Suggest remain in Auto.

IP Address Specify WAN port IP address.

IP Subnet Mask	Specify WAN IP Subnet Mask.
Gateway IP Address	Specify WAN Gateway IP address.
PPTP Server	Specify PPTP Server IP address.
Username	Specify the Username that is given by your ISP.
Password	Specify the Password that is given by your ISP.
Connect on Demand	Select the Radio button to specify the maximum idle time. Internet connection will disconnect when it reach the maximum idle time, but it will automatically connect when user tries to access the network.
Keep Alive	Select the Radio button to keep internet connection always on. Specify the redial period once the internet lose connection.
Get Automatically From ISP	Select the Radio button for get the DNS automatically from DHCP server.
Use These DNS Servers	Select the Radio button for setup the Primary DNS and Secondary DNS servers manually.
Discard Ping on WAN	Place a Check to Enable or Disable ping from WAN.
Apply / Cancel	Press Apply to apply the changes or Cancel to return previous settings.

Auction: If the router's MTU is set too high, packets will be fragmented downstream. If the router's MTU is set too low, the router will fragment packets unnecessarily and in extreme cases may be unable to establish some connections. In either case, network performance can suffer.

6.2 LAN Settings (Router Mode)

LAN Settings

[Home](#)[Reset](#)

LAN IP Setup

IP Address	192 . 168 . 1 . 1
IP Subnet Mask	255 . 255 . 255 . 0
WINS Server IP	0 . 0 . 0 . 0

 Use Router As DHCP Server

Starting IP Address	192 . 168 . 1 . 2
Ending IP Address	192 . 168 . 1 . 254

IP Address	Specify LAN port IP address.
IP Subnet Mask	Specify LAN IP Subnet Mask.
WINS Server IP	Specify WINS Server IP.
Use Router As DHCP Server	Place a Check to enable DHCP server.
Starting IP Address	Specify DHCP server starting IP address.
Ending IP Address	Specify DHCP server ending IP address.
Apply / Cancel	Press Apply to apply the changes or Cancel to return previous settings.

6.3 VPN Pass Through

VPN Pass Through is on top of an existing network by passing or restricting certain protocol. This function can help to provide a secure private network.

VPN Pass Through

[Home](#)[Reset](#) PPTP Pass Through L2TP Pass Through IPSec Pass Through[Apply](#)[Cancel](#)

PPTP Pass Through	Place a Check to enable PPTP protocol passes through WAN.
L2TP Pass Through	Place a Check to enable L2TP protocol passes through WAN.
IPSec Pass Through	Place a Check to enable IPSec protocol passes through WAN.
Apply / Cancel	Press Apply to apply the changes or Cancel to return previous settings.

6.4 Port Forwarding

Port Forwarding is used to forward a TCP/IP packet in a NAT to a specific network port.

Port Forwarding

Home

Reset

#	Name	Protocol	Start Port	End Port	Server IP Address	Enable	Modify	Delete
---	------	----------	------------	----------	-------------------	--------	--------	--------

Add Entry

Apply

Add Entry Press Add Entry to add a rule of Port Forwarding.

Apply Press **Apply** to apply the changes.

Service Name Specify a name for current Port Forwarding rule.

Protocol Select a protocol from drop down list: Both, TCP and UDP.

Starting Port Specify Starting Port number.

Ending Port Specify Ending Port number.

IP Address Specify IP address.

Save / Cancel Press **Save** to apply the changes or **Cancel** to return previous settings.

6.5 DMZ

DMZ (Demilitarized) is a physical or logical subnetwork that exposed LAN to an unknown network. This function allows you to add an additional entry to an IP address.

DMZ

[Home](#)[Reset](#)

DMZ Hosting	Disable ▾
DMZ Address	<input type="text"/> . <input type="text"/> . <input type="text"/> . <input type="text"/>

[Apply](#)[Cancel](#)

DMZ Hosting	Select Enable or Disable DMZ from drop down list.
DMZ Address	Specify an IP address of DMZ.
Apply / Cancel	Press Apply to apply the changes or Cancel to return previous settings.

7 Information Status

Status section is on the navigation drop-down menu. You will then see three options: Main, Wireless Client List, System Log, WDS Link Status, Connection Status, and DHCP Client Table. Each option is described in detail below.

7.1 Main

Click on the **Main** link under the **Status** drop-down menu or click **Home** from the top-right of the webpage. The status that is displayed corresponds with the operating mode that is selected. Information such as operating mode, system up time, firmware version, serial number, kernel version and application version are displayed in the 'System' section. LAN IP address, subnet mask, and MAC address are displayed in the 'LAN' section. In the 'Wireless section, the frequency, channel is displayed. Since this device supports multiple-SSIDs, the details of each SSID, such as ESSID and its security settings are displayed.

Main

System Information

Device Name	Access Point
Ethernet MAC Address	00:02:6f:09:0a:12
Wireless MAC Address	00:02:6f:10:0a:13
Country	N/A
Current Time	Sat Jan 1 00:16:45 UTC 2000
Firmware Version	1.0.27
Management VLAN ID	Untagged

LAN Settings

IP Address	192.168.1.1
Subnet Mask	255.255.255.0
Default Gateway	0.0.0.0
DHCP Client	Disabled

Current Wireless Settings

Operation Mode	Access Point
Wireless Mode	IEEE 802.11b/g Mixed
Channel/Frequency	Current Frequency:2.412GHz (channel 01)
Profile Isolation	No
Profile Settings (SSID/Security/VID)	1 EnGenius1/Open System/No Encryption/1
	2 N/A
	3 N/A
	4 N/A
Spanning Tree Protocol	Disabled
Distance	1 Km

Refresh

7.2 Wireless Client List

Click on the **Wireless Client List** link under the **Status** drop-down menu. This page displays the list of Clients that are associated to the EOA3630.

The MAC addresses and signal strength for each client is displayed. Click on the **Refresh** button to refresh the client list

Client List

[Home](#)[Reset](#)

#

MAC Address

RSSI(dBm)

[Refresh](#)

7.3 System Log

Click on the **System Log** link under the **Status** drop-down menu. The device automatically logs (records) events of possible interest in its internal memory. If there is not enough internal memory for all events, logs of older events are deleted, but logs of the latest events are retained.

System Log

[Home](#)[Reset](#)Show log type All ▼

Local Log is disabled.

[Refresh](#)[Clear](#)

7.4 WDS Link Status

The WDS Link Status will only show in WDS Bridge Mode. Click on the **WDS Link Status** link under the **Status** drop-down menu. This page displays the current status of WDS link, including station ID, MAC address, status and RSSI.

WDS Link Status

[Home](#)[Reset](#)

Station ID	MAC Address	Status	RSSI (dBm)
------------	-------------	--------	------------

[Refresh](#)

7.5 Connection Status

Click on the **Connection Status** link under the **Status** drop-down menu. This page displays the current status of the network, including network type, SSID, BSSID, connection status, wireless mode, current channel, security, data rate, noise level and signal strength.

Wireless

Network Type	Client Router
SSID	EnGenius
BSSID	N/A
Connection Status	N/A
Wireless Mode	N/A
Current Channel	N/A
Security	N/A
Tx Data Rate(Mbps)	N/A
Current noise level	N/A
Signal strength	N/A

WAN

MAC Address	00:02:6f:75:9f:a8
Connection Type	Static IP
Connection Status	Down
IP Address	
IP Subnet Mask	0.0.0.0

[Refresh](#)

7.6 DHCP Client Table

Click on the **DHCP Client List** link under the **Status** drop-down menu. This page displays the list of Clients that are associated to the EOA3630 through DHCP.

The MAC addresses and signal strength for each client is displayed. Click on the **Refresh** button to refresh the client list.

DHCP Client List

[Home](#)[Reset](#)

MAC addr	IP	Expires
----------	----	---------

[Refresh](#)

8 Management Settings

Management section is on the navigation drop-down menu. You will then see seven options: administration, management VLAN, SNMP settings, backup/restore settings, firmware upgrade, time settings, and log. Each option is described below.

8.1 Administration

Click on the **Administration** link under the **Management** menu. This option allows you to create a user name and password for the device. By default, this device is configured without a user name and password **admin**. For security reasons it is highly recommended that you create a new user name and password.

Administration

[Home](#)[Reset](#)

Administrator

Name	<input type="text" value="admin"/>
Password	<input type="password" value="•••••"/>
Confirm Password	<input type="password" value="•••••"/>

Name	Specify Username for login.
Password	Specify a Password for login
Confirm Password	Re-enter the Password for confirmation.

Remote Access

Remote Management	<input type="radio"/> Enable <input checked="" type="radio"/> Disable
Remote Upgrade	<input type="radio"/> Enable <input checked="" type="radio"/> Disable
Remote Management Port	<input type="text" value="8080"/>

Remote Management	Select the Radio button to Enable or Disable Remote Management.
Remote Upgrade	Select the Radio button to Enable or Disable Remote Upgrade.
Remote Management	Specify the Port number for Remote Management. For example: If you specify the

Port	Port number is 8080, then you will need to enter following http://<IP address>:8080 to access the web interface.
Apply / Cancel	Press Apply to apply the changes or Cancel to return previous settings.

8.2 Management VLAN

Click on the **Management VLAN** link under the **Management** menu. This option allows you to assign a VLAN tag to the packets. A VLAN is a group of computers on a network whose software has been configured so that they behave as if they were on a separate Local Area Network (LAN). Computers on VLAN do not have to be physically located next to one another on the LAN

Management VLAN Settings

Home

Reset

Caution: If you reconfigure the Management VLAN ID, you may lose connectivity to the access point. Verify that the switch and DHCP server can support the reconfigured VLAN ID, and then re-connect to the new IP address.

Management VLAN ID

- No VLAN tag
 Specified VLAN ID
 (must be in the range 1 ~ 4095.)

Apply

Cancel

Management VLAN ID	If your network includes VLANs and if tagged packets need to pass through the Access Point, specify the VLAN ID into this field. If not, select the No VLAN tag radio button.
---------------------------	--

Apply / Cancel	Press Apply to apply the changes or Cancel to return previous settings.
-----------------------	---

Auction: If you reconfigure the Management VLAN ID, you may lose connection to the EOA3630. Verify DHCP server can support the reconfigured VLAN ID, and then re-connect to the new IP address.

8.3 SNMP Settings

Click on the **SNMP Settings** link under the **Management** menu. This is a networking management protocol used to monitor network-attached devices. SNMP allows messages (called protocol data units) to be sent to various parts of a network. Upon receiving these messages, SNMP-compatible devices (called agents) return data stored in their Management Information Bases.

SNMP Settings

[Home](#)
[Reset](#)

SNMP Enable/Disable	<input checked="" type="radio"/> Enable <input type="radio"/> Disable
Contact	<input type="text"/>
Location	<input type="text"/>
Community Name (Read Only)	public
Community Name (Read/Write)	private
Trap Destination IP Address	0 . 0 . 0 . 0
Trap Destination Community Name	public

[Apply](#)
[Cancel](#)

SNMP Enable/Disable	Select the Radio button to Enable or Disable SNMP function.
Contact	Specify the contact details of the device.
Location	Specify the location of the device.
Community Name	Specify the password for access the SNMP community for read only access.
Community Name	Specify the password for access the SNMP community for read and write access.
Trap Destination IP Address	Specify the IP address that will receive the SNMP trap.
Trap Destination Community Name	Specify the password of the SNMP trap community.
Apply / Cancel	Press Apply to apply the changes or Cancel to return previous settings.

8.4 Backup/Restore Settings

Click on the **Backup/Restore Setting** link under the **Management** menu. This option is used to save the current settings of the device in a file on your local disk or load settings on to the device from a local disk. This feature is very handy for administrators who have several devices that need to be configured with the same settings.

Backup/Restore Settings Home Reset

Save A Copy of Current Settings Backup

Restore Saved Settings from A File Browse... Restore

Revert to Factory Default Settings Factory Default

Save A Copy of Current Settings

Click on **Backup** to save current configured settings.

Restore Saved Settings from a File

EOA3630 can restore a previous setting that has been saved. Click on Browse to select the file and Restore.

Revert to Factory Default Settings

Click on Factory Default button to reset all the settings to the default values.

8.5 Firmware Upgrade

Click on the **Firmware Upgrade** link under the **Management** menu. This page is used to upgrade the firmware of the device. Make sure that downloaded the appropriate firmware from your vendor.

Firmware Upgrade Home Reset

Current firmware version: 1.1.24

Locate and select the upgrade file from your hard disk:

Browse...

Upgrade

Auction: Upgrade process may take few minutes, please do not power off the device and it may cause

the device crashed or unusable. EOA3630 will restart automatically once the upgrade is completed.

8.6 Time Settings

Click on the **Time Settings** link under the **Management** menu. This page allows you to configure the time on the device. You may do this manually or by connecting to a NTP server.

Time Settings

Home

Reset

Time

Manually Set Date and Time

2000 / 01 / 01 02 : 45

Automatically Get Date and Time

Time Zone: UTC+00:00 England

User defined NTP Server: 0 . 0 . 0 . 0

Apply

Cancel

Manually Set Date and Time

Manually setup the date and time.

Automatically Get Date and Time

Specify the Time Zone from the drop down list and Place a **Check** to specify the IP address of the NTP Server manually or uses default NTP Server.

Apply / Cancel

Press **Apply** to apply the changes or **Cancel** to return previous settings.

8.7 Log

Click on the **Log** link under the **Management** menu. The **Log** page displays a list of events that are triggered on the Ethernet and Wireless interface. This log can be referred when an unknown error occurs on the system or when a report needs to be sent to the technical support department for debugging purposes.

Log

[Home](#)[Reset](#)

Syslog

Syslog	Disable ▾
Log Server IP Address	0 . 0 . 0 . 0

Local log

Local Log	Disable ▾
-----------	-----------

[Apply](#)[Cancel](#)

Syslog	Select Enable or Disable Syslog function from the drop down list.
Log Server IP Address	Specify the Log Server IP address.
Local Log	Select Enable or Disable Local Log service.
Apply / Cancel	Press Apply to apply the changes or Cancel to return previous settings.

8.8 Diagnostics

Click on the **Diagnostics** link under the **Management** menu. This function allows you to detect connection quality and trace the routing table to the target.

Diagnostics

[Home](#)[Reset](#)

Ping Test Parameters

Target IP	<input type="text"/> . <input type="text"/> . <input type="text"/> . <input type="text"/>
Ping Packet Size	64 Bytes
Number of Pings	4

Traceroute Test Parameters

Traceroute target	<input type="text"/>
-------------------	----------------------

Target IP	Specify the IP address you would like to search.
Ping Packet Size	Specify the packet size of each ping.
Number of Pings	Specify how many times of ping.
Start Ping	Press Start Ping to begin.
Traceroute Target	Specify an IP address or Domain name you would like to trace.
Start Traceroute	Press Start Traceroute to begin.

Appendix A – FCC Interference Statement

Federal Communication Commission Interference Statement

This equipment has been tested and found to comply with the limits for a Class B digital device, pursuant to Part 15 of the FCC Rules. These limits are designed to provide reasonable protection against harmful interference in a residential installation. This equipment generates, uses and can radiate radio frequency energy and, if not installed and used in accordance with the instructions, may cause harmful interference to radio communications. However, there is no guarantee that interference will not occur in a particular installation. If this equipment does cause harmful interference to radio or television reception, which can be determined by turning the equipment off and on, the user is encouraged to try to correct the interference by one of the following measures:

- Reorient or relocate the receiving antenna.
- Increase the separation between the equipment and receiver.
- Connect the equipment into an outlet on a circuit different from that to which the receiver is connected.
- Consult the dealer or an experienced radio/TV technician for help.

FCC Caution: Any changes or modifications not expressly approved by the party responsible for compliance could void the user's authority to operate this equipment.

This device complies with Part 15 of the FCC Rules. Operation is subject to the following two conditions: (1) This device may not cause harmful interference, and (2) this device must accept any interference received, including interference that may cause undesired operation.

IMPORTANT NOTE:

FCC Radiation Exposure Statement:

This equipment complies with FCC radiation exposure limits set forth for an uncontrolled environment. This equipment should be installed and operated with minimum distance 20cm between the radiator & your body.

This transmitter must not be co-located or operating in conjunction with any other antenna or transmitter.

Appendix B – IC Interference Statement

Industry Canada statement:

This device complies with RSS-210 of the Industry Canada Rules. Operation is subject to the following two conditions:

(1) This device may not cause harmful interference, and (2) this device must accept any interference received, including interference that may cause undesired operation.

IMPORTANT NOTE:

Radiation Exposure Statement:

This equipment complies with IC radiation exposure limits set forth for an uncontrolled environment. This equipment should be installed and operated with minimum distance 20cm between the radiator & your body.

This device has been designed to operate with an antenna having a maximum gain of 5dBi. Antenna having a higher gain is strictly prohibited per regulations of Industry Canada. The required antenna impedance is 50 ohms.

Professional installation instruction

1. Installation personal

This product is designed for specific application and needs to be installed by a qualified personal who has RF and related rule knowledge. The general user shall not attempt to install or change the setting.

2. Installation location

The product shall be installed at a location where the radiating antenna can be kept 20 cm from nearby person in normal operation condition to meet regulatory RF exposure requirement.

3. External antenna,

Use only the antennas which have been approved by Senao. The non-approved antenna(s) may produce unwanted spurious or excessive RF transmitting power which may lead to the violation of FCC limit and is prohibited.

4. Installation procedure

Please refer to user's manual for the detail.

5. Warning

Please carefully select the installation position and make sure that the final output power does not exceed the limit set force in US Rule CFR 47 part 15 section 15.247 . The violation of the rule could lead to serious federal penalty.