

FCC ID: P27BC855

IC: 527A-BC855

---

# **BC855**

# **Wireless Full HD**

# **Battery Camera**

---



---

## **Setup Guide**

---

Copyright © 2019. All Rights Reserved.

Document Version: 1.0

# Table of Contents

<b>Chapter 1 Introduction .....</b>	<b>1</b>
<b>Package Contents.....</b>	<b>1</b>
<b>Chapter 2 Setup.....</b>	<b>2</b>
<b>System Requirements .....</b>	<b>2</b>
<b>Physical Details - HD Battery Camera .....</b>	<b>2</b>
<b>Pre-Installation .....</b>	<b>5</b>
<b>Installation.....</b>	<b>7</b>
<b>Mounting Installation.....</b>	<b>7</b>
<b>Chapter 3 Viewing Live Video .....</b>	<b>8</b>
<b>Overview.....</b>	<b>8</b>
<b>Requirements .....</b>	<b>8</b>
<b>Connecting to a Camera on your LAN.....</b>	<b>8</b>
<b>Chapter 4 Troubleshooting.....</b>	<b>10</b>
<b>Overview.....</b>	<b>10</b>
<b>Problems .....</b>	<b>10</b>
<b>Appendix A.....</b>	<b>11</b>
<b>Specifications .....</b>	<b>11</b>
<b>Regulatory Approvals .....</b>	<b>12</b>

# Chapter 1

# Introduction

## Package Contents

The following items should be included: If any of these items are damaged or missing, please contact your dealer immediately.

1. Full HD Battery Camera x 1



2. Battery Pack x 1



3. Mounting Stand x 1



4. Screw/Anchor x 3



## Chapter 2

# Setup











This Chapter provides details on how to install and configure the HD Battery Camera.

### System Requirements

- A computer or mobile device with Internet access
- You can use the following web browser while using a computer:
  - Internet Explorer 7 or later
  - Firefox 3
  - Safari 4
  - Chrome

### Physical Details - HD Battery Camera

#### LED

Color	Status
 Solid Green	The camera is registered and connected to the network.
 Solid Green (5 seconds)	WPS pairing is failed. The camera can not access to the Wi-Fi network.
 Blinking Green	WPS pairing (PBC code mode)
 Fast Blinking Green	WPS pairing (pin code mode)
 Blinking Green/Blue	The camera is receiving a firmware/MCU upgrade.
 Blinking Red	<ul style="list-style-type: none"> <li>• The camera is connecting to the network and cloud.</li> <li>• The camera can not access to the network and cloud.</li> <li>• Low Battery alarm: once blinking per 2 seconds.</li> </ul>
 Slow Blinking Red	The SD card is invalid.
 Fast Blinking Red	When the Reset button is pressed for 10 seconds, the LED will blink red indicating the start of the reboot/factory reset.
 Solid Blue	The camera is powering on.
 Solid Blue (1 second)	The PIR is triggered.

## Front Panel

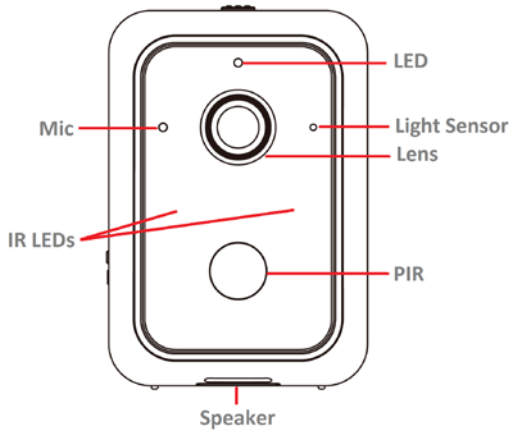

### Microphone

The built-in microphone is useful for bi-direction voice conversation.

### Light Sensor

This is hardware sensor to detect LUX.

### Lens

No physical adjustment is required or possible for the lens, but you should ensure that the lens cover remains clean. The image quality is degraded if the lens cover is dirty or smudged.

### IR LEDs

They are used to provide illumination for night time.

### PIR Sensor

This is hardware sensor for detecting motion.

## Rear Panel

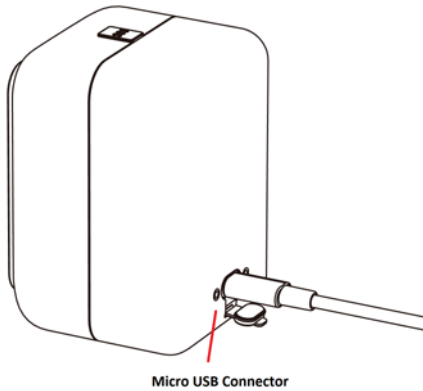

### Micro USB Connector

This connector is used for charging the power. Connect the Micro USB cable (not provided) to this port.

## Side Panel

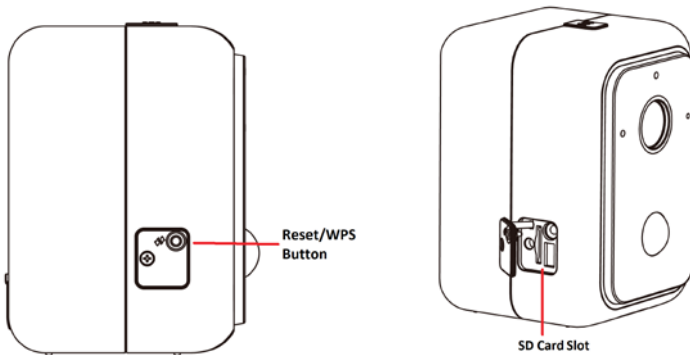

### Reset/WPS

This button has two functions:

- **WPS:**
  - WPS PBC Mode: When pressed and released (less than 3 seconds), the Camera will be in the WPS PBC mode (Auto link mode).
  - WPS Pin Code Mode: When pressed and held for over 3 seconds, the Camera will be in the WPS Pin Code mode.
- **Reset:** When pressed and held over 10 seconds, the LED will be flashing red, which means the settings of Camera will be set to their default values.

### SD Card Slot

Insert the SD card for external storage. Use a screwdriver to remove the screw and open the cover to insert the SD card if needed.

### CAUTION:

- Risk of fire and burns under certain conditions
- Do not open, crush, short circuit and keep away from heat.
- Risk of explosion if the battery is replaced by an incorrect type
- Follow instructions while using the battery
- Dispose of used batteries according to the instructions

## Pre-Installation

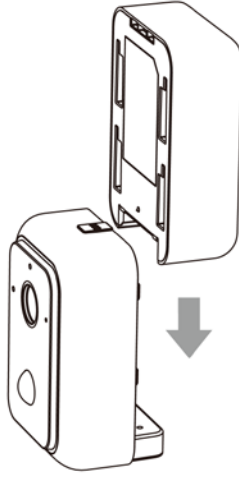

### Insert the Battery Pack

Align the battery contacts and then insert the battery pack into the camera.

**Note:** Be sure to charge the battery when use it for the first time.

### Battery Pack Charging

You can charge your camera battery **indoors** using the Micro USB cable (not provided).

**Note:** For safety reasons, the battery charging temperatures are from **5°C to 35°C**.

1. Put the battery pack into the camera.
2. Connect the power Micro USB cable (not provided) to the USB port of the camera.
3. Plug the other end of power Micro USB cable (not provided) into an electrical outlet.

### Battery Pack LED

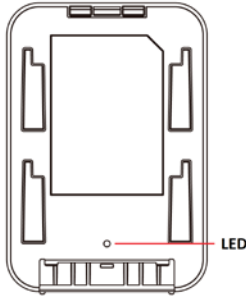

Color	Status
Solid Green	The charging is complete.
Solid Red	The battery pack is charging.

### Remove the Battery Pack

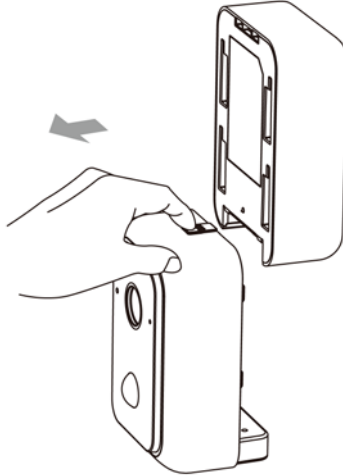

1. Push the button up.
2. Remove the battery pack from the camera.



## Installation

1. Move the camera to where it is to be placed.
2. Check the LED:
  - The Power LED should be solid blue when the camera is powering on.

## Mounting Installation

Place the camera in a flat surface or mount it on the wall/ceiling.

- Check the network signal strength in the place where you want to locate the camera.
- Avoid placing the camera in an area that gets a lot of light directly into the camera lens.

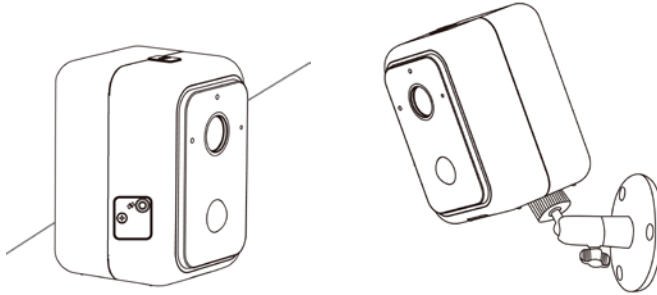

### Wall Mounting

1. Identify the location for mounting the Camera.
2. Place the mounting plate and secure it with three screws.  
**Note:** Use anchors if necessary.
3. Attach the camera onto the camera stand.

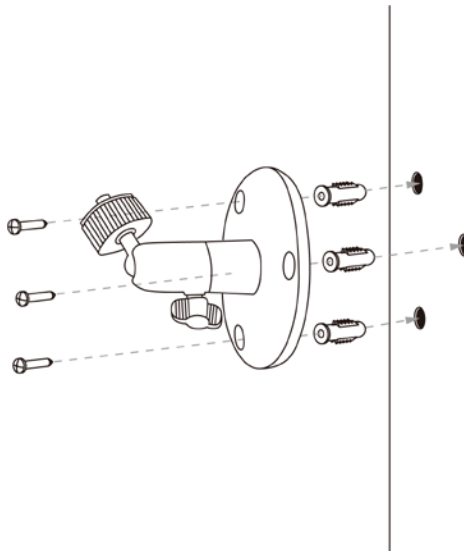

## Chapter 3

# Viewing Live Video

*This Chapter provides basic information about viewing live video.*

### Overview

This Chapter has details of viewing live video using Internet Explorer.

### Requirements

To view the live video stream generated by the HD Battery Camera, you need to meet the following requirements:

- Windows XP, 32-bit Windows Vista/Windows 7.
- Internet Explorer 7 or later, Firefox 3.0 or later.

### Connecting to a Camera on your LAN

To establish a connection from your PC to the HD Battery Camera:

1. Start Internet Explorer.
2. In the Address box, enter "HTTP://" and the IP Address of the HD Battery Camera.
3. You will then be prompted for a username and password.
  - If using the default values, enter **administrator** for the name, and leave the password blank.
  - Otherwise, enter the *Administrator ID* and *Administrator Password* set on the *Maintenance* screen.
4. When you connect, the following screen will be displayed.

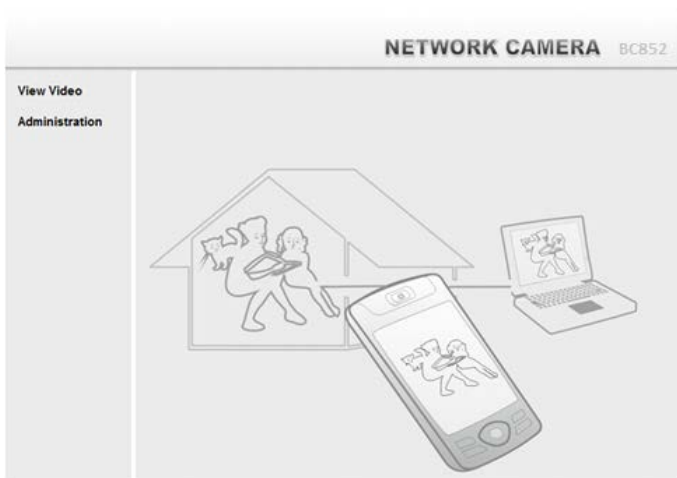

**Figure 1: Home Screen**

5. Click *View Video*.
6. If the Administrator has restricted access to known users, you will then be prompted for a username and password.  
Enter the name and password assigned to you by the HD Battery Camera administrator.

FCC ID: P27BC855

IC: 527A-BC855

7. The first time you connect to the camera, you will be prompted to install decoders. Choose "**I accept the terms of the license agreement**" and click "OK".
8. Video will start playing automatically. There may be a delay of a few seconds while the video stream is buffered.

## Chapter 4

# Troubleshooting

*This chapter covers the most likely problems and their solutions.*

### Overview

This chapter covers some common problems that may be encountered while using the HD Battery Camera and some possible solutions to them. If you follow the suggested steps and the HD Battery Camera still does not function properly, contact your dealer for further advice.

### Problems

**Problem 1**      **Cannot View the streaming in a web browser**

**Solution 1**      Make sure that your browser is not blocking the plug-in and that you are using the latest version of Adobe Flash.

**Problem 2**      **The camera is offline.**

**Solution 2**

1. Unplug your camera, remove the battery, reinsert the battery, and pay attention to the camera LED behavior.
2. Note the LED behavior after the camera is done starting. Please check Chapter 2 LED section for more details.
3. If your camera is still offline, contact your dealer for further advice

**Problem 3**      **The image is blurry.**

**Solution 3**      Try cleaning the lens. Condensation can reduce picture quality for the camera that is used outdoors or in a wet indoor area. If your camera's picture quality is affected by condensation, the best solution is to purchase a camera skin with a built-in shade.

**Problem 4**      **Using the motion detection feature, I receive E-Mails which don't show any moving objects.**

**Solution 4**      The motion detection feature doesn't actually detect motion. It compares frames to see if they are different. Major differences between frames are assumed to be caused by moving objects.

But the motion detector can also be triggered by:

- Sudden changes in the level of available light
- Movement of the camera itself.

Try to avoid these situations. The motion detection feature works best in locations where there is good steady illumination, and the camera is mounted securely. This feature can NOT be used if the camera is outdoors.



# Appendix A

## Specifications

Model	BC855
Dimensions (H x W x D)	72mm x 93mm x 71.35mm
Operating Temperature	-10° C to 50° C
Charging Temperature	5° C to 35° C
Storage Temperature	-20° C to 50° C
Network Protocols	TCP/IP, HTTP, HTTPS, DHCP, NTP, RTP, RTCP, RTSP, DNS
Network Interface	IEEE 802.11b/g/n
IR LED	2
LEDs	1
Microphone	1 built-in Microphone
Button	1
Micro-SD Card slot	1 (w/o Micro-SD inside)
Speaker	1
Power Adapter	5V / 2A, 100 - 240V
Battery (C1-04)	1, Minimum capacity 6140 mAh (22.2Wh)
Micro-USB Cable	1M Cable

## Regulatory Approvals

### FCC Statement

This equipment generates, uses and can radiate radio frequency energy and, if not installed and used in accordance with the instructions, may cause harmful interference to radio communications. However, there is no guarantee that interference will not occur in a particular installation. If this equipment does cause harmful interference to radio or television reception, which can be determined by turning the equipment off and on, the user is encouraged to try to correct the interference by one of the following measures:

- Reorient or relocate the receiving antenna.
- Increase the separation between the equipment and receiver.
- Connect the equipment into an outlet on a circuit different from that to which the receiver is connected.
- Consult the dealer or an experienced radio/TV technician for help.

To assure continued compliance, any changes or modifications not expressly approved by the party responsible for compliance could void the user's authority to operate this equipment. (Example - use only shielded interface cables when connecting to computer or peripheral devices).

- Any changes or modifications not expressly approved by the party responsible for compliance could void the authority to operate equipment.
- This device and its antenna must not be co-located or operating in conjunction with any other antenna or transmitter.
- For product available in the USA/Canada market, only channel 1~11 can be operated. Selection of other channels is not possible

### FCC Radiation Exposure Statement

This equipment complies with FCC RF radiation exposure limits set forth for an uncontrolled environment. This equipment should be installed and operated with a minimum distance of 20 centimeters between the radiator and your body.

This device complies with Part 15 of the FCC Rules. Operation is subject to the following two conditions:

- (1) This device may not cause harmful interference, and
- (2) This device must accept any interference received, including interference that may cause undesired operation.

This transmitter must not be co-located or operating in conjunction with any other antenna or transmitter.

### CE Approvals

The camera meets the guidelines of the European Union and comply with the 99/5/EEC and RTTE 99/5EG directives.

This is a Class B product. In a domestic environment this product may cause radio interference in which case the user may be required to take adequate measures.

FCC ID: P27BC855

IC: 527A-BC855

## **ISED Statement**

This device complies with Industry Canada's licence-exempt RSSs. Operation is subject to the following two conditions: (1) This device may not cause interference; and (2) This device must accept any interference, including interference that may cause undesired operation of the device.

Le présent appareil est conforme aux CNR d'Industrie Canada applicables aux appareils radio exempts de licence. L'exploitation est autorisée aux deux conditions suivantes: (1) l'appareil ne doit pas produire de brouillage, et (2) l'utilisateur de l'appareil doit accepter tout brouillage radioélectrique subi, même si le brouillage est susceptible d'en compromettre le fonctionnement.

Industry Canada ICES-003 Compliance Label:

CAN ICES-3 (B)/NMB-3(B)

\* Insert either "A" or "B" but not both to identify the applicable Class of ITE.

This device and its antenna(s) must not be co-located or operating in conjunction with any other antenna or transmitter.

Cet appareil et son antenne (s) ne doivent pas être situés ou fonctionner en conjonction avec une autre antenne ou émetteur.

## **IC Radiation Exposure Statement:**

This equipment complies with ISED radiation exposure limits set forth for an uncontrolled environment. This equipment should be installed and operated with minimum distance 20cm between the radiator & your body.

Cet équipement est conforme aux limites d'exposition au rayonnement ISED établies pour un environnement non contrôlé. Cet équipement doit être installé et utilisé à une distance minimale de 20 cm entre le radiateur et votre corps.