



## ADT Pulse® Interactive Solutions DBC845 FHD Wireless Doorbell Camera

Property of ADT, LLC. Information accurate as of published date and is provided “as is” without warranty of any kind.

©2017 ADT LLC dba ADT Security Services. All rights reserved. ADT, the ADT logo, 800 ADT.ASAP and the product/service names listed in this document are marks and/or registered marks. Unauthorized use is strictly prohibited.

## 1 Introduction

This section provides information about the Doorbell Camera features, components and capabilities.

### Packaging Contents

The following items are included in the package.

1. Doorbell Camera x 1

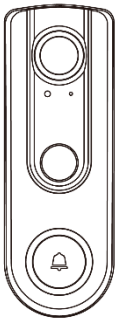

2. Two Mounting Brackets (Small Slim & Gang Plate size)

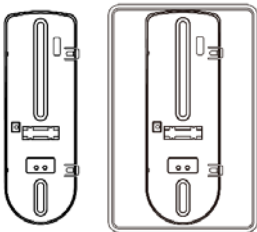

3. Wedge Kit (15°, 30° Angles)

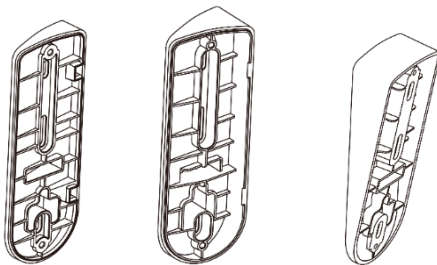

15° Wedge

30° Wedge

15° Tilt

4. (No.1) Screw/Anchor x 2



5. (No.2) Screw x 2



6. (No.3) Screw x 2



7. (No.4) Screw x 2



8. Bubble Level

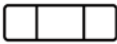

9. Always On Bracket



## Physical Details

The DBC845 supports both analog and digital chimes within 8-24 AC voltage range. The operation temperature is  $-4^{\circ}\text{F}$  to  $122^{\circ}\text{F}$ . ( $-20^{\circ}\text{C}$  to  $50^{\circ}\text{C}$ )  
(The battery will not be charged when the temperature is  $< 32^{\circ}\text{F}$  or discharge when internal temperature is  $> 138^{\circ}\text{F}$ )

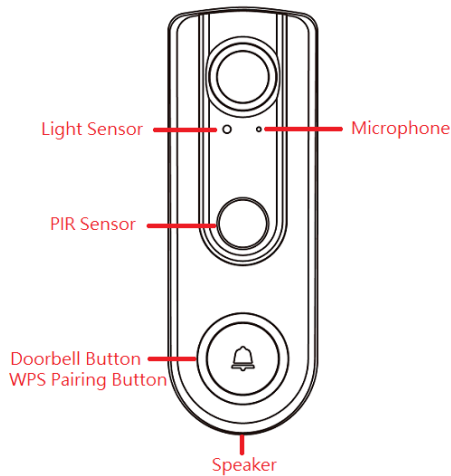

Figure 1-1 Front Panel

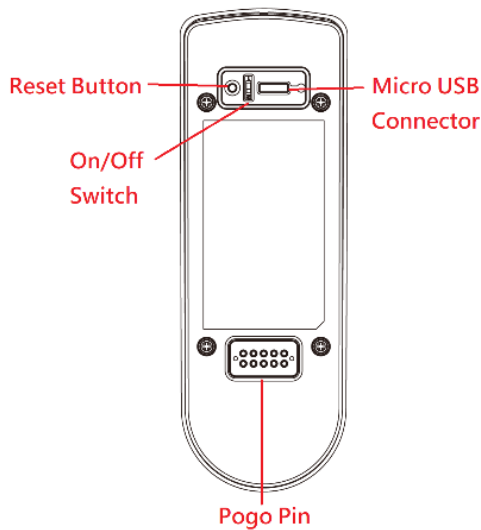

Figure 1-2 Rear Panel



## Overview

Doorbell/WPS Button has two functions:

**WPS Pin Code Mode:** When pressed and held 5 seconds, the doorbell camera will be in WPS Pin Code Mode.

*Note: When Wi-Fi connection is established, the WPS function is disabled.*

**Doorbell Mode:** Press the button to ring the door chime.

### LED Activity & Behavior:

Doorbell Activity	LED Color	LED Intensity	LED Behavior	Description
Power Up	ADT Blue	Medium	Solid	
WPS Mode	Green	Medium	Blinking	Time out 2 mins
WPS Failure	Red	Medium	Solid for 5 seconds	When WPS pair fails, RED LED solid on for 5s. Then return back to Network disconnection behavior till someone press WPS button again.
Network Connected	ADT Blue	Medium	Solid	After connected to network, then LED goes into Standby mode and related LED behavior while working mode is timeout.
Network Disconnection	Red	Medium	Blinking	This priority is higher than Network Standby mode
A/C Disconnected (or other external power resource in the future.)	Red	Medium	Intermittent Blinking in 2s	LED will blink red with 2 second when wired and A/C is not detected. At this moment, if the network is connected, the ADT blue is solid, then red LED is edges blinking and then after ADT blue 10s edges m. * When Battery pack replaces AC cable in the future, this LED behavior will present Battery pack connection status.
Standby (Sleep Mode)	ALL	NA	OFF	This priority is higher than Network connected.
Standby to PIR trigger	ADT Blue	Dim	ON	After PIR trigger without button press.
Doorbell Button Pressed	ADT Blue	Off-Dim-High	Pulsing for 10 seconds	LED will pulse between OFF(1s) -> dim -> High(1s) intensity while the session is set up. Then return back to Network connection behavior till Doorbell run into standby mode.



FW download In Progress	Green	Medium	Spinning	<i>Spinning will indicate FW being downloaded. Once complete, update takes place and doorbell reboots. LED then goes into Power Up mode</i>
Factory Reset	Red	Medium	Triple Blink	When Reset pin is held down for 10 seconds, once released, LED will blink red triple indicating the start of the reboot/factory reset
No Power	Dark	N/A	N/A	LED not powered

## 2 Basic Setup

This section provides information on how to assemble and configure the DBC845 Doorbell Camera for enrollment.

### Installation

#### 1. Power-Up and Check LED

Turn on the switch on the rear side of the doorbell camera and wait for 20 seconds until the LED turns to flashing red.



**Note:** The internal battery supports about 40 minutes of operation. If you don't see the camera powering up, please charge the doorbell camera via Micro USB cable with USB charger for 45 min before installation.

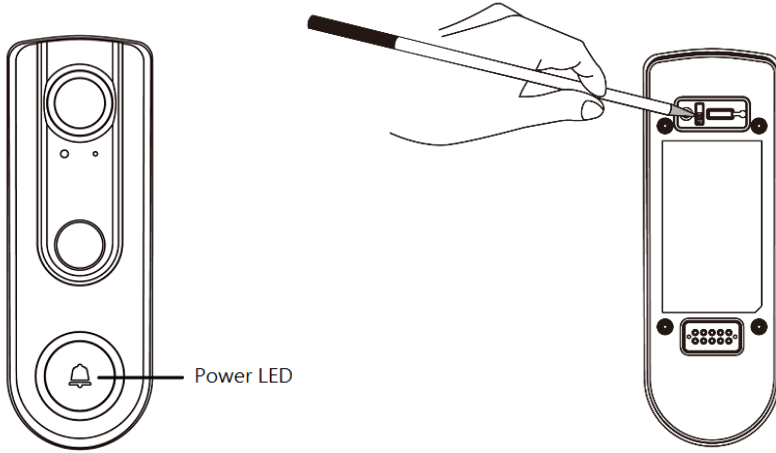

Figure 2-1 Power LED

#### 2. Enroll the Camera in ADT Pulse

This process is described in section 3 [ADT Pulse Enrollment](#).

#### 3. Mounting the Doorbell Camera

Mount the camera in its final permanent location. Please refer to section 4 [Hardware Installation](#) for more details.

### 3 ADT Pulse Enrollment

This section provides instructions for wirelessly enrolling the DBC845 Doorbell Camera into the ADT Pulse network. This process uses Wi-Fi Protected Setup (WPS) with PIN method to wirelessly enroll the HD Camera to gateway via the ADT Pulse portal or Installer App.

#### Using WPS with PIN

1. Power up the camera and wait for the LED to turn flashing red, as described in the previous chapter.
2. Launch web browser and log into the Pulse portal or installer app.
3. Enter the *Manage Devices* screen using one of the following methods.
  - For the Pulse portal, select the *System* tab and click *Manage Devices*.
  - For Installer app, click the *Pulse Devices* link.
4. In *Manage Devices* screen, click *Cameras*.

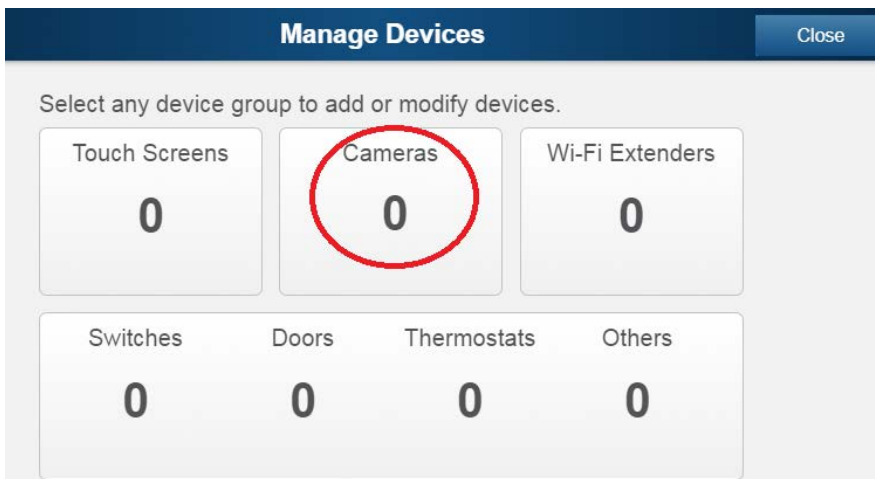

Figure 3-1 Clicking "Cameras" Button





5. Click the **Add Using WPS** button at the bottom of screen as shown in Figure 3-2.

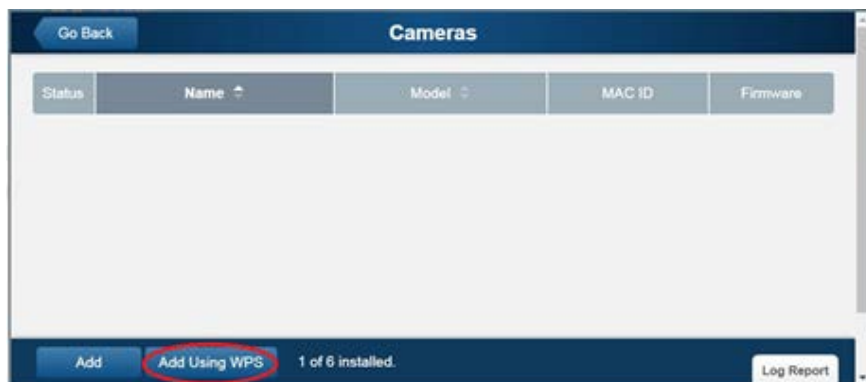

Figure 3-2 Clicking Add Using WPS Button

6. Locate the camera PIN number on the label on the rear of the camera. Enter the PIN number in the WPS PIN field as shown in Figure 3-3.

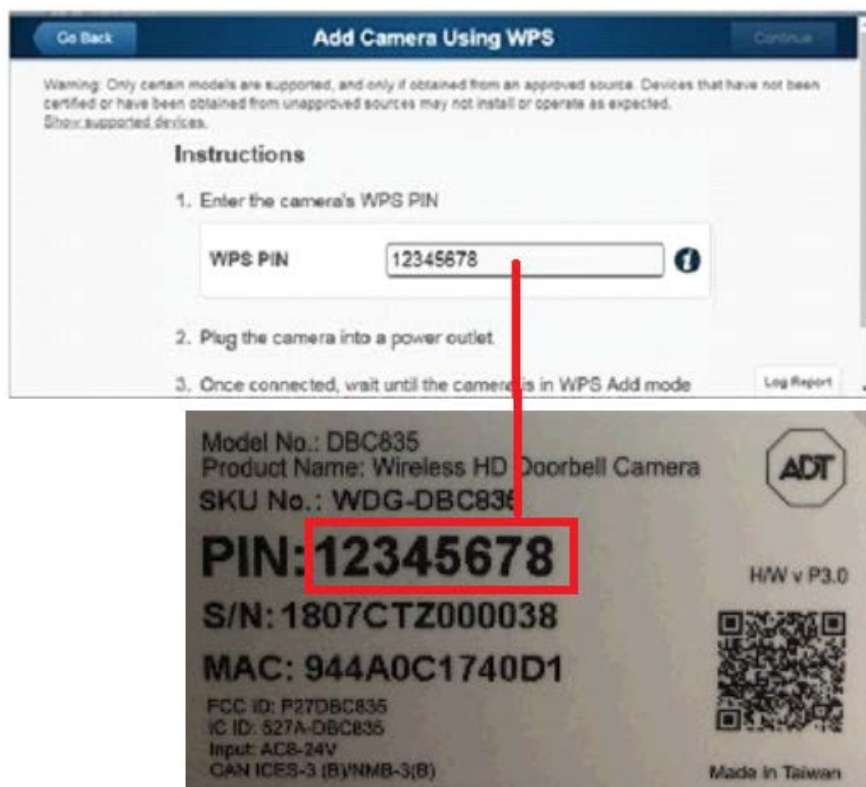

Figure 3-3 Entering the PIN

7. Click the Continue button to initiate the WPS process.

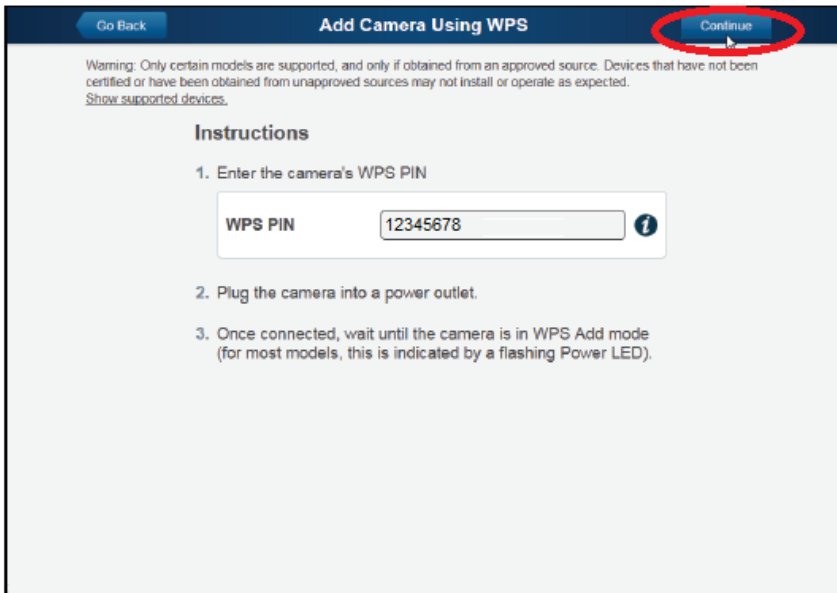

Figure 3-4 Clicking "Continue" Button

8. Press the doorbell button, the LED will blink green during WPS process.



**Note:** This WPS process must be completed within 2 minutes or else it will be timed out. The remaining time is displayed in the upper left portion of the screen.



Figure 3-5 Add Camera Using WPS Screen



9. Once the doorbell camera is enrolled, the Camera Details screen will be displayed. Name the device and select the desired bandwidth & chime type. Click **Save** after entering or change settings.

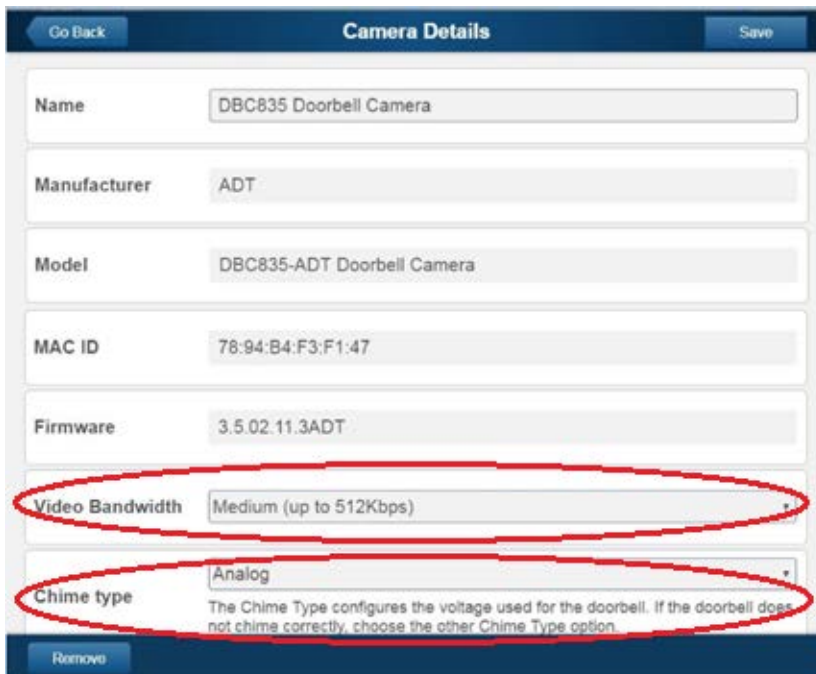

Figure 3-6 Saving Camera Details

10. The newly added device will be shown in the Camera List, then click **Go Back** at the top left of the screen as shown in Figure 3-7.

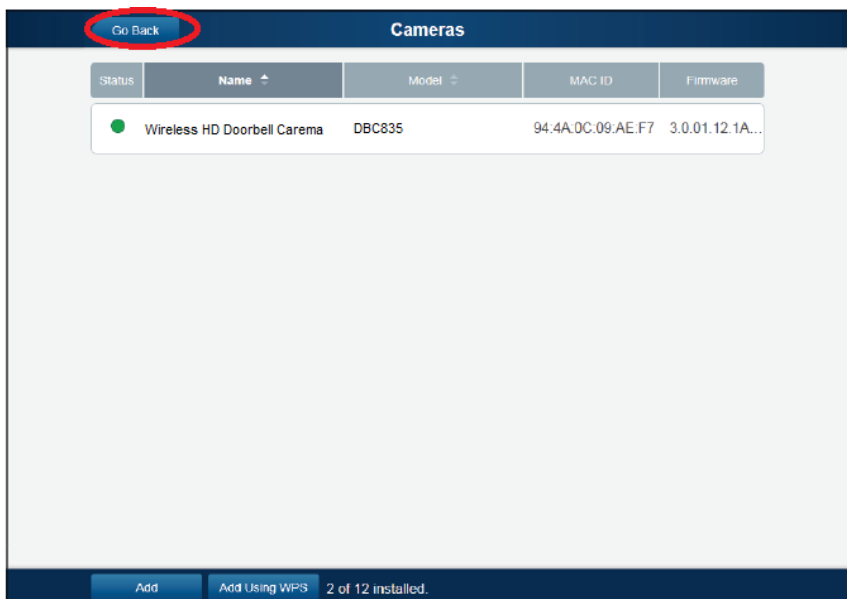

Figure 3-7 Clicking Go Back Button

11. The Manage Devices screen is displayed, click Close.



Figure 3-8 Manage Devices Screen

12. Click System page to verify the device enrollment.

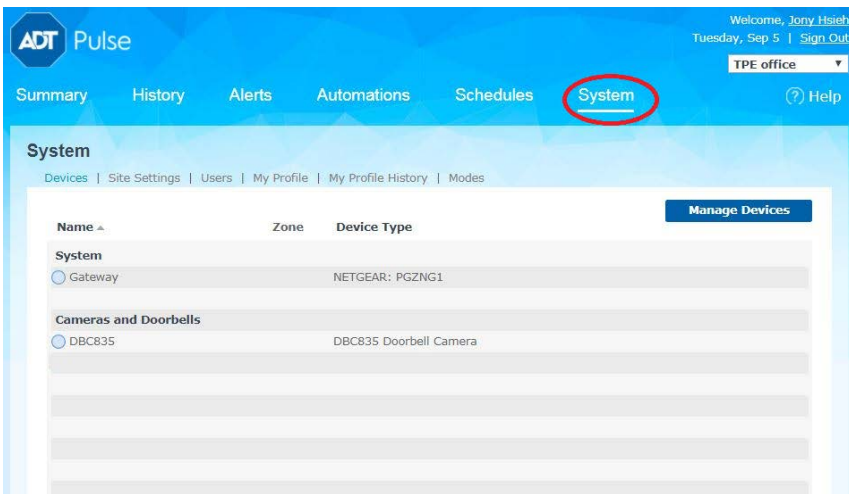

Figure 3-9 System Screen

13. Move the doorbell to where it will be mounted and check the LED and site diagnostics to verify Wi-Fi signal strength.



**Note:** If the Wi-Fi cannot reach the doorbell camera, you will see the LED blinking red. Relocate the Pulse gateway / TS or Cloud Link if possible or add a Wi-Fi repeater to improve the signal strength to the doorbell camera.



## 14. Factory Reset Instructions:

- A. Press the doorbell button to wake up the device
- B. If already enrolled, the device will “ding-dong”
- C. If not already enrolled, the device will go into WPS mode and blink green
- D. Press and hold the reset button on the back until you hear a ring (about 10 seconds), then release to start the reset process
- E. If you don’t hear the ring, press the doorbell button again to ensure it is awake and perform step “D” again
- F. The unit may need to be charged via USB if the battery is too low to perform the factory reset

## 4 Hardware Installation

This section provides details for mounting the DBC845 Doorbell Camera.



### Installing Hardware

**Note:** Ensure the camera is configured and enrolled in ADT Pulse before permanently mounting.

1. Turn off the breaker circuit before disconnecting legacy doorbell button.

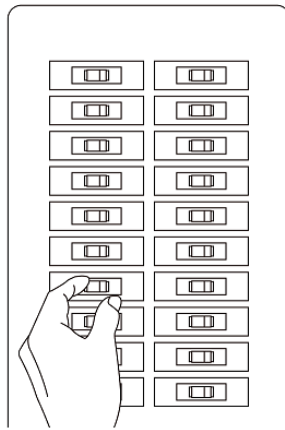

Figure 4-1 Breaker Circuit

2. Unscrew the legacy doorbell to locate two power wires. (The recommended installation height is between 47 -60 inches.)

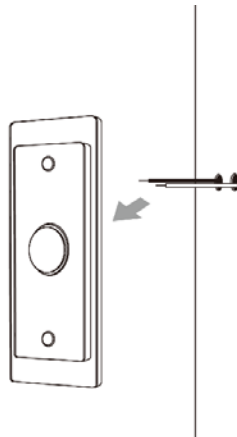
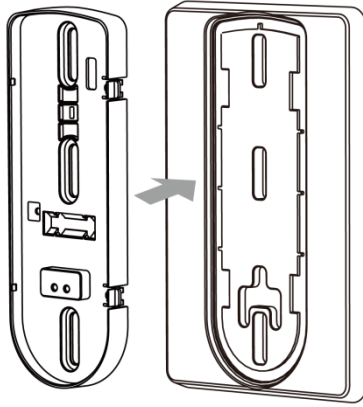

Figure 4-2 Mounting Location



**Note:** Check the voltage at the doorbell to ensure voltage is between 9 ~ 24 VAC. If the voltage is DC, then the DC845 does not support this voltage type.

3. Choose the mounting bracket that will cover the hole of the legacy doorbell button. The larger bracket should be used with gang boxes.



*Figure 4-3 Choosing Mounting Bracket*

4. Connect the power wires from the existing doorbell to the screw terminals of the bracket.

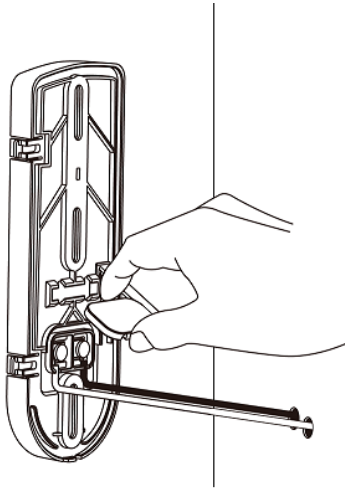

*Figure 4-4 Connecting the power Wires*



- Secure the bracket with screws (No. 1 or No. 2). Please see Figure 4-5.

**Note:** Install the anchors if necessary.

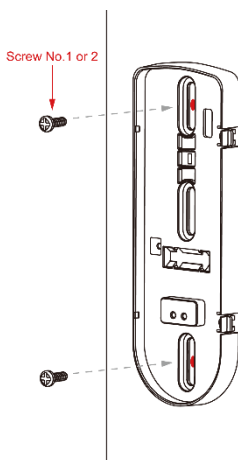

Figure 4-5 Installing the Screws

- Attach the doorbell camera to the mounting bracket. Make sure the doorbell camera is firmly fixed and working properly.



**Caution:** To avoid damaging the rubber seal of the pogo pins, please attach the camera to the mounting bracket flush. Mounting bracket should lay flat against the wall. Over torquing can warp the bracket and cause it to lose contact with pins.

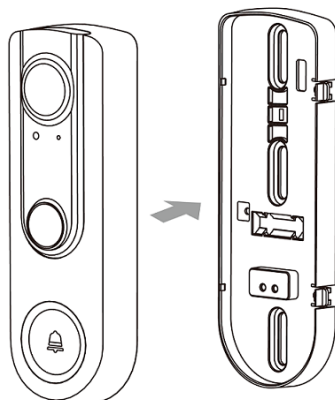

Figure 4-6 Attaching the Camera to the Bracket

- Turn on the breaker circuit.
- Check that the chime is working normally by pushing the doorbell button. If the AC wires are not connected properly, the LED will blink Red every 5 seconds.



**Note:** Please check if the chime sounds, if not, the chime type should be changed in the ADT Pulse portal under Manage Devices.

### Using the Wedge Kit (Optional)

If needed, you can mount your doorbell at an angle for better view and motion detection. The wedge kit comes with 3 plates which can be used to tilt the camera forward or sideways by 15/30 degrees.

1. Use the two screws (No.1) to install the wedge into the wall. The larger bracket should be used with gang box.

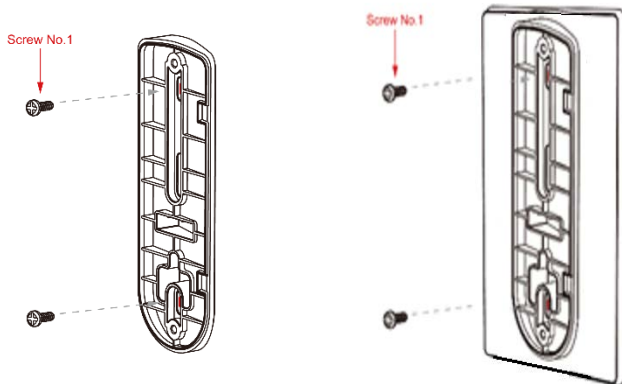

Figure 4-7 Install the Wedge

2. Secure the bracket to the wedge with the two screws (No.3 or No. 4).

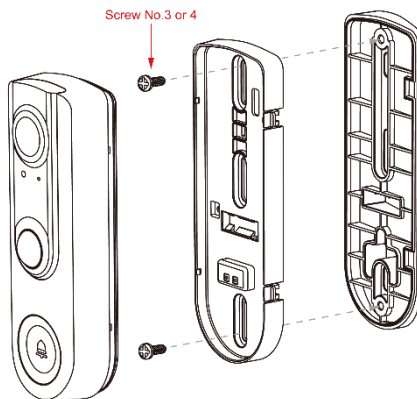
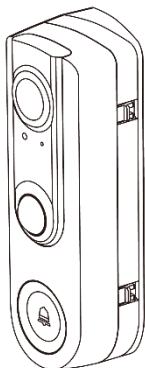

Figure 4-8 Attaching the Bracket to the Wedge



3. Attach the doorbell camera to the bracket.



*Figure 4-9 Attaching the Camera to the Bracket*

4. Apply the Audio Video Surveillance Sticker.

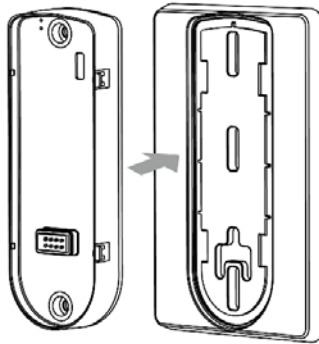

*Figure 4-10 Audio & Video Surveillance Sticker*

## Always On Bracket Installation

The Always On bracket can only be installed with mechanical doorbell chimes (AC16V~24V). In this configuration, the doorbell camera will be in always on mode, which brings back the 5 second pre-buffer, connects live view faster, and removes the need for the internal battery to be charged.

1. Choose the mounting bracket that will cover the hole of the legacy doorbell button. The larger bracket should be used with gang boxes.



*Figure 4-11 Choosing Mounting Bracket*

2. Connect the power wires from the existing doorbell to the screw terminals of the bracket.

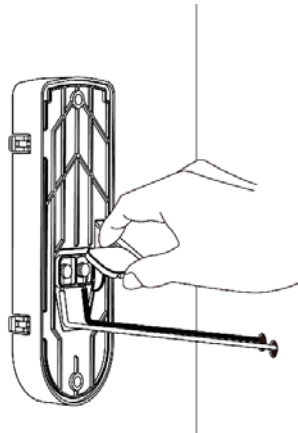

*Figure 4-12 Connecting the power Wires*

3. Secure the bracket with screws (No.1 or No.2). Please see Figure 4-13.

*Note: Install the anchors if necessary.*

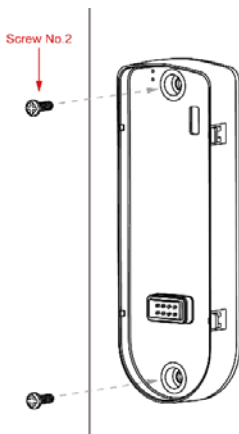

Figure 4-13 Installing the Screws

4. Attach the doorbell camera to the mounting bracket. Make sure the doorbell camera is firmly fixed and working properly.



**Caution:** To avoid damaging the rubber seal of the pogo pins, please attach the camera to the mounting bracket flush. Mounting bracket should lay flat against the wall. Over torquing can warp the bracket and cause it to lose contact with pins.

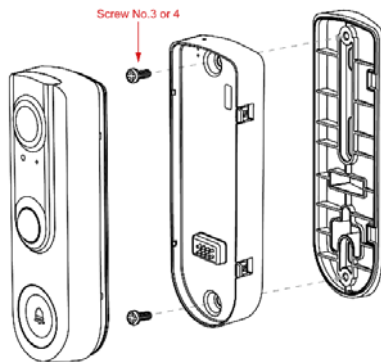

Figure 4-14 Attaching the Camera to the Bracket

## 5 Appendix

### Product Spec

#### Wireless Doorbell Camera

Model	DBC845
Dimensions (H x W x D)	121.15 x 42.25 x 30.8mm
Operating Temperature	<p>Mounting Bracket and Battery Pack mode: -20°C to 50°C</p> <p>Always On Bracket mode:</p> <ul style="list-style-type: none"> <li>● -20°C to 40°C ( Day Mode)</li> <li>● -20°C to 35°C ( Night Mode)</li> </ul>
Storage Temperature	-20° C to 45° C
Network Protocols	TCP/IP, HTTP, HTTPS, DHCP, uPnP, NTP, RTP, RTCP, RTSP, DN
Wireless	802.11 b/g/n
LED	1
Microphone	Built-in Microphone
Button	<p>Doorbell/WPS Button x 1</p> <p>Reset button x 1</p>
Speaker	1 built-in Microphone
Power Adapter	<p>USB charger: DC 5V,1A</p> <p>Internal Battery Power : capacity 730mA</p> <p>Charging Temp : 0°C to 20°C</p>



## Regulatory Approvals

### FCC Statement (US)

This equipment has been tested and found to comply with the limits for a Class B digital device, pursuant to part 15 of the FCC rules. These limits are designed to provide reasonable protection against harmful interference in a residential installation. This equipment generates, uses and can radiate radio frequency energy and, if not installed and used in accordance with the instructions, may cause harmful interference to radio communications. However, there is no guarantee that interference will not occur in a particular installation.

If this equipment does cause harmful interference to radio or television reception, which can be determined by turning the equipment off and on, the user is encouraged to try to correct the interference by one or more of the following measures:

- Reorient or relocate the receiving antenna.
- Increase the separation between the equipment and receiver.
- Connect the equipment into an outlet on a circuit different from that to which the receiver is connected.
- Consult the dealer or an experienced radio/TV technician for help.

To assure continued compliance, any changes or modifications not expressly approved by the party responsible for compliance could void the user's authority to operate this equipment. (Example - use only shielded interface cables when connecting to computer or peripheral devices).

### RF Exposure Part

This equipment complies with FCC RF radiation exposure limits set forth for an uncontrolled environment. This transmitter must not be co-located or operating in conjunction with any other antenna or transmitter.

This equipment should be installed and operated with a minimum distance of 20 centimeters between the radiator and your body.

## IC Statement (Canada)

This device complies with Industry Canada's licence-exempt RSSs.

Operation is subject to the following two conditions:

- (1) This device may not cause interference; and
- (2) This device must accept any interference, including interference that may cause undesired operation of the device.

Le présent appareil est conforme aux CNR d'Industrie Canada applicables aux appareils radio exempts de licence. L'exploitation est autorisée aux deux conditions suivantes :

- (1) l'appareil ne doit pas produire de brouillage ;
- (2) l'utilisateur de l'appareil doit accepter tout brouillage radioélectrique subi, même si le brouillage est susceptible d'en compromettre le fonctionnement.

This transmitter must not be co-located or operating in conjunction with any other antenna or transmitter. This equipment should be installed and operated with a minimum distance of 20 centimeters between the radiator and your body.

Cet émetteur ne doit pas être Co-placé ou ne fonctionnant en même temps qu'aucune autre antenne ou émetteur. Cet équipement devrait être installé et actionné avec une distance minimum de 20 centimètres entre le radiateur et votre corps.

### Exposure

This device meets the exemption from the routine evaluation limits in section

2.5 of RSS102 and users can obtain Canadian information on RF exposure and compliance.

Le dispositif rencontre l'exemption des limites courantes d'évaluation dans la section 2.5 de RSS 102 et la conformité à l'exposition de RSS-102 rf, utilisateurs peut obtenir l'information canadienne sur l'exposition et la conformité de rf.