SCD2R0-29

Wireless FHD

Doorbell Camera



Setup Guide

Copyright © 2019. All Rights Reserved.

Document Version: 1.1

Table of Contents

Chapter 1 Introduction	1
Package Contents	1
Physical Details	2
Chapter 2 Setup	5
System Requirements.....	5
Installation	5
Chapter 3 Hardware Installation	8
Overview	8
Power Kit Installation	11
Always On Bracket Installation (Optional).....	12
Battery Pack Installation (Optional).....	13
Appendix A Specifications.....	14
Wireless Doorbell Camera.....	14
Regulatory Approvals	15

Chapter 1

Introduction



This section provides information about the Doorbell Camera features, components and capabilities..

Package Contents

The following items should be included: If any of these items are damaged or missing, please contact your dealer immediately.

1. Doorbell Camera x 1



2. Screw/Anchor x 2

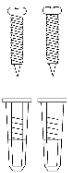

3. Always On Bracket x 1 (Optional, may not included in the package)



Physical Details

The SCD2R0-29 supports both analog and digital chimes within 8-24 AC voltage range. The operation temperature of SCD2R0-29 with regular mounting bracket and Battery pack is -4°F to 122°F (-20°C to 50°C). As to SCD2R0-29 with Always on bracket, the operating temperature is -4°F to 104°F . (-20°C to 40°C) on day mode and -4°F to 95°F . (-20°C to 35°C) on night mode.

Note:

1. The Doorbell internal battery will not be charged when the temperature is $< 32^{\circ}\text{F}$ (0°C) and $> 122^{\circ}\text{F}$ (50°C) or discharge when internal temperature is $< -4^{\circ}\text{F}$ (-20°C) and $> 138^{\circ}\text{F}$ (60°C)
2. The battery of Battery Pack can only be charged 0°C to 35°C , 85% RH Max, and discharged -20°C to 50°C , 85% RH Max

Front Panel

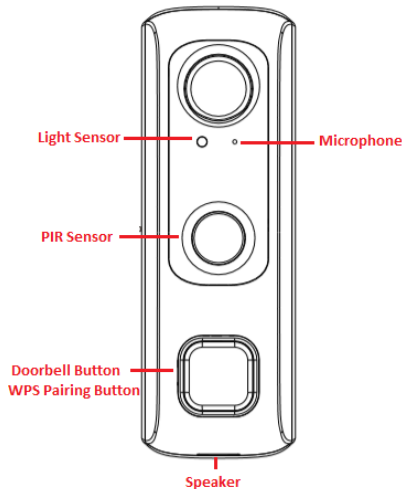

Light Sensor

This is hardware sensor to detect LUX.

Microphone

The built-in microphone is useful for bi-direction voice conversation.

PIR Sensor

This is hardware sensor to detect motion.

Doorbell/WPS Pairing Button

Doorbell/WPS Button has two functions:

- **WPS Pin Code Mode:** When doorbell button is held down for more than 3 seconds, the doorbell camera will be in WPS Pin Code Mode.
- **WPS PBC Mode.** When doorbell button is held down for less than 3 seconds, the Wireless HD Doorbell Camera will be in the WPS PBC mode (Auto link mode).

Note: When Wi-Fi connection is established, the WPS function is disabled.

- **Doorbell Mode:** Press the button to ring the door chime.

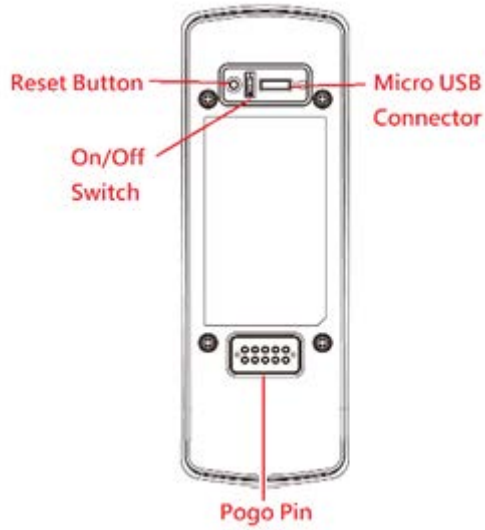
Rear Panel**Reset Button**

When pressed and held over 10 seconds, the LED will be solid amber, which means the settings of camera will be set to their default values.

On/Off Switch

Use this switch to turn on/off the device.

Micro USB Connector

This connector is used for charging the power. Connect the supplied Micro-USB cable to this port.

LED Activity & Behavior

Doorbell Activity	LED Color	LED Behavior	Description
Factory Reset	Amber	Solid	Press the reset button for 10 seconds to start this process.
WPS Pairing (PIN Code Mode)	Amber	Blinking (200ms)	When doorbell button is held down for more than 3 seconds, the LED will start flashing amber indicating doorbell camera is trying to connect to your Wi-Fi network in Pin Code mode.
WPS Pairing (PBC Mode)	Amber	Blinking (500ms)	When doorbell button is held down for less than 3 seconds, the LED will start flashing amber indicating doorbell camera is trying to connect to your Wi-Fi network in PBC mode.
WPS Failure	Amber	Solid (5s)	If doorbell camera fails during WPS enrollment, the LED will be solid on for 5 seconds.
Network Connected (Boot-up)	Green	Blinking (500ms)	When the doorbell camera is trying to connect the network, LED color will change to blinking green.
USB charge+ Battery < 80%	Blue	Blinking (1s)	LED spinning blue indicates the camera is charging for power.
PIR Triggered	Blue	Solid	When PIR detects motion the LED will turn solid blue.
Doorbell Button Press	Blue	Solid	NA
Intercom	Green	Whirling (2s)	Green LED will pulse between dim and medium intensity for two seconds while waiting for interactive session.

Chapter 2

Setup

2

This Chapter provides details on how to install and configure the Doorbell Camera.

System Requirements

- A computer with Internet access
- You can use the following web browser while using a computer:
 - Internet Explorer 10 or later
 - Firefox 3.5 or later
 - Safari 3 or later (Mac OS X only)
 - Chrome
 - Microsoft Edge

Installation

1. Power-Up and Check LED

Turn on the switch on the rear side of the doorbell camera and wait for 20 seconds until the LED turns to flashing amber.

Note: The internal battery supports about 40 minutes of operation. If you don't see the camera powering up, please charge the doorbell camera via Micro USB cable with USB charger (DC5V1A or above) for 45 minutes before installation.

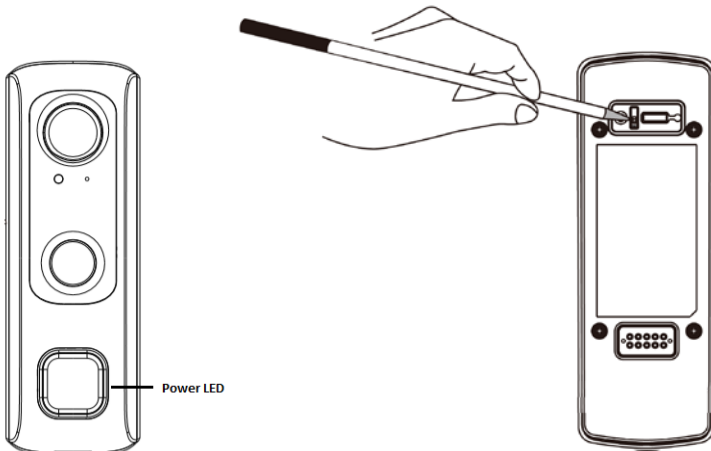

2. Add the Doorbell Camera to your network.

- a. Doorbell will detect the Wireless device (AP or router) which is **Disable the Wireless Security** automatically.



The default Wireless settings are:

Mode: Infrastructure
SSID: ANY
Wireless Security: Disabled
Domain: USA
Channel No.: Auto

- b. 1) **WPS PBC Mode** : Press the Doorbell button for less than 3 second and on your Wireless device (AP or router) as well to establish a wireless connection automatically. The wireless connection is successful when the Green LED blinking.
- 2) **WPS Pin Code Mode** : Key in the PIN code of Doorbell's back label on the Client PIN code of AP, and then held down Doorbell button for more than 3 seconds, the Doorbell Camera will be in the WPS Pin Code mode.
- (Please make sure if your AP or router support the WPS Pin code mode)



Note: Once Doorbell ever connected to AP by WPS or GUI configuration, then the push button is no longer for WPS function.

Please restore the Doorbell to factory default on working mode, after then try the WPS again to connect another AP.

- c. Obtain the IP Address of Doorbell on Wireless device (AP or router) device page. And start the Internet Explorer. After then enter the IP Address of Doorbell on the Address box of Internet Explorer (ex. <http://192.168.1.223>)
- d. When you connect, the following screen will be displayed.
- e. Click View Video.
- f. The first time you connect to the camera, you will be prompted to install decoders. Choose "I accept the terms of the license agreement" and click "OK".

Note: The options can only be configured while using IE browser. Other browsers can just view the video rather than configuration.

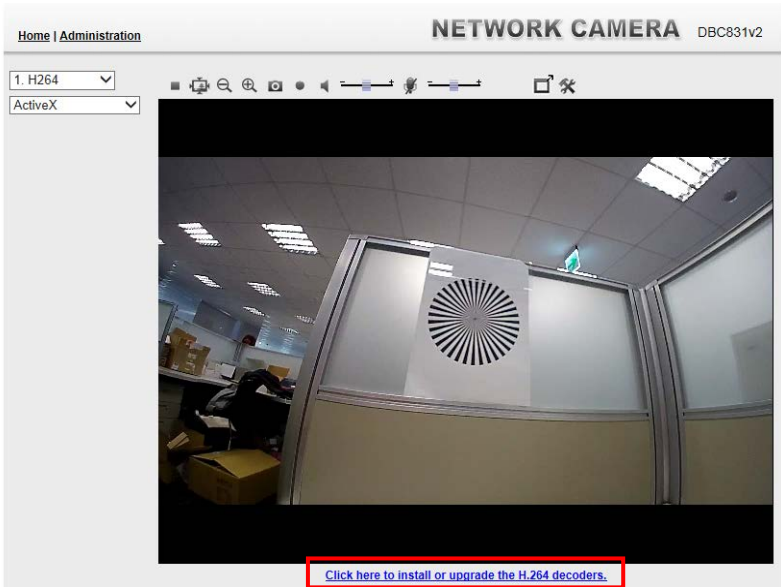

- g. Video will start playing automatically. There may be a delay of a few seconds while the video stream is buffered.
- h. If the Administrator has restricted access to known users, you will then be prompted for a username and password.
Enter the name and password assigned to you by the Doorbell administrator.



The default log in Administration:

User Name: administrator

Password: Blank

- i. Access the Administration for more Doorbell settings on SCD2R0-29 GUI.

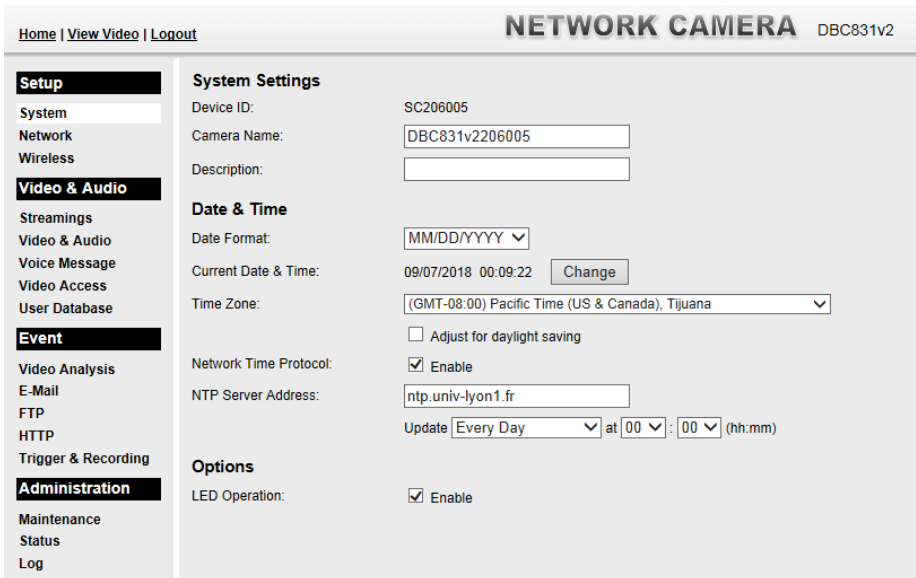

- 3. **Switch to analog or digital chime according to your existing doorbell in the process.** (The default chime which SCD2R0-29 support is analog type; the customers are required to develop this feature on the App)

If your existing doorbell produces an electronic sound that is programmable and comes in the form of a unique sound, it's a digital chime. If it has a traditional "ding dong" sound, it's a compatible analog chime.



4. **Complete the pairing process and unplug the Micro USB cable from the Doorbell Camera.**
5. **Identify the location for Mounting the Doorbell Camera**

The recommended installation height of the Doorbell Camera is about 130~150cm from the ground. Please refer to [Chapter 3 Hardware Installation](#) for more details.

Chapter 3

Hardware Installation

This chapter covers the most likely problems and their solutions.

Overview

Note: Ensure the camera is configured and enrolled in AP or router before permanently mounting.

Note: If SCD2R0-29 is using for engineering develop purpose, it is available to use Mirco USB cable to charge the battery for replacing the transformer. And doorbell does not require attaching with the chimer.

1. Check the voltage at the chimer to ensure voltage is between 8 ~ 24V AC.
2. Turn off the breaker circuit before disconnecting legacy doorbell button.

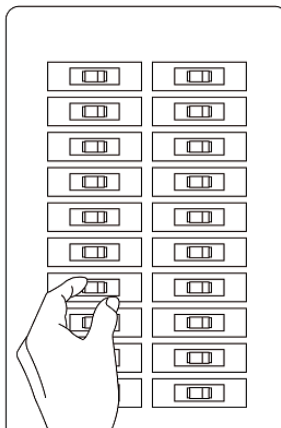

3. Unscrew the legacy doorbell to locate two power wires. (The recommended installation height is between 47 -60 inches.)

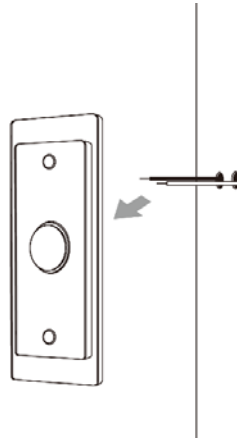

4. Choose either the Always On bracket or the regular mounting bracket that will cover the hole of the legacy doorbell button.
Please check [Always On Bracket Installation](#) section for more details
5. Connect the power wires from the existing doorbell to the screw terminals of the bracket.

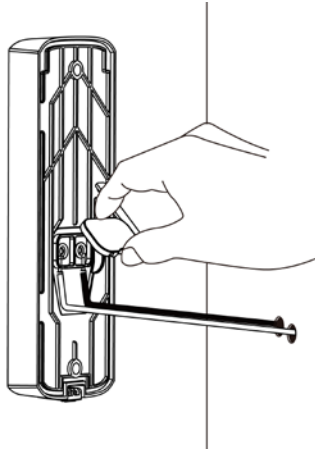

6. Secure the bracket with screws.
Note: Install the anchors if necessary. The provided lever can be used for measuring angles to prevent inclination.

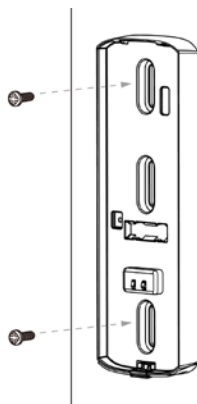

7. Attach the doorbell camera to the mounting bracket. Make sure the doorbell camera is firmly fixed and working properly.

Caution: To avoid damaging the rubber seal of the pogo pins, please attach the camera to the mounting bracket flush. Mounting bracket should lay flat against the wall. Over torquing can warp the bracket and cause it to lose contact with pins.

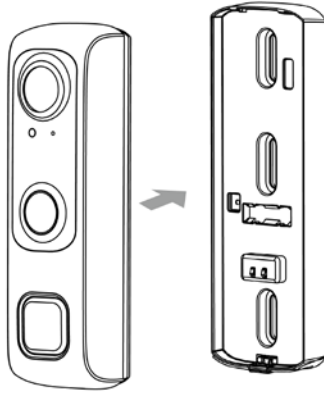

8. Turn on the breaker circuit.
9. Check that the chime is working normally by pushing the doorbell button. If the AC wires are not connected properly, the LED will blink amber every 5 seconds.

Power Kit Installation

The Power Kit included with the doorbell camera is a small device, which support Doorbell with any kinds of analog and digital chime usage by going between the doorbell transformers and chime wiring.

Note: Before removing or attaching wires to your original bell, be sure that the power is turned off at the breaker box. Consult a licensed electrician if needed.

1. Turn off the circuit breaker for the indoor chimer.
2. Remove the cover from the indoor chimer.
3. Loosen the "Front" and "Trans" terminal screws on the indoor chimer.

Loosen the "Front" and "Trans" terminal screws on the indoor chimer.

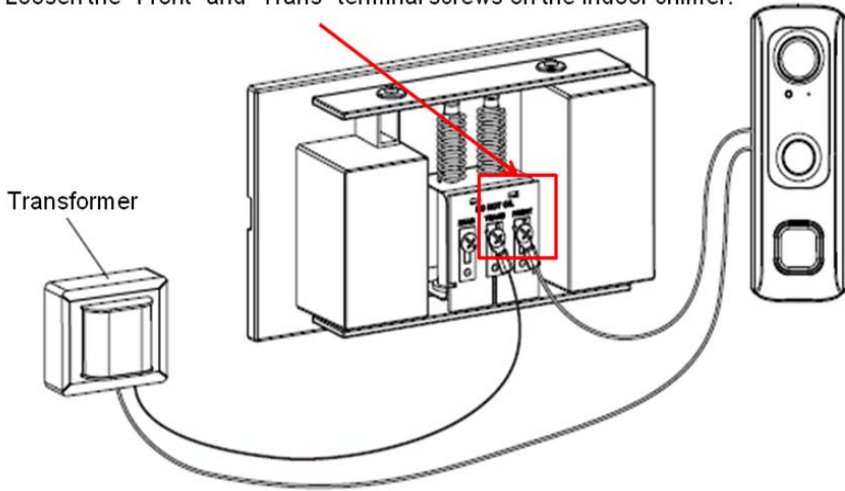

4. Connect white wire from the Power Kit to the "Front" terminal, and the black wire to the "Trans" terminal, leaving the existing doorbell wires in place. Then, re-tighten the screws.

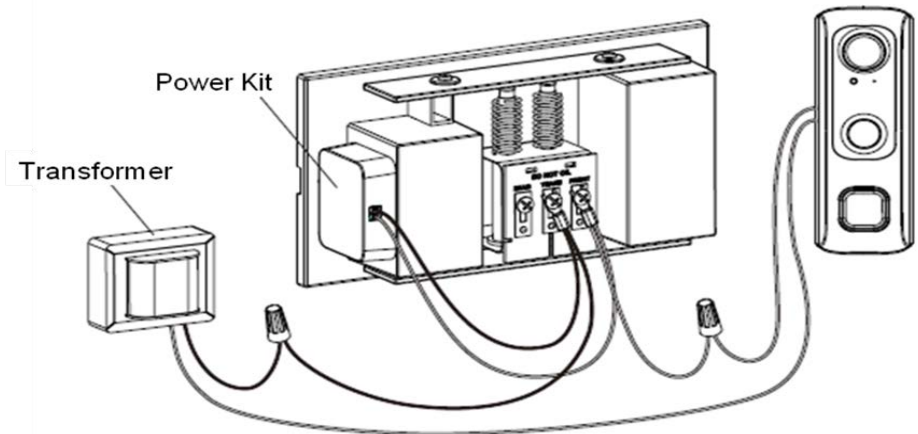

5. Position the Power Kit inside your indoor chimer, away from any moving parts. Use the adhesive (foam tap) on the back of the Power Kit to fix it in place, if desired.
6. Attach the cover back to the indoor chimer, and turn the power on at the breaker.

Always On Bracket Installation (Optional)

The Always On bracket (may not be included in the package) can only be installed with mechanical doorbell chimes (AC16V~24V). In this configuration, the doorbell camera will be in always on mode, which brings back the 5 second pre-buffer, connects live view faster, and removes the need for the internal battery to be charged.

1. Use the always on bracket that will cover the hole of the legacy doorbell button.
2. Connect the power wires from the existing doorbell to the screw terminals of the bracket.

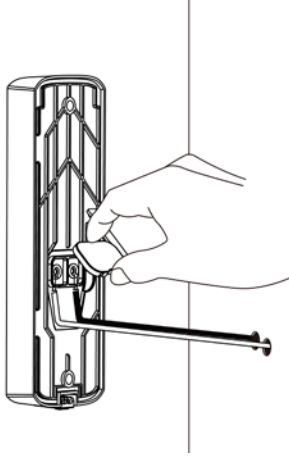

3. Secure the bracket with screws.

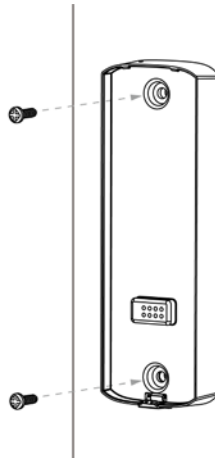

4. Attach the doorbell camera to the mounting bracket. Make sure the doorbell camera is firmly fixed and working properly.
Caution: To avoid damaging the rubber seal of the pogo pins, please attach the camera to the mounting bracket flush. Mounting bracket should lay flat against the wall. Over torquing can warp the bracket and cause it to lose contact with pins.

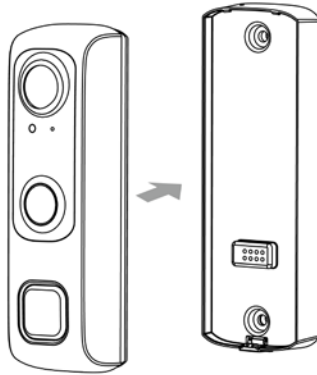

Specification

LED	LED x 1 (Green)
Waterproof Enclosure	IP65
Pogo Pin	2 x 4 (8 Pin)
Power	AC16~24V

Doorbell Attached Always on Bracket LED Activity & Behavior

Doorbell Activity	LED Color	LED Intensity	LED Behavior	Description
Bracket Connected	Blue	Dim	Solid	After connected to the doorbell, LED color will turn to dim blue.

Appendix A

Specifications



Wireless Doorbell Camera

Model	Wireless 2-Way Doorbell Camera
Dimensions (H x W x D)	126 mm * 42.7mm * 35.2mm (4.96 x 1.68 x 1.39)
Operating Temperature	Mounting Bracket and Battery Pack mode: -20°C to 50°C Always On Bracket mode: <ul style="list-style-type: none">● -20°C to 40°C (Day Mode)● -20°C to 35°C (Night Mode)
Storage Temperature	-20° C to 45° C
Network Protocols	TCP/IP, HTTP, HTTPS, DHCP, uPnP, NTP, RTP, RTCP, RTSP, DN
Wireless	802.11 b/g/n
IR LED	1
LED	1
Microphone	Built-in Microphone
Button	Doorbell/WPS Button x 1 Reset button x 1
Speaker	1 built-in Microphone
Power Adapter	USB charger: DC 5V,1A Internal Battery Power : capacity 730mA Charging Temp : 0°C to 20°C

Regulatory Approvals

FCC Statement

This equipment generates, uses and can radiate radio frequency energy and, if not installed and used in accordance with the instructions, may cause harmful interference to radio communications. However, there is no guarantee that interference will not occur in a particular installation. If this equipment does cause harmful interference to radio or television reception, which can be determined by turning the equipment off and on, the user is encouraged to try to correct the interference by one of the following measures:

- Reorient or relocate the receiving antenna.
- Increase the separation between the equipment and receiver.
- Connect the equipment into an outlet on a circuit different from that to which the receiver is connected.
- Consult the dealer or an experienced radio/TV technician for help.

To assure continued compliance, any changes or modifications not expressly approved by the party responsible for compliance could void the user's authority to operate this equipment. (Example - use only shielded interface cables when connecting to computer or peripheral devices).

FCC Radiation Exposure Statement

This equipment complies with FCC RF radiation exposure limits set forth for an uncontrolled environment. This equipment should be installed and operated with a minimum distance of 20 centimeters between the radiator and your body.

This device complies with Part 15 of the FCC Rules. Operation is subject to the following two conditions:

- (1) This device may not cause harmful interference, and
- (2) This device must accept any interference received, including interference that may cause undesired operation.

This transmitter must not be co-located or operating in conjunction with any other antenna or transmitter.

CE Approval

CE Standards

This product complies with the 99/5/EEC directives, including the following safety and EMC standards:

- EN55022/24

CE Marking Warning

This is a Class B product. In a domestic environment this product may cause radio interference in which case the user may be required to take adequate measures.

CAUTION
RISK OF EXPLOSION IF BATTERY IS REPLACED
BY AN INCORRECT TYPE.
DISPOSE OF USED BATTERIES ACCORDING
TO THE INSTRUCTIONS