

SZ-DWS01

ZigBee Door Window Sensor



User Guide

Table of Contents

CHAPTER 1 INTRODUCTION.....	1
Package Contents	1
Specfication	1
CHAPTER 2 DEVICE DESCRIPTION	2
Installation.....	2
Operation	4
External contact wiring (Optional).....	5
CHAPTER 3 REGULATORY APPROVAL	7

Copyright 2012. All Rights Reserved.

Document Version: 1.0

All trademarks and trade names are the properties of their respective owners.

Chapter 1

Introduction

1

This Chapter provides an overview of the ZigBee Door/Window Sensor features and capabilities.

Congratulations on the purchase of your new ZigBee Door/Window Sensor. The ZigBee Door/Window Sensor is a consumer electronic device, which is used for home monitoring and security.

Package Contents

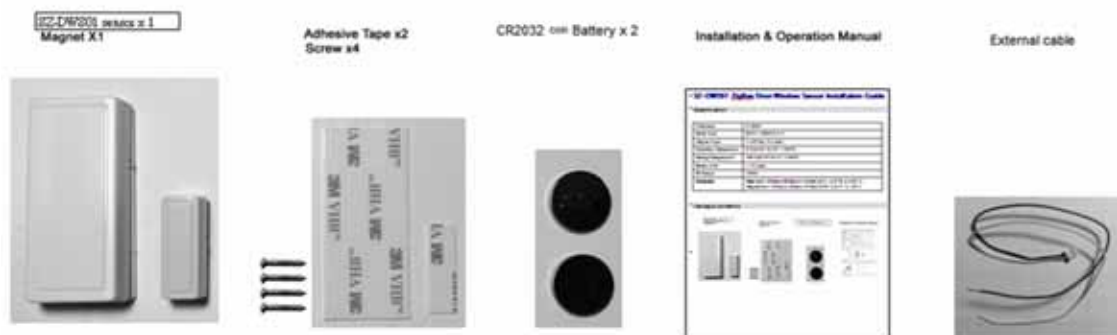

Specification

Frequency	2.4GHz
Batter Type	DC 3V, CR2032 x 2
Magnet Type	< 1.27 cm (0.5 inch)
Operating Temperature	0° C to 50° C (32° - 122°F)
Storage Temperature	-20° C to 70° C (-4° - 158°F)
Battery Life	1 ~ 2 years
RF Range	100M
Dimention	Main Unit: 13 mm x 20 mm x 115 mm (0.51" x 0.78" x 4.52") Magnet Unit: 10 mm x 12mm x 47 mm (0.39" x 0.47" x 1.85")

Chapter 2

Device Description

2

This Chapter provides device description for the ZigBee Door/Window Sensor.

Installation

NOTE: Please make sure that the sensor and magnet is located **less then 1.27cm (0.5 inch)** from each other.

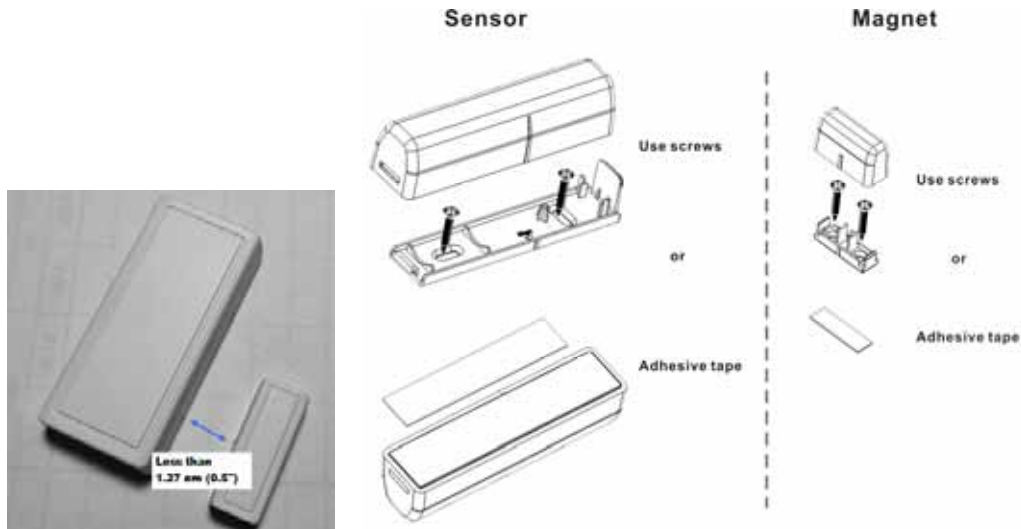

Intallation

1. Hold the sensor near the top of the door, close to the opening edge of the door. This is the mounting location for the sensor.
2. Using a flat head screw driver insert into the notch located on the case and gently twist to open.

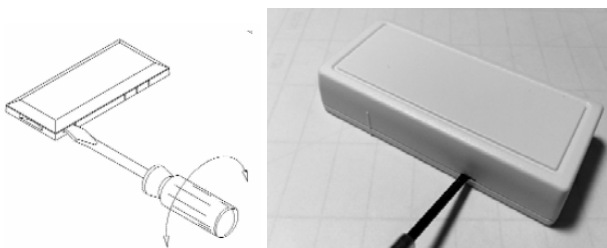

3. Insert CR2032 Battery

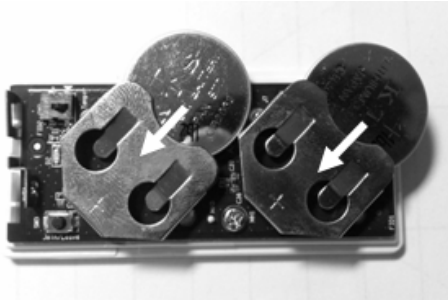

Use care when installing the battery and observe the correct polarity when the battery is inserted. Use only CR2032 batteries for replacement.

WARNING!: Battery may explode if mistreated. Do not recharge, disassemble or dispose of in fire.

4. Use either one of the following methods to install the sensor:

- Remove the back plate of the sensor; use this as the mounting bracket. Use the screwdriver to secure the back plate to the wall with the screws provided.
- Use provided adhesive on the sensor. Attach the sensor to the door. Press firmly and hold in place for a few seconds.

Magnet Setup

1. Attach the magnet on the location next to the sensor by using either one of the following methods:
 - Remove the back plate of the magnet; use this as the mounting bracket. Use the screwdriver to secure the back plate to the wall with the screws provided.
 - Use provided adhesive on the magnet. Attach the sensor to the door. Press firmly and hold in place for a few seconds.

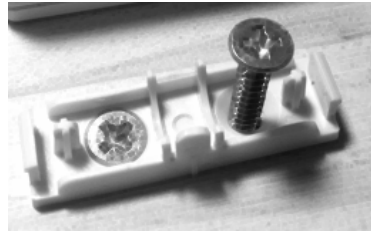

2. Make sure the alignment marks of both devices are facing each other.



Operation

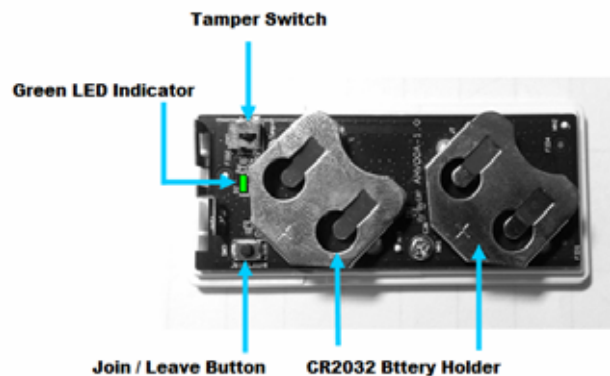

- **Join Function**

For "Join" a network, please do the following instruction:

- Press the Join/Leave button for less than 1 second. The LED is blinking while processing. If the sensor has been joined with the controller successfully, the Green LED will be on for 2 seconds and then off. The Green LED will be off instantly if failed.

- **Leave Function**

For "Leave" a network, please do the following instruction:

- Press Join/Leave button for 3 seconds to let the sensor disassociate from the controller.
- The LED will stay off during the normal operation.
- The sensor is equipped with a tamper switch. If the cover of sensor is removed, the sensor will send an alarm to the ZigBee controller. The sensor will be in "Awake" mode before replacing

External contact wiring (Optional)

1.remove screw

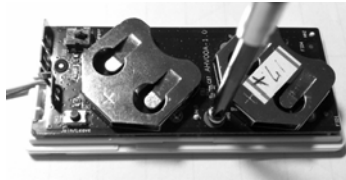

2.Plug two-pin connector.

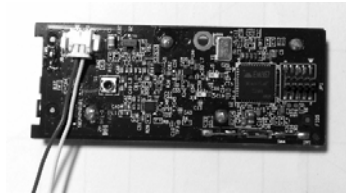

3.close screw

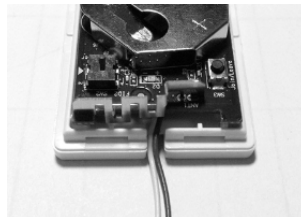
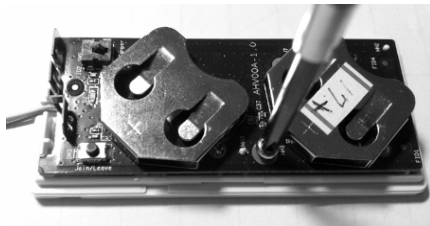

4. Connect wire to N/C dry reed switch device. (Option)

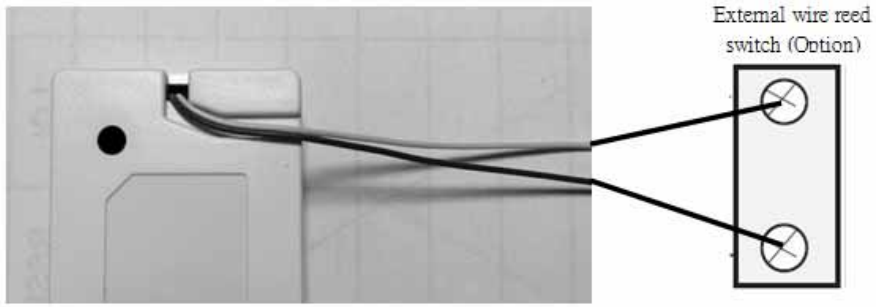

Use the following specifications for the external reed switch device.

- Maximum wire length:1 m

Chapter 3

REGULATORY APPROVAL



The FCC Statement

This equipment has been tested and found to comply with the limits for a Class B digital device, pursuant to part 15 of the FCC

rules. These limits are designed to provide reasonable protection against harmful interference in a residential installation. This

equipment generates, uses and can radiate radio frequency energy and, if not installed and used in accordance with the instructions, may cause harmful interference to radio communications. However, there is no guarantee that interference will not

occur in a particular installation. If this equipment does cause harmful interference to radio or television reception, which can be

determined by turning the equipment off and on, the user is encouraged to try to correct the interference by one or more of the

following measures:

-Reorient or relocate the receiving antenna.

-Increase the separation between the equipment and receiver.

FCC Radiation Exposure Statement

You are cautioned that changes or modifications not expressly approved by the party responsible for compliance could void your authority to operate the equipment.

This device complies with Part 15 of the FCC Rules. Operation is subject to the following two conditions: (1) this device may not cause harmful interference and (2) this device must accept any interference received, including interference that may cause undesired operation

This Transmitter must not be co-located or operating in conjunction with any other antenna or transmitter.

This equipment complies with FCC RF radiation exposure limits set forth for an uncontrolled environment . This equipment should be installed and operated with a minimum distance of 20 centimeters between the radiator and your body.

CE Approval

CE Standards

This product complies with the 99/5/EEC directives, including the following safety and EMC standards:

- EN30 0328-2
- EN30 1489-1/-17

CE Marking Warning

This is a Class B product. In a domestic environment this product may cause radio interference in which case the user may be required to take adequate measures.

UL Notices: This device complies with UL Standard UL634.