



# APPENDIX H

## : USER'S MANUAL



## **Digital Wireless Audio Solution**

**SH-320**

# **User's Guide**



**SEYOUNG INFORMATION & TELECOMMUNICATION CO., LTD**

## Cautions

**These are the right ways of handling the equipment for user's safety.**

- Avoid warm and humid places. Usage in those places can cause explosion, shape changes and malfunctions.
- Long-time use can be harmful for your ears.
- Designed for short-distance use (~30m in indoor circumstance) and to be used in 2.4GHz-usage allowed nations.
- Do not let battery charging port be in touch with electronic devices.
- Do not disassemble the equipment or give it physical damage.
- Use after enough charge.
- Do not pull necklace of the equipment and be aware of being stuck in subway, car doors.

## Index

### ☞ Introduction

1. What is WiWi? .....03
2. SH-320 .....03~04  
\*What is Speaking Function?
3. Applications .....04
4. Compositions .....05
5. Name and Function of each part .....06

### ☞ How to use

1. Power On/Off –Master mode .....07
2. Power On/Off – Slave mode .....08
3. Use speaking function – In Slave mode .....09
4. Disable speaking function – In Master mode .....10
5. Block/Unblock speaking function – In Master mode .....11
6. Change Channel .....12
7. LED Notification .....13
8. Beep Notification .....13
9. Battery Charging .....14
10. Summary .....15

### ☞ Others

1. Doubt for malfunction .....16
2. Specifications and Features .....17

## What is WiWi?

The new WiWi digital spread spectrum(DSS) wireless audio solution is the first portable 2-way simultaneous audio communication solution using 2.4GHz RF(Radio Frequency) Band. WiWi provides various, high-quality and robust audio communication services over safely secured wireless personal area network.

WiWi solution has two types of devices as its members, SH-320 transceiver and AUD-400 transceiver, both small, lightweight, and simple to set up and use. Depending on purpose of the service, either SH-320 transceiver or AUD-400 transceiver can be optional. Both devices can support 4 different RF channels.

## SH-320

SH-320 operates in 2 modes, Master mode and Slave mode. In Master mode, SH-320 transmits and receives audio data simultaneously, In Slave mode, SH-320 basically receives audio data and can transmit at the same time when it earns right to use speaking function(\*) by user's pressing its talk button.

## **\*Speaking Function**

Slave-mode SH-320 basically can only listen to Master-mode SH-320's words.

But As WiWi solution tries to offer innovative mobile communication, speaking function is added.

Speaking function makes users possible to speak through their Slave-mode SH-320, which means that 2-way conversation became available. Words of slave-mode SH-320 using speaking function are delivered to Master-mode SH-320 and other Slave-mode SH-320s in the channel. Speaking function is provided to only 1 slave-mode SH-320 in each channel at a time. Using speaking function is available when there is no one using speaking function in your channel.

Master-mode SH-320 can disable slave-mode SH-320's speaking function and can also block it to prevent all slave-mode SH-320s from using speaking function.

### **Applications**

- One or 2-way tour guide
- Conferences (2-way communication)
- Portable language interpretation system
- Personal audio receiver
- Small area audio broadcasting or multi-casting
- Wireless internet telephony system

## Composition



SH-320



Earset

※As type of earset is customer's option, actual product may differ from above image.



User's Guide



Quick Guide



Charging Cable

## Name and Function of each part



- ① Power Button : Power On/Off
- ② Channel LED : 4 different colors for 4 channels  
(CH1=>Blue, CH2=>Orange, CH3=>Red, CH4=>Green)

Distinguishing Master mode and Slave mode

(Master mode=>Still light, Slave mode=>Blinking light)

- ③ Volume Up Button : Volume up function
- ④ Volume Down Button: Volume down function
- ⑤ Multi-function Button: Asking for speaking right  
Disable speaking right  
Charging LED : Shows charging state  
(Charging=>Red, Fully Charged=>Green)
- ⑥ Mini USB Port : Charging/Debugging

☞ Channel changing function: Volume Up button + Multi-function button



## How to use

### Power On/Off – Master mode

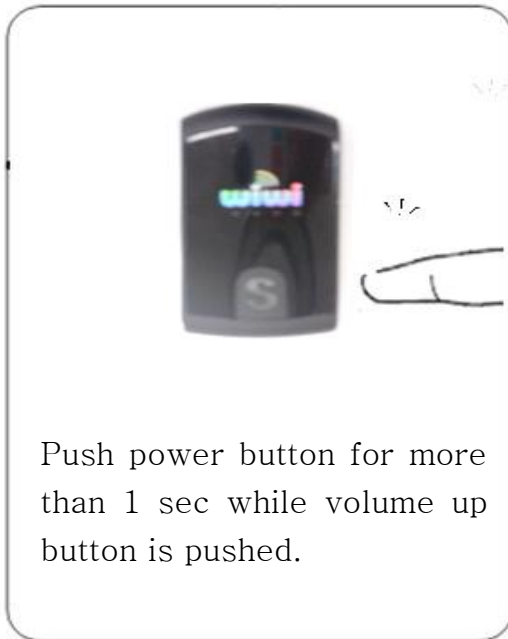

Push power button for more than 1 sec while volume up button is pushed.

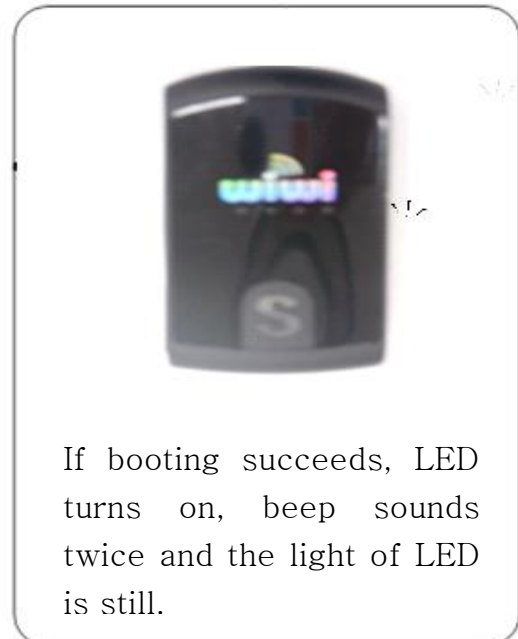

If booting succeeds, LED turns on, beep sounds twice and the light of LED is still.

- How to power on
- How to Power off

※ One of the SH-320s in a channel should be operated in Master mode to make communication in the channel possible. More than 1 Master-mode SH-320 in a channel can cause malfunctions. Build up network with 1 Master-



Push power button for more than 1 sec.

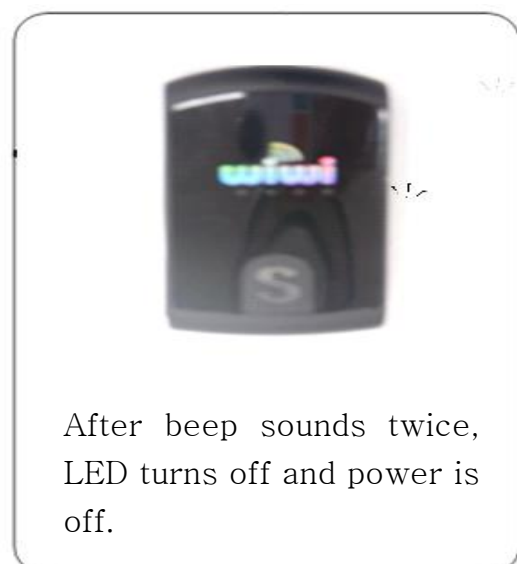

After beep sounds twice, LED turns off and power is off.

mode SH-320 and many Slave-mode SH-320s.

## Power On/Off – Slave mode

### - How to Power On

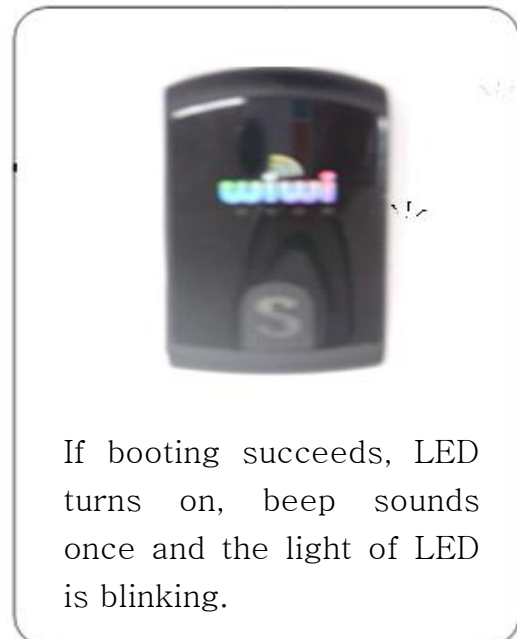
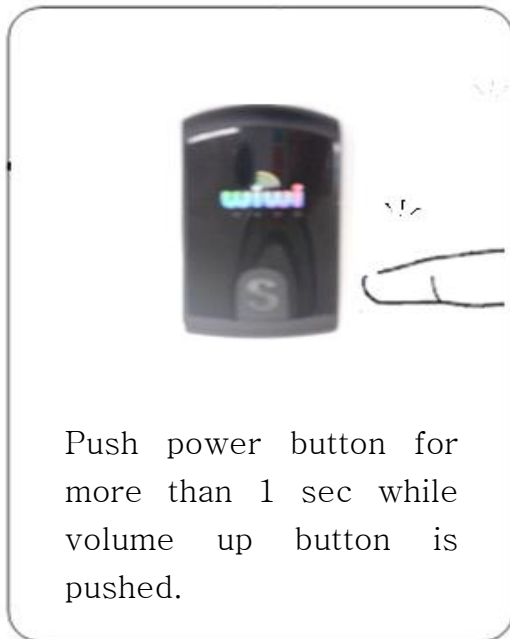

### - How to Power off



## Use speaking function – Slave mode

- How to use speaking function



- ※ Speaking function is provided to only 1 slave-mode SH-320 in each channel at a time. Using speaking function is available when there is no one using speaking function in your channel.

## Disable speaking function – In Master mode

- How to disable speaking function



- ※ Auto speaking function disabling function: If a Slave-mode SH-320 using speaking function is disconnected by being too far from the Master-mode SH-320, speaking function is automatically disabled.

## How to block/unblock speaking function

- Block speaking function



Push multi-function button for more than 1 sec in Master mode.

If block succeeds ,beep sounds twice.



- Unblock speaking function



Push multi-function button for more than 1 sec in Master mode.

If unblock succeeds, beep sounds once.



## Change channel

- How to change channel

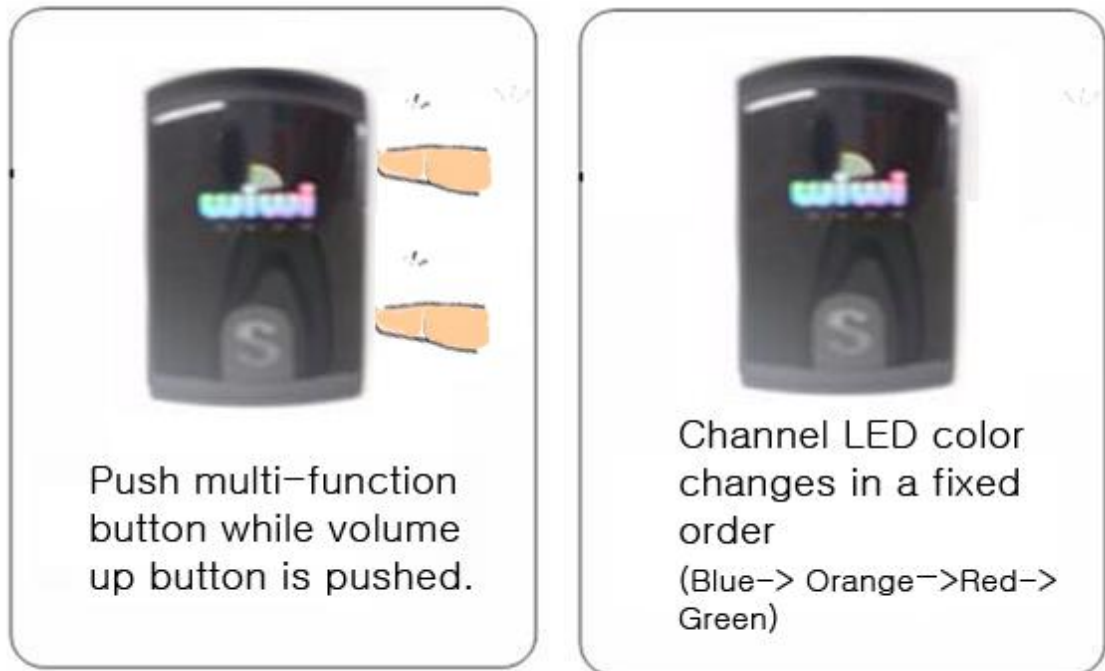

- ※ SH-320 supports 4 different channels.
- ※ Channel LED color shows each channel.  
CH1=>Blue, CH2=>Orange, CH3=>Red, CH4=>Green

👉 **Channel Memorizing function: Lastly used channel is memorized and selected automatically after reset.**

## LED notification

### - Charging LED

State	LED color
Charging	Red
Fully Charged	Green

### - Channel LED

Channel	LED
CH 1	Blue
CH 2	Orange
CH 3	Red
CH 4	Green

## Beep notification

Situation	Beep Sound
Power On	Master : "Ddoo Ddoo"
	Slave : "Ddoo"
Power Off	"Ddoo Ddoo"
Use Speaking function	"Ddoo"
Disable speaking function	"Ddoo Ddoo"
Block/Unblock speaking function	Block: "Ddoo Ddoo"
	Unblock : "Ddoo"

## Battery Charging

- Connect USB charging cable or DC adapter to SH-320's USB port and start charging.
- 2 hours of charging is required for full charge. If fully charged, the light of charging LED turn green.

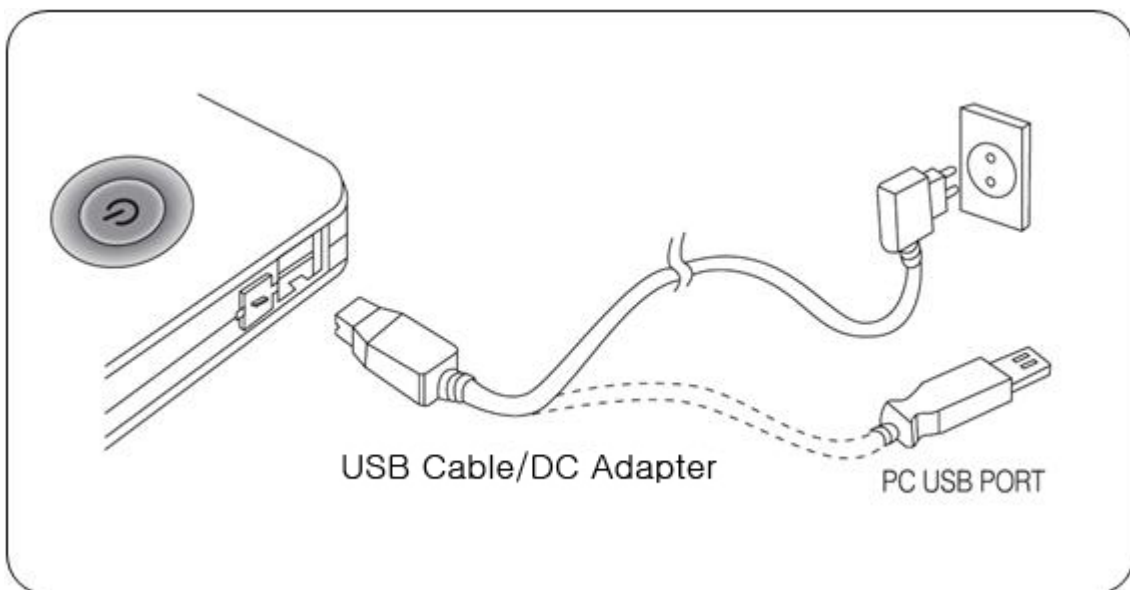



## Summary

- ※ Build up network with 1 Master-mode SH-320 and more than 1 Slave-mode SH-320 to make 1:N communication possible.
- ※ Push a multi-function button to use a speaking function(Slave mode), Push a multi-function button to disable a speaking function(Master mode). Only 1 Slave-mode SH-320 in a channel can use a speaking function at a time.

Power On	Master mode	Push power button while volume up button is pushed.
	Slave mode	Push power button for more than 1 sec.
Power Off	Master mode	Push power button for more than 1 sec.
	Slave mode	Push power button for more than 1 sec.
To use speaking function (In Slave mode)		Push multi-function button. If you're allowed to use speaking function, beep sounds once. (In Slave mode)
To disable speaking function (In Master mode)		Push multi-function button. If speaking function is disabled, beep sounds twice. (In Master mode)
Volume Up		Push volume up button.
Volume Down		Push volume down button.

## Doubt for malfunction

<b>Symptom</b>	<b>Measures</b>
Battery operation time differs from that of user's guide.	<ul style="list-style-type: none"> <li>• As battery is a consumable, its using time decreases gradually since it's firstly used. Storing it in low or high temperature can cause decrease of its operation time.</li> </ul>
Can not turn it on.	<ul style="list-style-type: none"> <li>• Check the battery.</li> <li>• If it doesn't turned on after charge, contact service center.</li> </ul>
Disconnection occurs while listening to music or on a conversation.	<ul style="list-style-type: none"> <li>• If battery runs out, this can happen.</li> <li>• If distance between headsets exceed available range or obstacles disturb connection, this can happen.</li> </ul>
Lot of noise occurs during conversation.	<ul style="list-style-type: none"> <li>• This equipment is designed for using in less than 30m. Exceeding this distance can cause noise.</li> </ul>
Can not use speaking function.	<ul style="list-style-type: none"> <li>• Check whether there is another SH-320 in Master mode around you.</li> </ul>

## Specifications and features

Frequency	2.402~2.483[GHz]
Service Coverage	30~100[m](L.O.S)
Maximum data rate	1[Mbps]
Operation time	Max 8[hour](in Master mode) Max 12[hour](in Slave mode)
Charging time	2[hour]
Battery type	Lithium-polymer
Power requirement	5V DC-800mA
Weight	39g
Dimension (W x H x D)	65 X 32 X 22mm

☞ Service coverage and operation time depend on the surrounding circumstances.

## **FCC**

This device complies with Part 15 of the FCC Rules. Operation is subject to the following two conditions: (1) this device may not cause harmful interference, and (2) this device must accept any interference received, including interference that may cause undesired operation.

Any change or modifications not expressly approved by the party responsible for compliance could void the authority to operate equipment

## **Caution**

This antenna(s) used for this transmitter must not be co-located or operating in conjunction with any other antenna or transmitter.

## **FCC Radiation exposure statement**

According to the KDB447498 (3)(b)(c), The output power is lower than 25 mW

for any simultaneous transmitting antenna for which stand-alone SAR evaluation is not required. This equipment complies with FCC radiation exposure.



**SEYOUNG INFORMATION &  
TELECOMMUNICATION CO., LTD**

Head Office : #298-2, Gongdan-dong, Gumi-city,

Gyeong-Buk, South Korea

TEL : +82-54-463-2300

FAX : +83-54-463-2106

Website : [www.eseyoung.com](http://www.eseyoung.com)