



USED FOR H823H,H823HW

SKY WALKER

HIGH PERFORMANCE QUADCOPTER
FLIGHT MANUAL



Battery Usage and Warnings:
For remote controller: 3 x 1.5V "AAA" batteries (not included in the package)
For Drone: Li-Po battery 3.7/240mAh with low-voltage and over current protection

- Do not leave a fully charged battery connected to charger; overcharging may shorten its lifetime.
- If not intend to use the battery for long period, it should be removed and kept in dry and low-temperature environment with full charge. If left unused, a fully charged battery will lose its charge over time. Though equipped with low-voltage protection we still suggest avoiding excessive discharge to a low voltage condition that may cause the failure to charge again.
- Do not leave the battery on charger over 24 hours, unplug the charger after using.
- Leaving the battery in hot places, such as a close car in summer will reduce the capacity and lifetime of the battery.
- Do not dispose of battery in a fire as they may explode, battery may also exploded if damaged.
- Do not disassemble or modify the battery for any purpose.
- Do not short-circuit the battery. Accidental short-circuiting can occur when a metallic object such as a coin, clip, or pen causes direct connection of the positive(+) and negative(-) terminals of the battery.
- Short-circuiting the terminals may damage the battery or the connecting object.
- Do not expose the battery to liquid or subject to strong mechanical shocks

How to treat Waste Electrical and Electronic Products

- Do not place the product as household waste.
- Follow the local regulations and laws for proper disposal of discarded electronic products.
- HELICUTE encourages you to participate in electronics recycling program.

Note:

- * Always dispose of old batteries responsibly

Instructions Before flying

Read through the manual before using
Keep the small parts of the accessories out of the reach of kids
Keep the drone 3 meters away from the other people when flying

-1-

Flying Precautions

- Keep small parts out of the reach of children, to avoid choking hazard.
- The DRONE is powerful, when taking off, move the throttle stick forward gradually, to avoid it's rising too fast.
- After flight, turn off the DRONE first, then turn off the controller.
- Do not put the battery in high temperature or near heat source
- Note, to avoid injury or damage, the DRONE should not be flown nearer than 2 meters / 7 feet from people or other obstacles.
- Children should fly the DRONE under adult supervision only. Always keep the DRONE in clear sight while flying.
- Always turn off the power of the controller and DRONE when not in use.

Notification

Equipped with low-voltage and over current protection, the Drone will land slowly when the battery is low and the power will be cut if any of the 4 blades is jammed.

Maintenance

- Keep the Drone clean and dry
- Don't fly the Drone into the water or in the rain
- Check the Drone before every flying and if any damage is found, don't fly the Drone until it is well repaired.

Controller Batteries Installation

Controller

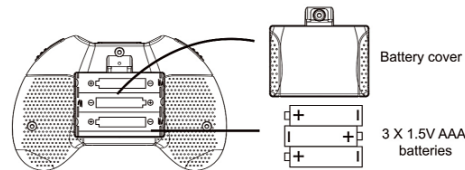

- Installing Batteries: unscrew and open the cover of the battery case, insert 3x1.5V AAA batteries according to the indication in the battery case.
- Battery installation should be done under adult supervision
- Don't install the old and new, or different types of batteries together

-2-

Charging

Insert the USB cable to the computer USB port and connect the charging end to the Drone's power port.

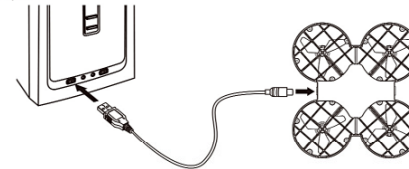

Controller

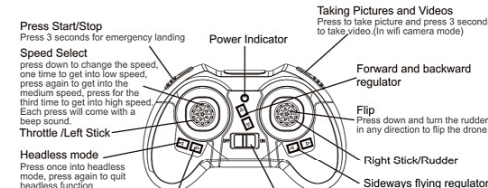

Drone

Replacing Damaged blades:
Your set will come with 4 replacement rotors, two (A) type and two (B) type. You will see the "A" and "B" word on the canopy, put the rotor on the motor accordingly.

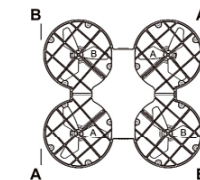

-3-

Operating steps

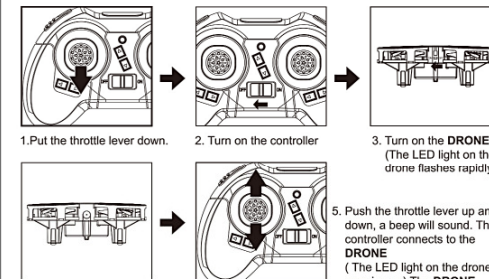

- Put the throttle lever down.
- Turn on the controller
- Turn on the DRONE (The LED light on the drone flashes rapidly)
- Place the DRONE at a level position.
- Push the throttle lever up and down, a beep will sound. The controller connects to the DRONE (The LED light on the drone remains on). The DRONE is ready to fly.

Operation and Control

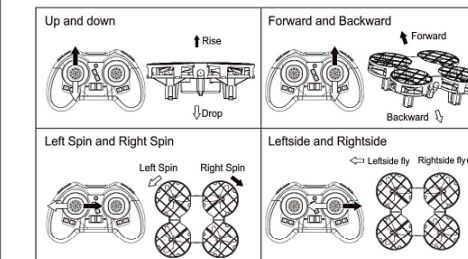

Note: When the drone is flying towards you, the control directions are reversed.

-4-

Regulating

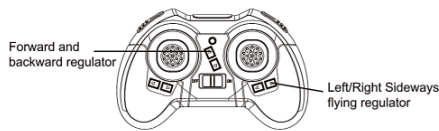

Backward Trim	Forward	←	→	Backward Trimmer
Forward Trim	Backward	←	→	Forward Trimmer
Leftside Trim	←	→	↔	LeftSide Trimmer
Rightside Trim	←	→	↔	RightSide Trimmer

WiFi CAMERA FCC ID:2AKPPLTH823
R/C DRONE FCC ID:2AKPPHELICUTE1

This device complies with Part 15 of the FCC Rules.

Operation is subject to the following two conditions:

- this device may not cause harmful interference, and
- this device must accept any interference received, including interference that may cause undesired operation.

-6-

Radical Flips & Rolls

You can perform flips with your DRONE in any of the speed settings.
Press down the rudder once(one beep sounds) then push the rudder in related direction.

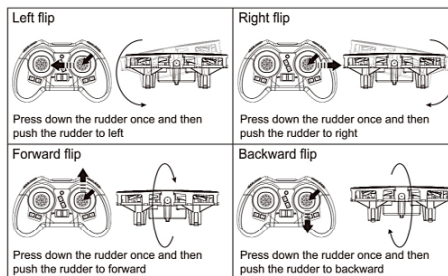

Before you perform a Flip Trick, always make sure you have enough space both above and below your DRONE.

Auto trim function

Press the throttle and rudder down to 45 degree circle (as below) for 10 second, you will see the light on the PC board of drone flashing rapidly, then pls let go the throttle and rudder, the light on the PC board remains on, the auto trim finishes.

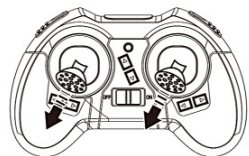

-6-

Headless function

HOW TO GET INTO/QUIT HEADLESS FUNCTION FLYING?

Press the button on controller(as picture shows) you will hear beep sounds then you get into compass mode flying.To quit from compass mode,just press it again and you will hear beep sound disappears.



HOW TO RECOGNIZE THE "FORWARD SIDE" UNDER HEADLESS FLIGHT?

When the drone is taking off, at the moment, the LED light on the drone stop flashing, at the moment, the drone sets its front side to be the front direction for headless mode flying.

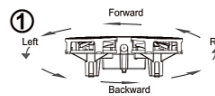

If you want to reset the front direction, then you need to turn off the rc drone and reset it again.

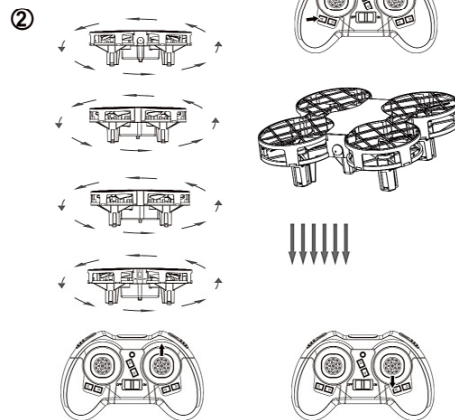

-7-

One key return function

When the drone is taking off, the LED light on the drone stop flashing, at the moment,the drone sets its front side to be the front direction for one key return flying. If you want to reset the front direction, then you need to turn off the rc drone and reset it again.



Instruction for wifi camera using

1.SOFTWARE DOWNLOAD AND INSTALLATION

APP (IOS) APK (Android/ Overseas) APK (Android/ Mainland China)



2.USING INSTRUCTION

- Connect the model to the power, the indicator on camera turns red.
- Enter the "setting" menu of your mobile device and turn on WIFI.
- Find a network WIFI called "HELICUTE FPV", click connection until "connected".
- Open the "HELICUTE FPV" software, click the "play" icon into the control interface. And you will see the real time video.



Spare parts list

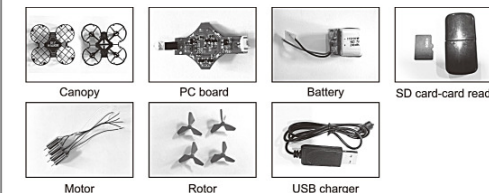

-8-