

Shark®

OWNER'S GUIDE

GI468N 10

GI468CN 10

GI468N 12

GI468CN 12



IMPORTANT SAFETY INSTRUCTIONS SAVE THESE INSTRUCTIONS

For Household Use Only

WHEN USING YOUR IRON, BASIC SAFETY PRECAUTIONS SHOULD ALWAYS BE FOLLOWED, INCLUDING THE FOLLOWING:

READ ALL INSTRUCTIONS BEFORE USING YOUR IRON.

POLARIZED PLUG:

This appliance has a polarized plug (one blade is wider than the other). As a safety feature, this plug will fit into a polarized outlet only one way. If the plug does not fit fully into the outlet, reverse the plug. If it still does not fit, contact a qualified electrician. **Do not attempt to defeat this safety feature.**

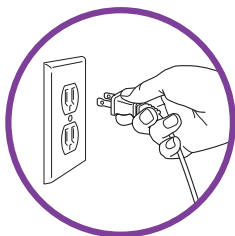

1. Use iron only for its intended use.
2. To protect against risk of electrical shock, do not immerse the iron in water or other liquids.
3. **DO NOT** yank cord to disconnect from outlet. Grasp plug and pull to disconnect.
4. **DO NOT** allow cord to touch hot surfaces. Let iron cool completely before putting away.
5. Always disconnect iron from electrical outlet when filling with water, emptying, or when not in use.
6. **DO NOT** operate iron with a damaged cord, or after the iron has been dropped or damaged in any manner. To avoid the risk of electric shock, do not disassemble the iron. Return the iron to the nearest service facility for examination and repair. Incorrect reassembly can cause the risk of electric shock when the iron is used.
7. Close supervision is necessary for any appliance being used by or near children. Do not leave iron unattended while connected or on an ironing board.
8. Burns can occur from touching hot metal parts, hot water or steam. Use caution when you turn a steam iron upside down; there may be hot water in the reservoir.
9. Never use or rest iron on an unstable surface.
10. While the iron is hot, never set iron on an unprotected surface -even if it is on its heel rest.
11. Always store your iron standing upright, not on the soleplate. If stored face down, even the smallest amount of moisture will cause the soleplate to corrode and stain.
12. This appliance is for household use only.



TOLL FREE: 1-800-798-7398

⚠ CAUTION! TO PREVENT ELECTRIC SHOCK OR OTHER INJURY, before filling the iron with water, make sure that the plug is removed from the outlet.

⚠ WARNING: Never fill the iron with fabric conditioner, starches or any other solution, as these will damage the steam mechanism. Do not use contaminated water.

⚠ CAUTION! TO AVOID FIRE, never leave iron unattended while it is plugged in.

⚠ CAUTION! TO PREVENT ELECTRIC SHOCK, never use the iron in a location where it can fall or be pulled into water or another liquid. If the iron falls into water or other liquid, unplug it immediately. **DO NOT** reach into the water or liquid.

⚠ WARNING: Never use scouring pads, abrasive or chemical cleaners, or solvents to clean the exterior or soleplate of your iron. Doing so will scratch and/or damage the surface.

⚠ CAUTION! DO NOT aim iron at face, towards yourself, or anyone else while using or adjusting steam. Burns or serious injury may occur.

SPECIAL INSTRUCTIONS

1. To avoid a circuit overload, do not operate another high-wattage appliance on the same circuit.
2. If an extension cord is absolutely necessary, use a 15-ampere cord. Cords rated for less amperage may overheat. Use care to arrange the cord so that it cannot be pulled or tripped over.

Quick Start

First things first, remove any labels, stickers or tags that may be attached to your Shark® Rapido™ Electronic Iron.

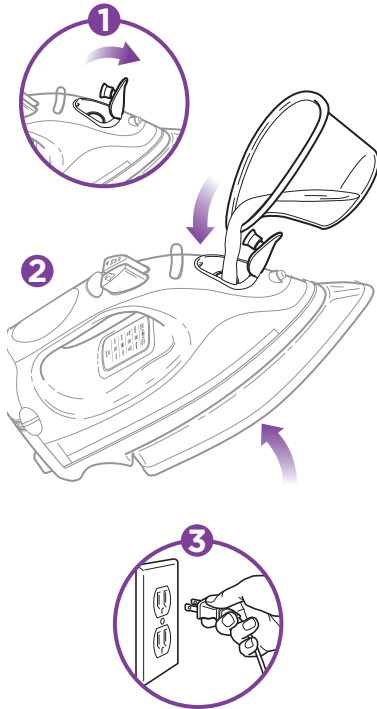

- 1 Open the water inlet cover located on the front of the iron.
- 2 Holding the iron at a slight angle; fill the tank with the filling flask without going over the "MAX" line. Close the water inlet cover.
- 3 Plug in the iron.
- 4 Choose dry or steam ironing based on the type of fabric you are going to iron.
For DRY ironing set the steam control dial to "0".

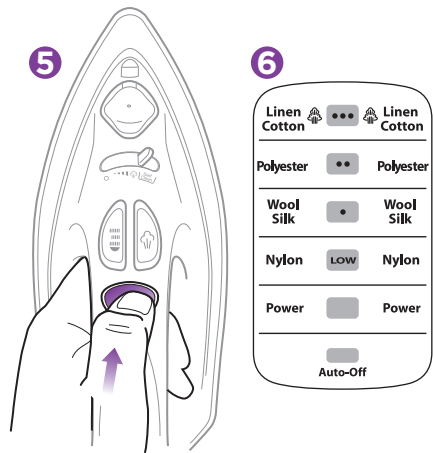

- 6 The temperature indicator light on the LED Display Panel will flash as the iron reaches the preset temperature.
- 7 Allow approximately 2 minutes for the iron to heat up or cool down to the new temperature setting. Start ironing!



TIPS

Read all garment care labels before you start ironing. You can also test the temperature of the iron on a hem or an inside seam.

Iron similar fabrics together and in sequence of synthetic fibers acrylic, nylon, silk/wool, polyester and cotton/linen. This will reduce the need to adjust the temperature frequently.

7

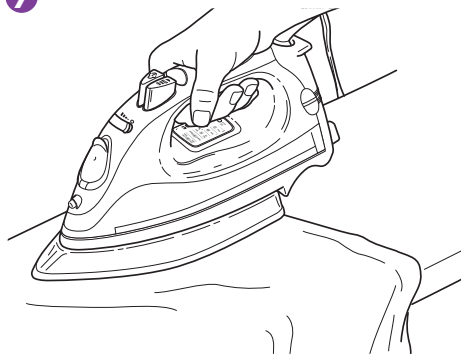

8

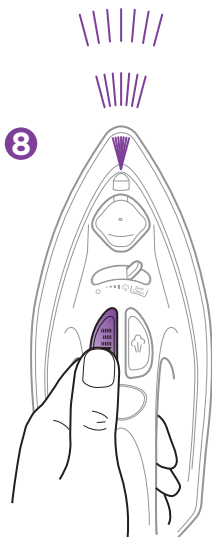
**ATOMIZER SPRAY**

- 8 Use the atomizer spray to get rid of tough wrinkles. Make sure there is enough water in the tank. Press the atomizer spray button to moisten the fabric.
- ▲ Before choosing to iron with steam for the first time, let the iron heat-up, hold in a horizontal position and hit the burst of steam button a couple of times.

- ▲ When you turn on the iron for the first time it might emit an odor for the first ten minutes. This is because the materials used in making the iron are heating up. The odor is safe and should not re-occur after the initial heating.
- ▲ To prevent fire, do not leave iron unattended while connected.

Thank you for
purchasing the
Shark® Rapido™
Electronic Iron

TECHNICAL SPECIFICATIONS

120 Volts, 60 Hz., 1500 Watts



Contents

GETTING STARTED	7
USING YOUR IRON	8
USING THE BURST OF STEAM	11
ELECTRONIC AUTO-OFF.....	12
EMPTYING THE IRON	12
SELF-CLEANING FEATURE	13
SELECTING THE PROPER TEMPERATURE FOR YOUR FABRIC	14
STORAGE	14
TROUBLESHOOTING	15
WARRANTY AND REGISTRATION.....	16

Getting Started

First things first, remove any labels, stickers or tags that may be attached to your Shark® Rapido™ Electronic Iron.

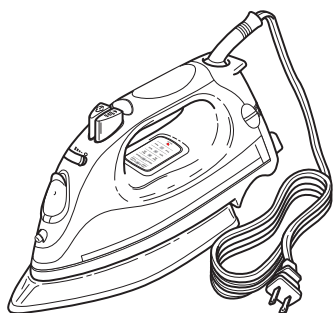

a



b

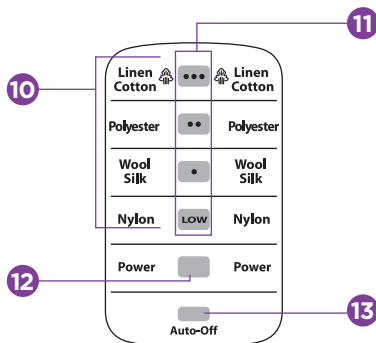
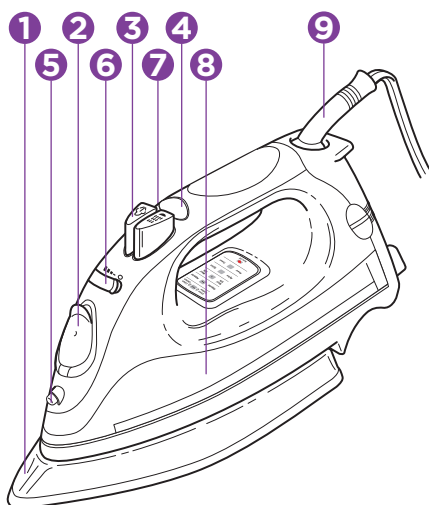

FIRST THINGS FIRST, YOU NEED TO KNOW WHAT'S IN THE BOX YOU JUST OPENED:

- a Shark® Rapido™ Electronic Iron
- b Filling flask

FEATURES:

- 1 Stainless Steel Soleplate**
Provides maximum glide-ability and heat retention.
- 2 Water Inlet Door**
Keep closed during use to prevent any water from spilling while ironing.
- 3 Steam Burst Button**
Removes stubborn wrinkles from denim, cotton or linen by surge of steam.
- 4 Electronic Temperature Control**
Select the fabric/temperature setting.

Using Your Iron

- 5 Spray Nozzle**
6 Variable Steam/Self-Clean Control Lever

Select "0" to maximum steaming for different fabrics.

The self-cleaning feature removes impurities and scale buildup inside the soleplate.

- 7 Atomizer Spray Button**
 Moistens fabric to remove stubborn wrinkles.
- 8 Water Level Window**
- 9 Pivot Cord**
 Provided for left or right-handed use. Pivots up and down to prevent dragging along the fabric. The flexible cord cover protects the cord from fraying.
- 10 Fabric Setting**
- 11 Temperature Indicators**
- 12 Power Light**
- 13 Auto-Off Light**
 The iron is inactive when the Auto-Off light is flashing
- 14 Anti-Drip Function** (not shown)
 Prevents water spitting when the iron temperature is too low.
- 15 Built-In Anti-Calcium Filter** (not shown)
 Prevents calcium build-up which prolongs the life of the iron.

This iron is for **HOUSEHOLD USE ONLY**. Plug it into any 120V AC polarized electrical outlet to start ironing!

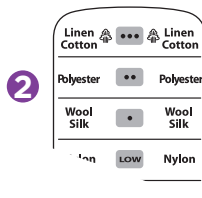

SETTING THE FABRIC AND TEMPERATURE INDICATORS:

- 1 Press the Electronic Temperature Control to select the desired fabric setting on the LED display panel. Please read the garment label for correct setting. Wait about 1 minute for the iron to heat up.
- 2 The temperature indicator will flash on the LED Display Panel until it reaches your desired temperature.

Using Your Iron

2

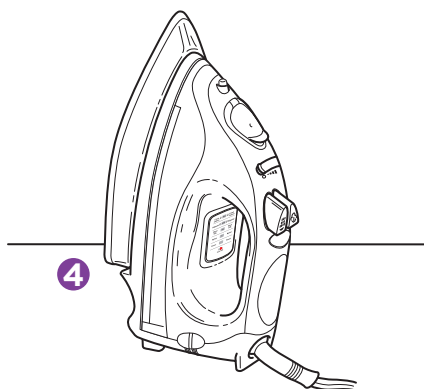
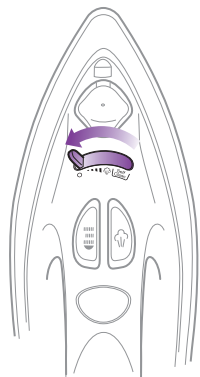

DRY IRONING

- 1 Choose any of the fabric settings on the LED Display Panel according to your garment label (as described on page 8).
- 2 Turn the Steam Control Dial to "0".
- 3 Place the iron on its heel, standing up and on a stable surface while it's heating up to the desired temperature.
- 4 Once the steam flow is cut off, you can start ironing.

TIPS

DRY ironing on a low temperature is best on acrylic, nylon, polyester, silk and wool.



2

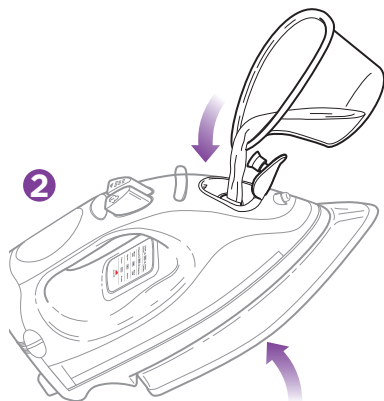

STEAM IRONING

- 1 Open the water filling inlet cover. Holding the iron at a slight angle, pour the water slowly into the inlet. The soleplate design allows for ordinary tap water to be used. We recommend using the mix of 50% tap water and 50% distilled water to reduce the hardness.
- 2 Using the filling flask, fill the tank to a desired level without going over the "MAX" line on the water tank.
- 3 When you're finished, close the inlet cover before continuing.
- 4 Plug the cord into a polarized 120V AC electrical outlet.

Using Your Iron

TIPS

STEAM ironing on a higher temperature is best on cotton and linen.

ANTI-DRIP FEATURE

Steam cannot be produced if the soleplate is not hot enough. It may result in water spitting or leaking from the soleplate. This iron is built with an anti-drip feature which reduces water dripping and leaking when ironing at low temperatures.

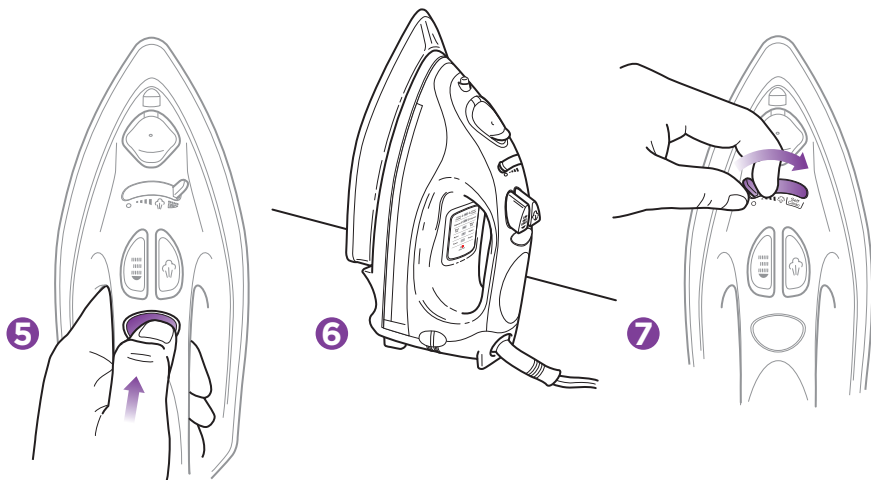

- 5 Set the desired fabric/temperature by pressing the electronic temperature control button (as described on page 8) after reading the garment label.
- 6 Place the iron on its heel, standing up on a stable, protected surface to allow the iron to heat up for approximately 2 minutes or until the temperature settings on the LED display panel are lit at the preset temperature.
- 7 Turn the steam control lever to the appropriate steam setting. (See “Ironing Guide” on page 15.)
- 8 In order to increase the amount of steam, turn the steam control lever to the right within the steam band. When you use extra steam, the iron uses

more water, so you may have to fill the tank more often.

- ⚠ Before filling the iron with water, always make sure the cord is not plugged into the electrical outlet.
- ⚠ Be very careful when filling the iron with water. Injuries may occur if you or your family comes in contact with the hot metal parts, hot water or steam.
- ⚠ Never fill the iron with fabric conditioner, starches or any other liquid because these will damage the steam mechanism. Don't use contaminated water either.
- ⚠ DO NOT aim iron at yourself or anyone else while adjusting steam. Be careful, burns or serious injury may occur.

Using the Burst of Steam Button

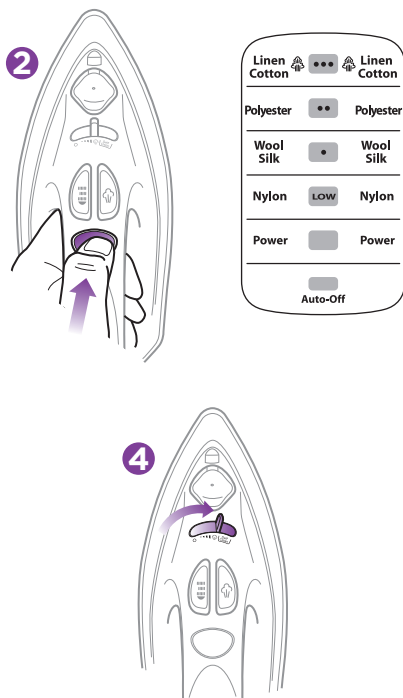

TIPS

Steam burst helps to remove stubborn wrinkles and can work both horizontally and vertically.

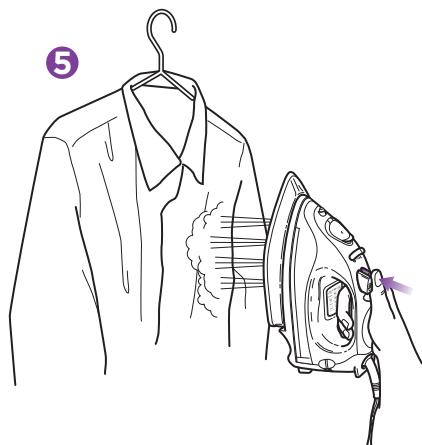

- 1 Make sure the water tank is at least 1/2 filled with water.
- 2 Select the desired fabric and temperature setting after reading the garment label.
- 3 Place the iron on its heel, standing up on a stable and protected surface so it can heat up for approximately 2 minutes.
- 4 Press the steam burst button while holding the iron horizontally or vertically. Give an interval of 3 seconds of each burst. Overuse of steam burst button may cause water spitting or weak steam performance.

VERTICAL STEAM

- 5 The steam burst feature is especially useful to remove wrinkles from hanging clothes, delicate garments and other fabrics. Hold the iron in a vertical position several inches away from the articles and press the steam burst button to prime the pump.
- ⚠ **CAUTION:** Do not aim iron at yourself or anyone else while using the steam burst feature. Be careful, burns or serious injury may occur.
 - ⚠ **CAUTION:** Never iron or steam clothes while they are being worn.
 - ⚠ If the tank runs dry, always make sure you unplug the iron from the outlet before you refill.

Electronic Auto-Off

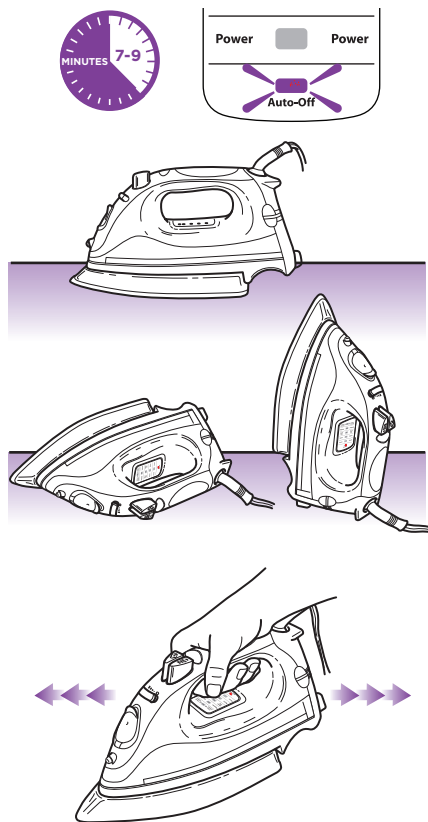

The Shark® Rapido™ Electronic Iron is equipped with an electronic auto-off feature. The electronic auto-off switches the iron off if it has been unmoved in any position (sideways, flat or upright) for approximately 7-9 minutes. The auto-off light will turn red on the LED display panel when the iron switches off. To turn the iron back on, just gently rock the iron back and forth several times until the “Power ON” light is re-illuminated. Press the Electronic Temperature Control to reset the temperature to the desired setting. The iron might have to warm up for a minute if the auto-off feature was activated for an extended time.

Emptying the Iron

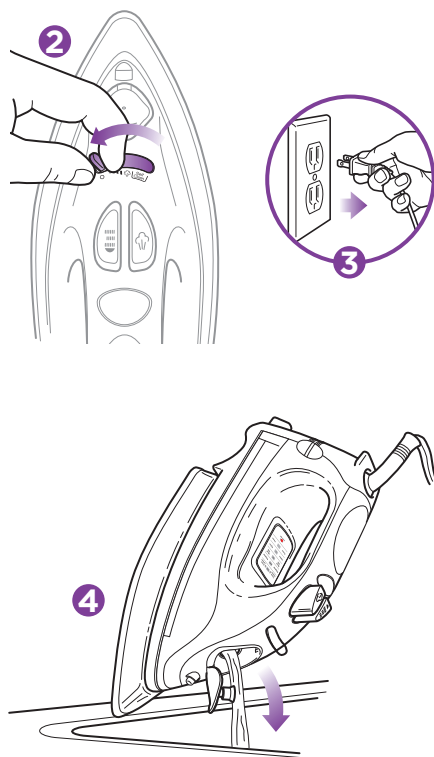

- 1 Always empty the water in the iron after each use.
- 2 When you have finished ironing, turn the variable steam control lever to “0” and press the electronic temperature control button until the power light is lit.
- 3 Unplug the iron from the electrical outlet.
- 4 Turn the iron upside down over the sink with the tip pointing downward and allow the water to flow from the opening. Be cautious when emptying, don't touch the hot surfaces, water or steam because injury may occur.
- 5 Place the iron upright and allow to cool before storing.

Self-Cleaning

We suggest that you self-clean the iron at least once every two weeks to remove scale and calcium. If you know you have very hard water we recommend that you self-clean the iron more often.

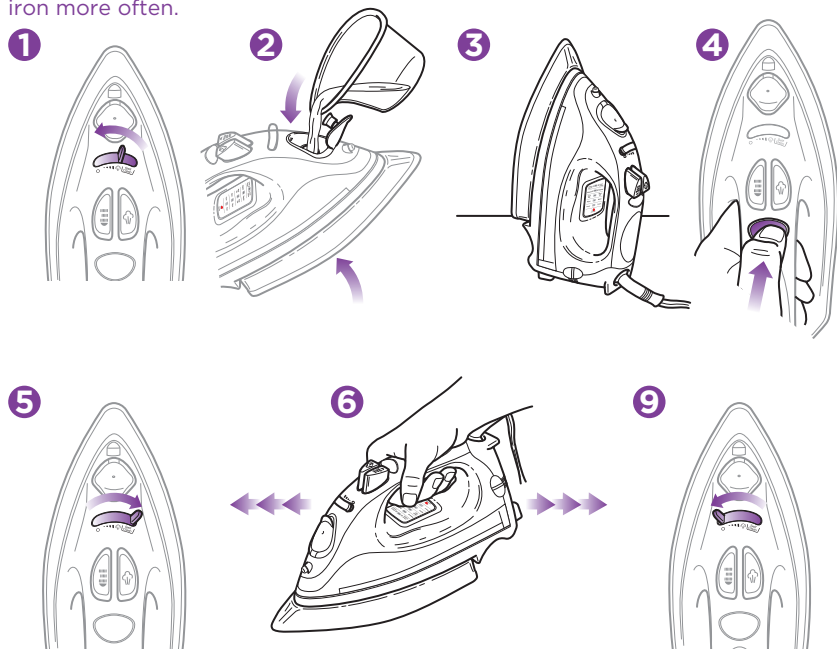

- 1 Set the steam control lever to any steam position.
- 2 Fill the water tank up to the “MAX” level. Do not overfill.
- 3 Stand the iron on its heel, standing up on a protected surface and plug into the electrical outlet.
- 4 Press the Electronic Temperature Control button to “•••” setting. Wait until the iron heats up and the Temperature Indicator lights up.
- 5 Hold the iron horizontally over the sink. Turn the steam control lever all the way to the right to the SELF CLEAN position.
- 6 Move the iron back and forth. Hot water and steam will now be ejected

- 7 Continue moving the iron back and forth until all the impurities are flushed.
- 8 Empty the water tank as described on Page 12. Don't touch the hot surfaces, water or steam because injury may occur.
- 9 Turn the Steam Control Lever to “0” position when the water tank is empty
- 10 Place the iron back upright on its heel to cool down before storing.

Selecting the Proper Temperatures

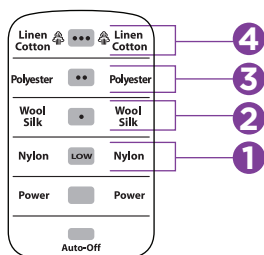





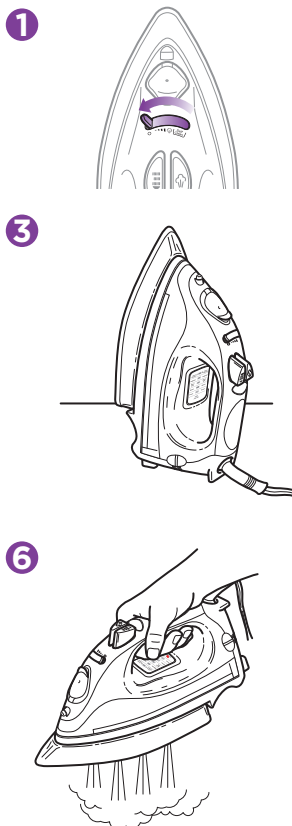





- 1 Use **LOW** settings for nylon and other synthetics.
 - 2 Use ● setting for wool, silks and blends.
 - 3 Use ●● setting for polyester.
 - 4 Use highest ●●●● settings for cottons and linens.
- ⚠ Always read garment labels and follow the manufacturer's ironing instructions.

Storage and Care

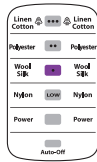
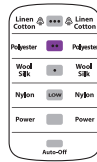
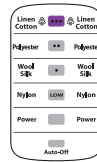
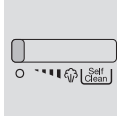

- 1 Always turn the variable steam control to "0" after you have emptied the water tank.
- 2 Allow the iron to cool down.
- 3 Always store the iron in the upright position to protect the soleplate.
- 4 Every two weeks, clean the exterior of the iron with a damp cloth and wipe dry.
- 5 If you use spray starch, wipe the soleplate with a soft, damp cloth after every use before unplugging. Please be careful if the iron is hot when cleaning the soleplate.
- 6 If the iron hasn't been used in a few weeks, hold the iron horizontally and allow steaming for 2 minutes before ironing.

Ironing Guide

<p>FABRIC TYPE</p> <p>LED DISPLAY PANEL</p> <p>STEAM CONTROL</p> <p>BURST OF STEAM</p> <p>SPRAY</p>					
	<p>Use this setting for synthetic fibers such as acrylic, or nylon</p>	<p>Use this setting for silk or wool</p>	<p>Use this setting for polyester</p>	<p>Use this setting for cotton or linen</p>	<p>Please note that the symbol above on the label of your garment means that THE ARTICLE CANNOT BE IRONED</p>
					
					
	<p>NO</p>	<p>NO</p>	<p>NO</p>	<p>YES</p>	
<p>YES</p>	<p>YES</p>	<p>YES</p>	<p>YES</p>		

PROBLEM	POSSIBLE REASONS & SOLUTIONS
<p>Iron doesn't heat.</p>	<p>Iron should be plugged into a 120V AC electric outlet only.</p> <p>Make sure the plug is securely in the socket.</p> <p>Temperature setting might be too low.</p> <p>Try turning to a higher setting.</p>
<p>An odor is being emitted from the new iron or small particles are coming out.</p>	<p>This is normal.</p> <p>Follow the instructions for first-time use and allow iron to steam through 2-3 fillings and press the steam burst button occasionally to eliminate small white particles.</p>
<p>Iron doesn't steam.</p>	<p>Water tank may be empty or water level is very low. Add water.</p> <p>Make sure the fabric/temperature setting and the variable steam control are correctly set. For maximum steam, set "MAX" on steam control and the temperature setting should be set on "•••."</p> <p>Steam control dial is set on "0."</p> <p>The soleplate is not hot enough and the anti-drip feature switches off the steam. Always allow the iron to reach the selected temperature with the variable steam control setting at "0." For more steam, turn temperature dial to a higher setting and the steam control to "MAX."</p> <p>If the temperature setting and steam control settings are correct and there is no steam, gently move the iron left or right a couple of times. Move the Steam Control Dial from "0" to "Max" a few times.</p>
<p>Water droplets coming from steam vents.</p>	<p>Variable Steam Control Dial may be set in "self clean" position. Align the dial to the "0" to "Max" steam setting.</p> <p>Iron may not be hot enough. Set temperature to "MAX" position. Always allow iron sufficient time to heat up before activating the variable steam control.</p> <p>Overuse the steam burst. Allow more time between each burst.</p>

Notes

ONE (1) YEAR LIMITED WARRANTY

EURO-PRO Operating LLC warrants this product to be free from defects in material and workmanship for a period of one (1) year from the date of the original purchase, when utilized for normal household use, subject to the following conditions, exclusions and exceptions.

If your appliance fails to operate properly while in use under normal household conditions within the warranty period, return the complete appliance and accessories, freight prepaid. For Customer Service support, call 1 (800) 798-7398 or visit our website www.sharkclean.com.

If the appliance is found to be defective in material or workmanship, **EURO-PRO Operating LLC** will repair or replace it free of charge. Proof of purchase date and a cheque in the amount of \$ 9.95 payable to **EURO-PRO Operating LLC** to cover the cost of return shipping and handling must be included.*

The liability of **EURO-PRO Operating LLC** is limited solely to the cost of the repair or replacement of the unit at our option. This warranty does not cover normal wear of parts and does not apply to any unit that has been tampered with or used for commercial purposes. This limited warranty does not cover damage caused by misuse, abuse, negligent handling or damage due to faulty packaging or mishandling in transit. This warranty does not cover damage or defects caused by or resulting from damages from shipping or repairs, service or alterations to the product or any of its parts, which have been performed by a repair person not authorized by **EURO-PRO Operating LLC**.

This warranty is extended to the original purchaser of the unit and excludes all other legal and/or conventional warranties. The responsibility of **EURO-PRO Operating LLC** if any, is limited to the specific obligations expressly assumed by it under the terms of the limited warranty. **In no event is EURO-PRO Operating LLC** liable for incidental or consequential damages of any nature whatsoever. Some states/provinces do not permit the exclusion or limitation of incidental or consequential damages, so the above may not apply to you.

This warranty gives you specific legal rights, and you may also have other rights which vary from state to state or province to province.

***Important: Carefully pack item to avoid damage in shipping. Be sure to include proof of purchase date and to attach tag to item before packing with your name, complete address and phone number with a note giving purchase information, model number and what you believe is the problem with item. We recommend you insure the package (as damage in shipping is not covered by your warranty). Mark the outside of your package "ATTENTION CUSTOMER SERVICE". We are constantly striving to improve our products, therefore the specifications contained herein are subject to change without notice.**

OWNERSHIP REGISTRATION CARD FOR CANADIAN CONSUMERS ONLY

Please complete and return within ten (10) days of purchase. The registration will enable us to contact you in the event a product defect is discovered. By returning this card you acknowledge to have read and understood the instructions for use, and warnings set forth in the accompanying instructions.

RETURN TO: **EURO-PRO Operating LLC**, 4400 Bois Franc, St. Laurent, Quebec H4S 1A7

PURCHASER:

ADDRESS:

DATE OF PURCHASE: MODEL: **GI468N 10 / GI468N 12 / GI468CN 10 / GI468CN 12**

NAME AND ADDRESS OF STORE:

U.S.: EURO-PRO Operating LLC
Boston, MA 02459

Canada: EURO-PRO Operating LLC
4400 Bois Franc
Ville St. Laurent, Québec H4S 1A7

1-800-798-7398

www.sharkclean.com

COPYRIGHT © EURO-PRO OPERATING LLC 2009

PRINTED IN CHINA

REV. 091130

Illustrations may differ with actual product.