

Shark[®]

OWNER'S GUIDE
LA400



IMPORTANT SAFETY INSTRUCTIONS

For Household Use Only

WHEN USING AN ELECTRICAL APPLIANCE, BASIC SAFETY PRECAUTIONS SHOULD ALWAYS BE OBSERVED, INCLUDING THE FOLLOWING:

READ ALL INSTRUCTIONS BEFORE USING YOUR SHARK® LIFT-AROUND™ CANISTER VAC.

POLARIZED PLUG:

To reduce the risk of electric shock, this appliance has a polarized plug (one blade is wider than the other). As a safety feature, this plug will fit into a polarized outlet only one way. If the plug does not fit fully into the outlet, reverse the plug. If it still does not fit, contact a qualified electrician.

DO NOT force into outlet or try to modify to fit.

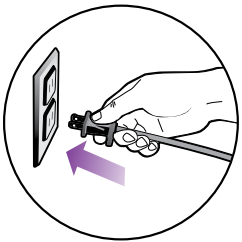

⚠ WARNING: To reduce the risk of electric shock or injury, do not use outdoors or on wet surfaces.

WARNING:
TO REDUCE THE RISK OF FIRE, ELECTRIC SHOCK OR INJURY:

GENERAL ELECTRICAL SAFETY:

1. Unplug from electrical outlet when not in use and before servicing.
2. **DO NOT** use the vacuum with a damaged cord or plug. This appliance has no serviceable parts. If appliance is not working as it should, has been dropped, damaged, left outdoors, or dropped into water, return it to EURO-PRO Operating LLC for examination, repair, or adjustment.
3. **DO NOT** pull or carry the vacuum by the cord.
4. **DO NOT** unplug by pulling on the cord; to unplug, grasp the plug, not the cord.
5. **DO NOT** handle the plug or the appliance with wet hands.
6. **DO NOT** run the vacuum over the power cord.
7. **DO NOT** use the cord as a handle.
8. **DO NOT** close a door on the cord.
9. **DO NOT** pull the cord around sharp corners. The use of an extension cord is not recommended.
10. **DO NOT** leave the appliance plugged in when not in use.
11. Keep the cord away from heated surfaces.
12. Turn off all controls before plugging or unplugging the vacuum cleaner.
13. Always turn off this appliance before attaching or removing accessories.

GENERAL USE:

1. Use only as described in this manual.
2. **DO NOT** put any objects into openings. **DO NOT** use with any opening blocked; keep free of dust, lint, hair, and anything that may reduce air flow.
3. Keep your work area well lit.
4. **DO NOT** place the vacuum on unstable surfaces such as chairs or tables.
5. **DO NOT** allow young children to operate the vacuum or use as a toy. Close attention is necessary when used by or near children.
6. **DO NOT** use vacuum cleaner if it has been dropped, damaged, left outdoors, or submerged in water. Return to EURO-PRO Operating LLC for examination, repair, or adjustment.
7. **DO NOT** use without dust cup and/or filters in place.

HOSE ATTACHMENTS:

1. **DO NOT** use if air flow is restricted; if the air paths, the hose, or the accessories become blocked, turn the vacuum cleaner off. Remove all obstructions before you turn on the unit again.
2. Keep the end of the hose and accessory openings away from face and body.
3. Keep cleaning tools and hose suction openings away from hair, face, fingers, uncovered feet, or loose clothing.
4. Only use manufacturer's recommended attachments.

GENERAL CLEANING:

1. **DO NOT** pick up large-sized objects.
2. **DO NOT** pick up hard or sharp objects such as glass, nails, screws or coins that could damage the vacuum cleaner.
3. **DO NOT** pick up smoking or burning objects such as hot coals, cigarette butts, matches or hot ash.
4. **DO NOT** pick up flammable or combustible materials such as lighter fluid, gasoline, or kerosene or use vacuum in areas where they may be present.
5. **DO NOT** pick up toxic solutions such as chlorine bleach, ammonia, or drain cleaner.
6. **DO NOT** use in an enclosed space where vapors are present from paint, paint thinner, moth-proofing substances, flammable dust or other explosive or toxic materials.
7. **DO NOT** vacuum up any liquids.
8. **DO NOT** immerse the vacuum cleaner in water or other liquids.
9. **DO NOT** use outdoors or on wet surfaces; use only on dry surfaces.
10. Use extra care when cleaning on stairs.

DUST CUP/FILTERS/ACCESSORIES:

Before turning on the vacuum:

1. Make sure that all filters are thoroughly dry after routine cleaning.
2. Make sure that the dust cup and all filters are in place after routine maintenance.
3. Make sure accessories are free of blockages.
4. Only use filters and accessories provided by EURO-PRO Operating LLC. [Failure to do so will void the warranty.]

SAVE THESE INSTRUCTIONS

Thank you for
purchasing the
Shark®
Lift-Around™
Canister Vac.

Getting Started.....	6
How to Use	8
Maintenance	10
Checking for Blockages.....	12
Storing	13
Resetting the Motor Thermostat	13
Ordering Replacement Parts	13
Troubleshooting Guide.....	14
Warranty & Registration.....	15

This manual covers model numbers:

LA400 40

TECHNICAL SPECIFICATIONS

Voltage: 120V., 60Hz

Watts: 550 W

Amps: 4.6 A



Getting Started

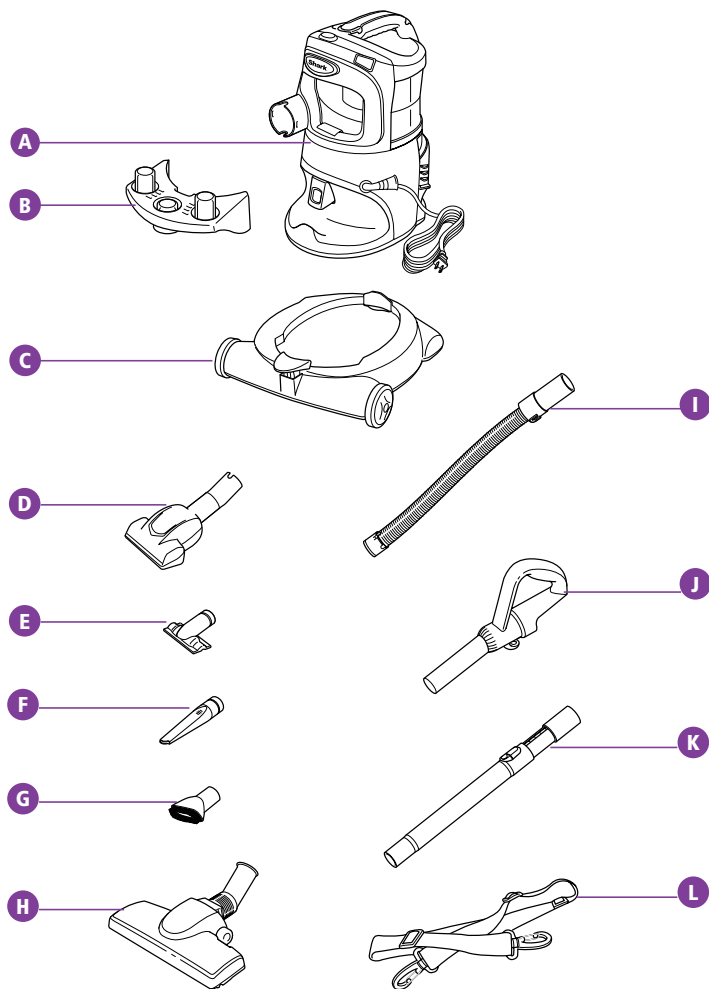

FIRST THING'S FIRST, YOU NEED TO KNOW WHAT'S IN THE BOX YOU JUST OPENED:

- A** *Lift-Around™* Canister Vac
- B** Removable Tool Caddy
- C** Canister Caddy
- D** Power Brush
- E** Upholstery Brush
- F** Crevice Tool
- G** Dusting Brush
- H** Bare floor Nozzle

Use the *Shark® Lift-Around™* Canister Vac as a stand alone vacuum for spot-cleaning small areas and large piles of debris, or with the Flexible Hose and cleaning tools for above-floor cleaning.

- I** Flexible Hose
- J** Floor Kit Handle
- K** Telescopic Tube
- L** Shoulder Strap

! NOTE: Always turn the power off before attaching or detaching accessories.

REMOVABLE TOOL CADDY (B)

Specially designed to hold the crevice tool, dusting brush and upholstery brush for quick access to tools when vacuuming and cleaning around the house.

CANISTER CADDY (C)

Specially designed to hold the *Shark® Lift-Around™* and convert it to a canister vacuum.

POWER BRUSH (D)

This small accessory has an air driven brushroll for cleaning upholstery, pet hair and even auto interiors.

UPHOLSTERY BRUSH (E)

This unique tool was engineered for fast and easy removal of pet hair from upholstery.

CREVICE TOOL (F)

Reach deep into narrow spaces and clean between cushions, under radiators and baseboards and in hard to reach crevices and corners.

DUSTING BRUSH (G)

Dust shelves, lamp shades, window blinds, books, furniture and other household items.

BARE FLOOR NOZZLE (H)

Powerful cleaning on bare floors.

FLEXIBLE HOSE (I)

With the right cleaning tool in place and the Flexible Hose, you can extend your reach into hard-to-clean areas.

! NOTE: Use the Flexible Hose without any accessories attached for large debris cleaning.

FLOOR KIT HANDLE (J)

Designed for easy manoeuvrability and effortless swivel.

TELESCOPIC TUBE (K)

Extend and adjust your reach farther into hard-to-clean areas.

SHOULDER STRAP (L)

Specialized design to make carrying the Canister Vac with ease. The removable Shoulder Strap is ergonomic and easily distributes weight across the shoulder.

How to Use

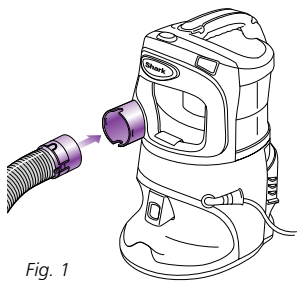

Fig. 1

Align arrows to attach tool caddy

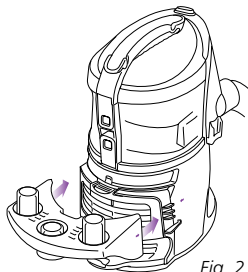

Fig. 2

Pull out to remove tool caddy

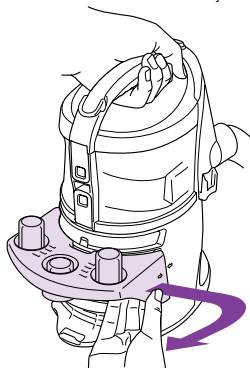

Fig. 3

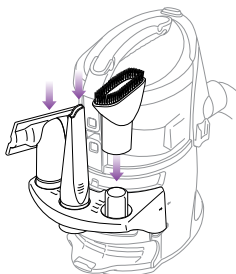

Fig. 4

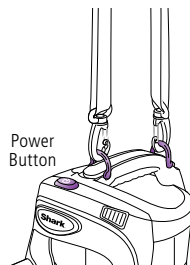

Fig. 5

Power Button

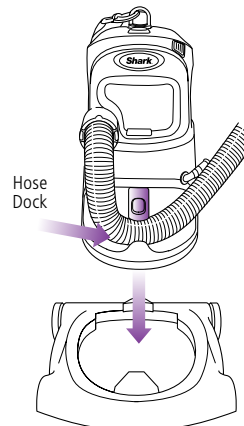

Fig. 6

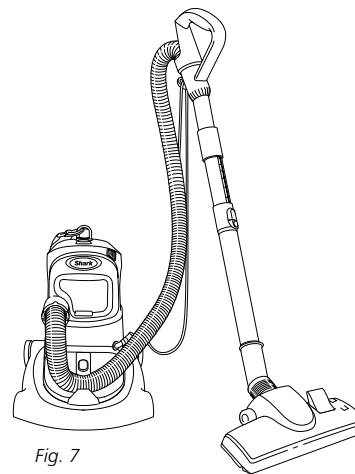

Fig. 7

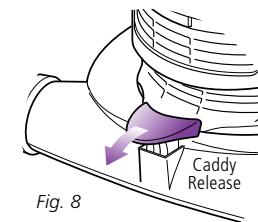

Fig. 8

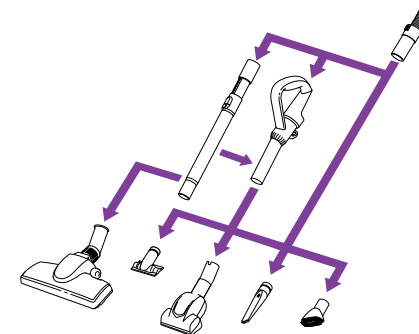

Fig. 9

ASSEMBLING THE LIFT-AROUND™ CANISTER VAC

- 1 Insert the end of the flexible hose into the connector on the front of the **Lift-Around™** Canister Vac. (**fig. 1**)
- 2 Insert the removable tool caddy onto the back of the Canister Vac. (**fig. 2**) To remove the tool caddy, hold the vacuum by the handle, pull out slightly from the right side and then remove it from the Canister Vac. (**fig. 3**)
- 3 Insert the crevice tool, dusting brush, upholstery brush or power brush into the openings on the tool caddy. (**fig. 4**)

- 4 Attach the shoulder strap onto the hooks on the handle of the Canister Vac. (**fig. 5**)
- 5 Empty Dust Cup after cleaning and periodically during cleaning when it appears full. (See "Maintenance" section for instructions.)

USE IN CANISTER MODE

- 6 Place the hose in the hose dock. (**fig. 6**)
- 7 Place the unit over the caddy and press down until it locks into place. (**fig. 6, fig. 7**)
- 8 To release the vacuum from the caddy, press caddy release button and lift the vacuum up. (**fig. 8**)

FOR ADDED COMFORT OR FOR AN EXTENDED REACH

- 9 Attach the floor kit handle to the flexible hose. Push it in until it is secure. (**fig. 9**)
 - 10 Insert the telescopic tube into the end of the floor kit handle. Push it in until it is secure. (**fig. 9**)
- NOTE:** All accessories may be used with the flexible hose, the floor kit handle or the telescopic tube.
- 11 Attach the desired accessory to the end of the flexible hose, floor kit handle or telescopic tube by pushing it in until it is tightly secured. (**fig. 9**)
 - 12 While holding the Canister Vac by the handle, press down on the power button to turn the Canister Vac on and begin vacuuming. Press down again to turn the vacuum off. (**fig. 5**)

Maintenance

⚠ To reduce the risk of electric shock, unplug the unit before performing any cleaning, maintenance, or troubleshooting checks.

⚠ Reassemble all parts securely before operating vacuum.

For best results empty the Dust Cup after each use; empty several times during prolonged usage or when it reaches the **MAX** fill line.

NEVER OVER-FILL THE DUST CUP.

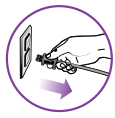
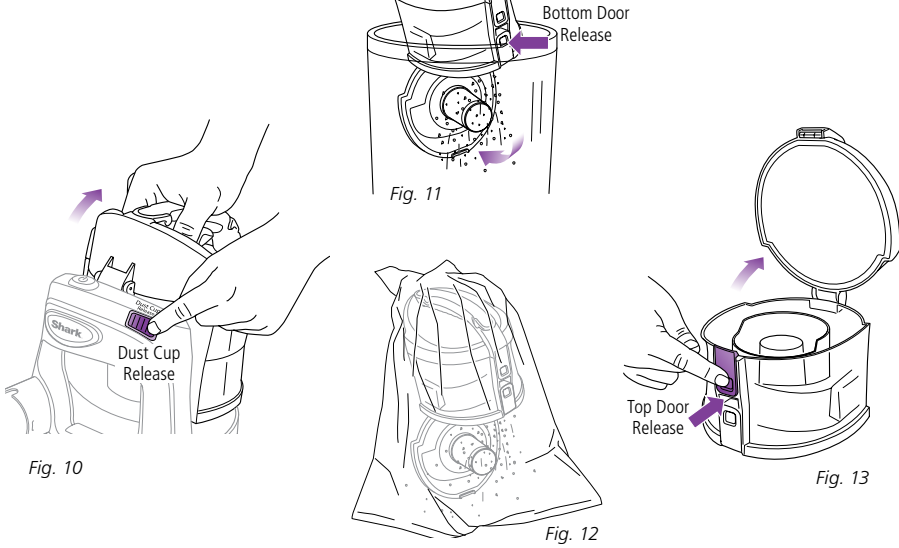

CAUTION:
Unplug the vacuum; failure to do so might result in electric shock.

EMPTYING THE DUST CUP

⚠ The Dust Cup needs to be emptied each time you vacuum and periodically during cleaning, when the Dust Cup appears full.

- 1 Press the dust cup release button and remove the dust cup from the vacuum. (fig. 10)
- 2 **Option A:** for Quick Empty: Insert the Dust Cup deep inside a trash receptacle to contain the dust and debris. Press the bottom door release button to release the trap door. Tap gently to empty contents. (fig. 11) Press the door shut again until it clicks.

- 3 **Option B:** For Allergy Sufferers: Wrap a trash bag around the Dust Cup leaving space at the bottom for the door to swing open. Locate the bottom door release button within the trash bag and press to release as you shake the dust cup to empty dust and debris. (fig. 12) Press the door shut again until it clicks.

Note: Option B can also be performed outside of the home to further minimize releasing dust back into the air. Carry just the dust cup and trash bag outside.
- 4 Check to make sure the trap door is secure before returning it to the Vacuum.
- 5 To clean the upper compartment of the dust cup, press the top door release button to open. (fig. 13) Empty the contents over a trash receptacle and push the door shut until it clicks into place.

COMPONENT	MAINTENANCE SCHEDULE
1 Dust Cup	Empty each time you vacuum.
2 Pre-Motor Foam Filter	Rinse and air dry every month under normal use.
3 Pre-Motor Felt Filter	Rinse and air dry every month under normal use.
4 Post-Motor HEPA Filter	Clean once every 24 months under normal use.

- ⚠ DO NOT** operate the vacuum without ALL the filters in place.
- ⚠ DO NOT** operate the vacuum with WET filters.
- ⚠ DO NOT** put the filters in the washing machine or dishwasher.

NOTE: The material in the filters will discolor over time. This is NORMAL and will not affect the performance of the filters.

⚠ IMPORTANT: Loss of Suction may occur if foam filter is not cleaned every month. Rinse and allow to air dry completely. Tap loose dirt from foam filter as needed in between washing. Foam filter may appear dirty after use - this is normal.

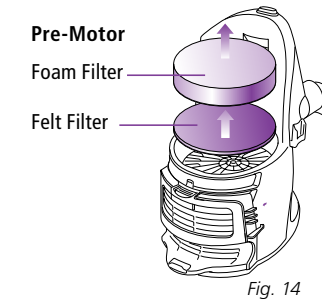

CLEANING THE PRE-MOTOR FILTERS

- 1 Remove the dust cup.
- 2 Remove the pre-motor filters out from the top of the motor base. (fig. 14)
- 3 Rinse the filters thoroughly in lukewarm water until the water runs clear.
- 4 Squeeze out excess water and let air-dry for at least 24 hours before replacing. Do not use a hair dryer or other heating methods to dry.
- 5 Place the felt filter in first, then the foam filter.
- 6 Replace the dust cup.

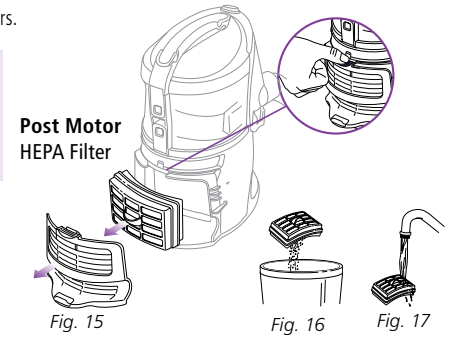

CLEANING THE POST-MOTOR HEPA FILTER

- 1 Remove the tool caddy from the unit.
- 2 Remove the filter cover from the vacuum by pulling up on the tab and pulling the cover away from the vacuum. (fig. 15)
- 3 Take out the HEPA filter by pulling it straight out.
- 4 Turn the filter over so that the dirty side is on the bottom and vigorously tap it clean against a garbage can to remove any dust. (fig. 16)
- 5 Wash the filter under the tap using lukewarm water with the dirty side face down until the water runs clear. (fig. 17)
- 6 Allow the filter to air dry for 24 hours. Do not use a hair dryer or other heating methods to dry.
- 7 Once the HEPA filter is dry, replace it back into the vacuum.
- 8 Replace the cover by inserting the two tabs into the holes at the top and then swinging the cover down until it clicks into place.

Checking for Blockages

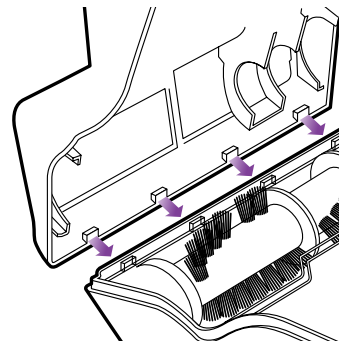
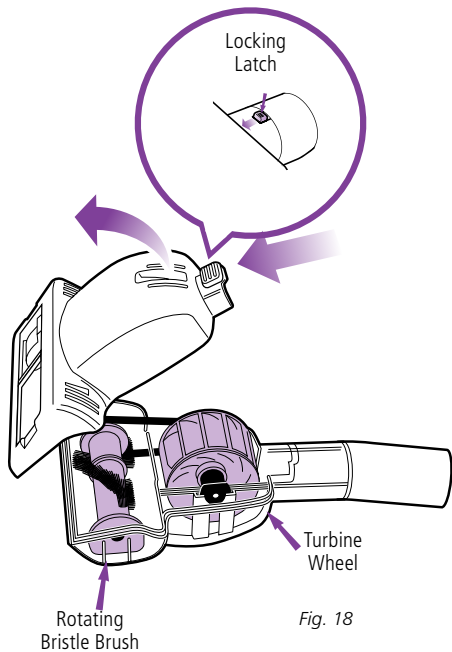

Blockages may cause your vacuum to overheat and shut down. To prevent this from happening, check potential blockage areas after heavy use or if you detect a loss of suction or poor cleaning performance.

1 DUST CUP

Dust Cup may be full. Empty Dust Cup.

2 FILTERS (PRE-MOTOR AND POST MOTOR)

Ensure that both the Pre Motor Filters and the Post Motor HEPA filter are clean.

3 ACCESSORIES

Check intake openings:

- Power Brush
- Crevice Tool
- Upholstery Brush
- Dusting Brush
- Flexible Hose
- Floor Kit Handle
- Bare floor Nozzle

CLEANING THE POWER BRUSH

- Turn the Power Brush over, slide the locking latch forward and tilt the cover upward to remove. (fig. 18)
- Inspect the rotating bristle brush, turbine wheel and air passage.
- Remove any blockage or debris and carefully, without damaging the bristles or belt, cut any build-up of hair or string wrapped around the rotating bristle brush with scissors.
- To reassemble, first insert the tabs on the front edge of the cover into the matching holes in the top half of the Power Brush and tilt the cover back down pressing until it clicks into place. (fig. 19)

Storing

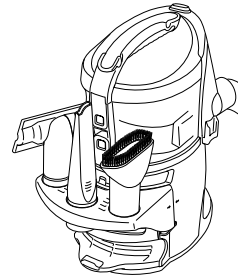

Fig. 20

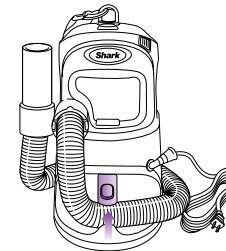

Fig. 21

STORE YOUR VACUUM SAFELY

- 1 Store the dusting brush, upholstery brush, the crevice tool or the power brush on the mounts on the removable tool caddy. (fig. 20)
- 2 Wrap the flexible hose around the base of the vacuum and hook the end of the flexible hose into the hose dock. (fig. 21) To release the hose, press the Hose Storage button.
- 3 Wrap the attached cord strap around the power cord when storing.
- 4 Store your vacuum cleaner with the rest of the accessories safely in a cool dry area where they will not be a hazard, will not get damaged and will not cause damage to anyone or anything.

NOTE: Empty dust cup after cleaning and prior to storing. (See "Maintenance" section for instructions.)

Resetting the Motor Thermostat

Your **Shark® Lift-Around™** Canister Vac is equipped with a protective Motor Thermostat. If the motor should overheat, the thermostat shuts off the power.

To reset the Motor Thermostat:

Press the Power Button to turn the vacuum off.

Unplug the vacuum.

Check for clogged hose or filter; unclog hose and replace filter. Refer to **Checking for Blockages**.

Wait 45 minutes for vacuum to cool; then plug in the vacuum.

Press the Power Button to restart the vacuum.

Note: If vacuum still does not start, contact Customer Service at: 1-800-798-7398.

Ordering Replacement Parts

To order additional parts and accessories, go to www.sharkclean.com or call 1-800-798-7398.

PART	PART NO.
Pre-Motor Filters	XFF318
HEPA Filter	XHF318
Telescopic Tube	1057FT
Upholstery Brush	1061FT
Crevice Tool	1062FT
Dusting Brush	1063FT
Power Brush	1064FT
Floor Kit Handle	XKH320
Canister Caddy	XCAD320
Bare floor Nozzle	XSN320

PROBLEM	POSSIBLE REASONS & SOLUTIONS
Vacuum is not picking up dirt.	<p>Check Filters to see if they need cleaning. Follow instructions for rinsing and drying the Filters before re-inserting back into the Vacuum. (See "Maintenance" sections for instructions.)</p> <p>Dust Cup may be full; empty Dust Cup.</p> <p>Check Hose, Hose connections and accessories for blockages; clear blockages if required.</p> <p>If Dust Cup is empty, and attachment inlets are clear, check for other blockages. (See "Checking for Blockages" for instructions.)</p>
Airflow is restricted. No suction or light suction.	<p>Check Filters to see if they need cleaning. Follow instructions for rinsing and drying the Filters before re-inserting back into the Vacuum. (See "Maintenance" sections for instructions.)</p> <p>Dust Cup may be full; empty Dust Cup.</p> <p>Check Hose and Hose connections for suction strength; clear blockages if required.</p> <p>If Dust Cup is empty, and attachment inlets are clear, check for other blockages. (See "Checking for Blockages" for instructions.)</p>
Vacuum turns off on its own.	<p>This vacuum cleaner is equipped with a motor protective thermostat. If for some reason your vacuum overheats, the thermostat will automatically turn the unit off. Should this occur, perform the following steps to restart the motor thermostat:</p> <ol style="list-style-type: none"> 1. Press down on the Power Button to turn the Canister Vac off. 2. Unplug the vacuum. 3. Empty the Dust Cup and clean Filters. (See "Maintenance" sections for instructions.) 4. Check for blockages in hose, accessories and inlet opening. (See "Checking for Blockages" for instructions.) 5. Allow the unit to cool for a minimum of 45 minutes. 6. Plug in the vacuum. 7. Press the Power Button again to restart the vacuum. <p>Note: If vacuum still does not start, contact Customer Service at: 1-800-798-7398.</p>

NOTE: This appliance has no serviceable parts. Please contact Customer Service at 1-800-798-7398.

Euro-Pro Three-Year (3) Limited Warranty

EURO-PRO Operating LLC warrants this product to be free from defects in material and workmanship for a period of three (3) years from the date of the original purchase, when utilized for normal household use, subject to the following conditions, exclusions and exceptions.

If your appliance fails to operate properly while in use under normal household conditions within the warranty period, return the complete appliance and accessories, freight prepaid to:

- **U.S.: EURO-PRO Operating LLC**
For customer service support call 1-800-798-7398
or visit www.sharkclean.com
- **Canada: EURO-PRO Operating LLC**
4400 Bois Franc, St. Laurent, Québec H4S 1A7

If the appliance is found to be defective in material or workmanship, **EURO-PRO Operating LLC** will repair or replace it free of charge. Proof of purchase date and \$19.95 to cover the cost of return shipping and handling must be included.*

Non-durable parts including, without limitation, filters, brushes and electrical parts which normally require replacement are specifically excluded from warranty.

The liability of **EURO-PRO Operating LLC** is limited solely to the cost of the repair or replacement of the unit at our option. This warranty does not cover normal wear of parts and does not apply to any unit that has been tampered with or used for commercial purposes. This limited warranty does not cover damage caused by misuse, abuse, negligent handling or damage due to faulty packaging or mishandling in transit. This warranty does not cover damage or defects caused by or resulting from damages from shipping or repairs, service or alterations to the product or any of its parts, which have been performed by a repair person not authorized by **EURO-PRO Operating LLC**.

This warranty is extended to the original purchaser of the unit and excludes all other legal and/or conventional warranties. The responsibility of **EURO-PRO Operating LLC** if any, is limited to the specific obligations expressly assumed by it under the terms of the limited warranty. In no event is **EURO-PRO Operating LLC** liable for incidental or consequential damages of any nature whatsoever. Some states do not permit the exclusion or limitation of incidental or consequential damages, so the above may not apply to you.

This warranty gives you specific legal rights, and you may also have other rights which vary from state to state or province to province.

***IMPORTANT: Carefully pack item to avoid damage in shipping. Be sure to include proof of purchase date and to attach tag to item before packing with your name, complete address and phone number with a note giving purchase information, model number and what you believe is the problem with item. We recommend you insure the package (as damage in shipping is not covered by your warranty). Mark the outside of your package "ATTENTION CUSTOMER SERVICE". We are constantly striving to improve our products, therefore the specifications contained herein are subject to change without notice.**

Product Registration

Please visit www.sharkclean.com or call **1-800-798-7398** to register your new **Shark®** product within ten (10) days of purchase. You will be asked to provide the store name, date of purchase and model number along with your name and address.

The registration will enable us to contact you in the unlikely event of a product safety notification. By registering you acknowledge to have read and understood the instructions for use, and warnings set forth in the accompanying instructions.

Euro-Pro Operating LLC
USA: Newton, MA 02459
CAN: 4400 Bois Franc, St-Laurent, QC H4S 1A7

English: 1-800-798-7398

www.sharkclean.com

COPYRIGHT © EURO-PRO OPERATING LLC 2012

PRINTED IN CHINA

Illustrations may differ from actual product.

LA400.E.120821.2