

Shark

WWW.SHARKSONICDUO.COM

SONIC DUO™ PRO
Carpet & Hard Floor Cleaner

SP1000

OWNER'S GUIDE



IMPORTANT SAFETY INSTRUCTIONS

For Household Use Only

WHEN USING YOUR SHARK® SONIC DUO™ PRO, BASIC SAFETY PRECAUTIONS SHOULD ALWAYS BE FOLLOWED, INCLUDING THE FOLLOWING:

READ ALL INSTRUCTIONS BEFORE USING YOUR SHARK® SONIC DUO™ PRO CARPET & HARD FLOOR CLEANER.

POLARIZED PLUG:

This appliance has a polarized plug (one blade is wider than the other). As a safety feature, this plug will fit into a polarized outlet only one way. If the plug does not fit fully into the outlet, reverse the plug. If it still does not fit, contact a qualified electrician. **Do not attempt to defeat this safety feature.**

⚠ CAUTION:

Keep all **Shark®** branded cleaners and polishes out of the reach of children.

Eye irritant. Should some of the **Shark®** branded cleaners and polishes be rubbed or splashed into the eyes, wash out thoroughly with water. If irritation continues, contact a physician.

In case of ingestion, drink 16 FL. oz. (2 cups) of water.

WARNING:

TO REDUCE THE RISK OF FIRE, ELECTRIC SHOCK OR INJURY:

1. Use the system only for its intended use.
2. **DO NOT** use outdoors.
3. **DO NOT** leave the appliance unattended when plugged in. Always turn the appliance off (O) and unplug the power cord from the electrical outlet when not in use and before servicing.
4. Turn off all controls before unplugging.
5. **DO NOT** allow to be used as a toy. Close attention is necessary when used by or near children, pets or plants.
6. Use only as described in this manual.
7. Use only manufacturer's recommended accessories.
8. **DO NOT** use with damaged cord or plug. If the appliance is not working as it should, has been dropped, damaged, left outdoors, or dropped into water, return the appliance to EURO-PRO Operating LLC for examination and repair. Incorrect re-assembly or repair can cause a risk of electrical shock or injury to persons when the appliance is used.
9. To protect against a risk of electric shock, **DO NOT** immerse the appliance into water or any other liquids.
10. **DO NOT** handle the plug or the appliance with wet hands or operate the appliance without shoes.
11. **DO NOT** pull or carry by cord, use the power cord as a handle, close a door on the cord, or pull the cord around sharp edges or corners. Do not run the appliance over the power cord. Keep the power cord away from heated surfaces.
12. **DO NOT** unplug by pulling on the power cord. To unplug, grasp the plug not the power cord. Do not use extension cords or outlets with inadequate current carrying capacity.
13. **DO NOT** use for space heating purposes.



TOLL FREE: 1-800-798-7398

14. **DO NOT** put any objects into openings. Do not use with any opening that is blocked.
15. **DO NOT** put hands or feet under the **Sonic Duo™ Pro**.
16. Keep hair, loose clothing, fingers, and all parts of the body away from openings and moving parts.
17. Use **ONLY** on flat, horizontal surfaces. Do not use on walls, counters or windows.
18. To reduce the risk of fire and electric shock - use **ONLY Shark®'s** cleaning, polishing and carpet cleaning solutions intended for use with this appliance.
19. **DO NOT** add any cleaning solutions in the **Shark® Sonic Duo™ Pro** other than **Shark®'s** Low Moisture - No Rinse - Carpet Cleaner and Hard Floor Cleaner. The Hard Floor Polish should never be run through the **Sonic Duo™ Pro**. It will cause clogging. Use of other scented perfumes, oils or any other chemicals added to the solution or to the Reusable Bottle used in this appliance may damage or clog the unit and void the warranty. If you live in a hard water area, we recommend using distilled water to dilute the Low Moisture - No Rinse - Carpet Cleaner and Hard Floor Cleaner for better performance.
20. **DO NOT** mix other cleaners with **Shark®'s** Low Moisture - No Rinse - Carpet Cleaner and Wood & Hard Floor Cleaner as this could affect the effectiveness of the appliance.
21. **DO NOT** use the **Sonic Duo™ Pro** to clean up or absorb flammable or combustible materials.
22. **NEVER LEAVE THE SONIC DUO™ Pro IN ONE SPOT ON ANY SURFACE FOR ANY PERIOD OF TIME WHEN THE CLEANING OR POLISHING PAD IS ATTACHED OR WITH THE APPLIANCE TURNED ON AS THIS WILL DAMAGE YOUR FLOORS.**
23. When cleaning the **Sonic Duo™ Pro**, unplug the power cord from the electrical outlet, and clean with a dry or damp cloth. Do not pour water or use alcohol, benzene or paint thinner on the unit.
24. Unplug the appliance before attaching or removing the pads.
25. Extreme caution should be exercised when using this appliance to clean stairs.
26. Never use the **Sonic Duo™ Pro** without the carpet pad, cleaning pad or polishing pad attached.
27. Keep your work area well lit.
28. Store the **Sonic Duo™ Pro** indoors in a cool, dry place.
29. To avoid circuit overload, do not operate another appliance on the same socket (circuit) as the **Sonic Duo™ Pro**.
30. If an extension cord is absolutely necessary, an extension cord rated a minimum of 15 ampere, 14 gauge cord should be used. Cords rated for less amperage may overheat. Care should be taken to arrange cord so that it cannot be pulled or tripped over.
31. This appliance is provided with double insulation. Use only identical replacement parts. See instructions for servicing of double-insulated appliances.



WARNING: Your **Sonic Duo™ Pro** is designed to clean hard floor and carpet surfaces. Do not use on wood or tile floors that are highly worn, unfinished or have a wax or oil finish. Surfaces that have been treated with wax or some no wax floors may be damaged by the cleaning and polishing solutions therefore it is always recommended to test an isolated area of the surface to be cleaned before proceeding. You should always check the use and care instructions from the floor manufacturer. Always check with the carpet manufacturer or distributor before using the **Shark®** Activating Pretreater Carpet Stain & Odor Remover or the Low Moisture -No Rinse - Carpet Cleaner. To determine the colorfastness of any carpet -especially with reds or blues - take a clean, moist towel and gently rub a small area in an inconspicuous area. If color comes off the towel, you may need to have the carpets cleaned professionally.

SAVE THESE INSTRUCTIONS

Servicing of double-insulated appliances:

A double-insulated appliance is marked with one or more of the following: The words "double-insulation" or "double-insulated" or the double insulation symbol (square within a square).



In a double-insulated appliance, two systems of insulation are provided instead of grounding. No grounding means is provided on a double-insulated appliance, nor should a means for grounding be added to the appliance. Servicing a double-insulated appliance requires extreme care and knowledge of the system, and should be done only by qualified service personnel. Replacement parts for a double-insulated appliance must be identical to the parts they replace.

This manual covers model numbers:
SP1000 26

TECHNICAL SPECIFICATIONS

Voltage: 120V~, 60Hz.

Power: 96 Watts

Reusable Bottle Capacity: 32 oz.

Euro-Pro, Shark, Sonic Duo Pro, ScrubDuster, and Rotator are trademarks of Euro-Pro Operating LLC. All other brand names may be trademarks of their respective owners.



TOLL FREE: 1-800-798-7398

Contents

Thank you for purchasing the **Shark® Sonic Duo™ Pro** Carpet & Hard Floor Cleaner.

Getting Started.....	2
Using Your Sonic Duo™ Pro Carpet & Hard Floor Cleaner	4
Cleaning Your Carpets.....	4
Regular Cleaning.....	4
High Traffic Area Cleaning.....	5
Spot & Stain Cleaning.....	7
Cleaning Your Hard Floors.....	8
Polishing Your Hard Floors	10
Care and Maintenance.....	13
Ordering Replacement Parts.....	14
Troubleshooting Guide.....	15
Warranty	19

Getting Started

When assembling your **Sonic Duo™ Pro** there may be a little water in the Reusable Bottle. This is because we test all of our products 100% before you buy them, so you get a quality **Shark® Sonic Duo™ Pro** Carpet & Hard Floor Cleaner.

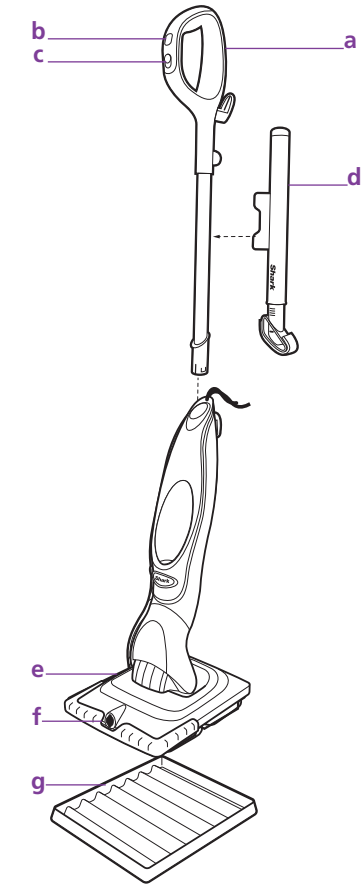

- a Handle
- b Spray Button
- c On/Off/Mode Button
- d ScrubDuster™
- e Sonic Duo™ Pro Scrub Head
- f Spray Nozzle
- g Storage Tray

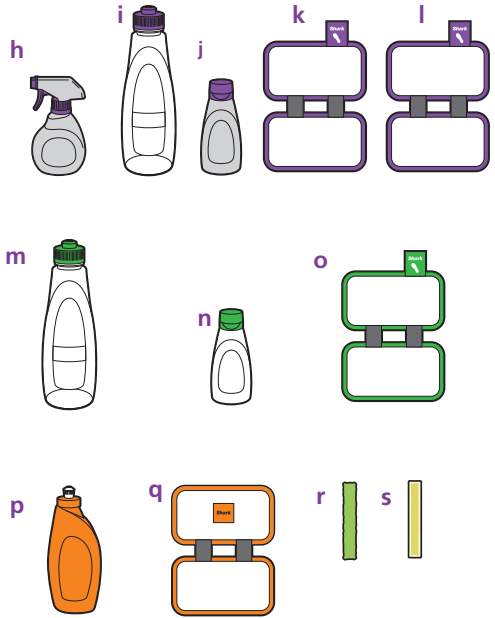

- h Activating Pretreater Carpet Stain & Odor Remover
- i Reusable Bottle for Carpet Cleaning Solution
- j Low Moisture - No Rinse - Carpet Cleaner
- k Carpet / Rug Cleaning Pad (x2)
- l Carpet Scrub 'n Stain™ Pad
- m Reusable Bottle for Hard Floor Cleaning Solution
- n Hard Floor Cleaner
- o Hard Floor Cleaning Pad (x3)
- p Hard Floor Polish
- q Hard Floor Polishing Pad (x2)
- r ScrubDuster™ Scrubbing Pad
- s ScrubDuster™ Dusting Pad

⚠ NOTE: Additional accessories such as cleaning pads and cleaning solutions are available for purchase at www.sharksonicduo.com or by calling 1-800-798-7398.

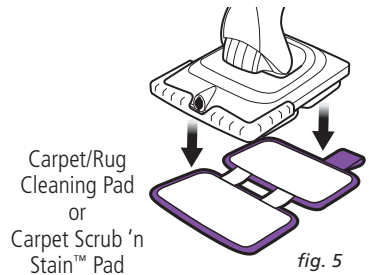
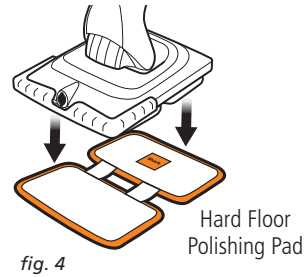
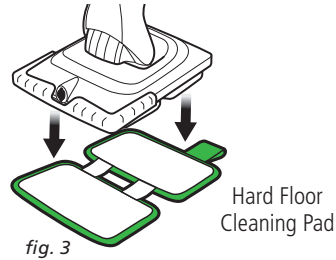
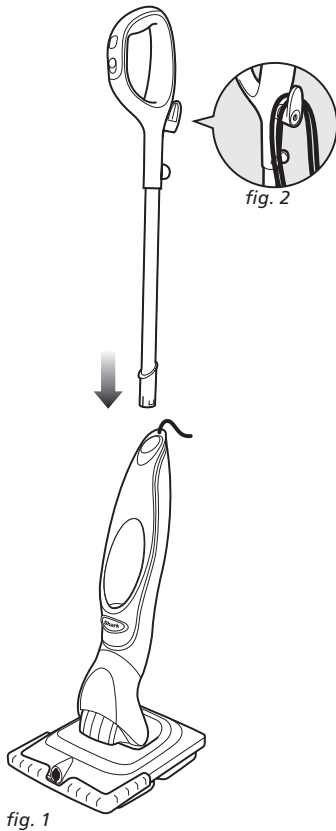

IMPORTANT: Always make sure that the **Sonic Duo™ Pro** is **UNPLUGGED** from the wall when not in use. Never fill the Reusable Bottle, change or remove the **Sonic Duo™ Pro** pad when the appliance is plugged into the wall. Use **ONLY** diluted **Shark®'s** Low Moisture - No Rinse - Carpet Cleaner or Hard Floor Cleaner in the **Sonic Duo™ Pro** Reusable Bottle. The addition of other chemicals or cleaning solutions may damage the appliance, void the warranty and could be unsafe for you and your family. For best results, dilute the Hard Floor Cleaner with distilled water to reduce streaking and minimize residue.

WARNING: The Hard Floor Polish should never be put through the **Sonic Duo™ Pro**. It will cause clogging in the system.

ASSEMBLY

- 1 Insert the handle into the neck of the main body of the **Sonic Duo™ Pro**. Push the mop handle and main body of the appliance together until you hear it "click" into place. (Fig. 1)
- 2 Hold the power cord and wrap it around the cord holders. (Fig. 2)
- 3 Place the Hard Floor Cleaning Pad, the Hard Floor Polishing Pad or the Carpet/Rug Cleaning Pad on the floor ensuring that the Velcro® side is facing up. (Fig. 3, Fig. 4, Fig. 5)
- 4 Place the **Sonic Duo™ Pro** unit on top of the Hard Floor Cleaning Pad, the Hard Floor Polishing Pad, the Carpet/Rug Cleaning Pad or the Carpet Scrub 'n Stain™ Pad. (Fig. 3, Fig. 4, Fig. 5)

Using Your *Sonic Duo™ Pro* Carpet, Wood & Hard Floor Cleaner

IMPORTANT: Always check with the carpet manufacturer or distributor before using the *Shark®* Activating Pretreater Stain & Odor Remover or the Low Moisture -No Rinse - Carpet Cleaner. To determine the colorfastness of any carpet -especially with reds or blues - take a clean, moist towel and gently rub a small area in an inconspicuous area. If color comes off on the towel, you should discontinue use.

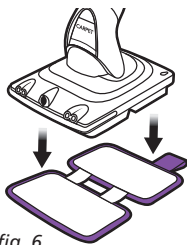

fig. 6

Cleaning Your Carpets

The *Sonic Duo™* comes with a Reusable Bottle with a "Purple" cap and label. This bottle is to be used with the Low Moisture -No Rinse- Carpet Cleaner. The *Sonic Duo™* also has a second Carpet Mode (II) that should be used when cleaning carpets. Please note that not all carpets react to the *Sonic Duo* the same way. Some carpets will require more time and cleaning solution than others.

REGULAR CLEANING

Step 1:

- 1 Vacuum your carpets and/or area rugs to remove any loose dirt, dust, or debris that may have accumulated in the carpet.

Step 2:

- 2 Attach the Carpet/Rug Cleaning Pad to the bottom of the *Sonic Duo™*. This pad has a "Purple" trim and tag that says Carpet/Rug Cleaning Pad. Attach the pad as shown in (Fig. 6) – the tag should be positioned toward the back of the *Sonic Duo™*.
- 3 Remove the Reusable Bottle by holding it and pulling up (Fig. 7). Remove the cap by turning it counterclockwise.
- 4 Fill the Reusable Bottle with the "Purple" cap and label with water until the "1:7 Water" fill line and then with the Low Moisture -No Rinse- Carpet Cleaner until the "Solution" fill line. (Fig. 8)

Always fill with water first and then add the cleaning solution so avoid foaming and ensure accuracy when measuring.

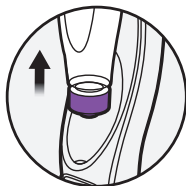

fig. 7

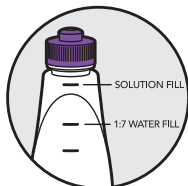

fig. 8

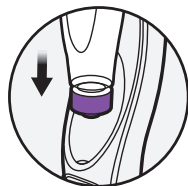

fig. 9



fig. 10

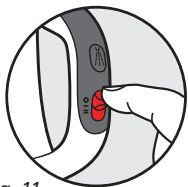

fig. 11

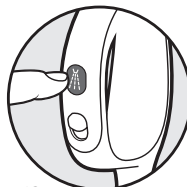

fig. 12

- 5 Screw the bottle cap on tightly and insert the Reusable Bottle into the unit. Push it down to make sure that it is well inserted. You will hear an audible "Click" when the Reusable Bottle is inserted properly. (Fig. 9)
 - 6 Twist the quick cord release holder to unwrap the power cord completely. (Fig. 10) Plug into an electrical outlet and slide the "ON/OFF" button to turn the *Sonic Duo™* on. Select the faster Carpet Mode (II). (Fig. 11)
 - 7 Lightly step on the back of the scrubbing head to release the handle.
- WARNING:** Never stand on the *Sonic Duo™*.
- 8 Begin cleaning by pressing the Spray Button to apply the cleaning solution to the carpet that is to be cleaned. (Fig. 12) Spray the solution continuously while pushing the unit forward and then pulling it backward until the area to be cleaned is damp.

HIGH TRAFFIC AREA CLEANING

Step 1:

- 1 Vacuum your carpets and/or area rugs to remove any loose dirt, dust, or debris that may have accumulated in your carpet.

Step 2:

- 2 Liberally spray the Activating Pretreater Carpet Stain & Odor Remover to pretreat the area. Spray the entire area until saturated and let sit for 3-5 minutes.
- 3 Attach the **Carpet Scrub 'n Stain™ Pad** to the bottom of the **Sonic Duo™**. This pad has a "Purple" trim and tag that is labelled **Carpet Scrub 'n Stain™ Pad**. Attach the pad as shown in (Fig. 14) – the tag should be positioned toward the back of the **Sonic Duo™**.
- 4 Go over the Pretreated High Traffic Area with the **Sonic Duo™** and the **Carpet Scrub 'n Stain™ Pad** using a forward then back motion. Continue to go over the area until most of the Pretreater has been absorbed by the **Carpet Scrub 'n Stain™ Pad**. The area will be damp, but not wet.

Step 3:

- 5 Attach the **Carpet/Rug Cleaning Pad** to the bottom of the **Sonic Duo™**. This pad has a "Purple" trim and tag that is labelled **Carpet/Rug Cleaning Pad**. Attach the pad as shown in (Fig. 14) – the tag should be positioned toward the back of the **Sonic Duo™**.
- 6 Remove the Reusable Bottle by holding it and pulling up. (Fig. 15) Remove the cap by turning it counterclockwise.
- 7 Fill the Reusable Bottle with the "Purple" cap and label with water until the "1:3 Water" fill line and then with the Low Moisture –No Rinse-Carpet Cleaner until the "Solution" fill line. (Fig. 16)

Always fill with water first and then add the cleaning solution so avoid foaming and ensure accuracy when measuring.



fig. 13

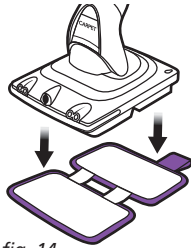

fig. 14

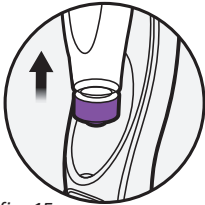

fig. 15

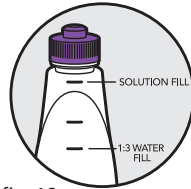

fig. 16

NOTE: The first time that you use the **Sonic Duo™** there may be air in the system causing a delay for the solution to come out of the spray nozzle. Hold the spray button down for 5 to 10 seconds until you see the solution spray out.

- 9 Using the same back and forth motion, continue go over the area a few times without spray. Work your way through the room or area being cleaned methodically. Repeat as necessary until the entire carpeted area has been cleaned. No rinsing is required.
- 10 If the Reusable Bottle is empty, you can refill it at any time as long as the **Sonic Duo™** is unplugged from the outlet.
- 11 Once finished, step on the tag of the Carpet/Rug Cleaning Pad and lift the unit to remove the Carpet/Rug Cleaning Pad from the **Sonic Duo™** (Fig. 13). Let the carpet dry thoroughly and then vacuum.

Visit www.sharkclean.com for other great quick cleaning products to complement your **Sonic Duo™**, such as the **Shark® Rotator™** vacuums.

Using Your *Sonic Duo™ Pro* Carpet, Wood & Hard Floor Cleaner- cont.

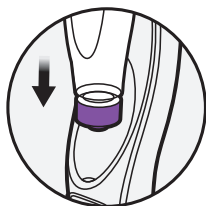

fig. 17

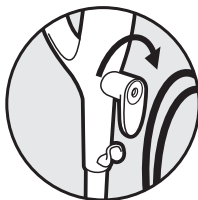

fig. 18



fig. 19

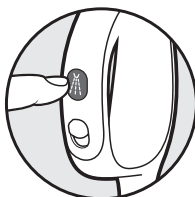

fig. 20

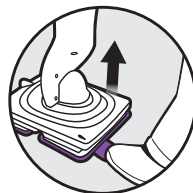

fig. 21

- 8 Screw the bottle cap on tightly and insert the Reusable Bottle into the unit. Push it down to make sure that it is well inserted. You will hear an audible "Click" when the Reusable Bottle is inserted properly. (Fig. 17)
- 9 Twist the quick cord release holder to unwrap the power cord completely. (Fig. 18) Plug into an electrical outlet and slide the "ON/OFF" button to turn the *Sonic Duo™* on. Select the faster Carpet Mode (II). (Fig. 19)
- 10 Lightly step on the back of the scrubbing head to release the handle.
- ⚠ **WARNING:** Never stand on the *Sonic Duo™*.
- 11 Begin cleaning by pressing the Spray Button to apply the cleaning solution to the carpet that is to be cleaned. (Fig. 20) Spray the solution continuously while pushing the unit forward and then pulling it backward several times until the area to be cleaned is wet*.
- NOTE: The first time that you use the *Sonic Duo™* there may be air in the system causing a delay for the solution to come out of the spray nozzle. Hold the spray button down for 5 to 10 seconds until you see the solution spray out.
- 12 Using the same back and forth motion, continue to go over the same area without spray. For heavily soiled high traffic areas or dingier carpets you may need to go over the area for several minutes, spraying periodically. Spray more solution as needed while cleaning. Repeat as necessary until the entire carpeted area has been cleaned. No rinsing is required.
- 13 If the Reusable Bottle is empty, you can refill it at any time as long as the *Sonic Duo™* is unplugged from the outlet.
- 14 Once finished, step on the tag of the *Carpet Scrub 'n Stain™* Pad and lift the unit to remove the *Carpet Scrub 'n Stain™* Pad from the *Sonic Duo™* (Fig. 21). Let the carpet dry thoroughly and then vacuum.

*You may need to push the *Sonic Duo™* back and forth over an area for as many as 8 strokes while continuously spraying the solution. More solution generally yields a better result, but be sure not to over-wet.

SPOT & STAIN CLEANING

Please note that not all carpets react to the **Sonic Duo™ Pro** the same way. Some carpets will require more time and cleaning solution than others.

Step 1:

1. Vacuum the stained or discolored area to remove any loose dirt, dust, or debris that may have accumulated in your carpet.

Step 2:

2. Begin by pretreating the stain with the Activating Pretreater Carpet Stain & Odor Remover until the stain or discoloration is fully saturated.
3. Let sit for 5-10 minutes.
4. Use a white cloth with a blunt object to blot up the stain.
5. You will see the stain begin to transfer from the carpet onto the white cloth.
6. Continue to use fresh areas of the white cloth as you blot up more and more of the stain.
7. Never rub.
8. Repeat as necessary.

Visit www.sharkclean.com for other great quick cleaning products to complement your **Sonic Duo™ Pro**, such as the **Shark® Rotator™** vacuums.

Frequently Asked Questions

- Q.** I noticed a rippling effect on the edges of my area rugs – should I be concerned?
- A.** Wool area rugs sometimes have a rippling effect on the edges after cleaning. This rippling will relax out after a few days of regular wear and usage.
- Q.** After using the Low Moisture –No Rinse- Carpet Cleaner, my carpet feels dry and crunchy – what can I do?
- A.** If your carpets feel crunchy, you likely used too much of the Low Moisture – No Rinse- Carpet Cleaner. The dry crunchy feeling will go away after a few days of normal wear and usage. Another pass vacuuming should also help break up the crunchy texture more quickly. To avoid this from happening again, we recommend using less solution on one specific area or a less concentrated dilution.
- Q.** How can I remove tough stains?
- A.** Begin by treating the stain with the Activating Pretreater until fully saturated. Let sit for 5-10 minutes. Next, use a white cloth with a blunt object to blot up the stain. You will see the stain transfer from the carpet onto the white cloth. Continue to use fresh areas of the cloth as you blot up more and more of the stain. Never rub. Repeat as necessary.

Using Your *Sonic Duo™ Pro* Carpet, Wood & Hard Floor Cleaner- cont.

- ⚠ IMPORTANT:** When cleaning, do not use the *Sonic Duo™ Pro* without attaching a Hard Floor Cleaning Pad and adding the diluted cleaning solution to the Reusable Bottle first. When polishing, do not use the *Sonic Duo™ Pro* without attaching a Hard Floor Polishing Pad.

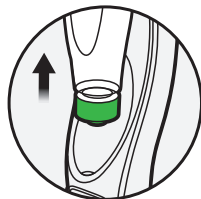

fig. 14

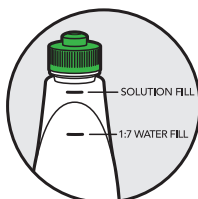

fig. 15

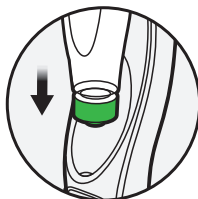

fig. 16

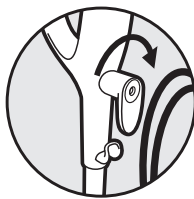

fig. 17

Cleaning Your Hard Floors:

- 1 To remove the Reusable Bottle, hold it and pull it up to remove from the unit. (Fig. 14)
- 2 Remove the "Green" bottle cap. Add 1 part of the Sonic Activated Hard Floor Cleaner solution to 7 parts water into the Reusable Bottle. Use the measuring marks on the Reusable Bottle for easy measuring and filling. (Fig. 15) Always fill with cold water first up to the "Water Fill Line" and then the add the cleaning solution up to the "Solution Fill Line" to avoid foaming and to ensure accuracy.
- 3 Screw the bottle cap on tightly and insert the Reusable Bottle into the unit upside down. Push it down to make sure that it is well inserted. You will hear an audible "Click" when the Reusable Bottle is inserted properly. (Fig. at the)

- ⚠ IMPORTANT:** Do not use on unsealed wood or unglazed ceramic floors. Do not use on wood or tile floors that are highly worn, unfinished or have a wax or oil finish. Surfaces that have been treated with wax or some no wax floors may be damaged by the cleaning and polishing solutions therefore it is always recommended to test an isolated area of the surface to be cleaned before proceeding. You should always check the use and care instructions from the floor manufacturer.



fig. 18

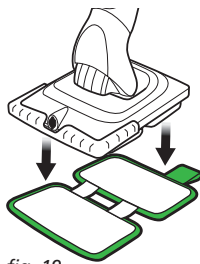

fig. 19

- ⚠ IMPORTANT:** Make sure the floors are swept or vacuumed before using the *Sonic Duo™ Pro*. Visit www.sharkclean.com for other great quick cleaning products to complement your *Sonic Duo™ Pro*, such as the *Shark® Rotator™* vacuums.
- 4 Twist the quick release cord holder to unwrap the power cord completely. (Fig. 17)
Plug into an electrical outlet and slide the "On/Off" button down to turn the *Sonic Duo™ Pro* on. Use "(I) Hard Floor" mode for hard floor cleaning. (Fig. 18)
 - 5 Make sure that the Hard Floor Cleaning Pad is attached to the *Sonic Duo™ Pro*. This pad has a "Green" trim and the tag says "Hard Floor Cleaning Pad". Attach the side of the Cleaning Pad with the tag to the back of the *Sonic Duo™ Pro*. (Fig. 19)

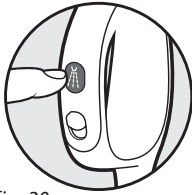

fig. 20

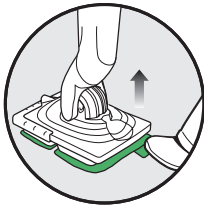

fig. 21

NOTE: The first time that you use the **Sonic Duo™ Pro** there may be air in the system causing a delay for the solution to come out of the spray nozzle. Hold the spray button down for 5 to 10 seconds until you see the solution come out.

- 6 Lightly step on the back of the scrubbing head to release the handle and move the agitating **Sonic Duo™ Pro** back and forth over the area to clean tough, dried on stains faster and easier. Repeat until the entire floor surface has been cleaned. No rinsing is required.
- ⚠ **WARNING:** Never stand on the **Sonic Duo™ Pro**.
- 7 Press the Spray Button to apply solution onto the floor that is to be cleaned. (Fig. 20)
- 8 If the Reusable Bottle is empty, you can refill it at any time as long as the **Sonic Duo™ Pro** is unplugged from the outlet.
- ⚠ **IMPORTANT:** Never leave the **Sonic Duo™ Pro** with a damp/wet cleaning pad on any floor surface for any amount of time as this may damage the floor.
- 9 Once finished, step on the tag of the Hard Floor Cleaning Pad and lift the unit to remove the pad from the **Sonic Duo™ Pro**. (Fig. 21)

Frequently Asked Questions

- Q. My **Sonic Duo™ Pro** leaves a foam on hard floors.
- A. The **Sonic Duo™ Pro** Hard Floor Cleaning Pad is likely too saturated. Replace it with a clean, dry pad.
- Q. My floors appear cloudy after cleaning.
- A. The **Sonic Duo™ Pro** Hard Floor Cleaning Pad may be dirty. Change the pad.
- OR
- A. The **Sonic Duo™ Pro** Hard Floor Cleaning Pad was washed with a powder detergent and may be damaged and require replacement. Never use powder detergents. Only use liquid detergent to launder the cleaning pads.
- OR
- A. The **Sonic Duo™ Pro** may have been left in the same spot for too long with a wet cleaning pad. Never leave the unit with a wet pad in one spot for too long.
- OR
- A. This may be leftover from past cleaners that were used on the floor surface. Use the **Sonic Duo™ Pro** a few more times and see if the leftover cloudiness is removed. If this does not work, we suggest rinsing the floor with water and letting it dry. One or more rinses generally removes the residue. A more stubborn case may require you to rinse the floor with a mix of one part vinegar to 2 parts water. Then use the **Sonic Duo™ Pro** again with a clean pad.
- Q. How can I remove tough stains and tough dried on dirt.
- A. To remove tough stains and dried on dirt, we recommend using the ScrubDuster™ tool with the Scrubbing Pad. Just attach the pad, extend the wand and clean away your toughest spots. (See page 9 for assembly.)

Using Your Sonic Duo™ Pro Carpet, Wood & Hard Floor Cleaner- cont.

⚠ IMPORTANT: NEVER add the **Sonic Activated Hard Floor Polish** to the Reusable Bottle or run it through the **Sonic Duo™ Pro** unit.

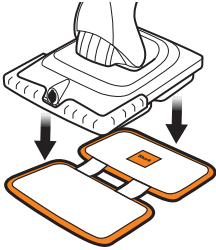

fig. 22



fig. 23



fig. 24



fig. 25

Polishing Your Hard Floors:

- 1 Vacuum the floor to remove all loose dirt, dust and grit from the floor surface. For best results, we recommend that you clean the floor using the **Shark®** Hard Floor Cleaner first and allow time to dry before polishing.
- 2 Attach the Hard Floor Polishing Pad to the bottom of the **Sonic Duo™ Pro**. This pad has a "Orange" trim and the "Orange" tag says "Hard Floor Polishing Pad". (Fig. 22)
- 3 Lightly step on the back of the scrubbing head to release the handle.
- ⚠ WARNING:** Never stand on the **Sonic Duo™ Pro**.
- 4 Carefully, squirt a liberal amount of the Floor Polish onto an area of the floor to be polished and place the polishing pad over it before you start the unit. Make sure that the polishing pad is saturated and then squirt the polish in 5'x5' sections. (Fig. 23)
- 5 Turn the On/Off button to "(I) Hard Floor" mode. Always squirt the floor polish from a height of 6 inches above the floor to avoid splashing the polish over the floor. One bottle is enough to cover 425 square feet. (Fig. 24)

- 6 Use the **Sonic Duo™ Pro** to spread the polish evenly over the floor. Do not go over an applied area too frequently. Always leave an area looking wet. If a section begins to look dry while polishing, add more Hard Floor Polish to the area. Repeat until the whole area has been polished.
- 7 When going from section to section, do not lift the **Sonic Duo™ Pro** to move it, always slide it to the next section. No rinsing is required.
- 8 Allow the Hard Floor Polish to dry for at least 1 hour in light traffic areas and a complete 24 hours for the polish to cure before returning to heavy traffic areas.
- 9 When finished, turn the unit off and slide and lift the **Sonic Duo™ Pro** to remove it from the area that was just polished. Lay the **Sonic Duo™ Pro** on its side and remove the Hard Floor Polishing Pad by hand. (Fig. 25)

NOTE: Depending on the amount of traffic your floors sustain, **Shark®** recommends polishing every 2 months. Touch up high traffic areas as needed in-between full floor polishes.

! IMPORTANT: Do not use on unsealed wood or unglazed ceramic floors. Do not use on wood or tile floors that are highly worn, unfinished or have a wax or oil finish. Surfaces that have been treated with wax or some no wax floors may be damaged by the cleaning and polishing solutions therefore it is always recommended to test an isolated area of the surface to be cleaned or polished before proceeding. You should check the use and care instructions from the floor manufacturer before cleaning or polishing.

! IMPORTANT: Do not use more than one brand of floor polish to polish one room. Use only **Shark® Hard Floor Polish**.

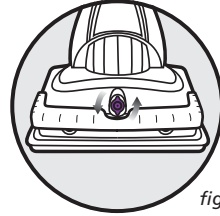

fig. 26

Frequently Asked Questions

Q. Polishing has left my floors streaky or spotty.

A. You should go over the streaky or spotty area with more polish. Always leave the area looking very wet, never dry.

Q. There is a footprint, smudge or uneven spot after or during polishing.

A. You should add more polish to any problem areas during polishing. Always leave the area looking very wet, never dry.

Q. I accidentally ran the **Shark® Hard Floor Polish** through the **Sonic Duo™ Pro** and now it is not working properly.

A. **Shark® Hard Floor Polish** should always be squirted directly onto the floor. If it was run through the unit, you need to flush it out immediately. Fill the Reusable Bottle with warm water and spray it through the system to flush it. Then turn and remove the tip of the nozzle to clean it. **(Fig. 26)** Call Customer Service at 1-800-798-7398 for additional assistance if necessary.



fig. 27



fig. 28

Using the ScrubDuster™:

Use the ScrubDuster™ with the Scrubbing Pad to remove tough stains and dried on dirt or the Dusting Pad to dust around and reach inside the narrowest crevices for a true Total Clean in every nook and cranny.

- 1 Attach one side of the Scrubbing Pad or the Dusting Pad to the Velcro® strip on the front side of the ScrubDuster™ and then bring it up and attach it to the Velcro® strip on the back. Make sure that the pad is attached tightly. **(Fig. 27, Fig. 28)** Extend the wand for easier reach.

Using Your *Sonic Duo™ Pro* Carpet, Wood & Hard Floor Cleaner- cont.

<i>Pad</i>	<i>Consumption</i>
Hard Floor Cleaning Pad	Replace after 20 washes
Hard Floor Polishing Pad	Replace after 20 washes
Carpet/Rug Cleaning Pad	Replace after 20 washes
Carpet Scrub 'n Stain™ Removal Pad	Replace after 20 washes

<i>Cleaner</i>	<i>Consumption / Usage</i>
Hard Floor Cleaner	Use 32 oz. diluted solution per 600 sq. ft.
Hard Floor Polish	Use 28 oz. solution per 425 sq. ft.
Activating Pretreater Carpet Stain & Odor Remover	Fully saturate a spot or stain before blotting
Low Moisture - No Rinse - Carpet Cleaner	Use 32 oz. diluted solution per 250 sq. ft.

General Tips:

- Change the Hard Floor Cleaning Pad frequently for best results.
- Always vacuum floors and carpets before cleaning or polishing.
- If you notice any uneven areas or streaking, DO NOT go over the same area with more polish if the floor has begun to dry. Wait until the floor polish has totally dried for approximately a day before going over it again with more polish.
- Never lift the *Sonic Duo™ Pro* up at the end of a section of flooring that has been polished. Always slide the unit off the floor and then remove the pad.
- When polishing, you should always leave each section looking wet, never dry, before going to the next section.
- Try the Pretreater Carpet Stain & Odor Remover to eliminate your toughest stains. Just spray the solution onto the stain until saturated, allow 5-10 minutes to set and then blot up the stain with a white cloth or towel. Never scrub the stain, only blot.

Care and Maintenance

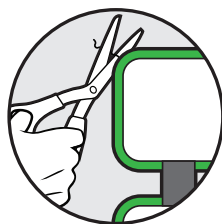

AFTER USE AND STORAGE

- 1 When you have finished using the *Sonic Duo™ Pro*, unplug the cord from the outlet and remove the Carpet/Rug Cleaning Pad, Carpet Scrub 'N Stain™ Pad, Hard Floor Cleaning Pad or Hard Floor Polishing Pad from the unit.
- 2 Store the *Shark® Sonic Duo™ Pro* in the upright position without the Carpet/Rug Cleaning Pad, Carpet Scrub 'N Stain™ Pad, Hard Floor Cleaning Pad or Hard Floor Polishing Pad on the unit and away from children or high traffic areas.
- 3 The Reusable Bottle can be hand washed **ONLY**. Never wash the Reusable Bottle in the dishwasher - it will warp.

CARE FOR YOUR CARPET/RUG CLEANING PAD, CARPET SCRUB 'N STAIN™ PAD, HARD FLOOR CLEANING PAD AND HARD FLOOR POLISHING PAD

NOTE: Please note that the Hard Floor Polishing Pad must be rinsed immediately after use and before being machine washed with the other pads.

- 1 We recommend washing your *Sonic Duo™ Pro* Hard Floor Cleaning Pads, Hard Floor Polishing Pads and Carpet/Rug Cleaning Pads separately from other fabrics to avoid picking up lint. **Only use liquid detergent (no powder detergent). Do not use any fabric softeners or bleach.** Line dry or dry on a low dryer setting.
- 2 If there are loose threads on the cleaning or polishing pad, carefully cut the thread with scissors. Do not pull on them or cut at the base.

Ordering Replacement Parts

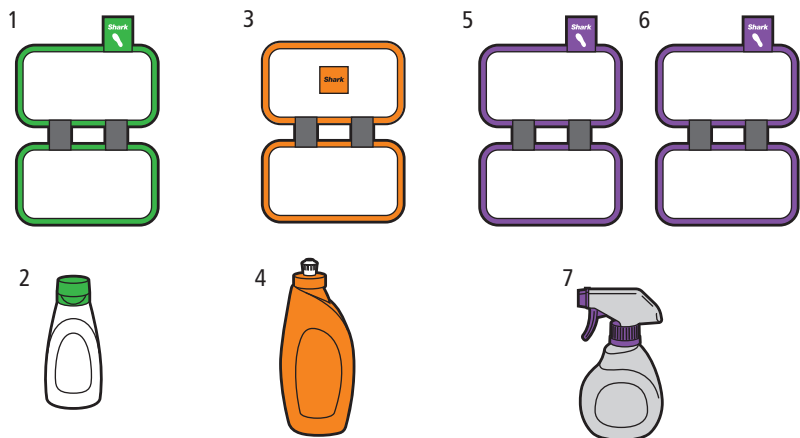

To order additional parts and accessories, feel free to contact us at www.sharksonicduo™.com or call **1-800-798-7398**.

NOTE: Some parts may be available at your local retailer. Contact customer service for any other servicing.



PART	PART NO.
1 Hard Floor Cleaning Pad	P131WHF
2 Hard Floor Cleaner	XHFCB02
3 Hard Floor Polishing Pad	P133WSH
4 Hard Floor Polish	XSHCB04
5 Carpet/Rug Cleaning Pad	P132WCP
6 Carpet Scrub 'n Stain™ Removal Pad	P138SSC
7 Activating Pretreater, Carpet Stain & Odor Remover	XRUB907
8 Low Moisture - No Rinse - Carpet Cleaner	XCPCB03
9 ScrubDuster™	500FFJ-K450
10 ScrubDuster™ Dusting Pad	P134WTUP
11 ScrubDuster™ Scrubbing Pad	P135WSCR
12 Hard Floor Dusting Pad	P137WDST
13 Storage Tray	XSTRAY400

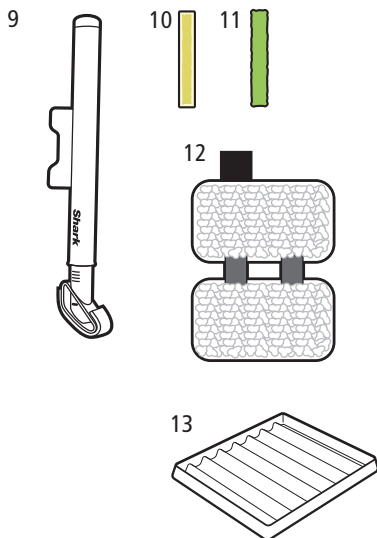

Troubleshooting Guide

PROBLEM	POSSIBLE REASONS & SOLUTIONS
<p>Sonic Duo™ Pro is squirting foam from the spray nozzle.</p>	<ol style="list-style-type: none"> 1. The Reusable Bottle is not firmly inserted into the unit. Make sure that you hear an audible “Click” when you insert the Reusable Bottle into the appliance. 2. There may be air in the system. Hold down the spray button for 5 to 10 seconds to flush the system.
<p>Sonic Duo™ Pro doesn't spray.</p>	<ol style="list-style-type: none"> 1. Make sure that the Reusable Bottle is inserted all the way in. You should hear an audible “Click” when inserted. 2. Check that there is enough cleaning solution in the Reusable Bottle. If not, add more. 3. The bottle cap on the Reusable Bottle may need to be cleaned. Remove it from the Reusable Bottle and rinse it under running water and then replace it onto the Reusable Bottle. 4. There may be air in the system. Hold down the spray button for 5 to 10 seconds until solution comes out of the spray nozzle. 5. The colored spray nozzle at the front of the unit where the spray comes out may be clogged. Clean the spray nozzle by removing it from the unit. To remove it, grip the small lips at the top and bottom of the spray nozzle and turn counterclockwise. Run the spray nozzle under warm water to clean it out. Reinsert the spray nozzle by lining up its grooves with the inside of the nozzle hole. Turn clockwise until the lips return to the top and bottom positions.
<p>Sonic Duo™ Pro turns off when the handle is lowered.</p>	<ol style="list-style-type: none"> 1. The Sonic Duo™ Pro automatically turns off when the handle is lowered to low. This is a safety mechanism to ensure that the machine will turn off if it is dropped. To keep the Sonic Duo™ Pro on when cleaning under low profile items, simply twist the handle to the left or right and engage the swivel. When the handle is swivelled and lowered, the Sonic Duo™ Pro will remain on.
<p>The cap of the Reusable Bottle is stuck inside the Sonic Duo™ Pro after the bottle was removed.</p>	<ol style="list-style-type: none"> 1. To remove the cap, hold center valve of the cap with your fingers and gently pull it out. If it doesn't come out easily, use a set of long nose pliers for leverage. Be careful not to crack the center valve when applying pressure and lifting up.
<p>The Reusable Bottle fell out.</p>	<ol style="list-style-type: none"> 1. The Sonic Duo™ Pro is not meant to be turned upside down. When upside-down, the Reusable Bottle is at risk for falling out of its cradle. Please do not turn the Sonic Duo™ Pro upside-down. If it is necessary to turn the unit upside-down, remove the Reusable Bottle first.
<p>Sonic Duo™ Pro turns off on its own.</p>	<p>This unit is equipped with an automatic protector. If for some reason your appliance overheats, the protector will automatically turn the unit off. Should this occur, perform the following steps to restart the appliance:</p> <ol style="list-style-type: none"> 1. Move the switch to the “O” (Off) position. 2. Unplug. 3. Allow the unit to cool for around 45 minutes. 4. Plug in. 5. Turn the switch on to restart. <p>Note: If appliance still does not start, contact Customer Service at: 1-800-798-7398.</p>

Notes



Notes

Notes





FIVE (5) YEARS LIMITED WARRANTY

EURO-PRO Operating LLC warrants this product to be free from defects in material and workmanship for a period of five (5) years from the date of the original purchase, when utilized for normal household use, subject to the following conditions, exclusions and exceptions.

If your appliance fails to operate properly while in use under normal household conditions within the warranty period, return the complete appliance and accessories, freight prepaid. For assistance with warranty service options or customer support, please call our customer care and product specialists at 1 (800) 798-7398 or visit our website www.sharksonicduo.com.

If the appliance is found to be defective in material or workmanship, **EURO-PRO Operating LLC** will repair or replace it free of charge. Proof of purchase is required and a fee of \$19.95 will apply to cover the cost of return freight. *

The liability of **EURO-PRO Operating LLC** is limited solely to the cost of the repair or replacement of the unit at our option. This warranty does not cover normal wear of parts and does not apply to any unit that has been tampered with or used for commercial purposes. This limited warranty does not cover damage caused by misuse, abuse, negligent handling or damage due to faulty packaging or mishandling in transit. This warranty does not cover damage or defects caused by or resulting from damages from shipping or repairs, service or alterations to the product or any of its parts, which have been performed by a repair person not authorized by **EURO-PRO Operating LLC**.

This warranty is extended to the original purchaser of the unit and excludes all other legal and/or conventional warranties. The responsibility of **EURO-PRO Operating LLC** warranty if any, is limited to the specific obligations expressly assumed by it under the terms of the limited warranty. **In no event is EURO-PRO Operating LLC** liable for incidental or consequential damages of any nature whatsoever. Some states/provinces do not permit the exclusion or limitation of incidental or consequential damages, so the above may not apply to you.

This warranty gives you specific legal rights, and you may also have other rights which vary from state to state or province to province.

***Important: Carefully pack item to avoid damage in shipping. Be sure to include proof of purchase date and to attach tag to item before packing with your name, complete address and phone number with a note giving purchase information, model number and what you believe is the problem with the item. We recommend you insure the package (as damage in shipping is not covered by your warranty). Mark the outside of your package "ATTENTION CUSTOMER SERVICE". We are constantly striving to improve our products, therefore the specifications contained herein are subject to change without notice.**

Product Registration

Please visit www.sharksonicduo.com or call **1-800-798-7398** to register your new **Shark®** product within ten (10) days of purchase. You will be asked to provide the store name, date of purchase and model number along with your name and address.

The registration will enable us to contact you in the unlikely event of a product safety notification. By registering you acknowledge to have read and understood the instructions for use, and warnings set forth in the accompanying instructions.

EURO-PRO Operating LLC

U.S.: Newton, MA 02459

Canada: Ville St. Laurent, Québec H4S 1A7

1-800-798-7398

www.sharksonicduo.com

COPYRIGHT © 2013 EURO-PRO OPERATING LLC

Euro-Pro, Shark, Sonic Duo Pro, ScrubDuster, and Rotator are trademarks of Euro-Pro Operating LLC. All other brand names may be trademarks of their respective owners.

PRINTED IN CHINA

SP1000.E.131011.2

Illustrations may differ from actual product.