

SHARP®

MICROWAVE OVEN OPERATION MANUAL

Carousel®

MODELS

R-510C / R-410C

Followed by letter indicating color
K=black, W=white

CONTENTS



- For Customer Assistance Inside Front Cover
- Precautions to Avoid Possible Exposure to Excessive Microwave Energy Inside Front Cover
- Limited Warranty 1
- Product Information Card 1
- Important Safety Instructions 2
- Unpacking and Installation Instructions 3
- Grounding Instructions 3
- Information You Need to Know 4-6
- Part Names 7
- Before Operating 8
- Manual Operation 9
- Special Features 10-12
- Other Convenient Features 13-14
- Cleaning & Care 14
- Service Call Check 15
- THE ULTIMATE ACCESSORY 15
- Specifications 16
- COOKBOOK ORDER FORM 16
- Cooking Charts 17-20
- Guia Auto-Touch Parte Interior de la Cubierta Trasera
- Auto-Touch Guide Back Cover

Read all instructions carefully before using the oven.

FOR CUSTOMER ASSISTANCE

To aid in reporting this microwave oven in case of loss or theft, please record below the model number and serial number located on the unit. We also suggest you record all the information listed and retain for future reference.

MODEL NUMBER _____	SERIAL NUMBER _____
DATE OF PURCHASE _____	
DEALER _____	TELEPHONE _____
SERVICER _____	TELEPHONE _____

TO PHONE:

DIAL 1-800-BE-SHARP (237-4277) for :

SERVICE (for your nearest Sharp Authorized Servicer)

PARTS (for your authorized parts distributor)

ADDITIONAL CUSTOMER INFORMATION

DIAL 1-800-642-2122 for :

ACCESSORIES and COOKBOOK

DIAL (201)529-8703 for :

COOKING ASSISTANCE

TO WRITE:

For cooking and operation questions:

Susan Edwards/Test Kitchen
Sharp Electronics Corporation
Sharp Plaza, Box 650
Mahwah, NJ 07430-2135

For service problems, warranty information, missing items and other assistance:

Sharp Electronics Corporation
Customer Assistance Center
1300 Naperville Drive
Romeoville, IL 60446-1091

Please provide the following information when you write or call: model number, serial number, date of purchase, your complete mailing address (including zip code), your daytime telephone number (including area code) and description of the problem.

TO ACCESS INTERNET: www.sharp-usa.com

PRECAUTIONS TO AVOID POSSIBLE EXPOSURE TO EXCESSIVE MICROWAVE ENERGY

- (a) Do not attempt to operate this oven with the door open since open-door operation can result in harmful exposure to microwave energy. It is important not to defeat or tamper with the safety interlocks.
- (b) Do not place any object between the oven front face and the door or allow soil or cleaner residue to accumulate on sealing surfaces.
- (c) Do not operate the oven if it is damaged. It is particularly important that the oven door close properly and that there is no damage to the: (1) door (bent), (2) hinges and latches (broken or loosened), (3) door seals and sealing surfaces.
- (d) The oven should not be adjusted or repaired by anyone except properly qualified service personnel.

CONSUMER LIMITED WARRANTY

SHARP ELECTRONICS CORPORATION warrants to the first consumer purchaser that this Sharp brand product (the "Product"), when shipped in its original container, will be free from defective workmanship and materials, and agrees that it will, at its option, either repair the defect or replace the defective Product or part thereof with a new or remanufactured equivalent at no charge to the purchaser for parts or labor for the period(s) set forth below.

This warranty does not apply to any appearance items of the Product nor to the additional excluded item(s) set forth below nor to any Product the exterior of which has been damaged or defaced, which has been subjected to improper voltage or other misuse, abnormal service or handling, or which has been altered or modified in design or construction.

In order to enforce the rights under this limited warranty, the purchaser should follow the steps set forth below and provide proof of purchase to the servicer.

The limited warranty described herein is in addition to whatever implied warranties may be granted to purchasers by law. ALL IMPLIED WARRANTIES INCLUDING THE WARRANTIES OF MERCHANTABILITY AND FITNESS FOR USE ARE LIMITED TO THE PERIOD(S) FROM THE DATE OF PURCHASE SET FORTH BELOW. Some states do not allow limitations on how long an implied warranty lasts, so the above limitation may not apply to you.

Neither the sales personnel of the seller nor any other person is authorized to make any warranties other than those described herein, or to extend the duration of any warranties beyond the time period described herein on behalf of Sharp.

The warranties described herein shall be the sole and exclusive warranties granted by Sharp and shall be the sole and exclusive remedy available to the purchaser. Correction of defects, in the manner and for the period of time described herein, shall constitute complete fulfillment of all liabilities and responsibilities of Sharp to the purchaser with respect to the Product, and shall constitute full satisfaction of all claims, whether based on contract, negligence, strict liability or otherwise. In no event shall Sharp be liable, or in any way responsible, for any damages or defects in the Product which were caused by repairs or attempted repairs performed by anyone other than an authorized servicer. Nor shall Sharp be liable or in any way responsible for any incidental or consequential economic or property damage. Some states do not allow the exclusion of incidental or consequential damages, so the above exclusion may not apply to you.

THIS WARRANTY GIVES YOU SPECIFIC LEGAL RIGHTS. YOU MAY ALSO HAVE OTHER RIGHTS WHICH VARY FROM STATE TO STATE.

Your Product Model Number & Description:

R-510C or R-410C Home Use Carousel Microwave Oven. (Be sure to have this information available when you need service for your Product.)

Warranty Period for this Product:

One (1) year parts and labor. The warranty period continues for an additional four (4) years, for a total of five (5) years, with respect to the magnetron tube in the Product for parts only; labor and service are not provided free of charge for this additional period.

Additional Item(s) Excluded from Warranty Coverage (if any):

Non-functional accessories, turntable and light bulb.

Where to Obtain Service:

From a Sharp Authorized Servicer located In the United States. To find the location of the nearest Sharp Authorized Servicer, call Sharp toll free at 1-800-BE-SHARP (1-800-237-4277).

What to do to Obtain Service:

Ship prepaid or carry in your Product to a Sharp Authorized Servicer. Be sure to have **Proof of Purchase** available. If you ship the Product, be sure it is insured and packaged securely.

TO OBTAIN SUPPLY, ACCESSORY OR PRODUCT INFORMATION, CALL 1-800-BE-SHARP OR VISIT www.sharp-usa.com. SAVE THE PROOF OF PURCHASE AS IT IS NEEDED SHOULD YOUR OVEN EVER REQUIRE WARRANTY SERVICE.

PRODUCT INFORMATION CARD

The Product information card which is on the inside of the microwave oven carton should be completed within ten days of purchase and returned. We will keep it on file and help you access the information in case of loss, damage or theft. This will also enable us to contact you in the unlikely event that any adjustments or modifications are ever required for your oven. Save proof of purchase as it is needed should your oven ever require warranty service.

IMPORTANT SAFETY INSTRUCTIONS

When using electrical appliances basic safety precautions should be followed, including the following:

WARNING - To reduce the risk of burns, electric shock, fire, injury to persons or exposure to excessive microwave energy:

1. Read all instructions before using the appliance.
2. Read and follow the specific **“PRECAUTIONS TO AVOID POSSIBLE EXPOSURE TO EXCESSIVE MICROWAVE ENERGY”** on inside front cover.
3. This appliance must be grounded. Connect only to properly grounded outlet. See **“GROUNDING INSTRUCTIONS”** on page 3.
4. Install or locate this appliance only in accordance with the provided installation instructions.
5. Some products such as whole eggs and sealed containers—for example, closed glass jars — may explode and should not be heated in this oven.
6. Use this appliance only for its intended use as described in this manual. Do not use corrosive chemicals or vapors in this appliance. This type of oven is specifically designed to heat, cook or dry food. It is not designed for industrial or laboratory use.
7. As with any appliance, close supervision is necessary when used by children.
8. Do not operate this appliance if it has a damaged cord or plug, if it is not working properly or if it has been damaged or dropped.
9. This appliance should be serviced only by qualified service personnel. Contact nearest Sharp Authorized Servicer for examination, repair or adjustment.
10. Do not cover or block any openings on the appliance.
11. Do not store or use this appliance outdoors. Do not use this product near water—for example, near a kitchen sink, in a wet basement or near a swimming pool, and the like.
12. Do not immerse cord or plug in water.
13. Keep cord away from heated surfaces.
14. Do not let cord hang over edge of table or counter.
15. See door surface cleaning instructions on page 14.
16. To reduce the risk of fire in the oven cavity:
 - a. Do not overcook food. Carefully attend appliance if paper, plastic or other combustible materials are placed inside the oven to facilitate cooking.
 - b. Remove wire twist-ties from paper or plastic bags before placing bag in oven.
 - c. **If materials inside the oven should ignite, keep oven door closed, turn oven off and disconnect the power cord or shut off power at the fuse or circuit breaker panel.**
 - d. Do not use the cavity for storage purposes. Do not leave paper products, cooking utensils or food in the cavity when not in use.
17. If the oven is installed as a built-in, observe the following instructions:
 - a. Do not operate any heating or cooking appliance beneath this appliance.
 - b. Do not mount unit over or near any portion of a heating or cooking appliance.
 - c. Do not mount over a sink.
 - d. Do not store anything directly on top of the appliance surface when the appliance is in operation.
18. If the oven light fails, consult a SHARP AUTHORIZED SERVICER.

SAVE THESE INSTRUCTIONS

UNPACKING AND INSTALLATION INSTRUCTIONS

Unpacking and Examining Your Oven

Remove:

1. all packing materials from inside the oven cavity; however, **DO NOT REMOVE THE WAVEGUIDE COVER**, which is located on the right cavity wall.

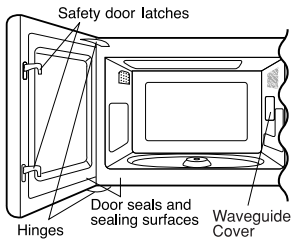

Read enclosures and **SAVE** the Operation Manual.

2. the feature sticker, if there is one, from the outside of the door.

Check the oven for any damage, such as misaligned or bent door, damaged door seals and sealing surfaces, broken or loose door hinges

and latches and dents inside the cavity or on the door. If there is any damage, do not operate the oven and contact your dealer or **SHARP AUTHORIZED SERVICER**.

Choosing a Location for Your Oven

You will use the oven frequently so plan its location for

ease of use. It's wise, if possible, to have counter space on at least one side of the oven. Allow at least 2 inches on the sides, top and at the rear of the oven for air circulation. Do not place or install the oven in any area where heat and steam are generated; for example, next to or above a conventional gas or electric range or above a conventional wall oven. Heat and steam may damage the electronics or the mechanical parts of the oven.

Built-in Kit

Your oven can be built into a cabinet or wall—not near or above a heat source—using Sharp's Built-In Kit RK-51 for the R-510CK, RK-51W for the R-510CW; the RK-42 for the R-410CK and the RK-42W for the R-410CW. If your dealer does not stock the kit, it can be ordered directly from the Sharp Accessories and Supplies Center. Have your credit card number available and call toll-free: **1-800-642-2122** for ordering the kit to be sent to your address.

The kit includes ducts and finish trim strips and easy-to-follow instructions for installation as well as the location of the power supply.

GROUNDING INSTRUCTIONS

This appliance must be grounded. This oven is equipped with a cord having a grounding wire with a grounding plug. It must be plugged into a wall receptacle that is properly installed and grounded in accordance with the National Electrical Code and local codes and ordinances. In the event of an electrical short circuit, grounding reduces risk of electric shock by providing an escape wire for the electric current.

WARNING – Improper use of the grounding plug can result in a risk of electric shock.

Electrical Requirements

The electrical requirements are a 120 volt 60 Hz, AC only, 15 amp. or more protected electrical supply. It is recommended that a separate circuit serving only this appliance be provided.

The oven is equipped with a 3-prong grounding plug. It must be plugged into a wall receptacle that is properly installed and grounded. Should you only have a 2-prong outlet, have a qualified electrician install a correct wall receptacle.

A 3-prong adapter may be purchased and used temporarily if local codes allow. Follow package directions.

A short power-supply cord is provided to reduce risk of becoming entangled in or tripping over a longer cord.

Extension Cord

If it is necessary to use an extension cord, use only a 3-wire extension cord that has a 3-blade grounding plug and a 3-slot receptacle that will accept the plug on the microwave oven. The marked rating of the extension cord should be AC 115-120 volt, 15 amp. or more.

Be careful not to drape the cord over the countertop or table where it can be pulled on by children or tripped over accidentally.

Notes:

1. If you have any questions about the grounding or electrical instructions, consult a qualified electrician or service person.
2. Neither Sharp nor the dealer can accept any liability for damage to the oven or personal injury resulting from failure to observe the correct electrical connection procedures.

Radio or TV Interference

Should there be any interference caused by the microwave oven to your radio or TV, check that the microwave oven is on a different electrical circuit, relocate the radio or TV as far away from the oven as feasible or check position and signal of receiving antenna.

Permanent and Correct Installation

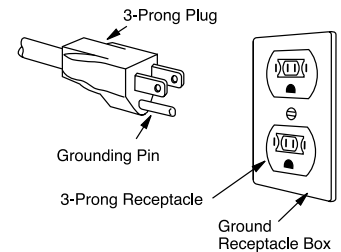

Temporary Use

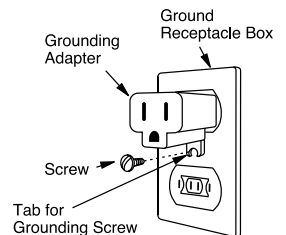

INFORMATION YOU NEED TO KNOW

ABOUT YOUR OVEN

This Operation Manual is valuable: read it carefully and always save it for reference.

A good microwave cookbook is a valuable asset. Check it for microwave cooking principles, techniques, hints and recipes. See pages 15 and 16 for ordering the Ultimate Accessory, the SHARP CAROUSEL MICROWAVE COOKBOOK.

NEVER use the oven without the turntable and support nor turn the turntable over so that a large dish could be placed in the oven. The turntable will turn both clockwise and counterclockwise.

ALWAYS have food in the oven when it is on to absorb the microwave energy.

When using the oven at power levels below 100%, you may hear the magnetron cycling on and off. It is normal

for the exterior of the oven to be warm to the touch when cooking or reheating.

Condensation is a normal part of microwave cooking. Room humidity and the moisture in food will influence the amount of moisture that condenses in the oven. Generally, covered foods will not cause as much condensation as uncovered ones. Vents on the oven back must not be blocked.

The oven is for food preparation only. It should not be used to dry clothes or newspapers.

All ovens are rated by using the IEC-705-1988 method as 1100 watts, except for the R-405C which is 1000 watts. In using recipes or package directions, check food a minute or two before the minimum time and add time accordingly.

ABOUT FOOD

FOOD	DO	DON'T
Eggs, sausages, fruits & vegetables	<ul style="list-style-type: none">• Puncture egg yolks before cooking to prevent "explosion".• Pierce skins of potatoes, apples, squash, hot dogs and sausages so that steam escapes.	<ul style="list-style-type: none">• Cook eggs in shells.• Reheat whole eggs.
Popcorn	<ul style="list-style-type: none">• Use specially bagged popcorn for the microwave oven.• Listen while popping corn for the popping to slow to 1 or 2 seconds or use special POPCORN pad.	<ul style="list-style-type: none">• Pop popcorn in regular brown bags or glass bowls.• Exceed maximum time on popcorn package.
Baby food	<ul style="list-style-type: none">• Transfer baby food to small dish and heat carefully, stirring often. Check temperature before serving.• Put nipples on bottles after heating and shake thoroughly. "Wrist" test before feeding.	<ul style="list-style-type: none">• Heat disposable bottles.• Heat bottles with nipples on.• Heat baby food in original jars.
General	<ul style="list-style-type: none">• Cut baked goods with filling after heating to release steam and avoid burns.• Stir liquids briskly before and after heating to avoid "eruption".• Use deep bowl, when cooking liquids or cereals, to prevent boilovers.	<ul style="list-style-type: none">• Heat or cook in closed glass jars or air tight containers.• Can in the microwave as harmful bacteria may not be destroyed.• Deep fat fry.• Dry wood, gourds, herbs or wet papers.

ABOUT UTENSILS AND COVERINGS

It is not necessary to buy all new cookware. Many pieces already in your kitchen can be used successfully in your new microwave oven. Make sure the utensil does not touch the interior walls during cooking.

Use these utensils for safe microwave cooking and reheating:

- glass ceramic (Pyroceram®), such as Corningware®.
- heat-resistant glass (Pyrex®)
- microwave-safe plastics
- paper plates
- microwave-safe pottery, stoneware and porcelain
- browning dish (Do not exceed recommended preheating time. Follow manufacturer's directions.)

These items can be used for short time reheating of foods that have little fat or sugar in them:

- wood, straw, wicker

DO NOT USE

- metal pans and bakeware
- dishes with metallic trim
- non-heat-resistant glass
- non-microwave-safe plastics (margarine tubs)
- recycled paper products
- brown paper bags
- food storage bags
- metal twist-ties

Should you wish to check if a dish is safe for microwaving, place the empty dish in the oven and microwave on HIGH for 30 seconds. A dish which becomes very hot should not be used.

ABOUT CHILDREN AND THE MICROWAVE

Children below the age of 7 should use the microwave oven with a supervising person very near to them. Between the ages of 7 and 12, the supervising person should be in the same room.

The child must be able to reach the oven comfortably; if not, he/she should stand on a sturdy stool.

At no time should anyone be allowed to lean or swing on the oven door.

The following coverings are ideal:

- Paper towels are good for covering foods for reheating and absorbing fat while cooking bacon.
- Wax paper can be used for cooking and reheating.
- Plastic wrap that is specially marked for microwave use can be used for cooking and reheating. DO NOT allow plastic wrap to touch food. Vent so steam can escape.
- Lids that are microwave-safe are a good choice because heat is kept near the food to hasten cooking.
- Oven cooking bags are good for large meats or foods that need tenderizing. DO NOT use metal twist ties. Remember to slit bag so steam can escape.

How to use aluminum foil in your microwave oven:

- Small flat pieces of aluminum foil placed smoothly on the food can be used to shield areas that are either defrosting or cooking too quickly.
- Foil should not come closer than one inch to any surface of the oven.

Should you have questions about utensils or coverings, check a good microwave cookbook or follow recipe suggestions.

ACCESSORIES There are many microwave accessories available for purchase. Evaluate carefully before you purchase so that they meet your needs. A microwave-safe thermometer will assist you in determining correct doneness and assure you that foods have been cooked to safe temperatures. Sharp is not responsible for any damage to the oven when accessories are used.

Children should be taught all safety precautions: use potholders, remove coverings carefully, pay special attention to packages that crisp food because they may be extra hot.

Don't assume that because a child has mastered one cooking skill he/she can cook everything.

Children need to learn that the microwave oven is not a toy. See page 14 for Child Lock feature.

INFORMATION YOU NEED TO KNOW

ABOUT MICROWAVE COOKING

- Arrange food carefully. Place thickest areas towards outside of dish.
- Watch cooking time. Cook for the shortest amount of time indicated and add more as needed. Food severely overcooked can smoke or ignite.
- Cover foods while cooking. Check recipe or cook-book for suggestions: paper towels, wax paper, microwave plastic wrap or a lid. Covers prevent spattering and help foods to cook evenly.
- Shield with small flat pieces of aluminum foil any thin areas of meat or poultry to prevent overcooking before dense, thick areas are cooked thoroughly.
- Stir foods from outside to center of dish once or twice during cooking, if possible.
- Turn foods over once during microwaving to speed cooking of such foods as chicken and hamburgers. Large items like roasts must be turned over at least once.
- Rearrange foods such as meatballs halfway through cooking both from top to bottom and from the center of the dish to the outside.
- Add standing time. Remove food from oven and stir, if possible. Cover for standing time which allows the food to finish cooking without overcooking.
- Check for doneness. Look for signs indicating that cooking temperatures have been reached.

Doneness signs include:

- Food steams throughout, not just at edge.
- Center bottom of dish is very hot to the touch.
- Poultry thigh joints move easily.
- Meat and poultry show no pinkness.
- Fish is opaque and flakes easily with a fork.

ABOUT SAFETY

- Check foods to see that they are cooked to the United States Department of Agriculture's recommended temperatures.
- ALWAYS use potholders to prevent burns when handling utensils that are in contact with hot food. Enough heat from the food can transfer through utensils to cause skin burns.
- Avoid steam burns by directing steam away from the face and hands. Slowly lift the farthest edge of a dish's covering and carefully open popcorn and oven cooking bags away from the face.
- Stay near the oven while it's in use and check cooking progress frequently so that there is no chance of overcooking food.
- NEVER use the cavity for storing cookbooks or other items.
- Select, store and handle food carefully to preserve its high quality and minimize the spread of foodborne bacteria.
- Keep waveguide cover clean. Food residue can cause arcing and/or fires.
- Use care when removing items from the oven so that the utensil, your clothes or accessories do not touch the safety door latches.

TEMP	FOOD
160°F	... for fresh pork, ground meat, boneless white poultry, fish, seafood, egg dishes and frozen prepared food.
165°F	... for leftover, ready-to-reheat refrigerated, and deli and carry-out "fresh" food.
170°F	... white meat of poultry.
180°F	... dark meat of poultry.

To test for doneness, insert a meat thermometer in a thick or dense area away from fat or bone. NEVER leave the thermometer in the food during cooking, unless it is approved for microwave oven use.

PART NAMES

MICROWAVE OVEN PARTS

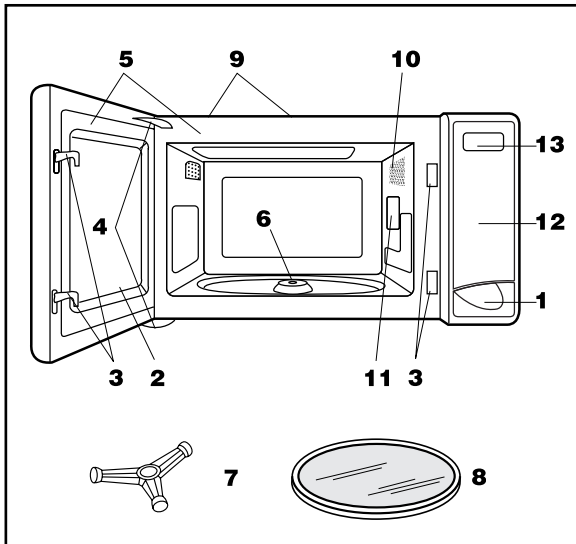

- 1 One touch door open button
Push to open door.
- 2 Oven door with see-through window
- 3 Safety door latches
The oven will not operate unless the door is securely closed.
- 4 Door hinges
- 5 Door seals and sealing surfaces
- 6 Turntable motor shaft
- 7 Removable turntable support
Carefully place the turntable support in the center of the oven floor.
- 8 Removable turntable
Place the turntable on the turntable support securely. The turntable will rotate clockwise or counterclockwise. Only remove for cleaning.
- 9 Ventilation openings (Rear)
- 10 Oven light
It will light when oven is operating or door is open.
- 11 Waveguide cover: DO NOT REMOVE.
- 12 Auto-Touch control panel
- 13 Time display: 99 minutes, 99 seconds

CONTROL PANEL

R-510C / R-410C

Number next to the key panel illustration indicates page on which there are a feature description and usage information.

VISUAL DISPLAY

Words in the lower portion of the display will light to indicate what function is in progress.

BEFORE OPERATING

- Before operating your new microwave oven make sure you read and understand this operation manual completely.
- Before the oven can be used, follow these procedures:
 1. Plug in the oven. Close the door. The oven display will then begin flashing [88:88].
 2. Touch the **Stop/Clear** pad.
[:] will appear.
 3. Set clock.

TO SET THE CLOCK

- Suppose you want to enter the correct time of day 12:30 (A.M. or P.M.).

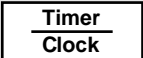
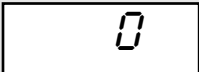
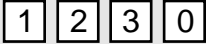
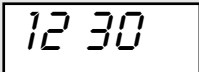
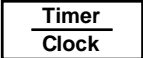
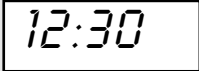
PROCEDURE	DISPLAY
1  Touch Clock pad.	
2  Enter the correct time of day by touching the numbers in sequence.	
3  Touch Clock pad again.	

This is a 12 hour clock. If you attempt to enter an incorrect clock time, [ERROR] will appear in the display. Touch the **Stop/Clear** pad and re-enter the time.

- If the electrical power supply to your microwave oven should be interrupted, the display will intermittently show [88:88] after the power is reinstated. If this occurs during cooking, the program will be erased. The time of day will also be erased. Simply touch **Stop/Clear** pad and reset the clock for the correct time of day.

NOTE: Your oven can be programmed with the door open except for START, MINUTE PLUS and INSTANT ACTION.

STOP/CLEAR

Touch the **Stop/Clear** pad to:

1. Erase if you make a mistake during programming.
2. Cancel timer.
3. Stop the oven temporarily during cooking.
4. Return the time of day to the display.
5. Cancel a program during cooking, touch twice.

MANUAL OPERATION

TIME COOKING

Your oven can be programmed for 99 minutes 99 seconds (99.99). Always enter the seconds after the minutes, even if they are both zeros.

- Suppose you want to cook for 5 minutes at 100%.

PROCEDURE	DISPLAY
1 [5] [0] [0] Enter cooking time.	5 00
2 [START] Touch START pad.	5.00 <small>COOK</small>

TO SET POWER LEVEL

There are eleven preset power levels.

Using lower power levels increases the cooking time which is recommended for foods such as cheese, milk and long slow cooking of meats. Consult cookbook or recipes for specific recommendations.

TOUCH POWER LEVEL PAD ONCE THEN TOUCH	APPROXIMATE PERCENTAGE OF POWER	COMMON WORDS FOR POWER LEVELS
Power Level	100%	High
9	90%	
8	80%	
7	70%	Medium High
6	60%	
5	50%	Medium
4	40%	
3	30%	Med Low/Defrost
2	20%	
1	10%	Low
0	0%	

- Suppose you want to defrost for 5 minutes at 30%.

PROCEDURE	DISPLAY
1 [5] [0] [0] Enter defrosting time.	5 00
2 [Power Level] Touch Power Level pad.	P-
3 [3] Enter power level.	P-30
4 [START] Touch START pad.	5.00 <small>COOK</small>

MANUAL DEFROST

If the food that you wish to defrost is not listed on the COMPU DEFROST CHART or is above or below the limits in the "Amount" column on the COMPU DEFROST CHART (see page 12), you need to defrost manually.

You can defrost any frozen food, either raw or previously cooked, by using Power Level 3. Follow the exact 4-step procedure found under Time Cooking in next column. Estimate defrosting time and press [3] for 30% when you select the power level.

For either raw or previously cooked frozen food the rule of thumb is approximately 4 minutes per pound. For example, defrost 4 minutes for 1 pound of frozen spaghetti sauce.

Always stop the oven periodically to remove or separate the portions that are defrosted. If food is not defrosted at the end of the estimated defrosting time, program the oven in 1 minute increments on Power Level 30% until totally defrosted.

When using plastic containers from the freezer, defrost only long enough to remove from the plastic in order to place in a microwave-safe dish.

SPECIAL FEATURES

INSTANT ACTION

Instant Action allows you to cook or reheat many of your favorite foods by touching just one pad.

- Suppose you want to cook 3 medium baked potatoes.

PROCEDURE

1

Baked Potatoes

x 3

Select desired setting. Touch **Baked Potatoes** pad. The oven starts automatically.

To use any pad, touch within 1 minute after cooking,

opening and closing the door or touching the Stop/Clear pad.

To increase quantity, touch chosen pad until number in display is same as desired quantity to cook. Ex: touch Baked Potatoes three times for three baked potatoes.

TIP: Foods can be covered with wax paper or vented plastic wrap. Temperatures of foods covered with plastic wrap tend to be slightly higher than those covered with wax paper.

NOTE: Instant Action can be programmed with More or Less Time Adjustment. See page 13.

INSTANT ACTION CHART

FOOD	AMOUNT	PROCEDURE
POPCORN		This setting works well with most brands of microwave popcorn. You may wish to try several and choose your favorite. Pop only one bag at a time. Unfold bag and place in oven according to directions.
	3.5 oz bag	Touch POPCORN once for regular. REG .
	3.0 or 3.5 oz bag (Light)	Touch POPCORN twice within 2 seconds for light regular. L-REG .
	1.75 oz	Touch POPCORN three times within 3 seconds for snack. SNK .
	1.5 or 1.75 oz (Light)	Touch POPCORN pad four times within 4 seconds for light snack. L-SNK .
BEVERAGE	.5-2.0 cups	This setting is good for restoring cooled beverage to a better drinking temperature. Stir after heating. Stir liquid briskly before and after heating to avoid "eruption".
Dinner plate	1 plate	Use this pad to reheat precooked foods from the refrigerator. Place meaty portions and bulky vegetables to outside of plate. Cut large items like baked potatoes in smaller pieces. Flatten foods such as mashed potatoes and other dense foods. Cover with wax paper or plastic wrap. ONE PLATE ONLY. After cooking, check that food is very hot throughout and that the bottom center of the plate is very hot. If not, continue heating using time and power level. Allow to stand, covered, 1 to 2 minutes.
	1 Regular	Touch Dinner plate once for a regular amount of food: approximately 4 oz sliced meat or poultry, 1/2 cup potato or rice and 1/2 cup of vegetables or equivalent. REG will appear in the display.
	1 Large	Touch Dinner plate twice within 2 seconds for a larger amount of food on a dinner plate. LARGE will appear in the display.
	1 Small	Touch Dinner plate three times within 3 seconds for a smaller amount of food on a dinner plate. SMALL will appear in the display.
Casserole	1-6 cups * 1-8 cups **	Use this pad to reheat refrigerated canned or homemade pasta with sauce or other cooked casserole. For room temperature pasta or casserole, use Less option (see page 13). For pasta without sauce double the quantity per setting. For example, measure 2 cups of cooked noodles and program for 1 cup. Cover with lid or plastic wrap. After cooking, let stand, covered, 2 to 3 minutes.

SPECIAL FEATURES

INSTANT ACTION CHART (continued)

FOOD	AMOUNT	PROCEDURE												
Rolls/ muffins	1-8 * 1-10 **	Use this pad to warm rolls, muffins, biscuits, bagels etc. Large items should be considered as 2 or 3 regular size. Arrange on plate; cover with paper towel. For refrigerated rolls or muffins, it may be necessary to double the entered amount to ensure the proper serving temperature. For example, enter quantity of 2 for 1 refrigerated muffin. For frozen rolls/muffins, enter quantity and then touch Power Level once for FROZ . Large items should be considered as 2 or 3 regular size. Arrange on plate; cover with paper towel.												
Baked potatoes	1-6 medium * 1-8 medium **	Pierce with fork in several places; place on paper towel on turntable. At end of cooking time, remove from oven, wrap in foil and let stand 10 minutes.												
Fresh vegetables	1-6 cups * 1-8 cups **	For beans, carrots, corn and peas, add 1 tablespoon of water per cup. For broccoli, Brussels sprouts, cabbage and cauliflower, cook immediately after washing with no additional water. If you like tender crisp vegetables, double or triple measured quantity per setting. For example, use 2 cups or 3 cups of zucchini but touch Fresh vegetables only once. After cooking, remove from oven, stir, cover and let stand 3 to 5 minutes before serving.												
Ground meat	.3-2.0 lb	Use this setting to cook ground beef or poultry as patties or in a casserole to be added to other ingredients. Place patties on a microwave-safe rack and cover with wax paper. Place ground meat in a casserole and cover with wax paper or plastic wrap. When oven stops, turn patties over or stir meat in casserole to break up large pieces. Re-cover and touch START . After cooking, let stand, covered, for 2 to 3 minutes. <table border="1" style="margin-left: auto; margin-right: auto;"> <thead> <tr> <th>Press the key</th> <th>Amount</th> </tr> </thead> <tbody> <tr> <td>Once</td> <td>0.3 lb</td> </tr> <tr> <td>Twice</td> <td>0.5 lb</td> </tr> <tr> <td>3 times</td> <td>1.0 lb</td> </tr> <tr> <td>4 times</td> <td>1.5 lb</td> </tr> <tr> <td>5 times</td> <td>2.0 lb</td> </tr> </tbody> </table>	Press the key	Amount	Once	0.3 lb	Twice	0.5 lb	3 times	1.0 lb	4 times	1.5 lb	5 times	2.0 lb
Press the key	Amount													
Once	0.3 lb													
Twice	0.5 lb													
3 times	1.0 lb													
4 times	1.5 lb													
5 times	2.0 lb													
Frozen entrees	6-17 oz 6-8 oz 9-11 oz 12-14 oz 15-17 oz	Use this pad for frozen, convenience foods. It will give satisfactory results for most brands. You may wish to try several and choose your favorite. Remove package from outer wrapping and follow package directions for covering. After cooking, let stand, covered, for 1 to 3 minutes. Touch Frozen entrees once for package weight of 6-8 oz, 6-8 will appear in the display. Touch Frozen entrees twice for package weight of 9-11 oz, 9-11 will appear in the display. Touch Frozen entrees three times for package weight of 12-14 oz, 12-14 will appear in the display. Touch Frozen entrees four times for package weight of 15-17 oz, 15-17 will appear in the display.												
Frozen vegetables	1-6 cups * 1-8 cups **	Add no water. Cover with lid or plastic wrap. After cooking, stir and let stand, covered, for 3 minutes												
Microwave pizza	1	Use frozen microwave pizza. Follow package directions for placing pizza on special crisping susceptor.												



NOTE: The symbol * for model number R-410C only.
The symbol ** for model number R-510C only.

SPECIAL FEATURES

COMPU DEFROST

CompuDefrost automatically defrosts ground meat, steaks, chops and chicken pieces.

- Suppose you want to defrost a 2.0 pound steak .

PROCEDURE	DISPLAY
<p>1 COMPU DEFROST x 2</p> <p>Select desired food by touching COMPU DEFROST pad until the display shows the desired food number. (Ex: touch twice for Steak.)</p>	
<p>2 2 0</p> <p>Enter weight by touching the number pads 2 and 0 . (Ex: 2.0 lb steak.)</p>	
<p>3 START</p> <p>Touch START pad. Note that count down time varies for each model.</p>	
<p>The oven will stop so the food can be checked.</p>	

4 After the 1st stage, open the door.
Turn steak over and shield any warm portions.
Close the door.
Touch **START** pad.

START

5 After the 2nd stage, open the door. Shield any warm portions. Close the door.
Touch **START** pad.

START

6 After defrost cycle ends, cover and let stand as indicated in chart below.

NOTE:

1. To defrost other food or foods above or below the weights allowed on the COMPU DEFROST Chart, use time and 30% power. See Manual Defrost on page 9.
2. Power Level can be inputted within 2 seconds for more or less function. Display will indicate the following before operation starts. **MORE** or **LESS** .
3. If an incorrect weight is entered, **ERROR** will be displayed.

COMPU DEFROST CHART

TOUCH COMPU DEFROST PAD	FOOD	FOR AMOUNT	PROCEDURE
once	Ground Meat	.5 - 3.0 lb (.2 - 1.4 kg)	Remove any thawed pieces after each stage. Let stand, covered, for 5 to 10 minutes.
twice	Steaks/Chops (fish)	.5 - 4.0 lb (.2 - 1.8 kg)	After each stage of defrost cycle, rearrange and if there are warm or thawed portions, shield with small flat pieces of aluminum foil. Remove any meat or fish that is nearly defrosted. Let stand, covered, for 10 to 20 minutes.
3 times	Chicken Pieces	.5 - 3.0 lb (.2 - 1.4 kg)	After each stage of defrost cycle, if there are warm or thawed portions, rearrange or remove. Let stand, covered, for 10 to 20 minutes.

NOTE: Check foods when oven signals. After final stage, small sections may still be icy. Let stand to continue thawing. Do not defrost until all ice crystals are thawed. Shielding prevents cooking from occurring before the center of the food is defrosted. Use small smooth strips of aluminum foil to cover edges and thinner sections of the food.

OTHER CONVENIENT FEATURES

MULTIPLE SEQUENCE COOKING

Your oven can be programmed for up to 3 automatic cooking sequences, switching from one power level setting to another automatically.

Sometimes cooking directions tell you to start on one power level and then change to a different power level. Your oven can do this automatically.

- Suppose you want to cook roast beef for 5 minutes at 100% and then continue to cook for 30 minutes at 50%.

PROCEDURE	
1	First enter cooking time. Then touch Power Level pad twice for 100% power.
2	Then enter second cooking time. Touch Power Level pad. Touch number pad 5 for 50% power.
3	Touch START pad.

NOTE:

1. If Power Level pad is touched twice, will be displayed.
2. If 100% is selected as the final sequence, it is not necessary to touch the Power Level pad.
3. If you wish to know power level, simply touch the **Power Level** pad. As long as your finger is touching the Power Level pad, the power level will be displayed.

TIMER

- Suppose you want to time a 3 minute long distance phone call.

PROCEDURE	
1	Enter time.
2	Touch Timer pad.

MORE OR LESS TIME ADJUSTMENT

Should you discover that you like any of the Instant Action or CompuDefrost settings slightly **more** done, touch the **Power Level** pad **once** after touching your choice of pads.

The display will show .

Should you discover that you like any of the Instant Action or CompuDefrost settings slightly **less** done, touch the **Power Level** pad **twice** after touching your choice of pads.

The display will show .

The Power Level pad must be touched within 1 second of touching your choice of pads.

MINUTE PLUS

Minute Plus allows you to cook for a minute at 100% by simply touching the **MINUTE PLUS** pad. You can also extend cooking time in multiples of 1 minute by repeatedly touching the **MINUTE PLUS** pad during manual cooking.

- Suppose you want to heat a cup of soup for one minute.

PROCEDURE	
1	Touch MINUTE PLUS pad.

NOTE:

1. To use Minute Plus, touch pad within 1 minute after cooking, closing the door, touching the **Stop/Clear** pad or during cooking.
2. Minute Plus cannot be used with special features.

AUDIBLE SIGNAL ELIMINATION

If you wish to have the oven operate with no audible signals, touch **Timer/Clock**, the number and then touch **START** pad and hold for three seconds.

To cancel and restore the audible signal, touch **Timer/Clock** pad, the number and **Stop/Clear** pad.

OTHER CONVENIENT FEATURES

CHILD LOCK

The Child Lock prevents unwanted oven operation such as by small children.

The oven can be set so that the control panel is deactivated or locked. To set, touch **Timer/Clock** pad, the number **1** and then touch **START** pad and hold for three seconds. Should a pad be touched, **LOCK** will appear in the display.

To cancel, touch **Timer/Clock** pad, the number **1** and **Stop/Clear** pad.

DEMONSTRATION MODE

To demonstrate, touch **Timer/Clock** pad, **0** and then touch **START** pad and hold for three seconds. **DEMO** will appear in the display. Cooking operations and specific special features can now be demonstrated with no power in the oven. For example, touch **MINUTE PLUS** pad and the display will show **1:00** and count down quickly to **0** and the **END**.

To cancel, touch **Timer/Clock** pad, then **0** and **Stop/Clear** pad.

CLEANING AND CARE

Exterior

The outside surface is painted. Clean the outside with mild soap and water; rinse and dry with a soft cloth. Do not use any type of household or abrasive cleaner.

Door

Wipe the window on both sides with a damp cloth to remove any spills or splatters. Metal parts will be easier to maintain if wiped frequently with a damp cloth. Avoid the use of spray and other harsh cleaners as they may stain, streak or dull the door surface.

Touch Control Panel

Care should be taken in cleaning the touch control panel. If the control panel becomes soiled, open the oven door before cleaning. Wipe the panel with a cloth dampened slightly with water only. Dry with a soft cloth. Do not scrub or use any sort of chemical cleaners. Close door and touch **Stop/Clear**.

Interior

Cleaning is easy because little heat is generated to the interior surfaces; therefore, there is no baking and setting of spills or spattering. To clean the interior surfaces, wipe with a soft cloth and warm water. **DO NOT USE ABRASIVE OR HARSH CLEANERS OR SCOURING PADS.** For heavier soil, use baking soda or a mild soap; rinse thoroughly with hot water.

Waveguide Cover

The waveguide cover is made from mica so requires special care. Keep the waveguide cover clean to assure good oven performance. Carefully wipe with a damp cloth any food splatters from the surface of the cover immediately after they occur. Built-up splashes may overheat and cause smoke or possibly catch fire. Do not remove the waveguide cover.

Odor Removal

Occasionally, a cooking odor may remain in the oven. To remove, combine 1 cup water, grated peel and juice of 1 lemon and several whole cloves in a 2-cup glass measuring cup. Boil for several minutes using 100% power. Allow to set in oven until cool. Wipe interior with a soft cloth.

Turntable/Turntable Support

The turntable and turntable support can be removed for easy cleaning. Wash them in mild, sudsy water; for stubborn stains use a mild cleanser and scouring sponge as described above. They are also dishwasher-proof. Use upper rack of dishwasher. The turntable motor shaft is not sealed, so excess water or spills should be wiped up immediately.

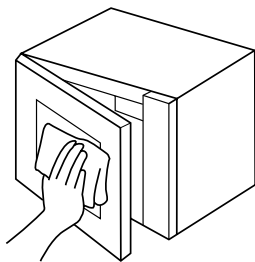

Exterior

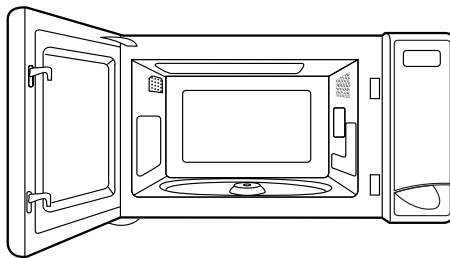

Interior



Turntable

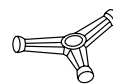

Turntable Support

SERVICE CALL CHECK

Please check the following before calling for service:

Place one cup of water in a glass measuring cup in the oven and close the door securely.
Operate the oven for one minute at HIGH 100%.

- A Does the oven light come on? YES _____ NO _____
- B Does the cooling fan work?
(Put your hand over the rear ventilating openings.) YES _____ NO _____
- C Does the turntable rotate?
(It is normal for the turntable to turn in either direction.) YES _____ NO _____
- D Is the water in the oven warm? YES _____ NO _____

If "NO" is the answer to any of the above questions, please check electrical outlet, fuse and/or circuit breaker. If they are functioning properly, CONTACT YOUR NEAREST SHARP AUTHORIZED SERVICER. A microwave oven should never be serviced by a "do-it-yourself" repair person.

NOTE: If time appearing in the display is counting down very rapidly, check Demonstration Mode on page 14 and cancel.

THE ULTIMATE ACCESSORY

- ★ Great recipes
- ★ Reliable microwave reference guide
- ★ Many color photos
- ★ Step-by-step instructions
- ★ Nutritional information for each recipe
- ★ Durable wipe-clean soft cover with 128 8 1/2 x 11 pages
- ★ Helpful tips and special techniques

SHARP® CAROUSEL MICROWAVE COOKBOOK

TO ORDER

Simply call this toll-free number : **1-800-642-2122**.
Please have your credit card ready.

If you prefer to order by mail, complete and return the order form on page 16. Please include check or money order (payable to Sharp Accessories & Supplies Center) for \$6.00 plus \$4.25 shipping & handling and tax, if applicable, per book.

SATISFACTION GUARANTEED

You must be completely satisfied with the Sharp Carousel Microwave Cookbook. If, within 14 days, you are dissatisfied for any reason, simply return the book and we'll gladly refund your \$6.00 plus tax.

(SOLAMENTE ESCRITO EN INGLES!)

SPECIFICATIONS

	R-510C	R-410C
AC Line Voltage:	Single phase 120V, 60Hz, AC only	Single phase 120V, 60Hz, AC only
AC Power Required:	1650 watts, 14.0 amps.	1650 watts, 14.0 amps.
Output Power: Microwave	1100 watts* (IEC-705-1988 Test Procedure)	1100 watts* / R-405C : 1000 watts (IEC-705-1988 Test Procedure)
Frequency:	2450 MHz	2450 MHz
Outside Dimensions:	24"(W) x 13 ³ / ₈ "(H) x 19 ¹ / ₈ "(D)	21 ¹¹ / ₁₆ "(W) x 12 ³ / ₈ "(H) x 17 ³ / ₈ "(D)
Cavity Dimensions:	17 ³ / ₈ "(W) x 10 ¹ / ₂ "(H) x 18 ⁵ / ₈ "(D)	15"(W) x 9 ⁷ / ₁₆ "(H) x 16 ³ / ₄ "(D)
Oven Capacity:	2.0 Cu. Ft.	1.4 Cu. Ft.
Cooking Uniformity:	Turntable system	Turntable system
Weight:	Approx. 46 lb	Approx. 40 lb

★ The International Electrotechnical Commission's standardized method for measuring output wattage. This test method is widely recognized.

In compliance with standards set by:

FCC – Federal Communications Commission Authorized.

DHHS – Complies with Department of Health and Human Services (DHHS) rule, CFR, Title 21, Chapter I, Subchapter J.



– This symbol on the nameplate means the product is listed by Underwriters Laboratories, Inc.

Cut along this line.

COOKBOOK ORDER FORM

Please send me _____ cookbooks at \$10.25 each \$ _____

Illinois sales tax, (if applicable) per book \$.44 no. of books _____ \$ _____

TOTAL ORDER AMOUNT \$ _____

I have enclosed a check made payable to Sharp Accessories & Supplies Center.

Please bill my VISA MASTERCARD AMERICAN EXPRESS

Acct. No. _____ Expiration date ____ / ____

Signature _____

(All credit card orders must be signed.)

Name _____

Address _____

City _____ State _____ Zip _____

Daytime Phone No. () _____

Mail to: SHARP Accessories & Supplies Center
2130 Townline Road
Peoria, Illinois 61615-1560

Price is subject to change without notice.

REHEATING CHART

ITEM	STARTING TEMPERATURE	MICROWAVE TIME	PROCEDURE
Plate of Food 1 serving of meat, 2 servings of vegetables	Room temp. Refrigerated	MED.-HIGH (70%) 1 1/2-2 3/4 min. 2 3/4-4 min.	Meaty portions and bulky vegetables to outside. Cover with wax paper.
Meat (Chicken pieces, chops, hamburgers, meat loaf slices) 1 serving 2 servings	Refrigerated Refrigerated	MED.-HIGH (70%) 1-2 min. 2-4 min.	Cover loosely with wax paper.
Meat Slices (Beef, ham, pork, turkey) 1 or more servings	Room temp. Refrigerated	MEDIUM (50%) 1-1 3/4 min. per serving 1 1/2-2 1/2 min. per serving	Cover with gravy or wax paper. Check after 30 sec. per serving.
Stirrable Casseroles and Main Dishes 1 serving 2 servings 4-6 servings	Refrigerated Refrigerated Refrigerated	HIGH (100%) 2 3/4-3 1/2 min. 5 - 6 3/4 min. 9 -10 min.	Cover with plastic wrap. Stir after half the time.
Nonstirrable Casseroles and Main Dishes 1 serving 2 servings 4-6 servings	Refrigerated Refrigerated Refrigerated	MEDIUM (50%) 4 1/2-7 1/2 min. 7 1/2-11 min. 12-15 min.	Cover with wax paper.
Soup, Cream 1 cup 1 can (10 3/4 oz)	Refrigerated Room temp.	MEDIUM (50%) 2-5 1/2 min. 5-7 1/2 min.	Cover. Stir after half the time.
Soup, Clear 1 cup 1 can (10 3/4 oz)	Refrigerated Room temp.	HIGH (100%) 2-3 min. 3 1/2-7 min.	Cover. Stir after half the time.
Pizza 1 slice 1 slice 2 slices 2 slices	Room temp. Refrigerated Room temp. Refrigerated	HIGH (100%) 15-25 sec. 25-35 sec. 25-35 sec. 55-60 sec.	Place on paper towel on microwave-safe rack.
Vegetables 1 serving 2 servings	Refrigerated Refrigerated	HIGH (100%) 3/4-1 1/4 min. 1 1/2-2 min.	Cover. Stir after half the time.
Baked Potato 1 2	Refrigerated Refrigerated	HIGH (100%) 1-2 1/2 min. 2 1/2-3 min.	Cut potato lengthwise and then several times crosswise. Cover with wax paper.
Breads (Dinner or breakfast roll) 1 roll 2 rolls 4 rolls	Room temp. Room temp. Room temp.	HIGH (100%) 10-12 sec. 15-18 sec. 25-30 sec.	Wrap single roll, bagel or muffin in paper towel. To reheat several, line plate with paper towel; cover with another paper towel.
Pie 1 slice 2 slices	Refrigerated Refrigerated	HIGH (100%) 30-45 sec. 1-1 1/2 min.	Place on microwave-safe dish. Do not cover.

After reheating, food should be very hot-165°F, if possible, stir food, cover and allow to stand two to three minutes before serving.

VEGETABLE COOKING CHART

VEGETABLE	AMOUNT	COOKING PROCEDURE	MICROWAVE TIME AT HIGH (100%)	STANDING TIME, COVERED
Artichokes Fresh	2 medium	Trim and rinse. 2-qt casserole. 2 tbsp water. Cover with plastic wrap.	5-8 min.	5 min.
Asparagus Fresh Spears	1 lb	2-qt casserole. 2 tbsp water. Cover. Rearrange after 3 min.	4-7 min.	2 min.
Beans Fresh, Green and Wax	1 lb	1 1/2-in pieces, 2-qt casserole. 1/4 cup water. Cover. Stir twice.	9-13 min.	2 min.
Beets Fresh, Whole	5 medium	Wash. Leave 1 inch of tops. 2-qt casserole. 1/4 cup water. Cover. Stir every 5 min.	12-18 min.	3 min.
Broccoli Fresh, Spears	1 lb	Wash. 2-qt casserole. Add no water. Cover. Rearrange after 3 min. Uncover during stand.	6-8 min.	3 min. uncovered
Fresh, Pieces	1 lb	Wash. 2-qt casserole. Add no water. Cover. Stir after 3 min. Uncover during stand.	5-7 min.	2 min. uncovered
Brussels Sprouts Fresh	4 cups	2-qt casserole. 1/4 cup water. Cover. Stir after 2 min.	6-8 min.	3 min.
Cabbage Shredded	1 lb	2-qt casserole. 2 tbsp water. Cover. Stir, after 4 min.	8-12 min.	2 min.
Wedges	1 lb	2-qt casserole. 2 tbsp water. Cover. Rearrange after 5 min.	12-14 min.	3 min.
Carrots Fresh, Slices	2 cups	1-qt casserole, 2 tbsp water. Cover. Stir after 3 min.	5-8 min.	3 min.
Cauliflower Fresh, Flowerets	2 cups	1-qt casserole. 1 tbsp water. Cover. Stir after 2 min.	3-5 min.	2 min.
Fresh, Whole	1 1/2 lb	Remove leaves and core center. 2-qt casserole. 2 tbsp water. Cover.	7-9 min.	3 min.
Corn Fresh, on Cob	2 ears	9-in pie plate. 2 tbsp water. Cover. Rearrange after 4 min.	6-9 min.	5 min.
	4 ears	2-qt oval or rectangular casserole. 1/4 cup water. Cover.	12-14 min.	5 min.
Frozen, on Cob	2 ears	9-in pie plate. 2 tbsp water. Cover. Rearrange after 4 min.	6-8 min.	5 min.
	4 ears	2-qt oval or rectangular casserole. 1/4 cup water. Cover.	10-12 min.	5 min.

VEGETABLE COOKING CHART (continued)

VEGETABLE	AMOUNT	COOKING PROCEDURE	MICROWAVE TIME AT HIGH (100%)	STANDING TIME, COVERED
Peas, Green Fresh	2 cups	1-qt casserole. 1/4 cup water. Cover. Stir after 3 min.	4-6 min.	3 min.
Potatoes Boiled	4 medium	Peel and quarter potatoes. 2-qt casserole. Cover. Stir after 5 min.	9-12 min.	3 min.
Spinach Fresh	1 lb	Wash and trim. Add no water. 3-qt casserole. Cover. Stir after 3 min.	5-7 min.	2 min.
Squash Fresh, Acorn	1 whole	Prick; place on paper towel. Turn over after 4 min. 1-qt casserole. Add no water. Cover. Stir after 2 min.	7-10 min.	5 min.
Fresh, Sliced Zucchini	2 cups	1-qt casserole. Add no water. Cover.	2-4 min.	1 min.
Sweet Potatoes Baked	2 medium 4 medium	Prick; place on paper towels. Turn over, rearrange after 5 min.	5-9 min. 10-13 min.	5 min. 5 min.
Tomatoes Fresh	2 medium 4 medium	Halve tomatoes. Round dish. Cover. Rearrange once.	2-4 min. 5-8 min.	2 min. 2 min.
Canned Vegetables	15 to 16 oz	1-qt casserole. Drain all but 2 tbsp liquid. Stir once.	2-4 min.	2 min.

POULTRY ROASTING CHART

CUT	COOKING PREPARATION	MICROWAVE PROCEDURE	INTERNAL TEMP. AT REMOVAL	INTERNAL TEMP. AFTER STANDING
CHICKEN				
Whole	Breast side down on rack. Cover with plastic wrap. Turn over halfway through cooking time.	MED.-HIGH (70%) 5-8 min. per lb	170°F	180°F
Pieces	Rack. Cover with plastic wrap. Turn over halfway through cooking time.	HIGH (100%) 5-7 1/2 min. per lb 4-7 min. per lb	170°F 160°F	180°F 170°F
TURKEY				
Whole (up to 10 lb)	Breast side down on rack. Cover with plastic wrap. Turn over halfway through cooking time.	MED. (50%) 10-14 min. per lb	170°F	180°F
Breast	Rack. Cover with plastic wrap. Turn over halfway through cooking time.	MED. (50%) 11-15 min. per lb 14-18 min. per lb	160°F 160°F	170°F 170°F

MEAT ROASTING CHART

CUT	COOKING PREPARATION	MICROWAVE TIME	INTERNAL TEMP. AT REMOVAL	INTERNAL TEMP. AFTER STANDING
BEEF				
Chuck or Pot Roast (cook in 1/2 cup liquid) (2-3 lb)	Large covered casserole. Turn over halfway through cooking time.	MED. (50%)	150°F	160°F
Without vegetables		21-24 min. per lb		
With 3-4 cups cut-up vegetables		27-30 min. per lb		
Eye of Round (2-3 lb)	Rack. Cover with plastic wrap. Turn over halfway through cooking time.	MED. (50%) Rare: 5-8 min. per lb Med: 7-10 min. per lb Well: 9-11 min. per lb	120°F 135°F 150°F	130°F 145°F 160°F
Ground Meat (to brown for casserole)	Casserole. Cover with plastic wrap. Stir halfway through cooking time.	HIGH (100%) 3 1/2-5 min. per lb	155°F	160°F
Hamburgers (1/4 lb each) 2 patties 4 patties	Rack. Cover with wax paper. Turn over halfway through cooking time.	HIGH (100%) 2 1/4-3 1/2 min. 3 1/2-5 min.		
PORK				
Loin Roast	Meat roasting rack. Cover with plastic wrap.	MED.-HIGH (70%) 7-11 min. per lb	160°F	170°F
Boneless	Turn over halfway through cooking time.	MED. (50%) 12-14 min. per lb	160°F	170°F
Bacon 2 slices 4 slices 6 slices	Place bacon between paper towels on paper plate or on a rack.	HIGH (100%) 1 1/2-2 min. 2 1/2-3 1/2 min. 3 1/2-4 1/2 min.		
Smoked Ham Canned Butt Shank	Casserole. Cover with plastic wrap. Turn over halfway through cooking time. Drain and shield if necessary.	MED. (50%) 5-8 min. per lb 8-11 min. per lb	130°F 130°F	135°F 135°F

FISH AND SEAFOOD COOKING CHART

CUT	COOKING PREPARATION	MICROWAVE PROCEDURE	STANDING TIME
FILLETS	Pie plate or casserole. Cover with plastic wrap.	POWER LEVEL (80%) 4-6 min. per lb	3 min.
STEAKS	Pie plate or casserole. Cover with plastic wrap. Turn over halfway through cooking time.	POWER LEVEL (80%) 5-7 min. per lb	3 min.
SHRIMP & SCALLOPS	Pie plate or casserole. Cover with plastic wrap. Turn over halfway through cooking time.	POWER LEVEL (80%) 4-6 min. per lb	1-2 min.

GUIA AUTO-TOUCH^{MD}

Para mayor informacion y precauciones de seguridad, consulte el Manual de Operaciones

PONER LA HORA

Si aparece **88:88** en la pantalla, primero oprima "Stop/Clear".

1. Oprima **Timer/Clock**.
2. Ponga la hora correcta del día oprimiendo los números en secuencia (Ej: 12:30).
3. Oprima **Timer/Clock** otra vez.

**Timer
Clock**

1 2 3 0

**Timer
Clock**

FUNCION INSTANTANEA ACTION

1. Oprima "POPCORN" una vez para el tamaño normal de palomitas.
2. 2 Veces para el tamaño normal "light".
3. 3 Veces para el tamaño botana.
4. 4 Veces para el tamaño botana "light".

POPCORN

OPERACION MANUAL

Cocimiento con Alta Energia.

1. Marque el tiempo de cocimiento al oprimir los números. (Ej: 1 min. 30 sec.)
2. Oprima el **START**.

1 3 0

START

Energia de Cocimiento Variable.

1. Después de realizar el primer paso (Num. 1 arriba), oprima el Power Level.
2. Elija el grado de energia. (Ejemplo: 50%).
3. Oprima el **START**.

**Power
Level**

5

START

COMPU DEFROST

1. Seleccione el alimento deseado, tocando el **COMPU DEFROST** hasta que la pantalla presente el número del alimento deseado. (Ex: toque dos veces para bistec)
2. Oprima los números correspondientes **2** y **0**. (Ej: 2,0 libras [0,900 kg])
3. Oprima **START**. Al descongelar, el horno se detiene y revisa la comida. Oprima **START** para seguir descongelando.

**COMPU
DEFROST**

2 0

START

Tipo de Comida	Cantidad	
	R-410C	R-510C
Babida	,5 a 2,0 tazas	,5 a 2,0 tazas
Plato de comida	1 plato: Normal, Grande o Pequeño	1 plato: Normal, Grande o Pequeño
Cacerola	1 a 6 tazas	1 a 8 tazas
Pan	1 a 8	1 a 10
Papa asada	1 a 6 tam. Nor.	1 a 8 tam. Nor.
Verdura fresca	1 a 6 tazas	1 a 8 tazas
Carne molida	,3 a 2,0 libras	,3-2,0 libras
Platos congelado	6 a 17 onzas	6 a 17 onzas
Verdura congelado	1 a 6 tazas	1 a 8 tazas
Pizza congelado	1	1

TABLA COMPU DEFROST

Tipo de Comida	Cantidad
1. Carne Molida	,5 a 3,0 libras
2. Filete/Chuleta	,5 a 4,0 libras
3. Trozos de Pollo	,5 a 3,0 libras

MINUTO EXTRA

Oprima **MINUTE PLUS** para obtener un minuto al 100% de energia o para agregar otro minuto durante el cocimiento manual. Vuelva a oprimirlo para obtener minutos adicionales.

**MINUTE
PLUS**

AUTO-TOUCH® GUIDE

For more complete information and safety precautions, refer to your Operation Manual.

SET CLOCK		MANUAL OPERATION																																												
<p>If 88:88 is in the display, first touch Stop/Clear.</p> <ol style="list-style-type: none"> Touch Timer/Clock pad. Enter correct time of the day by touching numbers in sequence. (Ex: 12:30) Touch Timer/Clock pad again. 	<div style="border: 1px solid black; padding: 5px; margin: 5px auto; width: 80px;">Timer Clock</div> <div style="display: flex; justify-content: center; gap: 5px; margin: 5px 0;"> 1 2 3 0 </div> <div style="border: 1px solid black; padding: 5px; margin: 5px auto; width: 80px;">Timer Clock</div>	<p>High Power Cooking.</p> <ol style="list-style-type: none"> Enter cooking time by touching number pads. (Ex: 1 min. 30 sec.) Touch START pad. <p>Variable Power Cooking.</p> <ol style="list-style-type: none"> After Step 1 above, touch Power Level pad. Select power level. (Example: 50%). Touch START pad. 	<div style="display: flex; justify-content: center; gap: 5px; margin-bottom: 10px;"> 1 3 0 </div> <div style="border: 1px solid black; padding: 5px; margin: 5px auto; width: 80px;">START</div> <div style="border: 1px solid black; padding: 5px; margin: 5px auto; width: 80px;">Power Level</div> <div style="display: flex; justify-content: center; gap: 5px; margin-bottom: 10px;"> 5 </div> <div style="border: 1px solid black; padding: 5px; margin: 5px auto; width: 80px;">START</div>																																											
INSTANT ACTION		COMPU DEFROST																																												
<ol style="list-style-type: none"> Touch POPCORN pad once for regular. Twice — light regular size. 3 times — snack size. 4 times — light snack size. 	<div style="border: 1px solid black; padding: 5px; margin: 5px auto; width: 80px;">POPCORN</div>	<ol style="list-style-type: none"> Select desired food by touching COMPU DEFROST pad until the display shows the desired food number. (Ex: touch twice for Steak.) Touch the number pads 2 and 0. (Ex: 2.0 lb steak.) Touch START pad. During defrosting, oven will stop, check food. Touch START to continue defrosting. 	<div style="border: 1px solid black; padding: 5px; margin: 5px auto; width: 80px;">COMPU DEFROST</div> <div style="display: flex; justify-content: center; gap: 5px; margin-bottom: 10px;"> 2 0 </div> <div style="border: 1px solid black; padding: 5px; margin: 5px auto; width: 80px;">START</div>																																											
<table border="1" style="width: 100%; border-collapse: collapse;"> <thead> <tr> <th rowspan="2" style="width: 20%;">Food</th> <th colspan="2" style="text-align: center;">Amount</th> </tr> <tr> <th style="width: 30%;">R-410C</th> <th style="width: 30%;">R-510C</th> </tr> </thead> <tbody> <tr> <td>Beverage</td> <td>.5 - 2.0 cups</td> <td>.5 - 2.0 cups</td> </tr> <tr> <td>Dinner plate</td> <td>1 plate: Regular, Large or Small</td> <td>1 plate: Regular, Large or Small</td> </tr> <tr> <td>Casserole</td> <td>1-6 cups</td> <td>1-8 cups</td> </tr> <tr> <td>Rolls/muffins</td> <td>1-8</td> <td>1-10</td> </tr> <tr> <td>Baked potatoes</td> <td>1-6 medium</td> <td>1-8 medium</td> </tr> <tr> <td>Fresh vegetables</td> <td>1-6 cups</td> <td>1-8 cups</td> </tr> <tr> <td>Ground meat</td> <td>.3-2.0 lb</td> <td>.3-2.0 lb</td> </tr> <tr> <td>Frozen entrees</td> <td>6-17 oz</td> <td>6-17 oz</td> </tr> <tr> <td>Frozen Vegetables</td> <td>1-6 cups</td> <td>1-8 cups</td> </tr> <tr> <td>Microwave pizza</td> <td>1</td> <td>1</td> </tr> </tbody> </table>		Food	Amount		R-410C	R-510C	Beverage	.5 - 2.0 cups	.5 - 2.0 cups	Dinner plate	1 plate: Regular, Large or Small	1 plate: Regular, Large or Small	Casserole	1-6 cups	1-8 cups	Rolls/muffins	1-8	1-10	Baked potatoes	1-6 medium	1-8 medium	Fresh vegetables	1-6 cups	1-8 cups	Ground meat	.3-2.0 lb	.3-2.0 lb	Frozen entrees	6-17 oz	6-17 oz	Frozen Vegetables	1-6 cups	1-8 cups	Microwave pizza	1	1	<h3 style="text-align: center;">COMPU DEFROST CHART</h3> <table border="1" style="width: 100%; border-collapse: collapse;"> <thead> <tr> <th style="width: 50%;">Food</th> <th style="width: 50%;">Amount</th> </tr> </thead> <tbody> <tr> <td>1. Ground Meat</td> <td>.5 - 3.0 lb</td> </tr> <tr> <td>2. Steaks/Chops</td> <td>.5 - 4.0 lb</td> </tr> <tr> <td>3. Chicken Pieces</td> <td>.5 - 3.0 lb</td> </tr> </tbody> </table>		Food	Amount	1. Ground Meat	.5 - 3.0 lb	2. Steaks/Chops	.5 - 4.0 lb	3. Chicken Pieces	.5 - 3.0 lb
Food	Amount																																													
	R-410C	R-510C																																												
Beverage	.5 - 2.0 cups	.5 - 2.0 cups																																												
Dinner plate	1 plate: Regular, Large or Small	1 plate: Regular, Large or Small																																												
Casserole	1-6 cups	1-8 cups																																												
Rolls/muffins	1-8	1-10																																												
Baked potatoes	1-6 medium	1-8 medium																																												
Fresh vegetables	1-6 cups	1-8 cups																																												
Ground meat	.3-2.0 lb	.3-2.0 lb																																												
Frozen entrees	6-17 oz	6-17 oz																																												
Frozen Vegetables	1-6 cups	1-8 cups																																												
Microwave pizza	1	1																																												
Food	Amount																																													
1. Ground Meat	.5 - 3.0 lb																																													
2. Steaks/Chops	.5 - 4.0 lb																																													
3. Chicken Pieces	.5 - 3.0 lb																																													
MINUTE PLUS																																														
<p>Touch MINUTE PLUS for one minute at 100% power or to add a minute during manual cooking. Continue to touch for additional minutes.</p>	<div style="border: 1px solid black; padding: 5px; margin: 5px auto; width: 80px;">MINUTE PLUS</div>																																													

Carousel® and Auto-Touch® are registered trademarks of Sharp Corporation.

SHARP®

SHARP ELECTRONICS CORPORATION
Sharp Plaza, Mahwah, New Jersey 07430-2135

Printed in U.S.A.
TINSEB204MRR0