



SHARP®

SUPER STEAM OVEN OPERATION MANUAL

MODEL

AX-1200

followed by letter indicating color
S= Stainless K= Black

CONTENTS



- For Customer Assistance Inside Front Cover
- Precautions to Avoid Possible Exposure to Excessive Microwave Energy Inside Front Cover
- Limited Warranty 1
- Product Information Card 1
- Important Safety Instructions 2
- Unpacking and Installation Instructions... 3
- Grounding Instructions 4
- Information You Need to Know 5-10
- Part Names 11
- Control Panel 12
- Important Instructions 13-15
- Before Operating 16
- Clean the Oven Before First Use 16
- Automatic Cooking 17-25
- Manual Cooking 26-32
- Other Convenient Features 33-35
- Cleaning and Care 36-37
- Troubleshooting Chart..... 38-40
- Service Call Check / Specifications .. Back Cover

READ ALL INSTRUCTIONS CAREFULLY BEFORE USING THE OVEN.

FOR CUSTOMER ASSISTANCE

To aid in reporting this SuperSteam Oven in case of loss or theft, please record below the model number and serial number located on the unit. We also suggest you record all the information listed and retain for future reference.

Please provide the following information when you write or call: model number, serial number, date of purchase, your complete mailing address (including zip code), your daytime telephone number (including area code) and description of the problem.

MODEL NUMBER _____	SERIAL NUMBER _____
DATE OF PURCHASE _____	
DEALER _____	TELEPHONE _____
SERVICER _____	TELEPHONE _____

TO PHONE:

DIAL 1-800- BE-SHARP (237-4277) for :
SERVICE (for your nearest Sharp Authorized Servicer)
PARTS (for your authorized parts distributor)
ADDITIONAL CUSTOMER INFORMATION

DIAL 1-800-642-2122 for :
REPLACEMENT ACCESSORIES

TO WRITE:

Sharp Electronics Corporation
Customer Assistance Center
1300 Naperville Drive
Romeoville, IL 60446-1091

TO ACCESS INTERNET: www.sharppusa.com

PRECAUTIONS TO AVOID POSSIBLE EXPOSURE TO EXCESSIVE MICROWAVE ENERGY

- (a) Do not attempt to operate this oven with the door open since open-door operation can result in harmful exposure to microwave energy. It is important not to defeat or tamper with the safety interlocks.
- (b) Do not place any object between the oven front face and the door or allow soil or cleaner residue to accumulate on sealing surfaces.
- (c) Do not operate the oven if it is damaged. It is particularly important that the oven door close properly and that there is no damage to the: (1) door (bent), (2) hinges and latches (broken or loosened), (3) door seals and sealing surfaces.
- (d) The oven should not be adjusted or repaired by anyone except properly qualified service personnel.



LIMITED WARRANTY

SHARP ELECTRONICS CORPORATION warrants to the first consumer purchaser that this Sharp brand product (the Product), when shipped in its original container, will be free from defective workmanship and materials, and agrees that it will, at its option, either repair the defect or replace the defective Product or part thereof with a new or remanufactured equivalent at no charge to the purchaser for parts or labor for the period(s) set forth below.

This warranty does not apply to any appearance items of the Product nor to the additional excluded item(s) set forth below nor to any Product the exterior of which has been damaged or defaced, which has been subjected to improper voltage or other misuse, abnormal service or handling, or which has been altered or modified in design or construction.

In order to enforce the rights under this limited warranty, the purchaser should follow the steps set forth below and provide proof of purchase to the servicer.

The limited warranty described herein is in addition to whatever implied warranties may be granted to purchasers by law. ALL IMPLIED WARRANTIES INCLUDING THE WARRANTIES OF MERCHANTABILITY AND FITNESS FOR USE ARE LIMITED TO THE PERIOD(S) FROM THE DATE OF PURCHASE SET FORTH BELOW. Some states do not allow limitations on how long an implied warranty lasts, so the above limitation may not apply to you.

Neither the sales personnel of the seller nor any other person is authorized to make any warranties other than those described herein, or to extend the duration of any warranties beyond the time period described herein on behalf of Sharp.

The warranties described herein shall be the sole and exclusive warranties granted by Sharp and shall be the sole and exclusive remedy available to the purchaser. Correction of defects, in the manner and for the period of time described herein, shall constitute complete fulfillment of all liabilities and responsibilities of Sharp to the purchaser with respect to the Product, and shall constitute full satisfaction of all claims, whether based on contract, negligence, strict liability or otherwise. In no event shall Sharp be liable, or in any way responsible, for any damages or defects in the Product which were caused by repairs or attempted repairs performed by anyone other than an authorized servicer. Nor shall Sharp be liable or in any way responsible for any incidental or consequential economic or property damage. Some states do not allow the exclusion of incidental or consequential damages, so the above exclusion may not apply to you.

THIS WARRANTY GIVES YOU SPECIFIC LEGAL RIGHTS. YOU MAY ALSO HAVE OTHER RIGHTS WHICH VARY FROM STATE TO STATE.

Your Product Model Number & Description: AX-1200K or AX-1200S Home Use SuperSteam Oven. Be sure to have this information available when you need service for your Product.

Warranty Period for this Product: One (1) year parts and labor. The warranty period continues for an additional four (4) years, for a total of five (5) years, with respect to the magnetron tube in the Product for parts only; labor and service are not provided free of charge for this additional period.

Additional Item(s) Excluded from Warranty Coverage (if any): Non-functional accessories and light bulb.

Where to Obtain Service: From a Sharp Authorized Servicer located In the United States. To find the location of the nearest Sharp Authorized Servicer, call Sharp toll free at 1-800-BE-SHARP (1-800-237-4277).

What to do to Obtain Service: Ship prepaid or carry in your Product to a Sharp Authorized Servicer. Be sure to have **Proof of Purchase** available. If you ship the Product, be sure it is insured and packaged securely. If your Product is built-in using Sharp Built-in Kit RK-12S30, you may obtain in-home service during the initial one-year warranty period by contacting your Servicer. The Servicer will come to your home and if it is necessary to remove the product, the Servicer will reinstall it. Be sure to have **Proof of Purchase** available.

TO OBTAIN SUPPLY, ACCESSORY OR PRODUCT INFORMATION, CALL **1-800-BE-SHARP**. Save the **Proof of Purchase** as it is needed should your oven ever require warranty service.

PRODUCT INFORMATION CARD

The product information card, which is inside of the SuperSteam Oven carton, should be completed within ten days of purchase and returned. We will keep it on file and help you access the information in case of loss, damage or theft. This will also enable us to contact you in the unlikely event that any adjustments or modifications are ever required for your oven.



IMPORTANT SAFETY INSTRUCTIONS

When using electrical appliances basic safety precautions should be followed, including the following:

WARNING - To reduce the risk of burns, electric shock, fire, injury to persons or exposure to excessive microwave energy:

1. **Read all instructions before using the appliance.**
2. Read and follow the specific **“PRECAUTIONS TO AVOID POSSIBLE EXPOSURE TO EXCESSIVE MICROWAVE ENERGY”** on inside front cover.
3. This appliance must be grounded. Connect only to properly grounded outlet. See **“GROUNDING INSTRUCTIONS”** on page 4.
4. Install or locate this appliance only in accordance with the provided installation instructions.
5. Some products such as whole eggs and sealed containers – for example, closed glass jars – are able to explode and should not be heated in this oven.
6. Use this appliance only for its intended use as described in this manual. Do not use corrosive chemicals or vapors in this appliance. This type of oven is specifically designed to heat, cook or dry food. It is not designed for industrial or laboratory use.
7. As with any appliance, close supervision is necessary when used by children.
8. Do not operate this appliance if it has a damaged cord or plug, if it is not working properly or if it has been damaged or dropped.
9. This appliance should be serviced only by qualified service personnel. Contact nearest Sharp Authorized Servicer for examination, repair or adjustment.
10. Do not cover or block any openings on the appliance.
11. Do not store or use this appliance outdoors. Do not use this product near water, near a kitchen sink, in a wet basement, near a swimming pool or similar locations.
12. Do not immerse cord or plug in water.
13. Keep cord away from heated surfaces.
14. Do not let cord hang over edge of table or counter.
15. See door surface cleaning instructions on page 36.
16. To reduce the risk of fire in the oven cavity:
 - a. Do not overcook food. Carefully attend appliance when paper, plastic or other combustible materials are placed inside the oven to facilitate cooking.
 - b. Remove wire twist-ties from paper or plastic bags before placing bag in oven.
 - c. **If materials inside the oven ignite, keep oven door closed, turn oven off and disconnect the power cord or shut off power at the fuse or circuit breaker panel.**
 - d. Do not use the cavity for storage purposes. Do not leave paper products, cooking utensils or food in the cavity when not in use.
17. Liquids, such as water, coffee or tea are able to be overheated beyond the boiling point without appearing to be boiling. Visible bubbling or boiling when the container is removed from the microwave oven is not always present. **THIS COULD RESULT IN VERY HOT LIQUID SUDDENLY BOILING OVER WHEN A SPOON OR OTHER UTENSIL IS INSERTED INTO THE LIQUID.** To reduce the risk of injury to persons:
 - a. Do not overheat the liquid.
 - b. Stir the liquid both before and halfway through heating it.
 - c. Do not use straight-sided containers with narrow necks. Use a wide-mouthed container.
 - d. After heating, allow the container to stand in the microwave oven at least for 20 seconds before removing the container.
 - e. Use extreme care when inserting a spoon or other utensil into the container.
18. If the oven light fails, consult a SHARP AUTHORIZED SERVICER.
19. Do not operate any heating or cooking appliance beneath this appliance, except a properly installed electric wall oven, a warming drawer or a SHARP Microwave Drawer. See page 3.
20. Do not mount unit over or near any portion of a heating or cooking appliance, except a properly installed electric wall oven, a warming drawer or a SHARP Microwave Drawer. See page 3.
21. Do not mount over a sink.
22. Do not store anything directly on top of the appliance surface when the appliance is in operation.

SAVE THESE INSTRUCTIONS

UNPACKING AND INSTALLATION INSTRUCTIONS

Unpacking and Examining Your Oven

Remove:

1. all packing materials from inside the oven cavity.
Read enclosures and SAVE the Operation Manual.
2. the feature sticker from the outside of the door, if there is one.

Check the oven for any damage, such as misaligned or bent door, damaged door seals and sealing surfaces, broken or loose door hinges and latches and dents inside the cavity or on the door. If there is any damage, do not operate the oven and contact your dealer or SHARP AUTHORIZED SERVICER.

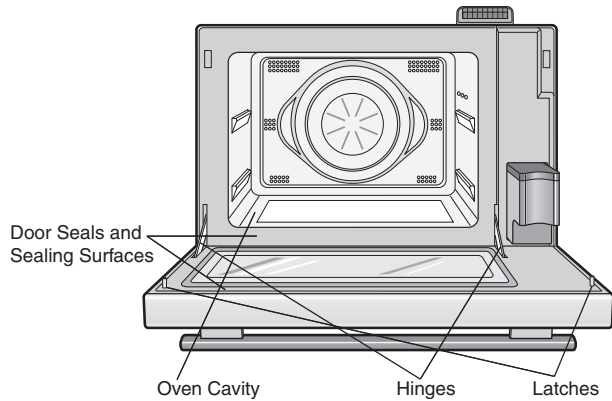

Choosing a Location for Your Oven

You will use your oven frequently so plan its location for ease of use. Do not place the oven on a mat, carpet or tablecloth or block the ventilation openings. The oven must be placed on a countertop which is a minimum of 36 inches (91.5 cm) from the floor. Allow at least 2 inches (5.1 cm) on the sides, and 2 inches (5.1 cm) above the top of the oven (excluding the air vent opening) for air circulation. Be sure to position oven so that the rear cannot be touched inadvertently.

Your SuperSteam oven can be built into a cabinet or wall by itself, or above any electric wall oven, above warming drawer, above Sharp's Microwave Drawer, models KB-6002, KB-6015 or KB-6025 or above other Sharp Microwave Drawer models that specify the combination of this oven using Sharp's Built-in Kit, RK-12S30. It cannot be built in above any gas wall oven.

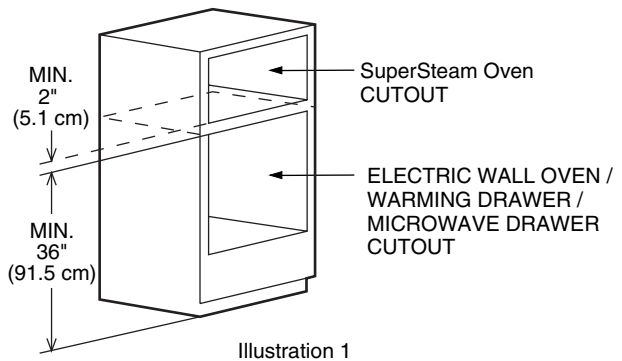

Illustration 1

Refer to Illustration 1 for proper location when building in above an electric wall oven, a warming drawer or SHARP Microwave Drawer. Carefully follow both the electric wall oven/warming drawer/microwave drawer installation instructions and Sharp's Built-in Kit instructions. Be sure that the clearance of the floor between the SuperSteam Oven and the electric wall oven/warming drawer/microwave drawer is a minimum of 2 inches (5.1 cm).

Ordering a Built-in Kit

If your dealer does not stock the kit, it can be ordered directly from the Sharp Accessories and Supplies Center. Have your credit card number available and call toll-free: 1-800-237-4277 for ordering the kit, RK-12S30 to be sent to your address.

The kit includes ducts and finish trim strips and easy-to-follow instructions for installation as well as the location of the power supply.

GROUNDING INSTRUCTIONS

This appliance must be grounded. This oven is equipped with a cord having a grounding wire with a grounding plug. It must be plugged into a wall receptacle that is properly installed and grounded in accordance with the National Electrical Code and local codes and ordinances. In the event of an electrical short circuit, grounding reduces the risk of electric shock by providing an escape wire for the electric current.

WARNING – Improper use of the grounding plug can result in a risk of electric shock.

Electrical Requirements

The electrical requirements are a 120 volt 60 Hz, AC only, 15 amp. or more protected electrical supply. It is recommended that a separate circuit serving only this oven be provided.

The oven is equipped with a 3-prong grounding plug. It must be plugged into a wall receptacle that is properly installed and grounded. Should you only have a 2-prong outlet, have a qualified electrician install a correct wall receptacle.

A 3-prong adapter may be purchased and used temporarily if local codes allow. Follow package directions.

A short power-supply cord is provided to reduce risk of becoming entangled in or tripping over a longer cord.

Extension Cord

If it is necessary to use an extension cord, use only a 3-wire extension cord that has a 3-blade grounding plug and a 3-slot receptacle that will accept the plug on the SuperSteam Oven. The marked rating of the extension cord should be AC 115-120 volt, 15 amp. or more.

Be careful not to drape the cord over the countertop or table where it can be pulled on by children or tripped over accidentally.

NOTES:

1. If you have any questions about the grounding or electrical instructions, consult a qualified electrician or service person.
2. Neither Sharp nor the dealer can accept any liability for damage to the oven or personal injury resulting from failure to observe the correct electrical connection procedures.

Radio or TV Interference

Should there be any interference caused by the microwave part of the oven to your radio or TV, check that the oven is on a different electrical circuit, relocate the radio or TV as far away from the oven as feasible or check position and signal of receiving antenna.

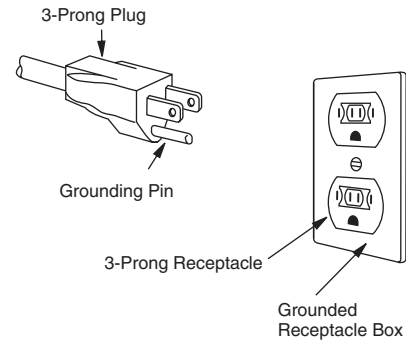

Permanent and Correct Installation

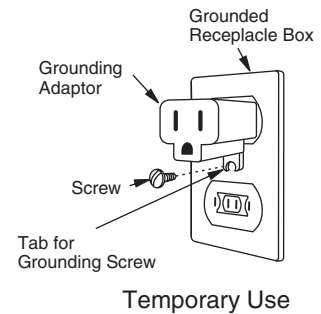



INFORMATION YOU NEED TO KNOW

ABOUT YOUR OVEN

This Operation Manual is valuable: read it carefully and always save it for reference.

The Sharp SuperSteam Oven Cookbook is a valuable asset. Check it frequently for cooking principles, techniques, hints and recipes.

Be aware that, unlike microwave-only ovens, Super Steam Ovens have a tendency to become hot during cooking with **SuperSteam Convection, Convection or Steam.**

The oven is for food preparation only. It should not be used to dry clothes or newspapers.

ABOUT COOKING OPTIONS

Your oven has a variety of cooking options that are divided into automatic and manual. SuperSteam Convection, Steam and Microwave have both automatic and manual choices. Convection has only manual.

SuperSteam Convection

SuperSteam is combined with convection heating, which can roast or broil foods and allow excess fats to be removed. These foods retain moisture. Meats and poultry are brown, juicy and flavorful.

Steam

Steam-only gently cooks foods such as vegetables, fish, seafood and poached eggs while retaining moisture, natural flavors and nutrients.

Convection

Convection browns, bakes, broils and crisps a wide variety of foods. Cookies, cakes, breads, muffins, biscuits and rolls can be baked on one or two levels. There are no automatic settings for convection. Refer to your SuperSteam Cookbook or to Convection in Manual Operations.

Microwave

Microwave is fast and convenient for cooking, defrosting and popping popcorn. With Sensor Reheat, Sensor Cook and Sensor Popcorn, it is unnecessary to enter amount. The sensor eliminates guesswork.



INFORMATION YOU NEED TO KNOW

ABOUT UTENSILS AND COVERINGS

The chart below will help you decide what utensils and coverings should be used in each mode.

Utensils - Coverings / Cooking Mode	SuperSteam Convection / Convection	Steam	Microwave
Aluminium Foil, Foil Containers	YES	YES	YES Small flat pieces of aluminum foil placed smoothly on food can be used to shield areas from cooking or defrosting too quickly. Keep foil at least 1 inch (2.54 cm) from walls of oven.
Metal	YES	YES	NO
China, Ceramics, Porcelain, Pottery, Stoneware	YES Oven-proof porcelain, pottery, glazed earthenware and bone china are usually suitable. Do not use the container if it has a flaw.	YES	YES Check manufacturer's recommendation for being microwave safe. Do not use the container if it has a flaw.
Heat-resistant Glassware e.g. Pyrex®	YES Care should be taken if using fine glassware as it can break or crack if heated suddenly.	YES	YES
Non-heat-resistant Glassware	NO	NO	NO
Heat-resistant Plastic/Polystyrene	NO Check manufacture's temperature range.	YES Care must be taken as some containers warp, melt or discolor at high temperatures.	YES Use microwave-safe plastic containers for reheating and defrosting. Some microwave-safe plastics are not suitable for cooking foods with high and sugar content. Follow manufacturer's directions.
Plastic, Thermoset®	NO	YES	YES
Microwave Plastic Wrap	NO	NO	YES
Paper Towels, Paper Plates	NO	NO	YES Paper towels: To cover for reheating and cooking. Do not use recycled paper towels which may contain metal filings. Paper plates: For reheating.
Parchment Paper	NO	YES	YES
Wax Paper	NO	NO	YES Good covering for cooking and reheating.
Roasting Rack	YES	NO	NO
Roasting Bags	YES Roasting bags should only be used with convection bake or roast.	NO	YES Follow manufacturer's directions.
Silver Dishes and Cooking Utensils or Containers that might rust inside the oven.	NO	NO	NO
Low Rack, High Rack, Baking Tray, Steam Basket	YES	YES	NO



INFORMATION YOU NEED TO KNOW

DISH CHECK. If you wish to check if a dish is safe for microwaving, place the empty dish in the oven and microwave on 100% power for 30 seconds. If the dish becomes very hot, do NOT use it for microwaving.

ACCESSORIES There are many microwave or heat-resistant accessories available for purchase. Evaluate carefully before you purchase so that they meet your needs. A microwave-safe thermometer will assist you in determining correct doneness and assure you that foods have been cooked to safe temperatures when using microwave-only cooking. Sharp is not responsible for any damage to the oven when accessories are used.

For automatic cooking, use the recommended container in the cooking chart in this operation manual or the cookbook.

ABOUT SUPER STEAM CONVECTION AND STEAM COOKING

There are certain techniques for cooking with steam. It is essential that these techniques are followed for good results. Many of them are similar to those used in conventional cooking so may require little change. Note information in all of the charts in the cookbook for all cooking options that use SuperSteam Convection (Roast, Convenience Foods, Broil) and Steam (Cook, Reheat, Keep Warm and Proof).

- **Always attend the oven when in use.**
- **Use utensils/cookware suitable for the cooking mode as described on page 6.**
- **Ventilate the room to allow the steam to dissipate.**
- **Refer to the charts in the SuperSteam Oven Cookbook for recommended cooking settings and times.**
- **After cooking and the oven has cooled, remove and empty the reservoir, wipe oven cavity with a soft cloth or sponge. Wait a few minutes, then empty the drip tray.**

FOR STEAM COOKING

Cooking Techniques	
Baking Tray • High Rack • Steam Basket	Place food in steam basket on high rack in baking tray so steam reaches all sides and cooking is even. For faster cooking, use upper level in oven. Foods crowded together will take longer to cook, so position with enough space between items to allow the steam to circulate.
Covering	Covering is not necessary in most cases. If a cover is required, aluminum foil is recommended to keep food from becoming wet.
Door	For accurate cooking times, keep the door closed.
Stir	Sometimes soups or casseroles reheated without covering look watery after cooking. Appearance will be better if stirred well.
Stand	Standing time is recommended after cooking to allow heat to disperse equally throughout the food. Do not allow to stand in the oven for a long time; food may be overcooked or wet from the residual steam.

Cooking Hints	
Blanching	Steam mode can be used to blanch vegetables to prepare them for freezing. Place the prepared vegetables in the steam basket on the high rack in the baking tray. Use upper level in oven. Press Steam , MANUAL and desired time 4 - 5 minutes. Press START . After steaming, put in cold water to cool quickly. Drain and then freeze.



INFORMATION YOU NEED TO KNOW

FOR SUPER STEAM CONVECTION AND STEAM COOKING

Food Characteristics	
Density	Food density will affect the amount of cooking time. Cut the food into thinner parts, if possible, and arrange in single layer.
Quantity	The cooking time must be increased as the amount increases.
Size	Small foods and small pieces cook faster than large ones, as heat can penetrate from all sides to the center. For even cooking make all the pieces the same size.
Shape	Foods which are irregular in shape, such as chicken breasts or drumsticks, may take longer to cook in the thicker parts. Check that these parts are cooked thoroughly before serving.
Temperature of Food	The initial temperature of food affects the cooking time. Chilled foods will take longer to cook than foods at room temperature. The temperature of the container is not the actual temperature of the food or drink.
Seasoning and Flavoring	Seasoning or flavoring are best added after cooking. If added as marinades or rubs, the taste may become less pronounced when cooking with steam. Add seasoning or flavoring again after cooking, if necessary.

- Check that food is thoroughly cooked/reheated before serving.
- Cooking time will be affected by the shape, depth, quantity and temperature of food together with the size, shape and material of the container.
- Never heat oil or fat for deep frying as this may lead to overheating and fire.

CAUTION:

Always use dry pot holders or oven mitts to remove food or utensils from the oven. Be careful when opening the oven door to allow steam to dissipate.

ABOUT MICROWAVE COOKING

- * **ALWAYS** have food in the oven when it is on to absorb the microwave energy.
- * Your oven is rated 700 watts using the IEC Test Procedure. In using recipes or package directions, check food at the minimum time and add time accordingly.
- * Condensation is a normal part of microwave cooking. Room humidity and the moisture in food will influence the amount of moisture that condenses in the oven. Generally, covered foods will not cause as much condensation as uncovered ones. Vents on the oven back must not be blocked.
- * Arrange food carefully. Place thickest areas toward outside of dish.
- * Watch cooking time. Cook for the shortest amount of time indicated and add more as needed. Foods severely overcooked can smoke or ignite.
- * Cover foods while cooking. Check recipe or cookbook for suggestions: paper towels, wax paper, microwave plastic wrap or a lid. Covers prevent spattering and help foods to cook evenly.
- * Shield with small flat pieces of aluminum foil any thin areas of meat or poultry to prevent overcooking before dense, thick areas are cooked thoroughly.
- * Stir foods from outside to center of dish once or twice during cooking, if possible.
- * Turn foods over once during microwaving to speed cooking of such foods as chicken and hamburgers. Large items like roasts or turkey breasts must be turned over at least once.
- * Rearrange foods like meatballs halfway through cooking both from top to bottom and from the center of the dish to the outside.
- * Add standing time. Remove food from oven and stir, if possible. Cover for standing time which allows the food to finish cooking without overcooking.
- * Check for doneness. Look for signs indicating that cooking temperatures have been reached.
 - Doneness signs include:**
 - Food steams throughout, not just at edge.
 - Center bottom of dish is very hot to the touch.
 - Poultry thigh joints move easily.
 - Meat and poultry show no pinkness.
 - Fish is opaque and flakes easily with a fork.



INFORMATION YOU NEED TO KNOW

ABOUT FOOD WHEN USING THE MICROWAVE MODE

	DO	DON'T
Eggs, sausages, nuts, seeds, fruits & vegetables	<ul style="list-style-type: none"> * Puncture egg yolks before cooking to prevent "explosion". * Pierce skins of potatoes, apples, squash, hot dogs and sausages so that steam escapes. 	<ul style="list-style-type: none"> * Cook eggs in shells. * Reheat whole eggs. * Dry nuts or seeds in shells.
Popcorn	<ul style="list-style-type: none"> * Use specially bagged popcorn for the microwave oven. * Listen while popping corn for the popping to slow to 1 or 2 seconds or use SENSOR POPCORN for "no-guess" popping. 	<ul style="list-style-type: none"> * Pop popcorn in regular brown bags or glass bowls. * Exceed maximum time on popcorn package.
Baby food	<ul style="list-style-type: none"> * Transfer baby food to small dish and heat carefully, stirring often. Check temperature before serving. * Put nipples on bottles after heating and shake thoroughly. "Wrist" test before feeding. 	<ul style="list-style-type: none"> * Heat baby food in original jars. * Heat disposable bottles. * Heat bottles with nipples on.
General	<ul style="list-style-type: none"> * Cut baked goods with filling after heating to release steam and avoid burns. * Stir liquid briskly before and after heating to avoid "eruption". * Use deep bowl when cooking liquid or cereal to prevent boilovers. 	<ul style="list-style-type: none"> * Heat or cook in closed glass jars or air tight containers. * Can in the microwave as harmful bacteria may not be destroyed. * Deep fat fry. * Dry wood, gourds, herbs or wet papers.

ABOUT CHILDREN

Children below the age of 7 should use the oven with a supervising person very near to them. Between the ages of 7 and 12, the supervising person should be in the same room.

The child must be able to reach the oven comfortably; if not, he/she should stand on a sturdy stool.

At no time should anyone be allowed to lean or swing on the oven door.

Children should be taught all safety precautions.

Don't assume that because a child has mastered one cooking skill he/she can cook everything.

Children need to learn that the oven is not a toy. Young children should be supervised to ensure that they do not play with the oven.

ABOUT SAFETY

- Check foods to see that they are cooked to the United States Department of Agriculture's recommended temperatures.

TEMP	FOOD
145°F (63°C)	... for beef, lamb or veal cut into steaks, chops or roasts, fish
160°F (71°C)	... for fresh pork, ground meat, fish, seafood, egg dishes, frozen prepared food and beef, lamb or veal cut into steaks, chops or roasts
165°F (74°C)	... for leftover, ready-to-reheat refrigerated, deli and carry out "fresh" food, whole chicken or turkey, chicken or turkey breasts and ground poultry used in chicken or turkey burgers. NOTE: Do not cook whole, stuffed poultry. Cook stuffing separately to 165°F (74°C).



INFORMATION YOU NEED TO KNOW

To test for doneness, insert a meat thermometer in a thick or dense area away from fat or bone. NEVER leave the thermometer in the food during cooking, unless it is approved for microwave oven use.

- Accessible parts (e.g. oven door, oven cavity, dishes and accessories) may become hot during use. Use dry pot holders or oven mitts when removing container, food and oven accessories from the oven and be careful not to touch the oven cavity to prevent burns.
- Use care when opening door. Avoid steam burns by directing steam away from the face and hands. Always stand back from the oven when opening it.
- Slowly lift the farthest edge of a dish's covering and carefully open popcorn and oven cooking bags away from the face.
- Stay near the oven while it's in use and check cooking progress frequently so that there is no chance of overcooking food.
- NEVER use the cavity for storing cookbooks or other items.
- Select, store and handle food carefully to preserve its high quality and minimize the spread of foodborne bacteria.
- Use care when removing items from the oven so that the utensil, your clothes or accessories do not touch the door projection.
- Do not touch around the oven light. This part will become hot when the oven light is on.
- To avoid burns, always be careful of splashing grease from the baking tray when removing roasted or broiled meats from the oven.
- To avoid burns, always test food and container temperature and stir before serving. Pay special attention to the temperature of containers, foods and drinks. Do not drink beverage or soup without checking the container's temperature.
- Do not touch the oven door, outer cabinet, rear cabinet, oven cavity, ventilation openings, accessories, dishes and the escaping steam from the air vent openings during operation because they will become hot.
- Do not operate the oven if reservoir cracks and water leaks. Call 1-800-BE-SHARP to purchase a replacement part.
- After use, condensed water may be inside oven cavity, especially on the oven floor. Dry any liquid residue with a sponge and wipe out to keep the oven clean.
- Do not place anything on the outer cabinet during operation.
- Do not move the oven during the operation. If the oven needs to be moved, always drain all water inside the oven using the DRAIN WATER function (See page 15). After draining, empty the drip tray.
- To prevent condensation, which could corrode the appliance, do not leave cooked food in the oven for an extended period.
- Clean the oven at regular intervals and remove any food deposits in the oven or on the door.
- Do not heat oil or fat for deep frying.
- ALWAYS use potholders to prevent burns when handling utensils that are in contact with hot food. Enough heat from the food can transfer through utensils to cause skin burns. In SuperSteam Convection, Steam and Convection modes, cabinet, interior and door may be too hot to touch.
- Keep aluminum foil used for shielding at least 1 inch (2.54 cm) away from walls, ceiling and door for microwave cooking.
- Do not pour cold water on the ceramic oven floor after cooking as it might break.
- Do not pour cold water on the door as it might break.
- Do not touch hot surfaces.
- The use of accessory attachments not recommended by the appliance manufacturer may cause injuries.
- The oven should not be left unattended during operation. Oven temperatures that are too high or cooking times that are too long may overheat foods resulting in a fire.
- Do not insert fingers or objects in the steam outlets or air vent openings, as this may damage the oven and cause an electric shock or a hazard.
- If any objects drop inside the air vent openings, turn off the oven immediately, unplug and consult a Sharp Authorized Servicer.
- Do not touch the plug with wet hands when inserting or removing from the outlet. Plug securely into the electric wall receptacle and remove by gripping on the plug end. Never pull using just the cord.

PART NAMES

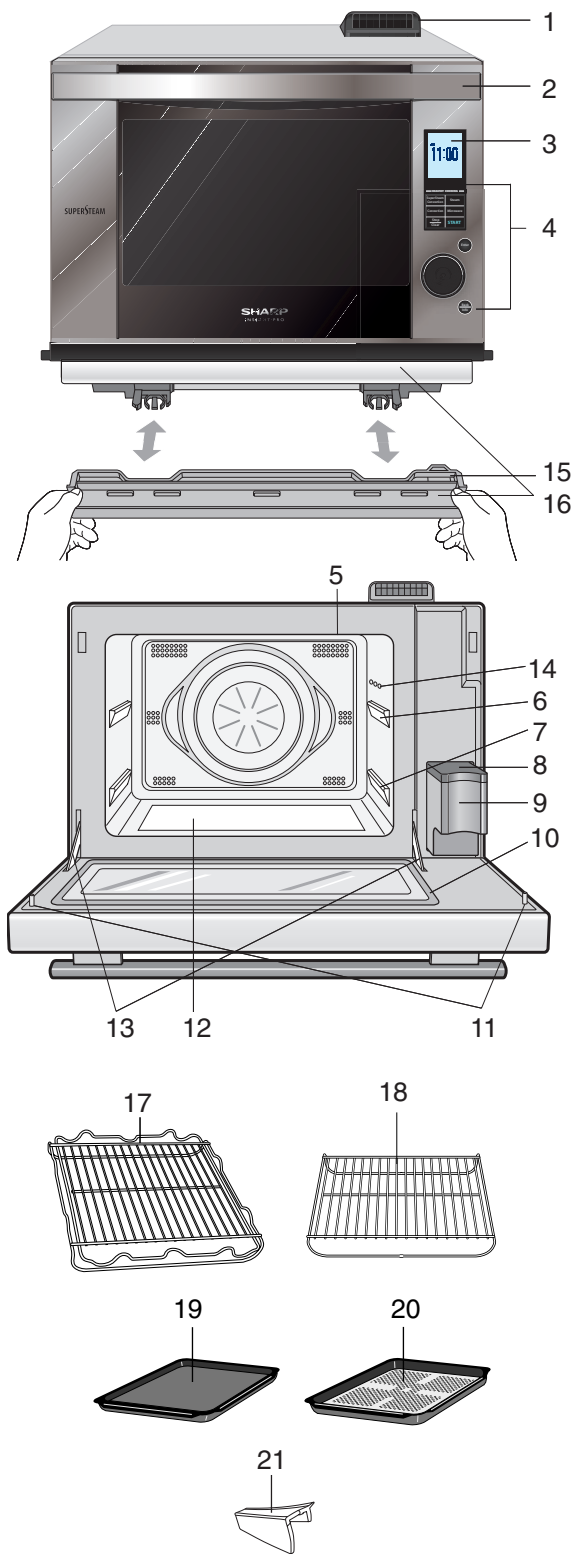

- 1** Air vent opening
- 2** Handle
- 3** LCD display
- 4** Control panel
- 5** Oven light
- 6** Upper level
- 7** Lower level
- 8** Reservoir lid (See page 13.)
- 9** Reservoir (See page 13.)
- 10** Door gasket
- 11** Latches
- 12** Ceramic oven floor
- 13** Door hinges
- 14** Steam outlets
- 15** Drip tray lid (See page 13.)
- 16** Drip tray (See page 13.)

ACCESSORIES

- 17** High rack
For SuperSteam Convection, Convection and Steam.
Do not use when microwave cooking.
Always place on baking tray.
- 18** Low rack
For SuperSteam Convection, Convection and Steam.
Do not use when microwave cooking.
Always place on baking tray.
- 19** Baking tray x2
For SuperSteam Convection, Convection, Steam and Descal function. Do not use when microwave cooking.
- 20** Steam basket
For Steam. You can also use for SuperSteam Convection and Convection.
Do not use when microwave cooking.
Place on high rack in baking tray.
- 21** Descaling guide (See page 15.)

PRINTED MATERIALS included:

- Operation Manual
- SuperSteam Oven Cookbook
- Touch Guide



CONTROL PANEL



Number next to the control panel illustration indicates pages on which there are feature descriptions and usage information.

DISPLAY INFORMATION

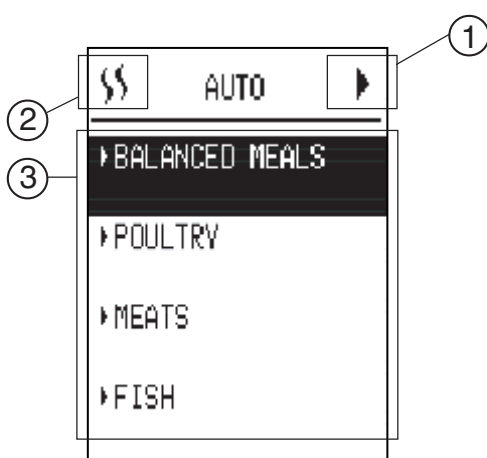

① Arrows indicate more than one page; when you see an arrow, you can turn the dial to move back and forth between pages. When there are no arrows, you can go back to the previous page by touching **Back/Info**.

② The illustration at the top of display indicates the selected cooking mode.

SuperSteam Convection was selected.

Steam was selected.

Microwave was selected.

Convection was selected.

③ Words will light in the display to indicate features and cooking instructions.



IMPORTANT INSTRUCTIONS

READ CAREFULLY BEFORE COOKING IN SUPER STEAM CONVECTION & STEAM

RESERVOIR

To fill the reservoir with fresh cold tap water is a must for SuperSteam Convection and Steam in both Automatic and Manual Cooking. Be sure to follow the directions below.

1. Pull the reservoir toward you to remove.
2. Wash the reservoir and lid for the first time. (Figure 1)
3. Fill the reservoir with **fresh cold tap water through the lid to the 2 mark each time you begin to cook.** (Figure 2) Do not fill the reservoir over the 2 mark.
4. Make sure the lid is closed firmly.
5. Install the reservoir by pushing firmly. (Figure 3)
6. After cooking, empty the reservoir and wash the reservoir and the lid.

NOTES:

1. Do not use distilled water or any other liquid.
2. An insufficient amount of water in the reservoir may cause an undesired result.
3. We recommend that you empty the reservoir every time after cooking. Do not leave the reservoir filled with water in the oven over a day.
4. If any messages, such as "Fill water reservoir", are as shown in the display during cooking, refer to Troubleshooting Chart on page 38.
5. Do not drop or damage the reservoir. Heat may cause the reservoir to change shape. Do not use a damaged reservoir. Call 1-800-BE-SHARP to purchase a replacement.
6. There may be a few water drops when removing the reservoir. Wipe the oven dry with a soft cloth.
7. Do not block the air holes on the lid of the reservoir. It will cause trouble during cooking.
8. A small amount of water will drain into the drip tray when the reservoir is removed. Empty after cooking.

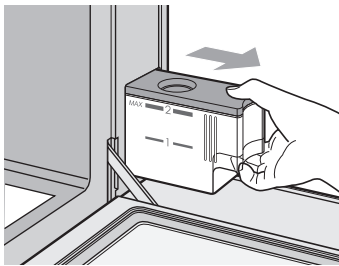

Figure 1

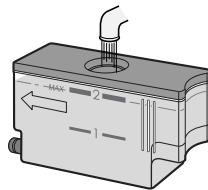

Figure 2

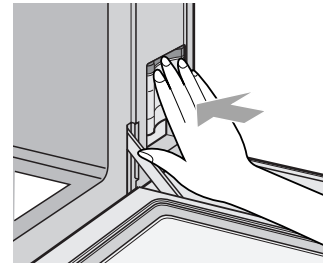

Figure 3

DRIP TRAY

Be sure to cook with drip tray in position and follow the directions below.

The drip tray and the lid are packed with the oven. Place the drip tray and lid under the oven door as shown in Figure 4. This drip tray collects the condensation from the oven door.

To remove the drip tray: Pull the drip tray toward you with both hands.

* Make sure water is not dripping down before removing the drip tray.

To replace the drip tray: Place the drip tray onto the right and left hooks under the oven and push firmly as shown in Figure 4.

If "Replace drip tray" or "Empty drip tray and replace" is as shown in the display, remove and then replace the drip tray correctly.

Empty the drip tray after each time you cook. Empty, rinse thoroughly, dry and replace. Failure to empty may cause the drip tray to overflow. Cooking repeatedly without emptying the drip tray may cause it to overflow.



Figure 4

WARNINGS:

1. The oven will become very hot after cooking and draining water function.
2. Do not open the oven with your face close to the oven. Steam from the oven may cause burns.
3. Make sure that the oven has cooled before emptying the reservoir and the drip tray and then wipe the oven cavity.
4. Do not touch the water directly as water in the drip tray may be hot.



IMPORTANT INSTRUCTIONS

SUPER STEAM CONVECTION & STEAM IN AUTOMATIC AND MANUAL COOKING

Before cooking

1. Make sure the reservoir is filled with fresh cold tap water and is installed. (See page 13.)
2. Make sure the empty drip tray is installed. (See page 13.)
3. Place food in the oven unless preheating is needed. (Refer to each chart to check if preheating is required in automatic operations.)

After Cooking

1. After the oven has cooled, remove and empty the reservoir, wipe oven cavity. Wait a few minutes, then empty the drip tray.
2. Perform the Drain Water function at least once a day after using SuperSteam Convection or Steam mode.
3. Check that water is not dripping down before removing the drip tray, as a small amount of water drains into the drip tray when the reservoir is removed.

Oven Door Opening

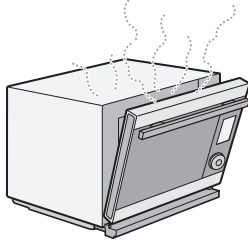

Figure 1

You can stop the door with the upper part of the oven open to exhaust steam, to cool or dry the oven cavity temporarily after cooking. (See Figure 1)

WARNING: Do not open the oven with your face close to the oven. Steam from the oven may cause burns.

NOTE: Avoid opening and closing the door during cooking as the oven cavity temperature drops suddenly, which may affect the result.



IMPORTANT INSTRUCTIONS

DRAIN WATER FUNCTION

Perform the Drain Water function at least once a day after using SuperSteam Convection or Steam mode. It takes up to 8 minutes.

Drain Water function is very useful to prevent scale build up and the use of stale water. It causes evaporation of the internal steam system.

PROCEDURE

- 1 Press **Back/Info**, turn the **Dial** to select DRAIN WATER and press **Enter**. 
- 2 Make sure the reservoir is removed and press **START**. 
- 3 After the oven has cooled, wipe oven cavity. Wait a few minutes, then empty the drip tray.

NOTE:

The reservoir must be removed before starting this procedure.

DESCALE FUNCTION

White or gray grains, also called scale, may form in the water circuit inside the oven during steam generation, which could cause the oven to malfunction.

When DESCALING IS NECESSARY. is shown in the display, be sure to carry out Descal function immediately. It takes about 1 hour.

PROCEDURE

- 1 Press **Back/Info**, turn the **Dial** to select DESCAL and press **Enter**. 
- 2 Pure citric acid, available at some drugstores, or bottled lemon juice with no pulp are used for descaling. Choose one and prepare the descaling solution.
To use pure citric acid, dissolve 1 tablespoon of pure citric acid crystals in 2 1/4 cups of water in a non-porous container. Stir well and pour into the reservoir.
To use 100% bottled lemon juice, check that there is absolutely no pulp in it. If there is pulp or you are not sure, strain through a fine strainer. Measure 1/3 cup of the strained lemon juice and add it to 2 1/4 cups of water. Stir well and pour into the reservoir.
Place the reservoir in the oven correctly and push firmly into place.

- 3 Place baking tray on upper level. Place descaling guide on the right side edge of baking tray as shown in Figure 1. Push down the right side edge of descaling guide to insert the projection between the wall and the baking tray as shown in Figure 2. Check that the edge of the descaling guide is below all steam outlets/screw heads as shown in Figure 3.

- 4 Do not place any food in the oven. Press **START** to begin descaling. 

- 5 When the oven has stopped and is cool, remove reservoir, empty, rinse and refill with cold tap water. Replace reservoir. Remove the descaling guide as shown in Figure 4. Empty baking tray, rinse, dry. Follow step 3. Press **START**. Rinsing will start. 

- 6 When rinsing has ended and the oven is cool, remove reservoir and empty. Then remove descaling guide as shown in Figure 4 and empty baking tray. Wipe oven cavity to dry. Wait a few minutes and then empty the drip tray.

WARNING:

The area around the steam outlets become hot. Pay extra attentions to attach or remove descaling guide.

NOTE:

Oven light goes off after Enter is pressed at Step 1.

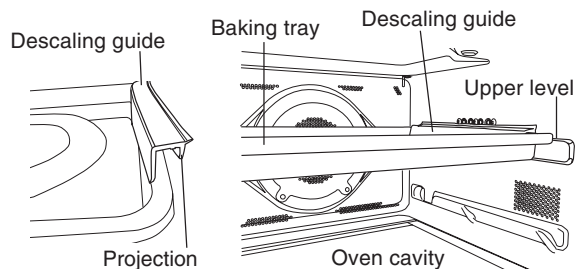

Figure 1

Figure 2

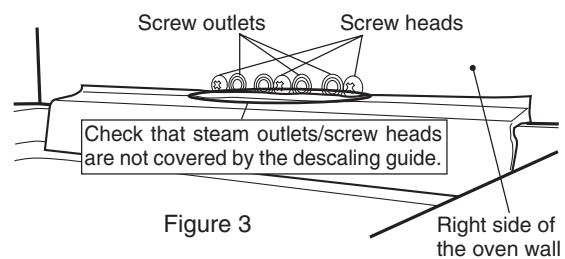

Figure 3



Figure 4
Removing descaling guide.





BEFORE OPERATING

- Before operating your SuperSteam oven, make sure you read and understand this operation manual completely.
- Before the oven can be used, follow these procedures:
 1. Place the drip tray correctly. See page 13.
 2. Close the door. Plug in the oven. Check that the display lights.
 3. See below for how to set the clock.
 4. Read pages 5 - 10 for important information necessary for correct operation.
 5. Follow directions on the right side for clean the oven before first use.

TO SET THE CLOCK

This is a 12 hour clock and AM or PM is shown in the display.
* Suppose you want to enter the correct time of day.
(EX: 11:30PM)

PROCEDURE

- 1** Press **Back/Info**.

- 2** Turn the **Dial** to select **CLOCK** and press **Enter**.

- 3** Turn the **Dial** to set the desired hour (PM 11:00) and press **Enter**.

- 4** Turn the **Dial** to select the desired minutes (PM 11:30) and press **Enter**.

NOTES:

1. If the electrical power supply to the oven should be interrupted, the display will intermittently show SuperSteam after the power is reinstated. If this occurs during cooking, the program will be erased. The time of day will also be erased. Simply press **Stop/Clear** and reset the clock for the correct time of day.
2. The display backlight will be automatically turned off in Sleep Mode ON, if the oven is not used for 15 minutes. See Sleep Mode on page 35.
3. When the desired option appears in the display, you do not have to turn the dial to select it. Just press **Enter**.

STOP/CLEAR

1. Press **Stop/Clear** if you make a mistake during programming.
2. Stop the oven temporarily during cooking.
3. Return the time of day or home page to the display.
4. Cancel a program during cooking, press twice.

BACK

1. Press **Back/Info** if you want to go back to the previous page during programming before pressing **START**.
2. After pressing **START**, it is not possible to return to a previous page.





CLEAN THE OVEN BEFORE FIRST USE

The steam generator heats the water which is used for cooking. It should be cleaned before the first use to get rid of any odor in the oven cavity. Clean the oven with SuperSteam Convection Broil in manual operation for 20 minutes without preheat and food. You may notice some smoke and odor during this process. This is normal. The oven is not out of order.

PREPARATION

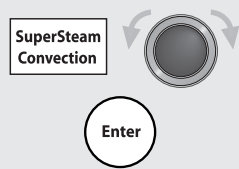
1. Ventilate the room.
2. Make sure that the reservoir is filled with fresh cold tap water and is installed.
3. Make sure that the empty drip tray is installed.

PROCEDURE

- 1** Press **SuperSteam Convection**, turn the **Dial** to select **MANUAL** and press **Enter**.

- 2** Turn the **Dial** to select **SUPER STEAM BROIL** and press **Enter**.

- 3** Turn the **Dial** to select **WITHOUT PREHEAT** and press **Enter**.

- 4** Turn the **Dial** to enter cooking time (20 min.) and press **START**.

WARNINGS:

1. The oven door, outer cabinet and oven cavity will become hot.
2. Do not open the oven with your face close to the oven. Steam from the oven may cause burns.

AUTOMATIC COOKING

Automatic Operation is available with SuperSteam Convection, Steam and Microwave. Refer to each function for the details.

SUPER STEAM CONVECTION

SuperSteam Convection has 8 options: Balanced Meals, Poultry, Meats, Fish, Grilled Vegetables, Potatoes, Frozen Pizza and Convenience Foods. Refer to the SuperSteam Convection Chart for details on page 20.

Balanced Meals

* Suppose you want to cook Balanced Meals Complete Dinners Chicken with Standard time.

PROCEDURE

- 1** Press **SuperSteam Convection**, turn the **Dial** to select **AUTO** and press **Enter**.

- 2** Turn the **Dial** to select **BALANCED MEALS** and press **Enter**.

- 3** Turn the **Dial** to select **COMPLETE DINNERS** and press **Enter**.

- 4** Turn the **Dial** to select **CHICKEN** and press **Enter**.

- 5** Make sure **STANDARD** is selected and then press **Enter**.

- 6** Press **START** to preheat. No food in oven.

- 7** When preheat is over, place food in the oven by following the directions in the display and the cooking chart. Close the door.
- 8** Press **START**.

- 9** After cooking, **EXTEND** will appear. If you wish to extend cooking time, turn the **Dial** to add time and press **START**. If not, press **Stop/Clear**. After the oven has cooled, remove and empty the reservoir, wipe oven cavity. Wait a few minutes, then empty the drip tray.





POULTRY • MEATS • FISH • GRILLED VEGETABLES • POTATOES • FROZEN PIZZA • CONVENIENCE FOODS

* Suppose you want to cook 3.5 lb Chicken Pieces Bone-in with Standard time.

PROCEDURE

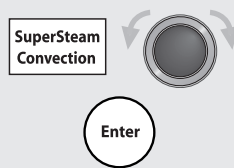
- 1** Press **SuperSteam Convection**, turn the **Dial** to select **AUTO** and press **Enter**.



- 2** Turn the **Dial** to select **POULTRY** and press **Enter**.



- 3** Turn the **Dial** to select **CHICKEN PIECES BONE-IN** and press **Enter**.



- 4** Turn the **Dial** to enter amount (**3.5 lb**) and press **Enter**.

- 5** Make sure **STANDARD** is selected and then press **Enter**.

- 6** Press **START** to preheat. No food in oven.

- 7** When preheat is over, place food in the oven by following the directions in the display and the cooking chart. Close the door.
- 8** Press **START**.

- 9** After cooking, **EXTEND** will appear. If you wish to extend cooking time, turn the **Dial** to add time and press **START**. If not, press **Stop/Clear**. After the oven has cooled, remove and empty the reservoir, wipe oven cavity. Wait a few minutes, then empty the drip tray.



AUTOMATIC COOKING

NOTES:

1. Enter the weight or amount of the food only (except Balanced Meals and Frozen Pizza). Do not include the weight of the container.
2. For foods weighing more or less than weights given in the cooking charts, cook manually.
3. If the oven door is not opened after preheating, the oven will hold the preheat temperature for 30 minutes and then time of day or home page will be displayed.
4. Always follow the instructions in the display.
5. The programmed cooking times are average times. To extend cooking times preprogrammed in the automatic cooking, see **EXTENDING COOKING TIME AT THE END OF COOKING** on page 33.
6. All selections can be programmed with More or Less Time Adjustment. See page 33.
7. Keep the door closed. If opened during cooking, steam will escape and a longer cooking time will be required in SuperSteam Convection and Steam.

8. The amount of water in the reservoir is sufficient for one cooking operation. Water does not need to be added during cooking.
9. During and after cooking, condensed water may be on the door, oven walls and oven floor. Dry any liquid residue with a soft cloth.
10. After cooking, the display may show "Now cooling". The oven will automatically cool and you will hear the sound of the cooling fan. The fan may continue to operate up to 13 minutes depending on the oven and parts temperature.

WARNINGS:

1. The oven door, outer cabinet and oven cavity will become hot. Use pot holders or oven mitts when adding or removing foods to prevent burns.
2. Do not open the oven with your face close to the oven. Steam from the oven may cause burns.

Recipes for Balanced Meals

Brunch Medley Balanced Meal

- 2 eggs
- 2 egg whites
- 2 teaspoons fat free half and half
- 4 tablespoons fat free Cheddar cheese
- 2 grapefruit halves
- 2 teaspoons brown sugar
- 4 fully cooked turkey sausage links

Place high rack in baking tray. Beat together eggs, egg whites, half and half and Cheddar cheese until well blended. Divide into 2 greased custard cups. Place on high rack.

Sprinkle teaspoon of brown sugar on each grapefruit half and put on high rack. Put sausage links on rack.

Place baking tray on upper level. Press **SuperSteam Convection** and then program the oven for **AUTO, BALANCED MEALS, BRUNCH MEDLEY**, and press **START**.

Nutritional analysis per serving:

Calories: 280, Sodium: 600 mg, Cholesterol: 250 mg, Carbohydrate: 23 g, Fat: 10 g, Protein: 24 g

Chicken Balanced Meal

- 2 boneless chicken breasts, approximately 12 ounces
- 1 tablespoon mango curry sauce
- 1/2 pound sweet potato wedges, approximately 1/2 x 1/2 x 2 1/2 inches
- 12 fresh asparagus spears

Press **SuperSteam Convection** and then program the oven for **AUTO, BALANCED MEALS, COMPLETE DINNERS, CHICKEN** and press **START** to begin preheating.

Put high rack in baking tray. Put chicken breasts on one side. Brush with mango curry sauce. Put sweet potato wedges and asparagus spears on rack.

When preheat is over, place baking tray on upper level. Press **START**.

Nutritional analysis per serving:

Calories: 310, Sodium: 330 mg, Cholesterol: 105 mg, Carbohydrate: 17 g, Fat: 5 g, Protein: 45 g

Salmon Balanced Meal

- 1/2 cup 10-minute brown rice
- 1 cup hot tap water
- 1 cup frozen peas, thawed
- 2 4-ounce salmon fillets
- 1 tablespoon Asian hoisin glaze

Press **SuperSteam Convection** and then program the oven for **AUTO, BALANCED MEALS, COMPLETE DINNERS, SALMON** and press **START** to begin preheating.

Place brown rice in shallow 2-quart casserole. Pour hot tap water over rice. Scatter thawed peas over rice, evenly. Season salmon fillets with Asian hoisin glaze and place on top of rice mixture.

Place casserole in baking tray. When preheat is over, place on upper level. Press **START**. After cooking, remove from oven, cover with foil and allow to stand 5 minutes.

Nutritional analysis per serving:

Calories: 460, Sodium: 200 mg, Cholesterol: 75 mg, Carbohydrate: 48 g, Fat: 15 g, Protein: 33 g

AUTOMATIC COOKING

Fajita Balanced Meal

- 1 tablespoon fajita seasoning mix
- 1 tablespoon salad oil
- 1 tablespoon water
- 1/2 pound mixture of raw peeled and deveined shrimp, chicken breast strips and beef strips
- 1 cup red pepper strips
- 1 cup green pepper strips
- 1/2 cup fat-free refried beans
- 2 8-inch whole wheat tortillas

Press **SuperSteam Convection** and then program the oven for AUTO, BALANCED MEALS, COMPLETE DINNERS, FAJITAS and press **START** to begin preheating.

Mix fajita seasoning mix, oil and water together. Add to mixture of shrimp, chicken strips, beef strips, red and green pepper strips. Mix well. Spray baking tray with nonstick cooking spray and put fajita ingredients in tray.

Put refried beans in small oven-proof dish. Wrap tortillas in foil. Place both on other baking tray.

When preheat is over, place baking tray of fajita mixture on upper level. Place baking tray of refried beans and tortillas on lower level. Press **START**.

After cooking, remove from oven. Stir fajita mix and put half in each warm tortilla. Stir refried beans and serve with fajitas.

Nutritional analysis per serving:

Calories: 450 mg, Sodium: 1370 mg, Cholesterol: 100 mg, Carbohydrate: 45 g Fat: 13 g, Protein: 34 g

Pork Balanced Meal

- 2 boneless pork chops, approximately 12 ounces
- 1/2 pound zucchini strips, approximately 1/2 x 2 1/2 inches
- 1 1/3 cups new potatoes, cut into 1/2-inch wedges
- 1 teaspoon olive oil

Press **SuperSteam Convection** and then program the oven for AUTO, BALANCED MEALS, COMPLETE DINNERS, PORK and press **START** to begin preheating.

Put high rack in baking tray. Put chops on one side, zucchini and potatoes on remainder of rack. Brush all with olive oil. Season to taste.

When preheat is over, place baking tray on upper level. Press **START**.

Nutritional analysis per serving:

Calories: 330 mg, Sodium: 85 mg, Cholesterol: 100 mg, Carbohydrate: 17 g, Fat: 12 g, Protein: 38 g

Beef Kabob Balanced Meal

- 1/2 pound beef round, cut into 8 1 1/2-inch cubes
- 8 1-inch squares red pepper
- 8 1-inch squares green pepper
- 8 1-inch squares onion
- 2 10-inch wooden skewers
- 2 ears fresh corn on the cob
- 2 teaspoon olive oil
- Seasons as desired

Press **SuperSteam Convection** and then program the oven for AUTO, BALANCED MEALS, COMPLETE DINNERS, BEEF KABOBS and press **START** to begin preheating.

Alternate meat cubes and vegetable squares on skewers. Put skewers on high rack in baking tray. Put ears of corn beside kabobs. Brush all with olive oil.

When preheat is over, place baking tray on upper level. Press **START**.

Nutritional analysis per serving:

Calories: 280 mg, Sodium: 390 mg, Cholesterol: 50 mg, Carbohydrate: 20 g, Fat: 11 g, Protein: 29 g

AUTOMATIC COOKING

SUPER STEAM CONVECTION CHART

FOOD		AMOUNT	CONTAINER/RACK	OVEN LEVEL
Poultry	Whole chicken*	2.5 - 7.5 lb.	Low rack in baking tray	lower
	Chicken pieces - bone-in*	0.5 - 3.5 lb.	High rack in baking tray Add ³ / ₄ cup water to the baking tray. Remove as much fat as possible before broiling.	lower
	Chicken breasts - boneless*	0.3 - 2 lb.	High rack in baking tray Spray both sides of the breasts with nonstick cooking spray or brush with olive oil.	upper
	Turkey breast - bone-in*	3 - 8 lb.	Low rack in baking tray	lower
Meats	Beef Hamburgers - 0.25 lb, 1/2" thick*	1 - 8 patties	High rack in baking tray	upper
	Eye of round - medium rare	2 - 3 lb.	Low rack in baking tray	lower
	Meat loaf*	1 - 2 lb.	Baking tray	lower
	Pork Boneless loin	2 - 4 lb.	Low rack in baking tray	lower
	Chops - boneless*	0.5 - 2 lb.	High rack in baking tray	upper
	Chops - bone-in*	0.5 - 2.5 lb.	High rack in baking tray	upper
	Tenderloin*	1.3 - 2 lb.	Low rack in baking tray	lower
Fish	Fish steaks*	0.3 - 2 lb.	High rack in baking tray	upper
	Thick fillets (³ / ₄ to 1 inch thick.) *	0.3 - 2 lb.	High rack in baking tray	upper
Grilled vegetables*		1 - 6 servings	Baking tray	upper
Potatoes	Baked white potatoes (6 - 8 oz)	1 - 6	Low rack in baking tray Rubbed with oil.	lower
	Baked sweet potatoes (9 - 10 oz)	1 - 6	Low rack in baking tray	lower
Frozen pizza	Regular crust 12-inch*	1	High rack in baking tray	lower
	Thin crust 12-inch*	1	High rack in baking tray	lower
	Rising crust 12-inch*	1	High rack in baking tray	lower
Convenience foods	Frozen prepared poultry nuggets*	0.3 - 1.5 lb.	High rack in baking tray	upper
	patties*	0.3 - 1.5 lb.	High rack in baking tray	upper
	Refrigerated chicken nuggets*	0.3 - 1.5 lb.	High rack in baking tray	upper
	Frozen prepared fish fish sticks*	0.3 - 1.5 lb.	High rack in baking tray	upper
	fish pieces*	0.3 - 2 lb.	High rack in baking tray	upper
	Frozen French fries*	0.3 - 1.5 lb.	Baking tray Stir when the oven stops midway.	upper

* Preheat is necessary.

AUTOMATIC COOKING

STEAM

Steam has 3 options: Vegetables, Fish/Seafood and Poached Eggs.

Refer to the Steam Chart for details.

* Suppose you want to cook 6 servings of Quick Cooking, Vegetables with Standard time.

PROCEDURE

- 1** Press **Steam**, turn the **Dial** to select **AUTO** and press **Enter**.



- 2** Turn the **Dial** to select **VEGETABLES** and press **Enter**.



- 3** Turn the **Dial** to select **QUICK COOKING** and press **Enter**. See the examples and press **Enter**.

- 4** Turn the **Dial** to enter amount (6 servings) and press **Enter**.

- 5** Make sure **STANDARD** is selected and press **Enter**.

- 6** Place food in oven. Press **START**.

- 7** After cooking, **EXTEND** will appear. If you wish to extend cooking time, turn the **Dial** to add time and press **START**. If not, press **Stop/Clear**. After the oven has cooled, remove and empty the reservoir, wipe oven cavity. Wait a few minutes, then empty the drip tray.



NOTES:

1. Enter the weight or amount of the food only. Do not include the weight of the container.
2. For foods weighing more or less than weights given in the cooking charts, cook manually.
3. When the desired option is selected, you do not have to turn the **Dial** to select it. Just press **Enter**.
4. The programmed cooking times are average times. To extend cooking times preprogrammed in the automatic cooking, see **EXTENDING COOKING TIME AT THE END OF COOKING** on page 33.
5. Any Steam selection can be programmed with More or Less Time Adjustment. See page 33.
6. Keep the door closed. If opened during cooking, steam will escape and a longer cooking time will be required.
7. The amount of water in the reservoir is sufficient for one cooking operation. Water does not need to be added during cooking.
8. During and after cooking, condensed water may be on the door, oven walls and oven floor. Dry any liquid residue with a soft cloth.
9. After cooking, the display may show "Now cooling". The oven will automatically cool and you will hear the sound of the cooling fan. The fan may continue to operate up to 13 minutes depending on the oven and parts temperature.
10. Press **Enter** once at step 3 in Vegetables New potatoes, Fish/Seafood and Poached eggs.

WARNINGS:

1. The oven door, outer cabinet and oven cavity will become hot. Use pot holders or oven mitts when adding or removing foods to prevent burns.
2. Do not open the oven with your face close to the oven. Steam from the oven may cause burns.

STEAM CHART

FOOD		AMOUNT	CONTAINER/RACK	OVEN LEVEL
Vegetables	Quick Cooking	1 - 6 servings	Steam basket on high rack in baking tray	upper
	Med. Cooking (carrots, green beans)	1 - 6 servings	Steam basket on high rack in baking tray	upper
	Long Cooking (corn on the cob, acorn squash)	1 - 6 servings	Steam basket on high rack in baking tray	upper
	New potatoes (cut - 1 1/2" pieces whole 1 1/2" diameter)	0.5 - 2.5 lb	Steam basket on high rack in baking tray	upper
Fish/ Seafood	Shellfish	0.3 - 2 lb	Steam basket on high rack in baking tray	upper
	Fish fillets	0.3 - 2 lb	Steam basket on high rack in baking tray	upper
Poached eggs		1 - 6 eggs	Put each egg into a greased custard cup and place custard cup(s) in steam basket on high rack in baking tray	upper



AUTOMATIC COOKING

MICROWAVE

Microwave has 3 sensor options, Sensor Reheat, Sensor Cook and Sensor Popcorn and 2 non-sensor options, Reheat and Defrost. Refer to the each Chart in Microwave for details.

NOTES:

1. After cooking, the display may show "Now cooling". The oven will automatically cool and you will hear the sound of the cooling fan. The fan may continue to operate up to 13 minutes depending on the oven and parts temperature.
2. Do not use the baking tray and metal racks.

MICROWAVE COOKING WITH SENSOR

Sharp's Sensor is a semi-conductor device that detects the vapor (moisture and humidity) emitted from the food as it heats. The sensor adjusts the cooking times and power level for various foods and quantities.

Using Sensor Settings:

1. After the oven is plugged in, wait 2 minutes before cooking with Sensor function.
2. Be sure the exterior of the cooking container and the interior of the oven are dry. Wipe off any moisture with a dry cloth or paper towel.
3. The oven works with foods at normal storage temperature. For example, popcorn would be at room temperature.
4. Any Sensor Cook selection can be programmed with More or Less Time Adjustment. See page 33.
5. More or less food than the quantity listed in the chart should be cooked following the guidelines in any microwave cookbook.
6. During the first part of cooking with Sensor function, SENSING will appear on the display. Do not open the oven door or press **Stop/Clear** during this part of the cooking cycle. The measurement of vapor will be interrupted. If this occurs, an error message will appear. To continue cooking, press **Stop/Clear** and cook manually. When the sensor detects the vapor emitted from the food, the remainder of cooking time will appear. The door may be opened when remaining cooking time appears in the display. At this time, you may stir or season food, as desired.
7. If the sensor does not detect vapor properly, Error will be displayed, and the oven will turn off.
8. Check food for temperature or doneness after cooking. If food is not completely cooked, enter additional cooking time manually. Do not repeat cooking with Sensor function again as food may overcook.

Sensor Reheat can be set two ways:

1. Quick way See page 24.
2. Microwave, MANUAL. REHEAT and then SENSOR REHEAT

Covering Foods:

Some foods work best when covered. Use the cover recommended in the Sensor Cook Chart for these foods.





1. Casserole lid.
2. Plastic wrap: Use plastic wrap recommended for microwave cooking. Cover dish loosely; allow approximately 1/2-inch to remain uncovered to allow steam to escape. Plastic wrap should not touch food.
3. Wax paper: Cover dish completely; fold excess wrap under dish to secure. If dish is wider than paper, overlap two pieces at least one inch to cover.

Be careful when removing any covering to allow steam to escape away from you.

SENSOR POPCORN

* Suppose you want to pop a regular size popcorn with Standard time.

PROCEDURE

- 1 Press **Microwave**, turn the **Dial** to select **AUTO** and press **Enter**.

- 2 Turn the **Dial** to select **SENSOR POPCORN** and press **Enter**.

- 3 Turn the **Dial** to select **REGULAR** and press **Enter**.

- 4 Make sure **STANDARD** is selected and press **Enter**.

- 5 Press **START**.





SENSOR POPCORN CHART

FOOD	AMOUNT	PROCEDURE
Popcorn 1 package Regular, Regular light	2.85 - 3.5 oz	Use only popcorn packaged for the microwave. Try several brands to decide which you like. Do not try to pop unpopped kernels.
Mini, snack	1.2 - 1.75 oz	

AUTOMATIC COOKING

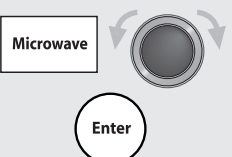
SENSOR COOK

* Suppose you want to cook 2 baked potatoes with Standard time.

PROCEDURE	
<p>1 Press Microwave, turn the Dial to select AUTO and press Enter.</p> 	<p>3 Turn the Dial to select BAKED POTATOES and press Enter.</p> 
<p>2 Turn the Dial to select SENSOR COOK and press Enter.</p> 	<p>4 Make sure STANDARD is selected and press Enter.</p> 
	<p>5 Press START.</p> 

SENSOR COOK CHART

FOOD	AMOUNT	PROCEDURE															
Baked Potatoes	1 - 6 med.	Pierce. Place on paper towel on oven floor. After cooking, remove from oven, wrap in aluminum foil and let stand 5 to 10 minutes.															
Fresh Vegetables: Quick Cooking		Wash and place in casserole. Add no water if vegetables have just been washed. Cover with lid for tender vegetables. Use plastic wrap for tender-crisp vegetables. After cooking, stir, if possible. Let stand, covered, for 2 to 5 minutes.															
Broccoli	0.25 - 2.0 lb																
Brussels sprouts	0.25 - 2.0 lb																
Cabbage	0.25 - 2.0 lb																
Caulif. (flowerets)	0.25 - 2.0 lb																
Cauliflower (whole)	1 med.																
Spinach	0.25 - 1.0 lb																
Zucchini	0.25 - 2.0 lb																
Baked apples	2 - 4 med.																
Fresh Vegetables: Longer Cooking		Place in casserole. Add 1 - 4 tbsp. water. Cover with lid for tender vegetables. Use plastic wrap cover for tender-crisp vegetables. After cooking, stir, if possible. Let stand, covered, for 2 to 5 minutes.															
Carrots, sliced	0.25 - 1.5 lb																
Corn on the cob	2 - 4																
Green beans	0.25 - 1.5 lb																
Winter squash:																	
diced	0.25 - 1.5 lb																
halves	1 - 2																
Frozen Entrees	6 - 17 oz	Use this setting for frozen, convenience foods. It will give satisfactory results for most brands. You may wish to try several and choose your favorite. Remove package from outer wrapping and follow package directions for covering. After cooking, let stand, covered for 1 to 3 minutes.															
Frozen Vegetables	0.25 - 1.5 lb	Add no water. Cover with lid or plastic wrap. After cooking, stir and let stand, covered, for 3 minutes.															
Ground Meat	0.25 - 2.0 lb	Use this setting to cook ground beef or turkey as patties or in a casserole to be added to other ingredients. Place patties on a microwave-safe rack and cover with wax paper. Place ground meat in a casserole and cover with wax paper or plastic wrap. When oven stops, turn patties over or stir meat in casserole to break up large pieces. Re-cover and press START . After cooking, let stand, covered, for 2 to 3 minutes.															
Rice	0.5 - 2.0 cups	Place rice into a deep casserole and add double quantity of water. Cover with lid or plastic wrap. After cooking, stir, cover and let stand 3 to 5 minutes or until all liquid has been absorbed.															
		<table border="1"> <thead> <tr> <th>Rice</th> <th>Water</th> <th>Size of casserole</th> </tr> </thead> <tbody> <tr> <td>.5 cup</td> <td>1 cup</td> <td>1.5 quart</td> </tr> <tr> <td>1 cup</td> <td>2 cups</td> <td>2 quart</td> </tr> <tr> <td>1.5 cups</td> <td>3 cups</td> <td>2.5 or 3 quart</td> </tr> <tr> <td>2 cups</td> <td>4 cups</td> <td>3 quart or larger</td> </tr> </tbody> </table>	Rice	Water	Size of casserole	.5 cup	1 cup	1.5 quart	1 cup	2 cups	2 quart	1.5 cups	3 cups	2.5 or 3 quart	2 cups	4 cups	3 quart or larger
Rice	Water	Size of casserole															
.5 cup	1 cup	1.5 quart															
1 cup	2 cups	2 quart															
1.5 cups	3 cups	2.5 or 3 quart															
2 cups	4 cups	3 quart or larger															

AUTOMATIC COOKING

REHEAT

Reheat allows you to heat many of your favorite foods.
 * Suppose you want to reheat 6 muffins with Standard time.

PROCEDURE

- 1** Press **Microwave**, turn the **Dial** to select **AUTO** and press **Enter**.



- 2** Turn the **Dial** to select **REHEAT** and press **Enter**.

- 3** Turn the **Dial** to select **FRESH ROLL, MUFFIN** and press **Enter**.

- 4** Turn the **Dial** to select the desired amount (6 pieces) and press **Enter**.

- 5** Make sure **STANDARD** is selected and press **Enter**.

- 6** Press **START**.



NOTES:

1. Any Reheat selection can be programmed with More or Less Time Adjustment. See page 33.
2. Enter the amount of the food only.
3. More or less food than the quantity listed in the chart should be cooked following the guidelines in any microwave cookbook.
4. The final result will vary according to the food condition (e.g. initial temperature, shape, quality). Check food temperature after heating. If additional time is needed, continue to heat manually.

SENSOR REHEAT (QUICK WAY)

* Suppose you want to reheat with Sensor Reheat with Standard time.

PROCEDURE

- 1** Press **Microwave**, turn the **Dial** to select **SENSOR REHEAT** and press **Enter**.

- 2** Make sure **STANDARD** is selected and press **Enter**.

- 3** Press **START**.



REHEAT CHART

FOOD	AMOUNT	PROCEDURE
Sensor Reheat	4 - 36 oz	Place in dish or casserole slightly larger than amount to be reheated. Flatten, if possible. Cover with lid, plastic wrap or wax paper. Use covers such as plastic wrap or lids with larger quantities of more dense foods such as stews. After reheating, stir well, if possible. Re-cover and allow to stand 2 to 3 minutes. Foods should be very hot. If not, continue to heat with variable power and time.
Beverage	0.5 - 2.0 cups	This setting is good for restoring cooled beverage to a better drinking temperature. Stir liquid briskly before and after heating to avoid "eruption".
Fresh Roll, Muffin	1 - 8 pieces	Use this setting to warm fresh rolls, muffins, biscuits, bagels, etc. Large items should be considered as 2 or 3 regular size. Arrange on plate; cover with paper towel.
Frozen Roll, Muffin	1 - 8 pieces	Use this setting to warm frozen rolls, muffins, biscuits, bagels, etc. Large items should be considered as 2 or 3 regular size. Arrange on plate; cover with paper towel.

AUTOMATIC COOKING

DEFROST

Defrost automatically defrosts all the foods shown in the Defrost Chart.

* Suppose you want to defrost a 2.0 pound steak with Standard time.

PROCEDURE

- 1** Press **Microwave**, turn the **Dial** to select **AUTO** and press **Enter**.

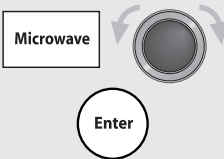
- 2** Turn the **Dial** to select **DEFROST** and press **Enter**.



- 3** Turn the **Dial** to select the desired food **STEAKS, CHOPS** and press **Enter**.



- 4** Turn the **Dial** to select the desired amount **2.0 lb.** and press **Enter**.



- 5** Make sure **STANDARD** is selected and press **Enter**.



- 6** Press **START**.

- 7** The oven will stop and directions will be displayed. Follow the indicated message. Press **START**.

- 8** After cooking, **EXTEND** will appear. If you wish to extend defrosting time, turn the **Dial** to add time and press **START**. If not, press **Stop/Clear**.

NOTES:

1. Enter the weight of the food only. Do not include the weight of the container.
2. Any Defrost selection can be programmed with More or Less Time Adjustment. See page 33.
3. To defrost other foods or foods above or below the weights allowed on DEFROST CHART below, use time and 30% power. See MANUAL DEFROST on page 32.
4. The programmed defrosting times are average times. To extend defrosting times preprogrammed in the automatic operation, see EXTENDING COOKING TIME AT THE END OF COOKING on page 33.

DEFROST CHART

FOOD	AMOUNT	PROCEDURE
Ground Meat	0.5 - 2.0 lb	Remove any thawed pieces after each stage. Let stand, covered, for 5 to 10 minutes.
Chicken Bone-in	0.5 - 3.0 lb	Arrange pieces with meatiest portions toward outside of glass dish or microwave-safe rack. After each stage, if there are warm or thawed portions, rearrange or remove. Let stand, covered, for 10 to 20 minutes.
Chicken Boneless	0.5 - 2.0 lb	After each stage, if there are warm or thawed portions, rearrange or remove. Let stand, covered, for 10 to 20 minutes.
Steaks, Chops	0.5 - 3.0 lb	After each stage, rearrange and if there are warm or thawed portions, shield with small flat pieces of aluminum foil. Remove any meat or fish that is nearly defrosted. Let stand, covered, for 10 to 20 minutes.

MANUAL COOKING

Manual Cooking is an option in Steam, SuperSteam Convection, Convection and Microwave. Refer to the Manual Cooking Chart. The chart gives information on each setting.

MANUAL COOKING CHART

		Preheat *	Temp range	Adjustment temp during cooking	Time range	2 level cooking
SuperSteam Convection	Roast	YES or NO	200 - 450°F	YES	0 - 2h30m	NO
	Broil	YES or NO	-	NO	0 - 2h30m	NO
	Convenience Food	YES or NO	200 - 450°F	YES	0 - 2h30m	YES
Convection	Bake or Roast	YES or NO	200 - 450°F	YES	0 - 2h30m	YES
	Broil	YES or NO	-	NO	0 - 2h30m	NO
Steam	Cook	NO	-	NO	0 - 35m	NO
	Reheat	NO	-	NO	0 - 35m	NO
	Keep Warm	NO	-	NO	0 - 2h30m	NO
	Proof	NO	100°F	NO	0 - 2h30m	NO
Microwave	Manual	-	0 - 100% power	-	0 - 1h30m	NO
	Keep Warm	-	-	-	0 - 30m	NO

* Preheat temperature is held for 30 minutes.

NOTE:

Always check the charts and recipes in the separate SuperSteam Oven Cookbook for recommended cooking times, correct cooking option, hints and techniques.

COOKING TIME INPUT

Your oven can be programmed for up to 2 hours 30 minutes depending on the cooking mode. Refer to the chart. The input unit increment varies from 5 seconds to 5 minutes, depending on the total length of time and cooking mode as shown in the table.

COOKING TIME INPUT

Your oven can be programmed for temperatures from 200°F to 450°F, which can be adjusted every 25°F with an initial setting is 350°F.

ITEM	INPUT STEP
Temperature	25°F per step (350°F is initial temperature) (200, 225, 250, 275, 300, 325, 350, 375, 400, 425, 450)
Cooking Time except Microwave	0 - 15 min. : 30 sec. per step
	15 min. - 1 hour : 1 min. per step
	1 hour - Max : 5 min. per step
Cooking Time Microwave	0 - 2 min. : 5 sec. per step
	2 - 5 min. : 10 sec. per step
	5 - 10 min. : 30 sec. per step
	10 - 30 min. : 1 min. per step
	30 - 90 min. : 5 min. per step

MANUAL COOKING

SUPER STEAM CONVECTION

Manual SuperSteam Convection has 3 functions: SuperSteam Roast, SuperSteam Broil and SuperSteam Convenience Foods, and each function has 2 options, With Preheat or Without Preheat. Use SuperSteam Convection for cooking foods that need to retain moisture and have a crisp brown exterior.

SUPER STEAM ROAST

Use SuperSteam Roast for roasting meat or poultry with superheated steam. See SuperSteam Convection Roast Chart in the cookbook.

SuperSteam Roast can be programmed for up to 2 hours 30 minutes. Oven temperature can be set between 200°F and 450°F in 25°F increments.

* Suppose you want to cook Cornish hens at a temperature of 375°F for 1 hour and 10 minutes with preheating.

PROCEDURE

- 1** Press **SuperSteam Convection**, turn the **Dial** to select **MANUAL** and press **Enter**.

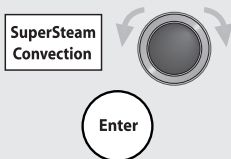
- 2** Turn the **Dial** to select **SUPER STEAM ROAST** and press **Enter**.



- 3** Turn the **Dial** to select **WITH PREHEAT**. Press **Enter**.

- 4** Turn the **Dial** to enter the desired temperature **375°F** and press **Enter**.

- 5** Turn the **Dial** to enter the desired cooking time **1 hour and 10 minutes**.

- 6** Press **START** to preheat. No food in oven.

- 7** When preheat is over, place food on low rack in baking tray on lower level. Close the door.
- 8** Press **START**.

- 9** After cooking, **EXTEND** will appear. If you wish to extend cooking time, turn the **Dial** to add time and press **START**. If not, press **Stop/Clear**. After the oven has cooled, remove and empty the reservoir, wipe oven cavity. Wait a few minutes, then empty the drip tray.



SUPER STEAM BROIL

Use SuperSteam Broil for broiling when desiring a moist interior and brown exterior. See SuperSteam Broil/Convection Broil Chart in cookbook. SuperSteam Broil can be programmed for up to 2 hours 30 minutes. Oven temperature cannot be changed.

* Suppose you want to broil a steak for 15 minutes with preheating.

PROCEDURE

- 1** Press **SuperSteam Convection**, turn the **Dial** to select **MANUAL** and press **Enter**.

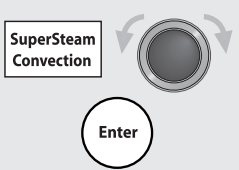

- 2** Turn the **Dial** to select **SUPER STEAM BROIL** and press **Enter**.



- 3** Turn the **Dial** to select **WITH PREHEAT**. Press **Enter**.

- 4** Turn the **Dial** to enter the desired cooking time **15 minutes**.

- 5** Press **START** to preheat. No food in oven.

- 6** When preheat is over, place food on high rack in baking tray on upper level. Close the door.
- 7** Press **START**.

- 8** After cooking, **EXTEND** will appear. If you wish to extend cooking time, turn the **Dial** to add time and press **START**. If not, press **Stop/Clear**. After the oven has cooled, remove and empty the reservoir, wipe oven cavity. Wait a few minutes, then empty the drip tray.



MANUAL COOKING

SUPER STEAM CONVENIENCE FOODS

Use SuperSteam Convenience Foods for cooking convenience foods that should be moist on the inside and brown and crisp on the outside. See the Bake Chart in cookbook. SuperSteam Convenience Foods can be programmed for up to 2 hours 30 minutes.

Oven temperature can be set between 200°F and 450°F in 25°F increments. SuperSteam Convenience Foods can cook with 2 levels cooking.

* Suppose you want to cook frozen chicken cutlets at 375°F for 10 minutes with preheating.

PROCEDURE

- 1** Press **SuperSteam Convection**, turn the **Dial** to select **MANUAL** and press **Enter**.

- 2** Turn the **Dial** to select **SUPER STEAM CONVENIENCE FOODS** and press **Enter**.

- 3** Turn the **Dial** to select **WITH PREHEAT**. Press **Enter**.

- 4** Turn the **Dial** to enter the desired temperature **375°F** and press **Enter**.

- 5** Turn the **Dial** to enter the desired cooking time **10 minutes**.

- 6** Press **START** to preheat. No food in oven.

- 7** When preheat is over, place food on high rack in baking tray on upper level. Close the door.
- 8** Press **START**.

- 9** After cooking, **EXTEND** will appear. If you wish to extend cooking time, turn the **Dial** to add time and press **START**. If not, press **Stop/Clear**. After the oven has cooled, remove and empty the reservoir, wipe oven cavity. Wait a few minutes, then empty the drip tray.



NOTES:

1. If the oven door is not opened after preheating, the oven will hold the preheat temperature for 30 minutes and then time of day or home page will be displayed.
2. To program only preheat, press **START** after entering the desired preheat temperature. For Broil, press **START** after selecting **WITH PREHEAT**. Preheat will start. When the oven reaches the programmed temperature, follow the message in the display.
3. To extend cooking time, see **EXTENDING COOKING TIME AT THE END OF COOKING** on page 33.
4. Keep the door closed. If opened during cooking, steam will escape and a longer cooking time will be required.
5. The amount of water in the reservoir is sufficient for one cooking operation. Water does not need to be added during cooking.
6. During and after cooking, condensed water may be on the door, oven walls and oven floor. Dry any liquid residue with a soft cloth.
7. After cooking, the display may show "Now cooling". The oven will automatically cool and you will hear the sound of the cooling fan. The fan may continue to operate up to 13 minutes depending on the oven and parts temperature.

WARNINGS:

1. The oven door, outer cabinet and oven cavity will become hot. Use pot holders or oven mitts when adding or removing foods to prevent burns.
2. Do not open the oven with your face close to the oven. Steam from the oven may cause burns.

MANUAL COOKING

CONVECTION

Manual Convection has 2 functions, Bake or Roast and Broil, and each function has 2 options, With Preheat or Without Preheat. Use Convection as you would use as a conventional oven. There is no need to change traditional cooking times. This mode does not use steam. Convection can be programmed for up to 2 hours 30 minutes. Oven temperature for Bake or Roast can be set between 200°F and 450°F in 25°F increments. Broil is a pre-set temperature, so oven temperature cannot be changed. Bake or Roast can cook with 2-level cooking. It is necessary to select 1 or 2 levels in programming.

BAKE or ROAST

* Suppose you want to bake biscuits using 2 levels with Bake or Roast at a temperature of 450°F for 10 minutes with preheating.

PROCEDURE	
1 Press Convection , turn the Dial to select BAKE OR ROAST and press Enter .	
2 Turn the Dial to select WITH PREHEAT . Press Enter .	
3 Turn the Dial to select 2 LEVELS cooking and press Enter .	
4 Turn the Dial to enter the desired temperature 450°F and press Enter .	
5 Turn the Dial to enter the desired cooking time 10 minutes.	
6 Press START to preheat. No food in oven.	
7 When preheat is over, place baking trays on upper and lower levels. Close the door.	
8 Press START .	
9 After cooking, EXTEND will appear. If you wish to extend cooking time, turn the Dial to add time and press START . If not, press Stop/Clear .	

BROIL

* Suppose you want to broil flank steak for 20 minutes with preheating.

PROCEDURE	
1 Press Convection , turn the Dial to select BROIL and press Enter .	
2 Turn the Dial to select WITH PREHEAT . Press Enter .	
3 Turn the Dial to enter the desired cooking time 20 minutes.	
4 Press START to preheat. No food in oven.	
5 When preheat is over, place food on high rack in baking tray on upper level in the oven. Close the door.	
6 Press START .	
7 After cooking, EXTEND will appear. If you wish to extend cooking time, turn the Dial to add time and press START . If not, press Stop/Clear .	

WARNINGS:

1. The oven door, outer cabinet and oven cavity will become hot. Use pot holders or oven mitts when adding or removing foods to prevent burns.
2. Do not open the oven with your face close to the oven. Steam from the oven may cause burns.

NOTES:

1. If the oven door is not opened after preheating, the oven will hold the preheat temperature for 30 minutes and then time of day or home page will be displayed.
2. To program only preheat, press **START** after entering the desired preheat temperature. For Broil, press **START** after selecting **WITH PREHEAT**. Preheat will start. When the oven reaches the programmed temperature, follow the message in the display.
3. To extend cooking times, see **EXTENDING COOKING TIME AT THE END OF COOKING** on page 33.
4. Keep the door closed. If opened during cooking, heat will escape and a longer cooking time will be required.
5. After cooking, the display may show "Now cooling". The oven will automatically cool and you will hear the sound of the cooling fan. The fan may continue to operate up to 13 minutes depending on the oven and parts temperature.

MANUAL COOKING

STEAM





STEAM has 4 functions: Steam Cook, Steam Reheat, Steam Keep Warm and Proof.

STEAM COOK

Use Steam Cook to steam foods such as fish, chicken or vegetables. Steam cooks food gently without destroying shape, color or aroma. The Steam mode can be programmed up to 35 minutes.

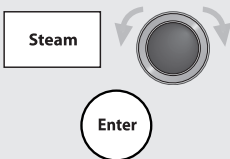
* Suppose you want to Steam Cook for 20 minutes.

PROCEDURE

- 1 Press **Steam**, turn the **Dial** to select **MANUAL** and press **Enter**.

- 2 Turn the **Dial** to select **STEAM COOK** and press **Enter**.

- 3 Turn the **Dial** to enter the desired cooking time 20 minutes.

- 4 Put food in steam basket on high rack in baking tray on upper level. Press **START**.

- 5 After cooking, **EXTEND** will appear. If you wish to extend cooking time, turn the **Dial** to add time and press **START**. If not, press **Stop/Clear**.

STEAM REHEAT

Use Steam Reheat to reheat gently without drying. Steam Reheat can be programmed up to 35 minutes. * Suppose you want to reheat rice for 20 minutes.

PROCEDURE

- 1 Press **Steam**, turn the **Dial** to select **MANUAL** and press **Enter**.

- 2 Turn the **Dial** to select **STEAM REHEAT** and press **Enter**.

- 3 Turn the **Dial** to enter the desired cooking time 20 minutes.

- 4 Press **START**.

- 5 After cooking, **EXTEND** will appear. If you wish to extend cooking time, turn the **Dial** to add time and press **START**. If not, press **Stop/Clear**.

MANUAL COOKING

STEAM KEEP WARM

Use Steam Keep Warm to keep food warm without drying. Steam Keep Warm can be programmed for up to 2 hours 30 minutes.

* Suppose you want to keep food warm for 20 minutes.

PROCEDURE	
<p>1 Press Steam, turn the Dial to select MANUAL and press Enter.</p>	
<p>2 Turn the Dial to select STEAM KEEP WARM and press Enter.</p>	
<p>3 Turn the Dial to enter the desired time 20 minutes.</p>	
<p>4 Press START.</p>	
<p>5 After cooking, EXTEND will appear. If you wish to extend cooking time, turn the Dial to add time and press START. If not, press Stop/Clear. After the oven has cooled, remove and empty the reservoir, wipe oven cavity. Wait a few minutes, then empty the drip tray.</p>	

PROOF

Use Proof to aid dough rising when making regular or sweet yeast breads. Proof can be programmed for up to 2 hours 30 minutes.

* Suppose you want to proof bread dough for 20 minutes.

PROCEDURE	
<p>1 Press Steam, turn the Dial to select MANUAL and press Enter.</p>	
<p>2 Turn the Dial to select PROOF and press Enter.</p>	
<p>3 Turn the Dial to enter the desired proofing time 20 minutes.</p>	
<p>4 Press START.</p>	
<p>5 After cooking, EXTEND will appear. If you wish to extend cooking time, turn the Dial to add time and press START. If not, press Stop/Clear. After the oven has cooled, remove and empty the reservoir, wipe oven cavity. Wait a few minutes, then empty the drip tray.</p>	

NOTES:

- To extend steaming times, see **EXTENDING COOKING TIME AT THE END OF COOKING** on page 33.
- Keep the door closed. If opened during cooking, steam will escape and a longer cooking time will be required.
- The amount of water in the reservoir is sufficient for one cooking operation. Water does not need to be added during cooking.
- During and after cooking, condensed water may be on the door, oven walls and oven floor. Dry any liquid residue with a soft cloth.
- After cooking, the display may show "Now cooling". The oven will automatically cool and you will hear the sound of the cooling fan. The fan may continue to operate up to 13 minutes depending on the oven and parts temperature.

WARNINGS:

- The oven door, outer cabinet and oven cavity will become hot. Use pot holders or oven mitts when adding or removing foods to prevent burns.
- Do not open the oven with your face close to the oven. Steam from the oven may cause burns.

MANUAL COOKING

MICROWAVE

Manual Microwave has 2 functions: microwave cooking and keep warm.



NOTES:

1. After cooking, the display may show "Now cooling". The oven will automatically cool and you will hear the sound of the cooling fan. The fan may continue to operate up to 13 minutes depending on the oven and parts temperature.
2. Do not use the baking tray and metal racks.

MICROWAVE TIME COOKING

* Suppose you want to cook for 5 minutes at 100% power level.

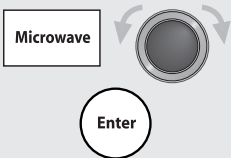
PROCEDURE

- 1 Press **Microwave**, turn the **Dial** to select **MANUAL** and press **Enter**.

- 2 Turn the **Dial** to enter the desired cooking time 5 minutes and press **START**.

TO SET POWER LEVEL

There are eleven preset power levels. Using lower power levels increases the cooking time which is recommended for foods such as cheese, milk and long slow cooking of meats. Consult a microwave cookbook or recipes for specific recommendations.



POWER LEVEL CHART

APPROXIMATE PERCENTAGE OF POWER	COMMON WORDS FOR POWER LEVELS
100%	High
90%	
80%	
70%	Medium High
60%	
50%	Medium
40%	
30%	Med Low / Defrost
20%	
10%	Low
0%	

* Suppose you want to defrost for 5 minutes at 30% power level.

PROCEDURE

- 1 Press **Microwave**, turn the **Dial** to select **MANUAL** and press **Enter**.

- 2 Turn the **Dial** to enter defrosting time 5 minutes and press **Enter**.

- 3 Turn the **Dial** to select power level 30%.

- 4 Press **START**.

MANUAL DEFROST

If the food that you wish to defrost is not listed on the DEFROST CHART or is above or below the limits in the "Amount" column on the DEFROST CHART on page 25, you need to defrost manually.

You can defrost any frozen food, either raw or previously cooked, by using Power Level 30%.

Follow the exact 4-step procedure found under MICROWAVE TIME COOKING, TO SET POWER LEVEL.

Estimate defrosting time and select 30% when you select the power level.

For either raw or previously cooked frozen food the rule of thumb is approximately 5 minutes per pound. For example, defrost 5 minutes for 1 pound of frozen spaghetti sauce. Always stop the oven periodically to remove or separate the portions that are defrosted. If food is not defrosted at the end of the estimated defrosting time, program the oven in 1 minute increments on Power Level 30% until totally defrosted.



When using plastic containers from the freezer, defrost only long enough to remove from the plastic in order to place in a microwave-safe dish.

KEEP WARM

Use Keep Warm to keep food at serving temperature.

* Suppose you want to keep a cup of soup warm for 15 minutes.

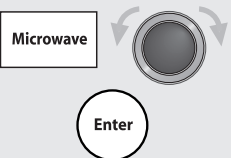
PROCEDURE

- 1 Press **Microwave**, turn the **Dial** to select **KEEP WARM** and press **Enter**.

- 2 Turn the **Dial** to enter the desired keep warm time 15 minutes and press **START**.

OTHER CONVENIENT FEATURES

AUTOMATIC COOKING TIME ADJUSTMENT (MORE OR LESS TIME ADJUSTMENT)

You can adjust cooking results as you like.

Should you discover that you like any automatic settings slightly **more** done, select MORE in the cooking time page before **START**.

The display will show MORE.

Should you discover that you like any automatic settings slightly **less** done, select LESS in the cooking time page before **START**.

The display will show LESS .

EXTENDING COOKING TIME AT THE END OF COOKING

Cooking results may vary depending on room temperature, initial food temperature and other factors. You can adjust cooking results by adding more cooking time at the end. When cooking is finished, the display will show "EXTEND". It is only possible to add extra time during the 5 minutes when "EXTEND" is in the display. The time can be extended up to 10-30 minutes depending on cooking mode. Turn the Dial for the desired time and then press **START**. The same cooking mode will be continued. Carefully check the cooking process.

NOTES:

1. If "Fill water reservoir" is displayed when **START** is pressed, fill the reservoir to the 2 mark. Position and push firmly into place.
2. Extend mode is canceled when **Stop/Clear** is pressed.
3. EXTEND is available depending cooking mode. See below. The Extending Cooking Time function can be repeated until the food is cooked as you desire.

		Extend time at end
SuperSteam Convection	Auto	0 - 30 min
	Manual	0 - 30 min
Convection	Manual	0 - 30 min
Steam	Auto	0 - 10 min
	Manual	0 - 10 min
Microwave	Auto: except Defrost	No
	Auto: Defrost	0 - 10 min
	Manual	No
	Keep Warm	No

TEMPERATURE ADJUSTMENT

To change the oven temperature during cooking in Manual Operations with SuperSteam Convection Roast, SuperSteam Convection Convenience Foods and Convection Bake or Roast, simply turn the Dial to increase or decrease in 25°F increments and then press **Enter**.

If **Enter** is not pressed within 5 seconds, the temperature will revert to the initial temperature that you selected.

END OF COOKING REMINDER

At end of cooking, the oven will signal and repeat after 2 and 4 minutes unless door is opened or **Stop/Clear** is pressed.



OTHER CONVENIENT FEATURES

MULTIPLE SEQUENCE COOKING

SUPER STEAM CONVECTION AND CONVECTION

There are 3 patterns in Super Steam Convection and Convection which can be programmed into Multiple Sequence Cooking.

- ① Preheat + Bake or Roast (Convection) + Bake or Roast (Convection)
- ② Preheat + Roast (Super Steam Convection) + Bake or Roast (Convection)
- ③ Preheat + Convenience Foods (Super Steam Convection) + Bake or Roast (Convection)

• Preheat can be omitted.

* Suppose you want to cook in Sequence Cooking with Preheating in patterns ②.

1st stage is at a temperature of 375°F for 1 hour and 10 minutes.

2nd stage is at a temperature of 400°F for 10 minutes.

PROCEDURE

1 For 1st stage, follow the steps 1 to 5 in single SuperSteam Convection. See SuperSteam Roast on page 27.

2 Press **Convection** to program the second stage. 

3 Turn the **Dial** to enter the desired temperature 400°F and press **Enter**. 

4 Turn the **Dial** to enter the desired cooking time 10 minutes. 

5 Press **START**. 

MICROWAVE

Your oven can be programmed for up to 4 automatic cooking sequences, switching from one power level setting to another automatically. Sometimes cooking directions tell you to start on one power level and then change to a different power level.

- Suppose you want to cook for 5 minutes at 30% and then continue to cook for 30 minutes at 50%.

PROCEDURE

1 For 1st stage, follow the steps 1 to 3 in manual microwave cooking under To Set Power Level, page 32.

2 Press **Microwave** to program the second stage. 

3 Turn the **Dial** to enter cooking time 30 minutes and press **Enter** to proceed. 

4 Turn the **Dial** to select power level 50%. 

5 Press **START**. 



OTHER CONVENIENT FEATURES

INFO

Back/Info provides 9 features and step-by-step instructions for special functions.

MAINTENANCE	SETTINGS
DRAIN WATER DESCALE STEAM CLEAN	CLOCK CONTRAST SOUND ON/OFF DEMO MODE CHILD LOCK SLEEP MODE

These features can be selected by pressing **Back/Info** in time of day or home page and then turning the **Dial** and pressing **Enter**.

DRAIN WATER

The remaining water inside the steam generator can be evaporated by using the DRAIN WATER function. See page 15.

DESCALE

See page 15.

STEAM CLEAN

See page 36.

CLOCK

See page 16.

CONTRAST

Contrast can adjust display darkness or brightness.

PROCEDURE

- 1 Press **Back/Info**, turn the **Dial** to select CONTRAST and press **Enter**.
- 2 Turn the **Dial** to adjust contrast and press **Enter** to keep the adjustment. The contrast setting will be held in the memory even if the oven power is off.

SOUND ON/OFF

You can mute the oven.

PROCEDURE

- 1 Press **Back/Info**, turn the **Dial** to select SOUND ON/OFF and press **Enter**.
- 2 Turn the **Dial** to select SOUND OFF and press **Enter**. The sound setting will be held in the memory even if the oven power is off.

NOTE:

To cancel the mute setting, select SOUND ON at Step 2.

DEMONSTRATION MODE

Cooking operations and special features can be demonstrated with no power in the oven.

PROCEDURE

- 1 Press **Back/Info**, turn the **Dial** to select DEMO MODE and press **Enter**.
- 2 Turn the **Dial** to select DEMO ON and press **Enter**.

NOTE:

To cancel Demonstration Mode, select DEMO OFF at step 2 or unplug the oven from the electrical outlet and re-plug.

CHILD LOCK

Child Lock prevents unwanted oven operation such as by small children. The oven can be set so that the control panel is deactivated and locked.

PROCEDURE

- 1 Press **Back/Info**, turn the **Dial** to select CHILD LOCK and press **Enter**.
- 2 Press **Enter**.

NOTES:

1. To cancel Child Lock, press **Enter** and hold for 3 seconds.
2. When the oven power is off, the setting returns to OFF.

SLEEP MODE

Sleep Mode means that the display backlight will be automatically turned off if the oven is not used for 15 minutes. Initial setting of the sleep mode is ON.

PROCEDURE

- 1 Press **Back/Info**, turn the **Dial** to select SLEEP MODE and press **Enter**.
- 2 Turn the **Dial** to select SLEEP MODE ON and press **Enter**. The sleep mode setting will be held in the memory even if the oven power is off.

NOTES:

1. To cancel Sleep Mode, select SLEEP MODE OFF at step 2.
2. You can press any pad, turn the **Dial** or open and close the door to activate backlight ON when the display backlight is off in Sleep Mode ON.

CLEANING AND CARE

CLEAN THE OVEN REGULARLY. Spatters and residue remaining from prolonged use, especially at high temperatures, are hard to clean and may interfere with good oven operation as well as decrease the useful life of the oven.

IMPORTANT CAUTIONS:

- DISCONNECT THE POWER CORD IF POSSIBLE.
- ALLOW THE OVEN TO COOL BEFORE CLEANING.
- DO NOT USE OVEN CLEANERS OR HARSH SCOURING PADS ON ANY PART OF THE OVEN.
- DO NOT USE A STEAM CLEANER.

Oven Cleaning - Exterior

Prepare a solution of mild soap and water, immerse a soft cloth or sponge into the solution and wring dry. Wipe exterior. Do not use any type of harsh abrasive cleaner. Rinse cloth or sponge in warm water and wring dry. Wipe exterior again and polish dry.

Door

Wipe the window on both sides with a damp cloth to remove any spills or spatters. Metal parts will be easier to maintain if wiped frequently with a soft damp cloth. Avoid the use of spray and other harsh cleaners as they may stain, streak or dull the door surface. When cleaning surfaces of door and oven that come together on closing the door, use only mild, non abrasive soaps, or detergents applied with a sponge or soft cloth.

Control Panel

Care should be taken in cleaning the control panel. If the control panel becomes soiled, open the oven door before cleaning. Wipe the panel with a cloth dampened slightly with water only. Dry with a soft cloth. Do not scrub or use any sort of chemical cleaners. Close the door and press **Stop/Clear**.

Oven Cleaning - Interior

STEAM CLEAN

The Steam Clean function helps to loosen any grease, oil or food residue. The steam will make the oven easy to clean; however, it is not a self-cleaning function. It will take approximately 20 minutes for the cleaning cycle.

PREPARATION

1. Make sure that the reservoir is filled with fresh cold tap water and is installed. (See page 13.)
2. Make sure that the empty drip tray is installed. (See page 13.)

PROCEDURE

- 1 Press **Back/Info**, turn the **Dial** to select **STEAM CLEAN** and press **Enter**.

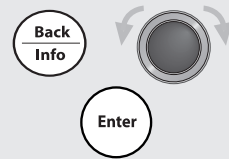

- 2 Press **START**.

START

Allow the oven to cool to prevent burns. Then open the door and remove any residue carefully with soft, damp cloth. Finally, remove and empty the reservoir. Wait a few minutes, then empty the drip tray.

To clean the interior surfaces, wipe with a soft cloth and warm water.

1. After every use while the oven is still warm, wipe spatters or spills with a soft damp cloth or sponge. **DO NOT USE ABRASIVE OR HARSH CLEANERS OR SCOURING PADS.** For heavier soil, use mild soap; rinse thoroughly with hot water. Carry out Steam Clean function to clean thoroughly.
2. The cleaning cloth or sponge must be wrung dry to prevent moisture or residue from entering the oven vents.
3. Do not use spray type cleaners on the oven interior.
4. Any remaining food or fat could cause smoke or an unpleasant smell. It is a good idea to heat the oven with SuperSteam Convection Broil in manual operation for 20 minutes without preheat and food to remove any fat or residue from the interior ducts and heaters and unpleasant smell. See **CLEAN THE OVEN BEFORE FIRST USE** on page 16



CLEANING AND CARE

Door Gasket

The door gasket is essential for a good seal. Always keep the gasket clean to prevent any damage. If water condenses inside the door gasket, wipe dry with a soft cloth. Polish with another soft cloth. Do not use a chemical or abrasive cleaner on these surfaces. Care should be taken not to rub, damage, pull or move the gasket. Before cooking, always check that door gasket is lying smooth and flat. If not, steam will leak from the door. Do not use SuperSteam Oven if it has a damaged door gasket as steam would not be contained in the oven. Consult a Sharp Authorized Service.

Baking Tray / High Rack / Low Rack / Steam Basket

Wash baking tray, high rack, low rack and steam basket after cooking with a mild soap or detergent solution, rinsing and polishing dry. Do not use harsh cleaners, sharp metal scrapers or stiff brushes to prevent damage to the easy clean surface. All the accessories can be washed in the dishwasher. Place them on the top rack in the dishwasher.

Reservoir and Reservoir Lid

After cooking, wash in a mild soap or detergent solution with a soft damp cloth or sponge, rinse and polish dry. Do not wash in the dishwasher. Note the filter in the rear bottom of the reservoir. Use a very soft brush to remove any build-up in the filter. The filter cannot be removed nor replaced so special care should be taken not to tear the mesh of the filter when cleaning it. Do not use harsh cleaners, sharp metal scrapers or stiff brushes on the reservoir, reservoir lid and reservoir filter. Do not use a torn filter. Order replacement. See inside front cover.

Drip Tray and Drip Tray Lid

Empty drip tray after cooking, wash in a mild soap or detergent solution with a soft damp cloth or sponge, rinse, polish dry and replace below the oven front. Do not wash in the dishwasher.

Descaling within the Oven's Steam Parts

During steam production, scale may form in the steam generator. To remove scale, carry out descale function when DESCALING IS NECESSARY. is shown in the display. See page 15 for complete instructions.

TROUBLESHOOTING CHART

If EE is displayed or you think the oven is not working properly, check the chart below before consulting a Sharp Authorized Servicer. This will help to prevent unnecessary service calls.

TROUBLESHOOTING CHART ERROR MESSAGE / INFORMATION MESSAGE

MESSAGE ON DISPLAY		ACTION
ERROR MESSAGE	EE	Due to technical error, call service for your nearest Sharp Authorized Servicer.
SENSOR ERROR	Finish cooking by time. Press Clear.	The sensor does not detect vapor properly in microwave sensor mode. Press Stop/Clear and finish cooking using manual time.
INFORMATION MESSAGE	Wait. Oven is too warm to use.	The oven is too hot to use Microwave Defrost or Steam Proof. Remove food from oven and allow to cool until the message clears.
	Water is frozen.	The oven may not operate properly. Operate the oven with Convection Broil without food and preheat for 5 minutes. See page 29.
	Now cooling.	After cooking, the oven and the parts will be hot. Now cooling is shown in the display until the oven cavity has cooled. The cooling fan may continue to operate up to 13 minutes. Now cooling will disappear when the oven has cooled. If you wish to use the warm oven, simply press Stop/Clear .
	Replace drip tray.	Remove and replace the drip tray correctly. See page 13. In case the drip tray is not installed correctly, Replace drip tray will be shown in the display.
	Empty drip tray and replace.	Empty drip tray and replace will be shown in the display when water remains in the drip tray. You must empty the drip tray and replace it before SuperSteam Convection or Steam Cooking will start. See page 13.
	Descaling is necessary.	Follow step-by-step instructions for descaling. See page 15.
	Fill water reservoir.	Remove reservoir and fill with water to the 2 mark. Replace and push firmly into place.
	Hot	The oven cabinet and oven cavity are very hot. Pay extra attention not to burn yourself.

TROUBLESHOOTING CHART

The following situations are normal and are not signs that the oven is malfunctioning.

QUESTION / SITUATION		ANSWER
Control panel / power supply	The display is black / blank.	<ul style="list-style-type: none"> * Check that power plug is connected to a suitable wall outlet. See page 4. * Check that fuse or circuit breaker is functioning properly. If not, correct. * Disconnect the oven from the power source, wait one minute and then plug into the wall outlet. If the problem exists, consult a Sharp Authorized Servicer.
	The display is fine but START will not function when pressed.	<ul style="list-style-type: none"> * Open the door and close. Is the oven light off? Press START again. * If the display says, "Wait. Oven is too warm to use.", be sure to wait until it disappears and then press START.
	Electrical power supply is interrupted during cooking.	The cooking program will be cancelled. Continue to cook with manual operation. Check food carefully as it cooks.
	Oven light is off during PROOF.	Normal operation to prevent bread dough from drying on the surface.
	Oven light is off during descaling.	This is normal operation. See page 15.
	Oven light is off when door is opened.	Oven light will turn OFF if the door is open for more than 5 minutes.
	The display backlight is off.	Sleep Mode may be ON. Press any pad, turn the Dial or open/close the door to activate display backlight. See page 35 to cancel Sleep Mode.



TROUBLESHOOTING CHART

The following situations are normal and are not signs that the oven is malfunctioning.

QUESTION / SITUATION		ANSWER
Steam	Water is found inside the oven when the door is opened.	Steam has condensed inside the oven. Wipe dry with a sponge.
	Steam comes out of the air ventilation openings at the top of the oven.	It is normal for used steam to come from the air ventilation opening on the top of the oven.
	Condensed water can be seen in the oven cavity.	This operation is normal. Steam has condensed on the oven floor. Wipe dry with a soft cloth.
	Steam comes from the door during cooking.	Check the door gasket to make sure it is lying smoothly and flat.
Noise / Sound	Noise during microwave cooking.	When microwaving, you may hear the magnetron cycling on and off depending on the power level.
	Noise after cooking.	* The cooling fan will operate until the oven is cool. * The fan may continue to operate up to 13 minutes depending on the oven and parts temperatures.
	Noise when cooking with high temperature.	High temperatures may cause expansion of the oven's components. This is normal.
	No sound when the pads are pressed.	Sound is turned OFF . See page 35 to cancel sound off.
Smoke / Aroma	When using the oven for the first time, it may smoke or smell.	See page 16 for step-by-step instructions for cleaning the oven before the first use.
	The oven cavity smells after cooking.	See CLEAN THE OVEN BEFORE FIRST USE on page 16 for step-by-step instructions for removing the aroma.
Others	Time appearing in the display is counting down very rapidly.	Check Demonstration Mode on page 35 and cancel.

SERVICE CALL CHECK

Please check the following before calling for service:

- Place one cup of water in a glass measuring cup in the oven and close the door securely.
Operate the oven for two minutes on Microwave, HIGH 100% power.
 - Does the oven light come on? YES _____ NO _____
 - Does the cooling fan work? YES _____ NO _____
(Put your hand over the air vent opening at the top.)
 - Is the water in the oven hot? YES _____ NO _____
- Remove water from the oven and operate the oven for 5 minutes on Manual Convection, Bake or Roast 450°F.
 - Does the Convection icon **CONV** appear in the display? YES _____ NO _____
 - After the oven stops, is inside of the oven hot? YES _____ NO _____
- Fill the reservoir with water and replace.
Operate the oven for 3 minutes on Manual Steam.
 - After the oven stops, is the inside of the oven filled with steam? YES _____ NO _____

If "NO" is the answer to any of the above questions, please check electrical outlet, fuse and/or circuit breaker. If they are functioning properly, CONTACT YOUR NEAREST SHARP AUTHORIZED SERVICER. A microwave oven should never be serviced by a "do-it-yourself" repair person.

NOTE: If the oven is set for more than about 12 minutes at 100(700W) or 90(630W) percent power level, output power will become 600W after 15 minutes to avoid overcooking.

SPECIFICATIONS

AC Line Voltage:	Single phase 120V, 60Hz, AC only
AC Power Required:	1.04 kW 9.0A (Microwave) 1.5 kW 12.5A (Convection)
Output Power:	
Microwave	700W* (IEC Test Procedure)
Convection Heater	1450W
Frequency:	2450 MHz
Outside Dimensions (WxHxD):	21 3/4" x 17 1/4" x 18 3/8" 553 mm x 438 mm x 468 mm
Cavity Dimensions (WxHxD)**:	14 1/8" x 10 1/8" x 13 3/8" 359 mm x 256 mm x 339 mm
Oven Capacity **:	1.1 cft
Weight:	Approx. 51 lbs. 23 kg

* The International Electrotechnical Commission's standardized method for measuring output wattage. This test method is widely recognized.

** Internal capacity is calculated by measuring maximum width, depth and height. Actual capacity for holding food is less.

SHARP®

SHARP ELECTRONICS CORPORATION
Sharp Plaza, Mahwah, NJ 07495-1163

TINSEB183WRRZ-D81
Printed in Thailand