

# SHARP®

MODEL

# FO-475

**FACSIMILE**

OPERATION MANUAL



1. Installation
2. Using the Answering Machine
3. Sending Documents
4. Receiving Documents
5. Making Copies
6. Making Telephone Calls
7. Special Functions
8. Option Settings
9. Printing Reports and Lists
10. Maintenance
11. Troubleshooting

# SHARP

## WARRANTY

*Facsimile Products*

### Congratulations on Your Purchase!

This Sharp product is warranted against manufacturing defects for a period of twelve (12) months from the date of original purchase.

In the event of any defect arising in the equipment during the warranty period, such repairs should only be carried out by the Dealer from which the unit was originally purchased or a Service Centre approved by Sharp to service this type of equipment. These repairs would be carried out at no charge to the owner, subject to the conditions specified herein.

The owner is responsible for any transportation and insurance costs if the product has to be returned for repair.

This warranty does not extend to accessories or defects or injuries caused by or resulting from causes not attributable to faulty parts or the manufacture of the product, including but not limited to, defect or injury caused by or resulting from misuse, abuse, neglect, accidental damage, improper voltage, liquid spillage, vermin infestation, software, use of consumables other than those approved by Sharp, or any alterations made to the product which are not authorised by Sharp.

Please retain your sales documentation, as this should be produced to validate a warranty claim.

This warranty is in addition to and in no way limits, varies or excludes any express and implied rights and remedies under any relevant legislation in the country of sale. However, to the extent permitted by such legislation, Sharp excludes any liability for any indirect or consequential damages arising from the purchase or use of the product.

To the extent permitted by law, Sharp excludes all implied warranties and conditions and where the product is one that is not normally required for personal, domestic or household use, Sharp limits its liability to the repair or replacement (at Sharp's option) of materials or workmanship which are found by Sharp to be defective.

For your reference, please enter the particulars of your purchase below and retain, with your purchase documentation.

Model No. \_\_\_\_\_

Serial No. \_\_\_\_\_

Date of Purchase \_\_\_\_\_

Place of Purchase \_\_\_\_\_

SPform046 (2Sept97)

FOR LOCATION ENQUIRIES WITHIN

### AUSTRALIA

REGARDING YOUR LOCAL  
SHARP APPROVED SERVICE CENTRE

CALL THE  
SHARP SERVICE REFERRAL CENTRE

**FREECALL: 1 800 807 820**

FACSIMILE: (02) 9672 1210

DURING NORMAL BUSINESS HOURS

SHARP CORPORATION OF AUSTRALIA PTY. LIMITED  
A.C.N. 003 039 405

1 Huntingwood Drive, Huntingwood NSW 2148

FOR THE SERVICING OF PRODUCTS

PURCHASED IN

### NEW ZEALAND

CONTACT YOUR SELLING DEALER/RETAILER

OR FOR REFERRAL TO A

SERVICE CENTRE,

CALL SHARP CUSTOMER SERVICES

TELEPHONE: **09 634 2059**

FACSIMILE: 09 636 6972

SHARP CORPORATION OF NEW ZEALAND LIMITED

Cnr Mahunga Drive & Hastie Avenue,  
Mangere, AUCKLAND

Important Notice: This warranty applies only to products sold in Australia & New Zealand

# QUICK REFERENCE GUIDE

## INSTALLATION

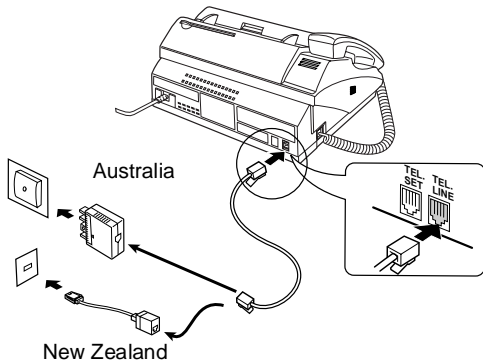

1. Connect the handset as shown.
2. Plug the power cord into an earthed, 230-240 V outlet.
3. Plug one end of the telephone line into the **TEL. LINE** socket on the rear of the fax, and the other end into your telephone wall socket.  
**Caution:** When disconnecting the fax, unplug the telephone line before the power cord.
4. If desired, connect an extension phone to the **TEL. SET** socket on the rear of the fax.

## RECORDING AN OUTGOING MESSAGE

1. Press: **FUNCTION** **0** **#** **START/MEMORY**
2. Press a number to select the type of outgoing message (OGM):  
 General OGM: **0**  
 Box 1 OGM: **1**  
 Box 2 OGM: **2**  
 Box 3 OGM: **3**  
 Transfer OGM: **4**
3. Pick up the handset, press the **START/MEMORY** key, and speak into the handset.
4. When finished, replace the handset or press the **STOP** key. Press the **STOP** key twice to return to the date and time display.

## ENTERING YOUR NAME AND NUMBER

1. Press: **FUNCTION** **3** **#** **#**

Display shows: **OWN NUMBER SET**

2. Press: **START/MEMORY**
3. Enter your fax number (max. of 20 digits) by pressing the number keys.  
 ♦ If you make a mistake, press the **HOLD/SEARCH** key to move the cursor back to the mistake, then enter the correct number or letter.

4. Press: **START/MEMORY**

5. Enter your name by pressing the appropriate number keys as shown below.

- ♦ To enter two letters in succession that require the same key, press the **SPEAKER** key after entering the first letter.

A = (2) (2)	J = (5) (5)	T = (8) (8)
B = (2) (2) (2)	K = (5) (5) (5)	U = (8) (8) (8)
C = (2) (2) (2) (2)	L = (5) (5) (5) (5)	V = (8) (8) (8) (8)
D = (3) (3)	M = (6) (6)	W = (9) (9)
E = (3) (3) (3)	N = (6) (6) (6)	X = (9) (9) (9)
F = (3) (3) (3) (3)	O = (6) (6) (6) (6)	Y = (9) (9) (9) (9)
G = (4) (4)	P = (7) (7)	Z = (9) (9) (9) (9) (9)
H = (4) (4) (4)	Q = (7) (7) (7)	SPACE = (1) (1)
I = (4) (4) (4) (4)	R = (7) (7) (7) (7)	
	S = (7) (7) (7) (7) (7)	

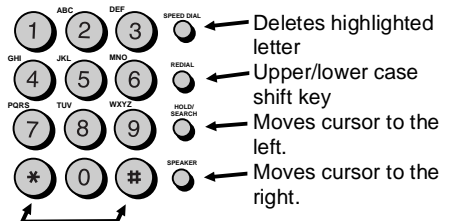

Press either key one or more times to select and enter a symbol.

6. When finished, press: **START/MEMORY** **STOP**

# QUICK REFERENCE GUIDE

## SETTING THE DATE AND TIME

Press:

Display shows: DATE & TIME SET

Press the **START/MEMORY** key:

- Enter two digits for the Day (01 through 31).
- Enter two digits for the Month (01 through 12).
- Enter four digits for the Year (Ex: 1998).
- Enter two digits for the Hour (00 through 23).
- Enter two digits for the Minute (00 through 59).
- When finished, press:

## STORING AND CLEARING NUMBERS FOR AUTO DIALLING

1. Press:

Display shows: FAX/TEL # MODE

- 2. Press **1** to store a number or **2** to clear a number.
- 3. Enter a 2-digit Speed Dial number (from 01 to 10 for Rapid Key Dialling, or 11 to 30 for Speed Dialling). (If you are clearing a number, go to Step 7.)
- 4. Enter the full telephone/fax number.
- 5. Press:
- 6. Enter the name of the location by pressing number keys (max. of 20 characters). (Refer to the letter entry table in *ENTERING YOUR NAME AND NUMBER*.)
- 7. Press:

## SENDING DOCUMENTS

Place your document (up to 10 pages) face down in the document feeder.

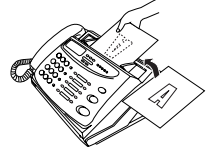

### Normal Dialling

- 1. Lift the handset or press
- 2. Dial the fax number.
- 3. Wait for the reception tone (if a person answers, ask them to press their Start key).
- 4. Press:

### Rapid Key Dialling

Press the appropriate Rapid Key. Transmission will begin automatically.

### Speed Dialling

- 1. Press:
- 2. Enter 2-digit Speed Dial number.
- 3. Press:

## RECEIVING DOCUMENTS

Press:



**FAX mode:** The fax automatically answers on two rings and receives the incoming document.

**TEL/FAX mode:** The fax automatically answers and receives incoming documents. Voice calls are signalled by a special ringing sound.

**TEL mode:**

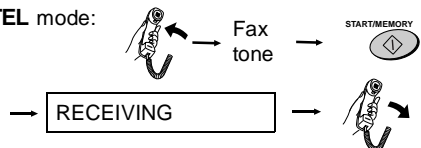

**ANS. mode:** Select this mode when you want to receive voice messages in the answering machine.

---

# Introduction

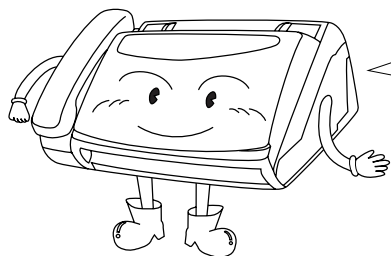

Welcome, and thank you for choosing a Sharp facsimile! The features and specifications of your new Sharp fax are shown below.

<b>Automatic dialling</b>	Rapid Key Dialling: 10 numbers Speed Dialling: 20 numbers
<b>Memory size*:</b>	512 KB (approx. 20 average pages with no voice messages recorded, or 24 minutes of voice messages (including OGMs) with no documents in memory)
<b>Fax paper</b>	Initial starter roll (included with fax machine): 10 m roll Recommended replacement roll: FO-40PR 50 m roll
<b>Automatic document feeder</b>	10 sheets max.
<b>Paper cutting method:</b>	Automatic cutter
<b>Modem speed</b>	9600 bps with automatic fallback to 7200, 4800, or 2400 bps
<b>Transmission time*</b>	Approx. 15 seconds (Sharp special mode)
<b>Display</b>	16-digit LCD display
<b>Reception modes</b>	FAX, TEL, TEL/FAX, ANS.
<b>Resolution</b>	<b>Horizontal:</b> 8 lines/mm <b>Vertical:</b> Standard: 3.85 lines/mm Fine/Halftone: 7.7 lines/mm Super fine (transmission only): 15.4 lines/mm

\* Based on ITU-T Test Chart #1 at standard resolution in Sharp special mode, excluding time for protocol signals (i.e., ITU-T phase C time only).

<b>Halftone (greyscale)</b>	64 levels
<b>Recording system</b>	Thermal recording
<b>Applicable telephone line</b>	Public switched telephone network
<b>Compatibility</b>	ITU-T (CCITT) G3 mode
<b>Configuration</b>	Half-duplex, desktop transceiver
<b>Compression scheme</b>	MH, MR, Sharp
<b>Scanning method</b>	Sheet-feeder CIS (Contact Image Sensor)
<b>Effective printing width</b>	210 mm max.
<b>Input document size</b>	<b>Automatic feeding:</b> Width: 148 to 216 mm Length: 140 to 297 mm <b>Manual feeding:</b> Width: 148 to 216 mm Length: 140 to 600 mm
<b>Effective scanning width</b>	210 mm max.
<b>Contrast control</b>	Automatic/Dark selectable
<b>Copy function</b>	Standard
<b>Telephone function</b>	Standard (Cannot be used if power fails)
<b>Power requirements</b>	230-240 V AC, 50 Hz
<b>Operating temperature</b>	5 to 35°C
<b>Humidity</b>	Maximum: 85 %
<b>Power consumption</b>	Stand-by: 6.0 W Maximum: 120 W
<b>Dimensions</b>	Width: 308 mm Depth: 256 mm Height: 138 mm (without handset in cradle)
<b>Weight</b>	Approx. 2.6 kg

As a part of our policy of continuous improvement, SHARP reserves the right to make design and specification changes for product improvement without prior notice. The performance specification figures indicated are nominal values of production units. There may be some deviations from these values in individual units.

## ***Important safety information***

- For your safety, if any of your equipment is not operating properly or should any physical damage occur to the equipment where internal parts may become exposed, the equipment should be immediately disconnected from the phone line and then the power line and returned to a SHARP authorised Service Centre for inspection, repair, or disposal.
- In Australia, installing or modifying telephone lines should only be done by an ACA licensed serviceman. In New Zealand, installing or modifying telephone lines should be done in accordance with Telecom wiring practices.
- Do not disassemble this machine or attempt any procedures not described in this manual. Refer all servicing to qualified service personnel.
- This machine must only be connected to a 230-240 V, 50 Hz, grounded (3-prong) outlet. Connecting it to any other kind of outlet may damage the machine.
- Do not install or use the machine near water, or when you are wet. Take care not to spill any liquids on the machine.
- Unplug the machine from the Telephone socket and then the power outlet and consult a qualified service representative if any of the following situations occur:
  - Liquid has been spilled into the machine or the machine has been exposed to rain or water.
  - The machine produces odors, smoke, or unusual noises.
  - The power cord is frayed or damaged.
  - The machine has been dropped or the housing damaged.
- Do not allow anything to rest on the power cord, and do not install the machine where people may walk on the power cord.
- Never insert objects of any kind into slots or openings on the machine. This could create a risk of fire or electric shock. If an object falls into the machine that you cannot safely remove, unplug the machine and consult a qualified service representative.
- Do not place this machine on an unstable cart, stand or table. The machine could be seriously damaged if it falls.
- Never install telephone wiring during a lightning storm.

- Never install telephone sockets in wet locations unless the socket is specifically designed for wet locations.
- Never touch uninsulated telephone wires or terminals unless the telephone line has been disconnected at the network interface.
- Use caution when installing or modifying telephone lines.
- Avoid using a telephone (other than a cordless type) during an electrical storm. There may be a remote risk of electric shock from lightning.
- Do not use a telephone in the vicinity of a gas leak.
- The socket-outlet must be installed near the equipment and must be easily accessible.
- To make emergency calls, any other calls in progress must first be released.

**Important:**

- This facsimile machine is not designed for use on a line which has call waiting, call forwarding, or certain other special services offered by your telephone company. If you attempt to use the fax machine on a telephone line using any of these services, you may experience errors during transmission and reception of facsimile messages.
- This facsimile machine is not compatible with digital telephone systems.
- This facsimile machine is designed to operate in Australia and New Zealand only.



**WARNING NOTICE:**

**NO** calls can be made to or from this fax during a mains power failure.

**WARNING** — Australian Communications Authority (ACA) regulations state that no unauthorised changes or modifications to this equipment are permitted.

**Note:** Complies with ACA and NZ TELECOM standard AS/NZS3548 regarding emission of electromagnetic interference.

These limits are designed to provide reasonable protection against interference in an installation. This equipment generates, uses and can radiate radio frequency energy and, if not installed and used in accordance with the instructions, may cause interference. However, there is no guarantee that interference will not occur in a particular installation.

If this equipment does cause interference to radio or television reception, which can be determined by turning the equipment off and on, the user is encouraged to try to correct the interference by one or more of the following measures:

- Reorient or relocate the receiving antenna.
- Increase the separation between the equipment and the receiver.
- Connect the equipment to an outlet on a different circuit to that which the receiver is connected.
- Consult the dealer or an experienced radio/TV technician for help.

**For Australia:** The Ringer Equivalence Number (REN) for this equipment is written on the back of the machine.

The sum of all the Ringer Equivalence Numbers (REN's) on your telephone line should not exceed 3 to assure correct service from your telephone company.

## **IMPORTANT NOTICE FOR NEW ZEALAND USERS**

Please note:

The grant of a Telepermit for any item of terminal equipment indicates only that Telecom has accepted that the item complies with the minimum conditions for connection to its network.

It indicates no endorsement of the product by Telecom, nor does it provide any sort of warranty. Above all, it provides no assurance that any item will work correctly in all respects with another item of Telepermitted equipment of a different make or model, nor does it imply that any product is compatible with all of Telecom's network services.

This equipment is not capable, under all operating conditions, of correct operation at the higher speeds for which it is designed. Telecom will accept no responsibility should difficulties arise in such circumstances.

This equipment shall not be set up to make automatic calls to the Telecom '111' Emergency Service.

To avoid telephone charges for local calls, be sure to store numbers "without area code in your rapid or speed dial locations.

If a charge for local calls is unacceptable, the "Dial" button should NOT be used for local calls. Only the 7-digits of the local number should be dialled from your telephone. DO NOT dial the area code digit or "0" prefix.

This equipment may not provide for the effective hand-over of a call to another device connected to the same line.

This device may be subject to ringing or bell tinkle when certain other devices are connected to the same line. If this occurs, the problem should not be referred to the Telecom Faults Service.

All persons using this device for recording telephone conversations shall comply with New Zealand law. This requires that at least one party to the conversation is to be aware that it is being recorded. In addition, the Principles enumerated in the Privacy Act 1993 shall be complied with in respect to the nature of the personal information collected, the purpose for its collection, how it is used and what is disclosed to any other party.

---

# **Table of Contents**

<b>1</b>	<b>Installation</b>	<b>1</b>
	Unpacking Checklist . . . . .	1
	A Look at the Operation Panel . . . . .	2
	Connections . . . . .	5
	Original Document Support . . . . .	10
	Loading the Fax Paper . . . . .	10
	Entering Your Name and Fax Number . . . . .	14
	Setting the Date and Time . . . . .	17
	Selecting the Reception Mode . . . . .	19
	Volume Adjustment . . . . .	20
<b>2</b>	<b>Using the Answering Machine</b>	<b>22</b>
	Recording an Outgoing Message . . . . .	22
	Operating the Answering Machine . . . . .	25
	Optional Answering Machine Settings . . . . .	29
	Transfer Function . . . . .	33
	Override Ringing . . . . .	36
	Remote Operations . . . . .	38
<b>3</b>	<b>Sending Documents</b>	<b>46</b>
	Transmittable Documents . . . . .	46
	Loading the Document . . . . .	48
	Resolution and Contrast . . . . .	50
	Sending a Fax by Normal Dialling . . . . .	52
	Sending a Fax by Automatic Dialling . . . . .	54
<b>4</b>	<b>Receiving Documents</b>	<b>63</b>
	Using TEL/FAX Mode . . . . .	63
	Using ANS. Mode . . . . .	64
	Using FAX Mode . . . . .	64
	Using TEL Mode . . . . .	65
<b>5</b>	<b>Making Copies</b>	<b>67</b>
<b>6</b>	<b>Making Telephone Calls</b>	<b>68</b>

<b>7</b>	<b>Special Functions</b>	<b>70</b>
	Caller ID . . . . .	70
	Distinctive Ring . . . . .	75
	Blocking Reception of Unwanted Faxes. . . . .	77
	Polling (Requesting a Fax Transmission) . . . . .	79
	Timer Operations. . . . .	82
	Memory . . . . .	84
	Broadcasting . . . . .	87
	Reminder Function . . . . .	89
<b>8</b>	<b>Option Settings</b>	<b>92</b>
<b>9</b>	<b>Printing Reports and Lists</b>	<b>98</b>
<b>10</b>	<b>Maintenance</b>	<b>103</b>
<b>11</b>	<b>Troubleshooting</b>	<b>105</b>
	Problems and Solutions . . . . .	105
	Messages and Signals . . . . .	110
	Clearing Paper Jams . . . . .	112
	<b>Index</b>	<b>114</b>

# Installation

## Unpacking Checklist

Before setting up, make sure you have all of the following items.



If any are missing, contact your dealer or retailer.

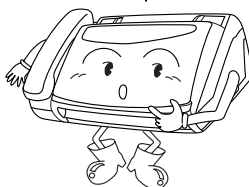

Handset



Handset lead

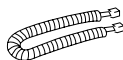

Fax paper (sample roll)

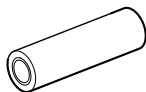

Paper guide

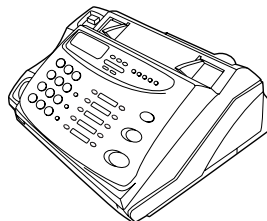

Rapid key labels

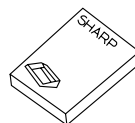

Operation manual



Telephone line cord



Adapter (for Australia)

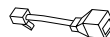

Adapter (for New Zealand)



Business products dealer installation report

## A Look at the Operation Panel

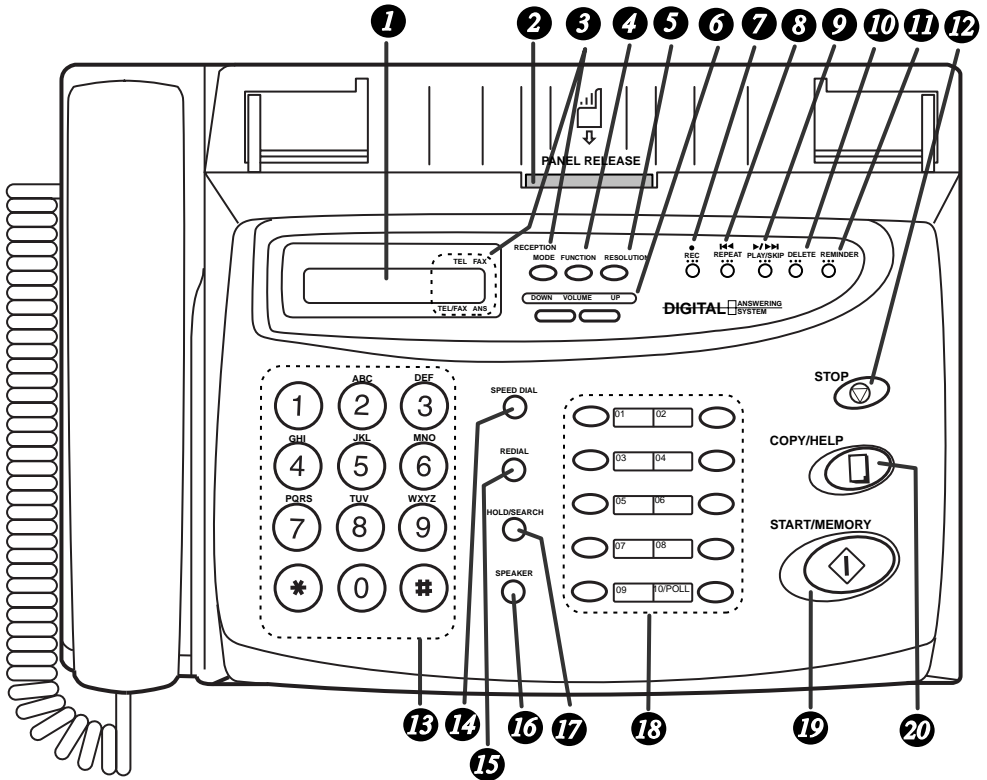

- 1 Display**  
This displays messages and prompts during operation and programming.
- 2 PANEL RELEASE**  
Pull this release toward you to open the operation panel.
- 3 RECEPTION MODE key**  
Press this key to select the reception mode. An arrow in the display will point to the currently selected reception mode.
- 4 FUNCTION key**  
Press this key to select various special functions.

- 5 RESOLUTION key**  
Press this key to adjust the resolution and contrast before sending or copying a document.
- 6 VOLUME keys**  
Press these keys to adjust the volume of the speaker when the **SPEAKER** key has been pressed, or the volume of the ringer at all other times.
- 7 REC key**  
Press this key to record a phone conversation or a message.
- 8 REPEAT key**  
Press this key to repeat playback of a message.
- 9 PLAY/SKIP key**  
Press this key to play recorded messages. During playback, press it to skip forward to the next message.
- 10 DELETE key**  
Press this key to erase recorded messages.
- 11 REMINDER key**  
Press this key to send a fax and/or voice message to another party or to yourself at a preset time.
- 12 STOP key**  
Press this key to stop operations before they are completed.
- 13 Number keys**  
Use these keys to dial numbers, and enter numbers and letters during number/name storing procedures.
- 14 SPEED DIAL key**  
Press this key to dial a 2-digit Speed Dial number.
- 15 REDIAL key**  
Press this key to automatically redial the last number dialled.

### **16** **SPEAKER key**

Press this key to hear the line and fax tones through the speaker before sending a document, or dialling a voice number.

Note: **This is not a speakerphone.** You must pick up the handset to talk with the other party.

### **17** **HOLD/SEARCH key**

Press this key to search for an automatic dialling number, or, during a phone conversation, press this key to put the other party on hold.

### **18** **Rapid Dial Keys**

Press one of these keys to dial a fax or voice number automatically. (Note that you must attach the Rapid Key labels.)

### **19** **START/MEMORY key**

Press this key to send or receive a document manually when off hook.

### **20** **COPY/HELP key**

When a document is in the feeder, press this key to make a copy. At any other time, press this key to print out the Help List, a quick reference guide to the operation of your fax.



## Connections

### Points to keep in mind when setting up

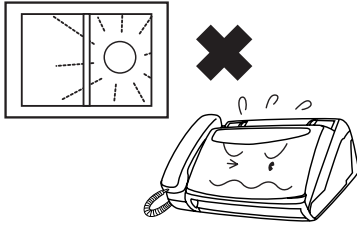

Do not place the machine in direct sunlight.

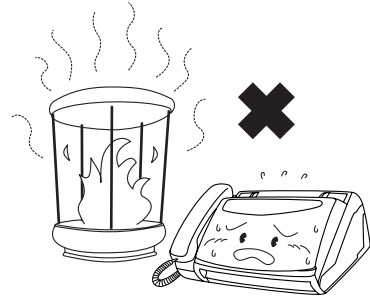

Do not place the machine near heaters or air conditioners.

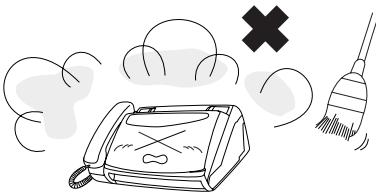

Keep dust away from the machine.

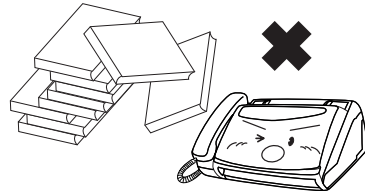

Keep the area around the machine clear.

### About condensation

If the machine is moved from a cold to a warm place, it is possible that condensation may form on the scanning glass, preventing proper scanning of documents for transmission. To remove the condensation, turn on the power and wait approximately two hours before using the machine.

## Handset

Connect the handset as shown and place it on the handset rest.

- ◆ The ends of the handset lead are identical, so they will go into either socket.

Make sure the handset cord goes into the unmarked socket on the side of the machine!

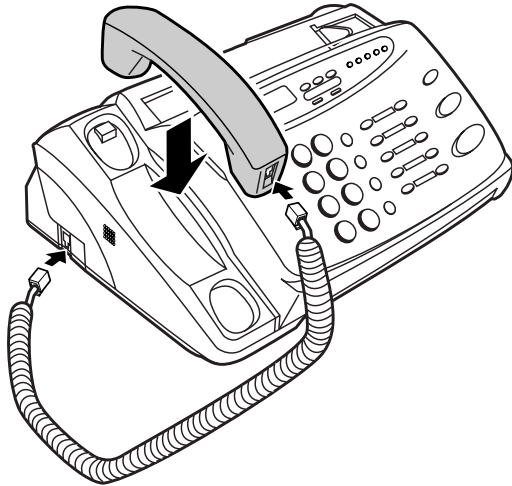
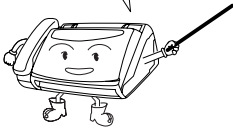

Use the handset to make ordinary phone calls, or to transmit and receive documents manually.

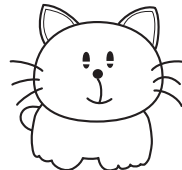

## Power lead

Plug the power lead into a 230-240 V, 50 Hz, earthed (3-prong) AC outlet.

- ◆ **Caution:** When disconnecting the fax, unplug the telephone line cord before unplugging the power lead.
- ◆ **Caution:** The mains outlet (socket outlet) should be installed near the equipment and be easily accessible.

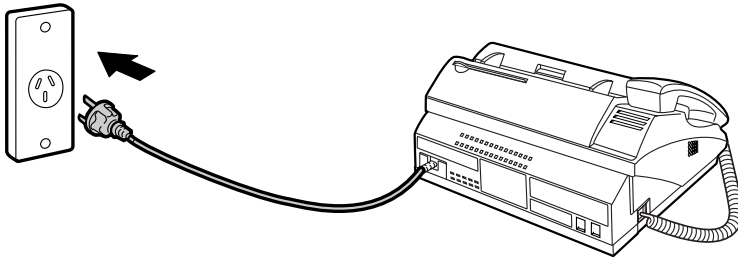

The machine does not have a power on/off switch, so the power is turned on and off by simply plugging or unplugging the power lead.

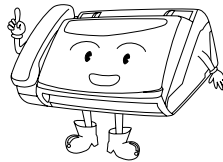

**Note:** If your area experiences a high incidence of lightning or power surges, we recommend that you install surge protectors for the power and telephone lines. Surge protectors can be purchased at most telephone specialty stores.

## Moving your fax and reconnecting

Should it be necessary to move your fax to a new location, first disconnect the telephone line cord before disconnecting the power lead. When reconnecting, it is necessary to connect the power lead before connecting the telephone line cord.

## Telephone line cord

Insert one end of the telephone line cord into the adapter. Insert the other end of the line cord into the socket on the back of the fax marked **TEL. LINE**. Plug the adapter into the telephone socket on the wall.

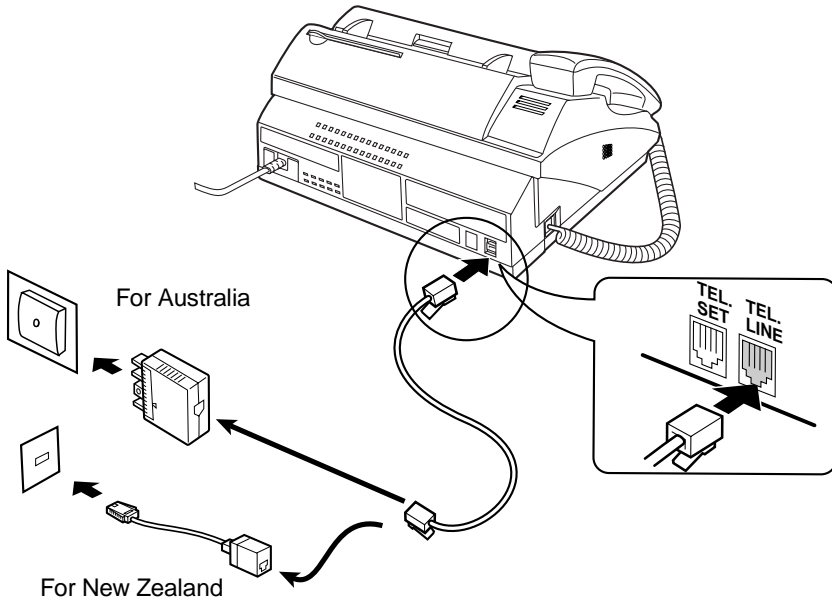

Be sure to insert the telephone line cord into the **TEL. LINE** socket. **Do not** insert it into the **TEL. SET** socket.

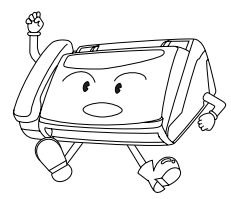

### Comments:

- Your fax is set for tone dialling. If you are on a pulse only dial line, you must set the fax for pulse dialling by changing Option Setting 7. This procedure is described in Chapter 8, *Option Settings*.
- If you intend to use a computer fax modem on the same phone line, you must reset Option Setting 12 (Fax Signal Receive) to NO in order to prevent transmission and reception errors. This procedure is described in Chapter 8, *Option Settings*.

## Extension phone (optional)

If desired, you can connect an extension phone to the **TEL. SET** socket on the fax.

- 1 Remove the seal covering the **TEL. SET** socket.

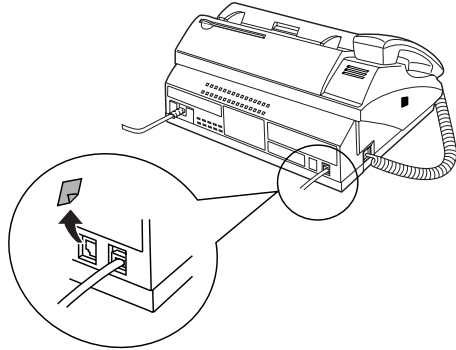

- 2 Connect the extension phone line to the **TEL. SET** socket.

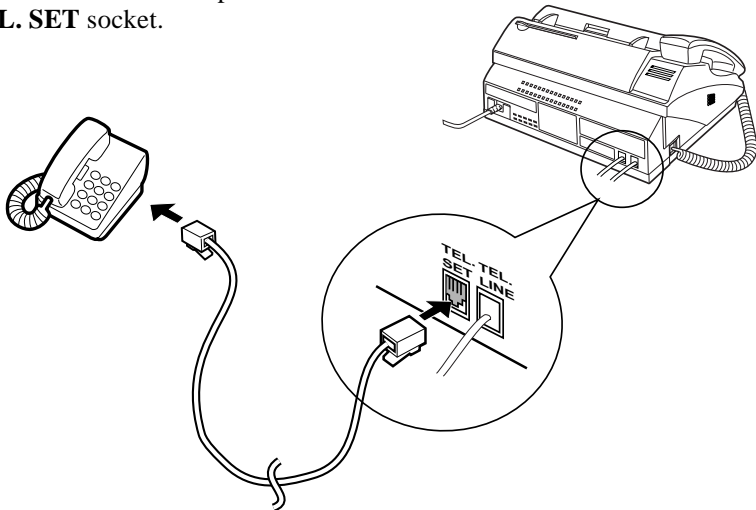

**Important:** In New Zealand, not all standard telephones and answering machines will respond to incoming ringing when connected to the extension socket of the equipment.

## Original Document Support

Rotate the original document support so that it points straight out.

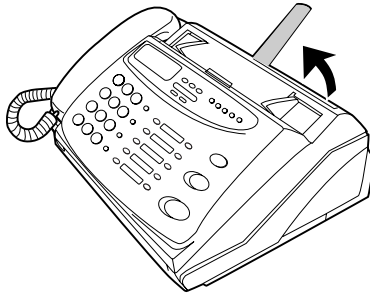

## Paper Guide

Attach the paper guide by inserting the ends into the holes in the front of the fax as shown.

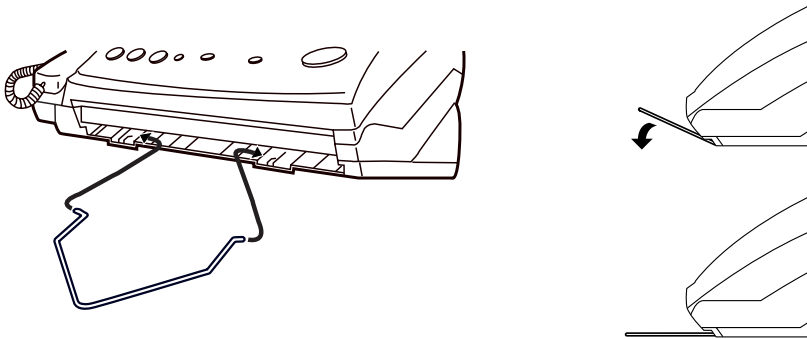

## Loading the Fax Paper

Your fax machine prints incoming faxes on a special kind of paper called thermal paper.



The fax's print head creates text and images by applying heat to the thermal paper.

**Note:** The power must be on (plug in the power cord) when loading fax paper in the fax machine.

- 1** Pull the release marked **PANEL RELEASE** toward you and open the operation panel.

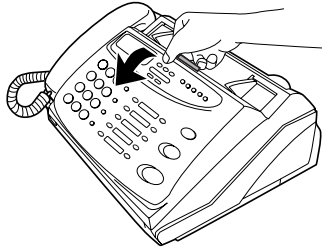

- 2** Remove the packing paper from the paper compartment.

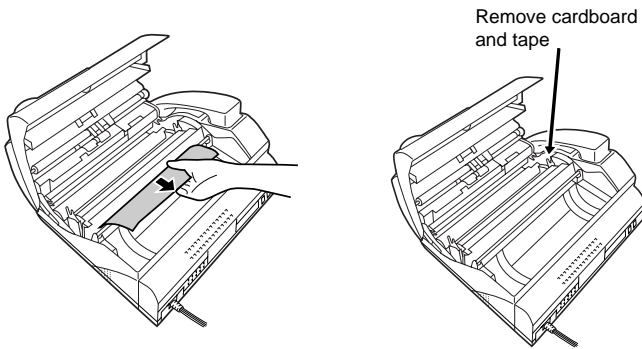

- 3** Unwrap the roll of fax paper and place it in the compartment.

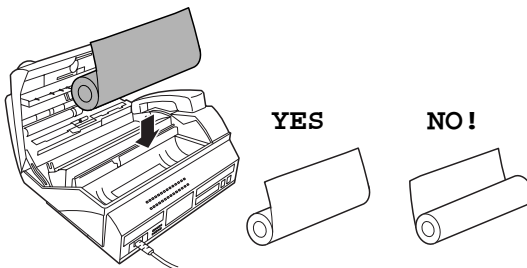

- **Important:** The roll must be placed so that the leading edge of the paper unrolls as shown. (The paper is only coated on one side for printing. If the roll is placed backwards, the paper will come out blank after printing.)

---

## Loading the Fax Paper

---

- 4** Insert the leading edge of the paper into the paper inlet. Continue to push the paper through the inlet until it comes out of the opening in the front of the fax.

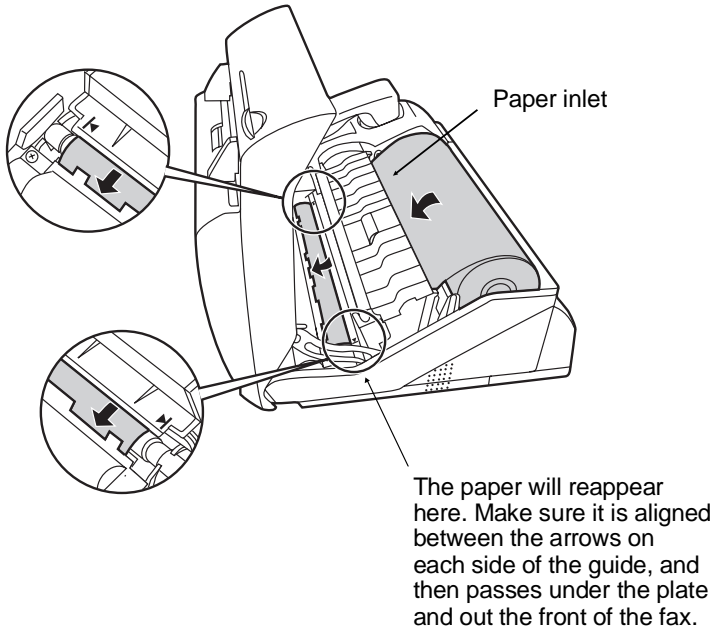

- 
- 5** Close the operation panel, making sure it clicks into place.

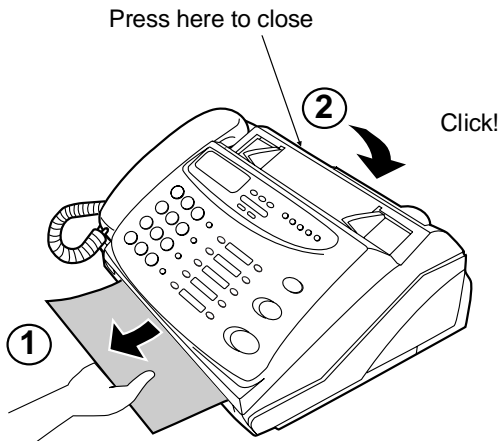



- 6** A short length of the fax paper will feed out and be cut off. (If this doesn't happen, repeat the loading procedure.)

**Note:** The fax has a built-in anti-curl mechanism that will help to reduce paper curling problems. The anti-curl mechanism will be more effective at the beginning of the paper roll and less effective towards the end.

## Replacing the fax paper

When the paper runs out, OUT OF PAPER will appear in the display. Reception and copying will no longer be possible. To replace the paper, first take out the old roll, then load the new roll as described above.

To assure a long life for your fax and obtain the best reproduction quality, we recommend that you use the following Sharp fax (thermal) paper which is available from your dealer:

### **FO-40PR THERMAL PAPER (50 m roll)**

- ◆ The use of any other paper may result in poor copy quality and excessive build-up of residue on the head. This is due to the different thermal reactive characteristics of each manufacturer's paper.

## Handling fax paper

Do not unpack the paper until you are ready to use it. It may become discoloured if:

- ◆ It is stored at high humidity or high temperature.
- ◆ It is exposed to direct sunlight.
- ◆ It comes in contact with glue, thinner, or a freshly copied blueprint.
- ◆ A rubber eraser or adhesive tape is used on it, or it is scratched.

## Entering Your Name and Fax Number

Before you can begin using your fax, you need to enter your name and the telephone number of your fax. You also need to set the date and time.



Once you enter this information, it will automatically appear at the top of each fax page you send.

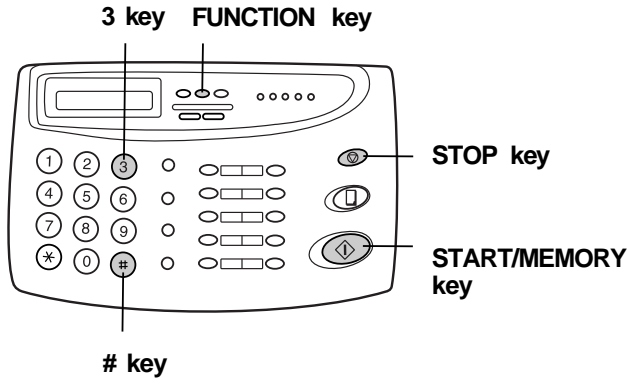
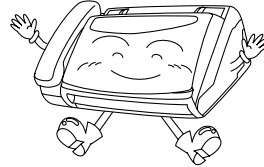

**1** Press these keys:

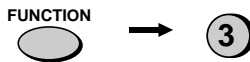

The display will show: ENTRY MODE

**2** Press the # key twice:



The display will show: OWN NUMBER SET

- 3** Press the **START/MEMORY** key.



The display will show:

ENTER FAX #

- 4** Enter your fax number by pressing the number keys. Up to 20 digits can be entered.
- To insert a space between digits, press the # key. To insert a "+", press the \* key.
  - If you make a mistake, press the **HOLD/SEARCH** key to move the cursor back to the mistake and then enter the correct number. The new number will replace the old number.

Example:



- 5** Press **START/MEMORY** to enter the fax number in memory.

START/MEMORY



The display will show:

ENTER YOUR NAME

**Cursor:** A dark square mark in the display that indicates where a number or letter will be entered.

**6** Enter your name by pressing the number keys as shown in the chart below. Up to 24 characters can be entered.

- To enter two letters in succession that require the same key, press the **SPEAKER** key after entering the first letter to advance the cursor.

Example: SHARP = 7 7 7 7 7 4 4 4 2 2 7 7 7 7  7 7

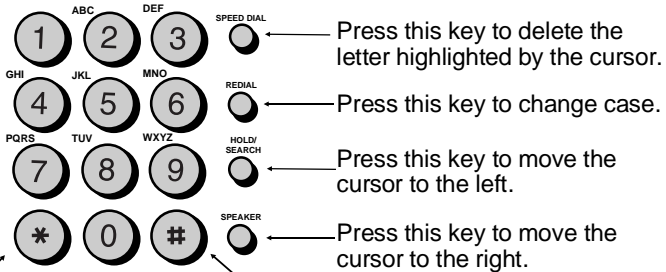
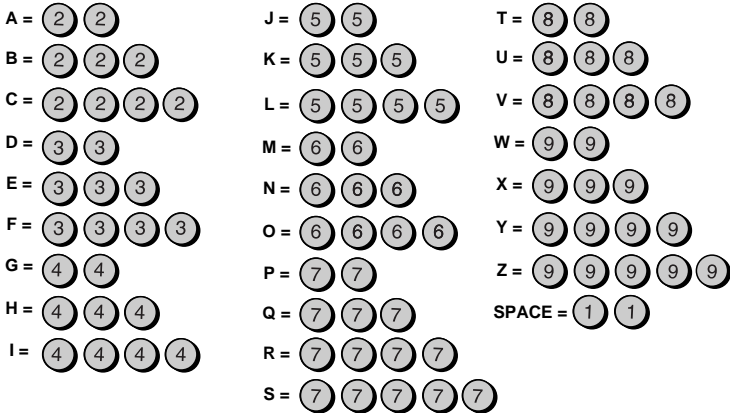

Press either key repeatedly to select one of the following symbols:  
 .!"/#\$%&'()\*+,-;:<=>?[ \]^\_`{|}~→←

**7** Press the **START/MEMORY** key to save your name in memory.



The display will show:

SECURITY SELECT

**8** Press the **STOP** key to return to the date and time display.



## Setting the Date and Time

The date and time appear in the display and reports, and are printed at the top of every page you transmit.

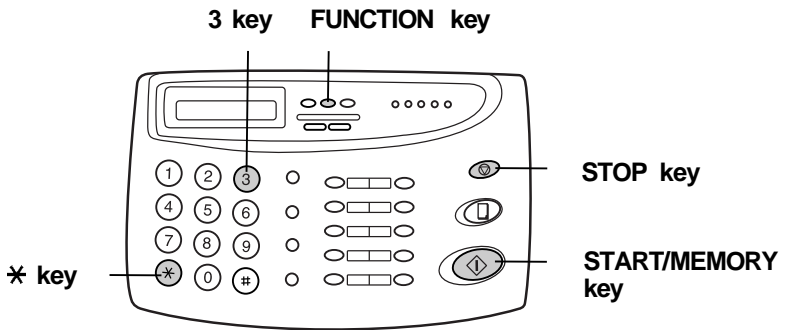
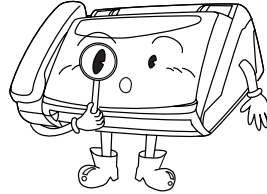

- 1** Press these keys:

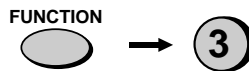

The display will show:

ENTRY MODE

- 2** Press the \* key three times.



The display will show:

DATE & TIME SET

- 3** Press the **START/MEMORY** key.

- The currently set date will appear in the display.



## Setting the Date and Time

---

**4** Enter a two-digit number for the day ("01" to "31").

Example: the 5th



---

**5** Enter a two-digit number for the month ("01" for January, "02" for February, "12" for December, etc.).

- To correct a mistake, press the **SPEED DIAL** key to move the cursor back to the mistake, and then enter the correct number.

Example: January



---

**6** Enter the year (four digits).

Example: 1998



---

**7** Enter a two-digit number for the hour ("00" to "23") and a two-digit number for the minute ("00" to "59").

Example: 9:25



---

**8** Press the **START/MEMORY** key to start the clock.

START/MEMORY



The display will show:

STORE JUNK #

---

**9** Press the **STOP** key to return to the date and time display.

STOP



## Selecting the Reception Mode

Your fax has four modes for receiving incoming calls and faxes:

### TEL mode:

This is the most convenient mode for receiving phone calls. You can also receive faxes; however, all calls must be answered first by picking up the fax's handset or an extension phone connected to the same line.

### FAX mode:

Select this mode when you only want to receive faxes on your line. The fax will automatically answer all calls and receive incoming faxes sent automatically.

### TEL/FAX mode:

This mode is convenient for receiving both faxes and voice calls. When a call comes in, the fax will detect whether it is a voice call (including manually dialed fax transmissions), or an automatically dialed fax. If it is a voice call, the fax will make a special ringing sound to alert you to answer. If it is an automatically dialed fax transmission, reception will begin automatically.

**ANS. mode:** Select this mode when you are out and want the built-in answering machine to answer all calls. Voice messages will be recorded, and fax messages will be received automatically.

## Setting the reception mode

Press the **RECEPTION MODE** key until the arrow in the display points to the desired mode.

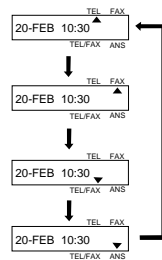
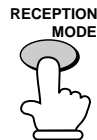
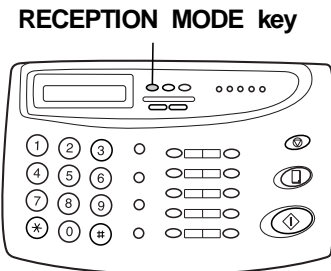

**Note:** ANS. mode cannot be selected unless a general outgoing message has been recorded as described in Chapter 2.

For more information on receiving faxes in TEL, TEL/FAX mode and FAX mode, see Chapter 4, *Receiving Documents*. For more information on using ANS. mode, see Chapter 2.

## Volume Adjustment

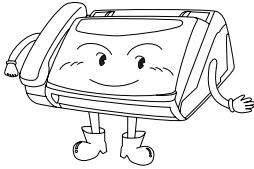

You can adjust the volume of the speaker and ringer using the **UP** and **DOWN** keys on the operation panel.

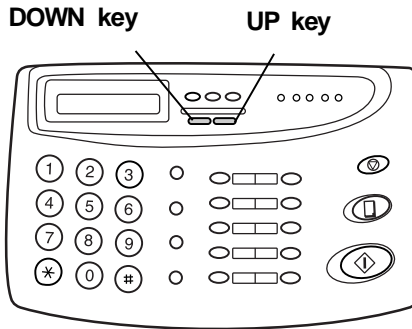

### Speaker

- 
- 1** Press the **SPEAKER** key.

**SPEAKER**



- 
- 2** Press the **UP** or **DOWN** key.

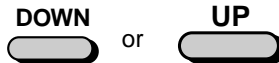

- 
- 3** When the display shows the desired volume level, press the **SPEAKER** key to turn off the speaker.

**SPEAKER**





## Ringer

- 1 Press the **UP** or **DOWN** key. (Make sure the **SPEAKER** key has not been pressed and the handset is not lifted.)
  - The ringer will ring once at the selected level, then the date and time will reappear in the display.

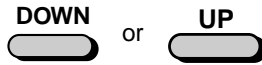

Display:

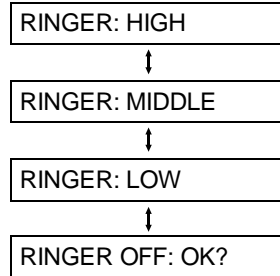

- 2 If you selected RINGER: OFF OK?, press the **START/MEMORY** key.

START/MEMORY



## Silent ring fax detection system

You can also set your fax machine to receive faxes silently, but ring to alert you to a voice call. To do so, set the ringer volume to OFF and set the reception mode to TEL/FAX. When a voice call comes in, a special ringer on the fax will ring. Note that extension telephones will not ring.

**Note:** During initial ringing before the fax picks up the call, the fax will be silent but extension telephones will ring.

## Using the Answering Machine

The FO-475's built-in answering machine allows you to receive both voice messages and fax transmissions while you are out.

When the reception mode is set to ANS., the answering machine will automatically answer incoming calls and play your outgoing message. Voice callers can leave a message just as with any regular answering machine. If the call is a fax transmission, the FO-475 will automatically receive it.

### Recording an Outgoing Message

The outgoing message (OGM) is the greeting which is played after the machine answers a call to inform callers that they can leave a message or send a fax.

The answering machine has a general message box and three personal message boxes. To use the answering machine, you must record an OGM for the general box. To use a personal box, you must record an OGM for that box.

#### Example of an OGM for the general box:

"Hello, this is the Jones family. We are not at home right now. If you would like to leave a general message, please speak after the beep. If you would like to leave a private message, press "1" for John, "2" for Jane, or "3" for Billy before the beep. If you would like to send a fax, press your facsimile Start button."

#### Example of an OGM for a personal box:

"This is Jane's personal box. Please leave a message after the beep."

---

**1** Press these keys:

FUNCTION



The display will show:

ANS. SETTINGS

---

**2** Press the # key.



The display will show:

OGM RECORDING

- 3** Press the **START/MEMORY** key.



- 4** Press a number key to select the outgoing message you want to record:

- **0**: General outgoing message **0**
- **1**: Box 1 outgoing message **1**
- **2**: Box 2 outgoing message **2**
- **3**: Box 3 outgoing message **3**
- **4**: Transfer outgoing message **4**  
(This is used for the Transfer function, which is described in *Transfer Function* in this Chapter.)

Boxes 1, 2, and 3 are personal boxes. A caller accesses a personal box by pressing its number (for example, **1** for Box 1) after listening to the general outgoing message.

- 5** Pick up the handset, press the **START/MEMORY** key, and speak into the handset.

- The general outgoing message can be up to 60 seconds long. A personal outgoing message can be up to 30 seconds long.
- While recording, the display will show the time remaining to record.

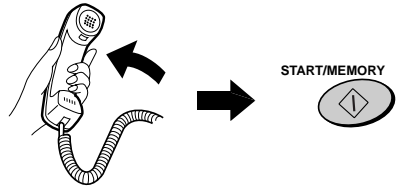

- 6** When finished, press the **STOP** key and replace the handset.

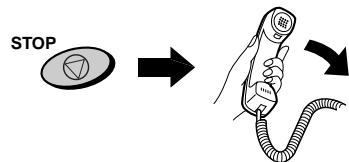

- 7** Go back to Step 4 to record an outgoing message for another box, or press the **STOP** key twice to return to the date and time display.



### ***To listen to or erase an outgoing message***

To listen to or erase an outgoing message, follow Steps 1 through 4 of the above procedure to select the message, and then press the **PLAY/SKIP** key to listen to it, or the **DELETE** key to erase it. To return to the date and time display, press the **STOP** key twice. Note that the general outgoing message cannot be erased. If you need to change it, simply repeat the recording procedure.

## Operating the Answering Machine

### Activating the answering machine

Activate the answering machine before you go out as follows:

Press the **RECEPTION MODE** key until the arrow in the display points to **ANS.**.

- Each outgoing message will play (you can stop playback by pressing the **STOP** key).
- It will not be possible to set the reception mode to **ANS.** if a general outgoing message has not been recorded.

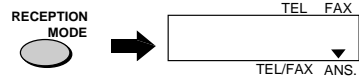

When the reception mode is set to **ANS.**, the FO-475 will answer incoming calls after two rings if it has received at least one incoming message, or after four rings if no messages have been received. (For more information, see *Toll Saver in Remote Operations* in this chapter.)

**Note:** If the memory is full from messages previously recorded, **MEMORY IS FULL** will appear in the display. To set the reception mode to **ANS.**, you must first erase some or all of the stored messages.

**Note:** In **ANS.** mode, the machine will automatically switch to fax reception if it detects a period of silence longer than six seconds after answering a call. For this reason, if a caller pauses for this length of time while leaving a message, they will be cut off and hear fax reception tones.

### Listening to received messages

When you return, the display will show the number of messages recorded in each box. Listen to them as follows:

---

**1** Press the **PLAY/SKIP** key.

- If you only want to listen to new messages (messages not previously listened to), continue to hold the **PLAY/SKIP** key down for at least two seconds.



---

**2** If you want to listen to the messages in a personal box, enter the number of that box by pressing the appropriate number key.



(Example)

---

**3** If the box (general or personal) has a passcode, enter the passcode by pressing the appropriate number keys.



(Example)

---

**4** The messages will play.

- As each message plays, the date and time of recording will appear briefly in the display. If no messages were received, NO MESSAGES will appear.
- To listen to a message a second time, press the **REPEAT** key before playback of that message ends.
- To move back to the previous message, press the **REPEAT** key within 3 seconds of the beginning of the current message.
- To skip forward to the next message, press the **PLAY/SKIP** key.
- To increase playback speed, press the # key. To decrease playback speed, press the \* key.



**Note:** Playback will stop if you receive a call, lift the handset, press the **STOP** key, or open the paper compartment cover.

## Erasing received messages

It is important to erase received messages after you listen to them to ensure that the memory does not become full. This is done as follows:

- **Erasing general messages:** To erase all messages in the General Box, press and hold down the **DELETE** key for at least 2 seconds. If the General Box has a passcode, press the **DELETE** key and then enter the passcode.
- **Erasing personal messages:** To erase all messages in a personal box, press the **DELETE** key (**do not hold it down**), enter the number of the box, and then enter its passcode (if it has one).
- **Erasing a single message:** To erase only a single message, press the **DELETE** key while the message is being played.



## Using the REC key

You can use the **REC** key to record telephone conversations and messages for other users of the FO-475. These will be recorded in the General Box, and played back together with any incoming messages in that box when the **PLAY/SKIP** key is pressed.

- **Recording messages:** To record a message, press the **REC** key for at least 1 second, and then pick up the handset, press the **START/MEMORY** key, and speak into the handset. When you have finished speaking, press the **STOP** key and replace the handset.
- **Recording phone conversations:** To record a phone conversation, hold down the **REC** key during the conversation you want to record (while recording, you will hear a beep every 15 seconds). When you are finished, release the key.



## Date and time of ICMs

You can check the date and time of your received messages by pressing the panel keys as shown below.

- ◆ The dates and times are also shown in the Message List, which can be printed out as described in Chapter 9.

---

**1** Press these keys:



The display will show:

ANS. SETTINGS

---

**2** Press these keys:



The display will show:

ICM CONFIRMATION

---

**3** Press the **START/MEMORY** key. The number of messages recorded will appear in the display.



---

**4** Press # or \* one or more times to show the date and time of each of the messages.

- The message number will appear first, and then the date and time several seconds later.

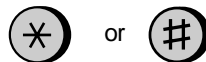

---

**5** Press the **STOP** key.



**Note:** The recorded dates and times are cleared each time you erase the messages.



## Optional Answering Machine Settings

### Programming a passcode

A 3-digit passcode can be programmed for each of the boxes. If this is done, the passcode must be entered before messages in the box can be listened to or erased. Program a new passcode or clear a previously programmed passcode by pressing the panel keys as shown below.

- ◆ The numbers "1", "2", and "3" cannot be selected for the first digit of the passcode.

- 1** Press these keys:



The display will show:

BOX PASSCODE

- 2** Press **1** to enter a passcode, or **2** to clear a previously programmed passcode.



or



- 3** Enter the number of the box for which you want to program or clear a passcode by pressing the appropriate numeric key. If you are clearing a passcode, go to Step 5.



(Example)

- 4** Enter a 3-digit passcode by pressing the number keys.



(Example)

- 5** Press the **START/MEMORY** key and then the **STOP** key.

START/MEMORY



STOP



**Note:** To ensure confidentiality, passcodes cannot be checked. If you have forgotten a passcode, clear it and program a new one.

## ***Fax reception in boxes***

If desired, you can turn on the Fax Box function to receive faxes in personal boxes.

When a fax is sent to a personal box, it will not be printed out immediately. Instead, it will print out when you play back the messages left in the box. If you program a passcode for the box, you will be able to receive confidential faxes. When a fax is sent to the General Box, it will be printed out immediately unless a passcode has been programmed for the General Box, in which case it will be printed out after message playback.

If the caller wants to send a fax to a personal box, they should enter the number of the box ("1" for Box 1, "2" for Box 2, or "3" for Box 3) by pressing the appropriate key on their telephone before the beep. The outgoing message for the selected box will play, and the caller can then press their Start key to send a fax.

Follow the steps below to turn the Fax box function on or off (it has been turned off at the factory).

---

**1** Press these keys:

FUNCTION



The display will show:

ANS. SETTINGS

---

**2** Press these keys:



The display will show:

FAX BOX FUNCTION

---

**3** Press **1** to turn the Fax box function on, or **2** to turn it off.



or



---

**4** Press the **STOP** key.

STOP



## Setting ICM time

Incoming messages (ICMs) are the messages which callers leave for you on the built-in answering machine. The answering machine is set at the factory to allow each caller a maximum of 4 minutes to leave a message. If desired, you can change this setting to 15, 30, or 60 seconds.

- Note that with all the settings, the machine will stop recording if it detects a period of silence or the caller has hung up or there is a fax machine calling automatically.

---

**1** Press these keys:

FUNCTION







The display will show:

ICM RECORD TIME

---

**2** Press a numeric key to select the desired ICM recording time:

- **1:** 15 seconds 
- **2:** 30 seconds 
- **3:** 60 seconds 
- **4:** 4 minutes 

---

**3** Press the **STOP** key.

STOP



## ***Fax reception on ANS. failure***

If the memory for recording incoming messages becomes full while you are out, the answering machine will no longer be able to record messages. The ON ANS. FAILURE setting is used to choose the response of the machine to incoming calls when this happens:

- ◆ Automatic fax reception NO: The FO-475 will answer after 20 rings, after which it will wait to receive a remote command. Most callers will hang up before it answers; however, when you call the FO-475 from a remote location, you can wait until it answers, listen to your messages, and then erase them (see *Remote Operations* in this chapter).
- ◆ Automatic fax reception YES: The reception mode will switch to **FAX** mode, allowing the FO-475 to continue to receive faxes automatically without broadcasting an OGM on answering. With this setting, you can still use the remote commands to listen to your messages and erase the message memory (see *Remote Operations* in this chapter).

Automatic fax reception is set to NO at the factory before shipping. If you want to set it to YES, press the panel keys as follows:

---

**1** Press these keys:

FUNCTION



The display will show:

ANS. SETTINGS

---

**2** Press these keys:



The display will show:

ON ANS. FAILURE

---

**3** Press **1** to turn automatic fax reception on, or **2** to turn it off.



or



---

**4** Press the **STOP** key.

STOP



## Transfer Function

The Transfer function is used to make the FO-475 automatically call you at a specified number every time it receives an incoming message in a selected box. This allows you to hear your messages immediately after they come in, even when you are at a remote location.

When you answer the telephone, you will hear your recorded message telling you that the call is a transfer call. Enter "#", the box number, the box's passcode (or your remote code number if the box has no passcode), and "#". The FO-475 will then play back your messages. You can also perform any of the remote operations described in *Remote Operations* in this chapter.

**Note:** When you hang up after a transfer call, the FO-475 will not immediately resume normal operation. If you want the FO-475 to accept calls immediately after a transfer call, enter "\*" twice before hanging up (if you want to hang up during message playback, first enter "0" and "#" to stop playback, then enter "\*" twice).

### Programming the transfer number

To use the Transfer function, you must first give the FO-475 the number to call (the transfer number). This is done by pressing the panel keys as follows:

**1** Press these keys:



The display will show:

ANS. SETTINGS

**2** Press these keys:



The display will show:

TRANSFER # ENTRY

**3** Press the **START/MEMORY** key.



**4** Enter a transfer number (max. of 32 digits including pauses) by pressing the number keys.



(Example)

**5** Press the **START/MEMORY** key and then the **STOP** key.



### ***Recording the transfer message***

The transfer message plays when you answer the telephone, and informs you that the call is a transfer call. It can be up to 15 seconds long. To record a transfer message, follow the steps described in *Recording an Outgoing Message* in this chapter. The following is an example:

"Hello. This is a transfer call for (YOUR NAME). Enter your remote code number now."

**Turning the Transfer function on and off****1** Press these keys:

FUNCTION



0

The display will show:

ANS. SETTINGS

**2** Press these keys:

The display will show:

TRANSFER FUNC

**3** Press "1" to turn the Transfer function on,  
or "2" to turn it off. (If you pressed "2",  
go to Step 5.)

1

or

2

**4** Enter the number of the box for which  
you want the Transfer function to operate  
(for the General Box, enter "0").

1

(Example)

**5** Press the **STOP** key.

STOP



## Override Ringing

This function allows selected callers using a touch-tone telephone to override the answering machine's outgoing message and cause the FO-475 to make a special ringing sound, alerting you that they are calling. This is useful when you are near the machine but only want to talk with certain callers, taking all other calls on the answering machine.

### Programming the override code

To override the answering machine, your callers must enter a 3-digit override code from their telephone. This code has been set to "009" at the factory. If you want to change it, press the panel keys as shown below.

#### Important!

- Make sure the override code is different from the remote code or any passcodes programmed for boxes.

---

**1** Press these keys:



The display will show:

ANS. SETTINGS

---

**2** Press these keys:



The display will show:

OVERRIDE CODE

---

**3** Enter a 3-digit code number by pressing the number keys.



(Example)

---

**4** Press the **START/MEMORY** key and then the **STOP** key.





## Overriding the answering machine

Your callers should follow the steps below to override the answering machine.

- 1** Your caller calls the FO-475 from a touch-tone telephone. When the outgoing message begins, they should press the "#" key on their telephone.



- The caller will hear a short beep, and the outgoing message will stop.

- 2** The caller should enter the override code and "#" by pressing the appropriate keys on their telephone.



(Example)

- If an incorrect code is entered, the caller will hear four beeps. He or she must re-enter the correct code within 60 seconds or the line will be disconnected.

- 3** The FO-475 will make a special ringing sound. Pick up the handset to answer the call. (Note that an extension telephone connected to the same line will not ring.)

- If you do not answer within 30 seconds, the outgoing message will play again and the caller can then leave a message.

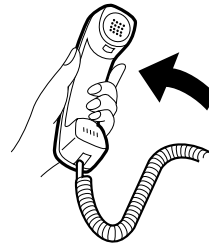

## Remote Operations

You can call the FO-475 from any tone dial telephone and play back your messages using the remote commands. You can also use these commands to change the reception mode and other settings.

### Remote code number

When you call the FO-475, you must enter the passcode for the box you want to listen to, or a remote code number if the box does not have a passcode. One remote code number can be programmed, and it is used to access all boxes which do not have passcodes. This prevents unauthorized people from listening to your messages. You can use any 3-digit number as the remote code number.

The remote code number has been set to "001" at the factory. If you want to change it, press the panel keys as shown below.

**1** Press these keys:



The display will show:

ANS. SETTINGS

**2** Press these keys:



The display will show:

REMOTE CODE

**3** Enter a 3-digit number by pressing the number keys. ("1", "2" and "3" cannot be selected for the first digit.)



(Example)

**4** Press the **START/MEMORY** key and then the **STOP** key.

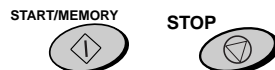

## Toll Saver

When you call the FO-475 to listen to your messages, it will answer after two rings if it has received at least one message in any of the boxes, or after four rings if no messages are received.

This allows you to save money on telephone charges, particularly if you are calling long distance. If the machine does not answer after the second ring, you can simply hang up before it answers, saving yourself the cost of that call.

If you do not want to use the Toll Saver function, you can turn it off by following the steps below. In this case, the FO-475 will answer after the number of rings set with Option Setting 2 (see Chapter 8), the ring setting for FAX reception mode.

**1** Press these keys:

FUNCTION



The display will show: ANS. SETTINGS

**2** Press these keys:



The display will show: TOLL SAVER

**3** Press "1" to turn Toll Saver on, or "2" to turn it off.



**4** Press the **STOP** key.

STOP



## Retrieving your messages

Follow the steps below to listen to your messages from a remote location. Note that you can only access one box per call; if you want to access more than one box, you must make a separate call for each box.

**Note:** You can also access the FO-475 for remote operation when the reception mode is set to FAX or TEL/FAX. In this case, call the FO-475, press the "#" key immediately after it answers, or during pseudo ringing in TEL/FAX mode (before you hear the fax tone in either case), and then continue from Step 2 below.

---

**1** Call the FO-475 from a touch-tone telephone. When your outgoing message begins, press the "#" key on the telephone.



- You will hear a short beep, and the outgoing message will stop.

---

**2** Enter the number of the box you want to listen to. If you want to listen to the General Box, skip this step.



(Example)

---

**3** Enter the box's passcode, or your remote code number if the box does not have a passcode. When finished, press "#" on the telephone.



- You will hear a series of beeps equal to the number of messages recorded in the box, or one long beep if four or more messages have been received. The machine will then play back the messages, beeping once at the end of each message. When all messages have been played back, you will hear a long beep.

(Example)

- If no messages have been received in the box, you will hear a short beep. You can either hang up, or perform any of the operations described in the following section "Other remote operations".

**4** While the messages are playing, you can do any of the following:

- **Repeat:** To listen to a message a second time, press "2" and "#" on the telephone before that message ends. To move back to the previous message, press "2" and "#" within the first 3 seconds of the current message.



- **Skip forward:** To skip forward to the next message, press "5" and "#" on the telephone.



- **Stop:** To stop playback, press "0" and "#" on the telephone. After this, you can enter any of the commands described in the following section, "Other remote operations".







- **Play new messages:** To listen to only your new messages, first stop playback by pressing "0" and "#", and then press "6" and "#".



- **Erase a message:** To erase the message you are currently listening to, press "3" and "#" before it ends.



**5** When you have finished listening to your messages, you can do any of the following:

- **Erase all messages:** To erase all of the messages in the box, press "3", "3", and "#".   
- **Repeat playback:** To listen to your messages again, press "7" and "#".  
- **Perform other operations:** You can enter any of the commands described in the following section, "Other remote operations".
- **Hang up:** If you do not erase your messages first, they will be saved and any new messages will be recorded after them. If you want the FO-475 to resume normal operation immediately, press "\*" twice before hanging up (in some cases, particularly when the Transfer function is used, the FO-475 may not accept new calls for one or two minutes after you hang up unless you first press "\*" twice).

### Comments:

- When a remote command is accepted by the machine, you will hear one beep. If an incorrect command is entered, you will hear four beeps. In the latter case, re-enter the correct command.
- When entering a command, do not pause longer than 10 seconds between each digit. If you do, a 4-beep error signal will be issued and the digits entered up to that point will be disregarded. In this case, re-enter the command from the beginning.
- If you make two errors (causing two 4-beep signals to be issued) while entering your remote code number, the line will be disconnected. This prevents unauthorized people from attempting to guess your remote code number.
- If you pause for longer than 60 seconds before entering a command, you will be disconnected.

## Other remote operations

After listening to your messages, you can do any of the operations described below by pressing the appropriate keys on the telephone.

**Note:** The following commands cannot be entered while messages are being played back. If you do not want to wait until playback ends to enter a command, first stop playback by pressing "0" and "#", and then enter the command.

## Changing the fax reception mode

Select a new reception mode by pressing the keys as follows:

- **ANS.** mode: "8", "1", and "#".
- **FAX** mode: "8", "2", and "#".
- **TEL** mode: "8", "3", and "#".



(Example)

- **Caution:** In TEL mode, you will not be able to further change the reception mode.
- **TEL/FAX** mode: "8", "4", and "#".

## Recording a new outgoing message

**Note:** A new outgoing message can only be recorded for the box you selected at the beginning of the remote operation procedure.

- 
- 1** Press "4" and "\*" on the telephone.



- 
- 2** When you hear a short beep, speak into the telephone to record the new message.

- The message (including the general outgoing message) can be up to 15 seconds long. After 15 seconds (or earlier if the machine detects silence after you finish speaking), you will hear a beep, and the new message will be played back.

### Turning the Transfer function on or off

To turn Transfer on: Press "9", "1", and "#", followed by the number of the box ("0" for the General Box) and "#".



To turn Transfer off: Press "9", "2", and "#" on the telephone.

(Example)

### Changing the transfer telephone number

**1** Press "9", "0", and "#" on the telephone.



**2** After you hear a short beep, enter the new telephone number. When finished, press "#".



- To insert a pause between any two digits of the number, press "\*".

(Example)

### Recording a new transfer message

**1** Press "9", "3", and "#" on the telephone.



**2** When you hear a short beep, speak into the telephone to record the new message.

- The time for the transfer message is fixed at 15 seconds. After 15 seconds (or earlier if the machine detects silence after you finish speaking), you will hear a beep, and the new message will be played back automatically.



## Recording a "Memo"

You can leave a "memo" for yourself or other users of the machine. It will be recorded in the General Box, and played back when messages in that box are listened to.

- 
- 1** Press "\*" and "#" on the telephone.



- 
- 2** When you hear a short beep, speak into the telephone to record the memo.

- 
- 3** When you are finished, press "0" and "#".

- If the FO-475 detects a certain period of silence, it will stop recording automatically.



# Sending Documents

## Transmittable Documents

### Size and weight

The size and weight of documents that you can load in the document feeder depend on whether you load one page at a time or several pages at once.

#### Loading one page at a time:

Minimum size

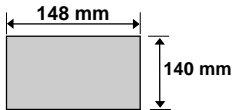

Maximum size

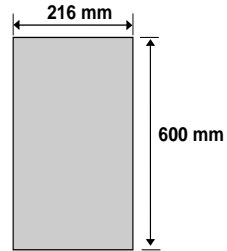

Minimum weight

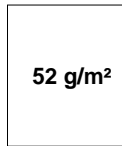

Maximum weight

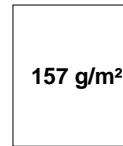

#### Loading several pages at once:

Minimum size

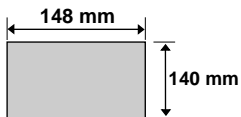

Maximum size

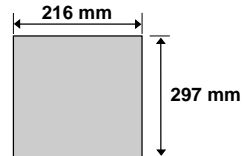

Minimum weight

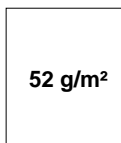

Maximum weight

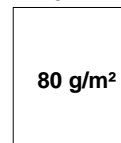

**Note:** Letters or graphics on the edges of a document will not be scanned.

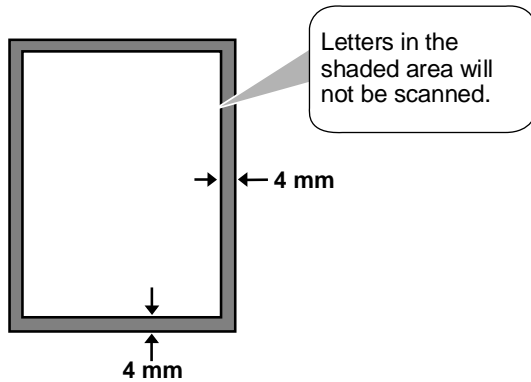

### ***Other restrictions***

- ◆ The scanner cannot recognise yellow, greenish yellow, or light blue ink.
- ◆ Ink, glue, and correcting fluid on documents must be dry before they pass through the document feeder.
- ◆ All clips, staples, and pins must be removed from documents before loading in the feeder. If these are not removed, they may damage the machine.
- ◆ Documents which are patched, taped, torn, smaller than the minimum size, carbon backed, or easily smudged should be photocopied, and the copy loaded in the feeder.

## Loading the Document

Up to 10 pages can be placed in the feeder at one time. The pages will automatically feed into the machine starting from the bottom page.

- ◆ If you need to send or copy more than 10 pages, place the additional pages gently and carefully in the feeder just before the last page is scanned. Do not try to force them in, as this may cause double-feeding or jamming.
- ◆ If your document consists of several large or thick pages which must be loaded one at a time, insert each page into the feeder as the previous page is being scanned. Insert gently to prevent double-feeding.

- 
- 1** Adjust the document guides to the width of your document.

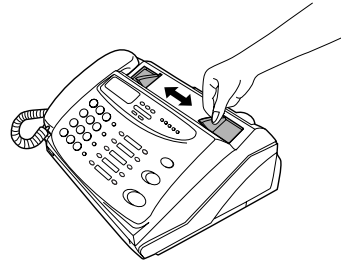

- 
- 2** Place the document face down and push it gently into the document feeder. The top edge of the document should enter the machine first.

- The feeder will draw the leading edge of the document into the machine. The display will show:

READY TO SEND

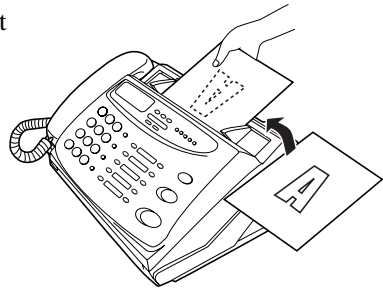

- 
- 3** Adjust the resolution and/or contrast setting (if desired) as explained in the section *Resolution and Contrast*, then dial the receiving machine as explained in *Sending a Fax by Normal Dialling*.

**RESOLUTION**



## Removing a document from the feeder

If you need to remove a document from the feeder, open the operation panel.

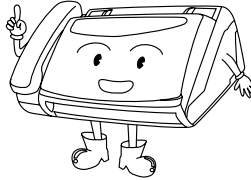

### Important:

Do not try to remove a document without opening the operation panel. This may damage the feeder mechanism.

- 1 Pull the release marked **PANEL RELEASE** toward you and open the operation panel.

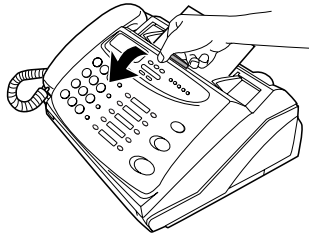

- 2 Remove the document.

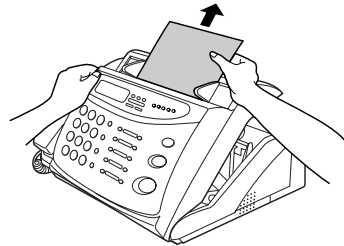

- 3 Close the operation panel, making sure it clicks into place.

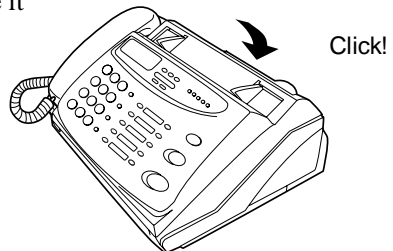

## **Resolution and Contrast**

If desired, you can adjust the resolution and contrast before sending a document.

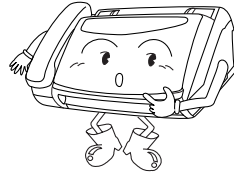
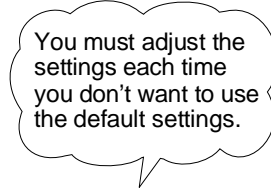
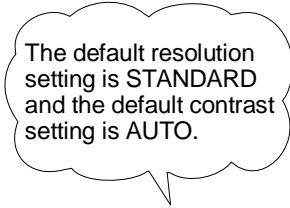

**Note:** The resolution and contrast settings are only effective for transmitting a document. They are not effective for receiving a document.

### **Resolution settings**

- STANDARD:** Use STANDARD for ordinary documents. This setting gives you the fastest and most economical transmission.
- FINE:** Use FINE for documents containing small letters or fine drawings.
- SUPER FINE:** Use SUPER FINE for documents containing very small letters or very fine drawings.
- HALF TONE:** Use HALF TONE for photographs and illustrations. The original will be reproduced in 64 shades of grey.

**Note:** In order to transmit in FINE or SUPER FINE resolution, the receiving fax machine must also have that resolution. If it doesn't, your machine will automatically step down to the next best available setting.

### **Contrast settings**

- AUTO** Use AUTO for normal documents.
- DARK** Use DARK for faint documents.

**1** Load the document(s).

- The document must be loaded before the resolution and contrast can be adjusted.

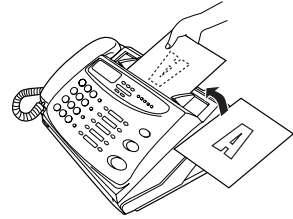
**2** Press the **RESOLUTION** key one or more times until the desired resolution and contrast settings appear in the display.

- The first time you move through the list of resolution settings, the contrast setting AUTO will appear next to each resolution setting. The second time you move through the list, the contrast setting DARK will appear.

**RESOLUTION**

Display:

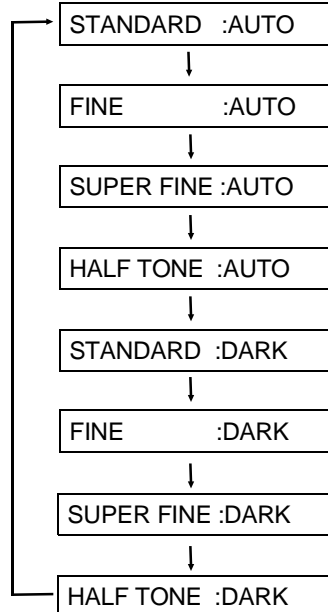

## ***Sending a Fax by Normal Dialling***

With Normal Dialling, you pick up the handset (or press the **SPEAKER** key) and dial by pressing the number keys.

- ◆ If a person answers, you can talk with them through the handset before sending the fax. (If you pressed the **SPEAKER** key, you must pick up the handset to talk.)
- ◆ Normal Dialling allows you to listen to the line and make sure the other fax machine is responding.

---

### **1** Load the document(s).

The display will show:

READY TO SEND

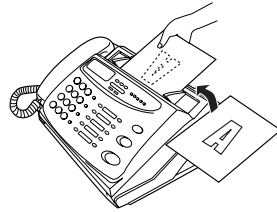

- Set the resolution and/or contrast if desired.



---

### **2** Pick up the handset or press the **SPEAKER** key. Listen for the dial tone.

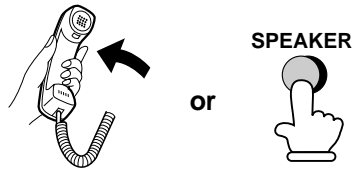

---

### **3** Dial the number of the receiving machine by pressing the numeric keys.

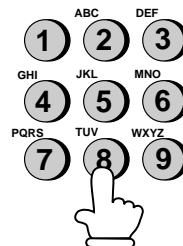



- 
- 4** Wait for the connection. Depending on the setting of the receiving machine, you will either hear a facsimile reception tone or the other person will answer.

- If the other party answers, (lift the handset if the **SPEAKER** key was pressed) ask them to press their **START/MEMORY** key. This causes the receiving machine to issue a reception tone.

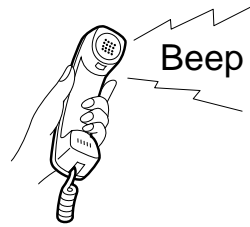

- 
- 5** When you hear the reception tone, press the **START/MEMORY** key. Replace the handset if you used it.

- When transmission is completed, the fax will beep once.

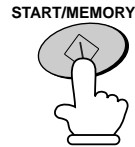

### ***Using the REDIAL key***

You can press the **REDIAL** key to redial the last number dialled. To send a document, proceed from Step 4 of Normal Dialling. Note that the speaker will be automatically activated when you press the **REDIAL**.

**Facsimile reception tone:** This is a pronounced, high-pitched tone that the receiving machine sends to the transmitting machine to indicate that it is ready to receive.



## ***Sending a Fax by Automatic Dialling***

You can dial a fax or telephone number by simply pressing a Rapid Key, or by pressing the **SPEED DIAL** key and entering a two-digit number.

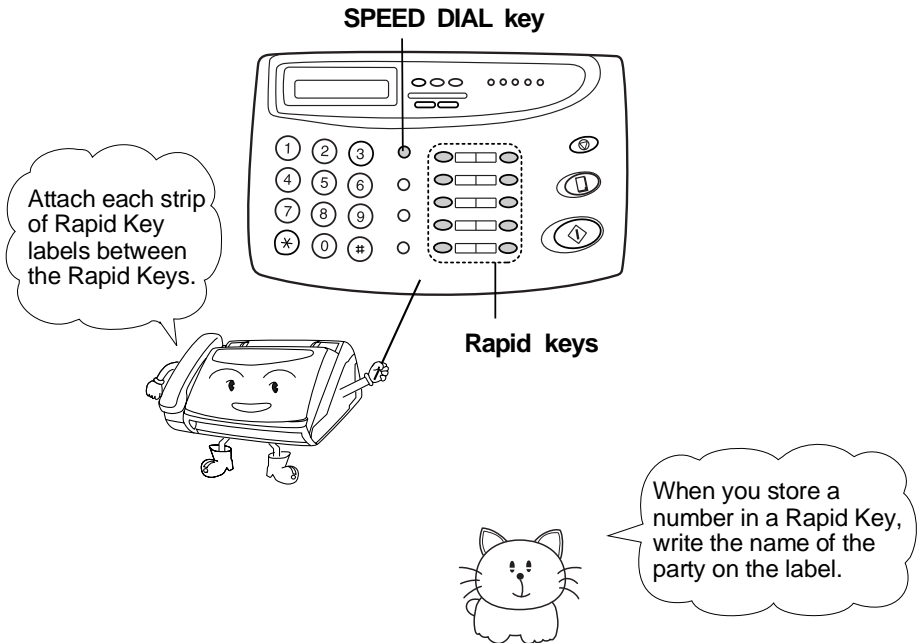
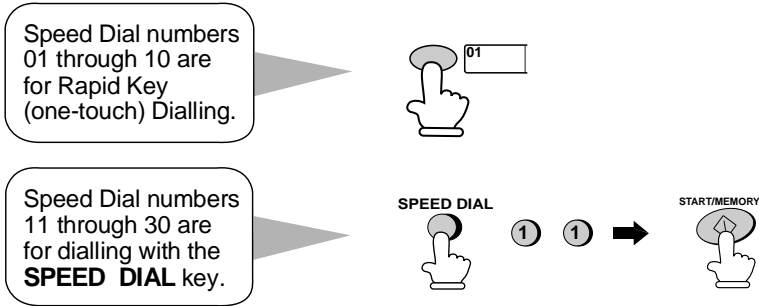
- ◆ To use Automatic Dialling, you must first store the full fax or telephone number in your fax machine.
- ◆ When you store a fax or telephone number, you select a two-digit Speed Dial number for it. 30 Speed Dial numbers are available.



## Storing fax and telephone numbers for Automatic Dialling

- 1** Press these keys:   

The display will show: FAX/TEL. # MODE

- 2** Press **1** to select SET. 

The display will show: FAX/TEL. # SET  
 ↓ ↑  
ENTER SPEED #

- 3** Enter a two-digit Speed Dial number by pressing the number keys (01 to 10 for Rapid Key Dialling, 11 to 30 for Speed Dialling).

  (Example)

- 4** Enter the fax or voice number by pressing the number keys (max. of 32 digits including pauses). (Note: A space cannot be entered.)

- Press the **SPEED DIAL** key to clear a mistake.
- If a pause is required between any of the digits to access a special service or an outside line, press the **REDIAL** key. The pause will appear as a hyphen. Several pauses can be entered in a row.

       (Example)





















































































- 5** Press the **START/MEMORY** key.



**6** Enter the name of the party by pressing the number keys as shown in the chart below. Up to 10 characters can be entered.

- If you don't want to enter a name, skip this step.
- To enter two letters in succession that require the same key, press the **SPEAKER** key after entering the first letter to advance the cursor.

Example: SHARP = 7 7 7 7 7 4 4 4 2 2 7 7 7 7  7 7

A =  	J =  	T =  
B =   	K =   	U =   
C =    	L =    	V =    
D =  	M =  	W =  
E =   	N =   	X =   
F =    	O =    	Y =    
G =  	P =  	Z =     
H =   	Q =   	SPACE =  
I =    	R =    	
	S =     	

**7** Press the **START/MEMORY** key.

**START/MEMORY**



**8** Return to Step 3 to store another number, or press **STOP** to exit. If the number will be used for Rapid Key Dialling, you can write the name on the appropriate Rapid Key label.

**Step 3 or**

**STOP**



**Note:** To confirm that Automatic Dialling numbers have been stored correctly, print out the Telephone List. The procedure for doing this is explained in Chapter 9, *Printing Reports and Lists*.

### **Storing area codes and access codes**

You can also store an area code or access code in a Rapid Key or Speed Dial number. To use this number to dial, see *Chain Dialing* in Chapter 5, *Making Telephone Calls*.

**Note:** An area code or access code stored in a Rapid Key or Speed Dial number can only be used if the handset is lifted or the **SPEAKER** key pressed before dialling.

## Clearing numbers

- 1** Press these keys:

FUNCTION



**3**



The display will show:

FAX/TEL. # MODE

- 2** Press **2** to select CLEAR.



- 3** Enter the Speed Dial number that you want to clear by pressing the number keys.



(Example)

- 4** Press the **START/MEMORY** key.

START/MEMORY



- 5** Return to Step 3 to clear another number, or press **STOP** to exit.

Step 3 or

STOP



## Making changes

To make changes in a number previously stored, repeat the storing procedure. Select the Speed Dial number for which you want to make changes in Step 3, and then change the number and/or name when they appear in the display (Steps 4 and 6, respectively).

### ◆ A lithium battery keeps automatic dialling numbers in memory

The machine uses a lithium battery to keep automatic dialling numbers and other programmed data in memory when the power is turned off. Battery power is consumed primarily when the power is off. With the power kept continuously off, the life of the battery is about 5 years. If the battery dies, have your dealer or retailer replace it. Do not try to replace it yourself.

## Rapid Key Dialling

If the number you want to dial has been stored for Automatic Dialling as a Speed Dial number from 01 to 10, you can dial it by pressing the corresponding Rapid Key.

---

**1** Load the document(s).

The display will show:

READY TO SEND

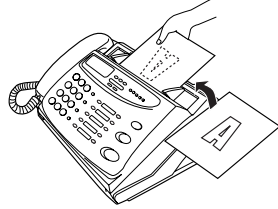

- Set the resolution and/or contrast if desired.



---

**2** Press the Rapid Key corresponding to the desired Speed Dial number.

- The name of the receiving party will appear in the display. If no name was stored, the fax number will appear. (If the name or number is incorrect, press the **STOP** key.)
- The document will be automatically transmitted once the connection is made.

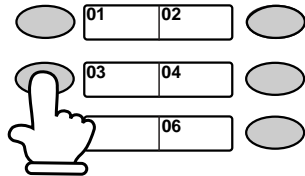

**Example:** To dial Speed Dial number 03, press Rapid Key 03.

## Speed Dialling

Speed Dialling can be used to dial any number that has been stored for Automatic Dialling.

### 1 Load the document(s).

The display will show:

READY TO SEND

- Set the resolution and/or contrast if desired.

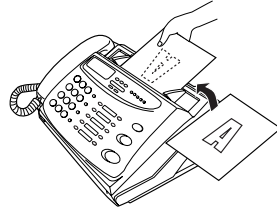

### 2 Press the **SPEED DIAL** key and then enter the two digits of the Speed Dial number by pressing the number keys.

- To enter numbers 1 through 9, first enter 0 and then the number.

**SPEED DIAL**



(Example)

### 3 Check the display. If the name or number shown is correct, press the **START/MEMORY** key. (If not, press the **STOP** key and then repeat Step 2.)

**START/MEMORY**



## Direct Keypad Dialling

You can also enter a full number with the number keys and then press the **START/MEMORY** key to begin dialling. You can use this method to dial a full number when you don't need to speak to the other party before faxing.

---

### 1 Load the document(s).

The display will show:

READY TO SEND

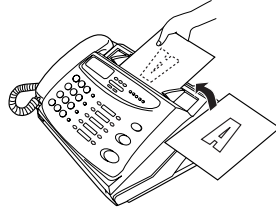

- Set the resolution and/or contrast if desired.

RESOLUTION



---

### 2 Enter the number of the receiving machine by pressing the numeric keys.

- If a pause is required between any of the digits to access a special service or an outside line, press the **REDIAL** key. The pause will appear as a hyphen. Several pauses can be entered in a row.

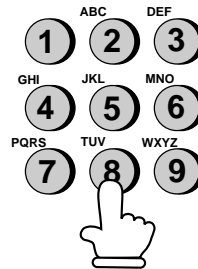

---

### 3 Check the display. If the number of the receiving machine shown is correct, press the **START/MEMORY** key.

- If it is not correct, press the **STOP** key to backspace and clear one digit at a time, and then re-enter the correct digit(s).

START/MEMORY





## Using the **HOLD\SEARCH** key

If you don't remember the Rapid Key or Speed Dial number in which you have stored a particular fax number, you can search for the number by following the steps below. Once you have found the number, you can dial it and transmit the loaded document by simply pressing the **START/MEMORY** key.

### 1 Load the document(s).

The display will show:

READY TO SEND

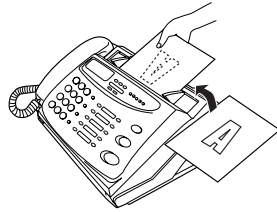

- Set the resolution and/or contrast if desired.

RESOLUTION



### 2 Press the **HOLD\SEARCH** key and press **1** key.

HOLD  
SEARCH



### 3 Enter the first letter of the stored name by pressing the appropriate number key (the key which corresponds to the required letter) one or more times until the letter appears in the display. If the name begins with a special character or number, press **1**.

- If you don't remember the first letter, go to Step 4 (you will scroll through the list from the beginning).
- If a name wasn't stored for the number, press **0**. This will cause numbers, not names, to appear when you scroll.

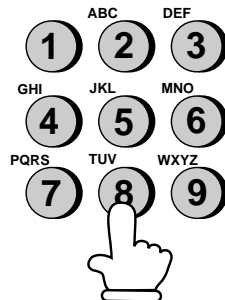

- 4** Press the # key or the \* key to scroll through the names (numbers if you pressed 0). Stop when the desired name appears in the display.

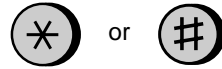

- If no names have been stored that begin with the entered letter, you will scroll from the next name, in alphabetical order, in the list. If no names/numbers have been stored at all, NO DATA will appear.

- 5** Press the **START/MEMORY** key. The document will be automatically transmitted once the connection is made.

**START/MEMORY**

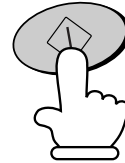

### ***Automatic redialling***

If you use automatic dialling (including Direct Keypad Dialling) and the line is busy, the machine will automatically redial the number. Up to 2 redialling attempts will be made at intervals of 5 minutes.

- ◆ To stop automatic redialling, press the **STOP** key.

## Receiving Documents

### Using TEL/FAX Mode

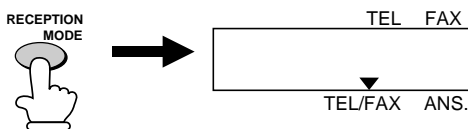
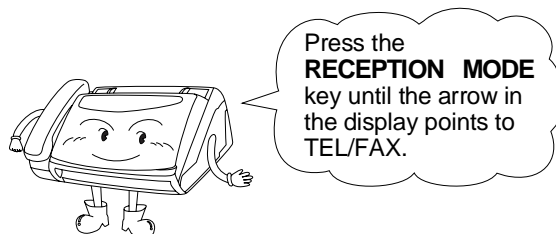

When the reception mode is set to TEL/FAX, your fax automatically answers all calls on 2 rings (See Option Setting 2 in Chapter 8). After answering, your fax monitors the line for about 5 seconds to see if a fax tone is being sent.

- ◆ If your fax detects a fax tone (this means that the call is an automatically dialed fax), it will automatically begin reception of the incoming document.
- ◆ If your fax doesn't detect a fax tone (this means that the call is a voice call or manually dialed fax), it will make a ringing sound (called pseudo ringing) for 15 seconds to alert you to answer. If you don't answer within this time, your fax will send a fax tone to the other machine to allow the calling party to send a fax manually if they desire.

#### Comments:

- Only the fax will alert you to voice calls or manually dialed faxes by pseudo ringing. An extension phone connected to the same line will not ring after the connection has been made.
- The duration of pseudo ringing can be adjusted with Option Setting 8. See Chapter 8, *Option Settings*.
- You can change the number of rings on which the machine answers calls by changing Option Setting 2. (See Chapter 8, *Option Settings*.)

## Using ANS. Mode

In ANS. mode, your fax will automatically receive voice and fax messages. See Chapter 2 for more details.

## Using FAX Mode

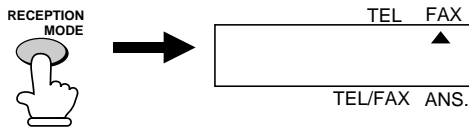
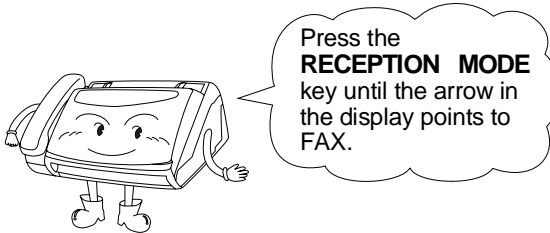

When the reception mode is set to FAX, the machine will automatically answer all calls on 2 rings and receive incoming faxes.

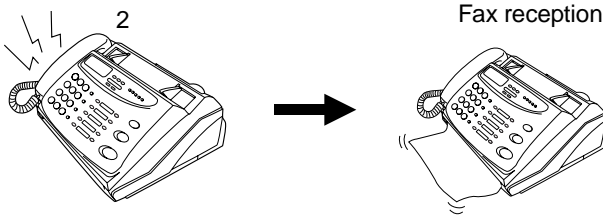

- ◆ You can change the number of rings on which the machine answers calls by changing Option Setting 2. (See Chapter 8, *Option Settings*.)
- ◆ If you pick up the handset before the machine answers, you can talk to the other party and/or receive a document as described in *Using TEL mode*.

## Using TEL Mode



Press the **RECEPTION MODE** key until the arrow in the display points to TEL.

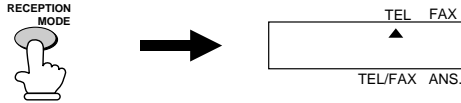

When the reception mode is set to TEL, you must answer all calls using the fax machine's handset or an extension phone connected to the same line.

## Answering with the fax's handset

- 1 Pick up the handset when the machine rings.

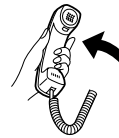

- 2 If you hear a fax tone, wait until the display shows RECEIVING and then replace the handset.

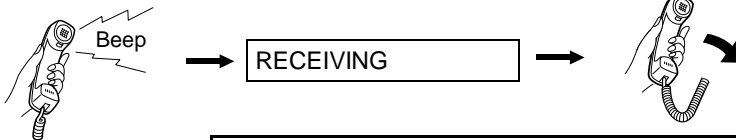

**Note:** If you have set Option Setting 12 (Fax signal receive) to NO, press the **START/MEMORY** key to begin reception.

- 3 If the other party first talks and then wants to send a fax, press the **START/MEMORY** key after speaking (press your **START/MEMORY** key before the sender presses their Start key).

- Make sure that the display shows RECEIVING, then replace the handset.

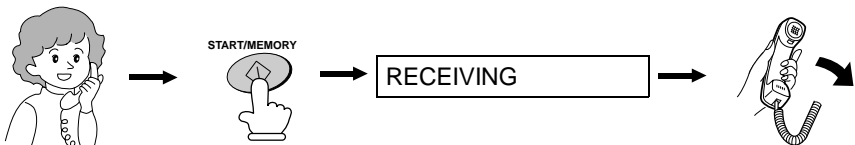

## Answering with an extension phone

- 1 Answer the extension phone when it rings.

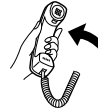

- 2 If you hear a fax tone when you answer an extension phone, wait until your fax answers (the extension phone will go dead), and then hang up.

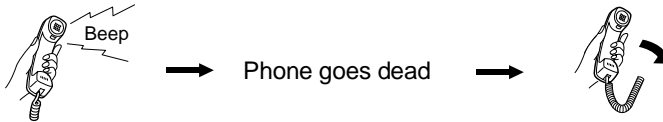

- 3 If the fax doesn't respond, or if the other party first talks to you and then wants to send a fax, press **5**, **\***, and **\*** on the extension phone (only on a tone dial phone). Hang up.

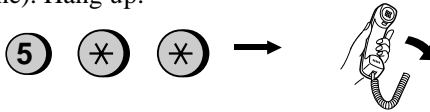

### Comments:

- Your fax will not accept the signal to begin reception (**5\*\***) if a document is loaded in its feeder.
- If you have set Option Setting 12 to NO and hear a fax tone when you answer the extension phone, you must press **5**, **\***, and **\*** if you are on a tone dial phone, or walk over to the fax, pick up the handset, and press the **START/MEMORY** key if you are on a pulse dial only phone.
- In New Zealand, not all standard telephones and answering machines will respond to incoming ringing when connected to the socket of the equipment.

## Paper cutting

After receiving a document, your fax automatically cuts the fax paper to a length slightly longer than the original.

## Making Copies

Your fax can also be used to make copies. You can use this function to make a sample copy of a document before transmitting it to see if the resolution or contrast needs adjustment.

- ◆ The default resolution for copying is FINE.

- 1 Load the document(s) face down.  
(Maximum of 10 pages.)

The display will show:

READY TO SEND

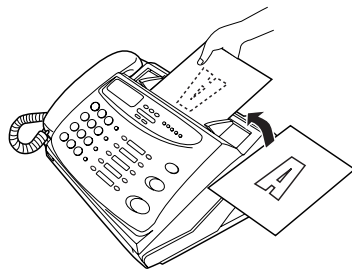

- Set the resolution and/or contrast if desired. (The default setting for copying is FINE.)

RESOLUTION



- 2 Press the **COPY/HELP** key.

COPY/HELP



### Incoming calls during copying

The fax goes into manual reception mode during copying, so if a call comes in at this time, pick up the handset to answer.

To receive a document, press the **START/MEMORY** key after copying is finished. If you want to begin reception immediately, press the **STOP** key to stop copying, and then press the **START/MEMORY** key as soon as the document has fed out and the fax has returned to standby mode.

## Making Telephone Calls

Your fax can be used like a regular telephone to make and receive voice calls.

- ◆ To make or receive a phone call, the power must be on.

- 
- 1** Pick up the handset or press the **SPEAKER** key. Listen for the dial tone.

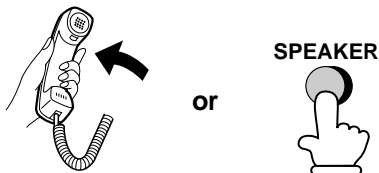

- 
- 2** Dial the number using one of the following methods:

- **Normal Dialling:** Enter the full telephone number with the numeric keys.
- **Rapid Key Dialling:** Press the appropriate Rapid Key.
- **Speed Dialling:** Press the **SPEED DIAL** key, and enter the 2-digit Speed Dial number with the numeric keys.

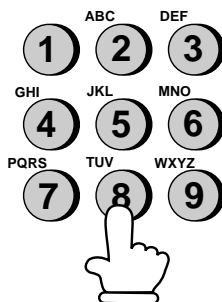

- 
- 3** Speak with the other party when they answer.
- If you pressed the **SPEAKER** key, pick up the handset to talk.

### Comments:

- While the handset of the fax is lifted (off hook), an extension phone connected directly to the fax cannot be used to speak with the other party.



## **Chain Dialling**

After lifting the handset, you can dial any combination of Normal Dialling, Rapid Key Dialling and Speed Dialling numbers. For example, if you have stored an area code or an access code for a special service in a Rapid Key, you can press the Rapid Key for that area code or access code, then dial the remainder of the number by pressing a Rapid Key, pressing number keys, or pressing the **SPEED DIAL** key and entering a two-digit Speed Dial number.

## **Using the HOLD/SEARCH key**

You can use the **HOLD/SEARCH** key to search for a Rapid Key or Speed Dial number. First search for the number as described in *Using the HOLD/SEARCH key in Sending a Fax by Automatic Dialling* in Chapter 3, then pick up the handset or press the **SPEAKER** key. The number will be dialled automatically (do not press the **START/MEMORY** key).

## **Redial**

The last number called can be redialled by pressing the **REDIAL** key (it is not necessary to pick up the handset or press the **SPEAKER** key). When the other party answers, pick up the handset to talk.

## **Hold**

You can put the other party on hold during a conversation by pressing the **HOLD/SEARCH** key. When this is done, they cannot hear you. You can put the handset back in the cradle without breaking the connection. When you are ready to speak with them again, pick up the handset. If you did not put the handset back in the cradle, press the **HOLD/SEARCH** key again to resume conversation.

## Special Functions

### Caller ID

If you subscribe to a caller identification service from your telephone company, you can set your fax to display the name and number of the caller while the fax rings.

#### Important:

- To use this function, you must subscribe to a caller identification service from your telephone company.
- Your fax may not be compatible with some caller identification services.

**1** Press these keys:

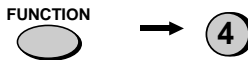

The display will show:

OPTION SETTING

**2** Press the \* key.



The display will show:

CALLER-ID

**3** Press **1** to turn on Caller ID, or **2** to turn it off.

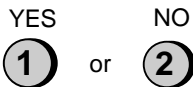

**4** Press **1** if you are in Australia or **2** if you are in New Zealand.

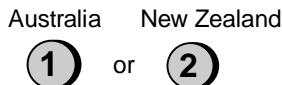

**5** Press the **STOP** key to return to the date and time display.



## How Caller ID operates

When you receive a call, the name and phone number of the caller will alternately appear in the display, beginning just before the second ring. The information will continue to be displayed until you pick up the handset, or until the fax answers automatically if it is in FAX mode.

**Note:** Some caller ID services may not provide the name of the caller. In this case, only the phone number will appear.

Display example:

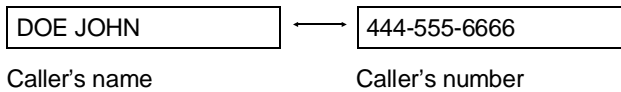

## Display messages

One of the following messages will appear while the fax rings if caller information is not available.

- |                    |  |
|--------------------|--|
| NO SERVICE         | No caller information was received from your telephone company. Make sure that the telephone company has activated your service.                                     |
| CALLER-ID<br>ERROR | Noise on the telephone line prevented reception of caller information.   |
| OUT OF AREA        | The call was made from an area which does not have a caller identification service, or the caller's service is not compatible with that of your local phone company. |
| PRIVATE CALL       | Caller information was not provided by the telephone company at the caller's request.  |

## Viewing the Caller ID list

If you subscribe to a Caller ID service and have turned on the Caller ID function, your fax machine will keep information on the most recent 20 unanswered calls and/or unsuccessful faxes you have received. You can view this information, which consists of the name and number of each caller, in the Caller ID List.

**Note:** For all units installed in New Zealand, the direct use of the displayed number for call back does not operate properly and must not be used. It is necessary to manually enter the verified correct number for the party called. This will often require the addition or deletion of leading digits from the number shown on the display when dialling manually.

- ◆ After you have received 20 unanswered calls, each new call will delete the oldest call.

Follow the steps below to view the Caller ID List in the display. If desired, you can immediately dial a number when it appears.

To print out the list, see Chapter 9, *Printing Reports and Lists*.

- 
- 1** Press the keys shown at right. REVIEWING CALLS will appear in the display.



- 
- 2** Press the # key to scroll through the list from the most recent call, or the \* key to scroll through the list from the oldest call.

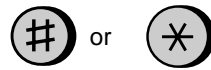

- 
- 3** If you want to dial one of the numbers in the list, scroll through the list until the number appears in the display.



- If you want to send a fax, load the document and then press the **START/MEMORY** key.
- If you want to make a voice call, pick up the handset or press the **SPEAKER** key. Dialing will begin automatically. (If you pressed the **SPEAKER** key, pick up the handset when the other party answers.)

- 
- 4** Press the **STOP** key when you have finished viewing the list.



**To delete calls from the caller list**

If you want to delete a single call from the caller list, press the "0" key while the call appears in the display. If you want to delete all calls from the list, hold the "0" key down for at least 3 seconds while you are viewing any number in the list.

**Priority Call**

If desired, you can set your fax to make a special ringing sound when you receive a call from a designated phone number. This lets you know immediately who is calling without having to look at the display. To use this function, enter the desired phone number by following the steps below (only one phone number can be entered).

- 
- 1** Press the keys shown at right. **PRIORITY CALL #** will appear in the display.

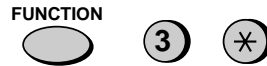

- 
- 2** Press **1** to enter a number, or **2** to clear a number. (If you pressed **2**, go to Step 4.)

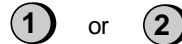

- 
- 3** Enter the phone number by pressing the number keys .



(Example)















- 
- 4** Press the **START/MEMORY** key and then the **STOP** key.



## Direct Call

If desired, you can allow a designated phone number to access a personal box directly when the answering machine is activated. In this case the caller will immediately hear the outgoing message of the personal box instead of that of the general box. You can designate one phone number for each personal box.

**Note:** This function cannot be used if you are using Distinctive Ring.

- 
- 1** Press the keys shown at left. "DIRECT CALL #" will appear in the display.   
- 
- 2** Press **1** to enter a number, or **2** to clear a number. (If you pressed **2**, go to Step 5.)  or 
- 
- 3** Enter the number of the personal box to be accessed directly.  (Example: "3" for personal box 3)
- 
- 4** Enter the phone number, including the area code, by pressing the number keys (the number must be 20 digits long).        (Example)
- 
- 5** Press the **START/MEMORY** key and then the **STOP** key.  

## Blocking voice calls

With Caller ID turned on, you can use the Anti Junk Fax function described in *Blocking Reception of Unwanted Faxes* in this chapter to prevent voice calls as well as fax receptions (the Anti Junk Fax function can normally only prevent faxes).

In this case, when a voice call or a fax transmission comes in from a number you have specified as a "Junk Number", your fax will break the connection as soon as it receives the calling phone number from the caller ID service (before the third ring).

To use this function, set Option Setting 13 to YES as described in Chapter 8, *Option Settings*, and then enter the number in the Anti Junk Number List as explained in *Blocking Reception of Unwanted Faxes* in this chapter.

**Note:** The blocked number must be input in the same format as Caller I.D. to be recognised, including applicable area codes.

**Note:** Blocking will not operate for numbers stored as priority or direct call numbers.

**Note:** Blocking voice calls will not operate if the number is already set as a direct or priority call number.

## ***Distinctive Ring***

If you subscribe to a distinctive ring service from your telephone company, you will need to turn on the distinctive ring function. When this is done, your fax machine will signal voice calls by the normal ring pattern, and fax transmissions by a special ring pattern. In the case of a fax transmission, your fax machine will automatically answer the call and receive the fax.

The distinctive ring function is used with the reception mode set to FAX or ANS.. When your fax number is dialled, your fax machine will signal the call with a special ringing sound, then answer automatically and begin reception after the number of rings set with Option Setting 2 (the factory setting is 2 rings). When your voice number is dialled, the fax machine will signal the call with the normal ringing to alert you to answer the call or allow the answering machine to take the call (when in ANS. mode).

The factory setting is "NO". If set to "YES", both Australian (Fax Duet) and New Zealand (FaxAbility) Distinctive Ring are supported.

### **Important:**

- The distinctive ring function can only be used if you subscribe to a distinctive ring service from your telephone company. Do not turn on distinctive ring if you are on a normal line, as the fax machine will not operate properly.
- If you turn on distinctive ring, the fax will not operate in TEL/FAX reception mode.

# Distinctive Ring

**1** Press these keys:



The display will show:

OPTION SETTING

**2** Press these keys:



The display will show:

DISTINCTIVE RING

**3** Press **1** (YES) to turn on distinctive ring, or **2** (NO) to turn it off.

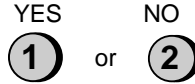

The display will show:

FAX SIGNAL RX

**4** Press the **STOP** key.



**5** Set the reception mode to FAX or ANS. .

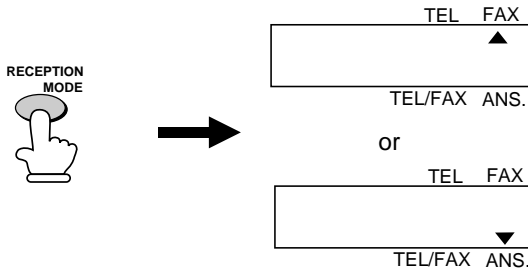



## Blocking Reception of Unwanted Faxes

The Anti Junk Fax function allows you to block reception of faxes from parties which you specify. This saves paper by not printing out unwanted "junk" faxes.

To use this function, first turn it on by setting Option Setting 13 to YES as described in Chapter 8, and then enter the fax numbers from which you do not want to receive faxes as shown below.

### Comments:

- The call will be terminated by the fax, however, the connection will remain until the caller hangs up or the line times out.
- Up to 5 numbers can be entered in the Anti Junk Number List.
- The Anti Junk function will not operate for a number which has been stored as a priority or direct call number.
- To clear a number from the Anti Junk Number List, you need to know the 1-digit number which identifies it. If you have forgotten this number, print out the Anti Junk Number List as described in Chapter 9.

- 
- 1** Press the keys shown at right.  
STORE JUNK # will appear in the display.



- 
- 2** Press **1** to store a number in the Anti Junk Number List, or **2** to clear a number from the list.

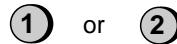

- 
- 3** Storing: Enter a 1-digit number from 1 to 5. This number identifies the fax/voice number you will store in the next step.  
**Clearing:** Enter the number which identifies the fax/voice number you want to clear, and go to Step 5.

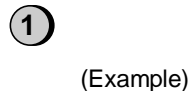

---

## Blocking Reception of Unwanted Faxes

---

- 4** Enter the full number you want to block  
(max. of 20 digits).



(Example)

- 
- 5** Press the **START/MEMORY** key.

START/MEMORY



- 
- 6** Return to Step 3 to enter (or clear)  
another number, or press **STOP** to exit.

Step 3 or

STOP



## Polling (Requesting a Fax Transmission)

Polling allows you to call another fax machine and have it send a document (previously loaded in its feeder) to your machine without operator assistance. In other words, the receiving fax machine, not the transmitting fax machine, initiates the transmission. You can use your machine to both poll and be polled by others.

To use the polling function, you must first set Rapid Key 10/POLL for use as a polling key. This is done by changing Option Setting 14, as described in Chapter 8, *Option Settings*. (Note that when Rapid Key 10/POLL is set as a polling key, it cannot be used for Rapid Key Dialling.)

### Requesting transmission

**Note:** Rapid Dial Keys cannot be used for polling. To dial a Rapid Dial location, press the **SPEED DIAL** key and then enter the 2-digit number corresponding to the Rapid Key.

**1** Dial the fax machine you want to poll using one of the following methods:

- Pick up the handset (or press the **SPEAKER** key) and dial the full number. Wait for the fax answerback tone.
- Press the **SPEED DIAL** key and enter a 2-digit Speed Dial number.
- Enter the full number using the numeric keys.

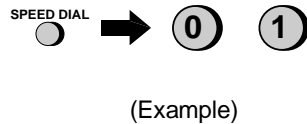

**2** Press Rapid Key 10/POLL.

- If you used the handset, replace it when **POLLING** appears in the display. Reception will begin.

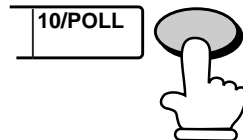

**Note:** When requesting a transmission from a facsimile information service (computer polling). Push the **START/MEMORY** key instead of the **POLL** key and make sure there are no documents loaded for sending.

### ***Turnaround polling***

After polling a fax machine, you can send a document to that machine on the same connection. Simply place the document to be sent in the feeder and follow the steps described above in "Requesting transmission". When polling is finished, the document will be automatically transmitted.

- ◆ The other fax machine must also have Turnaround Polling capability.
- ◆ Turnaround Polling cannot be performed when a timer transmission operation is set.

### ***Being polled (polling standby)***

To let another fax machine poll your machine, simply set the reception mode to FAX, and load the document(s) to be sent.

Transmission will take place when the other fax machine calls your machine and activates polling. Automatic reception is possible whilst your fax is on polling standby.

### ***Polling security***

Polling Security allows you to prevent unauthorized polling of your machine. When this function is turned on, polling will only take place when the fax number of the polling fax machine has been entered in your machine's list of permitted fax numbers (called "passcode numbers"). The number of the polling fax must also be correctly programmed into itself for identification.

To use Polling Security, follow the steps below to turn the function on, and then enter permitted numbers as shown on the following page.

- 
- 1** Press the keys shown at right.  
ENTRY MODE will appear in the display.



- 
- 2** Press the # key three times.  
SECURITY SELECT will appear in the display.



- 
- 3** Press **1** to turn polling security on, or **2** to turn it off.

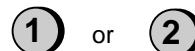

- 4** Press the **START/MEMORY** key and then the **STOP** key.

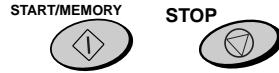

### Storing and clearing fax numbers for polling permission

You can store up to 10 fax numbers in your machine's list of permitted numbers.

- 1** Press the keys shown at right. **ENTRY MODE** will appear in the display.



- 2** Press the # key four times. **PASSCODE # MODE** will appear in the display.



- 3** Press **1** to store a number, or **2** to clear a number.

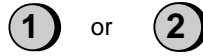

- 4** **Storing:** Enter a 2-digit number from 01 to 10. This number identifies the fax number you will store in the next step.  
**Clearing:** Enter the number which identifies the fax number you want to clear, and go to Step 6.



(Example)

- 5** Enter the fax number (max. of 20 digits).



(Example)

- 6** Press the **START/MEMORY** key.



- 7** Return to Step 4 to enter (or clear) another number, or press **STOP** to exit. **Step 4 or**



## Timer Operations

The Timer function allows you to set a transmission and/or polling operation to be performed automatically at a time you specify. One transmission operation and one polling operation can be set at the same time, and the times they will be performed can be specified up to 24 hours in advance.

As an example, you can use this function to take advantage of off-peak telephone rates without having to be there when the operation is performed.

**Note:** Only a Speed Dial number can be used to dial the receiving machine.

### Setting a timer operation

---

**1** Press the keys shown at right.  
TIMER MODE will appear in the display.



---

**2** Press # to set a transmission operation (SEND MODE), or \* to set a polling operation (POLLING MODE).

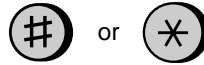

---

**3** Press 1 to select SET.



---

**4** Enter the time at which you want the operation to take place in 24-hour format (2 digits for the hour and 2 digits for the minute).



Example: 9:25

---

**5** Press the **START/MEMORY** key.



- 6** Enter the Speed Dial number of the receiving fax machine.
- If this is a polling operation, go to Step 9.

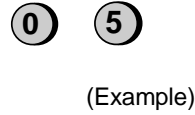

- 7** Press the **START/MEMORY** key.



- 8** Adjust the resolution and/or contrast if desired (skip to the next step if you don't want to change settings).



- 9** Press the **START/MEMORY** key and then the **STOP** key. If this is a transmission operation, load the document in the feeder sometime before the specified time of transmission.



### To cancel an operation

If you need to cancel an operation after it has been set, follow the steps below.

- 1** Press the keys shown at right. **TIMER MODE** will appear in the display.



- 2** Press **#** to cancel a transmission operation, or **\*** to cancel a polling operation.

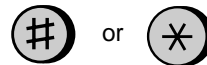

- 3** Press **2** to select **CLEAR**.



- 4** Press the **START/MEMORY** key and then the **STOP** key.



## Memory

Your fax has a memory which can be used to temporarily store both incoming and outgoing documents.

- ◆ Approximately 20 pages of average content can be held in memory when no voice messages (including outgoing messages) have been recorded. Less can be held if any pages were scanned using fine or halftone resolution.
- ◆ To see the percentage of memory that is currently occupied, press the **START/MEMORY** key with no document in the feeder. The percentage will appear in the display.

### **Sending documents from memory**

With this function, the original document is scanned immediately, stored in memory, and then transmitted once the connection to the receiving machine is made. This is convenient when transmitting to places where the line is often busy, as it saves you from waiting to collect the original document and frees the feeder for other operations.

- ◆ Only one memory transmission can be set at a time.
- ◆ The amount of memory currently occupied appears as a percentage in the display while the document is being scanned.

---

**1** Load the document(s).

- Set the resolution and/or contrast if desired.

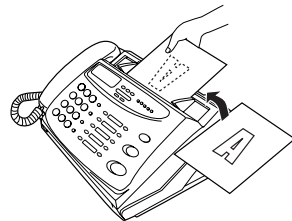

RESOLUTION



---

**2** Press the **START/MEMORY** key and then **1**.

START/MEMORY





**3** Enter the number of the receiving machine using one of the following methods:

- Press a Rapid Key.
- Press the **SPEED DIAL** key and enter a Speed Dial number.
- Enter a full telephone number by pressing the number keys.

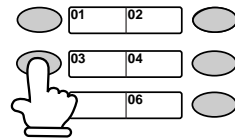

(Example)

**4** Press the **START/MEMORY** key if you entered a Speed Dial number or a full number.

- The document is first scanned and stored in memory. The other machine is then dialled (redialling will be performed automatically if necessary). When the connection is made, transmission begins. Afterwards, the document is cleared from memory and your fax returns to standby mode.



### ***If the memory becomes full...***

If the memory becomes full while the document is being scanned, MEMORY IS FULL will appear in the display.

- ◆ Press the **START/MEMORY** key if you want to transmit the pages which have been stored up to that point in memory. The remaining pages will be ejected from the feeder. After transmission, the memory will be cleared and you can transmit the remaining pages. You will also need to transmit the page which was being scanned when the memory filled up.
- ◆ Press the **STOP** key if you want to cancel the entire transmission.

***Substitute reception into memory***

This is a back-up function which is automatically activated if your fax runs out of paper or the paper jams.

When you have received a document in memory, FAX RX IN MEMORY will appear in the display, alternating with OUT OF PAPER or PAPER JAMMED. When you add paper or clear the paper jam, the stored documents will automatically be printed out.

## Broadcasting

This function allows you to send the same document to as many as 10 different locations with just one operation. First store the document in memory, then enter the numbers of the receiving machines. The document will be transmitted to each location.

- ◆ You can only use Rapid Keys or Speed Dial numbers to dial the numbers of the receiving machines.

### 1 Load the document(s).

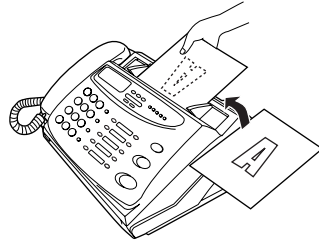

### 2 Press the **START/MEMORY** key and then 2.

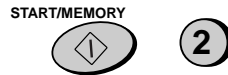

### 3 Dial the receiving machines by using one or both of the following methods. (a maximum of 10 stations can be selected)

- Enter one or more Speed Dial numbers by pressing the numeric keys.
- Press one or more Rapid Keys.

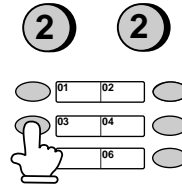

(Example)

### 4 Press the **START/MEMORY** key.

- Set the resolution and/or contrast if desired.



**5** Press the **START/MEMORY** key.  
Transmission will begin.

- A Transaction Report is automatically printed out after Broadcasting is completed. Check the "Note" column of the report to see if any of the locations are marked "Busy" or have a communication error code. If so, send the document to those locations again.

**START/MEMORY**



## Reminder Function

The Reminder function allows you to send either a voice message, fax message, or both to another person or yourself at a preset time. If the reminder is for another person, the FO-475 will call the other machine and transmit the message when the selected time arrives. If the reminder is for you, the FO-475 will prompt you to press the **REMINDER** key to play and/or print out the message.

- ◆ Only one reminder (voice message, fax, or both) can be set at one time.
- ◆ The reminder can be set up to one year in advance.

### Setting a reminder

- 1** Press the **REMINDER** key.

REMINDER



- 2** Enter two digits for the day ("01" to "31") and two digits for the month ("01" to "12").



(Example: 15th May)

- 3** Enter two digits for the hour ("01" to "23"), and two digits for the minute ("00" to "59").



(Example: 9:25)

- 4** Press the **START/MEMORY** key.

START/MEMORY



- 5** If the reminder is for another person, enter his or her telephone or fax number (max. 32 digits). (Skip this step if the reminder is for you.)



(Example)

**6** Press the **START/MEMORY** key.



**7** To record a voice message, pick up the handset, press the **START/MEMORY** key, and speak into the handset. When finished, press the **STOP** key and replace the handset. (Skip this step if you only want to send a fax message.)

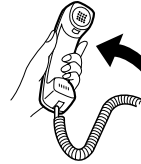

**8** Press the **START/MEMORY** key.



**9** If you are only sending a voice message, press the **REMINDER** key.



OR

If you are sending a fax message, press the **START/MEMORY** key, load the document, set the resolution if desired, and then press the **START/MEMORY** key again.

- The document will be scanned and stored in memory.

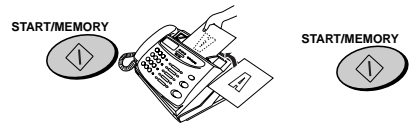

### **When the selected time arrives**

If the reminder is for you, the fax will beep repeatedly for 60 seconds when the selected time arrives and "PRESS REMINDER" will appear in the display. Press the **REMINDER** key to play the voice message and/or print out the fax message.

If the reminder is for another person, your fax will call his or her number and then play the voice message and/or transmit the fax message. If the line is busy or no one answers, 2 redialling attempts will be made at intervals of 5 minutes.

**Note:** If your fax machine calls another person to send him or her a voice message and an answering machine receives the call, it will not be possible for the voice message to be successfully recorded in the answering machine.

***To check or cancel a reminder message***

To check a reminder message before it is sent, press the **REMINDER** key and then press "1". The set date and time will appear, followed by the telephone or fax number of the receiving party if the reminder is for another person. Press the **START/MEMORY** key to play the recorded message and/or print the document.

## Option Settings

The option settings let you customise your fax to better suit your needs. An initial setting has been made for each option at the factory. You can change a setting by following the steps described for each option below.

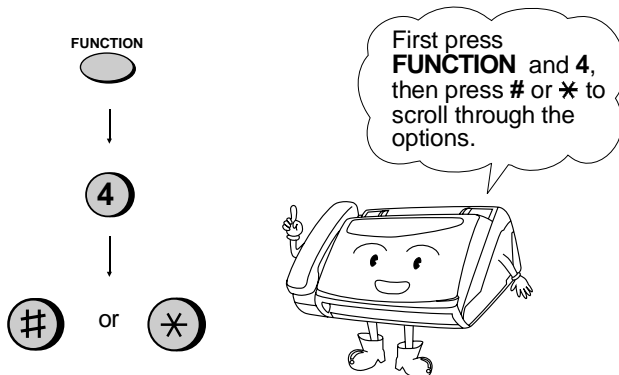

### Setting 1: FINE RESOLUTION PRIORITY

This option sets the default resolution (the resolution used if a setting is not made with the **RESOLUTION** key) for transmitting documents. Press **1** (YES) to set the default resolution to FINE, or **2** (NO) to set it to STANDARD.

- Initial setting: 2

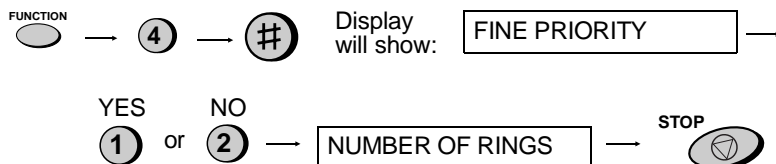

### Setting 2: NUMBER OF RINGS TO ANSWER

This sets the number of rings the fax machine waits before answering an incoming call in FAX and TEL/FAX reception modes. Enter any number from 2 to 4.

- Initial setting: 2





**Setting 3: 4 RINGS TEL ANSWER**

Press **1** (YES) to have the FAX answer a call after 4 rings when it is in TEL reception mode. Press **2** (NO) to turn the function off.

- Initial setting: **2**

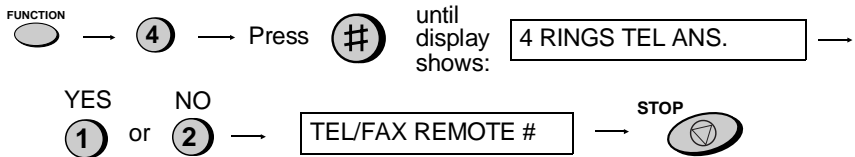
**Setting 4: TEL/FAX REMOTE NUMBER (TRANSFER CODE)**

If you hear a fax tone when you answer a call on a tone dial extension phone connected to the same line as the fax, you can make the fax begin reception by pressing **5**, **\***, and **\*** on the phone. Use this setting if you want to use a number other than **5** to begin fax reception. You can enter any number from **0** to **9**.

- Initial setting: **5**

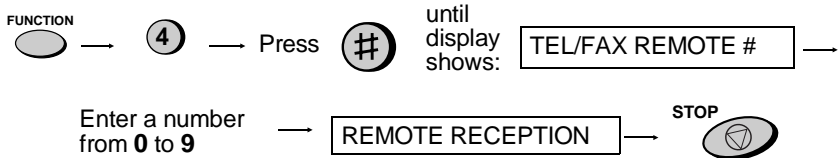
**Setting 5: REMOTE RECEPTION SELECT**

If you don't intend to use the above TEL/FAX REMOTE NUMBER, you can turn detection of the number off. This will ensure that the fax never mistakenly attempts to begin reception if it detects a signal similar to the TEL/FAX REMOTE NUMBER while you are talking on an extension phone. Press **1** to turn detection on, or **2** to turn detection off.

- Initial setting: **1**



**Setting 6: TRANSACTION REPORT PRINT SELECT**

This sets the condition for printing out a Transaction Report. Enter a number from **1** to **4** as follows:

- 1 (ALWAYS PRINT):** A report will be printed after each transmission, reception, or error.
- 2 (ERR/TMR/MEM. PRINT):** A report will be printed after an error or a timer operation.
- 3 (SEND ONLY):** A report will be printed only after a transmission.
- 4 (NEVER PRINT):** A report will never be printed.

• Initial setting: **2**

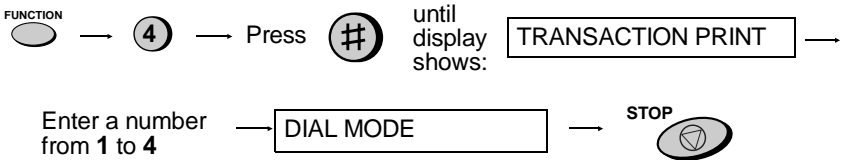

**Setting 7: DIAL MODE**

This sets the mode of dialling. Press **1** if you are on a tone dial line, or **2** if you are on a pulse dial line.

• Initial setting: **1**



**Note:** For all units installed in New Zealand, select "1" for tone dialling. The pulse setting "2" will not operate correctly and must not be used.

**Setting 8: PSEUDO RINGING DURATION**

This sets the duration of pseudo ringing in TEL/FAX reception mode. Press **1** for 15 seconds or **2** for 30 seconds.

- Initial setting: **1**

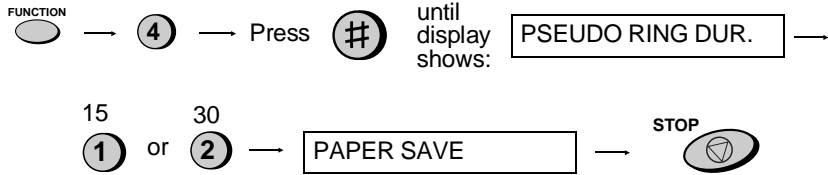
**Setting 9: PAPER SAVE**

This reduces the vertical length of documents received, allowing you to save paper. Enter a number from **1** to **3** as follows ("S" will appear highlighted in the display while Paper Save is turned on and a document is being sent or received):

- |                    |  |
|--------------------|--|
| <b>1 (MODE 1):</b> | Reduce only the white spaces between lines.                                |
| <b>2 (MODE 2):</b> | Reduce the entire document by 50% (only when standard resolution is used). |
| <b>3 (NO):</b>     | No Paper Save.   |

- Initial setting: **3**

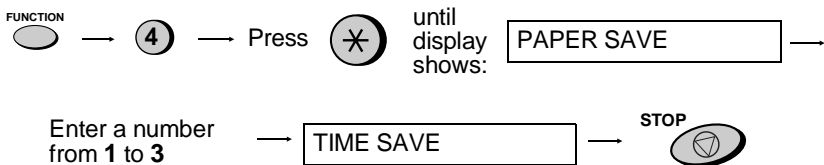

**Setting 10: TIME SAVE**

This reduces the vertical length of documents transmitted by 20%, saving line time and thereby allowing you to reduce telephone costs. Press **1** to turn the function on, or **2** to turn it off. ("T" will appear highlighted in the display while Time Save is turned on and a document is being sent or received):

- Initial setting: 2

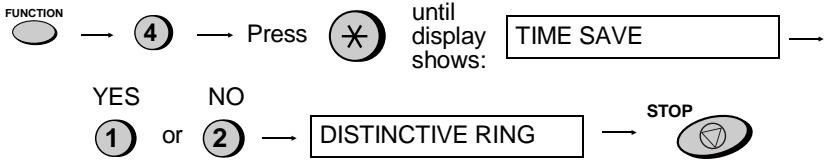

**Setting 11: DISTINCTIVE RING**

If you subscribe to a distinctive ring service from your telephone company, press **1** to have your facsimile automatically answer distinctive ring calls and ignore voice calls made to the normal telephone number. Press **2** to turn the function off. (This setting is described in more detail in *Distinctive Ring* in Chapter 7.)

- Initial setting: 2



**Setting 12: FAX SIGNAL RECEIVE**

Your fax will automatically begin reception if you hear a high-pitched fax tone after answering a call. If you use a computer fax modem on the same line, you must turn this function off in order to prevent your fax from mistakenly attempting to receive documents sent from the computer fax modem. Press **1** to turn the function on, or **2** to turn it off.

- Initial setting: 1



**Setting 13: JUNK NUMBER CHECK**

Press **1** to prevent reception from fax numbers entered in the Anti Junk Number List. Press **2** to allow reception from all numbers.

- Initial setting: **2**

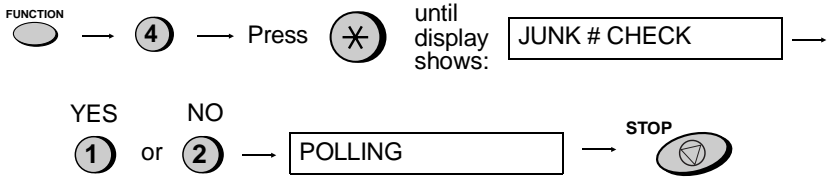
**Setting 14: POLLING**

Press **1** if you want to use Rapid Key 10/POLL as a polling key. Press **2** if you want to use it as a regular Rapid Key.

- Initial setting: **2**

**Setting 15: CALLER ID**

If you subscribe to a caller ID service and want to use the Caller ID function, press **1**. To turn Caller ID off, press **2**. (Caller ID is explained in more detail in *Caller ID* in Chapter 7.)

- Initial setting: **2**



## Printing Reports and Lists

You can print out lists showing settings and information entered in the fax. You can also have the fax automatically print out a report on transactions after they are made. The lists and the report are shown below.

### Printing a list

- 1 Press these keys:



The display will show:

LISTING MODE

- 2 Press the # key or the \* key until the desired list appears in the display.

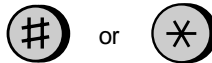

- 3 Press the **START** key.



### Timer list

This list shows the timer operations which are currently set.

TIMER LIST		04-AUG -1998 10:30
FOR: John Doe Corp.		201 555 1234
<hr/>		
TIMER SEND		
START	09:28	
RECEIVER	ABC TOOL	
RESOLUTION	FINE	: AUTO
<hr/>		
TIMER POLLING		
START	11:30	
SENDER	JACK JONES	
<hr/>		

## Telephone Number List

This list shows the fax and voice numbers which have been stored for automatic dialling.

TELEPHONE NUMBER LIST		
FOR: John Doe Corp.		04-AUG-1998 10:30 201 555 1234
SPEED NO.	NAME	TELEPHONE NO.
01	N. Y.	123-786-8340
02	JANE SMITH	258-942-7417
03	ABC TOOL	965-125-0546
04	JACK JONES	532-740-3341

## Passcode List

This list shows settings made for polling security, your name and fax/telephone number as entered in the machine, and a sample of the header printed at the top of every page you transmit (**HEADER PRINT**).

PASSCODE LIST	
FOR: John Doe Corp.	04-AUG-1998 10:30 201 555 1234
POLLING MODE	SECURITY OFF
PASSCODE NO.	
	01 12345678901234567890
	02 9988540885
	03 1111111111
	04
	05
	06
	07
	08
	09
	10
PRIORITY CALL NO.	5556659870
SENDER'S NAME	
John Doe Corp.	
SENDER'S TELEPHONE NUMBER	
201 555 1234	
HEADER PRINT	
04-AUG-1998 10:30	John Doe Corp. 201 555 1234 P. 01

### Option Setting List

This list shows the current status of the option settings.

OPTIONS SETTING LIST		
FOR: FOR: John Doe Corp.		04-AUG-1998 17:14 201 555 1234
NO.	ITEM	SETTING
1	FINE PRIORITY	NO
2	NUMBER OF RINGS IN AUTO ANSWER MODE	2 RINGS
3	4 RINGS TEL ANSWER	NO
4	TEL/FAX REMOTE NO.	(5)**
5	REMOTE RECEPTION	YES
6	TRANSACTION PRINT SELECT	ERR/TIMER/MEMORY
7	DIAL MODE	TOUR
8	PSEUDO RINGING DURATION	15S
9	PAPER SAVE	NO
10	TIME SAVE	NO
11	DISTINCTIVE RINGING	NO
12	FAX SIGNAL RECEIVE	YES
13	JUNK NO. CHECK	NO
14	POLLING	NO
15	CALLER-ID	NO

### Anti Junk Number List

This list shows the numbers that are blocked by the Anti Junk function.

ANTI JUNK NUMBER LIST		
FOR: John Doe Corp.		04-AUG-1998 10:30 201 555 1234
ANTI JUNK #	CHECK	: NO
STORED LOCATION	JUNK FAX NO.	
1		1234567890
2		11122233344455566677
3		123987093667

### ANS. Program List

This list shows the settings and codes programmed for the answering machine.

ANS. PROGRAM LIST		
FOR: John Doe Corp.		04-AUG-1998 10:58 555 5641
ITEM	CONTENT	
CGM RECORDING	GENERAL:	RECORDED
	BOX-1:	RECORDED
	BOX-2:	NOT RECORDED
	BOX-3:	NOT RECORDED
TOLL SAVER	YES	
RECORDING TIME	4 MIN.	
SENCE CODE NO.	222	
OVERRIDE CODE NO.	564	
TRANSFER TELEPHONE NO.	123456	
TRANSFER TELEPHONE CALLING	NO	
FAX BOX FUNCTION	YES	
ON-ANS. FAILURE	YES	
(JUNK SETS TO AUTO FAX REC.)		
BOX PASSCODE NO.	GENERAL:	STORED
	BOX-1:	STORED
	BOX-2:	NOT STORED
	BOX-3:	NOT STORED
DIRECT CALL NO.	BOX-1:	NOT STORED
	BOX-2:	NOT STORED
	BOX-3:	NOT STORED



### Message List

This list shows information about the messages currently recorded in the answering machine, including the date and time of recording, the length, and the type (ICM or memo).

MESSAGE LIST							
FOR: John Doe Corp.				04-AUG-1998 16:59			
				555 5541			
NO.	RECORDED	TIME	MESSAGE	LENGTH	TYPE	FAX	PAGES
01	04-AUG	16:15		14"	2-WAY		
02	04-AUG	16:16		09"	MEMO		
03	04-AUG	16:18		04"	ICM		

### Caller ID List

This list shows information about your most recent unanswered calls (maximum of 20 calls). (This list is only available if you are using the Caller ID function.)

CALLER-ID LIST						
FOR: John Doe Corp.				04-AUG-1998 10:30		
				201 555 1234		
NO.	DATE	RX	TIME	NAME	TELEPHONE NO.	MODE
01	04-AUG	09:38		JONES JENNIFER	111-111-1111	FAX
02	04-AUG	09:48		SMITH SHARON	333-333-3333	FAX
03	04-AUG	09:50		MACDONALD MIKE	222-222-2222	TEL

## Transaction Report

This report is printed out automatically after an operation is performed to allow you to check the result. Your fax is set at the factory to print out the report after a timer operation or when an error occurs. If desired, you can change the setting to have it printed out under a variety of other conditions. This is done by changing Option Setting 6 as described in Chapter 8.

- ◆ The Transaction report cannot be printed out manually.

```
XXXXXXXXXXXXXXXXXXXXXXXXXXXXXXXXXXXXXXXXXXXXXXXXXXXXXXXXXXXXXXXXXXXX
X
X                               TRANSACTION REPORT                               X
X                               04-AUG-1998 10:30                               X
X   FOR: John Doe Corp.           201 555 1234                               X
X   _____X
X   TIMER SEND      (RESERVED TIME 10:30)                                X
X   _____X
X   DATE  START    RECEIVER          PAGES  TIME  NOTE                    X
X   _____X
X   04-AUG 10:30   JACK JONES         0     **'**"  CANCEL                X
X   _____X
XXXXXXXXXXXXXXXXXXXXXXXXXXXXXXXXXXXXXXXXXXXXXXXXXXXXXXXXXXXXXXXXXXXX
```

### Explanation of headings

**SENDER/RECEIVER** The fax number of the other machine involved in the transaction. In the case of a transmission, the number dialled appears. In the case of a reception, the programmed ID of the sending machine appears. If this machine does not have an ID function, the communication mode will appear (for example, "G3").

**PAGES** Number of pages transmitted or received.

**NOTE** **OK** - Transmission/reception was normal.

**P.FAIL** - A power failure occurred. If you have power and the problem persists, try a different outlet. If necessary, have an electrician check your power lines.

**JAM** - A problem with the paper or original document occurred. Make sure the paper or document is loaded properly. Make sure the operation panel is shut securely.

**NO PAPER** - You ran out of paper during reception.

**COME-0 to COME-7** - A telephone line error prevented the transaction. See *Line Error in Problems and Solutions* in Chapter 11.

**CANCEL** - Transmission was cancelled because the **STOP** key was pressed, no document was in the feeder, or the other machine requested transmission using a function which your fax does not have. If you were attempting to fax, make sure a document is in the feeder. If you were receiving, contact the faxing party to see how they are trying to send to you.

**Fax print head**

Clean the print head frequently to ensure optimum printing performance. To clean the print head, first disconnect the telephone line, then unplug the power lead, open the operation panel (pull the release marked **PANEL RELEASE** toward you), and remove the fax paper.

Wipe the print head with a soft cloth dampened with methyl alcohol.

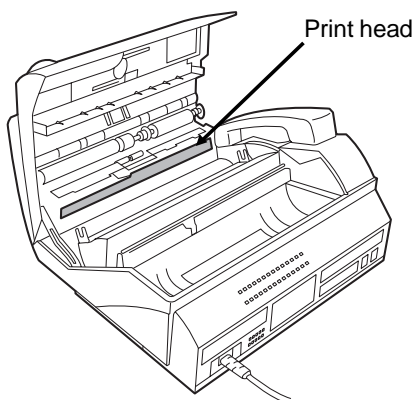
**Caution!**

- Do not use benzene or thinner. Avoid touching the print head with hard objects.
- The print head may be hot if your fax machine has just received a large number of documents. If this is the case, allow the print head to cool prior to cleaning.

## ***Scanning glass and rollers***

Clean the scanning glass and rollers frequently to ensure the quality of transmitted images and copies. Open the operation panel (pull the release marked **PANEL RELEASE** toward you), and wipe the scanning glass and rollers with a soft cloth.

- ◆ Make sure that all dirt and stains (such as correcting fluid) are removed, as dirt and stains will cause vertical lines on transmitted images and copies.
- ◆ Adhesive cellophane tape is useful for removal of debris from the rollers.

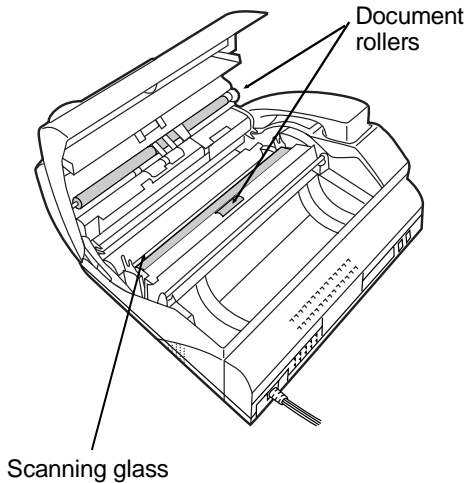

## ***The housing***

Wipe the external parts and surface of the machine with a dry cloth.

### **Caution!**

- Do not use benzene or thinner. These solvents may damage or discolour the machine.

**Problems and Solutions****Line error**

<b>Problem</b>	<b>Check and remedy</b>
<p>E appears in the display and/or a transaction report is printed out with <b>COM. E-</b> and a number from <b>0</b> to <b>1</b>, <b>2</b>, <b>3</b>, <b>4</b>, <b>5</b>, <b>6</b>, or <b>7</b> in the <b>NOTE</b> column.</p>	<ul style="list-style-type: none"><li>• Try the operation again. If the error persists, check the following:</li><li>• Check the connection. The cord from the <b>TEL. LINE</b> socket to the wall socket should be no longer than two meters.</li><li>• Check with the other party to make sure their fax machine is functioning properly.</li><li>• Have your telephone line checked for line noise.</li><li>• Try connecting your fax to a different telephone line.</li><li>• If the problem still occurs, your fax machine may need service.</li><li>• Call your dealer or the SHARP number(s) listed on the warranty card.</li></ul>

**Dialing and transmission problems**

Problem	Check and remedy
No dial tone when you pick up the handset or press the <b>SPEAKER</b> key.	<ul style="list-style-type: none"> <li>• Make sure the telephone line is connected to the correct socket. See <i>Handset</i> in <i>Connections</i> in Chapter 1.</li> </ul>
Dialling is not possible.	<ul style="list-style-type: none"> <li>• Make sure the power cord is properly plugged into a power outlet.</li> <li>• Make sure that the telephone line is properly connected to both the <b>TEL. LINE</b> socket and the wall socket.</li> <li>• Make sure that the fax is set to the correct dialling mode for your telephone line. See Option Setting 7 in Chapter 8.</li> </ul>
The power is on, but no transmission takes place.	<ul style="list-style-type: none"> <li>• Make sure that the receiving machine has fax paper.</li> <li>• Make sure that the telephone line cord is plugged into the <b>TEL. LINE</b> socket, and not the <b>TEL. SET</b> socket.</li> <li>• If the receiving machine is in telephone mode with no attendant, reception will not be possible.</li> <li>• Check the display for error messages.</li> <li>• Pick up the handset and check for a dial tone. Call the receiving machine by normal (telephone) dialling, and confirm its response.</li> </ul>
Nothing is printed at the receiving end.	<ul style="list-style-type: none"> <li>• Make sure that the document for transmission is placed face down in the feeder.</li> <li>• Make sure that the fax paper is properly loaded at the receiving machine.</li> </ul>
A distorted image is received at the other end.	<ul style="list-style-type: none"> <li>• Noise on the telephone line may cause distortion. Try sending the document again.</li> <li>• Make a copy of the document on your fax. If the copy is also distorted, your fax may have a problem. If the problem persists, call for service.</li> </ul>

**Reception and copying problems**

<b>Problem</b>	<b>Check and remedy</b>
The power is on, but no reception takes place.	<ul style="list-style-type: none"> <li>• Make sure the wall socket is connected to the <b>TEL. LINE</b> socket, and <b>not</b> the <b>TEL. SET</b> socket.</li> <li>• Check that fax is not set to distinctive ringing.</li> <li>• Check the FO-475 is set to <b>FAX</b> or <b>ANS.</b> mode.</li> </ul>
The fax paper does not come out.	<ul style="list-style-type: none"> <li>• The fax paper may be jammed. See <i>Clearing jammed fax paper</i> in this chapter.</li> </ul>
The fax paper comes out blank when you try to receive or copy a document.	<ul style="list-style-type: none"> <li>• Make sure that the fax paper is properly loaded in your fax. (If the roll has been loaded backward, nothing will be printed.)</li> <li>• For reception, make sure that the document for transmission is loaded face down in the feeder of the transmitting machine.</li> </ul>
The received document is faint.	<ul style="list-style-type: none"> <li>• Make sure that you are using the recommended fax paper. See <i>Loading the Fax Paper</i> in Chapter 1.</li> <li>• Ask the other party to send higher contrast documents. If the contrast is still too low, your fax may have a problem. Make a copy to check it.</li> </ul>
Received images are distorted.	<ul style="list-style-type: none"> <li>• Noise on the telephone line may cause distortion. Have the other party try sending the document again.</li> <li>• The print head may be dirty. See <i>Fax print head</i> in Chapter 10.</li> <li>• Make a copy of another document on your fax. If the copy is also distorted, your fax may have a problem. If the problem persists, call for service.</li> </ul>
Copies are distorted.	<ul style="list-style-type: none"> <li>• Make sure that you are using the recommended fax paper. See <i>Loading the Fax Paper</i> in Chapter 1.</li> <li>• Make sure that the fax paper is properly loaded in your machine.</li> <li>• The print head may be dirty. See <i>Fax print head</i> in Chapter 10.</li> </ul>

## Problems and Solutions

Reception/copying is interrupted.	<ul style="list-style-type: none"><li>• If reception or copying has been done continuously for a long time, the print head may have become overheated. Turn off the power and let it cool down.</li></ul>
A received document or copy prints out in strips.	<ul style="list-style-type: none"><li>• Make sure the operation panel is completely closed (press down on both sides).</li></ul>

### General problems

Problem	Check and remedy
Nothing appears in the display.	<ul style="list-style-type: none"><li>• Make sure the power cord is properly plugged into a power outlet.</li><li>• Connect another electrical appliance to the outlet to confirm that it has power.</li></ul>
The machine does not respond when you press any of its keys.	<ul style="list-style-type: none"><li>• If a beep sound is not made when you press the keys, unplug the power cord and then plug it back in several seconds later.</li></ul>
Automatic document feeding does not work for transmission or copying.	<ul style="list-style-type: none"><li>• Check the size and weight of the document (see <i>Transmittable documents</i> in Chapter 3).</li></ul>
Voice calls taken on an extension phone are interrupted by the fax.	<ul style="list-style-type: none"><li>• The fax may interrupt during a voice call if the reception mode is set to ANS. To prevent interruption on a tone dial extension phone, press any three keys on the extension phone after answering. (Note: Do not enter the code to activate fax reception.)</li></ul>
No reception occurs when polling is attempted.	<ul style="list-style-type: none"><li>• Make sure you have not run out of paper.</li><li>• Make sure the machine to be polled (responding fax machine) is in the <b>FAX</b> reception mode.</li><li>• If the responding machine has polling security make sure that your fax number has been entered in the responding machine's polling permission numbers in exactly the same way you entered in your machine's OWN NUMBER SET.</li></ul>



<p>Bell tinkle (New Zealand)</p>	<ul style="list-style-type: none"><li>• The operation of this equipment on the same line as the telephone or other equipment with audible warning devices or automatic ring detectors will give rise to bell tinkle or noise and may cause problem, contact your Sharp authorised Service Centre for information.</li></ul>
--------------------------------------	---

## ***Messages and Signals***

### ***Display messages***

**Note:** If you have turned on the Caller ID function, see *Caller ID* in Chapter 7 for display messages related to Caller ID.

ANS. TRANSFER	The answering machine's transfer function has been turned on as explained in <i>Transfer Function</i> in Chapter 2.
DOCUMENT JAMMED	The original document is jammed. See the following section, <i>Clearing Paper Jams</i> .
FUNCTION MODE	The <b>FUNCTION</b> key has been pressed.
HOLD	The <b>HOLD/SEARCH</b> key has been pressed to put the other party on hold during a phone conversation. Press the <b>HOLD/SEARCH</b> again to take the other party off hold.
LINE ERROR	Transmission or reception was not successful. Press <b>STOP</b> to clear the message, and then try again. If the error persists, see <i>Line Error</i> in <i>Problems and Solutions</i> in this chapter.
NO DATA	This appears if you attempt to search for an automatic dialling number when none have been stored.
NO # STORED	You have tried to dial or clear a Rapid Key or Speed Dial number that hasn't been programmed (a full number hasn't been assigned to it).
OUT OF PAPER	You have run out of fax paper. Load a new roll of fax paper as explained in <i>Loading the Fax Paper</i> in Chapter 1.
ON HOOK DIAL	The <b>SPEAKER</b> key has been pressed and the fax is waiting for you to dial. (To return to the date and time display, press the <b>SPEAKER</b> key again.)
OVER HEAT	The print head has overheated. Operation may be continued once it cools.

PAPER JAMMED	The fax paper is jammed. See the following section, <i>Clearing jammed fax paper</i> .
READY TO SEND	A document has been loaded and the fax is waiting for transmission or copying instructions.
RECALLING	This appears if you attempt to send a fax by automatic dialling and the line is busy or the receiving fax machine does not answer. Your fax machine will automatically reattempt the call. (See <i>Automatic Redialling</i> in <i>Sending a Fax by Automatic Dialling</i> in Chapter 3.)
SEARCH DIAL	The <b>HOLD/SEARCH</b> key has been pressed. Press <b>#</b> or <b>*</b> to search for an automatic dialling number, or press <b>STOP</b> to return to the data and time display. (See <i>Using the HOLD/SEARCH key</i> in <i>Sending a Fax by Automatic Dialling</i> in Chapter 3.)
TOTAL PAGE(S) 01	Number of pages transmitted, received, or copied.

### Audible signals

Continuous tone	3 seconds	Indicates the end of transmission, reception, or copying.
Intermittent tone (3 beeps)	5 seconds (1 second on, 1 second off)	Indicates incomplete transmission, reception, or copying.
Rapid intermittent tone	35 seconds (0.7 seconds on, 0.3 seconds off)	Indicates that the handset is off hook.

## Clearing Paper Jams

### Clearing a jammed document

If the original document doesn't feed properly during transmission or copying, or DOCUMENT JAMMED appears in the display, first try pressing the **START/MEMORY** key. If it doesn't feed out, remove it as follows:

**Important:**

Do not try to remove a document without opening the operation panel. This may damage the feeder mechanism.

- 
- 1** Pull the release marked **PANEL RELEASE** toward you and open the operation panel.

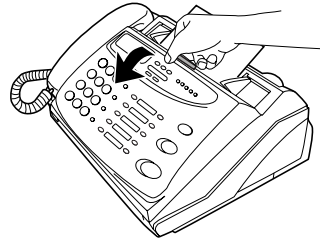

- 
- 2** Remove the document.

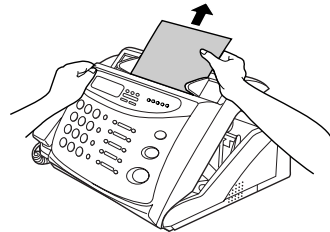

### Clearing jammed fax paper

- 
- 1** Pull the release marked **PANEL RELEASE** toward you and open the operation panel.

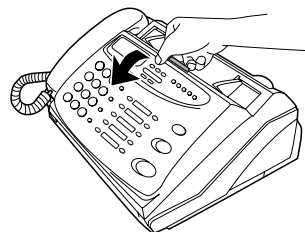

**2** Remove the paper roll.

- If any pieces of paper are stuck in the cutter, remove them with caution.
- Press the **START/MEMORY** key to reset the cutter.

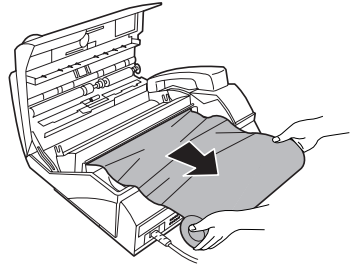

**3** Cut off the wrinkled part of the paper.

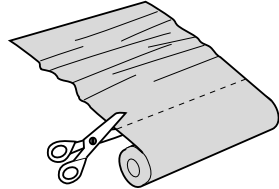

**4** Reload the paper.

- Jammed fax paper is often caused by improper loading. Be sure to carefully follow the instructions for paper loading given in *Loading the Fax Paper* in Chapter 1.

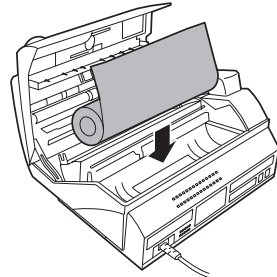

**If the display still shows PAPER JAMMED**

If the display still shows PAPER JAMMED after you press the **START/MEMORY** key in Step 2 above, the cutter is still engaged in the cutting position. To open the cutter, turn the fax up on its rear end and insert any long, rod-like object with a flat or blunt end into the hole marked

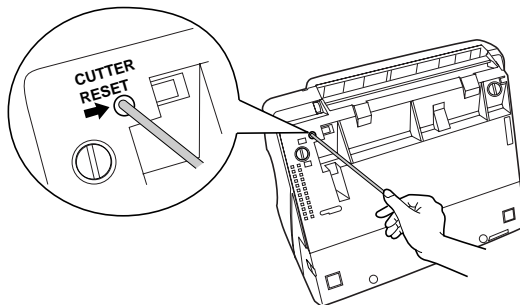

---

# Index

## A

ANS. Program List, 100  
ANS. reception mode, 19, 64  
Answering machine Operation, 22  
Anti junk fax, 77  
Anti Junk Fax (Anti Junk Number), 97  
Anti Junk Number List, 100  
Audible signals, 111  
Automatic dialling, 58  
Automatic dialling, storing numbers, 55

## B

Broadcasting, 87

## C

Caller ID, 70  
Caller ID List, 72,101  
Chain Dialling, 69  
Cleaning, 103 - 104  
Contrast, 50  
Copies, 67  
Copy/Help key, 4, 67

## D

Date, setting, 17  
Delete key, 3, 27  
Dial mode, 94  
Dialling  
    Direct Keypad, 60  
    Normal, 52, 68  
    Rapid Key, 58, 68  
    Search, 61, 69  
    Speed, 59, 68  
Direct Call, 74  
Direct Keypad Dialling, 60  
Display, 2  
Display messages, 110  
Distinctive Ring, 75  
Document feeder, 48

Document guides, 48  
Document restrictions, 47  
Document rollers, 104  
Document sizes, 46  
Document, maximum scanning size, 47  
Down key, 20

## E

Extension telephone  
    Connecting, 9  
    Using, 66

## F

Fax Ability (Distinctive Ring), 75  
Fax box function, 30  
Fax Duet (Distinctive Ring), 75  
Fax paper  
    Loading, 10  
    Replacing, 13  
FAX reception mode, 19, 64  
Fax reception on ANS. failure, 32  
Fax Signal Receive, 96  
Fine Resolution Priority, 92  
Four rings TEL answer, 93  
Function key, 2

## H

Halftone, 50  
Handset, 6  
Hold, 69  
Hold/Search key, 4, 69  
Housing, cleaning, 104

## I

Incoming message time, 31  
Installation, 5

**J**

Jams, clearing, 112  
Junk Number Check, 97

**L**

Letters, entering, 16  
Line error, 105  
Loading the document, 48

**M**

Maintenance, 103  
Memory, 84  
    Reception, 86  
    Transmission, 84  
Memo recording, 45  
Memory key, 84, 87  
Message List, 101  
Messages  
    Checking date and time, 28  
    Erasing, 27  
    Listening to, 25  
    Listening to remotely, 40  
    Setting allowed time, 31  
Moving your fax, 7

**N**

Normal Dialling, 52, 68  
Number keys, 3  
Number of rings in FAX and TEL/FAX  
reception modes, 92

**O**

Option Setting List, 100  
Outgoing message, 22  
Override Ringing, 36

**P**

Panel release, 2  
Paper jams, clearing, 112  
Paper Save setting, 95  
Paper, fax, 10  
Passcode List, 99  
Passcodes for boxes, 26 - 27, 29, 40  
Pauses in automatic dialling, 55, 60  
Play/Skip key, 3, 26  
Polling, 79 - 81  
Polling key, setting, 97  
Print head, cleaning, 103  
Priority Call, 73  
Pseudo ringing duration, 95

**R**

Rapid Dial keys, 4  
Rapid Key Dialling, 58, 68  
Rec/Memo key, 3, 27  
Reception mode  
    ANS. mode, 19, 64  
    FAX mode, 19, 64  
    Setting, 19  
    TEL mode, 19, 65  
    TEL/FAX mode, 19, 63  
Reception mode key, 2, 19  
Redial key, 3, 53, 69  
Redialling, 62, 69  
Reminder function, 89  
Reminder key, 3  
Remote code number, 38  
Remote operations, 38  
Remote Reception Select, 93  
Removing original document, 49  
Repeat key, 3  
Resolution, 50  
Resolution key, 3  
Ringing volume, 21  
Rollers, cleaning, 104

**S**

Scanning glass, cleaning, 104  
Search Dialling, 61, 69  
Sender's name and number, entering, 14  
Speaker key, 4, 20, 52, 68  
Speaker volume, 20  
Speed Dial key, 3, 59, 68  
Speed Dialling, 59, 68  
Start key, 4  
Stop key, 3

**T**

TEL reception mode, 19, 65  
TEL. LINE socket, 8  
TEL. SET socket, 9  
TEL/FAX reception mode, 19, 63  
Tel/Fax Remote Number, 93  
Telephone Number List, 99  
Telephone, using as, 68  
Time Save setting, 96  
Time, setting, 17  
Timer List, 98  
Timer operations, 82  
Transaction Report, 102  
Transaction Report Print Select, 94  
Transfer function, 33

**U**

Up key, 20

**V**

Volume keys, 20



## REMOTE OPERATION CARD

The card below is provided as a quick guide to remote operation. Cut it out and carry it with you when you go out.

### Remote Operation Guide

**SHARP®**

1. Call your fax from a touch-tone telephone, and press  when the outgoing message begins.
2. If you want to listen to a personal box, enter its number.
3. Enter your passcode or remote code:   .
4. Press .
5. After listening to your messages, you can either hang up to save them, or enter one of the commands on the reverse side.

## REMOTE COMMANDS

- **PLAYBACK**

- Play messages . . . . . **7** **#**
- Move backward/repeat . . . . . **2** **#**
- Skip forward . . . . . **5** **#**
- Stop . . . . . **0** **#**
- Play new messages only . . . . . **6** **#**  
(first stop playback)

- **ERASING MESSAGES**

- Erase single message . . . . . **3** **#**
- Erase all messages . . . . . **3** **3** **#**

- **RECORDING A MEMO**

- Start . . . . . **\*** **#**
- End . . . . . **0** **#**

- **RECORDING A NEW OGM**

- Start . . . . . **4** **\***

- **FAX RECEPTION MODES**

- ANS mode . . . . . **8** **1** **#**
- FAX mode . . . . . **8** **2** **#**
- TEL mode . . . . . **8** **3** **#**
- TEL/FAX mode . . . . . **8** **4** **#**

- **TRANSFER FUNCTION**

- Turn on . . . . . **9** **1** **#**  
→ (Box#)  
→ **#**
- Turn off . . . . . **9** **2** **#**
- New transfer number . . . . . **9** **0** **#**  
→ (Tel.#)  
→ **#**
- Record transfer OGM . . . . . **9** **3** **#**
- To quickly disconnect . . . . . **\*** **\***

**SHARP®**

**SHARP CORPORATION OF AUSTRALIA PTY.LTD.**

**A.C.N. 003 039 405**

**1 Huntingwood Drive, Huntingwood, Blacktown, N.S.W., 2148**

**SHARP CORPORATION OF NEW ZEALAND LIMITED.**

**Cnr Mahunga Drive & Hastie Ave. Mangere Bridge, Auckland  
New Zealand**

**SHARP CORPORATION**