

Your Phone

Please check the following carefully. Your phone should come complete with:

- GSM 900/1800/1900 GPRS phone
- Rechargeable Li-ion battery
- AC charger
- Hands free
- CD-ROM
- User guide

Accessories (option)

- Li-ion spare battery (XN-1BT11)
- Cigarette lighter charger (XN-1CL10)
- Car holder (XN-1CH11)
- Data cable (RS232C cable: XN-1DC10)

Some of the above accessories may not be offered by region.

For details, please contact your dealer.

Getting Started

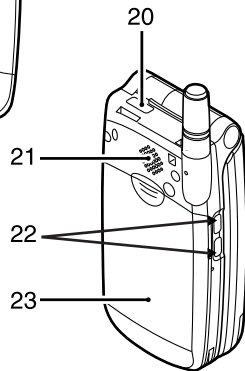
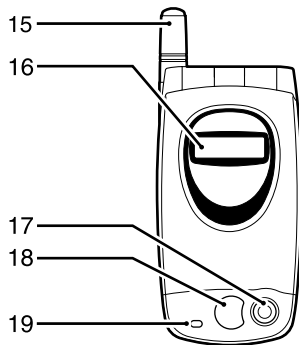
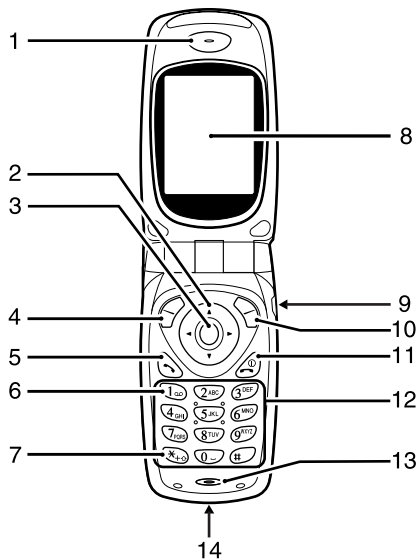

1. Earpiece

2. Navigation Keys (Arrow Keys):

Move the cursor to select menu items, adjust the earpiece volume, etc.

Up/Down arrow keys: Search the Phonebook entries in stand-by mode.

Left arrow key: Adjusts the earpiece volume in stand-by mode.

Right arrow key: Displays the Phonebook menu in stand-by mode.

3. Centre Key:

Displays the Main Menu and executes the functions.

 in this manual indicates this key.

4. Left Soft Key:

Executes the function at the bottom left on the screen.

5. Send Key:

Makes or accepts calls, views the call in stand-by mode.

6. Voice Mail Key:

Used to connect to Voice mail centre. (Depends on the SIM card.)

7. * /Shift Key:

Used to enter * or switch the text mode.

8. Main-Screen Display

9. Hands free Connector

10. Right Soft Key:

Executes the function at the bottom right on the screen.

11. End/Power Key:

Ends a call, turns power on/off.

12. Keypad

13. Microphone

14. External Connector:

Used to connect either the charger or data cable.

15. Aerial

16. Sub-Screen Display

17. Camera

18. Mirror:

For self portraits.

19. LED Indicator

20. Infrared Port:

Sends and receives data via infrared.

21. Speaker

22. Side Keys

Up/Down keys: Move the cursor to select menu items, etc.

23. Battery Cover

Inserting the SIM Card and the Battery

1. Slide off the battery cover.

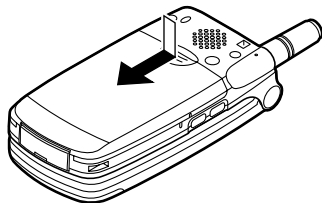

2. Slide the SIM card into the SIM holder.

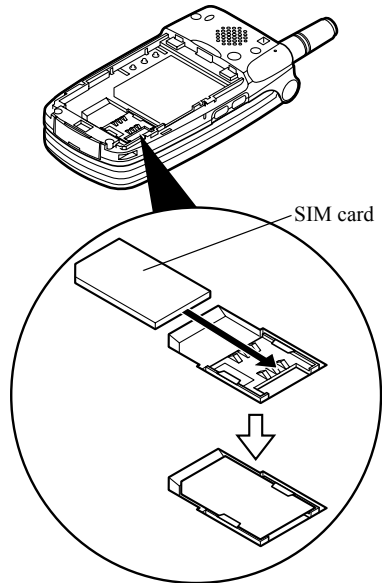

3. Hold the battery so that the metal contacts of the battery are facing down, slide the guides on the top of the battery into the battery slots ①, and then insert it ②.

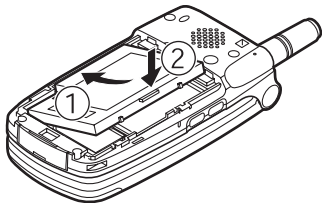

4. Replace the battery cover so that the marks are aligned and slide it as shown.

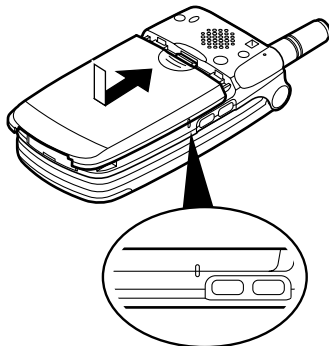

Note

- Make sure that only 3V SIM cards are used.
- Use only the approved battery (XN-1BT11).

Removing the SIM Card and the Battery

1. Make sure to turn off your phone and disconnect charger and other accessories. Slide off the battery cover.

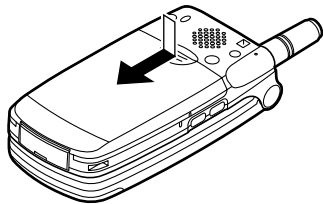

2. Pick up the battery using the protruding edge and remove the battery from the phone.

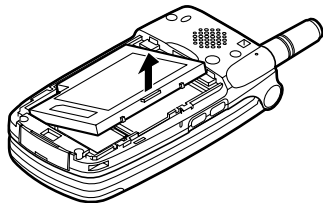

3. Slide the SIM card by pushing the back of the card and remove it from the SIM holder.

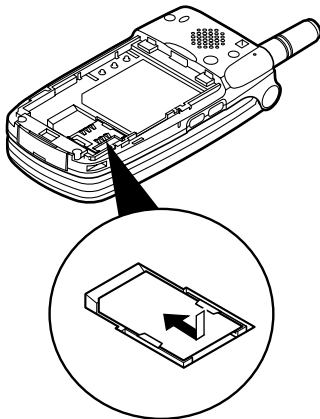

Battery Disposal

The device is supported by a battery. In order to protect the environment, please read the following points concerning battery disposal:

- Take the used battery to your local waste depot, dealer or customer service centre for recycling.
- Do not expose the used battery to an open flame, into water or dispose with the household waste.

Charging the Battery

You must charge the battery for at least 2 hours before using your phone for the first time.

To Charge Using the Charger

1. Connect the charger to the external socket located at the bottom of the phone with the charger's "PUSH TOP" mark facing towards you, and to an AC outlet.

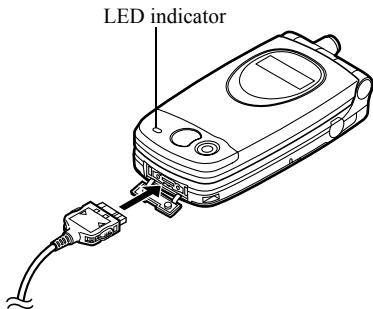

The LED indicator lights in red.
Standard charging time: Approx. 2 hours.

Note

- *Charging time may be longer than above depending on the state of a battery and a surrounding situation. (See "Battery" on page 125.)*

To disconnect the charger

Push and hold the side buttons of the charger, then disconnect the charger from the external socket of the phone.

2. When charging is complete, the LED indicator turns off. Unplug the charger from the AC outlet, then unplug the charger connector from the phone.

Note

- Do not use any non approved charger, this may damage your phone and invalidate any warranty, please see “Battery” on page 125 for details.
- When the phone is charging, the animated battery status icon () will be displayed in the upper right of the screen.

To Charge Using the Cigarette Lighter Charger

The cigarette lighter charger (option) supplies power for charging from the cigarette lighter socket of a car.





Battery Level Indicator

The current battery level is displayed in the upper right hand side of the screen and the Sub-screen.

Low Battery During Use

When the battery is running low, an alarm will sound and the “” will appear on the screen and the Sub-screen.

If you are using your phone and you hear the “low battery” alarm, attach your charger as soon as possible. The phone may not be able to continue normal operation if you continue to use it. The battery may only last five minutes before the phone itself powers down during a call.

Charge Level	Indicators
Full level (greater than 60%)	
Partial level (less than 60%)	
Partial level (less than 30%)	
Low level (less than 10%)	 Charging the battery is recommended.
Empty	 Charge the battery.

Turning Your Phone On and Off

To turn the power on, press and hold  for approximately 2 seconds.

The stand-by screen appears.

To turn the power off, press and hold  for approximately 2 seconds.

Entering the PIN Code

If activated you will be asked to enter a PIN (Personal Identification Number) code after turning on your phone.









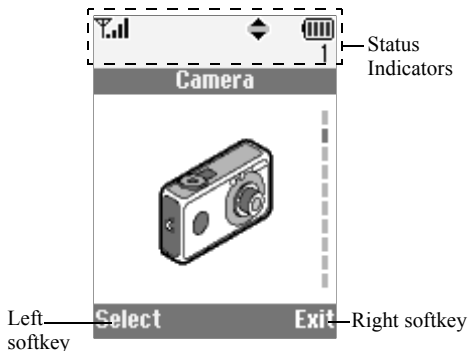











1. Enter your PIN code.
2. Press .





Note

- *If your PIN code is entered incorrectly three times in a row, the SIM card is locked. See “Enabling/Disabling the PIN Code” on page 100.*

Display Indicators





1.  : Indicates the strength of received signal/the service is out of range.
2.  : Appears when in call.
3. **Abc/ABC/abc/123** : Indicates the input mode (Upper case only the first letter of the word mode/Upper case mode/Lower case mode/Numeric mode).
4. **T9** : Appears when the T9 text input mode is activated.
5.  /  /  : Appears when a new SMS, MMS Alert or WAP Alert has arrived.
6.  /  : Appears when viewing secured WAP browser.
7.  /  : Appears when a picture or image/sound is attached to MMS.
8.  : Indicates a Phonebook entry stored in the phone memory.
9.  : Indicates a Phonebook entry stored on the SIM card.
10.  : Indicates the battery level.
11.  : Appears when your phone is roaming outside of your network.
12.  : Appears when your phone is in data communication mode.
13.  : Appears when your phone is in fax communication mode.
14.  : Appears when your phone is GPRS enabled and within range. Flashes during GPRS transmission.
15.  : Appears when Alarm is set.
16.  : Appears when “Diverts” (p. 82) is set to “All Calls”.
17.  : Appears when the data cable is connected to your phone.
18.  : Appears when “Ringer Volume” (p. 64) is set to “Silent”.
19.  : Appears when Vibration alert is set.



20. (No display)/  /  /  /  /  :

Indicates the phone's mode (Normal mode/Meeting mode/Activity mode/Car mode/Silent mode).

21.  : Appears when a voicemail message is stored.

22.  : Appears when up, down, right or left navigation is available.

23.  /  : Appears when "Infrared" is on/during connection.

24.  /  : Appears when the Java™ application is executed/suspended.

Softkey Indicators

To execute the operation indicated, press each corresponding key.

25. Area at the lower left of a screen:

Displays the operation executed by left softkey.







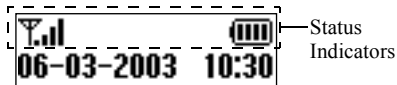

26. Area at the lower right of a screen:



Displays the operation executed by right softkey.

Sub-Screen

Status Indicators



1.  : Indicates the received signal strength.
2.  : Appears when GPRS is within range and can be used.
Flashes during in GPRS communication mode.
3.  : Appears when a new SMS, MMS Alert or WAP Alert has arrived.
4.  : Appears when Alarm is set.
5.  : Indicates the battery level.
6.  /  : Appears when "Infrared" is on/during connection.
7.  : Appears when "Diverts" (p. 82) is set to "All Calls".

8. : Appears when the data cable is connected to your phone.
9. : Appears when “Ringer Volume” (p. 64) is set to “Silent”.

Call Functions

Making a Call

1. Enter the area code and the phone number you wish to dial.

If you enter the wrong number, press  [Clear] to delete the number to the left of the cursor.

2. Press  to dial.



Emergency Calls

1. Enter 112 (international emergency number) using the keypad.
2. Press  to dial.

Note

- *Emergency calls may not be available on all mobile phone networks when certain network services and/or phone features are in use. Contact your network operator for more information.*
- *This Emergency number can normally be used to make an emergency call in any country, with or without a SIM card inserted, if a GSM network is within range.*



International Calls

1. Press and hold  until a “+” (international dialling prefix) sign appears.
2. Enter the country code, followed by the area code and the number.
3. Press  to dial.



Note

- *Enter the area code omitting the first 0 when making international calls, in most cases. (It differs for some countries.)*

Speed Dialling

In the Speed Dial List, up to 9 phone numbers out of the Phonebook can be set. You can call the numbers using the digit keys ( to  and ).







For details on setting the Speed Dial List, see “Speed Dial List” on page 30.

1. Press and hold any of the digit keys ( to  and ).

The phone number stored in the Speed Dial List is displayed, then dialled.



Redialling

You can redial the numbers in the call log list that you may have missed, received or dialled. Each list can contain up to 10 numbers.











1. Press  during stand-by.
2. Press  or  to select a category between “Dialled Numbers”, “Missed Calls” and “Received Calls”.
3. Select the number you wish to call by pressing  or .
4. Press  to redial the call.

Automatic Redialling

This setting allows you to automatically redial the number if the first attempt was unsuccessful.

If you wish to stop redialling, press  or  [End].

To Set the Auto Redial Function

1. Press  to display the Main Menu.
2. Press  or  to select “Settings”, then press .
3. Press  or  to select “Call Settings”, then press .
4. Press  or  to select “Auto Redial”, then press .

5. Select “On” to enable the Auto Redial function or “Off” to disable it, then press .

Note

- When you receive an incoming call, the Auto Redial function will be interrupted.
- Automatic redialling is not available for fax and data calls.

Ending a Call





1. Press  to end the call.

Answering a Call

When an incoming call is detected, the phone rings and the LED indicator flashes green.

1. Open your phone.
2. Press  to answer the call.

or

Press any key except ,  [Reject],  and  when the “Any Key Answer” function is enabled.



Set the Any Key Answer function in the profile in each mode. (p. 68)

Tip

- When the hands free kit is connected to the phone, you can answer calls by pressing the Side keys (up or down).
- If you have subscribed to the Calling Line Identification (CLI) service and the caller's network sends the number, the caller's number will appear on the screen. If the caller's name and number are stored in the Phonebook, the caller's name will appear on the screen.
- If the number is a restricted number, the display shows "Withheld".
- When receiving a call from the person whose picture is registered in the Phonebook, receiving display and the picture are displayed alternately.

Rejecting an Incoming Call

You can reject a call you do not wish to answer.







1. Press  or  [Reject] or press and hold the Side keys (up or down) whilst the phone is ringing.

Incall Menus

Your phone has additional functions available whilst a call is in progress.

Adjusting the Earpiece Volume

You can adjust the earpiece volume during a call.

1. During a call, press .
2. Press  to increase the earpiece volume or press  to decrease the earpiece volume.
Each press of  or  adjusts the earpiece volume by one of 5 levels.
3. Press  [OK].





Tip

- You can also adjust the earpiece volume using the Side keys (Volume up key or Volume down key) during a call.

Putting a Call on Hold

This function allows you to manage two calls at the same time. If you wish to make another call whilst you are talking to someone, you can put the current call on hold to call someone else.

To make another call during a call

1. During a call, press  [Options] to display the Options Menu.
2. Select "Hold", then press .
The current call is put on hold.
To retrieve a call, press  [Options] and select "Retrieve", then press .





3. Enter the phone number you wish to make another call to, then press .

Tip

- You can also make another call by entering the phone number during a call instead of steps 1 and 2. The current call is automatically put on hold.

Call Waiting

This service notifies you of another incoming call whilst you have a call in progress.

1. During a call, press  [Answer] to answer the second call.
The first call is put on hold and you can now talk to the second caller.
2. Press  [Options] and select “Swap” to switch between the two calls.
3. Press  [Options] and select “End Call”, then press  to end the current call and return to the held call.

Note

- You need to set “Call Waiting” to “On” if you use Call Waiting service (p. 89).
- Call Waiting service may not be available on all networks. Contact your network operator for more information.









- If you do not wish to answer the second call, press  [Reject] in step 1. The call log of the second call will be saved as a missed call.

Conference Call

Conference call is a call with more than 2 participants. You may include up to 5 participants in a conference call.

Making a Conference Call













To make a conference call, you must have one active call and one held call.

1. Press  [Options] to display the Options Menu.
2. Press  or  to select “Multiparty”, then press .
3. Press  or  to select “Join All”, then press .
4. Press  to end the conference call.

Note







- Conference call service may not be available on all networks. Contact your network operator for more information.

Adding New Participants to the Conference Call

1. Press  [Options] to display the Options Menu.
2. Press  or  to select “Dial”, then press .
3. Enter the number you wish to include in the conference call.
4. Press  to dial.
5. Press  [Options] to display the Options Menu.
6. Press  or  to select “Multiparty”, then press .
7. Press  or  to select “Join All”, then press  to join the conference call.















If you wish to add other participants, repeat steps 1 to 7.

To End the Call with a Conference Call Participant

1. During a conference call, select the person who you wish to disconnect the call by pressing  or .
2. Press  [Options] to display the Options Menu.
3. Press  or  to select “End Call”, then press .

To Have a Private Conversation with one of the participants

If you wish to have a private conversation with one of the participants, you may select the participant from the conference list and put the other participants on hold.

1. During the conference call, select the person that you wish to talk to by pressing  or .
2. Press  [Options] to display the Options Menu.
3. Press  or  to select “Multiparty”, then press .
4. Press  or  to select “Private”, then press .
5. Once you have finished the private conversation, press  [Options] and select “Multiparty”, then press .
6. Press  or  to select “Join All”, then press  to return to the conference call.

Muting the Microphone

1. During a call, press  [Mute] to mute the microphone.

To unmute the microphone, press  [Unmute].

Phonebook

You can store the phone numbers and E-mail addresses of your friends, family and colleagues in the Phonebook.

Group name (p. 26)

You can classify the phone numbers and names stored in the Phonebook, such as “Family” and “Business”.

Entering Characters

When entering characters to create Phonebook entries, SMS or MMS, etc., press the corresponding keys.





Table of Characters









Pressing each key scrolls characters in the following order.



Note

- Depending on the type of the data entry screen, usable characters are limited.

Normal Mode

Key	Upper Case Characters	Lower Case Characters	Numeric
	. (full-stop) , (comma) - (hyphen) ? ! ' (apostrophe) @ _ () / " : 1		1
	ABC2ĀĂÄÅĀĀÆÇ	abc2āăääåāāæç	2
	DEF3ÉÊËËË	def3éêëëë	3
	GHI4ÍÎÏÏ	ghi4íîïïï	4

Key	Upper Case Characters	Lower Case Characters	Numeric
	JKL5	jkl5	5
	MNO6ÕÓÔÕÕÖØÑ	mno6õóôõõöøñ	6
	PQRS7	pqrs7ß	7
	TUV8ÚÛÜÛÛÛ	tuv8úúúúú	8
	WXYZ9ÝÞ	wxyz9ýþ	9
	(space)+ = < > € £ \$ ¥ % & 0		0
	*+P?		
	. , ? ! : ; - + # * @ ' " () _ & € £ \$ % / ~ < > § = \ ¢ ¥ ÷ ÷ ^ [] { } × ÷ φ Γ Λ Ω Π Ψ Σ Θ Ξ ϰ (space)		

 - : Press and hold to enter 0 - 9 numbers.



: Press and hold to shift to Sentence mode, Capital letter, Small letter, Numeric.

: Press and hold to shift between Normal and T9 mode.

Note

- When you send an SMS with Optimisation set “On” in SMS Settings, characters with an accent will be sent as characters with no accent.
For details, see “Optimisation” on page 115.



Changing the Input Mode



To change the input mode, press  for approximately 2 seconds.

T9 Text Input

T9 text input method is a shortcut to enter text easily and quickly.

1. Press and hold  until “**T9**” is displayed.
2. Press each key once for any letter you require on that key.

To enter the word “How”, press   .

3. Press  or  until the correct word is shown if the character combination, that was initially displayed, is not correct.
4. Press  to select the word.

Note

- If the correct word is not shown in step 3, enter the correct word again after switching to the normal input mode.

Tip

- If you press  instead of step 4, a space is inserted next to the selected word.







Symbols and Punctuation

To enter symbols or punctuation, press .

Using Text Template

You can use the sentences registered in My Text Templates when entering characters.

For details on creating the text template, see “Adding Phrases to My Text Templates” on page 46.

1. Press  [Options] to display the Options Menu.
2. Press  or  to select “Insert Template”, then press .
3. Select a desired text template by pressing  or , then press .

The selected text template will be inserted.





Creating a New Entry







You can choose either the phone (up to 500) or SIM card memory locations to store the new entry.

The amount of phone numbers that you can store to the SIM card is dependant on its capacity. Contact your network operator for SIM details.









Phonebook Memories





Select the location for storing the Phonebook memory before storing a new entry.

1. Press  to display the Phonebook menu.
2. Press  or  to select “Settings”, then press .

3. Press  or  to select “Save Nos. to”, then press .
4. Select “SIM Card” to store the entry on the SIM memory or “Phone Memory” by pressing  or , then press .
When selecting “Choice”, you can choose SIM card or phone memory every time you store a new Phonebook entry.

Storing Names and Numbers

1. Press  to display the Phonebook menu.
2. Press  or  to select “Add New Name”, then press .
3. If you select “Choice” in step 4 in “Phonebook Memories”;
Select “SIM Card” or “Phone Memory” by pressing  or , then press .
The name entry prompt appears.
4. Enter a name, then press .
For details on entering characters, see “Entering Characters” on page 24.
The phone number prompt appears.
5. Enter the phone number, then press .
Up to 40 digits can be entered.

6. Select a desired number type by pressing  or , then press .
7. Press  [Save].

You can divide the phone numbers of the Phonebook into groups. You can also register E-mail address, personal data, and picture/image data. (See “Storing Optional Data” for details.)







Storing Optional Data

You can store optional data after entering a phone number. (See “Storing Names and Numbers” for details.)





Note

- E-mail address, personal data, and picture/image data cannot be stored on the SIM card.





Selecting Group Name

1. Press  or  to highlight the right side of “”, then press .
2. Select a desired group name by pressing  or , then press .
You can set to display the available group names when you store/edit the Phonebook, see “View Groups” on page 29.

Entering E-mail Address

3. Press  or  to highlight the right side of “”, then press .
4. Enter the E-mail address, then press .
Up to 60 characters can be entered.





Entering Personal Data







5. Press  or  to highlight the right side of “”, then press .
6. Enter the personal data, then .
Up to 60 characters can be entered.

Storing Picture/Image Data

You may store a picture/image for use with the Phonebook.

When you receive a call from a person with a Phonebook entry which also has a linked picture/image, when the person calls, the linked picture/image will be displayed.





7. Press  or  to highlight the right side of “”, then press .
8. Select the desired picture/image, then press .
The selected picture/image will appear on the screen.

9. Specify the range for displaying the picture/image by pressing , ,  or , then press .
10. Press  [Save].

Note

- The stored picture/image is automatically saved under the “in Phonebook” section of the Saved Pictures.
- The picture/image cannot be deleted in the Saved Pictures. Remove the picture/image data from the Phonebook.

Adding the Phone Number from the Call Log Entries

1. Display the call log entry you wish to store (p. 77).
2. Press .
3. Press  or  to select “Save to Phonebook”, then press .
4. Follow the procedure from step 3 in “Storing Names and Numbers” on page 26.









Storing after Inputting a Phone Number

1. Enter the phone number, then press  [Save].
2. Follow the procedure from steps 3 to 7 in “Storing Names and Numbers” on page 26.

Finding a Name and Number

Two methods of searching through the Phonebook are available:





Search by Name

1. Press  to display the Phonebook menu.
2. Select “View Names”, then press .
3. Enter a name or the first character(s) of the name. Matched results will be displayed alphabetically. If there is no entry in the Phonebook that satisfies the exact search criteria, the name that is nearest alphabetically matching will be displayed.
4. Scroll through list by pressing  or  to select the desired name, then press  [Select].
The detailed screen of the Phonebook appears.
5. Press .
6. Press  or  to select the desired phone number, then press  to dial.

Tip







- If you press  and select “Search” after step 2, you can also search the name and number.
- You can also dial the desired phone number by pressing the digit key corresponding to the list number instead of step 6.



Search in Alphabetical Order

1. Press  or  whilst in stand-by to open the Phonebook.
2. Scroll the list by pressing  or  to find the desired name.
3. If you wish to do a name search, perform steps 3 and 4 in “Search by Name”.







Editing Phonebook Entries

You can edit Phonebook entries.

1. Search for the desired Phonebook entry.
For details on searching through Phonebook entries, see “Finding a Name and Number”.
2. Press .
3. Press  or  to select “Edit”, then press .
4. Select an entry you wish to change by pressing  or , then press  [Edit].





5. Edit entry as required.
6. Press .
If you wish to edit another item, repeat steps 4 to 6.
7. Press  [Save] to save the change(s).



Deleting Phonebook Entries

1. Search for the desired Phonebook entries.
For details on searching through Phonebook entries, see “Finding a Name and Number” on page 28.
2. Press .
3. Press  or  to select “Delete”, then press .
4. Select “Yes”, then press .
The selected entry will be deleted.
To cancel deletion, select “No” at step 4, then press .

Checking Your Own Numbers

You can check and edit your own voice, data and fax phone numbers in the Phonebook.



1. Press  to display the Phonebook menu.
2. Press  or  to select “Own Numbers”, then press .

3. Press  or  to select the phone number you wish to check from either “Voice”, “Data” or “Fax”, then press .

Note





- “Data” or “Fax” may not be displayed depending on SIM card.



Editing Your Phone Numbers

1. Perform steps 1 to 3 in “Checking Your Own Numbers”.
2. Press .
3. Press  [Clear] to erase the phone number and enter a new phone number.
4. Press  to save the phone number.

View Groups







You can set the available group names when you store/edit the Phonebook.

1. Press  to display the Phonebook menu.
2. Press  or  to select “Settings”, then press .
3. Select “View Groups”, then press .

4. Select a desired group name by pressing .
“” indicates that the group has been selected.
To cancel the selected group, press  again.
The checkbox becomes blank again.

Memory Status

This function helps you to check the number of entries stored in the Phonebook.

1. Press  to display the Phonebook menu.
2. Press  or  to select “Settings”, then press .
3. Press  or  to select “Memory Status”, then press .

You can check the following memory status.

“SIM Card : xxx/xxx”

“Speed Dial : xx/xx”

“Phone : xxx/500”

Note









- The number of locations available on the SIM is dependant on its capacity.

Speed Dial List







You can set a maximum of 9 phone numbers to the Speed Dial List.

Use the phonebook entries on the SIM card.

Adding Phonebook entries to the Speed Dial List

1. Search for the desired Phonebook entries.
For details on searching through Phonebook entries, see steps 1 to 4 in “Search by Name” on page 28.
2. Press  or  to select the phone number.
3. Press .
4. Press  or  to select “Add to Speed”, then press .
5. Select the number you wish to add by pressing  or , then press .

Viewing the Speed Dial List







1. Press  to display the Phonebook menu.
2. Press  or  to select “Settings”, then press .
3. Press  or  to select “Speed Dial List”, then press .

The stored names and phone numbers in the selected entry are displayed in order.

Sending Messages



1. Search for the desired Phonebook entries.



For details on searching through Phonebook entries, see steps 1 to 4 in “Search by Name” on page 28.



2. Press  or  to highlight the right side of “1:”, “2:” or “3:”, then press 

or

Press  or  to highlight the right side of “:”, then press .

3. Press  or  to select “Send Message”, then press .





If you highlight the right side of “1:”, “2:” or “3:” in step 2:

4. Press  or  to select “MMS” or “SMS”, then press .
5. Enter your message.

For details on creating a message, see “Creating a New MMS” on page 107 or “Creating a New SMS” on page 115.

Using the Menu

Using the Main Menu



1. Press  during stand-by mode.
2. Press  or  to navigate to required location.
3. Press  or  to access function.

To Select Another Item within the Main Menu

To return to the previous screen after selecting a function from the Main Menu or Sub Menu, press .

Every time you press , the screen goes back one by one.

Operation Guidance

Your phone uses softkeys to help you to navigate the phone ( and ). These keys change usage depending on the situation. The function of each softkey at any given time is highlighted at the bottom left and bottom right of the screen.

Shortcut Keys

When pressing several key combinations during stand-by mode, you can shortcut to the specified menus.

To access the desired menu directly, press  and digit keys for the menu's corresponding number during stand-by mode. See the following table as reference.



Example: To access “Language” Sub Menu using shortcut keys

Press    .

Note

- The shortcut keys work for the first three menu levels only.

Side Keys

The Side keys (up or down) function the same as pressing  or .

List of Menu Functions

Menu No./ Main Menu	Menu No./ Sub Menu1
1 Camera	
2 My Phone	1 My Java™ Games 2 My Pictures 3 My Sounds 4 My Bookmarks 5 My Text Templates 6 Memory Status
3 Fun & Games	1 Java™ Games 2 Other Games 3 Melody Editor 4 Tone Editor
4 Profiles	1 Normal 2 Meeting 3 Activity 4 Car 5 Silent
5 Organiser	1 Calculator 2 Calendar 3 Clock & Alarm 4 Voice Memo 5 Help List
6 Call Manager	1 Phonebook 2 Call Register 3 Diverts

Menu No./ Main Menu	Menu No./ Sub Menu1
7 Settings	1 Phone Settings 2 Call Settings 3 Network Settings 4 Internet Settings 5 Infrared 6 Security 7 Master Reset
8 Vodafone live!	1 Vodafone live! 2 New 3 Chat 4 Games 5 Find & Seek 6 News 7 Sport 8 Shopping 9 Search
9 Info-Service*	
0 Messages	1 MMS 2 SMS 3 Cell Broadcast 4 Cell Info 5 Vodafone Messenger 6 Vodafone Mail

* Depends on the contents of SIM card.





Camera (M 1)

Your phone incorporates an integrated digital camera. This allows you to take and send pictures wherever you are.

Taking Pictures



Put the phone into the camera mode to take a picture.

You can send the pictures registered in the Saved Pictures with your message.

1. Press and hold  for approximately 2 seconds whilst stand-by.
The phone switches to the camera mode.
The camera view can be seen through the “on screen” viewer.
2. Press  or the Side keys (up or down) to take the picture.
The shutter sound occurs and the static image of the taken picture is displayed.
3. Press  [Save].
“Save to My Phone” is displayed, then the picture is registered.
If you send a picture by MMS after taking the picture, press  in step 3.
The camera returns to step 1 repeat process as desired.

4. Press  to return to stand-by.

Tip

- To leave Camera Mode without registering the taken picture after step 2 in “Taking Pictures”: Press  and select “Yes”, then press .
- To take a picture of yourself, press  or the Side keys (up or down) whilst checking the image reflected on the mirror on the back of the phone. Place/Hold the phone at least 40 cm away from yourself.

Using the Zoom Function







Press  [Zoom] to magnify the photographic subject.

Press  [Wide] to restore the original magnification.







Note

- When “Select Picture Size” is set to “Large”, you cannot use the zoom function.

To select the picture size

1. Press  [Options] before step 2 in “Taking Pictures” to display the Options Menu.
2. Press  or  to select “Select Picture Size”, then press .
3. Select the picture size by pressing  or , then press .

To select the mode

1. Press  [Options] before step 2 in “Taking Pictures” on page 34 to display the Options Menu.
2. Press  or  to select “Select Mode”, then press .
3. Select the mode by pressing  or , then press .

Note

- Vertical stripes may be reflected to a picture by light source. Change the mode in this case.

Retaking Pictures

After steps 1 and 2 in “Taking Pictures” on page 34, press  [Back].

Further shooting is available.

Note

- The Digital Camera Uses a C-MOS Sensor. Although this camera has been manufactured to the highest specification, some pictures may still appear too bright or too dark.
- If the phone has been left in a warm place for a long time before taking or registering a picture, the picture quality may be poor.

In the Case of No Available Memory

When the number of pictures that can be taken becomes 5 or less, or when the remaining capacity becomes 27.5 Kbytes (when “Medium” is selected as the picture size) or less, “” will appear on screen. The screen returns to step 2 in “Taking Pictures” on page 34. The number of pictures that can be taken is displayed in the upper left of the screen. (The number of pictures that can be taken is approximate.)

When the number of pictures that can be taken becomes 0, and when you try to take a picture again, “Can not take a picture. Maximum Capacity” is displayed.

Meanings of Indicators in Camera Mode

Delay timer indicator (p. 36)



: Whilst the timer setting is on.

Picture brightness indicators (p. 36)

 +2: Bright

 +1: ↓

 ±0: Normal

 -1: ↓

 -2: Dark

Picture size indicators (p. 34)



Large: 288 × 352 dots





Medium (default): 120 × 160 dots





Small: 60 × 80 dots

Mode indicator (p. 35)

- : Mode 1
- : Mode 2

Making Adjustments According to Lighting Conditions







Adjusting the Brightness of the Picture

Adjust the brightness of the picture by pressing  or .

Once the phone has returned to the stand-by screen the brightness settings return to default.

Viewing the Taken Pictures

The taken pictures can be viewed in the Saved Pictures.

1. In camera mode, press  [Options].
The Options Menu is displayed.
2. Select “Existing Pictures”, then press .
The list of Saved Pictures is displayed.
3. Select the file name you wish to view by pressing  or , then press .
The selected picture is displayed.
4. Once you have finished, press  [Back] to return to the list.

Tip









- Your pictures are given file names which show the time and date when the picture was taken.

Example:





The file name “13-05-03_12-34-56” is displayed for the picture taken at 12:34:56 of 13th May 2003. The file names of your pictures can be changed (p. 41).

Using the Timer









Taking a Picture with the Timer

1. In camera mode, press  [Options].
The Options Menu is displayed.
2. Press  or  to select “Delay Timer”, then press .
3. Press  or  to select “On”, then press .
“” appears on the screen and the phone returns to camera mode.
4. Press  to take the picture.
Delay timer begins.
10 seconds after the timer sound occurs, the camera takes a picture, and sounds a tone.

Note

- Whilst the delay timer is operating, the LED indicator and the icon flash.
- If  is pressed whilst the delay timer is operating, the picture is taken instantly.
- If there is an incoming call or alarm functioning, or  is pressed, whilst the delay timer is operating, the camera operation is cancelled. In this case, the timer setting is cancelled.
- The zooming function with  [Zoom] / [Wide], or the adjustment of brightness of the picture with  or , is unavailable whilst the delay timer is operating.

Canceling the Delay Timer

1. Press  [Options] whilst the delay timer setting is on.
The Options Menu is displayed.
2. Press  or  to select “Delay Timer”, then press .
3. Press  or  to select “Off”, then press .
“” goes off.

Sending Pictures

See “Sending Messages” on page 42 for instructions.

Deleting Pictures

See “Deleting Pictures/Images” on page 42 for instructions.

My Phone

My Phone contains several types of picture/image and sound data along with Java™ applications which can be controlled collectively. Also included in My Phone are frequently used text message phrases and accessed WAP pages (addresses) which you can use and edit.

Java™

Using Java™ Applications

Various kinds of Vodafone specific Java™ applications can be used in this phone.

To use Java™ applications, download the Java™ applications via the mobile Internet.

Some Java™ applications offer the ability to connect to a network either within a game or network based application.

Note

- *Java™ applications may be both localised (no connectivity) and network based (using the mobile Internet to update information/play games). The network may charge you more for using network-based applications. Please contact your service provider for more information.*

Downloading Java™ Applications

Confirmation screen









Before downloading the Java™ application you will be asked to confirm what you are about to receive.

After checking the information on the confirmation screen, the Java™ application can be downloaded.



Note

- *User authentication might be required before downloading the application on some information screens.*

Download

1. Press  to display the Main Menu.
 2. Press  or  to select “My Phone”, then press .
 3. Select “My Java™ Games”, then press .
 4. Press  or  to select “Download More”, then press .
- The Java™ application download site is displayed.
5. Select the Java™ application you wish to download.

After a WAP browser is displayed variously, the confirmation screen will appear after a whilst.

- Press  [Get].
Downloading starts.
- Press  [OK] even if it carries out complete.

My Java™ Games (M 2-1)







Along with the preloaded Java™ application, downloaded applications are stored in the Saved Games.

Your phone has one preloaded Java™ application.



Note

- The phone can store approximately 700Kbytes of information across the Saved Games, Saved Pictures and Saved Sounds. The Saved Games can store up to 50 applications.





Executing Java™ Applications

- Press  to display the Main Menu.
- Press  or  to select “My Phone”, then press .
- Select “My Java™ Games”, then press .
- Select “Saved Games”, then press .







The list of Saved Games is displayed.
The downloaded Java™ applications are sequentially displayed from the latest one.

- Select the title of the Java™ application you wish to execute by pressing  or , then press . The selected Java™ application is executed. When using network connection type Java™ applications, connection to the network can be selected.

To end the Java™ application





- Press .
- Press  or  to select “End”, then press . The screen returns to stand-by screen.

To suspend the Java™ application







- Press .
- Press  or  to select “Suspend”, then press . To resume the Java™ application, press  during stand-by screen and select “Resume”, then press .

Checking the Information of the Java™ Application

- Perform steps 1 to 4 in “Executing Java™ Applications”.
- Select the Java™ application you wish to check, then press  [Options]. The Options Menu is displayed.

3. Select “File Information”, then press .
The detailed information screen is displayed.
4. Press  or  to scroll through the screen.
5. When you have finished, press  [Back] twice.
The screen returns to the Saved Games.

Deleting Java™ Applications









1. Perform steps 1 to 4 in “Executing Java™ Applications” on page 39.
2. Select the Java™ application you wish to delete, then press  [Options].
The Options Menu is displayed.
3. Press  or  to select “Delete”, then press .
4. Select “Yes”, then press .
The selected application is deleted.
To cancel deletion, select “No” at step 4, then press .

Note

- You cannot delete preloaded Java™ applications.







My Pictures (M 2-2)

Pictures that are taken by a digital camera or images that are downloaded from mobile Internet sites can be managed.











- : This is the folder where the pictures/images registered in the Phonebook are saved.
- : Images in PNG format
- : Pictures/Images in JPEG format
- : e-Animation file (NEVA)
- : Images in GIF format
- : Images in BMP format
- : Images in WBMP format
- : Images in WPNG format

The date and time when the photo was taken is displayed as a file name for the picture.

Downloading Picture/Image File

1. Press .
2. Press  or  to select “My Phone”, then press .
3. Select “My Pictures”, then press .
4. Select “Download More”, then press .
The picture/image file download site is displayed.

Viewing Pictures/Images

1. Press  to display the Main Menu.
2. Press  or  to select “My Phone”, then press .
3. Select “My Pictures”, then press .
4. Select “Saved Pictures”, then press .
The list of Saved Pictures is displayed.
5. Select the file name you wish to view by pressing  or , then press .
The selected picture/image is displayed.
6. Once you have confirmed the picture/image, press  [Back] to return to the Saved Pictures.







Checking the Picture/Image Data

Select the desired data in step 5 in “Viewing Pictures/Images”, then select “File Information” after pressing  [Options] to display the Options Menu.

The file type and size of the selected picture/image are displayed. Whether the picture/image can be copied, forwarded, or saved is also displayed.

To return to the Saved Pictures, press  [Back] twice.

Changing the File Name

1. Perform steps 1 to 4 in “Viewing Pictures/Images”.
2. Select the file name you wish to change by pressing  or , then press  [Options].
The Options Menu is displayed.
3. Select “Rename”, then press .
4. Enter a new file name.
To correct the last character, press  [Clear] briefly.
Press and hold  [Clear] to clear all characters.
5. Press .

Note

















- *Following characters cannot be used for a file name: /, \, :, *, ?, ", <, > and . (full-stop).*

Adjusting the Size of the Picture/Image

The pictures/images that are registered in the Saved Pictures can be adjusted for use as a wallpaper during stand-by or as an incoming call display.

When the picture/image size is modified, the data size is updated.







1. Perform steps 1 to 4 in “Viewing Pictures/Images”.

2. Select the file name you wish to adjust by pressing  or , then press  [Options].
The Options Menu is displayed.
3. Press  or  to select “Adjust Size”, then press .
4. Select the picture/image size you wish to change by pressing  or , then press .
5. Specify the range for displaying the picture/image by pressing , ,  or  then press .
6. Press .
To cancel registration, press  [Back] at any time before step 6.

Note

- “Adjust Size” may not be available depending on the picture/image original and copyright issued.

Sending Messages

1. Perform steps 1 to 4 in “Viewing Pictures/Images” on page 41.
2. Select the file name you wish to send by pressing  or , then press  [Options].
The Options Menu is displayed.
3. Press  or  to select “Send Message”, then press .









4. Enter your message.

For details on creating a message, see “Creating a New MMS” on page 107.

Note





- Pictures/images with a red icon cannot be sent attached to a message.

Deleting Pictures/Images

1. Perform steps 1 to 4 in “Viewing Pictures/Images” on page 41.
2. Select the file name you wish to delete by pressing  or , then press  [Options].
The Options Menu is displayed.
3. Press  or  to select “Delete”, then press .
4. Select “Yes”, then press .
The selected picture/image is deleted.
To cancel deletion, select “No” at step 4, then press .

My Sounds (M 2-3)







The ring tones instead created by Melody Editor and the WAVE data recorded by Voice Memo are managed in the Saved Sounds. Default ring tones are not contained.

- : Sound file in SMAF format
- : Original ringing tone (composed in Melody Editor)
- : Sound file in Standard MIDI format
- : Sound file in i Melody format
- : Sound file in WAVE format











Note

- *SMAF (Synthetic music Mobile Application Format) is a format of music data for mobile phones.*

Downloading Sound Files

1. Press  to display the Main Menu.
2. Press  or  to select “My Phone”, then press .
3. Select “My Sounds”, then press .
4. Select “Download More”, then press .
The sound file downloaded site is displayed.

Playing Back Sounds

1. Press  to display the Main Menu.
2. Press  or  to select “My Phone”, then press .
3. Select “My Sounds”, then press .
4. Select “Saved Sounds”, then press .
The Saved Sounds is displayed.
5. Select the sound you wish to play back by pressing  or , then press .
The selected sound is played.
To stop playing, press  [Stop].







Checking the Sound Data

Select the desired sound as in step 5 in “Playing Back Sounds”, then select “File Information” after pressing  [Options].

The file type and size of the selected sound are displayed. Whether the sound can be copied, forwarded or saved is also displayed.

To return to the Saved Sounds, press  [Back] twice.

Changing the File Name

1. Perform steps 1 to 4 in “Playing Back Sounds” on page 43.
2. Select the file name you wish to change by pressing  or , then press  [Options].
The Options Menu is displayed.
3. Select “Rename”, then press .
4. Enter a new file name.
To delete the last character, press  [Clear] briefly.
Press and hold  [Clear] to clear all characters.
5. Press .







Note

- *Following characters cannot be used for a file name: /, \, :, *, ?, ", <, > and . (full-stop).*

Tip

- *When “Data Edit” is displayed in the menu in step 2, you are able to edit the sound (p. 57). Once you have completed editing the newly saved file overwrites the old file. This new file then becomes the original ring tone.*







Setting the Tone and Strength

1. Perform steps 1 to 4 in “Playing Back Sounds” on page 43.
 2. Select the file name you wish to edit by pressing  or , then press  [Options].
The Options Menu is displayed.
 3. Press  or  to select “Tone Set” or “Strength Set”, then press .
- For full details, see pages 55 to 57.



Note

- *If “Tone Set” and “Strength Set” are not displayed in the menu in step 2, you cannot change the settings.*

Sending Messages

1. Perform steps 1 to 4 in “Playing Back Sounds” on page 43.
2. Select the file name you wish to send by pressing  or , then press  [Options].
The Options Menu is displayed.
3. Press  or  to select “Send Message”, then press .

If you select your original ringing tone in step 2;

4. Press  or  to select the file format “SMAF”, “MIDI” or “i Melody”, then press .









5. Enter your message.

For details on creating a message, see “Creating a New MMS” on page 107.

Note

- Sounds with a red icon cannot be sent attached to a message.
- Only the first part of the data will be converted if you select “i Melody” in step 4.















Deleting Sounds

1. Perform steps 1 to 4 in “Playing Back Sounds” on page 43.
2. Select the file name you wish to delete by pressing  or , then press  [Options].
The Options Menu is displayed.
3. Press  or  to select “Delete”, then press .
4. Select “Yes”, then press .
The selected sound has been deleted.
To cancel deletion, select “No” at step 4, then press .



My Bookmarks (M 2-4)

You can store desired (or frequently used) pages (addresses) in My Bookmarks. It can save your time in accessing WAP pages sites.









Adding a Bookmark

1. Press  to display the Main Menu.
2. Press  or  to select “My Phone”, then press .
3. Press  or  to select “My Bookmarks”, then press .
The list of My Bookmarks is displayed.
4. Press  [Options] to display the Options Menu.
When you add a bookmark for the first time, press  [Add] instead, then skip to step 6.
5. Press  or  to select “Add”, then press .
6. Enter the bookmark title, then press .
7. Enter the URL address, then press .











Accessing Bookmarked Pages

1. Perform steps 1 to 3 in “Adding a Bookmark”.
2. Select a bookmarked page you wish to access by pressing  or , then press .

Editing Bookmarks

1. Perform steps 1 to 3 in “Adding a Bookmark” on page 45.
2. Select the desired bookmark to edit by pressing  or , then press  [Options].
The Options Menu is displayed.
3. Press  or  to select “Edit”, then press .
4. Edit the bookmark title.
For details on entering characters, see “Entering Characters” on page 24.
5. Press .
6. Edit the URL address.
7. Press .

Deleting Bookmarks

1. Perform steps 1 to 3 in “Adding a Bookmark” on page 45.
2. Select the desired bookmark to delete by pressing  or , then press  [Options].
The Options Menu is displayed.
3. Press  or  to select “Delete”, then press .
4. Press  or  to select “Yes”, then press .
- The selected bookmark has been deleted. To cancel deletion, select “No” at step 4, then press .











My Text Templates (M 2-5)

You can register up to 20 text templates for use in SMS and MMS.

You can input messages or others more easily by registering frequently used text.









128 characters may be registered in any text template.

Adding Phrases to My Text Templates







1. Press  to display the Main Menu.
2. Press  or  to select “My Phone”, then press .
3. Press  or  to select “My Text Templates”, then press .
- The list of My Text Templates is displayed.
4. Select the number you wish to register by pressing  or , then press .
5. Enter the text, then press .
- For details on entering characters, see “Entering Characters” on page 24.

Editing Text Templates







1. Perform steps 1 to 3 in “Adding Phrases to My Text Templates”.



2. Select the number you wish to edit by pressing  or , then press .
3. Press  or  to select “Edit”, then press .
4. Enter new text.
To correct the last character, press  [Clear] briefly.
Press and hold  [Clear] to clear all characters.
5. Press .

Viewing Text Templates

1. Perform steps 1 to 3 in “Adding Phrases to My Text Templates” on page 46.
2. Select the number you wish to view by pressing  or , then press .
3. Press  or  to select “Confirm”, then press .
The selected text template is displayed.
4. After confirmation, press  [Back] to return to template list.







Deleting Text Templates

1. Perform steps 1 to 3 in “Adding Phrases to My Text Templates” on page 46.
2. Select the text template you wish to delete by pressing  or , then press .
3. Press  or  to select “Delete”, then press .

4. Select “Yes”, then press .
The selected text template is deleted.
To cancel deletion, select “No” at step 4, then press .

Memory Status (M 2-6)

This function helps you to check the memory status of the Galleries.

1. Press  to display the Main Menu.
2. Press  or  to select “My Phone”, then press .
3. Press  or  to select “Memory Status”, then press .













Fun & Games

Java™ Games



Settings (M 3-1-2)



Operation Priority

You can set the method of incoming phone calls and alarm whilst a Java™ application is operated.

1. Press  to display the Main Menu.
2. Press  or  to select “Fun & Games”, then press .
3. Select “Java™ Games”, then press .
4. Press  or  to select “Settings”, then press .
5. Select “Operation Priority”, then press .
6. Select the option you wish to set by pressing  or , then press .







The options available are:

- “Incoming Call”
 - “Alarm”
7. Press  or  to select methods, then press .

- “Priority”:
The Java™ application is suspended automatically, and you can receive the call or alarm will sound. After finishing the call or alarm, the suspend icon () is displayed and you will know there is a suspended Java™ application.
- “Notice”:
The marquee (character scrolls) is displayed on the first line on the screen whilst the Java™ application continues. If you press , the Java™ application is suspended, and you can receive the call. After finishing the call, the suspend icon () is displayed and you will know there is a suspended Java™ application.

Volume

You can set the sound volume of the Java™ application such as sound effect to one of the five levels or silent. When “Ringer Volume” (p. 64) is set to “Silent”, the set up has a priority.

1. Perform steps 1 to 4 in “Operation Priority”.
2. Press  or  to select “Sound Volume”, then press .
The current volume level is displayed.
3. Press  to increase the volume or press  to decrease the volume and then press .

Backlight

You can select the method of backlight during the operation of the Java™ application from the following three types:

- “On”: Lit whilst the Java™ application is operated.
- “Off”: Unlit whilst the Java™ application is operated even if a key is pressed.
- “Normal Settings”: Works with the main backlight setting. (p. 85)

1. Perform steps 1 to 4 in “Operation Priority” on page 48.
2. Press ▲ or ▼ to select “Backlight”, then press ●.
3. Select “On/Off”, then press ●.
4. Select “On”, “Off” or “Normal Settings” by pressing ▲ or ▼, then press ●.

To Set the Blinking Operation

You can set whether the blinking operation, which is embedded in Java™ application, is enabled.

1. Perform steps 1 and 2 in “Backlight”.
2. Press ▲ or ▼ to select “Blink”, then press ●.

3. Select “On” or “Off” by pressing ▲ or ▼, then press ●.

Vibration

When vibrator is set in the Java™ application, you can choose whether the operation is enabled or disabled.

When a SMAF file is specified in the Java™ application, you can operate the vibrator set in the SMAF file.

Note

- *SMAF (Synthetic music Mobile Application Format) is a format of music data for mobile phones.*

1. Perform steps 1 to 4 in “Operation Priority” on page 48.
2. Press ▲ or ▼ to select “Vibration”, then press ●.
3. Press ▲ or ▼ to select “Enable”, “Disable” or “Link to Sound”, then press ●.

When you set “Link to Sound”, the Java™ application is synchronised with the vibrator.

Online Services

You can adjust the display settings of the confirmation screen when a Java™ application attempts to connect to the network.

1. Perform steps 1 to 4 in “Operation Priority” on page 48.
2. Press ▲ or ▼ to select “Online Services”, then press ●.
3. Press ▲ or ▼ to select “Yes”, then press ●.
To cancel confirmation, select “No”, then press ●.

Java™ Reset

To reset all settings in a Java™ application

1. Perform steps 1 to 4 in “Operation Priority” on page 48.
2. Press ▲ or ▼ to select “Java™ Reset”, then press ●.
3. Enter your handset code, then press ●.
If you enter a wrong handset code, the screen will return to step 4 in “Operation Priority” on page 48.
4. Select “Settings Reset”, then press ●.

5. Press ▲ or ▼ to select “Yes”, then press ●.
All settings in a Java™ application will be reset.
To cancel resetting, select “No”, then press ●.

To clear all Java™ applications

All Java™ applications stored in Saved Games are cleared. The preloaded Java™ application cannot be deleted.

1. Perform steps 1 to 4 in “Operation Priority” on page 48.
2. Press ▲ or ▼ to select “Java™ Reset”, then press ●.
3. Enter your handset code, then press ●.
If you enter a wrong handset code, the screen will return to step 4 in “Operation Priority” on page 48.
4. Press ▲ or ▼ to select “All Clear”, then press ●.
5. Press ▲ or ▼ to select “Yes”, then press ●.
All Java™ applications are cleared.
To cancel clearing, select “No”, then press ●.

Java™ Information (M 3-1-3)

The information about the license of Java™ can be displayed.

Download More (M 3-1-4)







See “Download” on page 38 for instructions.

Other Games (M 3-2)





Your phone comes complete with 3 games (PK Game, Collection Hunter, Air Hockey).

You can enjoy these 3 games soon after purchase. You can also enjoy various games by downloading Java™ application games provided in the Internet sites. (p. 38)

Starting Games

1. Press  to display the Main Menu.
2. Press  or  to select “Fun & Games”, then press .
3. Press  or  to select “Other Games”, then press .



The game list is displayed.

4. Press  or  to select the desired game, then press .
5. Select “New Game”, then press .
6. When you have finished playing, press .

Note

- If an incoming call is detected during gameplay, the game will be stopped.







Game Guide

1. Perform steps 1 to 4 in “Starting Games”.
2. Press  or  to select “Guide”, then press . Game instructions are displayed.







Collection Hunter (M 3-2-2)

Check of a collection and reset of a game can be performed in “Collection Hunter”.

To Check Collection

1. Perform steps 1 to 3 in “Starting Games”.
2. Press  or  to select “Collection Hunter”, then press .
3. Press  or  to select “Collection View”, then press .

To Reset the Game

1. Perform steps 1 to 3 in “Starting Games”.
2. Press  or  to select “Collection Hunter”, then press .
3. Select “Reset Game”, then press .
4. Press  or  to select “Yes”, then press .

Air Hockey (M 3-2-3)

The level of the game can be chosen for “Air Hockey”.



To Select a Game Level

1. Perform steps 1 to 3 in “Starting Games” on page 51.
2. Press ▲ or ▼ to select “Air Hockey”, then press ●.
3. Press ▲ or ▼ to select “Level”, then press ●.
4. Press ▲ or ▼ to select the level, then press ●.

Setting up Game Options (M 3-2-4)

1. Perform steps 1 to 3 in “Starting Games” on page 51.
2. Press ▲ or ▼ to select “Game Settings”, then press ●.
3. Press ▲ or ▼ to select “Backlight” or “Enable Vibrate” to change the settings, then press ●.
4. Press ▲ or ▼ to select “On” or “Off”, then press ●.
5. Press ▲ or ▼ to select “Sound Volume” to adjust the sound volume, then press ●.
6. Press ▲ to increase the sound volume or press ▼ to decrease the sound volume and then press ●.

Note

- If you wish to mute the sound during gameplay, press . Press  again to return the volume.

Melody Editor (M 3-3)



You can create an original ringing tone by yourself, or you can send a melody attached to an MMS.

You can input up to 190 tones × 16 chords, or 380 tones × 8 chords per melody.





The original ringing tone is registered in the Saved Sounds.

Creating Your Original Ringing Tone (M 3-3-1)



1. Press ● to display the Main Menu.
2. Press ▲ or ▼ to select “Fun & Games”, then press ●.
3. Press ▲ or ▼ to select “Melody Editor”, then press ●.
4. Select “Create New”, then press ●.
5. Enter the title.
Up to 24 characters can be entered.
For details on entering characters, see “Entering Characters” on page 24.
6. Press ●.

7. Press  or  to select a tempo, then press .

The music tempo is described below.



- “Allegro (Fast)” :  150
- “Moderato (Normal)” :  125
- “Andante (Slow)” :  107
- “Adagio (Very Slow)” :  94

Tempo is defined by the number of crotchets () played per minute.

8. Select “8 Chords” or “16 Chords” by pressing  or , then press .

9. Specify the musical scale and rest using the digit keys.

For details on specifying the sound level and rest, see “Specify the Musical Scale and Rest” on page 54.

10. Specify the types of musical notes or rest using  or  keys.

For details on specifying the musical notes and rest, “Specifying the Types of Notes and Rests” on page 54.

11. Press  key after inputting one note.

Input the next note after the cursor moves to the right.

12. Repeat steps 9 to 11 to input notes.



When you press  during input, the melody that you have entered is played back.

When you press  [Options] and select “Play before Cursor” whilst entering notes, the melody, that is displayed on the screen, is played back up to the cursor position.

When you press  [Options] and select “Select Chord”, you can select another chord. Repeat steps 9 to 11 to input notes for the new chord.

13. When you finish inputting, press  [Options] to display the Options Menu.

14. Select “Save”, then press .

15. Press  or  to select “Save to My Phone”, then press .

Your original ringing tone is registered in the Saved Sounds.

Note

- If the capacity or memory in the Saved Sounds becomes insufficient, the message of “Maximum Capacity : 80 Not registered” or “Not registered. Memory Full” is displayed respectively. At that time, the display returns to the screen of step 15. Try again after deleting unnecessary data (p. 45).

Specify the Musical Scale and Rest

Using the key shown below, specify the musical scale and rest.

Do	Re	Mi	Fa	Sol	La	Ti	Rest
1 _{oD}	2 _{ABC}	3 _{DEF}	4 _{GHI}	5 _{JKL}	6 _{MNO}	7 _{PQRS}	0 __

When you press the key shown above once, a crotchet is specified in the middle scale (no mark).

When you press the same key repeatedly, the note will shift cycle through the available octave ranges.



When you press or whilst a note is selected, the note will raise one semitone higher or lower.

When entering rest: Crotchet rest is entered.

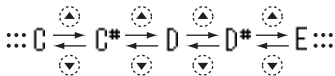

Specifying the Types of Notes and Rests

Specify notes and rests by pressing or repeatedly.

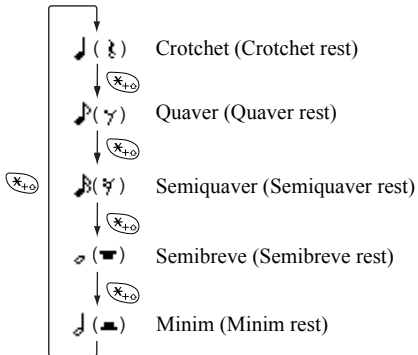

When you make a dotted note or triplet, press after selecting the target note.

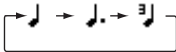



Note

- You cannot make a dotted semiquaver (semiquaver rest) or a dotted semibreve (semibreve rest).
- Three continuous notes are required for triplet.

To specify a tie, press  after selecting the target notes.









An underscore (_) is displayed next to the note, and the note is tied with the next one.

To enter the next note, press  and move the cursor to the right. Then, repeat the operation on the previous page.

If the cursor is positioned next to a note, you can repeat the note immediately left of the cursor when  or  is pressed.

Set the Tone

The phone can play notes using different instruments.

1. Perform steps 1 to 13 in “Creating Your Original Ringing Tone” on page 52.
2. Press  or  to select “Tone Set”, then press .
3. Select a category of the tone by pressing  or .
4. Select a tone by pressing  or , then press . When “Play Current Chord” is selected, the melody entered is played back in the selected tone. When “Confirm Tones” is selected, the syllable names are played back in the selected tone.
5. Select “OK”, then press .

Now you can create a melody.

You can select from the following 128 tones.

Category	Tone	Category	Tone
Pianos	Piano	Chimes	Celesta
	Bright Piano		Glockenspiel
	E. Grand Piano		Music Box
	Honky-Tonk		Vibraphone
	Electric Piano 1		Marimba
	Electric Piano 2		Xylophone
	Harpichord		Tubular Bells
	Clavi		Dulcimer

Category	Tone	Category	Tone
Organs	Drawbar Organ Perc. Organ Rock Organ Church Organ Reed Organ Accordion Harmonica Tango Accordion	Guitars	Nylon Guitar Steel Guitar Jazz Guitar Clean Guitar Muted Guitar Overdriven Gtr. Distortion Gtr. Gtr. Harmonics
Basses	Acoustic Bass Finger Bass Pick Bass Fretless Bass Slap Bass 1 Slap Bass 2 Synth Bass 1 Synth Bass 2	Strings 1	Violin Viola Cello Contrabass Tremolo Strings Pizz. Strings Harp Timpani
Strings 2	Str. Ensemble 1 Str. Ensemble 2 Synth Strings 1 Synth Strings 2 Choir Aahs Voice Oohs Synth Voice Orchestra Hit	Brasses	Trumpet Trombone Tuba Muted Trumpet French Horn Brass Section Synth Brass 1 Synth Brass 2

Category	Tone	Category	Tone
Reeds	Soprano Sax Alto Sax Tenor Sax Baritone Sax Oboe English Horn Bassoon Clarinet	Flutes/ Pipes	Piccolo Flute Recorder Pan Flute Blown Bottle Shakuhachi Whistle Ocarina
Synth Leads	Square Lead Sawtooth Lead Calliope Lead Chiff Lead Charang Lead Voice Lead Fifth Lead Bass & Lead	Synth Pads	New Age Pad Warm Pad Polysynth Pad Choir Pad Bowed Pad Metallic Pad Halo Pad Sweep Pad
Synth Effects	Rain Soundtrack Crystal Atmosphere Brightness Goblins Echoes Science Fiction	Ethnics	Sitar Banjo Shamisen Koto Kalimba Bagpipe Fiddle Shanai

Category	Tone	Category	Tone
Percussions	Tinkle Bell	Effects	Gtr. Fret Noise
	Agogo		Breath Noise
	Steel Drums		Seashore
	Woodblock		Bird Tweet
	Taiko Drums		Telephone Ring
	Melodic Tom		Helicopter
	Synth Drum		Applause
	Reverse Cymbal		Gunshot
Original	Original 1 (Piano)*		
	Original 2 (Glockenspiel)*		
	Original 3 (Reed Organ)*		
	Original 4 (Nylon Guitar)*		
	Original 5 (Violin)*		







* The default setting tone.

To create your original tone, see “Creating Your Original Tone” on page 61.

Setting the Strength of the Original Ringing Tone

The strength of the original ringing tone can be set in 3 levels for each melody.

When you purchase this phone, the strength of the original ringing tone is set to “forte (Loud)”.

1. Perform steps 1 to 13 in “Creating Your Original Ringing Tone” on page 52.
2. Press  or  to select “Strength Set”, then press .
3. Select a strength of the tone by pressing  or , then press .
4. Select “OK”, then press .



When “Play Current Chord” is selected, the original ringing tone entered is played back in the selected strength of the tone.





















Now you can create an original ringing tone.



Deleting an Original Ringing Tone

Perform steps 1 to 4 in “Deleting Sounds” on page 45.

Editing Original Ringing Tones

1. Perform steps 1 to 3 in “Creating Your Original Ringing Tone” on page 52.
2. Press  or  to select “Existing Melodies”, then press .

3. Press  or  to select an original ringing tone you wish to edit, then press  [Options].
The Options Menu is displayed.
4. Press  or  to select “Data Edit”, then press .
5. Edit the title and press .
6. Press  or  to select a tempo, then press .
7. Press  or  to select the number of chords, then press .
8. Select a note you wish to change by pressing  or , then edit notes.
For details on editing tones, see “Tone Editor” on page 59.
When you add notes, enter the note correctly on the cursor.
To delete a note, press  [Clear] briefly.
Press and hold  [Clear] to clear all tones.
9. When you finish editing, press  [Options] to display the Options Menu.
10. Select “Save”, then press .
11. Select “Save to My Phone”, then press .

12. Press  or  to select “Over Write”, then press .



The original ringing tone is changed.

If you select “New”, the melody before the correction is not modified. The original ringing tone is registered as a new original ringing tone.

Note

- When the number of chords is modified in step 7, the confirmation screen may be displayed. When you select “Yes”, a section of the melody may be deleted.
- When you are going to add notes in step 8, you cannot add any notes if you have already entered 380 notes (for 8 chords melodies) or 190 notes (for 16 chords melodies).











Tip

- To delete the continuous melody, press  [Options] and then press  after selecting “DEL after Cursor” or “DEL before Cursor.” You can delete the melody after the cursor or before the Cursor.

Copying and Pasting Notes

You can copy and move a part of a melody to another position.

Only original ringing tones or editable melodies can be copied or moved.

1. Perform steps 1 to 7 in “Editing Original Ringing Tones” on page 57.
2. Press  [Options] to display the Options Menu.
3. Press  or  to select “Copy” or “Cut”, then press .
4. Move the cursor to the first note to be copied or to be cut and press .
5. Move the cursor to the last note to highlight the area and press .
The highlighted area will be saved temporarily in the memory. If you select “Cut” in step 3, the highlighted area will be cut.
6. Press  [Options] to display the Options Menu.
7. Press  or  to select “Paste”, then press .
8. Move the cursor to the point you wish to paste the notes, then press .
Saved notes are pasted.

Tone Editor (M 3-4)

You can make a tone and use it for the original ringing tone.

Up to five types of tones can be registered respectively for 8 chords and 16 chords.

FM Sound Source

Various types of tones can be composed by combining the functions that generate one sine wave called an “Operator”. The combination of the operator is called an algorithm.

The operator acts as the modulator (modulating part) or the carrier (modulated part) depending on the algorithm.



- In each operator, various parameters such as multiple or envelope can be set.
- By setting the feedback to the specified operator, wider tone ranges can be created.

Setting an Algorithm

Set the combination of the operator.

Select from 4 types of combinations in 8 chords, and 2 types in 16 chords.

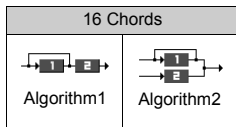
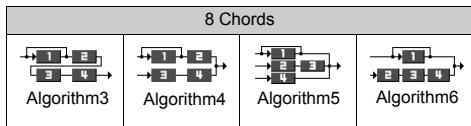









1 (Green number): The modulator (modulating part)

2 (White number): The carrier (modulated part)

Setting the Operator

The meaning and content of the parameter that can be set to the operator is described below.

Parameter	Meaning
Multiple (13 levels)	When the value of the carrier is large, the sound becomes high. You can set various types of notes by changing the values of the modulator.
Envelope (Continuous/Decay)	This sets continuous same note or fade-out.
Sustain (On/Off)	This sets a note to be sustained after completing the note. If you want to have a note with reverberation, set this function on.
Key Scale Rate (2 levels)	Set the function to "2" if you want to a short note.
Key Scale Level (4 levels)	This function sets the rate of reducing the volume as a note becomes higher.
Total Level (64 levels)	In the carrier, the volume becomes large as this level becomes higher. In the modulator, the melody becomes brighter as this level becomes higher. The melody becomes softer as this level becomes smaller.
Attack Rate (15 levels)	This sets the time from the beginning of the sound to the maximum volume.





















Parameter	Meaning
Decay Rate (16 levels)	This sets the time from the maximum volume to the volume of the sustain level.
Sustain Level (16 levels)	In sustaining note, this displays the volume of the sound that continues to produce. In fading-out note, this displays the volume when the note starts fading-out.
Release Rate (16 levels)	In sustaining note, this displays the sustaining time from note completion to no sound. In fading-out note, this displays the time from starting fade-out to no sound.
Wave Shape (8 types)	Select the basic wave type from eight types. <div style="display: flex; justify-content: space-around; text-align: center;"> <div>Type 1 </div> <div>Type 2 </div> <div>Type 3 </div> <div>Type 4 </div> </div> <div style="display: flex; justify-content: space-around; text-align: center; margin-top: 10px;"> <div>Type 5 </div> <div>Type 6 </div> <div>Type 7 </div> <div>Type 8 </div> </div>
Vibrato (4 levels/ Off)	Set the vibrato. If the vibrato is used, select from 4 levels.
Tremolo (4 levels/ Off)	Set the tremolo. If the tremolo is used, select from 4 levels.
Feedback (8 levels)	Set the level of modulation in the modulator feedback for Operator 1.

Set the Effect Frequency

Define the frequency of the vibrato or tremolo.

The frequency becomes faster as the figure increases.

Creating Your Original Tone

1. Press  to display the Main Menu.
2. Press  or  to select “Fun & Games”, then press .
3. Press  or  to select “Tone Editor”, then press .
4. Select “For 8 Chords” or “For 16 Chords” by pressing  or , then press .
5. Select the number you wish to register and press .
6. Press  or  to select “Rename”, then press .
7. Enter the title.
Up to 16 characters can be entered.
For details on entering characters, see “Entering Characters” on page 24.
8. Press .
9. Press  or  to select “Base Tone Set”, then press .
10. Select a category of the tone by pressing  or .

11. Select a base tone by pressing ▲ or ▼, then press ●.

When “Confirm Tones” is selected, the syllable names are played back in the selected tone.

12. Select “OK”, then press ●.

13. Press ▲ or ▼ to select “Details Editor”, then press ●.

14. Press ▲ or ▼ to select “Algorithm x”, then press ●.

15. Select an algorithm you wish to set by pressing ▲ or ▼, then press ●.

If you do not wish to change the operator, skip to step 20.

16. Select an operator you wish to change by pressing ▲ or ▼, then press ●.

The basic note parameter is set in advance.

17. Select a parameter you wish to change by pressing ▲ or ▼.

18. Press ◀ or ▶ to change the content of the parameter.

For details of parameter, see pages 60 to 61.

When you press ●, the syllable names are played back in the selected content of the parameter. Repeat steps 17 and 18 to change another content of the parameter.

19. Press ▲ or ▼ to select “Setup End”, then press ●.

If you do not wish to change the effect frequency, skip to step 22.

20. Press ▲ or ▼ to select “Effect Frequency”, then press ●.

21. Select the effect frequency you wish to set by pressing ▲ or ▼, then press ●.

22. Press ▲ or ▼ to select “Details End”, then press ●.

23. Press ▲ or ▼ to select “Save”, then press ●.
Your original tone is registered.

Profiles (M 4)











You can easily alter the phone tone (e.g. the ringer volume, keypad tones, etc.) according to your environment.

Tone sound and vibration set can be customized for each profile.





There are 5 profiles including one user definable profile:

- Normal
- Meeting
- Activity
- Car
- Silent

Activating a Profile

1. Press  to display the Main Menu.
2. Press  or  to select “Profiles”, then press .
3. Select the profile you wish to activate by pressing  or , then press .
4. Press  or  to select “Activate”, then press .
The profile will now be activated.









Note

- When a profile is set, the icon which corresponds to the profile name appears in the stand-by screen:
 -  Normal: Is the default setup. (not displayed in the stand-by screen)
 -  Meeting: For use when discretion is needed.
 -  Activity: For use in busy environments.
 -  Car: For use in the car. (connected to a hands free kit)
 -  Silent: For use when silence is needed. All sounds are muted and you are alerted to calls with the vibrator.

Tip

- You can also activate a profile by pressing and holding  for approximately 2 seconds instead of steps 1 and 2.















Customising Profiles

1. Perform steps 1 and 2 in “Activating a Profile”.
2. Select the profile you wish to customise by pressing  or , then press .
3. Press  or  to select “Edit”, then press .
4. Select the setting you wish to customise by pressing  or , then press .

5. Change the setting you want.

For details about settings, see pages 64 to 68.

Resetting Profile Settings

1. Perform steps 1 and 2 in “Activating a Profile” on page 63.
 2. Select the profile you wish to reset by pressing  or , then press .
 3. Press  or  to select “Edit”, then press .
 4. Press  or  to select “Set to Default”, then press .
 5. Enter your handset code, then press .
 6. Press  or  to select “Yes”, then press .
- To cancel the resetting, select “No”, then press .









Note

- If you enter a wrong handset code in step 5, the screen returns to step 4.

Ringer Volume



You can adjust the ringer volume to one of 5 levels.









When it is set to “Silent”, the volume of games and Java™ applications is muted.

1. Perform steps 1 to 3 in “Customising Profiles” on page 63.
2. Press  or  to select “Ringer Volume”, then press .
- The current volume level is displayed.
3. Press  to increase the ringer volume or press  to decrease the ringer volume and then press .
- To select “Step Tone”, press  at level 5.
- To select “Silent”, press  at level 1.

Ringer Type







You can select the ringing tone from 30 tones including 5 patterns, 15 sound effects and 10 melodies. You can also select a sound in the Saved Sounds as the default ringing tone excluding the WAVE format.

1. Perform steps 1 to 3 in “Customising Profiles” on page 63.
2. Press  or  to select “Assign Melody”, then press .

- Press  or  to select “Preset Melody” or “My Sounds”, followed by .
- Select the ringing tone you wish to use by pressing  or .
If you wish to hear the demo, press  [Play].
To stop playing, press  [Stop].
- When selection is complete, press .

Vibration

When the vibrator option is set to on, the phone will vibrate for incoming calls regardless of the ringer volume and tone settings.







- Perform steps 1 to 3 in “Customising Profiles” on page 63.
- Press  or  to select “Vibration”, then press .
- Press  or  to select “Enable”, “Disable” or “Link to Sound”, then press .

Tip











- When “Link to Sound” is selected in step 3, melodies are synchronised with the vibrator for the ringing tone. However, this function may not work depending on data.
- When you select “Enable” or “Link to Sound” in step 3, “” appears on the stand-by screen.

Keypad Tones

When the keypad tone is set to on, you will hear a confirmation tone each time you press a numerical key.

- Perform steps 1 to 3 in “Customising Profiles” on page 63.
- Press  or  to select “Keypad Tones”, then press .
- Press  or  to select “On” or “Off”, then press .

If you select “Off”, the screen returns to step 1.

- Set “Volume”, then press .
- Press  to increase the volume or press  to decrease the volume, then press .
- Press  or  to select “Melody”, then press .
- Press  or  to select either “Preset Melody”, “My Sounds” or “Default Tone”, then press .

When you select “Preset Melody” or “My Sounds” in step 7:

8. Select the keypad tone.

For details on selecting a ringing tone, see “Ringer Type” on page 64.

9. Press ▲ or ▼ to select “Duration”, then press ●.
10. Set the duration by pressing ▲ or ▼, then press ●.

Warning Tone

This function enables your phone to emit the warning tone when an error occurs.

1. Perform steps 1 to 3 in “Customising Profiles” on page 63.
2. Press ▲ or ▼ to select “Warning Tone”, then press ●.
3. Press ▲ or ▼ to select “On” or “Off”, then press ●.

If you select “Off”, the screen returns to step 1.

















4. Select “Volume”, then press ●.
5. Press ▲ to increase the volume or press ▼ to decrease the volume, then press ●.

6. Press ▲ or ▼ to select “Melody”, then press ●.
7. Press ▲ or ▼ to select “Preset Melody” or “My Sounds”, then press ●.
8. Select the warning tone.
For details on selecting a ringing tone, see “Ringer Type” on page 64.
9. Press ▲ or ▼ to select “Duration”, then press ●.
10. Select the duration by pressing ▲ or ▼, then press ●.

Power On/Off Sound























You can set up to emit a sound and select the melody, volume and duration when the phone is turned on or off.





1. Perform steps 1 to 3 in “Customising Profiles” on page 63.
2. Press ▲ or ▼ to select “Power On Sound” or “Power Off Sound”, then press ●.

3. Press  or  to select “On” or “Off”, then press .
- If you select “Off”, the screen returns to step 1.
4. Select “Volume”, then press .
5. Press  to increase the volume or press  to decrease the volume and then press .
6. Press  or  to select “Melody”, then press .
7. Press  or  to select “Preset Melody” or “My Sounds”, then press .
8. Select the ringing tone.
For details on selecting a ringing tone, see “Ringer Type” on page 64.
9. Press  or  to select “Duration”, then press .
10. Enter the duration of ringing tone in 2 digits (01 to 10 seconds) using the digit keys, then press .

Message Alert







When receiving messages, special ring tones can be set.

1. Perform steps 1 to 3 in “Customising Profiles” on page 63.
2. Press  or  to select “Message Alert”, then press .
3. Press  or  to select “MMS”, “SMS” or “WAP”, then press .
4. Select “Volume”, then press .
5. Press  to increase the volume or press  to decrease the volume and then press .
6. Press  or  to select “Melody”, then press .
7. Press  or  to select “Preset Melody” or “My Sounds”, then press .
8. Select the ringing tone.
For details on selecting a ringing tone, see “Ringer Type” on page 64.
9. Press  or  to select “Vibration”, then press .
10. Press  or  to select “Enable”, “Disable” or “Link to Sound”, then press .





11. Press  or  to select “Duration”, then press .
12. Enter the duration of ring tone in 2 digits (01 to 99 seconds) using the digit keys, then press .

Low Battery Alert

Adjust the volume of the alarm when the battery becomes low.

1. Perform steps 1 to 3 in “Customising Profiles” on page 63.
2. Press  or  to select “Low Battery Alert”, then press .
3. Press  to increase the volume or press  to decrease the volume and then press .







Any Key Answer

1. Perform steps 1 to 3 in “Customising Profiles” on page 63.
2. Select “Any Key Answer”, then press .
3. Select “On” or “Off” by pressing  or , then press .

Organiser

Calculator (M 5-1-1)

The calculator function performs the 4 arithmetic calculations using up to 12 digits.



1. Press  to display the Main Menu.
 2. Press  or  to select “Organiser”, then press .
 3. Select “Calculator”, then press .
 4. Select “Calculator”, then press .
- The calculator appears on the display.
5. Key operations for calculation are as follows.



To enter a decimal point, press .

To clear the entered number or operand, press  [C].









To do the calculations, press .

6. If you wish to start a new calculation, press  [C].
When calculation is complete, press .

Rate Conversion





You can also use the calculator as a currency calculator to convert from/to a home currency using a conversion rate that you enter.

To Set a Currency Conversion Rate (M 5-1-2)

1. Perform steps 1 to 3 in “Calculator”.
 2. Press  or  to select “Exchange Rate”, then press .
 3. Press  or  to select “Foreign → Domestic” or “Domestic → Foreign”, then press .
- To delete all digits, press  [Clear].
4. Enter the currency conversion rate, then press .

To Convert a Value

1. Perform steps 1 to 4 in “Calculator”.
2. Enter the value to be converted, then press .













3. Press  or  to select “In Domestic” or “In Foreign”, then press .
The result is displayed.
If you select “Exchange Rate” in step 3, you can set a currency conversion rate.
4. When calculation is complete, press .





Note

- You cannot perform step 2 when a sign of the four fundamental processes of arithmetic is displayed.

Calendar (M 5-2)

The Calendar function helps you organise and manage your busy schedule. You can view the stored schedule on a monthly basis.

1. Press  to display the Main Menu.
2. Press  or  to select “Organiser”, then press .
3. Press  or  to select “Calendar”, then press .
The current month will be displayed and current date will be highlighted.
4. Select the day for the schedule by pressing , ,  or , then press .



5. Press  or  and select the note number, then press .
6. Enter the schedule content, press .
Up to 3 schedule items can be stored.
For details on entering characters, see “Entering Characters” on page 24.
If you wish to add another item, repeat steps 5 and 6.
7. When you have finished entering, press  [Back].
The screen returns to the calendar. Dates with scheduled tasks/meetings are underlined.

Note

- The calendar can be displayed for dates from January 2000 through to December 2099.









Find a Particular Date

You can move the view to a specified date in the calendar.





1. Press  [Options] to display the Option Menu.
2. Select “Go to Date”, then press .
3. Enter the date of the calendar to be displayed, then press .
The specified date is displayed.

Deleting Schedules

To Delete Schedule Items





1. Perform steps 1 to 3 in “Calendar” on page 70.
2. Select the day by pressing , ,  or , then press .
3. Select the item you wish to delete by pressing , , then press  [Options].

The Options Menu is displayed.





4. Press  or  to select “Delete”, then press .
5. Select “1 Data”, then press .
6. Select “Yes”, then press .

To cancel deleting, select “No” at step 6, then press .

To Delete All Scheduled Tasks/Meetings for a Specific Day

1. Perform steps 1 to 3 in “Calendar” on page 70.
2. Select the day you wish to delete by pressing , ,  or , then press  [Options].





The Options Menu is displayed.



3. Press  or  to select “Delete”, then press .
4. Select “1 Day” to delete all contents for a day, then press .

5. Select “Yes”, then press .

To cancel deleting, select “No” at step 5, then press .

To Delete All Scheduled Entries

1. Perform steps 1 to 3 in “Calendar” on page 70.
2. Press  [Options] to display the Options Menu.
3. Press  or  to select “Delete” to delete all scheduled entries, then press .

4. Press  or  to select “All Data” to delete all scheduled entries, then press .







5. Select “Yes”, then press .





To cancel deleting, select “No” at step 3, then press .

Clock & Alarm

You need to set the correct time and date in order for your phone’s various time-based functions to work correctly.

Setting the Date and Time (M 5-3-4)







1. Press  to display the Main Menu.
2. Press  or  to select “Organiser”, then press .
3. Press  or  to select “Clock & Alarm”, then press .

4. Press  or  to select “Set Date/Time”, then press .
5. Enter the day, month, year and time using the digit keys, then press .

When you enter the time in a 12-hour clock format, press  and change am/pm.



The order in which the date and time appears is based on the format setting. See “To Select the Date Format”.







To Select the Time System

1. Perform steps 1 to 3 in “Setting the Date and Time” on page 71.
2. Press  or  to select “Clock Settings”, then press .
3. Select “Time Format”, then press .
4. Press  or  to select “12 hour” or “24 hour”, then press .











To Select the Date Format

The date format can be switched between “Day-Month-Year”, “Month-Day-Year” or “Year-Month-Day”.

1. Perform steps 1 to 3 in “Setting the Date and Time” on page 71.
2. Press  or  to select “Clock Settings”, then press .

3. Press  or  to select “Date Format”, then press .
4. Press  or  to select “D-M-Y”, “M-D-Y” or “Y-M-D”, then press .









To Set the Clock Display

1. Perform steps 1 to 3 in “Setting the Date and Time” on page 71.
2. Press  or  to select “Clock Settings”, then press .
3. Press  or  to select “Display Format”, then press .
4. Press  or  to select “Time Only”, “Date Only” or “Date & Time”, then press .
To set hide clock, select “Off” at step 4, then press .
When “Wallpaper” is set to “On”, the date is not displayed in the main screen.







To Set Daylight Saving Time

You can switch to daylight saving time without having to change the clock time itself.









1. Perform steps 1 to 3 in “Setting the Date and Time” on page 71.

2. Press  or  to select “Clock Settings”, then press .
3. Press  or  to select “Daylight Saving”, then press .
4. Press  or  to select “On”, then press .

Setting the Time Zone (M 5-3-3)

1. Perform steps 1 to 3 in “Setting the Date and Time” on page 71.
2. Press  or  to select “Set Time Zone”, then press .
3. Select “Change Zone”, then press .
4. Press  or  to set the home city, then press .













To Customise the Time Zone

1. Perform steps 1 to 3 in “Setting the Date and Time” on page 71.
2. Press  or  to select “Set Time Zone”, then press .
3. Press  or  to select “Set Custom Zone”, then press .
4. Enter the time using the digit keys, then press .
Each press of  switches - and +.







Setting Alarm (M 5-3-1)











Alarm function allows you to be alerted at a specified time.

Note that the alarm may not function correctly if the clock has not been set.











1. Press  to display the Main Menu.
2. Press  or  to select “Organiser”, then press .
3. Press  or  to select “Clock & Alarm”, then press .
4. Select “Set Alarm”, then press .
5. Select “List Alarm”, then press .
6. Press  or  to select the desired alarm number, then press .

Up to 5 alarm times can be specified.









7. Select “Set Time”, then press .
 8. Enter the alarm time using the digit keys, then press .
- When you enter the alarm time in a 12-hour clock format, press  and change am/pm.
9. Press  or  to select “Repeat Daily”, then press .

10. Press  or  to select “On” or “Off”, then press .
11. Press  or  to select “Alarm Status”, then press .
12. Press  or  to select “On”, then press .
13. Press  [Save].







To Change the Type of Alarm Tone

1. Perform steps 1 to 6 in “Setting Alarm” on page 73.
2. Press  or  to select “Alarm Tone”, then press .
3. Select “Melody”, then press .
4. Press  or  to select “Preset Melody” or “My Sounds”, then press .
5. Select the alarm tone.
If you wish to hear the demo play, press  [Play].
To stop playing, press  [Stop].
6. When selection is complete, press .



To Change the Vibration of Alarm

1. Perform steps 1 to 6 in “Setting Alarm” on page 73.
2. Press  or  to select “Alarm Tone”, then press .
3. Press  or  to select “Vibration”, then press .
4. Press  or  to select “Enable”, “Disable” or “Link to Sound”, then press .

To Change the Duration of Alarm









1. Perform steps 1 to 10 in “Setting Alarm” on page 73.
2. Press  or  to select “Alarm Tone”, then press .
3. Press  or  to select “Duration”, then press .
- The current duration is displayed.
4. Enter the length of the duration in 2 digits (02 to 59 seconds) using the digit keys, then press .

Changing Alarm Settings









1. Perform steps 1 to 5 in “Setting Alarm” on page 73.
2. Select the number you wish to change by pressing  or , then press .
3. Change Alarm settings.

For details on changing Alarm settings, see “To Change the Type of Alarm Tone” on page 74.







Disabling Alarm Function

1. Perform steps 1 and 2 in “Changing Alarm Settings”.
2. Press  or  to select “Alarm Status”, then press .
3. Press  or  to select “Off”, then press .
4. Press  [Save].
“” disappears from the screen.

Resetting an Alarm Setting

1. Perform steps 1 to 5 in “Setting Alarm” on page 73.
2. Select the number you wish to reset by pressing  or , then press .
3. Press  or  to select “Reset Alarm”, then press .
4. Press  or  to select “Yes”, then press .









Resetting All Alarm Settings



1. Perform steps 1 to 4 in “Setting Alarm” on page 73.
2. Press  or  to select “Clear All”, then press .
3. Press  or  to select “Yes”, then press .

Voice Memo (M 5-4)



This allows you to record a voice message of up to 10 seconds, which can be used to remind you of schedule entries or be sent within an MMS. The recorded voice memo is registered in the My Sounds.

Recording a Voice Memo





1. Press  to display the Main Menu.
2. Press  or  to select “Organiser”, then press .
3. Press  or  to select “Voice Memo”, then press .
4. Press  to start recording.
To stop recording before the recording time is over, press  [Stop].

5. Select “Save” to save the voice memo, then press .
- If you wish to exit the voice memo, press  [Exit], then select “Yes”.

Tip











- You can also record a voice memo by pressing  and  instead of steps 1 to 3.
- If you wish to record a voice memo again, select “Record Again” in step 5. The screen will return to step 4.

To Play Back the Saved Voice Memo

1. Perform steps 1 to 4 in “Recording a Voice Memo” on page 75.
 2. Press  or  to select “Playback”, then press .
 3. Press .
- The recorded voice memo is played back.
To stop playback, press  [Stop].

Help List (M 5-5)

You can view the help list and use it to guide you in the phone’s functions.

















1. Press  to display the Main Menu.
 2. Press  or  to select “Organiser”, then press .
 3. Press  or  to select “Help List”, then press .
- The help list is displayed.
4. Check the key operation by pressing  and .
 5. When you have finished, press  [Back].

Call Manager





Call Log

The phone will record the last 10 missed calls, received calls and dialled numbers.









Viewing Call Log

1. Press  to display the Main Menu.
2. Press  or  to select “Call Manager”, then press .
3. Press  or  to select “Call Register”, then press .
4. Press  or  to select “Missed Calls”, “Received Calls” or “Dialled Numbers”, then press .
The selected call log list is displayed.
5. Select the number you wish to view by pressing  or .
6. Press  [View].
Call record “1” is the most recent.
When you press , call record “2” will be displayed.
If you wish to dial the number, press .
7. When you have finished, press  [Back] to return to step 4.

Tip





- You can also confirm call records by pressing  in stand-by mode.
- You can switch between histories by pressing  or  in step 5 only when you enter by  in stand-by mode.





Sending Messages

1. Perform steps 1 to 5 in “Viewing Call Log”.
2. Select the file name you wish to send by pressing  or , then press .
3. Press  or  to select “Send Message”, then press .
4. Press  or  to select “MMS” or “SMS”, then press .
5. Enter your message.
For details on creating a message, see “Creating a New MMS” on page 107 or “Creating a New SMS” on page 115.









Deleting Call Log

Deleting Single Call Record

1. Perform steps 1 to 5 in “Viewing Call Log”.
2. Press .
3. Press  or  to select “Delete”, then press .

4. Press  or  to select “Yes”, then press .
The selected call record will be deleted.
To cancel deletion, select “No” in step 4, then press .

To Delete All Call Log (M 6-2-4)

1. Perform steps 1 to 3 in “Viewing Call Log” on page 77.
2. Press  or  to select “Clear Logs”, then press .
3. Select “All Calls”, then press .
4. Press  or  to select “Yes”, then press .
All call log records will be deleted.
To cancel deleting, select “No” in step 4, then press .













Tip

- If you select “Missed Calls”, “Received Calls” or “Dialled Numbers” in step 3, the call log in the selected category will be deleted.





Call Timers (M 6-2-5)

This function lets you check the duration of your calls.

Checking the Duration of the Last Call









1. Press  to display the Main Menu.
2. Press  or  to select “Call Manager”, then press .
3. Press  or  to select “Call Register”, then press .
4. Press  or  to select “Call Timers”, then press .
5. Select “Last Call”, then press .
The duration of the last call is now displayed.
6. When you have finished, press  [Back] to return to call timers menu.

Checking the Total Call Time

1. Press  or  to select “All Calls”, then press  in step 5 in “Checking the Duration of the Last Call”.
2. When you have finished, press  [Back].

Resetting All Call Timers













1. Perform steps 1 to 4 in “Checking the Duration of the Last Call”.

2. Press  or  to select “Clear Timers”, then press .
3. Press  or  to select “Yes”, then press . To cancel resetting, select “No”, then press .
4. Enter your handset code, then press . The Call Timers are reset to zero.





Call Costs (M 6-2-6)

This function lets you check the charges for your calls. Charging Advice is not supported on all networks. Please check with your service provider for availability.

Checking the Cost of the Last Call











1. Press  to display the Main Menu.
2. Press  or  to select “Call Manager”, then press .
3. Press  or  to select “Call Register”, then press .
4. Press  or  to select “Call Costs”, then press .
5. Select “Last Call”, then press . The cost of the last call is now displayed.
6. When you have finished, press  [Back] to return to call costs menu.

Checking the Total Call Cost



1. Press  or  to select “All Calls”, then press  in step 5 in “Checking the Cost of the Last Call”.
2. When you have finished, press  [Back].

Setting the Charge Rate

Set the charge rate to calculate the call cost and set the maximum limit for call cost.









1. Perform steps 1 to 4 in “Checking the Cost of the Last Call” on page 79.
2. Press  or  to select “Cost Units”, then press .
3. Press  or  to select “Set Units”, then press .
4. Enter your PIN2 code, then press .
5. Enter a cost per unit, then press 
To enter a decimal point, press .
6. Enter a currency unit (up to 3 characters), then press .

Checking the Charge Rate



1. Select “Read Units”, then press  at step 3 in “Setting the Charge Rate”.
The charge rate is now displayed.
2. When you have finished, press  [Back].

Setting the Charge Limit









This function is useful if you wish to make sure you do not exceed a certain charge limit.

1. Perform steps 1 to 4 in “Checking the Cost of the Last Call” on page 79.
2. Press  or  to select “Max Cost”, then press .
3. Press  or  to select “Set Limit”, then press .
4. Enter your PIN2 code, then press .
5. Enter a value, then press 
To enter a decimal point, press .





Checking the Charge Limit

1. Select “Read Limit”, then press  at step 3 in “Setting the Charge Limit”.
The value of the charge limit is now displayed.
2. When you have finished, press  [Back].

Resetting All Call Costs













1. Perform steps 1 to 4 in “Checking the Cost of the Last Call” on page 79.
2. Press  or  to select “Clear Costs”, then press .
3. Press  or  to select “Yes”, then press .
To cancel resetting, select “No”, then press .
4. Enter your PIN2 code, then press .
The Call Costs are reset to zero.

Checking the Residual Credit

1. Perform steps 1 to 4 in “Checking the Cost of the Last Call” on page 79.
2. Press  or  to select “Residual Credit”, then press .
3. When you have finished, press  [Back].

Data Counter (M 6-2-7)







You can confirm the amount of bytes which you used in the GPRS transmission.

1. Press  to display the Main Menu.
2. Press  or  to select “Call Manager”, then press .
3. Press  or  to select “Call Register”, then press .
4. Press  or  to select “Data Counter”, then press .
5. Press  or  to select “Last Data” or “All Data”, then press .

You can now check the amount of bytes.

6. When you have finished, press  [Back].











Resetting All Data Counter

1. Perform steps 1 to 4 in “Data Counter”.
2. Press  or  to select “Clear Counter”, then press .
3. Press  or  to select “Yes”, then press .
The Data Counter is reset to zero. To cancel resetting, select “No” at step 3, then press .

Diverts (M 6-3)







This service is used to divert incoming calls to your voice mail system or to another number depending on certain conditions in which you cannot answer a call.

Divert Calls

1. Press  to display the Main Menu.
2. Press  or  to select “Call Manager”, then press .
3. Press  or  to select “Diverts”, then press .
4. Select one of the divert options by pressing  or , then press .

The divert options available are:

- “All Calls”: Diverts all voice calls without ringing.
- “When Busy”: Diverts incoming calls when you are on a call.
- “No Answer”: Diverts incoming calls if you do not answer a call within a certain period of time.
- “Not Reachable”: Diverts incoming calls when your phone is out of network service or switched off.

5. Select “On”, then press .
6. If you wish to divert calls to a number which is located in the Phonebook, search for the desired Phonebook entry.
Press  or  [Search] to search the number by name or press  or  to search in alphabetical order, then press . For details on searching the Phonebook entries, see “Finding a Name and Number” on page 28.
7. If you wish to divert calls to a number which you can enter manually, enter the phone number.
8. Press .

If you select “No Answer” in step 4:

9. Enter the period of time using the digit keys (05 to 30 seconds), then press .







Note

- When a divert is set to “All Calls”, “ ” appears on the stand-by screen.









Tip

- If you select “By Service” in step 5, you can select the divert option further in the selected option in step 4.







Checking the Divert Status

1. Perform steps 1 to 3 in “Divert Calls” on page 82.
2. Select the divert option you wish to check by pressing  or , then press .
3. Press  or  to select “Status”, then press .
You can now check the status of the selected divert option.
4. When you have finished, press  [Back].

Cancelling All Divert Settings

1. Perform steps 1 to 3 in “Divert Calls” on page 82.
2. Press  or  to select “Cancel All”, then press .
3. Press  or  to select “Yes”, then press .
To cancel the resetting, select “No” in step 3, then press .
4. Press  [OK].
All divert settings are cancelled.

To cancel the Divert Settings Individually









1. Perform steps 1 to 3 in “Divert Calls” on page 82.
2. Select the divert option you wish to cancel by pressing  or , then press .
3. Press  or  to select “Off”, then press .
4. Press  [OK].
The selected divert has been cancelled.

Settings

Phone Settings

Changing the Language (M 7-1-1)

You can change the display language that the phone uses for the display messages and text entry.











1. Press  to display the Main Menu.
2. Press  or  to select “Settings”, then press .
3. Select “Phone Settings”, then press .
4. Select “Language”, then press .
5. Press  or  to select the desired language, then press .

Wallpaper for the Stand-by Screen (M 7-1-2)

For the stand-by screen, an animation and 3 illustrations are provided.

Pictures taken with the digital camera or images downloaded from a WAP site can be used for wallpapers.

To Set Built-in Animations or Illustrations

1. Perform steps 1 to 3 in “Changing the Language”.
2. Press  or  to select “Wallpaper”, then press .
3. Press  or  to select “On”, then press .
4. Select “Animation” or “Illustration 1” to “Illustration 3” by pressing  or , then press .
5. Press  again to set.

The selected animation or illustration is displayed on the stand-by screen.



Note

- Even if an animation is selected, the stand-by screen displays a static picture/image when you do not operate the phone for about 30 seconds (It is different according to the selected data).



Tip

- To cancel the Wallpaper setting, select “Off” in step 3.





To Set My Pictures for the Stand-by Screen

1. Perform steps 1 to 3 in “To Set Built-in Animations or Illustrations” on page 84.
2. Press  or  to select “My Pictures”, then press .

The file names of the pictures/images that are registered in the Saved Pictures is displayed.

3. Select the picture/image by pressing  or , then press .

The selected picture/image is displayed.

4. Specify the range for displaying the picture/image by pressing , ,  or , then press .

The selected picture/image is displayed on the stand-by screen.

Note



- Some pictures/images cannot be used because of their picture/image and data types.

Backlight (M 7-1-3)



You can turn the backlight of the main screen display on or off when you press the keypad or the optional cigarette lighter charger is connected to the phone.

You can change or specify the amount of time the backlight is ON for, which will help conserve battery life.

To Turn On/Off the Backlight

1. Perform steps 1 to 3 in “Changing the Language” on page 84.
2. Press  or  to select “Backlight”, then press .







3. Press  or  to select “On/Off”, then press .

4. Select “On” to set backlight on or “Off” to set backlight off by pressing  or , then press .

When you select “On” in step 4:

5. Enter the duration of the backlight using 2 digits, then press .

To Turn On/Off the Backlight whilst Charging with the Cigarette Lighter Charger

1. Perform steps 1 and 2 in “To Turn On/Off the Backlight”.
2. Press  or  to select “In Car”, then press .
3. Select “On” to set backlight on or “Off” to set backlight off by pressing  or , then press .

Adjust the Brightness of the Backlight (M 7-1-4)

You can adjust the brightness of the backlight of the main screen display at four levels.

1. Perform steps 1 to 3 in “Changing the Language” on page 84.
2. Press ▲ or ▼ to select “Brightness”, then press ●.
3. Press ▲ (Light) or ▼ (Dark) to adjust the brightness for maximum clarity.
4. Press ●.

Note

- *The brightness of the backlight does not affect the brightness of the Sub-Screen.*

Display Saving (M 7-1-5)

This phone’s screen will automatically turn off after a given amount of time if the phone is left open. This is in order to conserve battery life.

You can change the time the Display Saving will go into effect works between 2 and 20 minutes.

Tip

- *When you purchase this phone, the Display Saving is set to work 10 minutes later.*

1. Perform steps 1 to 3 in “Changing the Language” on page 84.
2. Press ▲ or ▼ to select “Display Saving”, then press ●.
3. Enter the time until the Display Saving works in two digits (02 to 20 minutes) using the digit keys, then press ●.

Note







- *The Display Saving does not work whilst you are calling, using WAP, or using a Java™ application.*

To Cancel the Display Saving Function

The display saving continues until either a key is pressed or there is an incoming alert. The first key press will only cancel the display saver. You must press another key in order to input any numerical or text value.

Setting the Greeting Message (M 7-1-6)

You can set the message which will appear when the phone is turned on.

1. Perform steps 1 to 3 in “Changing the Language” on page 84.
2. Press  or  to select “Greeting Message”, then press .
3. Press  or  to select “On”, then press .
4. Enter the message, then press .

Up to 16 characters can be stored as a message.
For details on entering characters, see “Entering Characters” on page 24.

Tip

- To cancel the Greeting Message setting, select “Off” in step 3.













Assign Pictures (M 7-1-7)

Pictures/images can be displayed when turning the power on or off, when receiving an incoming call, or when operating the alarm.

Pictures taken by a digital camera or images downloaded from a WAP site can be used.

To Set Built-in Pictures/Images



1. Perform steps 1 to 3 in “Changing the Language” on page 84.

2. Press  or  to select “Assign Pictures”, then press .
3. Select the screen to set the picture/image by pressing  or , then press .
4. Select “Animation 1” or “Animation 2” by pressing  or , then press .
- or
Select “Illustration 1” or “Illustration 2” by pressing  or , then press  when you select “Alarm” in step 3.
The selected picture/image is displayed.
5. Press .









Tip

- To cancel the picture/image setting, select “Off” in step 4.

To Set My Pictures

1. Perform steps 1 to 3 in “To Set Built-in Pictures/Images”.
2. Press  or  to select “My Pictures”, then press .

The file name of the pictures/images that are registered in the Saved Pictures is displayed.

3. Select the picture/image by pressing  or , then press .
The selected picture/image is displayed.
4. Specify the range for displaying the picture/image by pressing , ,  or , then press .

Note









- Some pictures/images cannot be used because of their picture/image and data types.

External Display (M7-1-8)

You can change the settings of the Sub-Screen Display.

To Turn On/Off the Sub-Screen Display









You can turn the Sub-Screen Display on or off when the phone is closed.

1. Perform steps 1 to 3 in “Changing the Language” on page 84.
2. Press  or  to select “External Display”, then press .
3. Press  or  to select “LCD On/Off”, then press .
4. Select “On” to set Sub-Screen Display on or “Off” to set Sub-Screen Display off by pressing  or , then press .

To Turn On/Off the Backlight of the Sub-Screen Display

You can turn the backlight of the Sub-Screen Display on or off when the phone is closed.

You can also change or specify the duration of the Sub-Screen Display backlight.

1. Perform steps 1 to 3 in “Changing the Language” on page 84.
2. Press  or  to select “External Display”, then press .
3. Press  or  to select “Backlight”, then press .
4. Select “On” to set backlight on or “Off” to set backlight off by pressing  or , then press .









When you select “On” in step 4:

5. Enter the duration of the backlight using 2 digits, then press .

To Adjust the LCD Contrast of the Sub-Screen









You may sometimes need to adjust the LCD contrast of the Sub-Screen to suit certain lighting conditions.

1. Perform steps 1 to 3 in “Changing the Language” on page 84.

2. Press  or  to select “External Display”, then press .
3. Press  or  to select “LCD Contrast”, then press .
4. Press  (Dark) or  (Light) to adjust the contrast for maximum clarity.
LCD contrast can be adjusted in 9 levels.
5. Press .

Phone Setting Reset (M 7-1-9)

The phone settings can be reset to their default settings.

1. Perform steps 1 to 3 in “Changing the Language” on page 84.
 2. Press  or  to select “Set to Default”, then press .
 3. Enter your handset code, then press .
 4. Press  or  to select “Yes”, then press .
- To cancel resetting, select “No” in step 4, then press .
- All phone settings are reset.

Note













- If you enter a wrong handset code in step 3, operation is cancelled.

Call Settings

Set various types of functions and services.

Call Waiting (M 7-2-1)





If you wish to be able to receive another incoming call whilst you have a call in progress, you must activate the Call Waiting service.

1. Press  to display the Main Menu.
2. Press  or  to select “Settings”, then press .
3. Press  or  to select “Call Settings”, then press .
4. Select “Call Waiting”, then press .
5. Select “On” to activate the Call Waiting service or “Off” to deactivate it by pressing  or , then press .
6. Press  [OK].







Note

- Call Waiting service may not be available on all mobile phone networks. Contact your network operator for more information.

To Check the Call Waiting Service Status

1. Perform steps 1 to 4 in “Call Waiting” on page 89.
2. Press  or  to select “Status”, then press .
Now you can check the status of the Call Waiting service.
3. Press  [Back].







Display Call Timers (M 7-2-2)

1. Perform steps 1 to 3 in “Call Waiting” on page 89.
2. Press  or  to select “Display Call Timers”, then press .
3. Select “On” or “Off” by pressing  or , then press .



Caller No. Status (M 7-2-3)

This lets you control whether to show your phone number or caller’s phone number when calling another party.





Caller No. Status is not supported on all networks. Please check with your service provider for availability.

1. Perform steps 1 to 3 in “Call Waiting” on page 89.
2. Press  or  to select “Caller No. Status”, then press .
3. Select the option you wish to set by pressing  or , then press .

The options available are:

- “Show Callers No.”: Displays whether caller numbers are displayed or not.
- “Show Your No.”: Displays whether your phone number is notified to your caller or not. This function can be turned On/Off with this option.
Select “On” to activate the option you wish to set or “Off” to deactivate it by pressing  or , then press .
- “Show Called No.”: Displays whether the phone number of the phone you are connected to is displayed or not, even if your call is diverted to another phone number.
- “Hide if Called”: Displays whether your phone number is hidden or not from any callers.







To Check the Caller No. Status





1. Perform steps 1 to 3 in “Caller No. Status”.
2. Press  or  to select “Status”, then press .
Now you can check the status of the Caller No. Status.
3. Press  [OK].



Personal Call (M 7-2-4)



A specified ringing tone or vibrator setting can be associated to a pre-registered phone number.



Up to 20 phone numbers can be registered.

1. Perform steps 1 to 3 in “Call Waiting” on page 89.
2. Press  or  to select “Personal Call”, then press .
3. Select the number you wish to set by pressing  or , then press .
4. Enter the phone number, then press .

If you wish to select the phone number in the Phonebook, search for the desired Phonebook entry. Press  or  [Search] to search the number by name or press  or  to search in alphabetical order, then press . For details on searching the Phonebook entries, see “Finding a Name and Number” on page 28.

5. Press  or  to select “Assign Melody”, then press .
6. Select a ringing tone.
For details on selecting a ringing tone, see “Ringer Type” on page 64.

7. Press  or  to select “Vibration”, then press .

8. Press  or  to select “Enable”, “Disable” or “Link to Sound”, then press .

For details on setting the vibrator, see “Vibration” on page 65.

9. When setting is complete, select “Setup End”, then press .

Group Call (M 7-2-5)













Phone numbers can be registered or updated in groups.

To Set Group Ringing Tone

Different ringing tones can be set for each group.

When you purchase this phone, groups are set to off.

If you do not set a group ringing tone the default ringing tone will be used.

1. Perform steps 1 to 3 in “Call Waiting” on page 89.
2. Press  or  to select “Group Call”, then press .
3. Select the group you want to set by pressing  or , then press .
4. Press  or  to select “On”, then press .
5. Press  or  to select “Assign Melody”, then press .

6. Select a ringing tone.
For details on selecting a ringing tone, see “Ringer Type” on page 64.
7. Press ▲ or ▼ to select “Vibration”, then press ●.
8. Press ▲ or ▼ to select “Enable”, “Disable” or “Link to Sound”, then press ●.
For details on setting the vibration, see “Vibration” on page 65.
9. When setting is complete, select “Setup End”, then press ●.

Tip

- To cancel the ringing tone setting, select “Off” in step 4.

Auto Redial (M 7-2-6)

See “Automatic Redialling” on page 20 about this function.

Minute Minder (M 7-2-7)

Minute Minder function informs you of your talk time by sounding a tone after every minute.

1. Perform steps 1 to 3 in “Call Waiting” on page 89.
2. Press ▲ or ▼ to select “Minute Minder”, then press ●.

3. Press ▲ or ▼ to select “On” or “Off”, then press ●.

Call Setting Reset (M 7-2-8)

The call settings can be reset to their default settings.

1. Perform steps 1 to 3 in “Call Waiting” on page 89.
2. Press ▲ or ▼ to select “Set to Default”, then press ●.
3. Enter your handset code, then press ●.
4. Press ▲ or ▼ to select “Yes”, then press ●.
To cancel resetting, select “No” at step 4, then press ●.

All call settings are reset.

Note









- If you enter the wrong handset code in step 3, the operation is cancelled and the screen returns to step 3 in “Call Waiting” on page 89.

Network Settings







Selecting a Network Automatically (M 7-3-1)

Each time the power is turned on, your phone will always try to connect first to the most recently available network, then to the subscribed network, and lastly to the preferred network.









If none of these are found, it will then search for any other available GSM networks.

1. Press  to display the Main Menu.
2. Press  or  to select “Settings”, then press .
3. Press  or  to select “Network Settings”, then press .
4. Select “Select Network”, then press .
5. Select “Automatic”, then press .

To Set the Network Manually







1. As in step 5 in “Selecting a Network Automatically”, press  or  to select “Manual”, then press .
2. Select the network from the list by pressing  or , then press .

Adding a New Network

1. Perform steps 1 to 4 in “Selecting a Network Automatically”.
2. Press  or  to select “Add New Network”, then press .
3. Press  or  to select “Add”, then press .
4. Enter the country code.
5. Press .
6. Enter the network code.
7. Press .
8. Enter a new network name.
9. Press  [OK].

Editing the Preferred List

To Change the Position of a Network in the Preferred List

1. Perform steps 1 to 4 in “Selecting a Network Automatically”.
2. Press  or  to select “Set Preferred”, then press .
3. Select the name of the network to change the position from the list by pressing  or , then press .

4. Press ▲ or ▼ to select “Insert” or “Add to End”, then press ●.

To Delete a Network from the Preferred List

1. Perform steps 1 to 3 in “To Change the Position of a Network in the Preferred List” on page 93.
2. Press ▲ or ▼ to select “Delete”, then press ●.

Changing the Network Password (M 7-3-2)

1. Perform steps 1 to 3 “Selecting a Network Automatically” on page 93.
2. Press ▲ or ▼ to select “Change Password”, then press ●.
3. Enter the old password, then press ●.
4. Enter a new password, then press ●.
5. Enter a new password again, then press ●.

If you enter the incorrect password in step 5, the screen will return to step 4 and you will be asked to enter the password again.

6. Press ●.

Selecting an Applicable Zone (M 7-3-3)

You need to select the applicable zone when using your phone in different area.

For America:

1. Perform steps 1 to 3 in “Selecting a Network Automatically” on page 93.
2. Press ▲ or ▼ to select “Zone Selection”, then press ●.
3. Press ▲ or ▼ to select “America”, then press ●.

For other countries, select “Europe, Asia, etc.”, then press ●.

Internet Settings (M 7-4)

WAP/MMS Settings

WAP Settings and MMS Settings can perform following various setups, respectively.

WAP Settings

Item	Description	Operation
Profile Name*	WAP Profile Name (Unique Name)	Select "Profile Name" and press . Enter the strings you like and press .
IP Address*	IP address	Select "IP Address" and press . Enter IP address for WAP and press .
Homepage	Homepage	Select "Homepage" and press . Enter Homepage URL, if needed, and press .
Port Number*	Security Option	Select "Port Number" and press . Enter Port Number (1024-65535) and press .

Item	Description	Operation
Circuit Prompt	Circuit Prompt	Select "Circuit Prompt" and press . Select "Enable" or "Disable" and press .
Connection Type	Bearer Connection Type	Select "Connection Type" and press . Select "GPRS Then CSD", "GPRS" or "CSD" and press .
GPRS Settings (If "GPRS Then CSD" or "GPRS" will be selected as connection type, they should be set)		
APN*	Access Point Name	Select "APN" and press . Enter Access Point Name and press .
UserName	User Name	Select "UserName" and press . Enter User Name and press .









Item	Description	Operation
Password	Password	Select "Password" and press <input type="radio"/> . Enter Password and press <input type="radio"/> .
Linger Time	Linger Time	Select "Linger Time" and press <input type="radio"/> . Enter second time (0-99999) and press <input type="radio"/> .
CSD Settings (If "GPRS Then CSD" or "CSD" will be selected as connection type, they should be set)		
Phone No.*	Access Point Number	Select "Phone No." and press <input type="radio"/> . Enter Access Point Number and press <input type="radio"/> .
Line Type	ISDN or Analogue	Select "Line Type" and press <input type="radio"/> . Select "ISDN" or "Analogue" and press <input type="radio"/> .
UserName	User Name	Select "UserName" and press <input type="radio"/> . Enter User Name and press <input type="radio"/> .











Item	Description	Operation
Password	Password	Select "Password" and press <input type="radio"/> . Enter Password and press <input type="radio"/> .
Linger Time	Linger Time	Select "Linger Time" and press <input type="radio"/> . Enter second time (0-99999) and press <input type="radio"/> .







*: Item to be set as mandatory.

MMS Settings

Item	Description	Operation
Profile Name*	MMS Profile Name (Unique Name)	Select "Profile Name" and press <input type="radio"/> . Enter the strings you like and press <input type="radio"/> .
IP Address*	IP address	Select "IP Address" and press <input type="radio"/> . Enter IP address for MMS and press <input type="radio"/> .

Item	Description	Operation
Relay Server URL*	MMS Relay Server	Select "Relay Server URL" and press  . Enter URL of the Relay Server and press  .
Port Number*	Security Option	Select "Port Number" and press  . Enter Port Number (1024-65535) and press  .
Connection Type	Bearer Connection Type	Select "Connection Type" and press  . Select "GPRS Then CSD", "GPRS" or "CSD" and press  .
GPRS Settings (If "GPRS Then CSD" or "GPRS" will be selected as connection type, they should be set)		
APN*	Access Point Name	Select "APN" and press  . Enter Access Point Name and press  .



















Item	Description	Operation
UserName	User Name	Select "UserName" and press  . Enter User Name and press  .
Password	Password	Select "Password" and press  . Enter Password and press  .
Linger Time	Linger Time	Select "Linger Time" and press  . Enter second time (0-99999) and press  .
CSD Settings (If "GPRS Then CSD" or "CSD" will be selected as connection type, they should be set)		
Phone No.*	Access Point Number	Select "Phone No." and press  . Enter Access Point Number and press  .
Line Type	ISDN or Analogue	Select "Line Type" and press  . Select "ISDN" or "Analogue" and press  .

Item	Description	Operation
UserName	User Name	Select "UserName" and press  . Enter User Name and press  .
Password	Password	Select "Password" and press  . Enter Password and press  .
Linger Time	Linger Time	Select "Linger Time" and press  . Enter second time (0-99999) and press  .







*: Item to be set as mandatory.

To Set up your Account Information

This information should be supplied by your Internet service provider.













1. Press  to display the Main Menu.
2. Press  or  to select "Settings", then press .
3. Press  or  to select "Internet Settings", then press .
4. Press  or  to select "WAP Settings" or "MMS Settings", then press .
5. Select the profile name you wish to edit by pressing  or , then press .
6. Press  or  to select "Edit", then press .
7. Select the item you wish to edit, then press .
8. Edit each item.
9. When you have finished editing, select "Setup End", then press .

To Select Network Connection Profile

1. Perform steps 1 to 4 in "To Set up your Account Information".
2. Select the profile name to use by pressing  or , then press .
3. Press  or  to select "Activate", then press .

WAP Push Setting (M 7-4-3)

You can select whether to accept the information supplied by your Internet service provider or not.











1. Press  to display the Main Menu.
2. Press  or  to select “Settings”, then press .
3. Press  or  to select “Internet Settings”, then press .
4. Press  or  to select “WAP Push Setting”, then press .
5. Press  or  to select “Allow” or “Reject”, then press .

Tip

- To cancel the information supply, select “Reject”, then press .

Infrared (M 7-5)

You can use the built-in infrared modem to establish contact between your phone and a PC equipped with an infrared port.

1. Press  to display the Main Menu.
2. Press  or  to select “Settings”, then press .
3. Press  or  to select “Infrared”, then press .
4. Press  or  to select “On”, then press .















“” will appear on the screen.

The infrared setting will return to off when no data is transmitted/received via infrared communication.

Security (M 7-6)

Enabling/Disabling the PIN Code (M 7-6-1)

If the PIN code is enabled you will be asked to enter the PIN code each time the phone is switched on. Your PIN code is stored on the SIM and you should have been made aware of the code when you purchased the SIM. Contact your service provider for further details.









1. Press  to display the Main Menu.
2. Press  or  to select “Settings”, then press .
3. Press  or  to select “Security”, then press .
4. Press  or  to select “PIN Entry”, then press .
5. Press  or  to select “On” or “Off”, then press .
6. Enter your PIN code, then press .

Note

- *If you enter the wrong PIN code three times in step 6, the SIM will lock. To remove the lock, contact your service provider/SIM vendor.*

Changing PIN Code



This allows you to change the PIN code stored on the SIM.

1. Perform steps 1 to 3 in “Enabling/Disabling the PIN Code”.
2. Press  or  to select “PIN Entry”, then press .
3. Press  or  to select “Change PIN”, then press .
4. Enter the existing PIN code, then press .
5. Enter a new PIN code, then press .
6. Enter a new PIN code again, then press .

If you enter a code different from the code which you entered in step 6, the screen returns to step 5. Enter the correct code again.

Handset Lock (M 7-6-2)

The Handset Lock is an additional security feature which prevents unauthorised use of the phone or certain features. The default Handset Lock code is “0000”.

1. Perform steps 1 to 3 in “Enabling/Disabling the PIN Code”.
2. Press  or  to select “Handset Lock”, then press .

3. Press ▲ or ▼ to select “On” or “Off”, then press ●.
4. Enter your handset code, then press ●.
If you enter an incorrect handset code, the screen will clear and you will be prompted to enter the code again.

Changing Handset Code

The default handset code is “0000”.

1. Perform steps 1 to 2 in “Handset Lock” on page 100.
2. Press ▲ or ▼ to select “Change Code”, then press ●.
3. Enter the old handset code, then press ●.
4. Enter a new handset code, then press ●.
5. Enter a new handset code again, then press ●.
If you enter a code different from the code which you entered in step 5, the screen returns to step 4. Enter the correct code again.

Changing PIN2 Code (M 7-6-3)

PIN2 code is used to protect certain functions in the phone such as Fixed Dialling No. and call cost limits. The following shows you how to change PIN2 code.



1. Perform steps 1 to 3 in “Enabling/Disabling the PIN Code” on page 100.
2. Press ▲ or ▼ to select “Change PIN2”, then press ●.
3. Enter the existing PIN2 code, then press ●.
4. Enter a new PIN2 code, then press ●.
5. Enter a new PIN2 code again, then press ●.
If you enter a code different from the code which you entered in step 5, the screen returns to step 4. Enter the correct code.

Call Barring (M 7-6-4)

This function lets you place restrictions on incoming and outgoing calls. To activate Call Barring you will need the call barring password, which will be available from your service provider.

1. Perform steps 1 to 3 in “Enabling/Disabling the PIN Code” on page 100.
2. Press ▲ or ▼ to select “Call Barring”, then press ●.
3. Press ▲ or ▼ to select call barring option, then press ●.



The call barring functions available are:

- “Bar Foreign Calls”: Restricts all outgoing international calls.
 - “Only Local & Home”: Restricts all outgoing international calls except to your home country.
 - “Bar Incoming Calls”: Restricts all incoming calls.
 - “Bar Inc. if Abroad”: Restricts all incoming calls when you are outside of the coverage from your registered network operator.
 - “Bar Outgoing Calls”: Restricts all outgoing calls except emergency calls.
4. Select one of the call barring options by pressing  or , then press .





The call barring options available are:

- “All Services”: Restricts all services.
 - “Voice Calls”: Restricts all voice calls.
 - “Data”: Restricts all data calls.
 - “Fax”: Restricts all fax calls.
 - “Messages”: Restricts all messages.
 - “All except Msgs.”: Restricts all services except messages.
5. Select “On”, then press .





If you select “Off”, the selected call barring setting is cancelled.

6. Enter the network password, then press .
- To change the network password, see “Changing the Network Password” on page 94.
7. Press  [OK].
- The selected call barring function is activated.
- If you enter a wrong network password, the entered password is cleared. Enter the correct the password.







Checking Call Barring Status

1. Perform steps 1 to 4 in “Call Barring” on page 101.
 2. Press  or  to select “Status”, then press .
- Now you can check the status of the selected call barring option.
3. When you finish the confirmation, press  [Back].

Cancel All Call Barring Settings

1. Perform steps 1 to 2 in “Call Barring” on page 101.
 2. Press  or  to select “Cancel All”, then press .
 3. Enter the network password, then press .
 4. Press  [OK].
- All call barring settings are cancelled.

To Cancel the Call Barring Setting Individually







1. Perform steps 1 to 3 in “Call Barring” on page 101.
2. Select the call barring option you wish to cancel by pressing  or , then press .
3. Press  or  to select “Off”, then press .
4. Enter the Barring password, then press .

The selected call barring setting is cancelled.

Fixed Dialling No. (M 7-6-5)

When the Fixed Dialling No. is enabled, you can call to only predefined numbers.







Enabling Fixed Dialling No.

1. Perform steps 1 to 3 in “Enabling/Disabling the PIN Code” on page 100.
2. Press  or  to select “Fixed Dialling No.”, then press .
3. Enter a PIN2 code, then press .
4. Select “Settings”, then press .
5. Select “On”, then press .

If you select “Off”, Fixed Dialling No. is disabled.



Adding a New Name

1. Perform steps 1 to 3 in “Enabling Fixed Dialling No.”

2. Press  or  to select “Edit Dial List”, then press .
3. Press .
4. Press  or  to select “Add New Name”, then press .
5. Add a name and a phone number.





For details on adding a name and a phone number, see “Storing Names and Numbers” on page 26.

Searching a Registered Name

1. Perform steps 1 to 3 in “Adding a New Name”.
2. Press  or  to select “Search”, then press .
3. Search for the desired name.





For details on searching a name, see “Finding a Name and Number” on page 28.

Editing a Registered Name

1. Perform steps 1 and 2 in “Adding a New Name” on page 103.
2. Select a name you wish to edit, then press .
3. Press  or  to select “Edit”, then press .
4. Edit the selected name.

For details on editing a name, see “Editing Phonebook Entries” on page 28.

Deleting a Registered Name













1. Perform steps 1 and 2 in “Adding a New Name” on page 103.
2. Select a name you wish to delete, then press .
3. Press  or  to select “Delete”, then press .
4. Select “Yes”, then press .

The selected name will be deleted.

To cancel deletion, select “No” at step 4, then press .

Master Reset (M 7-7)

The settings can be reset to their default settings.

1. Press  to display the Main Menu.
 2. Press  or  to select “Settings”, then press .
 3. Press  or  to select “Master Reset”, then press .
 4. Enter your handset code, then press .
 5. Press  or  to select “Yes”, then press .
- To cancel resetting, select “No” at step 5, then press .
- All settings are reset.

Note

- If you enter a wrong handset code in step 4, operation is cancelled.

Vodafone live!

Your phone contains a WAP browser used for surfing on the Mobile Internet, where you can get a lot of useful information. Normally, pages are designed for a mobile phone.

Your phone is already setup to Vodafone site for WAP/MMS Settings.

BROWSER BY



OPENWAVE



Viewing the WAP Browser

1. Press [] during stand-by.
2. Select the menu you wish to view by pressing or , then press .

To Exit the WAP Browser

1. Press to exit the browser.

Navigating a WAP Page

- :
Move the highlights around in the screen.
- / : Used to select an action displayed in the lower left corner of the screen.
- : Used to select an action displayed in the lower right corner of the screen.
- (press and hold):
Used to start the Go to URL.
- to (press and hold):
Used to start the Bookmark (WAP).
- : Exit (short press)
Turn off the phone. (press and hold)
- : Launch browser option menu.

Browser Menu

When you have started browsing, you can reach browsing options by pressing .

The Browser Menu contains the following:

Back: Go to the previous screen.

Home: Go to the homepage you set in the WAP Settings.

Bookmarks: Add the site you are currently browsing to your list of bookmarks, or see the list of bookmarks.

Go to URL: Input the URL of the site you wish to go, and go to the site.

Show URL: Display the URL you are currently browsing.

SnapShots: Save the page you are currently browsing to your list of Snap Shots, or see the list of Snap Shots.

Save Items: Save images or sounds to the My Pictures or My Sounds.

Alert Inbox: See the list of WAP push messages. You can receive push messages via WAP Services. This means that a service provider sends WAP content to your phone, without any set up.

Reload: Refresh the contents of the WAP page.

Settings: Includes “Restart Browser”, some settings, etc.

Messages

Your phone allows you to send and receive short messages, MMS and WAP mails.

MMS (Multimedia Messaging Service)







About MMS

MMS allows you to further personalise your messages with pictures, sounds and animations.

Note

- *Some MMS functions may not always be available depending on your network. Contact your network operator for more information.*

Setting up MMS (M 0-1-5)

1. Press  [] during stand-by.
2. Select “MMS”, then press .
3. Press  or  to select “Settings”, then press .
4. Select the desired item to set, then press .







The items available are:

- “Roam. Download”
- “Delivery Report”
- “Delivery Rep. Allow”
- “Expiry Time”
- “Sender Visibility”
- “Anonymous Reject”
- “Slide Interval”





5. Edit the each item.

6. When you finish setting, press  [Back].

Creating a New MMS (M 0-1-1)

1. Press  [] during stand-by.
2. Select “MMS”, then press .
3. Select “Compose”, then press .
4. Enter your message, then press .
5. Enter phone number or E-mail address of the recipient, then press .

If you wish to select the phone number or E-mail address in the Phonebook, search for the desired Phonebook entry.

Press  or  [Search] to search the number by name or press  or  to search in alphabetical

order, then press . For details on searching the Phonebook entries, see “Finding a Name and Number” on page 28.

6. Select “Send”, then press .

The confirmation screen of file size is displayed.



7. Select “Yes”, then press .

After the message has been sent, the message is added to the Sent box.











Note

- *This phone allows you to enter up to 256 characters as a subject, and enter up to 10 addresses of the recipients for sending MMS. However, these may be limited depending on your network. In this case, you may be failed to send MMS. Contact your network operator for more information.*







To Enter the Subject of the Message

1. Perform steps 1 to 3 in “Creating a New MMS” on page 107.
2. Press  [Options] to display the Options Menu.
3. Select “Subject”, then press .
4. Enter the subject of your message, then press .

To Add Recipients



1. Perform steps 1 to 5 in “Creating a New MMS” on page 107.
2. Press  or  to select “Add address”, then press .
3. Select “To” to add recipients or “Cc” to send a copy of this MMS to other recipients by pressing  or , then press .
4. Select a desired number from the list by pressing  or , then press .
5. Enter the phone number or E-mail address of the other recipients, then press .
6. Press  [Back] twice.

To Use the Text Template

1. Perform steps 1 to 3 in “Creating a New MMS” on page 107.
2. Press  [Options] to display the Options Menu.
3. Press  or  to select “Insert Template”, then press .
4. Select the desired template from the list by pressing  or , then press .

To Save a Message in the Drafts Box







You can save a message in the Drafts box temporarily and send it later, without sending it immediately.

1. Perform steps 1 to 5 in “Creating a New MMS” on page 107.
2. Press  or  to select “Save”, then press  to save the message in the Drafts box.

Note

- You can send it later following the instructions in “Sending a Message in the Drafts Box”.

Turning the Slide Show Setting On or Off

1. Perform steps 1 to 3 in “Creating a New MMS” on page 107.
2. Press  [Options] to display the Options Menu.
3. Press  or  to select “Slide Show”, then press .
4. Press  or  to select “On” or “Off”, then press .

If You Select “On”

- You can create messages which have up to 3 slides. Each slide can contain one picture/image, one sound file and up to 512 characters of text (up to the message total 30kb limit).









- The slide options available are:
 - Add Slide: To add a new slide.
 - Delete Slide: To delete the active slide.
 - Previous Slide: To navigate to the previous slide.
 - Next Slide: To navigate to the next slide.
- EVA data cannot be attached as a slide data to a message.

If You Select “Off”







- You can attach a maximum of 6 pictures/images or sounds in all.
- EVA data cannot be attached as a slide data to a message.

Inserting Attached Data









You can send pictures/images and sounds saved in the Saved Pictures or Saved Sounds attached to MMS.

1. Perform steps 1 to 3 in “Creating a New MMS” on page 107.
2. Press  [Options] to display the Options Menu.
3. Press  or  to select “Picture” or “Sound”, then press .
4. Select the file name you wish to attach by pressing  or , then press .
The selected picture/sound is attached.
5. Press .











To Add Attached Data

1. Perform step 1 to 3 in “Inserting Attached Data” on page 109.
The list of attached data is displayed.
2. Select the file name you wish to add by pressing  or , then press  [Options].
3. Press  or  to select “Add Picture” or “Add Sound”, then press .
4. Perform steps 4 and 5 in “Inserting Attached Data” on page 109.

To Delete Attached Data

1. Perform steps 1 to 3 in “Inserting Attached Data” on page 109.
The list of attached data is displayed.
2. Select the file name you wish to delete by pressing  or , then press  [Options].
3. Press  or  to select “Remove”, then press .
4. Press  or  to select “Yes”, then press .

Sending a Message in the Drafts Box





1. Perform steps 1 and 2 in “Creating a New MMS” on page 107.
 2. Press  or  to select “Drafts”, then press .
 3. Select the desired message to send in the Drafts box by pressing  or , then press  [Options].
The Options Menu is displayed.
 4. Press  or  to select “Send”, then press .
 5. Select “Yes”, then press .
- The phone begins the sending process and the MMS is sent.







Reading MMS (M 0-1-2)

Messages you receive are stored in the Inbox, and outgoing messages are stored in the Drafts box until you send them, after which they move to the Sent box.





Incoming Messages

The MMS indicator () will appear when you are receiving an incoming message.











1. Perform steps 1 and 2 in “Creating a New MMS” on page 107.
 2. Press  or  to select “Inbox”, then press .
- Messages are marked with “” denote mails with attachments.

3. Press  or  to select the desired message, then press .
The message is displayed.
4. Scroll the screen by pressing  or  to read the message.
5. When you finish viewing, press  [Done].

To Check the Sender and Receiver Phone Number or E-mail Address

1. Perform steps 1 to 3 in “Incoming Messages” on page 110.
2. Press  [Options] to display the Options Menu.
3. Press  or  to select “Details”, then press .
The sender’s phone number or E-mail address, time and date stamp, subject, attachment and size are displayed.





Replying to a Message to the Sender from Inbox

1. Perform steps 1 and 2 in “Creating a New MMS” on page 107.
2. Press  or  to select “Inbox”, then press .
3. Press  [Options] to display the Options Menu.
4. Press  or  to select “Reply”, then press .
5. Enter your message.
For details on entering characters, see “Entering Characters” on page 24.
6. Press .
The phone number or E-mail address of the recipient is automatically filled in the sender’s phone number or E-mail address.
7. Press .
The subject field is automatically filled in with the original subject preceded by “Re:”.
8. Select “Send”, then press .
The confirmation screen of file size is displayed.
9. Select “Yes”, then press .





Tip



- You can reply to a message to all addresses of selected messages by selecting “Reply All” in step 5.

Forwarding a Message

1. Perform steps 1 to 3 in “Replying to a Message to the Sender from Inbox” on page 111.
2. Press  or  to select “Forward”, then press .
3. Enter phone number or E-mail address of the recipient, then press .

If you wish to select the phone number or E-mail address in the Phonebook, search for the desired Phonebook entry.





Press  or  [Search] to search the number by name or press  or  to search in alphabetical order, then press . For details on searching the Phonebook entries, see “Finding a Name and Number” on page 28.

4. Select “Send”, then press .
The confirmation screen of the file size is displayed.
5. Select “Yes”, then press .

Note

- *When the message with attached data is forwarded the data is also sent. However, if there is any material which the phone recognises as having copyright, it will not be sent.*
- *“Subject” field is automatically filled in with the original subject preceded by “Fw:”.*
The original message and subject cannot be changed.



Modifying a Message

1. Perform steps 1 to 3 in “Replying to a Message to the Sender from Inbox” on page 111.
2. Select “Edit”, then press .
3. Modify the message.
4. Press .
5. Select “Send”, then press .
The confirmation screen of the file size is displayed.
6. Select “Yes”, then press .

Note









- *Messages cannot be edited if they contain particular data such as Slide Show, XHTML, copyrights or unknown format.*

Storing the Phone Number or E-mail Address of a Sender in the Phonebook













1. Perform steps 1 to 3 in “Replying to a Message to the Sender from Inbox” on page 111.
2. Press  or  to select “Save to Phonebook”, then press .
For details on entering a name, see “Storing Names and Numbers” on page 26.

Retrieving MMS

When “

1. Perform steps 1 and 2 in “Creating a New MMS” on page 107.
2. Press  or  to select “Inbox”, then press .
3. Press  or  to select a desired alert to download.
4. Press  to display the Alert Menu.
5. Press  or  to select “Download”, then press .

Deleting Messages

1. Perform steps 1 and 2 in “Creating a New MMS” on page 107.
2. Press  or  to select “Inbox”, “Drafts” or “Sent”, then press .
3. Select the message you wish to delete by pressing  or , then press  [Options].
The Options Menu is displayed.
4. Press  or  to select “Delete Message”, then press .
5. Press  or  to select “One Message” or “All Messages”, then press .









6. Select “Yes”, then press .

To cancel deletion, select “No”, then press .

Note





- You cannot delete locked messages.

To Lock Message

1. Perform steps 1 and 2 in “Creating a New MMS” on page 107.
2. Press  or  to select “Inbox” or “Sent”, then press .
3. Select the message you wish to lock by pressing  or , then press  [Options].
The Options Menu is displayed.
4. Press  or  to select “Lock/Unlock”, then press .

Making a Call to the Sender of a Message

You can make a call to the sender of a message in Inbox whose address (From) is the phone number.

1. Perform steps 1 and 2 in “Replying to a Message to the Sender from Inbox” on page 111.
2. Press  [Options] to display the Options Menu.
3. Press  or  to select “Call”, then press .

SMS (Short Message Service)

About SMS

The Short Message Service (SMS) allows you to send text messages of up to 1024 characters to other GSM users.

Using SMS with Your Phone

Messages longer than 160 characters may be composed. During sending, the messages will be split. If the receiver has a suitable phone the messages will recombine during reception, if not your message will appear as a number of separate 152 characters messages.





You can send or receive SMS even if you are talking on the phone.







You can also use My Text Templates to help you compose SMS.

Setting up SMS (M 0-2-4)

Before you can use SMS to send and receive messages, you have to set up some personal and system information.

To set up the Service Centre Address







1. Press  [] during stand-by to display the Message menu.
2. Press  or  to select “SMS”, then press .

3. Press  or  to select “Settings”, then press .
4. Select “Message Centre”, then press .
5. Enter the centre number.
If you wish to enter a country code for a message to an international number, press and hold  until a “+” sign appears.
6. Press .



Validity Period



This indicates the number of days and hours for which a message you send may remain undelivered to the message recipient.

During this period, the message service centre will continually try to deliver the message to the recipient.







1. Perform steps 1 to 3 in “Setting up SMS”.
2. Press  or  to select “Message Lifetime”, then press .
3. Select the validity period by pressing  or , then press .

Message Format

1. Perform steps 1 to 3 in “Setting up SMS”.
2. Press  or  to select “Message Format”, then press .

3. Select the message format by pressing  or , then press .

Connection Type







1. Perform steps 1 to 3 in “Setting up SMS” on page 114.
2. Press  or  to select “Connection Type”, then press .
3. Select the connection type by pressing  or , then press .

Optimisation







When set “On” (default), double-byte characters such as European characters with an accent will be converted into single-byte characters and sent.

When “Off”, double-byte characters will be sent as displayed.







Please note that you may be charged double for double-byte characters sent in an SMS when Optimisation is set “Off”.

1. Perform steps 1 to 3 in “Setting up SMS” on page 114.
2. Press  or  to select “Optimisation”, then press .
3. Press  or  to select “On” or “Off”, then press .





Creating a New SMS (M 0-2-1)

1. Press  [] during stand-by.
2. Press  or  to select “SMS”, then press .
3. Select “Compose”, then press .
4. Enter your message.
For details on entering characters, see “Entering Characters” on page 24.
5. Press .









To Use the Text Template

1. Perform steps 1 to 3 in “Creating a New SMS”.
2. Press  [Options] to display the Options Menu.
3. Press  or  to select “Insert Template”, then press .
4. Select the desired template from the list by pressing  or , then press .

To Save the Message in the Outbox

1. Perform steps 1 to 5 in “Creating a New SMS”.
2. Enter the SMS phone number of the recipient, then press .
3. Press  or  to select “Save”, then press .







Sending a Message

1. Perform steps 1 to 5 in “Creating a New SMS” on page 115.
2. Enter the SMS phone number of the recipient, then press .
3. If you wish to select the SMS phone number in the Phonebook, search for the desired Phonebook entry. Press  or  [Search] to search the number by name or press  or  to search in alphabetical order, then press . For details on searching the Phonebook entries, see “Finding a Name and Number” on page 28.
4. Press  or  to select “Send”, then press . The phone begins the sending process and the SMS is sent.





Reading SMS

Incoming Messages

The SMS indicator () will appear when an incoming message arrives.

1. When you receive a SMS, press  during stand-by.
2. Press  or  to select the desired message. The sender’s phone number and a part of the message are displayed. When the sender’s phone number is stored in the Phonebook, the sender’s name is displayed instead of the phone number. Messages are marked with “.
4. Scroll the screen by pressing  or  to read the message.
5. When you have finished viewing, press .

Replying to the Sender

1. Perform steps 1 to 3 in “Reading SMS”.
2. Press  [Options] to display the Options Menu.
3. Press  or  to select “Reply”, then press .





4. Enter your message.

For details on entering characters, see “Entering Characters” on page 24.





5. Press .

Follow the procedure from step 2 in “Sending a Message” on page 116.



Calling the Message Sender

1. Perform steps 1 to 3 “Reading SMS” on page 116.
2. Press  [Options] to display the Options Menu.
3. Press  or  to select “Call Sender”, then press .

Forwarding a Message









1. Perform steps 1 to 3 in “Reading SMS” on page 116.
2. Press  [Options] to display the Options Menu.
3. Press  or  to select “Forward”, then press .
4. Enter the SMS phone number of the recipient, then press .

For details on searching the Phonebook entries, see “Finding a Name and Number” on page 28.

5. Press  or  to select “Send”, then press .













The phone begins the sending process and the SMS is sent.

Modifying a Message

1. Perform steps 1 and 2 in “Creating a New SMS” on page 115.
2. Press  or  to select “Outbox”, then press .
3. Select the desired message to modify in the Outbox by pressing  or , then press .
4. Press  [Options] to display the Options Menu.
5. Select “Edit”, then press .
6. Modify the message, then press .









Follow the procedure from step 2 in “Sending a Message” on page 116.

Deleting Messages

1. Perform steps 1 and 2 in “Creating a New SMS” on page 115.
 2. Press  or  to select “Inbox” or “Outbox”, then press .
 3. Select the message you wish to delete by pressing  or , then press .
 4. Press  [Options] to display the Options Menu.
 5. Press  or  to select “Delete”, then press .
 6. Press  or  to select “Yes”, then press .
- The selected message is deleted.

Extracting Phone Numbers from the Received Messages and making a call

you can make a call using a telephone number embedded in the received SMS message.

1. Perform steps 1 and 2 in “Reading SMS” on page 116.
2. Press  [Options] to display the Options Menu.
3. Press  or  to select “Extract Numbers”, then press .
Any kinds of numbers are listed.
4. Press  or  to select the telephone number, then press .
5. To make a call, press .
To save this telephone number in the phonebook, press  [Save].
For details on entering a name, see “Storing Names and Numbers” on page 26.

Tip











- Selecting “Save to phonebook” in step 3 instead allows you to go to the phone number entry prompt with the sender’s number entered.
For details on entering a name, see “Storing Names and Numbers” on page 26.

Cell Broadcast (M 0-3)





You can receive Cell Broadcast messages or general messages like weather reports, traffic reports, etc. broadcast to all subscribers in a certain network area.

This function may not be available on all mobile phone networks. Contact your network operator for more information.

Enabling/Disabling Cell Broadcast (M 0-3-1)















1. Press  [] during stand-by.
2. Press  or  to select “Cell Broadcast”, then press .
3. Press  or  to select “On/Off”, then press .
4. Select “On” to set Cell Broadcast on or “Off” to set it off by pressing  or , then press .

Reading Cell Broadcast Messages (M 0-3-2)

1. When you receive a Cell Broadcast message, press .
2. Scroll the screen by pressing  or  to read the message.
3. When you finish viewing, press .

Subscribing to Cell Broadcasts

Select the page of the cell broadcast message that you want.

1. Press  [] during stand-by.
2. Press  or  to select “Cell Broadcast”, then press .
3. Press  or  to select “Settings”, then press .
4. Press  or  to select “Set Info Subjects”, then press .
5. Press  or  to select “Create Subject”, then press .
6. Press  to add the channel.
7. Enter the appropriate channel code obtained from your service provider, and a title for the channel.

Setting Languages

Allows you to select your preferred language for the cell broadcast message display.

Cell Information (M 0-4)









The Cell Information is the message information that operators sent to subscribers in certain areas.

When you receive Cell Information, the message will be displayed on the stand-by screen.

Note

- *This function may not be available on all mobile phone networks. Contact your network operator for more information.*

Enabling/Disabling Cell Information

1. Press  [] during stand-by.
2. Press  or  to select “Cell Info”, then press .
3. Press  or  to select “On” or “Off”, then press .

Note

- *If Cell Information is set to “On”, the Stand-by Time will decrease.*

Data Transmission

Your PC can be set up to use the GX10i as a modem. You can either use Infrared (IrDA) or a data cable “XN-1DC10” (option) to connect to the PC.

Refer to XN-1DC10 attached manual for the connection method of a data cable.

System Requirements

OS: Windows®98*, Windows®Me,
Windows®2000, Windows®XP

* Windows®98 Second Edition, or Windows®98 + Internet Explorer 5.01 or later

Interface: Infrared (IrDA) or Serial port (D-sub 9-pin connector)

CD-ROM drive

Software Installation and Setup

1. Install Modem setup software from the included CD-ROM.
 - Insert the CD-ROM and double-click [setup.exe] to start installation.
 - Follow the instructions on the screen to complete installation.

When installation has completed, “SHARP GSM GPRS” icon appears in the control panel.

When you perform the following operations (step 2 to 4), refer to GSM/GPRS Modem Option Help after executing [SHARP GSM GPRS] in the control panel.

2. Install Modem driver.
3. Make the Dial-up connection.
4. Set GSM/GPRS Modem Option which is stored in the control panel.

If you wish to use GSM, fill the GSM connection column.

If you wish to use GPRS, fill the GPRS connection column.

Note

- *Modem setup software may not run on certain PCs.*

Using the Modem Setup

The software in the CD-ROM supplied is provided based on the END USER LICENSE AGREEMENT, and can be used and duplicated only in compliance with the conditions of the pertinent END USER LICENSE AGREEMENT.

The software installer displays the END USER LICENSE AGREEMENT upon startup.

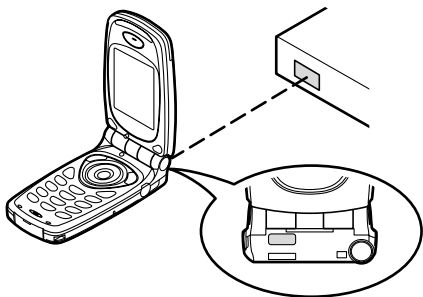

- When using the infrared modem function for executing data transmission, align the infrared port with each other.

Note

- *The distance between the infrared ports which can communicate is a maximum of 20 cm within a 30° angle.*
- *When transmitting data via infrared communication, you need to set the infrared setting to “On”. (p. 99)*
- *It is not recommended that you make or answer a call during data transmission. The operation may be interrupted.*

Transmitting Picture/Image Files

By installing software for data transmission into your PC, you can transmit picture/image files between your phone and a PC.

The data cable (RS232C) “XN-1DC10” (option) is necessary for connection to a PC.

Download software for data transmission from the download page in the following site.

<http://www.sharp-mobile.com>

Note

- *Some large picture/image files may not be able to be transmitted from the PC to the phone.*

Troubleshooting

Problem	Solution
The phone does not turn on.	<ul style="list-style-type: none"> • Make sure the battery is properly inserted and charged.
PIN code or PIN2 code is rejected.	<ul style="list-style-type: none"> • Make sure you have entered the correct code (4 to 8 digits). • Your SIM card/protected functions will become locked after 3 unsuccessful attempts. • Contact your SIM provider if you do not have the correct PIN code.
SIM card becomes locked.	<ul style="list-style-type: none"> • Enter PUK code (8 digits) provided by your service provider (if supported). • If the attempt is successful, enter the new PIN code and confirm your phone is operational again. Otherwise contact your dealer.
The display is difficult to read.	<ul style="list-style-type: none"> • Adjust the LCD contrast.

Problem	Solution
Phone functions do not work after the phone is turned on.	<ul style="list-style-type: none"> • Check the radio signal strength indicator as you may be outside the service area. • Check to see if any error message is displayed when you turn your phone on. If so, contact your dealer. • Make sure the SIM card is correctly inserted.
Calls cannot be made or received.	<ul style="list-style-type: none"> • If the message "SIM Card Error" is displayed at start-up, you cannot use your SIM card or SIM card is damaged. Contact your dealer or network service provider. • Check your call barring, fixed dialling setting, remaining battery and call forwarding settings. • Check if your phone is currently performing data communication using Infrared (IrDA) or a data cable. • Check the remaining balance if you are using a pre-paid SIM card.

Problem	Solution
Call quality is poor.	<ul style="list-style-type: none"> Your current location may not provide good call quality (i.e., in a car or train). Move to a location where radio signal strength is greater.
Cannot access network service.	<ul style="list-style-type: none"> Check where your account has been registered and where the service is available.
Cannot send or receive SMS.	<ul style="list-style-type: none"> Make sure you are correctly subscribed for the Short Message Service, that the network supports this service, and that the centre number is set up correctly. If not, contact your network service provider.
Cannot connect to MMS service provider.	<ul style="list-style-type: none"> MMS settings and configuration may be missing or incorrect or network does not support it. Check your service provider's access point number. Contact your service provider to confirm the correct settings.

Problem	Solution
Limited memory available.	<ul style="list-style-type: none"> Delete any unnecessary data.

Safety Precautions and Conditions of Use

FCC Declaration of Conformity

Dual-band phone: GX10i with PC/Data interface cable XN-1DC10

This device complies with part 15 of the FCC Rules.

Operation is subject to the following two conditions:

- (1) This device may not cause harmful interference, and
- (2) this device must accept any interference received, including interference that may cause undesired operation.

Responsible Party:

SHARP ELECTRONICS CORPORATION
Sharp Plaza, Mahwah, New Jersey 07430
TEL: 1-800-BE-SHARP

Tested To Comply With FCC Standards
FOR HOME OR OFFICE USE



FCC Notice

The phone may cause TV or radio interference if used in close proximity to receiving equipment. The FCC can require you to stop using the phone if such interference cannot be eliminated.

Information To User

This equipment has been tested and found to comply with the limits of a Class B digital device, pursuant to Part 15 of the FCC Rules. These limits are designed to provide reasonable protection against harmful interference in a residential installation. This equipment generates, uses and can radiate radio frequency energy and, if not installed and used in accordance with the instructions, may cause harmful interference to radio communications.

However, there is no guarantee that interference will not occur in a particular installation; if this equipment does cause harmful interference to radio or television reception, which can be determined by turning the equipment off and on, the user is encouraged to try to correct the interference by one or more of the following measures:

1. Reorient/Relocate the receiving antenna.
2. Increase the separation between the equipment and receiver.
3. Connect the equipment into an outlet on a circuit different from that to which the receiver is connected.
4. Consult the dealer or an experienced radio/TV technician for help.

CAUTION: Changes or modifications not expressly approved by the manufacturer responsible for compliance could void the user's authority to operate the equipment.

Exposure to Radio Waves

THIS MODEL PHONE MEETS THE GOVERNMENT'S REQUIREMENTS FOR EXPOSURE TO RADIO WAVES.

Your wireless phone is a radio transmitter and receiver. It is designed and manufactured not to exceed the emission limits for exposure to radio frequency (RF) energy set by the Federal Communications Commission of the U.S. Government. These limits are part of comprehensive guidelines and establish permitted levels of RF energy for the general population. The guidelines are based on standards that were developed by independent scientific organizations through periodic and thorough evaluation of scientific studies. The standards include a substantial safety margin designed to assure the safety of all persons, regardless of age and health.

The exposure standard for wireless mobile phones employs a unit of measurement known as the Specific Absorption Rate, or SAR. The SAR limit set by the FCC is 1.6W/kg.* Tests for SAR are conducted using standard operating positions specified by the FCC with the phone transmitting at its highest certified power level in all tested frequency bands. Although the SAR is determined at the highest certified power level, the

actual SAR level of the phone while operating can be well below the maximum value. This is because the phone is designed to operate at multiple power levels so as to use only the power required to reach the network. In general, the closer you are to a wireless base station antenna, the lower the power output.

Before a phone model is available for sale to the public, it must be tested and certified to the FCC that it does not exceed the limit established by the government-adopted requirement for safe exposure. The tests are performed in positions and locations (e.g., at the ear and worn on the body) as required by the FCC for each model. The highest SAR value for this model phone when tested for use at the ear is 0.52 W/kg and when worn on the body, as described in this user guide, is 0.43 W/kg. Body-worn Operation; This device was tested for typical body-worn operations with the back of the phone kept 1.5 cm from the body. To maintain compliance with FCC RF exposure requirements, use accessories that maintain a 1.5 cm separation distance between the user's body and the back of the phone. The use of belt-clips, holsters and similar accessories should not contain metallic components in its assembly.

The use of accessories that do not satisfy these requirements may not comply with FCC RF exposure requirements, and should be avoided.

While there may be differences between the SAR levels of various phones and at various positions, they all meet the government requirement for safe exposure.

The FCC has granted an Equipment Authorization for this model phone with all reported SAR levels evaluated as in compliance with the FCC RF emission guidelines. SAR information on this model phone is on file with the FCC and can be found under the Display Grant section of <http://www.fcc.gov/oet/fccid> after searching on FCC ID APYHRO00029.

Additional information on Specific Absorption Rates (SAR) can be found on the Cellular Telecommunications Industry Association (CTIA) web-site at <http://www.wow-com.com>.

* In the United States and Canada, the SAR limit for mobile phones used by the public is 1.6 watts/kg (W/kg) averaged over one gram of tissue. The standard incorporates a substantial margin of safety to give additional protection for the public and to account for any variations in measurements.