

Abridged English Manual

For more information about handset operations and functions, please go to the Vodafone K.K. Website (www.vodafone.jp) for the full manual* or dial 157 from a Vodafone handset for Customer Service.

* Please note, full English manual was created for Sharp 703, sold in the UK, and thus may include information/features specific to that model and exclude Japan-specific services, etc.

Accessories

■ Lithium-ion Battery (Type 1) (SHBAA1)*

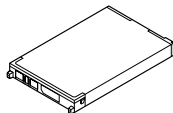

■ Headphones

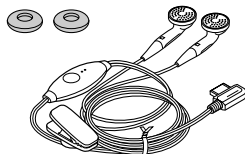

■ AC Charger (SHCAA1)*

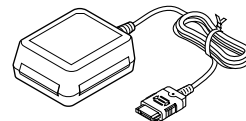

■ Utility Software (CD-ROM)

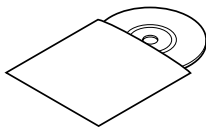

* May also be purchased separately.

- Tip** ►
- For accessory-related information, please contact Vodafone Customer Centre, General Information (☎ P.18-44).
 - 703SHf is compatible with miniSD™ Memory Card; miniSD™ Memory Card is not included in this package. Purchase miniSD™ Memory Card to use Memory Card-related handset functions.



Safety Precautions



- Read safety precautions before using handset.
- Observe precautions to avoid injury to self or others, or damage to property.
- Vodafone is not liable for any damages resulting from use of this product.

Before Using Handset

■ Symbols



Make sure you thoroughly understand these symbols before reading on. Symbols and their meanings are described below:

 DANGER	Great risk of death or serious injury from improper use
 WARNING	Risk of death or serious injury from improper use
 CAUTION	Risk of injury or damage to property from improper use



	Prohibited Actions
	Compulsory Actions
	Attention Required

DANGER

Handset, Battery & Charger

-  **Use only the specified battery, Charger or Holder.**
Using non-specified equipment may cause malfunctions, electric shock or fire due to battery leakage, overheating or bursting.
-  **Do not short-circuit Charger Terminals.**
Keep metal objects away from Charger Terminals. Keep handset away from jewellery. Battery may leak, overheat, burst or ignite causing injury. Use a case to carry handset.





Battery

-  **Prevent injury from battery leakage, breakage or fire. Do not:**
 - Heat or dispose of battery in fire.
 - Disassemble, modify or break battery.
 - Damage or solder battery.
 - Use a damaged or deformed battery.
 - Use non-specified charger.
 - Force battery into handset.
 - Charge or place battery near fire, heat sources or expose it to extreme heat.
 - Use battery for other equipment.
-  **If battery fluid gets into eyes, do not rub them. Rinse with clean water and consult a doctor immediately.**
Eyes may be severely damaged.

WARNING

Handset, Battery & Charger

-  **Do not insert foreign objects into handset.**
Do not place metal or flammable objects in handset, Charger or Holder. This may cause fire or electric shock. Keep handset out of the reach of children.
-  **Keep handset out of rain or extreme humidity.**
Fire or electric shock may occur.
-  **Keep handset away from liquid-filled containers.**
Keep handset, Charger and Holder away from chemicals/liquids. Fire or electric shock may result.
-  **Avoid sources of fire.**
Prevent fire or explosion. Do not use handset in the presence of gas or fine particles (coal, dust, metal, etc.).
-  **Keep handset, Charger or Holder away from microwave ovens.**
Battery or handset may leak, burst, overheat or ignite and cause accidents.

-  **Do not disassemble or modify handset.**
 - Do not open housing of handset, Charger or Holder; may cause electric shock or injury. Contact Vodafone Customer Centre, Customer Assistance for repairs.
 - Do not modify handset, Charger or Holder. Fire or electric shock may result.
-  **Do not subject handset to shocks.**
Subjecting handset, Charger or Holder to shocks may cause malfunction or injury. Should the handset break, remove the battery and contact Vodafone Customer Centre, Customer Assistance. Discontinue handset use. Fire or electric shock may occur.
-  **If water or foreign matter is inside handset:**
Discontinue handset use to prevent fire or electric shock. Turn handset power off, remove battery, unplug Charger and contact Vodafone Customer Centre, Customer Assistance.
-  **If an abnormality occurs:**
Should there be unusual sound, smoke or odour, discontinue handset use to avoid fire or electric shock. Turn handset power off, remove battery and unplug Charger and contact Vodafone Customer Centre, Customer Assistance.

Handset

-  **Preventing accidents**
 - For safety, never use handset while driving. Pull over beforehand. Mobile phone use while driving is prohibited by the revised Road Traffic Law (effective 1 November 2004).
 - Do not use headphones while driving or riding a bicycle. Accidents may result.
 - Moderate volume outside, especially at level/road crossings to avoid accidents.
-  **Do not swing handset by handstrap.**

May result in injury or breakage.
-  **Turn handset power off before boarding aircraft.**

Using wireless devices aboard aircraft may cause electronic malfunctions or endanger aircraft operation.
-  **Adjust vibration and Ringtone settings:**

Select settings carefully if you have a heart condition or wear pacemaker/defibrillator.
-  **During thunderstorms, turn power off; find cover.**

There is a risk of lightning strike or electric shock.

Charger



-  **Use only the specified voltage.**

Non-specified voltages may cause fire or electric shock.

 - AC Charger: 100 - 240 VAC
 - Vodafone is not liable for problems caused by charging handset abroad.
 - In-Car Charger: 12/24 VDC
-  **Do not use commercially available transformers.**

Use of AC Charger with commercially available transformers may cause fire, electric shock or damage.
-  **Do not use In-Car Charger inside vehicles with a positive earth.**

Fire may result. Use In-Car Charger only inside vehicles with a negative earth.
-  **Charger Care**

Do not touch blades with wet hands. Electric shock may occur.
- 
 - Do not use multiple cords in one outlet. May generate excess heat or fire.
 - Do not bend, twist, pull or set objects on cord. Exposed wire may cause fire or electric shock.
-  **Do not short-circuit Charger Terminals.**

Keep metal away from terminals. May cause overheating, fire or electric shock.

**Do not use Desktop Holder inside vehicles.**

Extreme temperature or vibration may cause fire or damage handset, etc.

**If AC/In-Car Charger cord is damaged:**

May cause fire or electric shock; contact Vodafone Customer Assistance to replace.

**Preventing accidents**

Secure In-Car Charger to avoid injury or accidents.

**During thunderstorms:**

Unplug Charger to avoid damage, fire or electric shock.

**Keep Charger & Desktop Holder out of the reach of children.**

Electric shock or injury may occur.

Battery



- If battery does not charge properly, stop charging. Battery may overheat, burst or ignite.
- If there is leakage or abnormal odour, avoid fire sources. It may catch fire or burst.



If there is abnormal odour, excessive heat, discolouration or distortion, remove battery from handset. It may leak, overheat or explode.

Handset Use & Electronic Medical Equipment

This section is based on "Guidelines on the Use of Radio Communications Equipment such as Cellular Telephones and Safeguards for Electronic Medical Equipment" (Electromagnetic Compatibility Conference, April 1997) and "Report of Investigation of the Effects of Radio Waves on Medical Equipment, etc." (Association of Radio Industries and Businesses, March 2001).

**People with implanted pacemakers/defibrillators should keep handset more than 22 cm away.**

Implanted pacemakers/defibrillators may malfunction due to radio waves.

**Turn handset power off in crowded places such as trains. People with implanted pacemakers/defibrillators may be near.**

Implanted pacemakers/defibrillators may malfunction due to radio waves.

**Observe these rules inside medical facilities:**

- Do not take handset into operating rooms or Intensive or Coronary Care Units.
- Keep handset off in hospitals.
- Keep handset off in hospital lobbies. Electronic equipment may be near.
- Obey rules regarding mobile phone use in medical facilities.

**Consult manufacturer for radio wave effects on electronic medical equipment.**

CAUTION

Handset, Battery & Charger

Handset Care

- Place handset on stable surfaces to avoid malfunction or injury.
- Keep handset away from oily smoke or steam. Fire or accidents may result.
- Cold air from air conditioners may condense, resulting in leakage or burnout.
- Keep handset away from direct sunlight (inside vehicles, etc.) or heat sources. Distortion, discolouration or fire may occur. Battery shape may be affected.
- Keep handset out of extremely cold places to avoid malfunction or accidents.
- Keep handset away from fire sources to avoid malfunction or accidents.

Usage Environment

- Excessive dust may prevent heat release and cause burnout or fire.
- Avoid using handset on the beach. Sand may cause malfunction or accidents.
- Keep handset away from credit cards, phone cards, etc. to avoid data loss.

Handset

Avoid leaving handset in extreme heat (inside vehicles, etc.).

Handset may heat up and lead to burns.

Volume settings

Keep handset volume moderate.

Excessive volume may cause damage to your hearing.

Headphones

- Do not unplug by pulling the cord. May cause damage to the cord.

- Keep plug clean to avoid noise or malfunction.

Inside vehicles:

Handset use may cause electronic equipment to malfunction.

Should skin irritation occur, discontinue handset use and consult a doctor.

Skin irritation, rashes, or itchiness may result depending on your physical condition.

Charger



Charger & In-Car Charger

Grasp plug (not cord) to disconnect Charger. May cause fire/electric shock.



- Keep cord away from heaters. Exposed wire may cause fire or electric shock.
- Stop use if plug is hot or improperly connected. May cause fire/electric shock.
- Keep In-Car Charger socket clean. May overheat and cause injury.



Do not touch Desktop Holder while in use

May cause burns.



Use only the specified fuse

1A fuse for In-Car Charger. Or may cause damage/fire.



Always charge handset in a well-ventilated area

Avoid covering/wrapping Charger/Desktop Holder. May cause damage/fire.



Do not use In-Car Charger when engine is off

Start engine before use. Or car battery may be weakened.



Long periods of disuse

Be sure to unplug AC/In-Car Charger after use.



Handset Maintenance

When cleaning, disconnect AC/In-Car Charger to prevent shock/injury.



Installing In-Car Charger

Properly position the cable for safe driving to avoid injury or accidents.

Battery



Do not throw or abuse battery. Battery may overheat, burst or ignite.



Do not leave battery in direct sunlight or inside vehicles. Overheating/fire may occur; may reduce performance.



Do not expose battery to liquids. Performance may deteriorate.



If battery fluid contacts on skin or clothes, rinse with clean water immediately.



Do not dispose of exhausted batteries with ordinary refuse. Tape over battery terminals before disposal, or bring them to a Vodafone shop. Follow local regulations regarding battery disposal.



Keep battery out of the reach of children.



• Charge battery within a range of 5°C - 35°C; outside this range, battery may leak/overheat and performance may deteriorate.

• If your child is using handset, explain all instructions and supervise usage.

• If there is abnormal odour or excessive heat, stop using battery and call Vodafone Customer Centre, Customer Assistance.

• Do not leave battery uncharged. Charge at least once every six months.

General Notes

General Use

- Vodafone is not liable for any damages resulting from accidental loss/alteration of handset or miniSD™ Memory Card data. Please keep separate records of Phone Book entries, etc.
- Handset transmissions may be disrupted inside buildings, tunnels or underground, or when moving into/out of such places.
- Use handset without disturbing others.
- Handsets are radios as stipulated by the Radio Law. Under the Radio Law, handsets must be submitted for inspection upon request.
- Handset use near landlines, TVs or radios may cause interference.
- **Beware of eavesdropping.**
Because this service is completely digital, the possibility of signal interception is greatly reduced. However, some transmissions may be overheard.

Eavesdropping

Deliberate/accidental interception of communications constitutes eavesdropping.

Inside Vehicles

- Never use handset while driving.
- Do not park illegally to use handset.
- Handset use may affect a vehicle's electronic equipment.

Aboard Aircraft

Never use handset aboard aircraft (keep power off). Handset use may impair aircraft operation.

Electromagnetic Waves

For body worn operation, this phone has been tested and meets RF exposure guidelines when used with an accessory that contains no metal and that positions the handset a minimum of 15mm from the body. Use of other accessories may not ensure compliance with RF exposure guidelines.

Handset Care

- If handset is left with no battery or an exhausted one, data may be altered/lost. Vodafone is not liable for any resulting damages.
- Use handset between 5°C - 35°C and 35% - 85% humidity. Avoid extreme temperatures/direct sunlight.
- Exposing lens to direct sunlight may damage colour filter and affect image colour.
- Do not drop or subject handset to shocks.
- Clean handset with dry, soft cloth. Using alcohol, thinner, etc. may damage it.
- Do not expose handset to rain, snow or high humidity.
- Never disassemble or modify handset.
- Avoid scratching handset Display.
- When closing handset, keep straps, etc. outside to avoid damaging the display.

- When using headphones, moderate volume to avoid sound bleed.
- **Handset is not water-proof. Avoid exposure to liquids and high humidity.**
 - Keep handset away from precipitation.
 - Cold air from air conditioning, etc. may condense causing corrosion.
 - Avoid placing handset in damp places (restrooms, bath/shower rooms, etc.).
 - On the beach, keep handset away from water and direct sunlight.
 - Perspiration may get inside handset causing malfunction.
- **Heavy objects or excessive pressure should be avoided. May cause malfunction or injury.**
 - Do not sit down with handset in a back pocket.
 - Do not place heavy objects on handset in a bag.
- Connect only the specified equipment to Headphone Connector. Malfunction or damage may result.
- Always turn off handset before removing battery. If battery is removed while saving data or sending mail, data may be lost, changed or destroyed.

Copyrights

Copyright laws protect sounds, images, computer programmes, databases, other materials and copyright holders. Duplicated material is limited to private use only. Use of materials beyond this limit or without permission of copyright holders may constitute copyright infringement, and be subject to criminal punishment. Comply with copyright laws when using images captured with handset camera.

FCC RF Exposure Information

Your handset is a radio transmitter and receiver. It is designed and manufactured not to exceed the emission limits for exposure to radio frequency (RF) energy set by the Federal Communications Commission of the U.S. Government.

The guidelines are based on standards that were developed by independent scientific organisations through periodic and thorough evaluation of scientific studies. The standards include a substantial safety margin designed to assure the safety of all persons, regardless of age and health.

The exposure standard for wireless handsets employs a unit of measurement known as the Specific Absorption Rate, or SAR. The SAR limit set by the FCC is 1.6 W/kg. The tests are performed in positions and locations (e.g., at the ear and worn on the body) as required by the FCC for each model. The highest SAR value for this model handset when tested for use at the ear is 0.754 W/kg and when worn on the body, as described in this user guide, is 0.943 W/kg.

Body-worn Operation; This device was tested for typical body-worn operations with the back of the handset kept 1.5 cm from the body. To maintain compliance with FCC RF exposure requirements, use accessories that maintain a 1.5 cm separation distance between the user's body and the back of the handset. The use of beltclips, holsters and similar accessories should not contain metallic components in its assembly.

The use of accessories that do not satisfy these requirements may not comply with FCC RF exposure requirements, and should be avoided.

The FCC has granted an Equipment Authorisation for this model handset with all reported SAR levels evaluated as in compliance with the FCC RF emission guidelines. SAR information on this model handset is on file with the FCC and can be found under the Display Grant section of <http://www.fcc.gov/oet/fccid> after searching on FCC ID APYHRO00043.

Additional information on Specific Absorption Rates (SAR) can be found on the Cellular Telecommunications & Internet Association (CTIA) website at <http://www.phonefacts.net>.

European RF Exposure Information

Your mobile device is a radio transmitter and receiver. It is designed not to exceed the limits for exposure to radio waves recommended by international guidelines. These guidelines were developed by the independent scientific organization ICNIRP and include safety margins designed to assure the protection of all persons, regardless of age and health.

The guidelines use a unit of measurement known as the Specific Absorption Rate, or SAR. The SAR limit for mobile devices is 2 W/kg and the highest SAR value for this device when tested at the ear was ●●● W/kg*. As mobile devices offer a range of functions, they can be used in other positions, such as on the body as described in this user guide**. In this case, the highest tested SAR value is ●●● W/kg.

As SAR is measured utilizing the devices highest transmitting power the actual SAR of this device while operating is typically below that indicated above. This is due to automatic changes to the power level of the device to ensure it only uses the minimum level required to reach the network.

The World Health Organization has stated that present scientific information does not indicate the need for any special precautions for the use of mobile devices. They note that if you want to reduce your exposure then you can do so by limiting the length of calls or using a hands-free device to keep the mobile phone away from the head and body.

* The tests are carried out in accordance with international guidelines for testing.

** Please see General Notes (Electromagnetic Waves) on page 18-9 for important notes regarding body worn operation.

Minding Mobile Manners

Please use your handset responsibly. Use these basic tips as a guide. Inappropriate handset use can be both dangerous and bothersome. Please take care not to disturb others when using your handset. Adjust handset use according to your surroundings.

- Turn it off in theatres, museums and other places where silence is the norm.
- Refrain from using it in restaurants, hotel lobbies, elevators, etc.
- Observe signs and instructions regarding handset use aboard trains, etc.
- Refrain from use that interrupts the flow of pedestrian or vehicle traffic.

Manner-Related Features

Take advantage of built-in features to help you use your handset in public places without disturbing or endangering others.

■ Offline Mode

Use Offline Mode to suspend all handset transmissions. When Offline Mode is active, incoming and outgoing calls/mail as well as incoming Vodafone live! information are blocked.

■ Manner Mode

Press a single key to automatically mute all Ringtones and activate Vibration mode for incoming calls/mail.

■ Vibration Mode

Activate Vibration mode to use handset vibration to alert you to incoming calls, mail, etc. in public places.

■ Volume Settings

Decrease or mute Ringtone volume for incoming calls/mail as well as tones for Web or V-applications when carrying handset in public places.

■ Answer Phone

Use Answer Phone to handle incoming calls when it is inappropriate or unsafe to answer.

Handset Parts & Functions

Handset

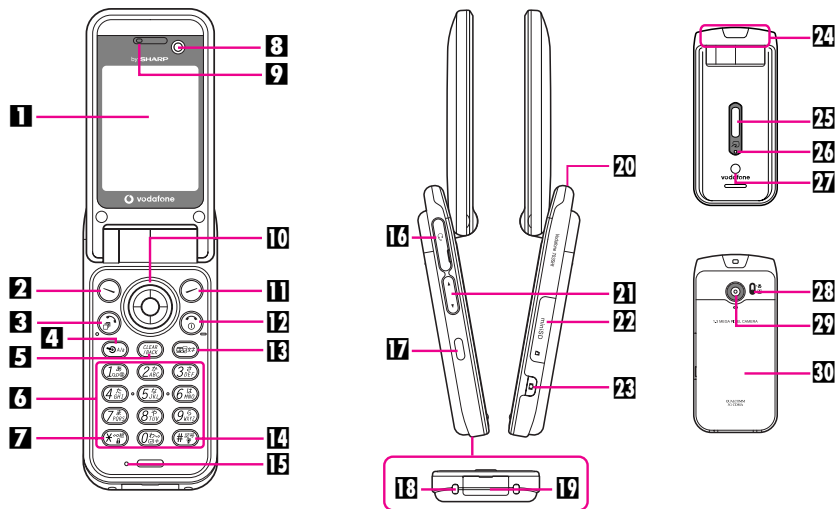

1 Display

2 Left Soft Key

Open messaging menu or execute Soft Key function/command.

3 Start Key

Initiate/answer calls.
Open records of All Calls.

4 Shortcuts and A/a Key

In Standby, open Shortcuts menu.
In text entry windows, toggle upper/lower case roman letters or standard/small hiragana/katakana.

5 Clear/Back Key

Delete entries/return to previous window.

6 Keypad**7 ✖ Key/Keypad Lock**

In Standby, press for 1+ seconds to toggle Keypad Lock.

In alphanumeric entry, open web/mail address prefixes & suffixes.

8 Internal Camera

Use during Video Call.

9 Earpiece**10 Multi Selector**

Select menu items, move cursor, scroll, etc.

11 Right Soft Key

Open Vodafone live! menu or execute Soft Key function/command.

12 Power On/Off Key

Press for 2+ seconds to turn handset power on/off.

13 Multimedia/Text Key

Start Media Player or toggle between character entry modes.

14 # Key

In text entry windows, toggle Symbol/Pictograph Lists.
Press for 1+ seconds to activate/cancel Manner mode.

15 Microphone**16 Headphone Connector**

Connect supplied Headphones, etc.

17 Infrared Port

Use for infrared data transmissions.

18 Charger Terminal**19 External Device Connector**

Connect Charger here.

20 Strap Eyelet

Attach straps as shown.

21 Zoom/Select Key

Select menu items, move cursor, etc.

22 Memory Card Slot

Insert miniSD™ Memory Card here.

23 Shutter Key

Open selected menu items or execute functions.
Press for 1+ seconds to activate mobile camera.

24 Internal Antenna Location**25 Sub Display****26 Small Light**

Illuminates red while charging. Flashes for incoming calls/mail.

27 Speaker**28 ●●●●****29 External Camera (Lens Cover)**

Capture still and video images.

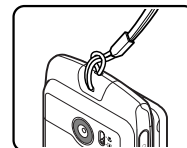
30 Battery Cover**Note ▶ Internal Antenna**

- 703SHf has no external antenna. Handset transmits and receives signals via Internal Antenna.
- Do not cover or place stickers, etc. over the area containing Internal Antenna. Voice quality will vary depending on where/how handset is used.

USIM Card

Vodafone Global Standard USIM Card is an IC card containing customer information such as handset number. USIM Card must be inserted before using a USIM Card compatible handset. Without USIM Card, Network services (calls, messaging, Web, etc.) are not available.

Inserting

1 Remove battery

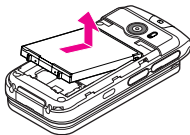

2 Press down and slide the holder as shown in ①, then lift it

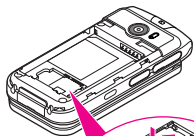

3 Slide USIM Card into the holder (with IC chip facing inward) until it stops

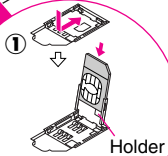

4 Set down and slide the holder back in as shown in ②

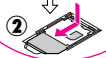

5 Insert battery

Removing

1 Remove battery

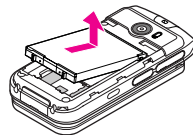

2 Press down and slide the holder as shown in ①, then lift it

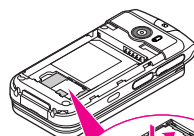

3 Slide out USIM Card

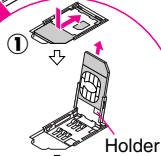

4 Set down and slide the holder back in as shown in ②

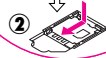

5 Insert battery

Note ▶ • Do not force USIM Card into or out of handset. Damage may result.

• Be careful not to lose removed USIM Card.

• Avoid touching USIM Card IC chip. May hinder performance. In such cases, **Insert SIM Card** may appear or handset may automatically restart. This is not a malfunction. Avoid touching USIM Card terminals as well.

Battery & Charger

Charge battery before use or after a period of disuse.

■ Battery Life

- Do not use or store battery at extreme temperatures. May shorten battery life.
Ideal working temperature is between 5°C - 35°C.
- Use specified Charger only. Battery may deteriorate, overheat or cause fire.
- Replace battery if operating time is noticeably shorter than normal.

■ Charging

- Do not use Charger for other purposes.
- Battery may short-circuit, overheat or burst from contact with metal objects.
- Charger and battery may become warm during charging.
- Move Charger away from TV/radio if interference occurs.

■ Precautions

- Use a dry cotton swab to clean handset, battery and Charger terminals.
- Avoid:
 - Extreme temperatures
 - Humidity, dust and vibration
 - Direct sunlight
- Do not leave battery uncharged. Charge at least once every six months.
- Use a case when carrying battery separately.

■ Battery Disposal

Do not dispose of exhausted batteries with ordinary refuse. Tape over battery terminals before disposal, or bring them to a Vodafone shop. Follow local regulations regarding battery disposal.

Charging (Use Specified Charger Only)

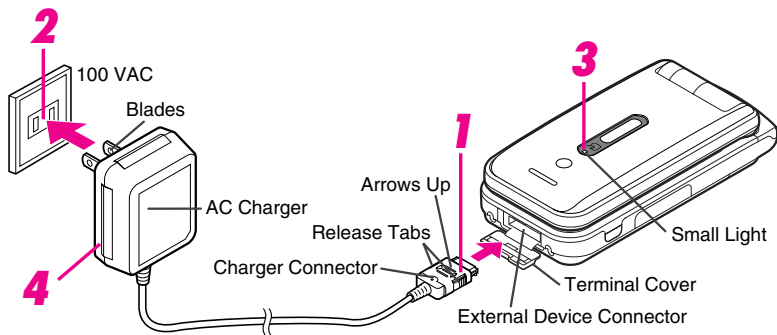

1 Open Terminal Cover, then squeeze release tabs and insert Charger connector until it clicks

- Take hold of the concave part and open Terminal Cover as shown.



2 Plug in Charger

- Charging starts and Small Light illuminates red.
- Extend blades. Fold back when not in use.

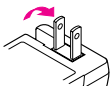

3 Charging is complete when light goes out

- Charging takes approximately 140 minutes* (with handset power off).
- * May vary with temperature.

4 After charging battery, unplug Charger from outlet, then handset

- Note** ▶
- Do not pull, bend or twist AC Charger cord.
 - AC Charger is compatible with household currents between 100 - 240 VAC.
 - Vodafone is not liable for problems caused by charging handset abroad.

Display Indicators

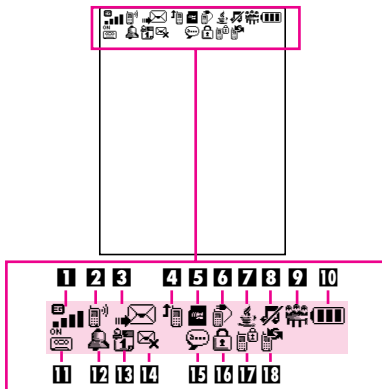

- 1** Signal Strength / 3G / GSM
: Strong : Moderate : Low : Weak
: Out-of-Range
- 2** Incoming Voice Call / Voice Call in Progress
 Video Call in Progress
 / Packet Data Communication Status
 Offline Mode
- 3** SMS or MMS / (red) Memory Full
 Receiving Mail / Sending Mail
- 4** Call Forwarding or Voice Mail / Auto Delivery Info
- 5** miniSD™ Memory Card Status
: Loading / : In Use
: Formatting / : Unusable

- 6** / / / / / External Transmission
: USB Transmission Ready
 (red): Infrared Connection in Progress
: Infrared Transmission in Progress
: Bluetooth Transmission Ready
: Bluetooth Transmission in Progress
: Bluetooth Talk in Progress
- 7** Active V-Application
 (grey) Paused V-Application
 Music Player Active / SSL
- 8** Silent / Increasing Volume / Vibration
 Loudspeaker / Microphone Mute
- 9** Meeting / Activity / Car / Headset / Manner
: Meeting : Activity : Car
: Headset : Manner
- 10** Battery Strength
: Strong : Moderate : Low : Empty
- 11** Answer Phone Active / Message
: Answer Phone Active
: Answer Phone Cancelled
- 12** Alarm Set
- 13** Schedule
 Reminder On: / Off:
- 14** Message Delivery Failure
- 15** New Voice Mail
- 16** Secret Mode Active
- 17** Function Lock Active / Keypad Lock Active
- 18** (grey) Infrared Transmission Ready

Sub Display

Sub Display & Display indicators (P.18-19) represent the same functions. Only major indicators are described below.

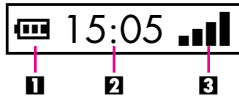

- 1** Battery Strength
- 2** Time
- 3** Signal Strength

Incoming Communications

Indicator and number of calls/messages, etc. appear for missed incoming communications or Alarm.

Missed Calls	☎: 1	Alarm	🔔: 1
Message Recorder	📄: 1	Calendar (Reminder set)	📅: 1
New Messages	✉: 1	Tasks (Reminder set)	📋: 1
Auto Delivery Info	📧: 1		

Symbols

Multi Selector

Use Multi Selector to select menu items, move cursor, scroll, etc. In this manual, Multi Selector operations are indicated as follows:

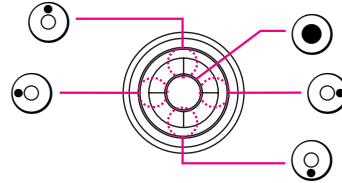

Basic Multi Selector Operations

- : Press or
- : Press or
- : Press , , or

Menu Items

Use or to select menu items. (Example: Select *Text* and press)

USIM PINs

PIN1 & PIN2

PIN1	Prevent unauthorised use of Vodafone handset
PIN2	Required to clear Call Costs and to set Max Cost

- PIN1 & PIN2 are **9999** by default.
- PIN1 & PIN2 can be changed.
- When **Switch On/Off** in **PIN Entry** is **On**, PIN1 (4-8 digits) is required every time handset is turned on (with USIM Card inserted).

PIN Lock & Cancellation (PUK Code*)

PIN1 Lock or PIN 2 Lock is activated if PIN1 or PIN2 is incorrectly entered three times consecutively. Cancel PIN Lock by entering the Personal Unblocking Key (PUK Code). For information on PUK Code, contact Vodafone Customer Centre, General Information ( **P. 18-44**).

* USIM Personal Unblocking Key (PUK Code) unblocks a USIM Card blocked after the wrong PIN has been entered three consecutive times. Each USIM Card has a unique PUK Code. Do not disclose it to unauthorised persons.

- Note** ▶
- If PUK Code is incorrectly entered ten times, USIM Card is locked and handset is disabled. Write down PUK Code.
 - For procedures required to unlock USIM Card, contact Vodafone Customer Centre, General Information ( **P. 18-44**).

Security Codes

Handset Code, Centre Access Code and Network Password are needed for handset use.

Handset Code

9999 or the 4-digit number selected at initial subscription. Handset Code is required to use/change some handset functions. ✖ appears when Handset Code is entered. If incorrect, **Handset code is incorrect!** appears.

Centre Access Code

The 4-digit number in the contract, required to access optional service via landlines, and to subscribe to fee-based information.

Network Password

The 4-digit number selected at initial subscription, required to restrict handset services. If Network Password is incorrectly entered three times consecutively, Call Barring settings are locked. To resolve, Network Password and Centre Access Code must be changed. For details, contact Vodafone Customer Centre, General Information (☎ P.18-44).

- Note** ▶
- Write down Handset Code, Centre Access Code and Network Password. If lost, contact Vodafone Customer Centre, General Information (☎ P.18-44).
 - Do not reveal Handset Code, Centre Access Code and Network Password. Vodafone is not liable for misuse or damages.

- Tip** ▶
- Change Handset Code and Network Password as needed.
 - Do not attempt to change Centre Access Code. Contact Vodafone Customer Centre, General Information (☎ P.18-44) for details.

Basic Handset Operations

Handset Power On/Off

Turning On

- 1 Open handset
- 2 Press ⏻ for 2+ seconds

Turning Off

- 1 Open handset
- 2 Press ⏻ for 2+ seconds

English Display

- 1 Press ⏻, select 設定 and press ⏻
- 2 Select *Language* and press ⏻
- 3 Select *English* and press ⏻

Your Phone Number

- 1 Press ⏻, select *My Details* and press ⏻
- 2 Press ⏻ to exit

Setting Clock

- 1 Press ⏻, select *Settings* and press ⏻
- 2 Select *Date & Time* and press ⏻

- 3 Select **Set Date/Time** and press ●
- 4 Enter the date and press ●
- 5 Enter the time (24-hour format) and press ●

Network Settings

- 1 Press ●, select **Connectivity** and press ●
- 2 Select **Network Settings** and press ●
- 3 Select **Select Service** and press ●
- 4 Select **Auto**, **3G** or **GSM** and press ●
For **Auto**, mode (3G or GSM) changes automatically depending on the current location.

Initiating a Voice Call

Calling in Japan

- 1 Enter a phone number
- 2 Press ●

Placing an International Call

Service requires an additional contract, but no basic monthly charges or application fees.

- 1 Enter a phone number
Proceed to Step 6 when calling Vodafone handsets.
- 2 Press ⌵ **Options**
- 3 Select **Country Code** and press ●

- 4 Select a country and press ●
- 5 Select **Japan** and press ●
- 6 Press ●

Note ▶

- Omit the first 0 of the area code except when calling a number in Italy.
- For details on placing international calls, contact Vodafone Customer Centre, General Information (☎ P.18-44).

Calling from Outside Japan

Service requires an additional contract, but no basic monthly charges or application fees.

- 1 Enter a phone number
When calling landlines or mobile phones within the country, proceed to Step 6.
- 2 Press ⌵ **Options**
- 3 Select **Country Code** and press ●
- 4 Select a country and press ●
When calling Vodafone handsets, always select **日本 (JPN)**.
- 5 Select **Abroad** and press ●
- 6 Press ●

Redial

- 1 Press
- 2 Select a record and press
- 3 Press

Calling from Received Calls

- 1 Press
- 2 Select a record and press
- 3 Press

Initiating a Video Call

- 1 Enter a phone number
- 2 Press **Options**
- 3 Select *Video Call* and press

Answering a Voice Call

- 1 Handset rings/vibrates and Small Light flashes for an incoming Voice Call
Open handset
- 2 Press

Answering a Video Call

- 1 Handset rings/vibrates and Small Light flashes for an incoming Video Call
Open handset
- 2 Press to answer with voice and video image
Press **Options**, select *Hide Picture* and press to answer with voice only

Total Charges & Call Time

Total Charges

- 1 Press , select *Call Log* and press
- 2 Select *Call Costs* and press
- 3 Select *All Calls* and press

Total Call Time

- 1 Press , select *Call Log* and press
- 2 Select *Call Timers* and press
- 3 Select *Received Calls* or *Dialled Calls* and press



Muting Microphone

Even when Microphone is muted, other party's voice can be heard through Earpiece.

- 1 During a call, press **Mute**
- 2 Press **Unmute** to cancel

Answer Phone & Voice Mail

Activate Answer Phone or transfer incoming calls to Voice Mail to record caller messages.

	Answer Phone	Voice Mail
Message Recorded	Handset	Voice Mail Centre
Setting	Press ⓪ ➔ Select Call Log ➔ Press ⓪ ➔ Select Answer Phone ➔ Press ⓪ ➔ Select Settings ➔ Press ⓪ ➔ Select Switch On/Off ➔ Press ⓪ ➔ Choose On ➔ Press ⓪	Press ⓪ ➔ Select Settings ➔ Press ⓪ ➔ Select Call Settings ➔ Press ⓪ ➔ Select Voicemail & Diverts ➔ Press ⓪ Select Voicemail ➔ Press ⓪ ➔ Select Activate ➔ Press ⓪ ➔ Select a forwarding condition ➔ Press ⓪ ➔ Select ring time (when the forwarding condition is No Answer) ➔ Press ⓪
Additional Contract	Not Required	Not Required
Message Indicator		
Play	Press ⓪ ➔ Select Call Log ➔ Press ⓪ ➔ Select Answer Phone ➔ Press ⓪ ➔ Select Play Answer Phone ➔ Press ⓪	Press ⓪ ➔ Select Phone Book ➔ Press ⓪ ➔ Select Call Voicemail ➔ Press ⓪
Delete	During playback, press ⓪ Options ➔ Select Delete ➔ Press ⓪ ➔ Press ⓪ Yes	After playback, press 7 ⓪
When Handset Power is Off	Not Available	Available (except when the forwarding condition is When Busy or No Answer)
When Handset is Out-of-Range	Not Available	Available (except when the forwarding condition is When Busy or No Answer)

Tip ▶ Activating Voice Mail cancels Call Forwarding.

Forwarding a Call

Transfer incoming calls to a specified phone number.

Activating Call Forwarding

- 1 Press **[M]**, select **Settings** and press **[M]**
- 2 Select **Call Settings** and press **[M]**
- 3 Select **VoiceMail & Diverts** and press **[M]**
- 4 Select **Diverts** and press **[M]**
- 5 Select **Activate** and press **[M]**
- 6 Select a forwarding condition and press **[M]**
- 7 Select **Enter Phone Number** and press **[M]**
- 8 Enter a forwarding number and press **[M]**
- 9 Select ring time and press **[M]** (when the forwarding condition is **No Answer**)

Note ▶ Activating Call Forwarding cancels Voice Mail.

Manner Mode

Activate Manner mode to use handset without disturbing others.

- 1 In Standby, press **[*][M][*]** for 1+ seconds
- Default Manner Mode Settings:
- ① Mutes Keypad Tones as well as Power On/Off and Error tones.
 - ② Simultaneously invokes: For Incoming Call (Silent), For New Message (Silent), General Volume (Silent), Vibration (On). Adjust settings as required.

Tip ▶ **Canceling Manner Mode**
In Standby, press **[*][M][*]** for 1+ seconds.

Entering Characters

Entry Modes

Press **[M]** to toggle between character entry modes.

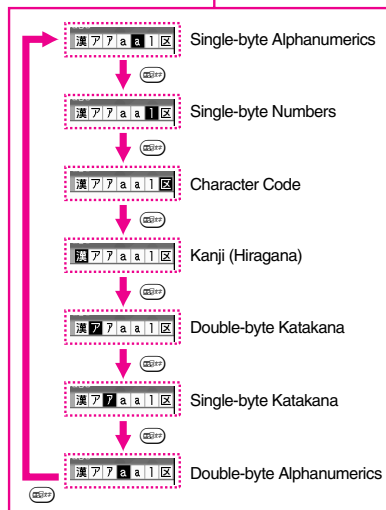
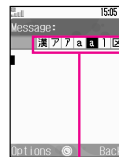

Key Assignments

Key	Single-byte Alphanumerics		Single-byte Numbers	Character Code
	Upper & Lower Case	Lower Case		
	@./_-1 (Space)	@./_-1 (Space)	1	1
	ABCabc2	abc2	2	2
	DEFdef3	def3	3	3
	GHIghi4	ghi4	4	4
	JKLjk15	jk15	5	5
	MNOmno6	mno6	6	6
	PQRSpqrs7	pqrs7	7	7
	TUVtuv8	tuv8	8	8
	WXYZwxyz9	wxyz9	9	9
	.0 (Line Break) ¹	.0 (Line Break) ¹	0 + ³	0
	Single-byte Mail/Web Extensions ²		* P (Pause) ? - ⁴	
	Log/Single-byte Symbols/Double-byte Pictographs		#	
	Cursor Up			
	Cursor Down (Line Break) ¹			
	Cursor Left			
	Cursor Right			
	Change Character Entry Mode			
	Toggle Case + Toggle Mode (upper & lower/lower case)			
	Delete One Character			Delete Code/One Character
	Delete before or after cursor			
	Recover up to 64 deleted characters ⁵			
	OK			

¹ Insert line breaks in mail message text, Text Templates, etc. Press at the end of text.

² Extensions are listed for easy entry.

³ + is for phone number entry. Press for 1+ seconds.



⁴ P (Pause), ? and - are for phone number entry.

⁵ Press once for each character to recover immediately after deleting. [Not available after deleting text with (Long Press).]

Tip ▶ Entering Consecutive Characters Assigned to the Same Key

Press  to move cursor to the right, then enter the next character.

Editing Characters

Use  to move cursor to a character. Press  to delete it and then enter another.

Symbols, Pictographs & Emoticons

Symbols & Pictographs

1 Press  to open Symbol List

2 Press  to toggle the list as follows: Pictograph List (6 - 1) → Log List (up to 20 recently entered Symbols/Pictographs are saved) → Symbol List

3 Use  to select one and press 

4 Press  **Exit** to exit list

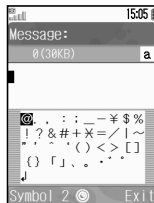

Tip ▶ In double-byte character entry modes, three Symbol Lists appear. Press  to toggle between them.

Emoticons

1 In a text entry window, press  **Options**

2 Select **Emoticons** and press 

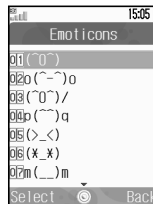

3 Select an emoticon and press 

Saving to Phone Book

Save names with phone numbers, mail addresses, etc. to Phone Book.

Phone Book Entry Items

Item	Description
Last Name:	Enter up to 16 characters. (Select Name: when saving to USIM Card.)
First Name:	
Reading:	Enter up to 32 characters
Add Telephone:	Enter up to three numbers on handset and two numbers on USIM Card (32 digits each)
Add Email Address:	Enter up to three addresses on handset and one address on USIM Card (128 single-byte characters each)
Category:	Sort entries into 16 Groups (handset and USIM Card each). Group names can be changed. Set Ringtone by Category (handset only).
Postcode:	Enter up to 20 characters
Country:	Enter up to 32 characters
State:	Enter up to 64 characters
City:	Enter up to 64 characters
Street & Number:	Enter up to 64 characters
Note:	Add personal details. Enter up to 256 characters.
Birthday:	Enter birth date
Picture:	Set an image to appear for incoming calls/mail
Assign Tone/Video:	Set Ringtone or Ringvideo by caller
Secret:	Restrict access to Phone Book entries by saving them as Secret

- Save up to 500 entries to handset Phone Book. On USIM Card, the number of entries you can save in Phone Book depends on the card specification. Depending on the USIM Card in use, some items may not be supported, and character entry limits or number of Groups may be lower. Also, the number of phone numbers or mail addresses per entry may be lower.
- Save names, readings, phone numbers, mail addresses and Categories to USIM Card.

Note ▶ Back-up Important Information

Keep a separate copy of important information. When battery is exhausted or removed for long periods, Phone Book entries may be lost. Handset damage may also affect information recovery. Vodafone is not liable for any damages resulting from accidental loss/alteration.

New Phone Book Entries

Enter a name, reading, phone number and mail address.

- 1 Press \odot , select **Phone Book** and press \odot
- 2 Select **Phone Book List** and press \odot
- 3 Press \ominus **Options**
- 4 Select **Add New Entry** and press \odot
- 5 Select **Last Name:** and press \odot
- 6 Enter last name and press \odot
- 7 Select **First Name:** and press \odot
- 8 Enter first name and press \odot
 Characters entered for names appear after **Reading:**.
 Confirm the reading.

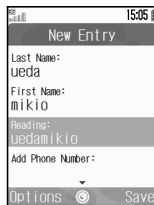

Tip ▶ Correcting Spelling, etc.
 Select **Reading:** and press \odot . Correct spelling and press \odot .

- 9 Select **Add Phone Number:** and press \odot
- 10 Enter a phone number and press \odot
- 11 Select an icon and press \odot

- 12 Select **Add Email Address:** and press \odot
- 13 Enter a mail address and press \odot
- 14 Select an icon and press \odot
- 15 Press \ominus **Save**

Note ▶ Enter a name, phone number or mail address to create a Phone Book entry.

Tip ▶ To Change Storage Media
 In Standby, press \odot ▶ Select **Phone Book** ▶
 Press \odot ▶ Select **Settings** ▶ Press \odot ▶ Select
Save New Entry ▶ Press \odot ▶ Select **Handset,**
USIM Memory or **Ask Each Time** ▶ Press \odot
 • For **Ask Each Time**, select storage media for
 each new entry.

Editing Phone Book

- 1 Open a Phone Book entry (☞ P.18-31 "Dialling from Phone Book")
- 2 Press \ominus **Options**
- 3 Select **Edit** and press \odot
- 4 Select an item and press \odot
- 5 Edit contents and press \odot
- 6 Press \ominus **Save**

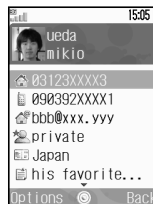

Saving from Received Calls

- 1 Select a phone number (☎ **P.18-24** "Calling from Received Calls")
- 2 Press **Options**, select **Save Number** and press **Enter**
- 3 **New Entry**
 - 1 Select **As New Entry** and press **Enter**
 - 2 Follow Steps 5 - 15 on **P.18-30**
Add to Existing Entry
 - 1 Select a Phone Book entry and press **Enter**
 - 2 Press **Save**

Dialling from Phone Book

Changing Search Method

By Reading Order	Shows entries that start with specified Reading
By Category	Opens entries in the specified Category
By Katakana	Shows entries with readings that start with katakana in the specified row

- 1 Press **Enter**, select **Phone Book** and press **Enter**
- 2 Select **Settings** and press **Enter**
- 3 Select **View Phone Book** and press **Enter**

- 4 Select **By Reading Order**, **By Category** or **By Katakana** and press **Enter**

Tip ▶ To Open Phone Book Entries on USIM Card In Standby, press **Enter** ▶ Select **Phone Book** ▶ Press **Enter** ▶ Select **Settings** ▶ Press **Enter** ▶ Select **Ph. Book Location** ▶ Press **Enter** ▶ Select **USIM Memory** ▶ Press **Enter**

Search by Reading

- 1 Set search method to **By Reading Order**
- 2 Press **Search**
- 3 Enter reading
- 4 Select a name and press **Enter**

Tip ▶ Multiple Numbers
Use **Search** to select other numbers.

- 5 Press **Search**

Mobile Camera

Before Using Camera

Select from two different shooting modes. Use **Photo Camera** for still images and **Video Camera** for videos.

■ Photo Camera

Image Size	W 960 × H 1280 dots
	W 768 × H 1024 dots
	W 480 × H 640 dots
	W 240 × H 320 dots
	W 120 × H 160 dots
Save to	Handset or miniSD™ Memory Card
File Format	JPEG (.jpg)

■ Video Camera

Image Size	W 176 × H 144 dots (QCIF)	W 240 × H 320 dots (QVGA)
	W 128 × H 96 dots (SQCIF)	
Save to	Handset or miniSD™ Memory Card	miniSD™ Memory Card
File Format	MPEG-4 (.3gp)	MPEG-4 (.3gp or .ASF)

Camera Shake

If handset moves while shooting, images may blur. Hold handset firmly or place it on a stable surface and use Self-timer.

Note ▶ Lens Cover

Use a soft cloth to wipe fingerprints and oil off lens cover.

Camera

- Mobile camera is a precision instrument. However, some pixels may appear brighter or darker.
- Shooting/saving images while handset is hot may affect the image quality.
- Subjecting the lens to direct sunlight will damage the camera's colour filter.

Capturing Still Images

- 1** In Standby, press
- 2** Select **Camera** and press
- 3** Press until appears at top of Display
- 4** Frame image on Display
- 5** Press
- 6** Press to save image
- 7** Press to exit

Capturing Self Portraits

Activate handset camera, then press to switch to Internal Camera. Your image appears on Display as a mirror image.

Data Folder

Data Folder Contents

Saved files are organised in separate folders according to file format.

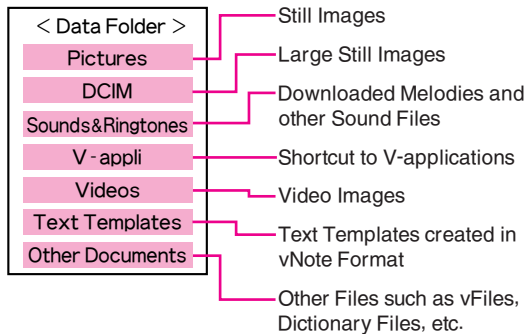

Opening Data Folder

- 1 Press **⏪**, select **Data Folder** and press **⏩**
- 2 Select a folder and press **⏩**
 - To select a file in a created sub folder, select the sub folder and press **⏩**.
 - To open miniSD™ Memory Card Data Folder, press **⏪**.
- 3 Select a file and press **⏩**
- 4 Press **⏪** to return to file list

MMS Mail Attachments

Example: Attaching an image from Pictures folder to MMS Mail

- 1 Press **⏪**, select **Data Folder** and press **⏩**
- 2 Select **Pictures** and press **⏩**
- 3 Select a file and press **⏪** **Options**
- 4 Select **Send** and press **⏩**
- 5 Select **As Message** and press **⏩**
- 6 Select the recipient field and press **⏩**
- 7 Enter a recipient and press **⏩**
- 8 Select the subject field and press **⏩**
- 9 Enter a subject and press **⏩**
- 10 Select the message text field, enter text and press **⏩**
- 11 Select **⏪** on Media Console and press **⏩**
- 12 Select **Send Message** and press **⏩**

Vodafone live!

Automatic Network Setup

To use Vodafone live! services, first download network connection information from Vodafone live! Service Centre. Handset initiates Network Setup when , or is pressed for the first time. If handset is in Japanese mode, press **No** , then change to English mode (P.18-22).

1 Press , or .

2 Press **Yes**

- Handset connects to the Network and retrieves required information.
- Follow onscreen instructions.

Web

Use Web to access the Mobile Internet directly from handset. Browse for image or sound files as well as information.

Vodafone live! Main Menu

Access Mobile Internet sites by selecting a topic from Vodafone live! Main Menu.

Auto Delivery Service

When available, request automatic info updates from Mobile Internet sites and download files via Web.

Searching the Mobile Internet

1 Press , select *Vodafone live!* and press

2 Select *Vodafone live!* and press

3 Select *English* and press

4 Select a menu item and press

5 Repeat Step 4

6 Press to exit Web

7 Press **Yes**

Note ▶ Vodafone live! Main Menu content is subject to change.

Web Options Menu

Open Vodafone live! and press  **Options** to use the following functions.

Item	Description
Home	Open information saved as "Home"
Bookmarks	Open Bookmarks to access information or edit the list
Mark Page	Save the current information to Bookmarks
Save This Link	Download files from links
Save Items	Save images, sound files and vFiles to Data Folder
Enter URL	Enter a Mobile Internet addresses directly
Access History	Access Mobile Internet sites using previously entered URLs
Reload Page	Update information
Advanced	Send URL via SMS/MMS, open properties, search within information, customise settings, etc.
Exit	Exit Web

Messaging

Vodafone text communication services are available in Japan and overseas. Exchange text or multimedia messages with compatible handsets, PCs, etc. via the Net.

SMS

Exchange short text messages of up to 160 single-byte characters with SMS compatible Vodafone handsets.

MMS

Exchange long text messages of up to approximately 30,000 single-byte characters with MMS compatible Vodafone handsets, e-mail compatible handsets and PCs and other devices via the Net. Attach images, sounds or vFiles to messages. Send/receive up to 300 KB (attachment and message text).

Note ▶ 703SHf handset is incompatible with Greeting, Coordinator, Relay Mail or Hotline. Messages from these services are not received.

Tip ▶

- An additional contract is required to use MMS and receive e-mail from PCs, etc.
- If a recipient's handset is off or out-of-range, the message is saved at the Centre, and delivered when recipient handset connects to the Network. The message is deleted if not received by the set Expiry Time.

Opening Messages

- 1 Press **⊙**, select *Messaging* and press **⊙**
- 2 Select *Received*, *Drafts*, *Sent* or *Unsent* and press **⊙**
- 3 Select a message and press **⊙**

Editing Messages

- 1 Open Draft or Unsent folder
- 2 *Draft*
 - 1 Select a message and press **⊙***Unsent*
 - 1 Select a message and press **⊖** **Options**
 - 2 Select *Edit* and press **⊙**
- 3 Edit the message

Customising Handset Address

Change the account name (alphanumerics before @) of initial handset mail address. Customising handset mail address helps reduce spam.

- 1 Press **⊙**, select *Vodafone live!* and press **⊙**
- 2 Select *Vodafone live!* and press **⊙**
Handset connects to the Network and Vodafone live! Main Menu opens.
- 3 Select *My Vodafone* and press **⊙**
- 4 Select *各種変更手続き* and press **⊙**

- 5 Select *オリジナルメール設定・各種メール設定* and press **⊙**
- 6 Select the text entry field below *暗証番号を入力してください。* and press **⊙**
- 7 Enter Centre Access Code and press **⊙**
- 8 Select *OK* and press **⊙**
- 9 Select 1. *各種メール設定* and press **⊙**
- 10 Select 1. *メールアドレス編集* and press **⊙**
- 11 Select the text entry field below *ご希望のアカウントを入力してください。* and press **⊙**
- 12 Enter an account name and press **⊙**
Enter between 3 and 30 single-byte characters.
- 13 Select *OK* and press **⊙**

Note: Error Messages

Message	Description
ご希望のEメールアドレスは既に登録されています。他のアドレスを入力してください	The address is already in use. Enter a different account name.
オリジナルメールアドレスを正しく入力してください	Entered address does not meet format requirements; try another.
一定時間経過しましたので再度暗証番号を入力して下さい	The specified time has elapsed. Press ⊙ and start again.
暗証番号の入力に誤りがあります	The Centre Access Code is incorrect. Press ⊙ and enter the correct Centre Access Code.

Note ▶ The procedure for searching the Mobile Internet may change without prior notice. For further information, contact Vodafone Customer Centre, General Information (☎ P.18-44).

Messages Menu

Press **⊙**, then select **Messaging** and press **⊙** to open Messages Menu.

Item	Description
Create Message	Create new message
Received	Open received messages
Drafts	Open draft messages
Sent	Open sent messages
Unsent	Open undelivered/cancelled/failed outgoing messages
Templates	Open messages saved as templates
Server Mail Box	Download and open list of messages on Server, or receive all messages on Server
Mail Settings	Customise general items, SMS, MMS, and Personal Folders. Create Speed Mail List.
Memory Status	View memory status of each Mail Box

Sending Text Messages

1 Press **⊙**, select **Messaging** and press **⊙**

2 Select **Create Message** and press **⊙**

3 Select the recipient field and press **⊙**

4 Enter a recipient

Phone Book

1 Select **From Phone Book** and press **⊙**

2 Select an entry and press **⊙**

3 Select recipient's mail address or Vodafone handset number and press **⊙**

Speed Mail

1 Press **⊖** **Options**, Select **Speed Mail List** and press **⊙**

2 Select a recipient and press **⊙**

Sent Mail Record

1 Select a recipient and press **⊙**

Direct Entry

1 Select **Enter Phone No.** or **Enter Email** and press **⊙**

2 Enter a mail address or Vodafone handset number and press **⊙**

Sending to Group



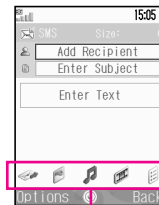

1 Select **Select Group** and press **⊙**

2 Select a Contact Group and press **⊙**

3 When multiple recipients are included, press **⊖** **Back** to return to New Message window



Media Console





- 5 Enter subject (MMS only)
 - 1 Select the subject field and press 
 - 2 Enter a subject and press 
- 6 Select the message text field and enter text, then press 
- 7 Press  until  appears on Media Console
For more about Media Console, see right.

8 Attach files (MMS only)





Attaching Images

- 1 Use  to select  on Media Console and press 
- 2 Select *Saved Pictures* and press 
- 3 Select a file and press 

Attaching Sound Files

- 1 Use  to select  on Media Console and press 
- 2 Select *Saved Sounds* and press 
- 3 Select a file and press 

Attaching Video Images

- 1 Use  to select  on Media Console and press 
- 2 Select *Saved Videos* and press 
- 3 Select a file and press 

- 9 When finished, use  to select  on Media Console and press 





- 10 Select *Send Message* and press 

Media Console

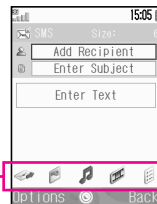
Media Console appears in New Message window for mail-related functions.



- When  appears on Media Console, use  to select icons. Otherwise press  until  appears.







-  **Send**
Enter a recipient, convert Message Type, send message, or use option settings.
-  **Picture**
Attach still images.
-  **Sound**
Attach sound files.
-  **Video**
Attach video images.
-  **Others**
Attach other types of files; attach Phone Book or schedule entries; create slides; check message text or attached files; or save to Draft or Templates.

Incoming Text Messages

Receiving MMS & SMS Messages

The Centre automatically delivers text messages to handset.  appears. While *Message received.* appears, press  to open Received folder.

Opening Received Text Messages



- 1 Press , select *Messaging* and press 
- 2 Select *Received* and press 
- 3 Select a message and press 

Retrieving MMS Messages

The Centre delivers the initial portion of MMS messages when:







- The message was sent to multiple recipients
- Files are attached to the message

Follow the steps below to download the entire message and attachments:









- 1 Select a message (see above)
Select an MMS message  (MMS Notice).
- 2 Press  **Options**
- 3 Select *Download* and press 

Replying & Forwarding

Replying to Messages

- 1 Open a received message (see left)
- 2 Press  **Options**
- 3 Select *Reply* or *Reply All* and press 
- 4 Select *Reply* or *Reply with Hist.* and press 
- 5 Select the message text field and enter text, then press 
- 6 Select  on Media Console and press 
- 7 Select *Send Message* and press 

Forwarding Messages

- 1 Open a received or sent message ( **P. 18-36**)
- 2 Press  **Options**
- 3 Select *Forward* and press 
- 4 Press 
- 5 Enter a recipient and press 
- 6 Select  on Media Console and press 
- 7 Select *Send Message* and press 

V-applications

A variety of V-applications are available for use with Vodafone handsets.

- Download V-applications via Web.
- Enjoy Network games or real time information.
- Set a V-application to activate when handset enters Standby.

V-appli Menu

Press **⊙**, then select *V-appli* and press **⊙** to open V-appli menu.

Item	Description
V-appli	Download, activate or delete V-applications
Settings	Adjust V-application settings
Information	View Java™ and JBlend™ rights

Downloading V-applications

- 1** Press **⊙**, select *V-appli* and press **⊙**
- 2** Select *V-appli* and press **⊙**
- 3** Select *More V-Appli* and press **⊙**
Handset connects to the Network and Vodafone live! Game Menu opens.
- 4** Open a Mobile Internet site offering V-applications
- 5** Select a V-application and press **⊙**
- 6** Press **⊙**
V-application is saved and confirmation appears.
- 7** Press **⊙** **Yes**

Function Menu

Main Menu	Sub Menu	Main Menu	Sub Menu	Main Menu	Sub Menu
V-appli	V-appli	Tools	Calendar	Call Log	All Calls
	Settings		Alarms		Dialled Numbers
	Information		Auto Power On		Missed Calls
Vodafone live!	Vodafone live!		Calculator		Received Calls
	Enter URL		Voice Recorder		Call Timers
	Bookmarks		E-Book		Data Counter
	Saved Page		Stopwatch		Answer Phone
	Access History		Tasks		Call Costs
	Browser Settings		World Clock		Connectivity
Media Player	Music		Countdown Timer		
	Videos	Expenses Memo	Network Settings		
Messaging	Create Message	Phone Help	Offline Mode		
	Received	Phone Book List	Internet Setting		
	Drafts	Call Voicemail	Memory Card		
	Sent	Manage Category	My Details	—	
	Unsent	Speed Dial List	Settings	Mode Settings	
	Templates	Contact Groups		Display Settings	
	Server Mail Box	Settings		Sound Settings	
	Mail Settings	Manage Ph.Book		Date & Time	
	Memory Status			言語選択	
Camera	—	User Dictionary			
Data Folder	Pictures		Call Settings		
	DCIM		Video Call		
	Sounds&Ringtones		Security		
	V-appli		LBS Settings		
	Videos		Master Reset		
	Text Templates				
	Other Documents				
	Memory Status				

Specifications

703SHf

Weight	Approximately 107 g (with battery)
Continuous Call Time	Approximately 150 minutes (3G) Approximately 240 minutes (GSM)
Continuous Standby Time (when closed)	Approximately 300 hours (3G) Approximately 290 hours (GSM)
Video Call Continuous Call Time	Approximately 100 minutes
Charging Time (Power off)	AC Charger: Approximately 140 minutes In-Car Charger: Approximately 140 minutes
Dimensions (W × H × D)	Approximately 47 × 99 × 23 mm (when closed, without protruding parts)
Maximum Output	0.25 W (3G) 2.0 W (GSM)

- Continuous Call Time is an average measured with a new, fully charged battery, with stable signals. Continuous Call Time may be less than half this value if handset is out-of-range or signal is weak.
- Continuous Standby Time is an average measured with a new, fully charged battery, with handset closed without calls or operations, in Standby with stable signals. Standby Time may be less than half this value if handset is out-of-range or signal is weak. Standby Time may vary by environment (battery status, temperature, etc.).
- Call Time and Standby Time decrease with frequent use of Display/Keypad Backlights.
- Call Time and Standby Time may decrease when a V-application is active.
- Call Time and Standby Time decrease with handset use in poor signal conditions.
- Display employs precision technology. However, some pixels may appear brighter or darker.

AC Charger

Power Source	100 - 240 VAC, 50/60 Hz
--------------	-------------------------

Power Consumption	12 VA
-------------------	-------

Output Voltage/Current	5.2 VDC/650 mA
------------------------	----------------

Charging Temperature	5°C - 35°C
----------------------	------------

Dimensions (W × H × D)	Approximately 55 × 45 × 22 mm (without protruding parts, cord)
------------------------	--

Cord Length	Approximately 1.5 m
-------------	---------------------

Battery

Voltage	3.7 V
---------	-------

Battery Type	Lithium-ion
--------------	-------------

Capacity	900 mAh
----------	---------

Dimensions (W × H × D)	Approximately 35.8 × 4.5 × 55 mm (without protruding parts)
------------------------	---

Headphones

Weight	Approximately 19 g
--------	--------------------

Cord Length	Approximately 169 cm
-------------	----------------------

Customer Service

If you have questions about Vodafone handsets or services, please call General Information.
For repairs, please call Customer Assistance.

Vodafone Customer Centres
From a Vodafone handset, dial toll free at
157 for General Information or
113 for Customer Assistance

Call these numbers toll free from landlines.

Subscription Area	Service Centre	Phone Number
Hokkaido, Aomori, Akita, Iwate, Yamagata, Miyagi, Fukushima, Niigata, Tokyo, Kanagawa, Chiba, Saitama, Ibaraki, Tochigi, Gunma, Yamanashi, Nagano, Toyama, Ishikawa, Fukui	General Information	☎ 0088-240-157
	Customer Assistance	☎ 0088-240-113
Aichi, Gifu, Mie, Shizuoka	General Information	☎ 0088-241-157
	Customer Assistance	☎ 0088-241-113
Osaka, Hyogo, Kyoto, Nara, Shiga, Wakayama	General Information	☎ 0088-242-157
	Customer Assistance	☎ 0088-242-113
Hiroshima, Okayama, Yamaguchi, Tottori, Shimane	General Information	☎ 0088-259-157
	Customer Assistance	☎ 0088-259-113
Tokushima, Kagawa, Ehime, Kochi	General Information	☎ 0088-247-157
	Customer Assistance	☎ 0088-247-113
Fukuoka, Saga, Nagasaki, Oita, Kumamoto, Miyazaki, Kagoshima, Okinawa	General Information	☎ 0088-250-157
	Customer Assistance	☎ 0088-250-113