

Abridged English Manual

For more information about handset operations and functions, please go to the Vodafone K.K. Website (www.vodafone.jp) for the full manual or dial 157 from a Vodafone handset for Customer Service.*

* Please note that the full manual may not be available in English at time of purchase. In this case, call Customer Service or check Vodafone Website again at a later date.

Accessories

■ Lithium-ion Battery (Type 1) (SHBAJ1)

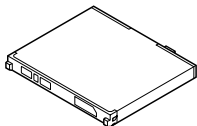

■ AC Charger (SHCAA1)

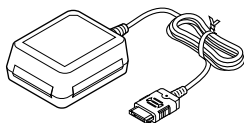

■ Utility Software (CD-ROM)**

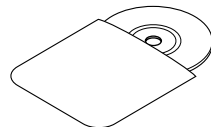

* Upgrades or updates of included Utility Software may become available on the Vodafone Website (<http://www.vodafone.jp>) without prior notification. Please check for the newest versions of utility applications and download as required.

** Complimentary sample not available for purchase

Note ▶ Supplied Utility Software is designed exclusively for 705SH.

- Tip** ▶
- For accessory-related information, please contact Vodafone Customer Centre, General Information (see P.17-45).
 - 705SH is compatible with microSD™ Memory Card; microSD™ Memory Card is not included in this package. Purchase microSD™ Memory Card to use Memory Card-related handset functions.
 - In this manual, microSD™ Memory Card is referred to as "Memory Card".



Safety Precautions



- Read safety precautions before using handset.
- Observe precautions to avoid injury to self or others, or damage to property.
- Vodafone is not liable for any damages resulting from use of this product.

Before Using Handset

■ Symbols

Make sure you thoroughly understand these symbols before reading on. Symbols and their meanings are described below:

 DANGER	Great risk of death or serious injury from improper use
 WARNING	Risk of death or serious injury from improper use
 CAUTION	Risk of injury or damage to property from improper use

	Prohibited Actions
	Compulsory Actions
	Attention Required

DANGER

Handset, Battery & Charger

Use specified battery, Charger and Desktop Holder.

Using non-specified equipment may cause malfunctions, electric shock or fire due to battery leakage, overheating or bursting.

Do not short-circuit Charger terminals.

Keep metal objects away from Charger terminals. Keep handset away from jewellery. Battery may leak, overheat, burst or ignite causing injury. Use a case to carry handset.

Battery

Prevent injury from battery leakage, breakage or fire. Do not:





- Heat or dispose of battery in fire
- Open/modify/disassemble battery
- Damage or solder battery
- Use a damaged or deformed battery
- Use non-specified charger
- Force battery into handset
- Charge battery near fire or sources of heat; or expose it to extreme heat
- Use battery for other equipment

If battery fluid contacts eyes, do not rub them. Rinse with clean water and consult a doctor immediately.

Eyes may be severely damaged.

WARNING

Handset, Battery & Charger

-  **Do not insert foreign objects into the handset, Charger or Desktop Holder.**
Do not insert metal or flammable objects into handset, Charger or Desktop Holder; may cause fire or electric shock. Keep out of children's reach.
-  **Keep handset out of rain or extreme humidity.**
Fire or electric shock may result.
-  **Keep handset away from liquid-filled containers.**
Keep the handset, Charger and Desktop Holder away from chemicals or liquids; fire or electric shock may result.
-  **Keep battery, handset, Charger or Desktop Holder away from microwave ovens.**
Battery, handset, Charger or Desktop Holder may leak, burst, overheat or ignite, leading to accidents or injury.
-  **Do not disassemble or modify handset or related hardware.**
 - Do not open handset, Charger or Desktop Holder; may cause electric shock or injury. Contact Vodafone Customer Centre, Customer Assistance for repairs.
 - Do not modify handset, Charger or Desktop Holder; fire or electric shock may result.



If water or foreign matter is inside handset:

Discontinue handset use to prevent fire/electric shock. Turn off handset, remove battery and unplug Charger, then contact Vodafone Customer Centre, Customer Assistance.



Avoid sources of fire.

Prevent fire or explosion. Do not use handset in the presence of gas or fine particles (coal, dust, metal, etc.).



Do not subject handset to strong shocks or impacts.

Strong shocks or impacts to handset, Charger or Desktop Holder may cause malfunction or injury. Should handset be damaged, remove battery then contact Vodafone Customer Centre, Customer Assistance. Discontinue handset use; fire or electric shock may occur.



If an abnormality occurs:

If a handset emits an unusual sound, smoke or odour, discontinue use; may cause fire or electric shock. Turn off handset, remove battery and unplug Charger; contact Vodafone Customer Centre, Customer Assistance.

Handset

-  **Take measures to prevent accidents.**
 - For safety, never use handset while driving. Pull over beforehand. Mobile phone use while driving is prohibited by the revised Road Traffic Law (effective 1 November 2004).
 - Do not use headphones while driving or riding a bicycle. Accidents may result.
 - Moderate volume outside, especially at level/road crossings to avoid accidents.
-  **Do not swing handset by handstrap.**

May result in injury or breakage.
-  **Turn handset power off before boarding aircraft.**

Using wireless devices aboard aircraft may cause electronic malfunctions or endanger aircraft operation.
-  **Adjusting vibration and Ringtone settings:**

Users with a heart condition/pacemaker/defibrillator should adjust handset settings accordingly.
-  **During thunderstorms, turn power off; find cover.**

There is a risk of lightning strike or electric shock.



Charger

-  **Use only the specified voltage.**

Non-specified voltages may cause fire or electric shock.

 - **AC Charger: AC 100V-240V Input**
 - Vodafone is not liable for problems caused by charging handset abroad.
 - **In-Car Charger: DC 12V-24V Input**
-  **Do not use commercially available transformers.**

Use of AC Charger with commercially available transformers may cause fire, electric shock or damage.
-  **Do not use In-Car Charger if vehicle has a positive earth.**

Fire may result. Use In-Car Charger only inside vehicles with a negative earth.
-  **Charger care**
 - Do not touch blades with wet hands. Electric shock may occur.
 - Do not use multiple cords in one outlet; may cause excess heat/fire.
 - Do not bend, twist, pull or set objects on cord. Exposed wire may cause fire or electric shock.
-  **Do not short-circuit Charger terminals.**

May cause overheating, fire or electric shock. Keep metal away from terminals.

 **Do not use Desktop Holder inside vehicles.**
Extreme temperature or vibration may cause fire or damage handset, etc.

 **Take measures to prevent accidents.**
Secure In-Car Charger to avoid injury or accidents.

 **Damaged AC Charger/In-Car Charger cord:**
May cause fire or electric shock; contact Vodafone Customer Centre, Customer Assistance to replace.

 **During thunderstorms:**
Unplug Charger to avoid damage, fire or electric shock.

 **Charger/Desktop Holder use and children:**
May cause electric shock/injury; keep out of reach.

Battery

 • If battery does not charge properly, stop charging. Battery may overheat, burst or ignite.
• If there is leakage or abnormal odour, avoid fire sources. It may catch fire or burst.

 If there is abnormal odour, excessive heat, discolouration or distortion, remove battery from handset. It may leak, overheat or explode.

Handset Use & Electronic Medical Equipment

This section is based on "Guidelines on the Use of Radio Communications Equipment such as Cellular Telephones and Safeguards for Electronic Medical Equipment" (Electromagnetic Compatibility Conference, April 1997) and "Report of Investigation of the Effects of Radio Waves on Medical Equipment, etc." (Association of Radio Industries and Businesses, March 2001).

 **Persons with implanted pacemaker/defibrillator should keep handset more than 22 cm away.**
Radio waves can interfere with implanted pacemakers or defibrillators causing such devices to malfunction.

 **Turn handset off in crowds or trains where persons with implanted pacemaker/defibrillator may be near.**

Radio waves can interfere with implanted pacemakers or defibrillators causing such devices to malfunction.

 **Observe these rules inside medical facilities:**

- Do not enter an operating room or an Intensive or Coronary Care Unit while carrying a mobile handset.
- Keep handset off in hospitals.
- Keep handset off in hospital lobbies. Electronic equipment may be near.
- Obey rules regarding mobile phone use in medical facilities.

 **Consult manufacturer for radio wave effects on electronic medical equipment.**

CAUTION

Handset, Battery & Charger



Handset care

- Place handset on stable surfaces to avoid malfunction or injury.
- Keep handset away from oily smoke or steam. Fire or accidents may result.
- Cold air from air conditioners may condense, resulting in leakage or burnout.
- Keep handset away from direct sunlight (inside vehicles, etc.) or heat sources. Distortion, discolouration or fire may occur. Battery shape may be affected.
- Keep handset out of extremely cold places to avoid malfunction or accidents.
- Keep handset away from fire sources to avoid malfunction or accidents.



Usage environment

- Excessive dust may prevent heat release and cause burnout or fire.
- Avoid using handset on the beach. Sand may cause malfunction or accidents.
- Keep handset away from credit cards, telephone cards, etc. to avoid data loss.

Handset



Handset temperature

Handset may become hot while in use. Avoid prolonged contact with skin especially at high temperature. May cause burn injuries.



Avoid leaving handset in extreme heat (inside vehicles, etc.).

Handset may become hot to the touch, leading to burn injuries.



Volume settings

Moderate handset volume; excessive volume may damage ears or hearing.



Inside vehicles

Handset use may cause electronic equipment to malfunction.



If you experience any skin irritation associated with handset use, discontinue handset use and consult a doctor.

Some materials may cause skin irritation, rashes, or itchiness depending on your physical condition.

Charger



Charger & In-Car Charger

- Grasp plug (not cord) to disconnect Charger. May cause fire/electric shock.
- Keep cord away from heaters. Exposed wire may cause fire or electric shock.
- Stop use if plug is hot or improperly connected. May cause fire/electric shock.
- Keep In-Car Charger socket clean. May overheat and cause injury.



Do not touch Desktop Holder while in use.

May cause burn injuries.



Use only the specified fuse.

1 A fuse for In-Car Charger. Or may cause damage/fire.



Always charge handset in a well-ventilated area.

Avoid covering/wrapping Charger and Desktop Holder. May cause damage/fire.



Do not use In-Car Charger when engine is off.

To avoid weakening the car battery, always start engine before charging the handset using In-Car Charger.



During periods of disuse

Always unplug AC Charger or In-Car Charger after use.



Handset maintenance

Always disconnect AC Charger or In-Car Charger when cleaning handset, to prevent shock/injury.



Installing In-Car Charger

Properly position the cable for safe driving to avoid injury or accidents.

Battery



Do not throw or abuse battery. Battery may overheat, burst or ignite.



Do not leave battery in direct sunlight or inside a closed vehicle; may reduce battery performance or overheat. An overheated battery may cause fire.



Do not expose battery to liquids. Performance may deteriorate.



If battery fluid contacts skin or clothes, rinse with clean water immediately.



Do not dispose of an exhausted battery with ordinary refuse; always tape over battery terminals before disposal. Take exhausted battery to a Vodafone shop, or follow the local disposal regulations.



Keep battery out of children's reach.



- Charge battery in ambient temperatures between 5°C and 35°C; outside this range, battery may leak/overheat and performance may deteriorate.
- If your child is using handset, explain all instructions and supervise usage.
- If there is abnormal odour or excessive heat, stop using battery and call Vodafone Customer Centre, Customer Assistance.
- Charge battery at least once every six months; an uncharged battery may become unusable.

General Notes

General Use

- Vodafone is not liable for any damages resulting from accidental loss/alteration of handset or Memory Card data. Keep a copy of Phone Book entries, etc. in a separate place.
- Handset transmissions may be disrupted inside buildings, tunnels or underground, or when moving into/out of such places.
- Use handset without disturbing others.
- Handsets are radios as stipulated by the Radio Law. Under the Radio Law, handsets must be submitted for inspection upon request.
- Handset use near landlines, TVs or radios may cause interference.
- **Beware of eavesdropping.**
Because this service is completely digital, the possibility of signal interception is greatly reduced. However, some transmissions may be overheard.

Eavesdropping

Deliberate/accidental interception of communications constitutes eavesdropping.

Inside Vehicles

- Never use handset while driving.
- Do not park illegally to use handset.
- Handset use may affect a vehicle's electronic equipment.

Aboard Aircraft

Never use handset aboard aircraft (keep power off).
Handset use may impair aircraft operation.

Electromagnetic Waves

For body worn operation, this phone has been tested and meets RF exposure guidelines when used with an accessory that contains no metal and that positions the handset a minimum of 15 mm from the body. Use of other accessories may not ensure compliance with RF exposure guidelines.

Handset Care

- If handset is left with no battery or an exhausted one, data may be altered/lost. Vodafone is not liable for any resulting damages.
- Use handset within temperatures of 5°C to 35°C and humidity 35% to 85%. Avoid extreme temperatures/direct sunlight.
- Exposing lens to direct sunlight may damage colour filter and affect image colour.
- Do not drop or subject handset to shocks.
- Clean handset with dry, soft cloth. Using alcohol, thinner, etc. may damage it.
- Do not expose handset to rain, snow or high humidity.
- Never disassemble or modify handset.
- Avoid scratching handset Display.
- When closing handset, keep straps, etc. outside to avoid damaging the Display.
- When using headphones, moderate volume to avoid sound bleed.
- **Handset is not water-proof. Avoid exposure to liquids and high humidity.**
 - Keep handset away from precipitation.
 - Cold air from air conditioning, etc. may condense causing corrosion.
 - Avoid dropping handset in damp places (toilet, bathroom, etc.).
 - On the beach, keep handset away from water and direct sunlight.
 - Perspiration may seep inside handset causing malfunction.

- **Avoid heavy objects or excessive pressure. May cause malfunction or injury.**
 - Do not sit down with handset in a back pocket.
 - Do not place heavy objects on handset in a bag.
- Connect only the specified products to Headphone Connector. Non-specified devices may malfunction or cause damage.
- Always turn off handset before removing battery. If battery is removed while saving data or sending mail, data may be lost, changed or destroyed.

Copyrights

Copyright laws protect sounds, images, computer programmes, databases, other materials and copyright holders. Duplicated material is limited to private use only. Use of materials beyond this limit or without permission of copyright holders may constitute copyright infringement, and be subject to criminal punishment. Comply with copyright laws when using images captured with handset camera.

FCC Notice

- This device complies with part 15 of the FCC Rules. Operation is subject to the following two conditions:
(1) This device may not cause harmful interference, and
(2) this device must accept any interference received, including interference that may cause undesired operation.
- Changes or modifications not expressly approved by the manufacturer responsible for compliance could void the user's authority to operate the equipment.

FCC RF Exposure Information

Your handset is a radio transmitter and receiver. It is designed and manufactured not to exceed the emission limits for exposure to radio frequency (RF) energy set by the Federal Communications Commission of the U.S. Government.

The guidelines are based on standards that were developed by independent scientific organisations through periodic and thorough evaluation of scientific studies. The standards include a substantial safety margin designed to assure the safety of all persons, regardless of age and health.

The exposure standard for wireless handsets employs a unit of measurement known as the Specific Absorption Rate, or SAR. The SAR limit set by the FCC is 1.6 W/kg.

The tests are performed in positions and locations (e.g., at the ear and worn on the body) as required by the FCC for each model. The highest SAR value for this model handset when tested for use at the ear is 0.280 W/kg and when worn on the body, as described in this user guide, is 0.741 W/kg. Body-worn Operation; This device was tested for typical body-worn operations with the back of the handset kept 1.5 cm from the body. To maintain compliance with FCC RF exposure requirements, use accessories that maintain a 1.5 cm separation distance between the user's body and the back of the handset. The use of beltclips, holsters and similar accessories should not contain metallic components in its assembly.

The use of accessories that do not satisfy these requirements may not comply with FCC RF exposure requirements, and should be avoided.

The FCC has granted an Equipment Authorisation for this model handset with all reported SAR levels evaluated as in compliance with the FCC RF emission guidelines. SAR information on this model handset is on file with the FCC and can be found under the Display Grant section of <http://www.fcc.gov/oet/fccid> after searching on FCC ID APYHRO00048.

Additional information on Specific Absorption Rates (SAR) can be found on the Cellular Telecommunications & Internet Association (CTIA) website at <http://www.phonefacts.net>.

European RF Exposure Information

Your mobile device is a radio transmitter and receiver. It is designed not to exceed the limits for exposure to radio waves recommended by international guidelines. These guidelines were developed by the independent scientific organization ICNIRP and include safety margins designed to assure the protection of all persons, regardless of age and health.

The guidelines use a unit of measurement known as the Specific Absorption Rate, or SAR. The SAR limit for mobile devices is 2 W/kg and the highest SAR value for this device when tested at the ear was 0.512 W/kg*. As mobile devices offer a range of functions, they can be used in other positions, such as on the body as described in this user guide**. In this case, the highest tested SAR value is 1.089 W/kg.

As SAR is measured utilizing the devices highest transmitting power the actual SAR of this device while operating is typically below that indicated above. This is due to automatic changes to the power level of the device to ensure it only uses the minimum level required to reach the network.

The World Health Organization has stated that present scientific information does not indicate the need for any special precautions for the use of mobile devices. They note that if you want to reduce your exposure then you can do so by limiting the length of calls or using a hands-free device to keep the mobile phone away from the head and body.

*The tests are carried out in accordance with international guidelines for testing.

Please see General Notes (Electromagnetic Waves) on **P.17-9 for important notes regarding body worn operation.

Declaration of Conformity

C E 0168

Hereby, Sharp Telecommunications of Europe Ltd, declares that this Vodafone 705SH is in compliance with the essential requirements and other relevant provisions of Directive 1999/5/EC.

A copy of the original declaration of conformity can be found at the following Internet address:

<http://www.sharp.co.jp/k-tai/>

Minding Mobile Manners

Please use your handset responsibly. Use these basic tips as a guide. Inappropriate handset use can be both dangerous and bothersome. Please take care not to disturb others when using your handset. Adjust handset use according to your surroundings.

- Turn it off in theatres, museums and other places where silence is the norm.
- Refrain from using it in restaurants, hotel lobbies, lifts, etc.
- Observe signs and instructions regarding handset use aboard trains, etc.
- Refrain from use that interrupts the flow of pedestrian or vehicle traffic.

Manner-Related Features

Take advantage of built-in features to help you use your handset in public places without disturbing or endangering others.

■ Manner Mode

Press Manner Key to automatically mute all Ringtones and activate Vibration mode for incoming calls, mail, etc.

■ Vibration Mode

Activate Vibration mode to use handset vibration to alert you to incoming calls, mail, etc. in public places.

■ Volume Settings

Decrease or mute Ringtone volume for incoming calls, mail, etc. as well as tones for Web or V-applications when carrying handset in public places.

■ Offline Mode

Use Offline Mode to temporarily suspend all handset transmissions. In Offline Mode, incoming/outgoing calls and Vodafone live! transmissions are blocked.

■ Answer Phone

Use Answer Phone to handle incoming calls when it is inappropriate or unsafe to answer.

Handset Parts & Functions

Handset

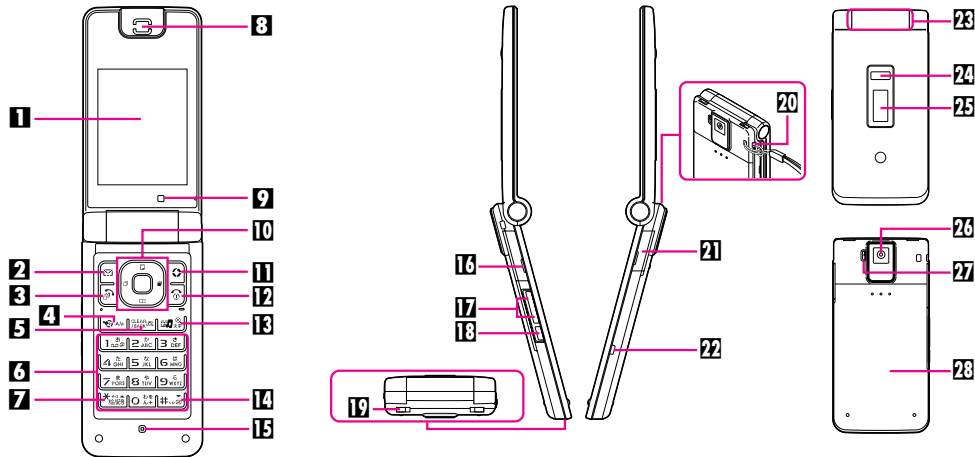

1 Display

2 Mail Key

Open Messaging menu or execute Soft Key functions.

3 Start Key

Initiate/answer calls. Open records of all calls.

4 Shortcuts & A/a Key

In Standby, open Shortcuts menu. In text entry windows, toggle upper/lower case roman letters or standard/small hiragana/katakana.

5 Clear/Back Key

Delete entries, escape/return to previous window.

6 Keypad

7 * Key

In text entry windows, open Symbol/Pictograph Lists.

8 Earpiece/Speaker

9 Internal Camera

Use during Video Call.

10 Multi Selector & Keypad Lock Key

Select menu items, move cursor, scroll, etc. In Standby, press for 1+ seconds to toggle Keypad Lock.

11 Vodafone Web Key

Open Vodafone Web menu or execute Soft Key functions.

12 Power On/Off Key

Press and hold to turn handset power on/off.

13 Multimedia/Text Key

Start Media Player or toggle between character entry modes. In Standby, press for 1+ seconds to activate/cancel Large Font Mode.

14 # Key

In text entry windows, enter comma, full stop, line break, space, etc.

15 Microphone**16 External Device Connector**

Connect Charger here.

17 Zoom/Volume Key

Select menu items, move cursor, etc. or adjust volume.

18 Privacy/Manner Key

Activate/cancel Privacy Filter. Press for 1+ seconds to activate/cancel Manner mode.

19 Charger Terminal**20 Strap Eyelet**

Attach straps as shown.

21 Video Out/Headphone/Optical Digital Line In Connector

Connect optional Headphones, Video Cable, etc.

22 Small Light**23 Internal Antenna Location****24 Infrared Port**

Use for infrared data transmissions.

25 External Display**26 External Camera (lens cover)****27 Portrait (👤)/Macro (🌸) Selector****28 Battery Cover****Note ▶ Internal Antenna**

- 705SH has no external antenna. Handset transmits/receives signals via Internal Antenna.
- Do not cover or place stickers, etc. over the area containing Internal Antenna.
- Voice quality varies with handset usage/location.
- For better reception in Standby, close handset.
- Avoid attaching metallic straps. Antenna sensitivity will be affected.

USIM Card

Universal Subscriber Identity Module (USIM) Card is an IC card containing customer and authentication information, including the handset number, and limited storage for Phone Book entries and SMS messages. USIM Card must be inserted to use this handset. Turn 705SH off before inserting/removing USIM Card.

- Do not force USIM Card into or out of handset; damage may result.
- Avoid touching USIM Card IC chip or terminals; doing so may hinder performance.
- Some handset files may be inaccessible after handset repair/upgrade or USIM Card replacement.

Inserting

- 1** Slide in USIM Card with IC chip facing down
- 2** Insert battery

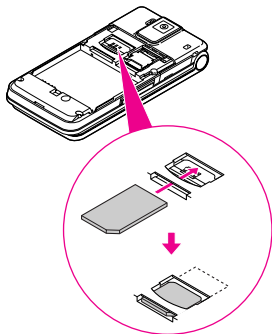

Removing

- Take care not to lose removed USIM Card.
- 1** Gently press and slide out USIM Card as shown
 - 2** Insert battery

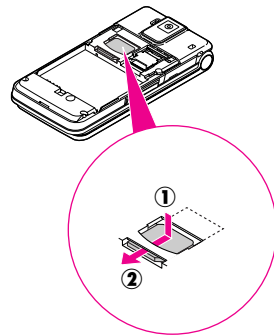

Battery & Charger

Charge battery before first use/after period of disuse.

■ Battery Life

- Do not use/store battery at extreme temperatures; this may shorten battery life. Ideally, use/store between 5°C - 35°C.
- Use specified Charger only; others may damage handset/battery or overheat or ignite battery.
- Replace battery if operating time shortens noticeably.

■ Charging

- Do not use Charger for other purposes.
- Contact with metal may short, overheat or burst battery.
- Small Light illuminates red while charging. (It may take longer for the light to illuminate when handset is off.)
- 705SH and Charger may warm during charging.
- Separate Charger from TV/radio if interference occurs.

■ Precautions

- Clean device charging terminals with a dry cotton swab.
- Avoid:
 - Extreme temperatures
 - Humidity, dust and vibration
 - Direct sunlight
- Charge battery at least once every six months; an uncharged battery may become unusable.
- Use a case when carrying battery separately.

■ Battery Disposal

Do not dispose of an exhausted battery with ordinary refuse; always tape over battery terminals before disposal. Take exhausted battery to a Vodafone shop, or follow the local disposal regulations.

Charging (Use Specified Charger Only)

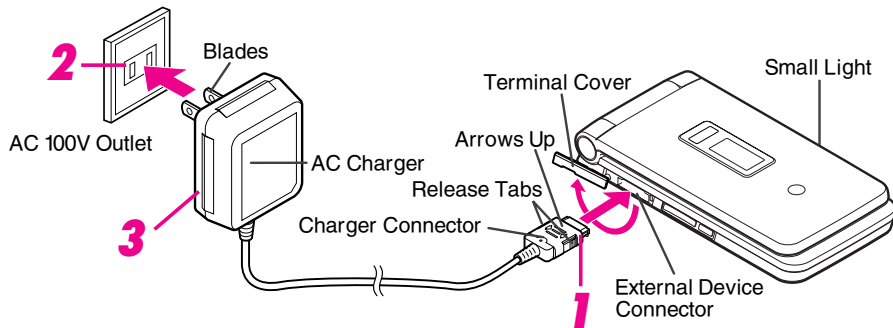

1 Open Terminal Cover to connect Charger

- Insert connector until it clicks.
- Use slot to gently pull Terminal Cover down and out as shown.

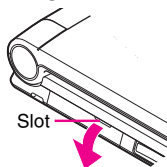

2 Plug Charger into AC outlet

- Charging starts and Small Light illuminates red. (Charging takes approximately \$\$\$ minutes.)
- Charging is complete when Small Light goes out.
- Extend Charger blades.
- (Fold back when not in use.)

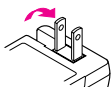

3 Unplug Charger from AC outlet, then 705SH

- Squeeze release tabs to remove connector.
- Replace Terminal Cover to protect External Device Connector.

- Note** ▶
- Do not pull, bend or twist AC Charger cord.
 - AC Charger is compatible with household currents between AC 100V and 240V.
 - Vodafone is not liable for problems resulting from charging 705SH abroad.

Main Display Indicators

The following indicators appear at the top of Display.

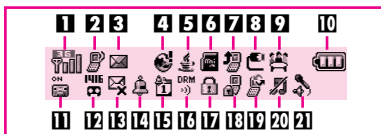

1 Network Service

: 3G, : GSM

Signal Strength

: Strong, : Moderate, : Low, : Weak

: Out-of-Range

2 : Incoming Voice Call, : Voice Call in Progress

: Video Call in Progress, : Offline Mode

: SSL, : Packet Transmission Ready

: Packet Transmission in Progress

3 Mail

: Unread Mail, : Unread Delivery Report

(red): Memory Low

: Receiving Mail, : Sending Mail

4 : Auto Delivery Info, : CAST Info

: Software Update, : Software Update Report

5 : Active V-application, (grey): Paused V-application

: Music Player Active

6 Memory Card Status

: Inserted, : In Use, : Formatting, : Unusable

7 : Call Forwarding or Voice Mail Active

Appears when **Always** (forwarding condition) is set.

: Multi Application Active

8 External Transmission

: USB Transmission Ready

: Infrared Connection in Progress

: Infrared Transmission in Progress

: Bluetooth® Transmission Ready

Appears in grey when Visibility is set to *Hide My Phone*.

: Bluetooth® Transmission in Progress

: Bluetooth® Talk in Progress

9 Mode

: Meeting, : Activity, : Car, : Headset, : Manner

10 Battery Strength

: Strong, : Moderate, : Low, : Empty

Indicator may appear vertically (e.g.).

11 : Answer Phone Active

: Answer Phone Active & Message Recorded

: Answer Phone Cancelled & Message Recorded

12 New Voice Mail

13 Message Delivery Failure

14 Alarm Set

15 : Schedule (Reminder Set)

: Schedule (Reminder Unset)

16 Copyright Information

: Content Key Received

When Content Key memory is low, (below 10 %) or

(below 5 %) appears.

17 Secret Mode Active

18 : Function Lock Active, : Keypad Lock Active

19 (grey): Infrared Transmission Ready

20 Ringtone/Vibration

: Silent, : Increasing Volume, : Vibration Active

: Silent & Vibration Active

21 : Loudspeaker Active, : Microphone Muted

External Display Indicators

See major External Display indicators below.

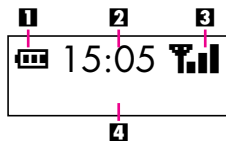

- 1 Battery Strength
- 2 Time
- 3 Signal Strength
- 4 Date

Incoming Communications

Indicator and number of calls/messages, etc. appear for missed calls, new mail/information, etc.

Missed Calls		Alarm	
Answer Phone Message		Calendar (Reminder set)	
New Messages		Tasks (Reminder set)	
New Delivery Report		Auto Delivery Info	
Message Delivery Failure		Bluetooth Notification	
CAST Info		CAST Info Reception Failure	
Content Key			

Up to two indicators appear at the same time. Press

or to view more.

Symbols

Multi Selector

Use Multi Selector to select menu items, move cursor, scroll, etc. In this manual, Multi Selector operations are indicated as follows:

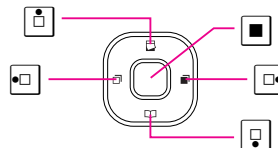

Basic Multi Selector Operations

- : Press or
- : Press or
- : Press , , , or

Menu Items

Use or to select menu items. (Example: Select *Text* and press .

USIM PINs

PIN1 & PIN2

PIN1	Prevent unauthorised use of Vodafone handset
PIN2	Required to clear Call Costs and to set Max Cost

- PIN1 and PIN2 are **9999** by default; change as needed.
- Activate PIN Entry to require PIN1 (4-8 digits) entry each time handset (USIM Card inserted) is turned on.

PIN Lock & Cancellation (PUK Code*)

PIN1 Lock or PIN2 Lock is activated if PIN1 or PIN2 is incorrectly entered three times consecutively. PUK Code is required to cancel PIN Lock. For details, contact Vodafone Customer Centre, General Information (see [P.17-45](#)).

*USIM Personal Unblocking Key (PUK Code) unblocks a USIM Card blocked after the wrong PIN has been entered three consecutive times. Each USIM Card has a unique PUK Code. Do not disclose it to unauthorised persons.

- Note** ▶
- If PUK Code is incorrectly entered ten times, USIM Card is locked and handset is disabled. Write down PUK Code.
 - For USIM Card unlocking procedures, call Vodafone Customer Centre, General Information (see [P.17-45](#)).

Security Codes

Handset Code, Centre Access Code and Network Password are needed for handset use.

Handset Code

9999 or the 4-digit number selected at initial subscription; required to use/change some handset functions. # appears when Handset Code is entered. If incorrect, **Handset code is incorrect!** appears; re-enter code.

Centre Access Code

The 4-digit number in the contract; required to access Voice Mail via landlines or subscribe to fee-based information.

Network Password

The 4-digit number selected at initial subscription; required to restrict handset services. If Network Password is incorrectly entered three times consecutively, Call Barring settings are locked. To resolve, Network Password and Centre Access Code must be changed. For details, contact Vodafone Customer Centre, General Information (see P.17-45).

- Note** ▶
- Write down Handset Code, Centre Access Code and Network Password. If lost, contact Vodafone Customer Centre, General Information (see P.17-45)
 - Do not reveal Handset Code, Centre Access Code and Network Password. Vodafone is not liable for misuse or damages.

- Tip** ▶
- Handset Code/Network Password are changeable.
 - Do not attempt to change Centre Access Code. Contact Vodafone Customer Centre, General Information (see P.17-45) for details.

Basic Handset Operations

Handset Power On/Off





Turning On

- 1 Open handset
- 2 Press and hold 

Turning Off

- 1 Open handset
- 2 Press  for 2+ seconds





English Display

- 1 Press , select **設定** and press 
- 2 Select *Language* and press 
- 3 Select *English* and press 





Your Phone Number

- 1 Press  
- 2 Press  to exit

Setting Clock

- 1 Press , select **Settings** and press 
- 2 Select **Date & Time** and press 
- 3 Select **Set Date/Time** and press 
- 4 Enter date and time (24-hour format) and press 

Network Services

- 1 Press , select **Settings** and press 
- 2 Select **Network Settings**
- 3 Select **Select Service** and press 
- 4 Select **3G**, **GSM** or **Auto** and press 
For **Auto**, 3G and GSM switch automatically by location (network status).

Initiating a Voice Call

Calling within Japan





- 1 Enter a phone number
- 2 Press 

Answering a Voice Call

- 1 When a call arrives, open handset
- 2 Press 

Placing an International Call





Service requires an additional contract, but no basic monthly charges or application fees.

- 1 Enter a phone number
- 2 Press  **Options**
- 3 Select **Int'l Call** and press 
- 4 Select a country and press 
- 5 Press 





Note ▶

- Omit the first 0 of the dialling code except when calling Italy or Russia.
- For details on placing international calls, contact Vodafone Customer Centre, General Information (see [P.17-45](#)).

Calling from Outside Japan

- 1 Enter a phone number
When calling landlines or mobile phones within the country, skip ahead to Step 5.
- 2 Press  **Options**
- 3 Select **Int'l Call** and press 
- 4 Select a country and press 
When calling Vodafone handsets, always select **日本 (JPN)**.
- 5 Press 



Redial

- 1 Press  ()
- 2 Select a record and press 
- 3 Press 



Calling from Received Calls

- 1 Press  ()
- 2 Select a record and press 
- 3 Press 

Initiating a Video Call





- 1 Enter a phone number
- 2 Press  **Options**
- 3 Select *Video Call* and press 

Answering a Video Call





- 1 When a call arrives, open handset
- 2 Press  to answer with voice and video image
To answer with voice only, press  **Options**, select *Hide Picture* and press 

Total Charges & Call Time

Total Charges



- 1 Press , select *Call Log* and press 
- 2 Select *Call Costs* and press 
- 3 Select *All Calls* and press 

Total Call Time

- 1 Press , select *Call Log* and press 
- 2 Select *Call Timers* and press 
- 3 Select *Received Calls* or *Dialled Calls* and press 







Muting Microphone

Even when handset microphone is muted, other party's voice can be heard through Earpiece.

- 1 During a call, press  **Mute**
- 2 Press  **Unmute** to cancel

Answer Phone & Voice Mail

Activate Answer Phone or transfer incoming calls to Voice Mail Centre to record caller messages.











	Answer Phone	Voice Mail
Message Recorded	Handset	Voice Mail Centre
Setting	Press [M] ➔ Select Tools ➔ Press [M] ➔ Select Answer Phone ➔ Press [M] ➔ Select Settings ➔ Press [M] ➔ Select Switch On/Off ➔ Press [M] ➔ Choose On ➔ Press [M]	Press [M] ➔ Select Settings ➔ Press [M] ➔ Select Call/Video Call ➔ Select Call Settings ➔ Press [M] ➔ Select Voicemail/Diverts ➔ Press [M] ➔ Select Voicemail ➔ Press [M] ➔ Select Activate ➔ Press [M] ➔ Select Always or No Answer ➔ Press [M] ➔ Select ring time (for No Answer) ➔ Press [M]
Additional Contract	Not Required	Not Required
Message Indicator	 / 	
Play	Press [M] ➔ Select Tools ➔ Press [M] ➔ Select Answer Phone ➔ Press [M] ➔ Select Play Ans. Phone ➔ Press [M]	Press [1.2.3] for 1+ seconds ➔ Follow the voice guidance after handset connects to Voice Mail Centre
Delete	During playback, press  Delete ➔ Press  Yes	After playback, press 
When Handset is Off	Not Available	Available
When Handset is Out-of-Range	Not Available	Available

Tip ➤ Activating Voice Mail cancels Call Forwarding for Voice Calls.

Forwarding a Call

Transfer incoming calls to a specified phone number.

Activating Call Forwarding

- 1 Press , select **Settings** and press 
- 2 Select **Call/Video Call**
- 3 Select **Call Settings** and press 
- 4 Select **Voicemail/Diverts** and press 
- 5 Select **Diverts** and press 
- 6 Select call type and press 
- 7 Select **Always** or **No Answer** and press 
- 8 Select **Enter Phone Number** and press 
- 9 Enter a forwarding number and press 
- 10 Select ring time and press  (for **No Answer**)

Note ▶ Activating Call Forwarding for Voice Calls cancels Voice Mail.

Manner Mode

Activate Manner mode for proper handset etiquette.

- 1 Press  for 1+ seconds
Default Manner Mode Settings:
 - ① Mutes Keypad Tones, Power On/Off sounds and error tones.
 - ② Simultaneously silences incoming and general volumes and activates vibration (customisable).

Tip ▶ **Cancelling Manner Mode**
 Press  for 1+ seconds.

Entering Characters

Entry Modes

Press  to toggle between character entry modes.

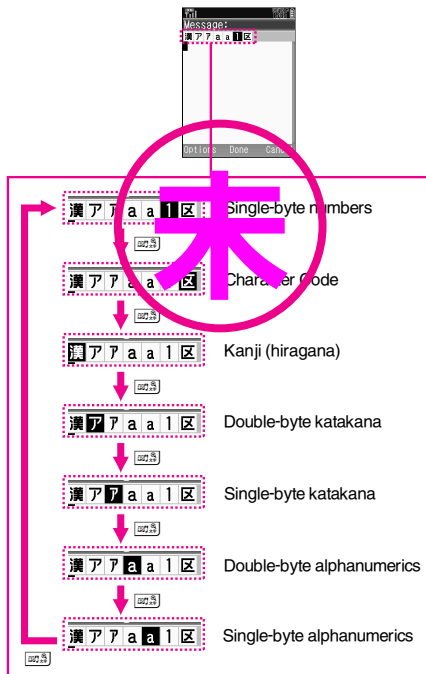

Key Assignments

Key	Single-byte Alphanumerics		Single-byte Numbers	Character Codes
	Upper/Lower Case	Lower Case		
	@/_-1 (Space)	@/_-1 (Space)	1	1
	ABCabc2	abc2	2	2
	DEFdef3	def3	3	3
	GHIghi4	ghi4	4	4
	JKLjkI5	jkI5	5	5
	MNOmno6	mno6	6	6
	PQRSpqrs7	pqrs7	7	7
	TUVtuv8	tuv8	8	8
	WXYZwxyz9	wxyz9	9	9
	0	0	0 + ¹	0
	Log List, Pictograph List, Single-byte Symbol List		* P (Pause) ? - ²	
	. . # (Line Break) ? ! (Space), Mail/Web Extensions ³		#	
	Cursor Up			
	Cursor Down # (Line Break)			
	Cursor Left			
	Cursor Right			
	Change Character Entry Mode			
	Toggle Case + Toggle Mode (upper/lower and lower case)			
	Delete One Character			Delete Code/One Character
	Delete before or after cursor			
	Recover up to 64 deleted characters ⁴			
	OK			



¹ Press for 1+ seconds to enter + (available for phone number entry).

² P (Pause), ? and - are for phone number entry. ³ Available for mail address/URL entry.

⁴ Press once for each character to recover immediately after deleting. (Not available after deleting text with (Long Press).)

Tip ▶ Entering Consecutive Characters Assigned to the Same Key

Press  to advance cursor; enter next character.
Editing Characters

Use  to select a character. Press  to delete it and then enter another.





Symbols, Pictographs & Emoticons

Symbols & Pictographs

1 In a text entry window, press  to open Symbol List

- Press  to toggle the list as follows: Symbol List → Pictograph Lists → Log List

2 Use  to select one and press 

3 Press a key ( -  or  - ) to exit list and enter the assigned character



- Tip ▶**
- Single-byte Symbols do not appear in Log List.
 - Symbols are double or single-byte according to the entry mode. (Pictographs are all double-byte.)

Emoticons

1 In a text entry window, press  **Options**

2 Select *Emoticons* and press 

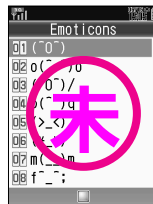

3 Select an emoticon and press 