

Accessories	20-2	■ Charging Battery	20-22	■ Manner Mode	20-27
Using This Manual	20-3	■ Inserting & Removing Battery ...	20-23	■ Forwarding a Call	20-27
Function & Feature Preview ...	20-4	■ Charging (Use Specified Charger Only) ...	20-24	■ Answer Phone & Voicemail ...	20-28
Safety Precautions	20-6	Getting Started	20-25	Basic Functions	20-29
General Notes	20-12	■ Handset Power On/Off ...	20-25	■ Text Entry	20-29
USIM Card	20-15	■ English Display	20-25	■ Phone Book	20-30
■ Inserting & Removing USIM Card ...	20-15	■ My Phone Number	20-25	■ Mobile Camera	20-31
■ USIM PINs	20-16	■ Setting Clock	20-25	■ Messaging	20-31
Security Codes	20-17	■ Network Services	20-25	■ Yahoo! Keitai	20-32
■ Handset Code	20-17	Basic Handset Operations	20-26	■ Total Charges & Call Time ...	20-32
■ Center Access Code	20-17	■ Initiating a Voice Call	20-26	Software Update	20-33
■ Network Password	20-17	■ Answering a Voice Call ...	20-26	Function List	20-35
Handset Parts & Functions	20-18	■ Initiating a Video Call	20-26	Specifications	20-37
■ Handset	20-18	■ Answering a Video Call ...	20-27	Customer Service	20-38
■ Display Indicators	20-20	■ Redial	20-27		
■ External Display Indicators ...	20-21	■ Calling from Received Calls ...	20-27		

For more information about handset operations and functions, please go to the SOFTBANK MOBILE Corp. Website (<http://www.softbank.jp>) for the full manual or dial 157 from a SoftBank handset for Customer Service.*

*Please note that the full manual may not be available in English at time of purchase. In this case, call Customer Service or check SoftBank Mobile Website again at a later date.

Accessories

■ Lithium-ion Battery (Type 1) (SHBBB1)

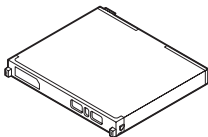

■ AC Charger (SHCAA1)

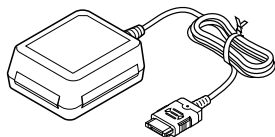

■ Utility Software (CD-ROM)**

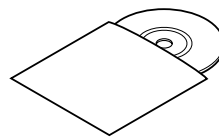

*Utility Software updates/upgrades may become available on the SOFTBANK MOBILE Corp. Website (<http://www.softbank.jp>) without prior notification. Please check for the newest versions of Utility Software and download as required.

**Complimentary sample not available for purchase.

Note ▶ Supplied Utility Software is designed exclusively for 814SH and 815SH.

- Tip** ▶
- For accessory-related information, please contact SoftBank Customer Center, General Information (P.20-38).
 - Handset takes microSD™ Memory Card (not included). Purchase one to use Memory Card functions.
 - In this manual, microSD™ Memory Card is referred to as "Memory Card."

Using This Manual

In this manual, most operations are described with SoftBank 814SH open in Standby. Sample screen shots, etc. are provided for reference only. Actual handset windows, menus, etc. may differ in appearance.

Keypad Keys

Indicated in this manual as shown below.

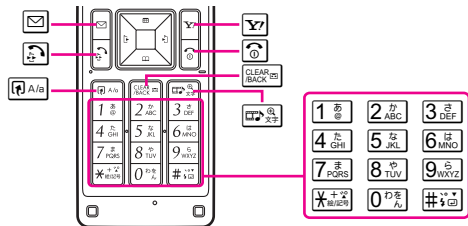

Multi Selector

Select menu items, move cursor and scroll, etc. In this manual, Multi Selector operations are indicated as shown to the right.

Basic Multi Selector Operations

- : Press or
- : Press or
- : Press , , or

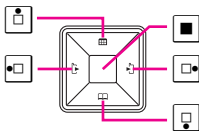

Side Keys

Indicated in this manual as shown below.
Activate/cancel Manner mode, adjust volume, etc.

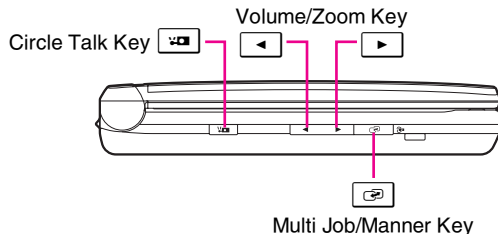

Japanese Functions & Services

When "(Japanese)" appears in a Function & Feature Preview title (P.20-4 & P.20-5), Japanese ability is required to use full range of the function or service.

Function & Feature Preview

Memory Card is required for items with gray background.

PC Site Browser

View PC-based websites on the handset directly, and access info on-the-go without using a PC.

Circle Talk

Press and hold one key to speak to up to ten parties simultaneously via this Walkie-Talkie type service.

S! Town (Japanese)

Select an avatar to enter 3D virtual town via this online communication application.

S! Loop (Japanese)

A SoftBank Mobile handset communication service.

e-Book/Document Viewer

Read e-Books, and e-Book dictionaries or documents (PDF files, etc.) on handset.

USIM Card

For use only with USIM Card-compatible SoftBank handsets; contains vital user information.

Manner Mode

Press a single key to mute ringer and activate Answer Phone automatically.

Simple Menu

Select a simplified menu, ideal for users who use only basic handset functions.

Phone Book

Save up to 750 entries; add up to five phone numbers/five mail addresses to each.

S! Address Book (SAB)

Back up Phone Book via Server; synchronize Phone Book/SAB to reflect changes.

Video Call

Place or receive video calls: send live video or previously saved still image during calls.

Camera

Capture still/video images shot with the 2.0 megapixel handset camera; send images via S! Mail.

Media Player

Play downloaded music and video images as well as those recorded/captured on handset.

Data Folder

Access handset image and sound files from here; files are organized by file type.

microSD™ Memory Card

Save files to Memory Card to expand handset memory or back up your handset files.

Display

Change Wallpaper, System Graphics, Fonts, et cetera to customize handset interface.

Display Language

Change Phone Settings to make handset user interface appear in either English or Japanese.

Custom Screen

Load uni-themed Wallpaper, Indicators, ringtones, and more, all at the same time.

Face Recognition

Save up to five facial images to use along with passwords, etc. to restrict handset access.

Bluetooth® & High-Speed Infrared

Wirelessly exchange handset files with compatible devices. Use Bluetooth® headsets, etc.

Mass Storage

Use a PC to directly access Memory Card content while card is inserted into handset.

Calendar & Tasks

Add events by date with time parameters; set Alarm, add stamps and set other options.

Barcode & Text Scanner

Scan UPC and QR Codes, as well as text. Create QR Codes from Phone Book entries, etc.

S! Mail

Exchange long messages; attach image/sound files or use Arrange Mail/Feeling Mail.

Yahoo! Keitai

Access Mobile Internet sites; download news/info as well as files for use on handset.

S! FeliCa (Japanese)

Hold handset over compatible reader/writers to use e-money services, etc. all around Japan.

S! Cast (Japanese)

Subscribe to Japanese mobile periodicals delivered overnight to your handset automatically.

Near Chat (Japanese)

Exchange instant messages with compatible Bluetooth® devices within ten meters.

Live Monitor (Japanese)

Downloaded news headlines, weather forecast or other info scrolls across Standby Display.

Software Update

Check for firmware updates and download as required.

Optional Services

Call Forwarding

Automatically divert all or all unanswered incoming calls to another preset phone number.

Voicemail

Redirect all or unanswered calls to Voicemail; access messages from handset/touchtone landline.

Missed Call Notification

Receive records of calls missed while handset is off/out-of-range and Voicemail is active.

Call Waiting

Reduce missed calls! Answer incoming calls even while the handset is already engaged.

Conference Call

Switch between open lines or connect multiple lines at once for wireless teleconferencing.

Call Barring

Restrict all incoming/outgoing calls or apply restrictions by type of call/current location.

Caller ID

Set handset to show/hide your phone number for all outgoing calls or enter show/hide prefix.



Safety Precautions



- Read safety precautions before using handset.
- Observe precautions to avoid injury to self or others, or damage to property.
- SoftBank is not liable for any damages resulting from use of this product.

Before Using Handset

■ Symbols

Make sure you thoroughly understand these symbols before reading on. Symbols and their meanings are described below:

 DANGER	Great risk of death or serious injury from improper use
 WARNING	Risk of death or serious injury from improper use
 CAUTION	Risk of injury or damage to property from improper use

	Prohibited Actions
	Compulsory Actions
	Attention Required

DANGER

Handset, Battery & Charger

Use specified battery, Charger and Desktop Holder only.

Using non-specified equipment may cause malfunctions, electric shock or fire due to battery leakage, overheating or bursting.

Do not short-circuit Charger terminals.

Keep metal objects away from Charger terminals. Keep handset away from jewelery. Battery may leak, overheat, burst or ignite causing injury. Use a case to carry battery.

Battery

Prevent injury from battery leakage, breakage or fire. Do not:





- Heat or dispose of battery in fire
- Open/modify/disassemble battery
- Damage or solder battery
- Use a damaged or deformed battery
- Use non-specified charger
- Force battery into handset
- Charge battery near fire or sources of heat; or expose it to extreme heat
- Use battery for other equipment

If battery fluid contacts eyes, do not rub them. Rinse with clean water and consult a doctor immediately.

Eyes may be severely damaged.

WARNING

Handset, Battery & Charger

-  **Do not insert foreign objects into the handset, Charger or Desktop Holder.**
Do not insert metal or flammable objects into handset, Charger or Desktop Holder; may cause fire or electric shock. Keep out of children's reach.
-  **Keep handset out of rain or extreme humidity.**
Fire or electric shock may result.
-  **Keep handset away from liquid-filled containers.**
Keep the handset, Charger and Desktop Holder away from chemicals or liquids; fire or electric shock may result.
-  **Keep battery, handset, Charger or Desktop Holder away from microwave ovens.**
Battery, handset, Charger or Desktop Holder may leak, burst, overheat or ignite, leading to accidents or injury.
-  **Do not disassemble or modify handset or related hardware.**
 - Do not open handset, Charger or Desktop Holder; may cause electric shock or injury. Contact SoftBank Customer Center, Customer Assistance for repairs.
 - Do not modify handset, Charger or Desktop Holder; fire or electric shock may result.

-  **Do not use Mobile Light near people's faces.**
May temporarily affect sight leading to accidents.

CAUTION:

Use of controls, adjustments or performance of procedure other than those specified herein may result in hazardous radiation exposure. As the emission level from Mobile Light LED used in this product is harmful to the eyes, do not attempt to disassemble the cabinet. Servicing is limited to qualified servicing station only.

-  **If water or foreign matter is inside handset:**
Discontinue handset use to prevent fire/electric shock. Turn off handset, remove battery and unplug Charger, then contact SoftBank Customer Center, Customer Assistance.

-  **Keep handset off and Charger disconnected near filling stations or places with fire/explosion risk.**
Handset use near petrochemicals or other flammables may cause fire/explosion; turn handset off before using S! FeliCa at filling stations (cancel IC Card Lock beforehand).

-  **Do not subject handset, Charger or Desktop Holder to strong shocks or impacts.**
 - Avoid strong shocks to AC Charger while it is plugged into the outlet; may cause malfunction or injury.
 - Strong shocks or impacts to handset, Charger or Desktop Holder may cause malfunction or injury. Should handset be damaged, remove battery then contact SoftBank Customer Center, Customer Assistance. Discontinue handset use; fire or electric shock may occur.



If an abnormality occurs:

If a handset emits an unusual sound, smoke or odor, discontinue use; may cause fire or electric shock. Turn off handset, remove battery and unplug Charger; contact SoftBank Customer Center, Customer Assistance.

Handset



Take measures to prevent accidents.

- Do not use handset while driving; park beforehand. Mobile phone use while driving is prohibited by the Road Traffic Law (revised November 1, 2004).
- Do not use Headphones while driving or cycling. Accidents may result.
- Moderate volume outside, especially near road/rail crossings, etc. to avoid accidents.



Do not swing handset by strap.

May result in injury or breakage.



Turn handset power off before boarding aircraft.

Using wireless devices aboard aircraft may cause electronic malfunctions or endanger aircraft operation.



Adjust vibration and ringtone settings:

Users with a heart condition/pacemaker/defibrillator should adjust handset settings accordingly.



During thunderstorms, turn power off; find cover.

There is a risk of lightning strike or electric shock.

Charger



Use only the specified voltage.

Non-specified voltages may cause fire or electric shock.

- **AC Charger: AC 100V-240V Input**
 - SoftBank is not liable for problems caused by charging battery abroad.
- **In-Car Charger: DC 12V-24V Input**



Do not use power adapters.

Using AC Charger with step-up/step-down transformer may cause fire, electric shock or damage.



Do not use In-Car Charger in positive earth vehicles.

Fire may result. Use in negative earth vehicles only.



Charger care

- Do not touch blades with wet hands. Electric shock may occur.
- Pull AC Charger straight out to unplug it; may cause malfunction or injury.
- Do not use multiple cords in one outlet; may cause excess heat/fire.
- Do not bend, twist, pull or set objects on cord. Exposed wire may cause fire or electric shock.



Do not short-circuit Charger terminals.

May cause overheating, fire or electric shock. Keep metal away from terminals.

 **Do not use Desktop Holder inside vehicles.**
Extreme temperature or vibration may cause fire or damage handset, etc.

 **Take measures to prevent accidents.**
Secure In-Car Charger to avoid injury or accidents.

 **Damaged AC Charger/In-Car Charger cord:**
May cause fire or electric shock; discontinue use and purchase a new Charger.

 **During thunderstorms:**
Unplug Charger to avoid damage, fire or electric shock.

 **Charger/Desktop Holder use and children:**
May cause electric shock/injury; keep out of reach.

Battery

 • If battery does not charge properly, stop charging. Battery may overheat, burst or ignite.
• If there is leakage or abnormal odor, avoid fire sources. It may catch fire or burst.

 If there is abnormal odor, excessive heat, discoloration or distortion, remove battery from handset. It may leak, overheat or explode.

Handset Use & Electronic Medical Equipment

This section is based on "Guidelines on the Use of Radio Communications Equipment such as Cellular Telephones and Safeguards for Electronic Medical Equipment" (Electromagnetic Compatibility Conference, April 1997) and "Report of Investigation of the Effects of Radio Waves on Medical Equipment, etc." (Association of Radio Industries and Businesses, March 2001).

 **Persons with implanted pacemaker/defibrillator should keep handset more than 22 cm away.**
Radio waves can interfere with implanted pacemakers or defibrillators causing such devices to malfunction.

 **Turn handset off in crowds or trains where persons with implanted pacemaker/defibrillator may be near.**
Radio waves can interfere with implanted pacemakers or defibrillators causing such devices to malfunction.

 **Observe these rules inside medical facilities:**
• Do not enter an operating room or an Intensive or Coronary Care Unit while carrying a handset.
• Keep handset off in hospitals, including lobbies.
• Obey medical facility rules on mobile phone use.

 **Consult electronic medical equipment vendor on radio wave effects.**

CAUTION

Handset, Battery & Charger



Handset care

- Place handset on stable surfaces to avoid malfunction or injury.
- Keep handset away from oily smoke or steam. Fire or accidents may result.
- Cold air from air conditioners may condense, resulting in leakage or burnout.
- Keep handset away from direct sunlight (inside vehicles, etc.) or heat sources. Distortion, discoloration or fire may occur. Battery shape may be affected.
- Keep handset out of extremely cold places to avoid malfunction or accidents.
- Keep handset away from fire sources to avoid malfunction or accidents.



Usage environment

- Excessive dust may prevent heat release and cause burnout or fire.
- Avoid using handset on the beach. Sand may cause malfunction or accidents.
- Keep handset away from credit cards, telephone cards, etc. to avoid data loss.

Handset



Handset temperature

Handset may become hot while in use. Avoid prolonged contact with skin especially at high temperature. May cause burn injuries.



Avoid leaving handset in extreme heat (inside vehicles, etc.).

Handset may become hot to the touch, leading to burn injuries.



Volume settings

Moderate handset volume; excessive volume may damage ears or hearing.



Inside vehicles

Handset use may cause electronic equipment to malfunction.



If you experience any skin irritation associated with handset use, discontinue handset use and consult a doctor.

Some materials may cause skin irritation, rashes, or itchiness depending on your physical condition.

Charger



Charger & In-Car Charger

- Grasp plug (not cord) to disconnect Charger. May cause fire/electric shock.
- Keep cord away from heaters. Exposed wire may cause fire or electric shock.
- Stop use if plug is hot or improperly connected. May cause fire/electric shock.
- Keep In-Car Charger socket clean. May overheat and cause injury.



Do not touch Desktop Holder while in use.

May cause burn injuries.



Use only the specified fuse.

1 A fuse for In-Car Charger. Or may cause damage/fire.



Always charge handset in a well-ventilated area.

Avoid covering/wrapping Charger and Desktop Holder; may cause damage/fire.



Do not use In-Car Charger when engine is off.

To avoid weakening the car battery, always start engine before charging the handset using In-Car Charger.



During periods of disuse

Always unplug AC Charger or In-Car Charger after use.



Handset maintenance

Always disconnect AC Charger or In-Car Charger when cleaning handset.



In-Car Charger installation

Properly position the cable for safe driving to avoid injury or accidents.

Battery



Do not throw or abuse battery. Battery may overheat, burst or ignite.



Do not leave battery in direct sunlight or inside a closed vehicle; may reduce battery performance or overheat. An overheated battery may cause fire.



Do not expose battery to liquids. Performance may deteriorate.



If battery fluid contacts skin or clothes, rinse with clean water immediately.



Do not dispose of an exhausted battery with ordinary refuse; always tape over battery terminals before disposal. Take battery to a SoftBank shop, or follow the local disposal regulations.



Keep battery out of children's reach.



• Charge battery in ambient temperatures between 5°C and 35°C; outside this range, battery may leak/overheat and performance may deteriorate.

• If your child is using handset, explain all instructions and supervise usage.

• If there is abnormal odor or excessive heat, stop using battery and call SoftBank Customer Center, Customer Assistance.

• Charge battery at least once every six months; an uncharged battery may become unusable.

General Notes

General Use

- SoftBank is not liable for any damages resulting from accidental loss/alteration of handset or Memory Card data. Keep a copy of Phone Book entries, etc. in a separate place.
- Handset transmissions may be disrupted inside buildings, tunnels or underground, or when moving into/out of such places.
- Use handset without disturbing others.
- Handsets are radios as stipulated by the Radio Law. Under the Radio Law, handsets must be submitted for inspection upon request.
- Handset use near landlines, TVs or radios may cause interference.
- **Beware of eavesdropping.** Because this service is completely digital, the possibility of signal interception is greatly reduced. However, some transmissions may be overheard.

Eavesdropping

Deliberate/accidental interception of communications constitutes eavesdropping.

Inside Vehicles

- Never use handset while driving.
- Do not park illegally to use handset.
- Handset use may affect a vehicle's electronic equipment.

Aboard Aircraft

Never use handset aboard aircraft (keep power off).
Handset use may impair aircraft operation.

Electromagnetic Waves

For body-worn operation, this phone has been tested and meets RF exposure guidelines when used with accessories containing no metal, that position handset a minimum of 15 mm from the body. Use of other accessories may not ensure compliance with RF exposure guidelines.

Handset Care

- If handset is left with no battery or an exhausted one, data may be altered/lost. SoftBank is not liable for any resulting damages.
- Use handset between 5°C - 35°C (35% - 85% humidity). Avoid extreme temperatures and direct sunlight.
- Exposing lens to direct sunlight may damage color filter and affect image color.
- Do not drop or subject handset to shocks.
- Clean handset with dry, soft cloth. Using alcohol, thinner, etc. may damage it.
- Do not expose handset to rain, snow or high humidity.
- Never disassemble or modify handset.
- Avoid scratching handset Display.
- When closing handset, keep straps, etc. outside to avoid damaging the Display.
- When using Headphones, moderate volume to avoid sound bleed.
- **Function Usage Limits**
These functions are disabled after handset upgrade/replacement or service cancelation: Camera; Media Player; S! Applications. After a period of disuse, these functions may be unusable; retrieve Network Information to restore usability.

- **Handset is not water-proof. Avoid exposure to liquids and high humidity.**
 - Keep handset away from precipitation.
 - Cold air from air conditioning, etc. may condense causing corrosion.
 - Avoid dropping handset in damp places (toilet, bathroom, etc.).
 - On the beach, keep handset away from water and direct sunlight.
 - Perspiration may seep inside handset causing malfunction.
- **Avoid heavy objects or excessive pressure. May cause malfunction or injury.**
 - Do not sit down with handset in a back pocket.
 - Do not place heavy objects on handset in a bag.
- **Connect only the specified products to AV OUT/ Headphone Port. Non-specified devices may malfunction or cause damage.**
- **Always turn off handset before removing battery. If battery is removed while saving data or sending mail, data may be lost, changed or destroyed.**

Copyrights

Copyright laws protect sounds, images, computer programs, databases, other materials and copyright holders. Duplicated material is limited to private use only. Use of materials beyond this limit or without permission of copyright holders may constitute copyright infringement, and be subject to criminal punishment. Comply with copyright laws when using images captured with handset camera.

FCC Notice

- This device complies with part 15 of the FCC Rules. Operation is subject to the following two conditions: (1) This device may not cause harmful interference, and (2) this device must accept any interference received, including interference that may cause undesired operation.
- Changes or modifications not expressly approved by the manufacturer responsible for compliance could void the user's authority to operate the equipment.

FCC RF Exposure Information

Your handset is a radio transmitter and receiver. It is designed and manufactured not to exceed the emission limits for exposure to radio frequency (RF) energy set by the Federal Communications Commission of the U.S. Government.

The guidelines are based on standards that were developed by independent scientific organisations through periodic and thorough evaluation of scientific studies. The standards include a substantial safety margin designed to assure the safety of all persons, regardless of age and health. The exposure standard for wireless handsets employs a unit of measurement known as the Specific Absorption Rate, or SAR. The SAR limit set by the FCC is 1.6 W/kg. Highest SAR value:

Model	FCC ID	At the Ear	On the Body
814SH	APYHRC00056	0.774 W/kg	0.640 W/kg
815SH	APYHRC00057	0.947 W/kg	0.666 W/kg

This device was tested for typical body-worn operations with the back of the handset kept 1.5 cm from the body. To maintain compliance with FCC RF exposure requirements, use accessories that maintain a 1.5 cm separation distance between the user's body and the back of the handset. The use of beltclips, holsters and similar accessories should not contain metallic components in its assembly.

The use of accessories that do not satisfy these requirements may not comply with FCC RF exposure requirements, and should be avoided.

The FCC has granted an Equipment Authorisation for this model handset with all reported SAR levels evaluated as in compliance with the FCC RF emission guidelines. SAR information on this model handset is on file with the FCC and can be found under the Display Grant section of <http://www.fcc.gov/oet/fccid> after searching on the corresponding FCC ID (see table on P.20-13).

Additional information on Specific Absorption Rates (SAR) can be found on the Cellular Telecommunications & Internet Association (CTIA) Website at <http://www.phonefacts.net>.

European RF Exposure Information

Your mobile device is a radio transmitter and receiver. It is designed not to exceed the limits for exposure to radio waves recommended by international guidelines. These guidelines were developed by the independent scientific organization ICNIRP and include safety margins designed to assure the protection of all persons, regardless of age and health.

The guidelines use a unit of measurement known as the Specific Absorption Rate, or SAR. The SAR limit for mobile devices is 2 W/kg. As mobile devices offer a range of functions, they can be used in other positions, such as on the body as described in this user guide*.

Highest SAR value:

Model	At the Ear**	On the Body
814SH	●● W/kg	●● W/kg
815SH	●● W/kg	●● W/kg

As SAR is measured utilizing the device's highest transmitting power the actual SAR of this device while operating is typically below that indicated above. This is due to automatic changes to the power level of the device to ensure it only uses the minimum level required to reach the Network.

The World Health Organization has stated that present scientific information does not indicate the need for any special precautions for the use of mobile devices. They note that if you want to reduce your exposure then you can do so by limiting the length of calls or using a hands-free device to keep the mobile phone away from the head and body.

*Please see General Notes (Electromagnetic Waves) on P.20-12 for important notes regarding body-worn operation.

**Values are measured in accordance with international guidelines for testing.

Declaration of Conformity

CE 0168

Hereby, Sharp Telecommunications of Europe Ltd, declares that 814SH and 815SH are in compliance with the essential requirements and other relevant provisions of Directive 1999/5/EC.

A copy of the original declaration of conformity for each model can be found at the following Internet address:
<http://www.sharp.co.jp/k-tai/>

USIM Card

Universal Subscriber Identity Module (USIM) Card is an IC card containing customer and authentication information, including the handset number, and limited storage for Phone Book entries and SMS messages.

Inserting & Removing USIM Card

USIM Card must be inserted to use this handset. Turn handset off before inserting/removing USIM Card.

- Do not force USIM Card into or out of handset; damage may result.
- Avoid touching USIM Card IC chip or terminals; doing so may hinder performance.
- Some downloaded files may be inaccessible after repairs, USIM Card replacement or handset upgrade/replacement.

- Follow these steps after removing battery.

Inserting

- 1 Slide in USIM Card with IC chip facing down
- 2 Insert battery

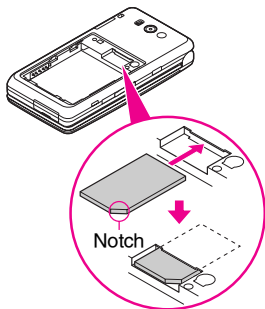

Removing

Take care not to lose removed USIM Card.

- 1 Gently slide out USIM Card as shown
- 2 Insert battery

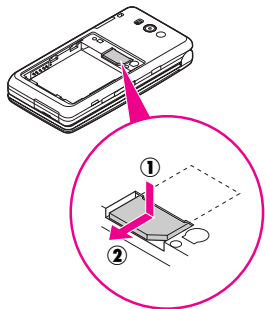

USIM PINs

PIN1 & PIN2

PIN1	A 4-digit Security Code to prevent unauthorized use of handset; required when PIN Entry is active
PIN2	Required to clear Call Costs and to set Max Cost

PIN1 and PIN2 are **9999** by default; change as needed.

PIN Lock & Cancelation (PUK Code*)

Entering incorrect PIN1 or PIN2 three consecutive times activates PIN1 Lock or PIN2 Lock. PUK Code cancels PIN Lock. Call SoftBank Customer Center, General Information (P.20-38) for details.

*USIM Personal Unblocking Key (PUK Code) unblocks a USIM Card blocked after the wrong PIN has been entered three consecutive times. Each USIM Card has a unique PUK Code. Do not disclose it to unauthorized persons.

- Note** ▶
- Entering incorrect PUK Code ten consecutive times locks USIM Card, disabling handset. Write it down.
 - To learn how to unlock USIM Card, call SoftBank Customer Center, General Information (P.20-38).

Security Codes

Handset Code, Center Access Code and Network Password are needed for handset use.

Handset Code

4-digit number (9999 by default) required to use or change some handset functions. ✖ appears as digits are entered. If *Handset code is incorrect!* appears, enter again.

Center Access Code

4-digit number selected at initial subscription; required to access Voicemail via landlines or subscribe to fee-based information.

Network Password

4-digit number selected at initial subscription; required to restrict handset services. If Network Password is incorrectly entered three times consecutively, Call Barring settings are locked. To resolve, Network Password and Center Access Code must be changed. For details, contact SoftBank Customer Center, General Information (P.20-38).

- Note** ▶
- Write down Handset Code, Center Access Code and Network Password.
 - Do not reveal Handset Code, Center Access Code and Network Password. SoftBank is not liable for misuse or damages.

Tip ▶ Handset Code/Network Password are changeable.

Handset Parts & Functions

Handset

814SH

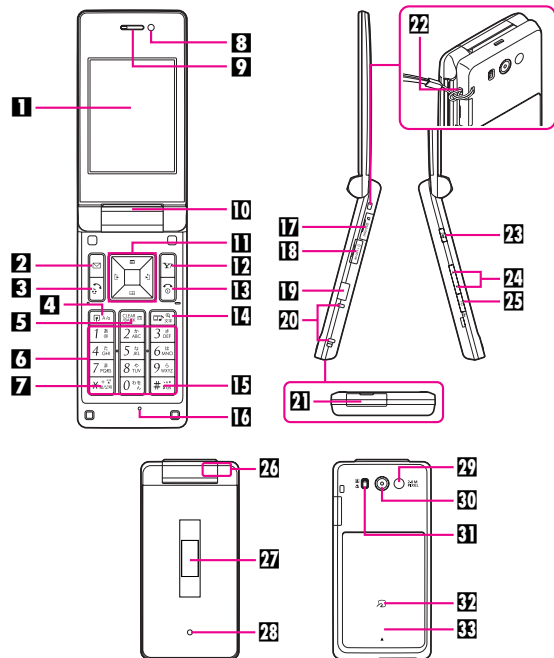

815SH

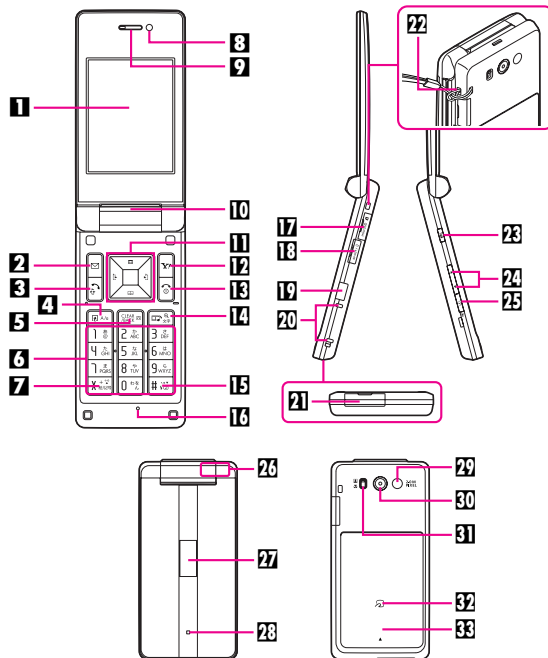

- 1 Display**
- 2 Mail Key**
Open Messaging menu or execute Soft Key functions.
- 3 Start Key**
Initiate/answer calls. Open records of All Calls.
- 4 Shortcuts & A/a Key**
Open Shortcuts menu. In text entry windows, toggle upper/lower case roman letters or standard/small hiragana/katakana.
- 5 Clear/Back Key**
Delete entries, escape/return to previous window.
- 6 Keypad**
- 7 * Key**
- 8 Internal Camera**
Use during Video Call.
- 9 Earpiece**
- 10 Speaker**
- 11 Multi Selector & Keypad Lock Key**
Select menu items, move cursor, scroll, etc. In Standby, press for 1+ seconds to activate/cancel Keypad Lock.
- 12 Yahoo! Keitai Key**
Open Yahoo! Keitai Main Menu or execute Soft Key functions.
- 13 Power On/Off Key**
Press and hold to turn handset power on/off.
- 14 Multimedia/Text Key**
Start Media Player or change character entry mode.
- 15 # Key**
- 16 Microphone**
- 17 Memory Card Slot**
Insert Memory Card here.
- 18 AV OUT/Headphone/Optical Digital Line-In Port**
Connect Headphones, Video Cable, etc.

- 19 Infrared Port**
Use for infrared data transmissions.
- 20 Charger Terminal**
- 21 External Device Port**
Connect Charger here.
- 22 Strap Eyelet**
Attach straps as shown; avoid metallic straps.
- 23 Circle Talk Key**
Press and hold to speak during Circle Talk.
- 24 Volume/Zoom Key**
Adjust Earpiece Volume or zoom mobile camera.
- 25 Multi Job/Manner Key**
Toggle multiple active function windows. Press for 1+ seconds to activate/cancel Manner mode.
- 26 Internal Antenna Location**
- 27 External Display**
- 28 Small Light**
Flashes for calls/new mail; illuminates red while charging.
- 29 Mobile Light**
Use as strobe/Pen Light.
- 30 External Camera (lens cover)**
- 31 Portrait (👤)/Macro (📷) Selector**
- 32 🔄 Logo**
S! FeliCa contactless IC Card embedded.
- 33 Battery Cover**

- Note ▶ Internal Antenna**
- Do not cover or place stickers, etc. over the area containing Internal Antenna.
 - Voice quality varies with handset usage/location.

Display Indicators

The following indicators appear at the top of Display.



1 Signal Strength

- : Within 3G Range, : Within GSM Range
- : Strong, : Moderate, : Low, : Weak
- out**: Out-of-Range

2 Incoming Voice Call, : Voice Call in Progress

- : Incoming Video Call, : Video Call in Progress
- : Incoming Circle Talk Request
- : Offline Mode, : SSL
- : Packet Transmission Protocol Ready
- : Waiting/Packet Transmission in Progress
- : Packet Transmission Available

3 Mail

- : Unread Mail, : Unread Delivery Report
- (red): Memory Low
- : Receiving Mail, : Sending Mail

4 Hot Status

- : Hot Status Online, : Unread Hot Status Notification
- : Hot Status Registration Request Received

5 : Cast Info, : Software Update

- : Software Update Result, : Live Monitor Info

6 : Active S! Application, : Paused S! Application

- : Music Player Active

7 Memory Card Status

- : Inserted, : In Use, : Formatting
- : Unusable/Poor Connection

8 : Multiple Functions (Multi Job) Active

- : IC Card Lock Active

9 : USB Transmission Ready

- : USB Transmission in Progress
- : Infrared Connection in Progress
- : Bluetooth® Transmission Ready
- Appears in gray when Visibility is set to *Hide My Phone*.

- : Bluetooth® Transmission in Progress

- : Bluetooth® Talk in Progress

- : Bluetooth® Audio Output in Progress

- : S! Address Book Transmission in Progress

- : PC Site Browser in Use

10 Mode

- : Manner, : Drive, : Original
- : Loudspeaker Active, : Microphone Muted
- : Loudspeaker Active & Microphone Muted

11 Battery Strength

- : Strong, : Moderate, : Low, : Empty
- Indicator may appear vertically (e.g.).

12 : Answer Phone Active

- : Answer Phone Active & Message Recorded
- : Answer Phone Canceled & Message Recorded

13 Call Forwarding or Voicemail Active

- Appears when **Always** (forwarding condition) is set for Voice Calls.

14 New Voicemail

15 Message Delivery Failure

16 📍: Alarm Set

📍: Schedule (Alarm Set), 📍: Schedule (Alarm Unset)

17 🔒: Secret Mode Active, 🔒: Password Lock Active

🔒: Keypad Lock Active

18 🔔 Ringtone/Vibration

🔔: Silent, 🔔: Increasing Volume, 🔔: Vibration Active

🔔: Silent & Vibration Active

19 ℹ️ Copyright Information

ℹ️: Content Key Received

When Content Key memory is low, ^{MEM} (below 10 %),



^{MEM} (below 5 %), etc. appear.

📶 (gray): Infrared Transmission Ready

20 📞 Auto Answer or Remote Monitor Active

21 🌤️ Weather Indicator

External Display Indicators

Press ,  or  with handset closed to turn External Display Backlight on. See major External Display indicators below.



1 Signal Strength

2 Battery Strength



3 Date

4 Time

Additional Indicators

Indicator and number of calls/messages, etc. appear for missed calls, new mail/information, etc.

Missed Calls	📞	New Delivery Report	📧
Answer Phone Message	📞	Message Delivery Failure	📧
Missed Call Notification	📞	Content Key	🔑
New Voicemail	📞	Bluetooth® Notification	📶
Alarm	🔔	New Cast Info	📺
Schedule Alarm	📅	Cast Reception Failure	📺
Task Alarm	📅	Hot Status Notification	📶
New Messages	📧	Weather Indicator Update	🌤️

Up to two indicators appear at the same time. Press  or  to view more.

Charging Battery

Battery & Charger

Charge battery before first use/after period of disuse.

■ Battery Life

- Do not use/store battery at extreme temperatures; this may shorten battery life. Ideally, use/store between 5°C - 35°C.
- Use specified Charger only; others may damage handset/battery or overheat or ignite battery.
- Replace battery if operating time shortens noticeably.

■ Charging

- Do not use Charger for other purposes.
- Contact with metal may short, overheat or burst battery.
- Small Light illuminates red while charging. (It may take longer for the light to illuminate when handset is off.)
- Handset and Charger may warm during charging.
- Separate Charger from TV/radio if interference occurs.

■ Precautions

- Clean device charging terminals with a dry cotton swab.
- Avoid:
 - Extreme temperatures
 - Humidity, dust and vibration
 - Direct sunlight
- Charge battery at least once every six months; an uncharged battery may become unusable.
- Use a case when carrying battery separately.

■ Battery Disposal

Do not dispose of an exhausted battery with ordinary refuse; always tape over battery terminals before disposal. Take exhausted battery to a SoftBank shop, or follow the local disposal regulations.

Inserting & Removing Battery

Inserting

- 1** Press down and slide cover as shown

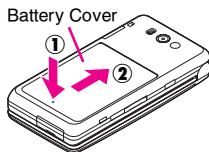

- 2** Lift and remove cover as shown

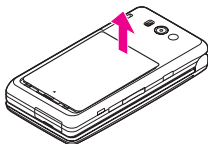

- 3** Insert battery
- With printed side up, fit tabs into battery cavity slots.

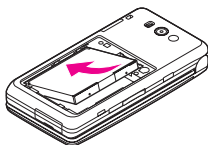

- 4** Close cover
- Position and slide the cover gently as shown until it stops.

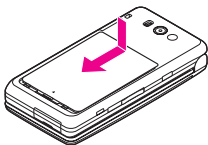

Removing

- Turn handset power off before removing battery.
- Do not remove battery immediately after saving files, sending messages, etc.

- 1** Perform Steps 1 - 2 on the left

- 2** Remove battery

- Take hold of Battery Tab here and lift as shown.

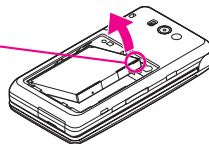

Charging (Use Specified Charger Only)

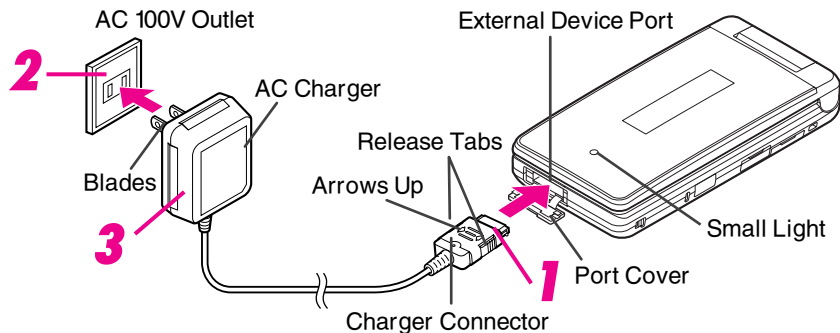

1 Open Port Cover to connect Charger

- Use slot to gently pull Port Cover down and out as shown.
- Insert connector until it clicks.

2 Plug Charger into AC outlet

- Small Light illuminates red while charging; may take up to approximately 150 minutes.
 - When charging completes Small Light goes out.
 - Extend Charger blades.
- (Fold back when not in use.)

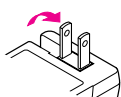
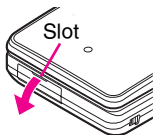

3 Unplug Charger, then disconnect handset

- Squeeze release tabs to remove connector.
- Replace Port Cover to protect External Device Port.

Note





- Do not pull, bend or twist AC Charger cord.
- Pull AC Charger straight out to unplug it.
- AC Charger is compatible with household currents between AC 100V and 240V.
- SoftBank is not liable for problems resulting from charging battery abroad.

Getting Started

Handset Power On/Off

Turning On





- 1 Open handset
- 2 Press and hold 

Tip ▶ If handset is in Japanese mode when turned on for the first time, press  three times then select はい and press . In Standby, press , select いいえ and press , then change to English mode (below).

Turning Off

- 1 Open handset
- 2 Press  for 2+ seconds





English Display

- 1 Press , select 設定 and press 
- 2 Select *Language* and press 
- 3 Select *English* and press 









My Phone Number

- 1 Press  
- 2 Press  to exit





Setting Clock

- 1 Press , select *Settings* and press 
- 2 In *Phone Settings*, select *Date & Time* and press 
- 3 Select *Set Date/Time* and press 
- 4 Enter date and time (24-hour format) and press 

Setting World Clock

- 1 Press , select *Tools* and press 
- 2 Use  to select *Tools 1*
- 3 Select *World Clock* and press 
- 4 Press 
- 5 Select *Set Time Zone* and press 
- 6 Use  to specify an area and press 
- 7 Press  to exit

Network Services

- 1 Press , select *Settings* and press 
- 2 Use  to select *Network Settings*
- 3 Select *Select Service* and press 
- 4 Select *Auto* or *Manual* and press 

Note ▶ For details, please see the full English manual.

Basic Handset Operations

Initiating a Voice Call

Calling within Japan





- 1** Enter a phone number
- 2** Press 

Tip ▶ Muting Microphone





During a call, press  **Mute**. To cancel, press  **Unmute**.

Placing an International Call

Service requires an additional contract, but no basic monthly charges or application fees.

- 1** Enter a phone number
- 2** Press  **Options**
- 3** Select **Int'l Call** and press 
- 4** Select a country and press 
- 5** Press 

Calling from Outside Japan

- 1** Enter a phone number
When calling landlines or mobile phones within the country, skip ahead to Step 5.
- 2** Press  **Options**
- 3** Select **Int'l Call** and press 
- 4** Select a country and press 
When calling SoftBank handsets, always select **日本 (JPN)**.
- 5** Press 



Note ▶

- Omit the first **0** of the area code except when calling Italy.
- For details, contact SoftBank Customer Center, General Information (P.20-38).

Answering a Voice Call



- 1** When a call arrives, open handset
- 2** Press 

Initiating a Video Call





- 1** Enter a phone number
- 2** Press  **Options**
- 3** Select **Video Call** and press 

Tip ▶ Alternatively, enter a phone number and press  for 1+ seconds to initiate a Video Call.





Answering a Video Call

- 1 When a call arrives, open handset
- 2 Press  **Answer**
- 3 Choose **Yes** and press 
 - To answer with voice only, choose **No**.

Redial

- 1 Press  ()
- 2 Select a record and press 
- 3 Press 

Calling from Received Calls

- 1 Press  ()
- 2 Select a record and press 
- 3 Press 

Manner Mode

Activate Manner mode for proper handset etiquette.











- 1 Press  for 1+ seconds
Manner Mode Settings:
 - ① Mutes Keypad Tones, Power On/Off sounds and error tones.
 - ② Simultaneously silences incoming and general volumes and activates vibration (default).

Tip ▶ **Canceling Manner Mode**
Press  for 1+ seconds.

Forwarding a Call



Transfer incoming calls to a specified phone number.

Activating Call Forwarding

- 1 Press , select **Settings** and press 
- 2 Use  to select **Call/Video Call**
- 3 Select **Voice/Video** and press 
- 4 Select **Diverts** and press 
- 5 Select call type and press 
- 6 Select **Always** or **No Answer** and press 
- 7 Select **Enter Number** and press 
- 8 Enter a forwarding number and press 
- 9 Select ring time and press  (for **No Answer**)

































Note ▶ Activating Call Forwarding for Voice Calls cancels Voicemail.

Canceling Call Forwarding

- 1 After Step 3 above, select **Cancel All** and press 
- 2 Choose **Yes** and press 

Answer Phone & Voicemail

Activate Answer Phone or transfer incoming calls to Voicemail Center to record caller messages.

	Answer Phone	Voicemail
Message Recorded	Handset	Voicemail Center
Additional Contract	Not Required	Not Required
Message Indicator	 / 	
When Handset is Off	Not Available	Available
When Handset is Out-of-Range	Not Available	Available
Activate	Press  ➔ Select Settings ➔ Press  ➔ Use  to select Call/Video Call ➔ Select Answer Phone ➔ Press  ➔ Select Switch On/Off ➔ Press  ➔ Choose On ➔ Press 	Press  ➔ Select Settings ➔ Press  ➔ Use  to select Call/Video Call ➔ Select Voicemail/Divert ➔ Press  ➔ Select Voicemail ➔ Press  ➔ Select Activate ➔ Press  ➔ Select Always or No Answer ➔ Press  ➔ Select ring time (for No Answer) ➔ Press 
Cancel	Press  ➔ Select Settings ➔ Press  ➔ Use  to select Call/Video Call ➔ Select Answer Phone ➔ Press  ➔ Select Switch On/Off ➔ Press  ➔ Choose Off ➔ Press 	Press  ➔ Select Settings ➔ Press  ➔ Use  to select Call/Video Call ➔ Select Voicemail/Divert ➔ Press  ➔ Select Cancel All ➔ Press  ➔ Choose Yes ➔ Press 
Play	Press  ➔ Select Phone ➔ Press  ➔ Select Play Messages ➔ Press 	Press  ➔ Select Phone ➔ Press  ➔ Select Call Voicemail ➔ Press  ➔ Follow the voice guidance after handset connects to Voicemail Center
Delete	During playback, press  Delete ➔ Choose Yes ➔ Press 	After playback, press 

Note ➤ Activating Voicemail cancels Call Forwarding for Voice Calls.

Basic Functions

Text Entry

Entry Modes

Follow these steps to change character entry mode.

1 Press

2 Use to select a mode and press

- For **Pictogram** or **Symbols**, corresponding list appears. (Entry mode remains unchanged.)
- Available Modes:

Menu Item	Indicator	Mode
Kanji	漢	Kanji (hiragana)
アイウ	ア	Double-byte katakana
アイウ	ア	Single-byte katakana
A b c	A	Double-byte alphanumerics (upper/lower case)
	a	Double-byte alphanumerics (lower case)
Abc	A	Single-byte alphanumerics (upper/lower case)
	a	Single-byte alphanumerics (lower case)
123	1	Single-byte number
Character Code	区	Character Code

A and a appear in upper/lower case mode. In double or single-byte alphanumerics mode, press to toggle between upper/lower case and lower case modes.

Basics

Multiple characters are assigned to each key. Press a key to toggle between character options for that key. Example: In double-byte katakana entry, press three times.



- Press to toggle options in reverse. (Not available for single-byte numbers or Character Codes.)

■ **Entering Characters Assigned to the Same Key**
When the next character is on the same key, press first to move cursor.

Example: In single-byte alphanumerics mode, enter *no*.





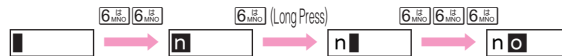

Press a key for 1+ seconds to enter the next character assigned to it and advance cursor.













Phone Book

Creating Phone Book Entries



Save names with phone numbers, mail addresses, etc. to Phone Book.

- 1** Press , select **Phone** and press 
- 2** Select **Add New Entry** and press 
- 3** Select **Last Name:** and press 
- 4** Enter last name and press 

Characters entered for last name appear under **Reading (Last Name):**
- 5** Select **First Name:** and press 
- 6** Enter first name and press 

Characters entered for first name appear under **Reading (First Name):**
- 7** Select **Add Phone Number:** and press 
- 8** Enter a phone number and press 
- 9** Select an icon and press 
- 10** Select **Add Email Address:** and press 
- 11** Enter a mail address and press 
- 12** Press 
- 13** Select an icon and press 
- 14** Press  **Save**

Dialing from Phone Book





- 1** In Standby, press 
- 2** Enter reading
- 3** Select a name and press 

Tip ▶ Multiple Numbers
Use  to select other numbers.

- 4** Press 







Changing Search Method

By Reading	Shows entries that start with specified Reading
By Category	Opens entries in the specified Category
By a-ka-sa-ta-na	Shows entries with Readings that start with katakana in the specified row









- 1** Press , select **Phone** and press 
- 2** Select **Ph.Book Settings** and press 
- 3** Select **Sort Entries** and press 
- 4** Select **By Reading**, **By Category** or **By a-ka-sa-ta-na** and press 

Mobile Camera

Capturing Still Images

- 1 Press , select **Camera** and press .
- 2 Frame image on Display
 - In Video Camera mode, press  () to switch to Photo Camera.
- 3 Press .
- 4 Press  to save
- 5 Press  to exit

Recording Video

- 1 Press , select **Camera** and press .
- 2 Press  ()
- 3 Frame image on Display
- 4 Press .
- 5 To stop, press .
- 6 To save, select **Save** and press .
- 7 Press  to exit

Messaging

Use SMS and S! Mail for messaging.

SMS

Use this basic messaging service to exchange short text messages of up to 160 alphanumeric with SoftBank handsets. This service is the ideal solution for fast and short text messaging!

S! Mail



Exchange text messages of up to 30,000 characters with e-mail compatible SoftBank handsets, other mobiles and PCs, etc. Attach image/sound files.

Note ▶ 814SH and 815SH are incompatible with Greeting, Coordinator, Relay Mail, Hotline and Polling service messages.

Tip ▶

- An additional contract is required to use S! Mail and receive e-mail from PCs, etc.
- Messages are stored in Server Mail Box, and delivered when recipient handset detects signal. Messages are deleted if not received by the specified expiry.

Receiving Text Messages

Delivery Notice appears and Information window opens ( appears) for new mail. Press  to open Received Msg. folder.

Opening Messages

- 1 Press **[F1]**, select *Messaging* and press **[F2]**
- 2 Select *Received Msg.*, *Drafts*, *Sent Messages* or *Unsent Messages* and press **[F2]**
 - For *Received Msg.* or *Sent Messages*, select a folder and press **[F2]**
- 3 Select a message and press **[F2]**

Sending Text Messages

- 1 Press **[F1]**, select *Messaging* and press **[F2]**
- 2 Select *Create Message (S! Mail)* or *Create New SMS* and press **[F2]**
- 3 Select recipient field and press **[F2]**
- 4 Enter a recipient
- 5 Enter subject and press **[F2]**
(S! Mail only)
- 6 Select **[F3]** (Text) and press **[F2]** then enter a message
 - For SMS, press **[F3]** or a key then enter a message.
- 7 Press **[F2]**
- 8 Attach files (S! Mail only)
Use **[F3]** to select **[F4]** (Attach) and press **[F2]**
- 9 When finished, press **[F7]** **[Send]** to send

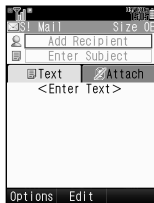

Mail Composition Window (S! Mail)

Yahoo! Keitai

- 1 Press **[F7]**
- 2 Select *メニューリスト* and press **[F2]**
- 3 Select *English* and press **[F2]**
- 4 Highlight a menu item and press **[F2]**
- 5 Repeat Step 4 to open additional links
- 6 To exit, press **[F6]** then choose *Yes* and press **[F2]**

Note ▶ Yahoo! Keitai Main Menu is subject to change.

Total Charges & Call Time

- 1 Press **[F1]**, select *Settings* and press **[F2]**
- 2 Use **[F3]** to select *Call/Video Call*
- 3 Select *Call Time & Cost* and press **[F2]**
- 4 *Total Charges*
 - 1 Select *Call Costs* and press **[F2]**
 - 2 Select *All Calls* and press **[F2]**
- 5 *Total Call Time*
 - 1 Select *Call Timers* and press **[F2]**
 - 2 Select *Dialled Calls* or *Received Calls* and press **[F2]**

Software Update

Check for firmware updates and download as required.

- Choose to begin update or schedule update.
- Handset is disabled until update is complete. Update may take up to approximately 30 minutes.





Precautions

Before updating software, turn power off to end all active functions/applications, then restart handset.



- Note** ▶
- Packet transmission fees do not apply to updates (including checking, downloading and rewriting).
 - Make sure signal is strong and stable beforehand.
 - Charge battery beforehand to reduce failure risk.
 - Do not remove battery; update may fail.
 - Disconnect USB Cable beforehand to reduce failure risk.

- Tip** ▶ Software Update information is also available on SoftBank Mobile Website (<http://www.softbank.jp>).

Updating Software

- 1 Press , select **Settings** and press .
- 2 In **Phone Settings**, select **Software Update** and press .
- 3 Select **Software Update** and press .

Confirmation appears.

- Follow onscreen instructions. ( appears during update.)
 - Update may take up to approximately 30 minutes.
 - When updated, a message appears and handset reboots; a completion message appears and Information window opens ( appears).
- While completion message appears, press  to acknowledge it and close Information window.

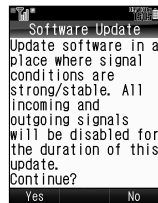



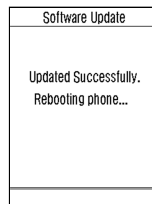



Confirmation



Update Complete

Update Result

- While Information window appears, select **Update Result** → Press 
 - Press  again to exit.
- In Standby, press  → Select **Settings** → Press  → Select **Software Update** → Press  → Select **Update Result** → Press 
 - Press  again to return.



Update Result

- Note** ▶
- Update failure may disable handset. Contact SoftBank Customer Center. Customer Assistance (P.20-38).
 - Phone Book entries, media files, and other handset contents are not affected by firmware updates, but always back up important information. (Some files cannot be copied.) SoftBank cannot be held liable for damages from lost information, etc.
 - If handset does not return to Standby after update, turn power off, reinsert battery, then restart it.

Scheduled Update

Confirmation appears at scheduled update time. Press  or wait about ten seconds for update to start.

- Update will not start if other functions are in use. After all operations end, a confirmation appears. If operations do not end within ten minutes, scheduled update is automatically canceled.
- Update automatically cancels Keypad Lock.

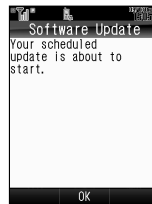

Confirmation

Function List

Main Menu	Sub Menu
Communication	S! Town
	S! Loop
	Hot Status
	Circle Talk
	Near chat
Yahoo! Keitai	Yahoo! Keitai
	Bookmarks
	Saved Pages
	Enter URL
	History
	Live Monitor
	PC Site Browser
	Common Settings
Media Player	Music
	Videos
	Streaming
	Settings
Messaging	Received Msg.
	Create Message
	Retrieve New Msg.
	Drafts
	Templates
	Sent Messages
	Unsent Messages
	Chat Folder
	Server Mail Box
	Create New SMS
	Settings
Memory Status	

Main Menu	Sub Menu	
Camera	—	
Data Folder	Pictures	
	DCIM	
	My Pictograms	
	Ring Songs•Tones	
	S! Appli	
	Music	
	Videos	
	Lifestyle-appli	
	Books	
	Custom Screens	
	Flash®	
Tools	Flash®Ringtones	
	Other Documents	
	Memory Status	
	Tools 1	Calendar
		Alarms
		Calculator
	Tools 2	Tasks
		World Clock
		Voice Recorder
		Document Viewer
		Stopwatch
	Tools 3	Countdown Timer
		Expenses Memo
Notepad		
Barcode		
	Phone Help	

Main Menu		Sub Menu
Entertainment		S! CAST/Weather Icon
		BookSurfing
		e-Book Viewer
S! Appli		S! Appli
		Settings
		Information
Lifestyle-appli		Lifestyle-appli
		IC Card Settings
Phone		Phone Book
		Add New Entry
		Information
		Call Log
		Play Messages
		Call Voicemail
		Category Control
		My Details
		Speed Dial List
		Mail Groups
		S! Address Book
		Ph.Book Settings
		Manage Entries
		Mode Settings
		Settings
Custom Screens		
Sounds & Alerts		
Date & Time		
言語選択 (Language)		
User Dictionary		
Ringer Output		
Earpiece Volume		
Change Menu		
Locks		
Software Update		
Master Reset		
Phone Settings		

Main Menu		Sub Menu
Settings	Connectivity	Bluetooth
		Infrared
		Mass Storage
		USB Charge
		Memory Card
	Call/Video Call	Call Time & Cost
		Answer Phone
		Voicemail/Divert
		Video Call
		Show My Number
		out Missed Calls
		Int'l Calling
		Disp. Time/Call
		Call Barring
		Minute Minder
	Auto Answer	
	Call Waiting	
	Network Settings	Select Network
		Select Service
		Offline Mode
Retrieve NW Info		
Location Info		
		Network Info

Specifications

■ SoftBank 814SH

Weight	Approximately 110 g
Continuous Talk Time	Approximately ●● minutes (3G) Approximately ●● minutes (GSM)
Continuous Standby Time (handset closed)	Approximately ●● hours (3G) Approximately ●● hours (GSM)
Continuous Video Call Talk Time	Approximately ●● minutes (with Internal Camera in use)
Charging Time (power off)	AC Charger: Approximately ●● minutes In-Car Charger: Approximately ●● minutes
Dimensions (W × H × D)	Approximately 49 × 98.8 × 18.2 mm (handset closed, without protruding parts)
Maximum Output	0.25 W (3G) 2.0 W (GSM)

- Values above were calculated with battery installed.
- Continuous Talk Time is an average measured with a new, fully charged battery, with stable signals. Continuous Talk Time may be less than half this value if signal is weak.
- Continuous Standby Time is an average measured with a new, fully charged battery, with handset closed without calls or operations, in Standby with stable signals. Standby Time may be less than half this value if handset is out-of-range/signal is weak. Standby Time may vary by environment: battery status, ambient temperature, etc.

■ SoftBank 815SH

Weight	Approximately 110 g
Continuous Talk Time	Approximately ●● minutes (3G) Approximately ●● minutes (GSM)
Continuous Standby Time (handset closed)	Approximately ●● hours (3G) Approximately ●● hours (GSM)
Continuous Video Call Talk Time	Approximately ●● minutes (with Internal Camera in use)
Charging Time (power off)	AC Charger: Approximately ●● minutes In-Car Charger: Approximately ●● minutes
Dimensions (W × H × D)	Approximately 49 × 98.8 × 18.2 mm (handset closed, without protruding parts)
Maximum Output	0.25 W (3G) 2.0 W (GSM)

- Values above were calculated with battery installed.
- Talk Time/Standby Time decreases with frequent use of Display/Keypad backlights.
- Talk Time/Standby Time may decrease when an S! Application is active.
- Talk Time/Standby Time decreases with handset use in poor signal conditions.
- Display employs precision technology, however, some pixels may appear brighter/darker.

Customer Service

For SoftBank handset or service information, call General Information. For repairs, call Customer Assistance.

SoftBank Customer Centers

From a SoftBank handset, dial toll free at **157** for General Information or **113** for Customer Assistance

SoftBank International Call Center

From outside Japan, dial **+81-3-5351-3491**
(International charges will apply.)

■ Call these numbers toll free from landlines.

Subscription Area	Service Center	Phone Number
Hokkaido, Aomori, Akita, Iwate, Yamagata, Miyagi, Fukushima, Niigata, Tokyo, Kanagawa, Chiba, Saitama, Ibaraki, Tochigi, Gunma, Yamanashi, Nagano, Toyama, Ishikawa, Fukui	General Information	☎ 0088-240-157
	Customer Assistance	☎ 0088-240-113
Aichi, Gifu, Mie, Shizuoka	General Information	☎ 0088-241-157
	Customer Assistance	☎ 0088-241-113
Osaka, Hyogo, Kyoto, Nara, Shiga, Wakayama	General Information	☎ 0088-242-157
	Customer Assistance	☎ 0088-242-113
Hiroshima, Okayama, Yamaguchi, Tottori, Shimane, Tokushima, Kagawa, Ehime, Kochi, Fukuoka, Saga, Nagasaki, Oita, Kumamoto, Miyazaki, Kagoshima, Okinawa	General Information	☎ 0088-250-157
	Customer Assistance	☎ 0088-250-113