

Introduction

Congratulations on your new Sharp SH1810C phone.

About This User Guide

This user guide is carefully designed to help you learn about your phone's features and operations quickly and effectively.

NOTICE

- We strongly recommend that you keep separate permanent written records of all important data. Data may be lost or altered in virtually any electronic memory product under certain circumstances. Therefore, we assume no responsibility for data lost or otherwise rendered unusable, whether as a result of improper use, repairs, defects, battery replacement, use after the specified battery life has expired or any other cause.
- We assume no responsibility, directly or indirectly, for financial losses or claims from third parties resulting from the use of this product and any of its functions, such as stolen credit card numbers, the loss or alteration of stored data, etc.
- All company and/or product names are trademarks and/or registered trademarks of their respective holders.

- Screen layout may differ from that illustrated in this user guide.
- The information described in this user guide is subject to change without notice.
- All the functions described in this user guide may not be supported by all networks.
- We assume no responsibility for downloaded contents, information, etc. from the network.
- Occasionally, a few black or bright pixels may appear on the screen. Please note that this will not have any impact on any of the features or on performance.

Intellectual Property Rights

According to copyright laws, the reproduction, alteration and use of material which is protected by copyright (music, pictures, etc.) is only permitted for personal or private use. If the user is not in possession of more extensive copyright or has not received the explicit permission from the copyright owner to reproduce, alter or use a copy which has been made or modified in this way, this is considered to be a violation of the copyright laws and gives the copyright owner the right to claim for damages. For this reason, avoid the illegal use of material which is protected by copyright.

Powered by JBlend™ Copyright 1997-2008 Aplix Corporation. All rights reserved.

JBlend and all JBlend-based trademarks and logos are trademarks or registered trademarks of Aplix Corporation in Japan and other countries.



Powered by Mascot Capsule®/Micro3D Edition™

Mascot Capsule® is a registered trademark of HI Corporation ©2002-2008 HI Corporation. All Rights Reserved.

The face detection technology utilized is FaceSolid™, a product of Morpho, Inc. FaceSolid™ is the trademark of Morpho, Inc.

XT9® is trademarks and/or registered trademarks of Nuance Communications, Inc. and/or its affiliates in the United States and/or other countries.



XT9 Mobile Interface is licensed under one or more of the following: U.S. Pat. Nos. 5,187,480, 5,818,437, 5,945,928, 5,953,541, 6,011,554, 6,286,064, 6,307,548, 6,307,549, 6,636,162, 6,646,573, 6,970,599, 6,801,190, 7,030,863, 7,088,345, 7,088,861, 7,164,367; Australia Pat. Nos. 727539, 746674, 747901; Austria Pat. Nos. AT225534, AT221222; Brazil P.I. No. 9609807-4; Canada Pat. Nos. 1,331,057, 2,227,904, 2,278,549, 2,302,595; People's Republic of China Pat. Nos. ZL89107372.8, ZL96196739.0, ZL98122778.3, ZL200410049543.9; European Pat. Nos. 0 842 463 (96927260.8), 1 010 057 (98903671.0), 1 018 069 (98950708.2); United Kingdom Pat. No. 2238414B; Hong Kong Standard Pat. No. HK1010924; Japan Pat. Nos. 3532780, 3492981; Republic of Korea Pat. Nos. KR201211B1, KR226206B1, 402252, 552085, 604039; Mexico Pat. Nos. 208141, 216023, 218409; New Zealand Pat. No. 519928; Russian Federation Pat. Nos. 2206118, 2214620, 2221268; Republic of Singapore Pat. Nos. 51383, 66959, 71976, 89076; Taiwan Pat. Nos. 169965, I263163; and additional patents are pending worldwide.

CP8 PATENT



microSDHC and microSD logos are trademarks.



The *Bluetooth*® word mark and logos are registered trademarks owned by the Bluetooth SIG, Inc. and any use of such marks by Sharp is under license. Other trademarks and trade names are those of their respective owners.



This product contains NF Browser and NF Messaging Client of ACCESS CO., LTD.

© 2008 ACCESS CO., LTD. All rights reserved.

ACCESS is a trademark or registered trademark of ACCESS CO., LTD. in the United States, Japan and other countries.

This software is based in part on the work of the Independent JPEG Group.

Microsoft®, Windows®, Windows Vista®, Outlook®, PowerPoint® and Excel® are registered trademarks of Microsoft Corporation in the United States and/or other countries.

Microsoft Word is a product name of Microsoft Corporation in the United States.

Adobe® and Acrobat® are trademarks of Adobe Systems Incorporated.

Adobe, the Adobe logo, FlashLite and the FlashLite logo are either trademarks or registered trademarks of Adobe Systems Incorporated in the United States and/or other countries.



**ADOBE
FLASH
ENABLED**

© 2003-2007 Adobe Systems Incorporated. All rights reserved.

picssel



"Document Viewer" is powered by Picssel Technologies. Picssel, Picssel Powered, Picssel Cube Logo, Picssel File Viewer and Picssel Document Viewer are Trademarks or Registered Trademarks

of the Picssel Group of Companies.

IrSS™, IrSimple™ and IrSimpleShot™ are trademarks or registered trademarks of the Infrared Data Association in the U.S.A. and/or in other countries.

This product is licensed under the MPEG-4 Visual Patent Portfolio License for the personal and non-commercial use of a consumer to (i) encode video in compliance with the MPEG-4 Video Standard ("MPEG-4 Video") and/or (ii) decode MPEG-4 Video that was encoded by a consumer engaged in a personal and non-commercial activity and/or was obtained from a licensed video provider. No license is granted or implied for any other use. Additional information may be obtained from MPEG LA.

See <http://www.mpegla.com>.

This product is licensed under the MPEG-4 Systems Patent Portfolio License for encoding in compliance with the MPEG-4 Systems Standard, except that an additional license and payment of royalties are necessary for encoding in connection with (i) data stored or replicated in physical media which is paid for on a title by title basis and/or (ii) data which is paid for on a title by title basis and is transmitted to an end user for permanent storage and/or use.

Such additional license may be obtained from MPEG LA, LLC.

See <http://www.mpegla.com> for additional details.

MPEG Layer-3 audio coding technology licensed from Fraunhofer IIS and Thomson.

QR Code is a trademark of DENSO WAVE INCORPORATED.

Contains iType™ font engine and font from Monotype Imaging Inc. Monotype® is a trademark of Monotype Imaging Inc. registered in the U.S. Patent and Trademark Office and may be registered in certain jurisdictions.

Copyright for Pictograph ©2008 Softbank Mobile Corp. or Sharp Corporation. All rights reserved.

Useful Functions and Services

Your phone offers you the following features:

- 3.0-inch full wide VGA (854 × 480 pixels) Advanced Super View (ASV) full colour LCD display with images that are clearer and easier to view.
- A built-in 8M pixel CCD digital camera with an auto focus function for taking pictures and video clips. A face AF function for taking pictures are also available.
- Motion control function for enabling easy operation without using any keys.
- A message function for reading and creating SMS messages.
- MMS (Multimedia Messaging Services) for sending picture, sound and video messages to brighten someone's day.
- Email for sending up to 300 KB and receiving mail with attachments.
- A colour WAP/Web browser for accessing information on the mobile Internet.
- Your own ringtones and ring video clips. You can use sound or video clip files as a ringtone or ring video clip.
- A music player that can play back MP3, MPEG-4 and 3GPP format sound files (supported codec of MPEG-4 or 3GPP are AMR, AAC, AAC+, and AAC+e).
- Playback of downloaded sound and video clip files.
- A voice recorder function for recording and playing back voice clips.
- A *Bluetooth*[®] wireless technology interface for establishing contact and transmitting data with certain devices. You can transmit pictures, sounds, and video clips to OBEX-enabled phones.
- An infrared interface for data communication. You can transmit pictures, sounds, and video clips to OBEX-enabled phones.
- A schedule alarm for creating and sending schedule entries with alarm settings.
- A calendar supporting the lunar calendar.
- A veilview function for guarding the screen display from being viewed by others.
- A microSD memory card slot that expands connectivity with a PC using the memory card.

Contents

Introduction	1	Entering Characters	31
List of Menu Functions	8	Changing the Input Language	31
Your Phone	10	Changing the Input Method	31
Optional Accessories	10	User Dictionary	34
Getting Started	11	Entering Pictograms and Symbols	35
Inserting/Removing the SIM Card and the Battery	14	Using Note	36
Charging the Battery	15	Copying, Cutting and Pasting Text	36
Inserting/Removing the Memory Card	16	Insert Phonebook Entries	36
Connecting the Handsfree Kit	17	Call Manager	37
Turning Your Phone On and Off	18	Sending a Message from the Phonebook	38
Display Indicators (Main Display)	19	Multimedia	43
Display Indicators (External Display)	20	Camera	47
Navigating Functions	21	Launching the Camera	47
Main Menu	21	Taking Pictures	47
Shortcut Keys	22	Recording Video Clips	47
Shortcuts	23	Common Functions in the Still and Video Camera Modes	48
Motion Control	24	Functions in Still Camera Mode	51
Voice Call Functions	27	Functions in Video Camera Mode	55

Messages	57	Connecting SH1810C to Your PC	122
SMS	57	System Requirements	122
MMS	57	GSM/GPRS Modem	122
Email	57	Handset Manager	123
Area Info	62	Music Manager	124
Browser	66	Sync Manager	126
Navigating a WAP or Web Page	66	Specifications	127
Gallery	69	Memory Card Structure and Contents	127
Java™	74	Safety Precautions and Conditions of Use	128
Organiser	78	Conditions of Use	128
SIM Application	94	Environment	130
Settings	95	Precautions Concerning Vehicle Use	130
Call Log	116	Out of Warranty List	132
Connectivity	118	Index	133
Bluetooth	118		
Infrared	120		
Mass Storage	120		
USB Charge	120		
Card Settings	121		

List of Menu Functions

SH1810C functions are listed below.

See relevant page for details of each function. The menu's corresponding number is used for shortcuts. For details, see page 22.

1 Java™		3 Organiser		4 Messages		6 Gallery	
1 Java™ Gallery	p. 74	(Tab 1: Tools 1)		1 Create Message	p. 57	1 Picture Gallery	p. 69
2 Java™ Settings	p. 75	1 Calendar	p. 78	2 Message	p. 59	2 Video Gallery	p. 70
3 Java™ Information	p. 77	2 Alarms	p. 82	3 Email	p. 59	3 Sound Gallery	p. 70
2 Browser		3 Tasks	p. 83	4 Cell Broadcasts	p. 61	4 Themes	p. 71
1 Homepage	p. 66	4 Calculator	p. 85	5 Area Info	p. 62	5 Java™ Gallery	p. 74
2 Bookmarks	p. 66	5 Expenses Memo	p. 86	6 Messaging Settings	p. 62	6 Flash®	p. 71
3 My Saved Page	p. 66	(Tab 2: Tools 2)		7 Memory Status	–	7 Other Documents	p. 71
4 Go to URL	p. 66	1 Stopwatch	p. 87	5 Camera	▶ p. 47	9 Memory Status	p. 73
5 Access History	p. 66	2 Countdown Timer	p. 87	1 Still Camera	p. 47	7 Multimedia	
6 Browser Settings	p. 67	3 World Clock	p. 87	2 Video Camera	p. 47	1 Music Player	p. 43
		4 Hour Minder	p. 88	3 Barcode/Scan	p. 53	2 Video Player	p. 44
		(Tab 3: Tools 3)		4 Review	p. 60	3 Streaming Player	p. 46
		1 Document Viewer	p. 88	5 Still Camera Settings	–		
		2 Notepad	p. 89	6 Video Camera Settings	–		
		3 Voice Recorder	p. 89				
		4 Scanner	p. 90				
		5 Phone Help	p. 93				
		6 Scratch Pad	p. 93				

8 Call Manager		9 Settings		(Tab 2: Call Settings)		10 SIM Application* ▶ p. 94			
1	Phonebook	p. 37	(Tab 1: Phone Settings)	1	Answer Phone	p. 107	11 Call Log		
2	Add New	p. 37	1	Profiles	p. 95	2	Dialled Numbers	p. 116	
3	Play Messages	p. 41	2	Display Settings	p. 96	3	Missed Calls	p. 116	
4	Call Voicemail	–	3	Themes	p. 100	4	Received Calls	p. 116	
5	Manage Groups	p. 41	4	Sound Settings	p. 100	5	Call Timers	p. 116	
6	My Card	p. 37	5	Date & Time	p. 103	6	Call Costs*	p. 116	
7	Speed Dial List	p. 42	6	Language	p. 104	7	Data Counter	p. 117	
8	Message Groups	p. 38	7	Motion Control	p. 24, p. 104	8	Display Call Timer	p. 112	
9	Phonebook Settings	p. 37	8	Switch Ringtone Output	p. 105	9	Display Call Cost	p. 112	
10	Service Dialling No.*	p. 38	9	Earpiece Volume	–	10	Auto Redial	p. 112	
11	Advanced	p. 39	10	Change Menu	p. 105	(Tab 3: Network Settings)	1	Network Settings	p. 113
			11	Security Settings	p. 105	2	Off Line Mode	p. 113	
			12	Master Reset	p. 106	3	Internet Settings	p. 113	
							12 Connectivity		
							1	Bluetooth	p. 118
							2	Infrared	p. 120
							3	Mass Storage	p. 120
							4	USB Charge	p. 120
							5	Card Settings	p. 121

* Depends on SIM card contents.

Your Phone

Please check the following carefully. Your phone should come complete with:

- EDGE/GSM 900/1800/1900 GPRS phone
- Rechargeable Li-ion Battery
- AC Charger
- Stereo Handsfree
- USB Data Cable
- CD-ROM
- User Guide
- Supplementary Manual
- Quick Start Guide
- Warranty Card
- Service Centre List

Optional Accessories

- Li-ion Spare Battery (XN-1BT22)
- USB Data Cable (XN-1DC31)
- AC Charger (including USB Data Cable) (XN-1QC75)
- Stereo Handsfree (XN-1ER90)

Note

- *Use only the accessories supplied or accessories approved by Sharp.*

Getting Started

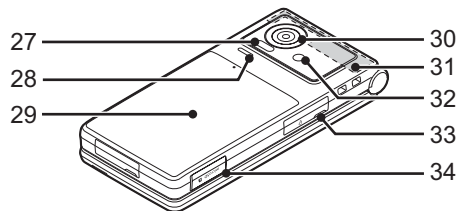
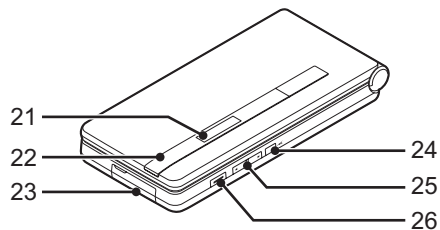
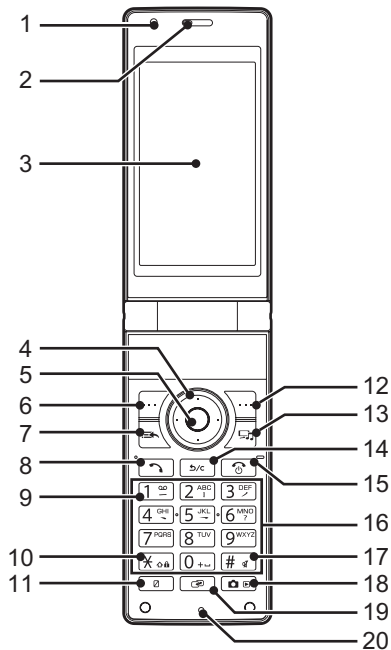



1. **Light Sensor**
2. **Earpiece**
3. **Main Display**
4. **Navigation Keys (Arrow Keys):** 

Moves cursor to highlight a menu item, etc.



Up arrow key () displays the Calendar and Tag when pressed in standby.

Down arrow key () displays the Phonebook entries when pressed in standby.

Left arrow key () displays the Java™ Gallery list when pressed in standby.

Left arrow key () switches Bluetooth on/off when long pressed in standby.

Right arrow key () displays Gallery when pressed in standby.

Right arrow key () switches the infrared setting on/off when long pressed in standby.
5. **Centre Key:** 

Displays Main menu in standby, and executes functions.

Long press in standby to initiate video camera.
6. **Left Soft Key:** 

Executes the function in the lower left of the screen.

Displays Message menu in standby.
7. **Shortcut Key:** 

Displays Shortcut menu.
8. **Send/Redial Key:** 

Makes voice calls or accepts calls, and displays the call logs in standby.
9. **Voicemail Key:** 

Long press to connect to the Voicemail centre. (Depending on the SIM card.)
10. *** /Shift Key:** 

Switches character input method as follows on the text entry screen.

Abc, ABC, abc, 123, XT9 PinYin, and XT9 Stroke

Press to enter +, P, ?, - or * in standby.

Long press in standby to lock the keypad.
11. **VeilView Key:** 

Long press to switch veilview on/off.
12. **Right Soft Key:** 

Executes the function in the lower right of the screen.

Opens the browser in standby.

Long press in standby to display Browser menu.
13. **Multimedia Key:** 

Displays Multimedia menu in standby.

Long press in standby to change menu display.
14. **Clear/Back Key:** 

Clears the characters before the cursor, returns to the previous screen, etc.

Plays messages when pressed in standby.

Long press in standby to switch answer phone on/off.

15. End/Power Key: 

Ends a call.

Long press to turn power on/off.

16. Keypad

17. #/Silent Key: 

Displays symbol and pictogram screen on the text entry screen.

Long press to switch languages on the text entry screen.

Long press in standby to switch Profiles settings between the mode most recently activated and Silent mode.

18. Camera Key: 

Activates the camera.

Long press to display the data taken the last time.

19. Profile Menu Key: 

Displays Profile menu in standby.

Long press to switch the Silent profile on/off.

20. Microphone

21. External Display

22. Small Light:

Flashes when an incoming call or a new message is received or missed, if Event Light (p. 95) or Status Light (p. 95) is enabled.

23. External Connector:

Used to connect either the AC charger or a USB data cable.

24. Mobile Light Key: 

When the phone is open and the camera is active:

Press to change the Mobile Light mode.

When in standby with the phone either open or closed:

Long press to turn on the Mobile Light.

25. Side Volume Keys: 

Press during a call to increase or decrease the earpiece volume.

Press while listening to music (or video) to increase or decrease the earpiece volume.

26. Side Shutter Key: 

When the camera is active:

Takes a picture or starts recording a video.

Press halfway to lock the focus.

27. Infrared Port:

Sends and receives data via infrared.

28. Speaker

29. Battery Cover

30. Camera

31. Built-in Aerial:

Warning: Do not cover the hinge area of the phone with your hand when in use as this may interfere with the performance of the built-in aerial.

32. Mobile Light:

Used as an auxiliary light.

33. Handsfree Kit/Microphone Connector

34. microSD Card Slot

Inserting/Removing the SIM Card and the Battery

1. Slide off the battery cover (① ②).

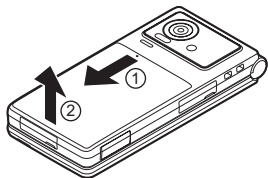

2. Slide the SIM card into the SIM holder ③.

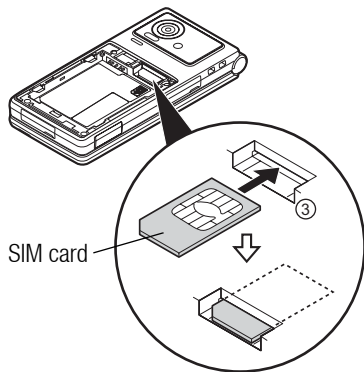

3. Hold the battery so that the metal contacts of the battery are facing down, slide the guides on the top of the battery into the battery slots ④, and then insert it ⑤.

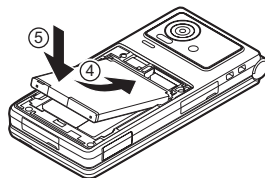

4. Replace the battery cover.

Note

- Make sure that only 3V SIM cards are used.
- Make sure that the standard Sharp accessory battery is used.

Battery Disposal

The device is battery-powered. In order to protect the environment, please read the following points concerning battery disposal:

- Take the used battery to your local waste depot, dealer or customer service centre for recycling.
- Do not expose the used battery to a naked flame, immerse in water or dispose with the household waste.

Charging the Battery

Using the Charger

1. Connect the USB interface of the cable to the provided AC charger ①. Open the cover of the external connector, and connect the provided USB data cable horizontally to the external socket located at the bottom of the phone until it clicks ②.

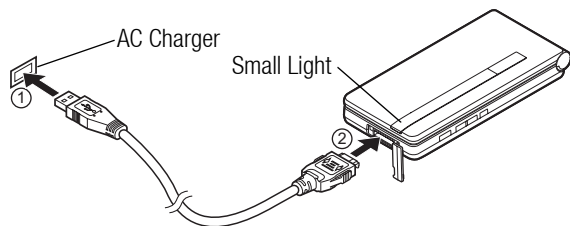

2. Connect the AC charger to an AC outlet.
When the phone is charging, the battery status icon () displays the current status. The Small Light also lights up.

Note

- Charging time may vary depending on the state of the battery and other conditions. (See "Battery" on page 129.)

- If you connect the USB interface of the cable to a PC's USB port when your phone is turned on, you can charge the battery using the PC. Note the following when charging your phone with a PC:
 - Be sure that the PC is powered from an AC outlet.
 - Install the USB driver from the provided CD-ROM before charging.
 - It is recommended that you use the AC charger when you wish to fully charge the battery.

To Disconnect the Charger

1. Unplug the AC charger from the AC outlet.
2. Push and hold the side buttons of the USB data cable ①, then disconnect the cable from the external socket of the phone ②.

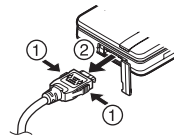

3. Close the cover.



Note

- Do not use any non-approved chargers as they may damage your phone and invalidate any warranties, see "Battery" on page 129 for details.
- Forcibly disconnecting the charger may cause malfunction.





Battery Level Indicator

The current battery level is displayed in the upper right of the screen.

Low Battery during Use

When the battery is running low, an alarm will sound and “” or “” is displayed on the screen.

If you are using your phone and you hear the low battery alarm, attach your charger as soon as possible. The phone may not be able to continue normal operation if you continue to use it.

Battery Indicators	Charge Level
	Sufficiently charged
	Charging recommended
	Charging required
	Empty

Inserting/Removing the Memory Card

Note

- *Make sure that the phone is turned off before inserting/removing the memory card.*
- *Be sure to insert the card in the correct direction and orientation.*
- *Keep all memory cards out of the reach of small children.*

1. Turn off the phone.
2. Open the microSD card slot cover.

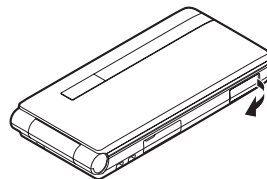

3. Insert the memory card until it clicks. (To remove the memory card, push the memory card until it clicks.)

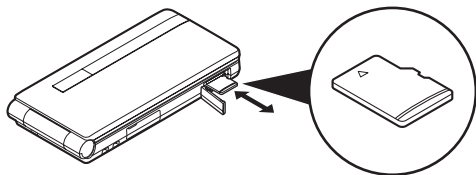



4. Close the cover.

Tip

- You see the following indicators when the memory card is in use:

 : Appears when the card is inserted.

 : Appears when the card is damaged or unusable. Make sure the card is properly inserted.

 : Appears when the card is being accessed.

 : Appears when the card is being read.

 : Appears when the card is being formatted.

Connecting the Handsfree Kit

1. Open the connector cover.
2. Connect the handsfree kit.

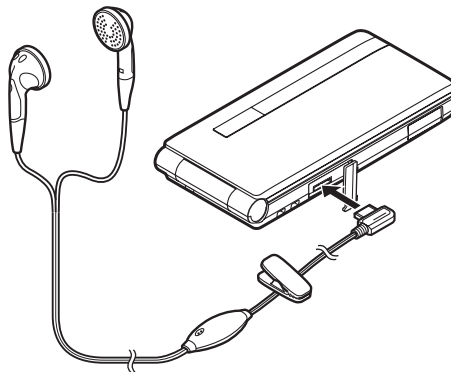

Turning Your Phone On and Off

To turn the power on or off, long press  for approximately 2 seconds.

To Enter the PIN Code

If the PIN (Personal Identification Number) code is enabled you are asked to enter the PIN code each time the phone is switched on. For details on setting the PIN code, see “Enabling/Disabling the PIN Code” on page 105.

1. Enter your PIN code.

The PIN code is 4 to 8 digits.

2. Press .

Note

- If your PIN code is entered incorrectly three times in a row, the SIM card is locked. See “Enabling/Disabling the PIN Code” on page 105.
- If the clock settings have not been entered, the date and time entry screen is displayed (p. 103).

To Copy All Phonebook Entries from the SIM Card







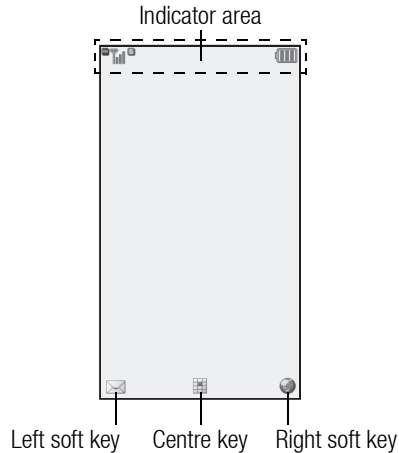









“Call Manager” → “Advanced” → “Copy All Entries”

1. Select “From SIM to Handset”.

Display Indicators (Main Display)













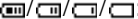

1. / : Strength of received signal/Service out of range
 : EDGE
 : GPRS enabled
 : Roaming outside network
2. / : Connection to the server [established/communicating]
3. / : Voice call [incoming/in progress]
4. / : Alerts [text message and multimedia message/Email]
5. : Mailbox full
6. : "Voice Calls" diverts set to "Always"
7. / / / / / / / :
 Connection status
 [USB data cable [standby or connected to a USB device/exchanging information]/IrDA setting [standby/exchanging information]/*Bluetooth* wireless setting [standby/exchanging information/talking with the *Bluetooth* headset/Hide my phone]]
8. / / : Java™ application [executed (colour)/suspended (grey)]/Music Player

9. : Secure WAP/Web page displayed
10. : Silent/vibration setting [silent/vibration enabled/silent and vibration enabled]
11. : Speaker mode [speaker phone on/microphone muted]
12. : Memory card inserted
13. : Battery level
14. : Daily alarm enabled
15. : Schedule entry enabled [with/without reminder alarm]
16. : Outbox contains unsent messages [text message/multimedia/Email]
17. : Voicemail message alert
18. : "Show Secret Data" set to "On"
19. : Function Lock enabled
20. : Keypad Lock enabled
21. (No display)/: Current profile [Normal/Car/Silent/Original]
22. : Hour minder enabled
23. : Auto answer enabled
24. : Answer Phone [enabled/enabled with message saved/disabled with message saved]

Display Indicators (External Display)



Status Indicators

1. : Battery level [sufficiently charged/charging recommended/charging required/empty]
2. **12:00**: Clock
3. : Strength of received signal/Service out of range
4. : Missed events
5. : Voice call incoming
6. : Call in progress
7. : Alerts [messages/Delivery Report]
8. : Alarm enabled [Daily alarm/Schedule alarm/Task alarm]
9. : Sound file being played
10. : Streaming
11. : Stopwatch/countdown timer
12. : OBEX data incoming
13. : Voice Recorder activated

Navigating Functions





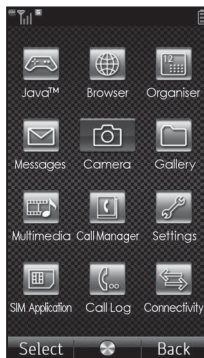

Main Menu



All applications are accessed from the Main menu.



To launch applications, you will need to open the Main menu, highlight menu items, and then make selections. For details on menu options, see “List of Menu Functions” on page 8.

The basic operations are as follows.

To Access the Main Menu	Press  in standby.
To Select a Menu Item (indicated in quotation marks in this user guide)	Move the cursor using  ,  ,  ,  and press  to select.
To Return to the Previous Screen	Press right soft key if it displays <i>Back</i> .
To Close the Main Menu	Press right soft key if it displays <i>Back</i> .

In certain procedures, you will need to press one of the soft keys (indicated in square brackets in this user guide), which are displayed in the lower left and right of the screen. Press the corresponding soft key ( or ) to execute the function displayed in the screen.

The Organiser and Settings menus have tabs.

The operations for selecting an item in these menus are as follows.

To Access the Desired Tab	Press ◀ or ▶.
To Select a Menu Item (indicated in quotation marks in this user guide)	Move the cursor using ▲ or ▼ and press ○ to select.

Each section in this user guide starts with a list of items you will need to select in order (indicated in italics) before performing the procedures shown. Select each item to reveal the next set of items that you have to choose from. Open subsection items after opening those listed in the main section.

Example:

“Java™” → ***“Java™ Settings”***

Example (menu with tabs):

“Settings” → ***“Phone Settings” tab*** → ***“Sound Settings”***

Shortcut Keys

You can access menus by pressing ○ and digit keys for the corresponding number on the Main menu. For numbers 10 to 12, press ○ and [X.00] (10), [0.1] (11) or [E.4] (12). For menus with tabs, press ▶ (or ▲ when necessary) to select the desired tab before pressing the digit keys. See “List of Menu Functions” on page 8.

Shortcuts are listed in the headings of this user guide.

Example (p. 113): To Access “Off Line Mode” Sub Menu

Off Line Mode (M 9-▶-▶-2)

“Settings” → ***“Network Settings” tab*** → ***“Off Line Mode”***

Press ○ [9.00] and ▶ twice for the “Network Settings” tab, then press [2.00].

Example (p. 41): To Access “Manage Groups” Sub Menu

Manage Groups (M 8-5)



“Call Manager” → ***“Manage Groups”***











Press ○ [8.00] [5.00].

Note

- *The shortcut keys work for the first three menu levels only.*

Shortcuts



Your phone has a shortcut function (press  in standby) which enables you to access the desired menu quickly. The default shortcuts are as follows (shortcuts assigned to - can be customised):

- Main Menu
- Scratch Pad
- Enter Phone Number
- : Inbox
- : Create Message
- : Bookmarks
- : Calendar
- : Phonebook
- : Gallery
- : Calculator
- : Alarms
- : Bluetooth
- : Scan Card



To Use the Shortcut Key

1. Press  in standby.
2. Select the desired item or number.

To Customise the Assigned Shortcuts

1. Press  in standby.
2. Highlight the shortcut you wish to customise from -.
3. Press [Options] and select “Assign”.
The list of the available items is displayed.
4. Select the desired item.

Note

- To move the item in the list that appears in step 1, highlight the item, press [Options] and select “Move”. Then press  or  to the desired location and press .
- To reset the customised shortcut, press [Options] and select “Set to Default” in step 2.

Motion Control

Your phone has a sensor which can detect motion or changes in direction. You can change the picture being displayed or enlarge or shrink the contents of the screen in specified applications, just by moving it in a certain way.

For details on the settings for motion control, see “Motion Control Settings” on page 104.

Holding the Phone Correctly

Open Position
(Portrait)



Open Position
(Landscape)

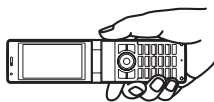

Closed Position



Hold the phone so it fits in the palm of your hand.

Before Using Motion Control

Make sure that the phone is in the following status.

1. The Display is Turned On

This function is not available when the display is turned off.

To Turn On the Display:

Press any side key.

2. Keypad Lock is Deactivated

This function is not available when the keypad is locked.

To Deactivate Keypad Lock:

Long press .

3. “Display Change” for Motion Control is Enabled

“Settings” → **“Phone Settings” tab** → **“Motion Control”** → **“Display Change”** → **Select the desired settings** → **Select “On”**

4. “Action Settings” for Motion Control is Enabled

“Settings” → **“Phone Settings” tab** → **“Motion Control”** → **“Action Settings”** → **Select the desired settings** → **Select “On”**

Motion Control Functions

1. Change the Direction of the Screen

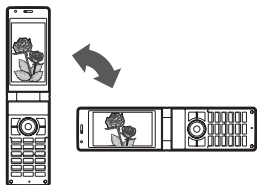

When Document Viewer or the WAP/Web browser is activated, the screen automatically changes direction to the portrait or landscape position according to the direction the phone is held.

2. Enlarge or Shrink the Contents of the Screen

Enlarge or shrink the font size of the text in messages by shaking the phone forward or backward. You can also enlarge/shrink pictures being viewed and the screen contents of WAP/Web pages or documents being viewed with Document Viewer.

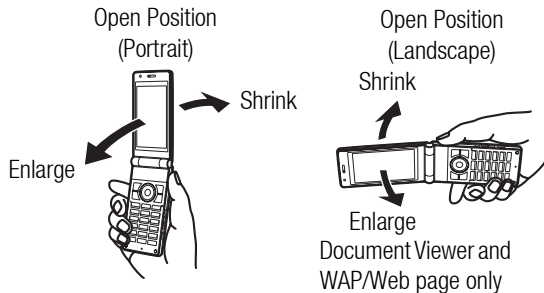

3. Select a Sound File or Picture

Select the previous or next picture, sound or document file by shaking the phone once to the left or to the right. You can also change the page being viewed.

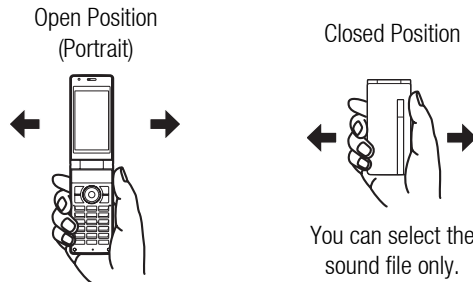

4. Quick Silent

Quickly silence your phone (the ringtone, alarm tone, etc.) just by turning the phone over.

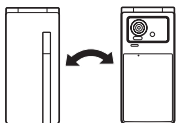

Note

- Make sure to set “Quick Silent” in “Action Settings” to “On” before using this function.
- Depending on the volume and the type of sound, some ringtones or alarm tones may not be muted.

Showing Secret Data Temporarily

The hidden data in the Phonebook or Calendar can be displayed temporarily by shaking the phone.

1. Enter the handset code in standby.
2. Shake the phone to the left or right.

The hidden data can be displayed temporarily.

To hide the data again, display the standby screen and close the phone.

Practicing the Action (M 9–7–3)

You can practice and confirm the actions set in the motion control settings.

“Settings” → “Phone Settings” tab → “Motion Control” → “Action Test”

1. Select “Zoom in/out” or “Select Contents”.
2. Perform the selected action to test the setting.

A confirmation tone sounds when an action is recognized.

Note

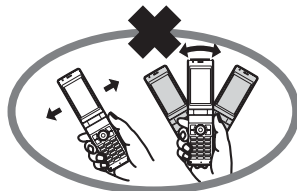

- Motion control may not function correctly depending on the way the phone is held or shaken.
- When shaking the phone, try to keep it as level as possible.
- Do not shake the phone at an angle.



- When using motion control, make sure to hold on to the phone firmly and not to shake the phone too strongly. Confirm that there is enough space around you to ensure the safety of others. Failing to do so may result in injury or damage to the phone or objects near by.

Voice Call Functions

Making a Voice Call

1. Enter the area code and the phone number you wish to dial, and then press  to dial.
If you enter the wrong number, press  to delete the number to the left of the cursor.



Emergency Calls

1. Enter the official emergency number for your location using the keypad and press  to dial.

Note

- *It may not be possible to make emergency calls on all mobile phone networks when certain network services and/or phone features are in use. Contact your service provider for more information.*
- *Emergency numbers differ depending on the location.*
- *Before making the emergency call, make sure the phone is turned on, the signal is strong, and a SIM card is inserted properly.*
- *During an emergency call, do not end the call until you are given permission to do so.*
- *Connection in all conditions cannot be guaranteed for wireless phones. You should never rely solely on any wireless device for communication during an emergency.*

International Calls

1. Long press  until a + (international dialling prefix) sign is displayed.
2. Enter the country code, followed by the area code (without the leading zero) and the phone number, and press  to dial.

Adding an Entered Phone Number to the Phonebook

1. After entering a phone number, press [Options] and select “Save Number”.
For details on creating a new entry, see “Adding a New Entry” on page 37.

Showing or Hiding My Phone Number on the Display of the Called Party

1. After entering a phone number, press [Options], select “Show My ID” or “Hide My ID” and press  to dial.

Speed Dialling





The digit keys (1-9) can be used for speed dial. Up to 8 phone numbers from the Phonebook memory (Handset and SIM) can be assigned to 2-9. The phone number of the Voicemail centre is assigned to 1.

For details on setting the speed dial list, see “Speed Dial List” on page 42.

1. To dial a number using the speed dial, long press any of the digit keys (1-9).
The phone number saved in the speed dial list is dialled.





Redialling

You can redial numbers in the call log. Select from specific categories or “All Calls”. Specific categories contain up to 30 numbers and the “All Calls” list contains up to 90.

1. Press  in standby.
2. Select the category from “All Calls”, “Dialled Numbers”, “Missed Calls” or “Received Calls”.
To switch logs, press  or .
3. Highlight the phone number you wish to call.
4. Press  to redial a voice call.

Answering a Voice Call

When an incoming call is detected, the phone rings.

1. Press  or  to answer the call.
Or press any key except , , [Options] or [Busy] when the “Any Key Answer” function is enabled. Set the Any Key Answer function in the profile of each mode (p. 96).









Rejecting an Incoming Call

1. Press [Options] and select “Reject” while the phone is ringing to reject a call you do not wish to answer.

In Call Menu (Voice Call)

Adjusting the Earpiece Volume

You can adjust the earpiece volume to five levels.

1. Press  or  to display the Earpiece Volume screen.
2. Press  (or /) to increase the volume of the call or press  (or /) to decrease the volume.
3. Press  when the volume is set to the desired level.

Turning the Speaker On and Off

You can talk via the loudspeaker on the phone when it is on.

1. During a call, press .

Putting a Call on Hold

To Make Another Call during a Call

1. During a call, press [Options] and select “Hold”.
The current call is put on hold.
2. Press [Options] and select “Dial New Number”.
3. Enter the phone number you wish to make another call to, then press .

Tip

- You can also make another call by entering the phone number during a call instead of step 1. The current call is automatically put on hold.

Accessing SMS/MMS Menu during a Call

1. During a call, press [Options] and select “Messages”.
The following options are available: “Create Message” to make an SMS and MMS, or “Inbox”, “Sent” or “Drafts” to access these folders. For details on SMS and MMS, see “SMS” and “MMS” on page 57.

Call Waiting

1. During a call, press [Options] and select “Hold & Answer” to answer the second call.

The first call is put on hold and you can now talk to the second caller.

You can also answer the second call by pressing .

Note

- You need to set “Call Waiting” to “On” if you wish to use the Call Waiting service (p. 112).
- Call Waiting service may not be available on all networks. Contact your service provider for more information.
- If you do not wish to answer the second call, press [Options] and select “Busy” in step 1. If “Reject” is selected, the log of the second call is saved as a missed call.

Conference Call

Conference call is a call with more than 2 participants. You may include up to 5 participants in a conference call.

To Make a Conference Call

You must have one active call and one held call.

1. During a call, press [Options] and select “Conference All” to join the conference call.
2. Press  to end the conference call.

Note

- *The conference call service may not be available on all networks. Contact your service provider for more information.*
- *To end the call with all participants, press [Options] and select “End All Call(s)”.*
- *You have more options for the Conference call after selecting “Conference All” in step 1:*
 - *To put all participants on hold, select “Hold All”.*
 - *To put all participants except the current call on hold, select “Private”.*

To Add New Participants to the Conference Call

1. Press [Options] and select “Enter Number”.
2. Enter the number you wish to include in the conference call and press  to dial.
3. Press [Options] and select “Conference All” to join the conference call.

If you wish to add other participants, repeat steps 1 to 3.

To End the Call with a Conference Call Participant

1. During a conference call, highlight the person that you wish to disconnect from the conference call.
2. Press [Options] and select “End This Call”.

To Have a Private Conversation with One of the Participants

1. During a conference call, select the person that you wish to talk to.
2. Press [Options] and select “Private”.
3. Once you have finished the private conversation, press [Options] and select “Conference All” to return to the conference call.





Muting the Microphone

1. During a call, press [Mute].
To use the microphone again, press [Unmute].





Entering Characters

In multi-tap input method, press each key until the desired character is displayed. For example, press  once for the letter A or twice for the letter B.

Press the following keys to:

- : Enter:
. (full-stop) , (comma) ? ! : ; ' (apostrophe) " / 1
- : Enter:
(space)+ = < > € £ \$ ¥ % & 0
- : Switch character case among four modes:
Abc, ABC, abc and 123.
- : Display the pictograms and symbols selection screen.

Long press the following keys to:

- : Enter 1-9 numbers.
- : Enter space in Numeric mode or to enter 0 in other modes.
- : Shift between multi-tap and XT9 mode.
- : Display the language options screen.

Changing the Input Language

1. On the text entry screen, press [Options] and select “Input Language”.
2. Select the desired language.

Changing the Input Method

1. On the text entry screen, press [Options].
2. Select “Input Method”.
3. Select the input method you wish to use.

Input Method	Input Language = Simplified Chinese	Input Language = English
XT9 Mode	XT9 PinYin XT9 Stroke	XT9 Abc XT9 ABC XT9 abc
Multi-tap mode	Abc ABC abc Numeric	Abc ABC abc Numeric

Tip

- In XT9 or multi-tap mode, you can switch input mode as follows by pressing .

English/XT9 mode

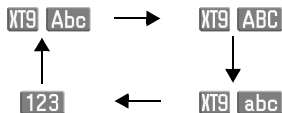

English/Multi-tap mode

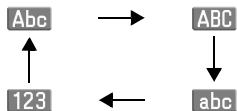

Simplified Chinese/XT9 mode



XT9 English Mode

Using XT9 English Mode

1. On the text entry screen, press [Options].
2. Select “Input Method”.
3. Select the XT9 mode (XT9 Abc, XT9 ABC, XT9 abc) you wish to change. “XT9” is displayed on the screen.
4. Press the keys to enter characters.
5. Press ⌂ or 🌐 to select the word you wish to input.

6. If you wish to clear the word, highlight it and long press [abc].

7. Press ⌂ to complete the selection.

Tip

- If you press [0+] instead of step 6, a space is inserted next to the selected word.

XT9 PinYin and XT9 Stroke Mode

In XT9 PinYin and XT9 Stroke mode, keys are as follows.

Key	Stroke	PinYin
1 [1]	—	
2 [2]		abc
3 [3]	↗	def
4 [4]	↘	ghi
5 [5]	→	jkl
6 [6]	Wildcard	mno
7 [7]		pqrs
8 [8]		tuv
9 [9]		wxyz
X [X]	Change Input Method	
0 [0]	Space	
# [#]	Go to the pictograms and symbols selection screen.	

-: Long press to input corresponding Chinese character displayed in the candidate field.

: Long press to display the Input Language screen.

Changing the Input Method between Stroke and PinYin

See “Changing the Input Method” on page 31.

Using Stroke Mode

The following is an example of entering “笔”.

1. Change the input mode to XT9 Stroke mode.
2. Press to display the corresponding stroke for “笔”.



3. Press to move the cursor to the candidate field and press to highlight the desired candidate, and then press .



You can also enter the character long pressing the corresponding numeric key.

Using PinYin Mode

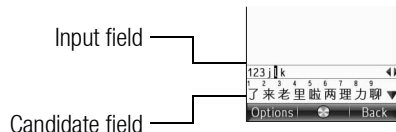

The following is an example of entering the character “理”.

1. Press for the first letter of the reading, then highlight “l”.



2. Press to move the cursor to the candidate field and press to highlight the desired candidate, and then press .



You can also enter the character long pressing the corresponding numeric key.



The following is an example of entering the word “你好”.

1. Press **6** **4** to display the corresponding reading for “你”, then highlight “ni”.



2. Press **4** to display the candidate for “你好”.



3. Press **4** to move the cursor to the candidate field and press **4** **4** **4** to highlight the desired candidate, and then press **4**.

You can also enter the character long pressing the corresponding numeric key.



User Dictionary

You can create your own word list for alphabet text and XT9 Chinese input.

English User Dictionary

Note

- This function is only available when “Input Language” is set to “English”.

To Create a New Entry

1. On the text entry screen, press [Options] and select “User Dictionary”.
2. Select “Add New Word”.
3. Enter a new word.

To Edit a Word in the List

1. On the text entry screen, press [Options] and select “User Dictionary”.
2. Highlight the desired word.
3. Press [Options] and select “Edit”.
4. Modify the word.

To Delete a Word

1. On the text entry screen, press [Options] and select “User Dictionary”.
2. Highlight the desired word.
3. Press [Options] and select “Delete”.
4. Select “Yes” or “No”.

Chinese User Dictionary

You can enter Chinese characters for Chinese word lists.

Note

- *This function is only available when “Input Language” is set to “Simplified Chinese”.*

To Create a New Entry

1. On the text entry screen, press [Options] and select “Chinese User Dictionary”.
2. Select “Add New Word”.
3. Enter a new word.

To Edit a Word in the List

1. On the text entry screen, press [Options] and select “Chinese User Dictionary”.
2. Highlight the desired word.
3. Press [Options] and select “Edit”.
4. Modify the entry word.

To Delete a Word

1. On the text entry screen, press [Options] and select “Chinese User Dictionary”.
2. Highlight the desired word.
3. Press [Options] and select “Delete”.
4. Select “Yes” or “No”.

Entering Pictograms and Symbols

1. On the text entry screen, press [Options] and select “Add Symbol”.

The history screen for entering pictograms and symbols is displayed first.

To switch to the pictogram list screen, press [Next]. Each time [Next] is pressed, the pictogram lists switch.

To switch to the symbol screen, press [Symbol]. Press [Next] to switch between the full width symbols and half width symbols.

2. Select the pictogram or symbol you wish to use and press .

Note



- *Pictograms are only available for SMS/MMS messages and Notepad.*

Using Note

For details on creating the Notepad entry, see “Adding Phrases to Notepad” on page 89.

1. On the text entry screen, move the cursor to the point you wish to insert the Notepad entry.
2. Press [Options] and select “Advanced”.
3. Select “Insert Note”.
4. Select the desired entry.

Copying, Cutting and Pasting Text

1. On the text entry screen, press [Options] and select “Advanced”.
2. Select “Copy” or “Cut”.
3. Move the cursor to the first letter to be copied or to be cut, then press .
4. Move the cursor to the last letter to highlight the area, then press .
5. Move the cursor to the point you wish to paste the letters.
6. Press [Options] and select “Advanced”.
7. Select “Paste”.
8. Select the desired item.

Insert Phonebook Entries

For details on creating the Phonebook entries, see “Call Manager” on page 37.

1. On the text entry screen, move the cursor to the point you wish to insert the Phonebook Entry.
2. Press [Options] and select “Advanced”.
3. Select “Insert Phonebook Entry”.
4. Select the desired Phonebook Entry.
The selected entry is inserted.

Call Manager (M 8)

Your phone can store up to 1000 entries. For each entry, you can enter information including up to 5 phone numbers and 5 Email addresses. There is a limit to the number of characters that can be entered for each item. The character limit differs for the handset memory and SIM card memory.

Adding a New Entry

Selecting the Storage Memory (M 8–9–3)

“Call Manager” → *“Phonebook Settings”* → *“Save to”*

1. Select from “Handset”, “SIM” or “Choice”.

Registering a New Entry (M 8–2)

“Call Manager” → *“Add New”*

1. Select the field you wish to fill in, and enter the relevant information.
2. Press [Save] when finished.

Saving an Unregistered Number (M 8–9–5)

“Call Manager” → *“Phonebook Settings”* → *“Save Unregistered”*

1. Select “Incoming Call” or “Outgoing Call”.
2. Select “On” or “Off”.

Registering My Card (M 8–6)

“Call Manager” → *“My Card”*

Searching for an Entry

Changing the List Displayed (M 8–9–2)

“Call Manager” → *“Phonebook Settings”* → *“Source”*

1. Select from “Handset”, “SIM” or “Both”.

Finding a Name

“Call Manager” → *“Phonebook”*

1. Enter the first few letters of the name.
The first name corresponding to the entered letters is highlighted.

Sorting the Phonebook List Order (M 8–9–1)

“Call Manager” → *“Phonebook Settings”* → *“View Phonebook”*

1. Select “By PinYin” or “By Group”.

Selecting the Search Mode (M 8–9–4)

“Call Manager” → *“Phonebook Settings”* → *“Search Mode”*

1. Select “Character Search”, “PinYin Search” or “English Search”.

Dialling from the Phonebook

“Call Manager” → “Phonebook”

1. Highlight the desired entry and press  to make a voice call.

Dialling a Service Phone Number (M 8–10)

Certain SIM cards contain service phone numbers that can be dialled. Contact your SIM card vendor for more information.

“Call Manager” → “Service Dialling No.”

1. Select the desired service phone number.

Sending a Message from the Phonebook

“Call Manager” → “Phonebook”

1. Select the desired entry including the phone number or Email address you wish to use.
2. Select the desired phone number or Email address.
3. When a phone number is selected in step 2, select “Create Message”.

For further procedures, see “Creating a New Message” on page 57.

Using Mailing Lists (M 8–8)

Up to 20 groups can be registered.

To Create a New Mailing List

“Call Manager” → “Message Groups” → “Add New Group”

1. Enter the group name.
The new group name is displayed following the last group on the Group List screen.

To Add Recipients to a Group

Up to 20 recipients can be registered in each list.

“Call Manager” → “Message Groups”

1. Select the desired group name.
2. Select “Assign New Entry”.
3. Select the desired entry.
The detailed screen is displayed.
4. Select the desired phone number or Email address.

To Send a Message Using a Mailing List

“Call Manager” → “Message Groups”

1. Highlight the desired group name.
2. Press [Options] and select “Create Message”.
For further procedures, see “Creating a New Message” on page 57.

Editing Phonebook Entries

“Call Manager” → **“Phonebook”**

1. Highlight the entry you wish to edit.
2. Press [Options] and select “Edit”.
3. Modify the information.
4. Press [Save] when finished.

Adding a Thumbnail to Entries

Only Phonebook entries saved to the handset can have thumbnails attached to them.

“Call Manager” → **“Phonebook”**

1. Highlight the desired entry.
2. Press [Options] and select “Edit”.
3. Select “Picture”.
4. Select “Assign Picture”.
5. Select the desired picture.
6. Press [Save] when finished.

Note

- If you delete a picture in the handset memory, the corresponding thumbnail is also deleted.
- To store a picture right after it was taken, select “Take Picture” in step 4.

Assigning a Ringtone or a Ring Video Clip to Each Entry

“Call Manager” → **“Phonebook”**

1. Highlight the desired entry.
2. Press [Options] and select “Edit”.
3. Select “Tone/Video for Voice Call” or “Tone/Video for New Message”.
4. Select “Assign Tone”.
5. Select “Preset Sounds”, “Sound Gallery”, “Video Gallery” or “Flash®”.
6. Select the desired tone or video clip.
For details on selecting a ringtone or a ring video clip, see “Assigning a Ringtone or a Ring Video Clip for an Incoming Call” on page 100.
7. Press [Save] when finished.

Deleting Phonebook Entries

Deleting All Phonebook Entries

“Call Manager” → **“Advanced”** → **“Delete All”**

1. Select from “Handset Entries”, “SIM Entries” or “Both Entries”.
2. Enter your handset code.

The default handset code is “9999”. For details on changing the handset code, see “Change Handset Code” on page 106.

Deleting a Phonebook Entry

“Call Manager” → **“Phonebook”**

1. Highlight the desired entry.
2. Press [Options] and select “Delete”.

Managing the Phonebook

Copying Phonebook Entries between SIM Card and Handset

“Call Manager” → **“Advanced”** → **“Copy All Entries”**

1. Select “From SIM to Handset” or “From Handset to SIM”.

Note

- *When you insert the SIM card into your phone for the first time and start the Phonebook application, the confirmation screen is displayed automatically, asking you if you wish to copy or not. The number of Phonebook entries to be copied varies depending on the SIM capacity.*
- *If the memory space is not enough to save all entries, you cannot complete copying.*

Sending a Phonebook Entry

“Call Manager” → **“Phonebook”**

1. Highlight the desired entry.
2. Press [Options] and select “Send Phonebook”.
3. Select “As Message”, “As Email”, “Via Bluetooth” or “Via Infrared”.

For “As Message”

For details, see “MMS” on page 57.

For “As Email”

For details, see “Email” on page 57.

For “Via Bluetooth”

For details, see “Bluetooth” on page 118.

For “Via Infrared”

For details, see “Infrared” on page 120.

Receiving a Phonebook Entry

When the phone receives a Phonebook entry, a confirmation message is displayed in standby.

1. Select “Yes”.

The received entry is saved in the Phonebook. Select “No” to reject.





Play Messages (M 8–3)

You can play back the messages saved with Answer Phone.

“Call Manager” → “Play Messages”

Playback automatically ends when all messages have been played.

To stop playback, press .

Press  (or ) to increase the volume or press  (or ) to decrease the volume.

To play back previous message, press .

To play back the next message, press  or .

To delete the message being played back, press [Delete] during playback.

Note

- Up to 20 messages (a total of approximately 90 seconds) can be recorded. Answer Phone cannot be used when the remaining available recording time is less than 12 seconds, or when 20 messages are already saved. In such cases, delete unnecessary messages.

Tip

- Press  in standby to play back the message saved with Answer Phone.

Manage Groups (M 8–5)

Different ringtones can be set for each group.

“Call Manager” → “Manage Groups”

1. Highlight the desired group.
2. Press [Options] and select “Assign Tone/Video”.
3. Select “For Voice Call” or “For New Message”.
4. Select “Assign Tone”.
5. Select “Preset Sounds”, “Sound Gallery”, “Video Gallery” or “Flash®”.
6. Select the desired tone or video clip.

Editing the Group Name

“Call Manager” → “Manage Groups”



1. Highlight the desired group name.
2. Press [Edit] and select “Edit Name”.
3. Modify the name.

Speed Dial List (M 8–7)

Setting Phonebook Entries in the Speed Dial List

To Create a New Entry for Speed Dial or Speed Mail

“Call Manager” → **“Speed Dial List”**

1. Select an empty entry.
2. Press [Assign].
3. Select the desired Phonebook entry.
4. Select the desired phone number.
5. Press .
You can now also assign an Email address for Speed Mail.
6. Select the desired Email address.
7. Press .
8. Press [Save] to save the details to the selected digit key.

To Change the Speed Dial List or the Speed Mail List

“Call Manager” → **“Speed Dial List”**

1. Select the entry you wish to change.
2. Press [Options] and select “Change”.
3. Select the “Call number” or “Mail address” you wish to modify.
4. Press [Change].
5. Select the phone number or Email address to assign.
If you wish to remove the entry, select “Do not Assign”.
6. Press [Save].

Note

- If you wish to set or edit entries in the Speed Mail List, the following procedure is also available:
“Messages” → “Messaging Settings” → “Speed Mail List”

Memory Status

This function helps you to check the memory used in the Phonebook.

“Call Manager” → **“Advanced”** → **“Memory Status”**

Multimedia (M 7)

Music Player (M 7–1)



Music player supports MP3, MPEG-4 and 3GPP format sound files.

Playing Back Sound Files

“Multimedia” → “Music Player” → “My Music”

1. Select the item you wish to play back.
 - “All Music”: All sound files are displayed.
 - “Artists”: The names of all artists are displayed.
 - “Albums”: The names of all albums are displayed.
 - “Playlists”: All playlists are displayed.
2. Select the desired sound file.

To pause playback, press .

To stop playback, press  and go back to standby, then press  again. Select “Yes” when the pop-up appears.

Note

- Select “My Music” to update the list of available music tracks.
- You are asked whether or not to play sounds when the Silent mode is activated.
- When “Action Settings” in the motion control setting for “Music” is set to “On” (p. 104), you can change the sound file being played back by shaking the phone sideways.

- When you receive a call, playback of the current file is paused, and you can receive the call. After the call ends, playback resumes automatically.

To Play Back the Last File (M 7–1–1)

“Multimedia” → “Music Player”



1. Select “Last Played Music”.

“Currently Playing” is displayed when a file is being played back.

Searching a File to be Played Back

“Multimedia” → “Music Player” → “My Music”

1. Select “All Music” or the desired album or playlist.
2. Press [Options] and select “Search”.
3. Enter a few letters of the title.

Search results are displayed with the first matching title highlighted (non-matching titles are greyed out). Press  or  to select other matching titles. The search will match the entered text with any part of the title.

Sorting Files

“Multimedia” → “Music Player” → “My Music” → “All Music”

1. Press [Options] and select “Sort”.
2. Select “By Title”, “By Artist”, “By Album” or “By Genre”.

Sort results are displayed.

Adding a File to the Playlist

“Multimedia” → **“Music Player”** → **“My Music”** → **“All Music”**

1. Highlight the file you wish to add to the playlist.
2. Press [Options] and select “Add to Playlist”.
The playlists are displayed. For details on adding a playlist, see “Adding a New Playlist”.
3. Select the desired playlist.
The file highlighted in step 1 is saved.
To delete files from the playlist, highlight the file in the playlist and press [Options]. Then select “Delete from Playlist”.

Note

- You can store up to 99 files in one playlist. However, the total number of files stored on your phone cannot exceed 350 files.

Adding a New Playlist

“Multimedia” → **“Music Player”** → **“My Music”** → **“Playlists”**

1. Press [Options] and select “Add New Playlist”.
2. Enter the desired playlist name.

Note



- To delete the playlist, highlight the playlist and press [Options]. Then select “Delete Playlist”.
- You can create up to 99 playlists.

Video Player (M 7–2)

Video Player supports MPEG-4, 3GPP and H.264 format video files.

Playing Back Video Clip Files (M 7–2–2)

“Multimedia” → **“Video Player”** → **“My Videos”**



1. Select “Handset Memory” or “Memory Card”.
2. Select “All Videos” or the desired playlist.
3. Select the desired file.
To pause playback, press .
To stop playback, press .

To Play Back or Resume Playback of the Last File (M 7–2–1)

“Multimedia” → **“Video Player”** → **“Last Played Video”**

Searching a File to Be Played Back

“Multimedia” → **“Video Player”** → **“My Videos”**

1. Select “Handset Memory” or “Memory Card”.
2. Select “All Videos” or the desired playlist.
3. Press [Options] and select “Search”.
4. Enter a few letters of the title.
Search results are displayed with the first matching title highlighted (non-matching titles are greyed out). Press  or  to select other matching titles. The search will match the entered text with any part of the title.

Adding a File to the Playlist

“Multimedia” → **“Video Player”** → **“My Videos”**

1. Select “Handset Memory” or “Memory Card”.
2. Select “All Videos”.
3. Highlight the file you wish to add to the playlist.
4. Press [Options] and select “Add to Playlist”.
The playlists are displayed. For details on creating a playlist, see “Adding a New Playlist”.
5. Select the desired playlist.

The file highlighted in step 3 is saved.

To delete files from the playlist, highlight the file in the playlist and press [Options]. Then select “Delete from Playlist”.

Adding a New Playlist

“Multimedia” → **“Video Player”** → **“My Videos”**

1. Select “Handset Memory” or “Memory Card”.
2. Press [Options] and select “Add New Playlist”.
3. Enter the desired playlist name.
4. Press .



Note

- To delete the playlist, highlight the playlist and press [Options]. Then select “Delete Playlist”.

To Play Back SD VIDEO

Video clips with the “ASF” format can also be managed with SD VIDEO.

“Multimedia” → **“Video Player”** → **“SD VIDEO”**

1. Select the desired file.
To pause playback, press .
To resume, press  again.
To delete a file, highlight the file, press [Options] and select “Delete”.

Settings

“Multimedia” → **“Video Player”** → **“Settings”**

1. Select from “Playback Pattern”, “Backlight”, “AV Mode”, “Display Size”, “Sound Effects” or “Web Link Setting”.
2. Select from the following:
 - “Playback Pattern” (“Normal”, “Repeat”, “Repeat All”, “Random”)
 - “Backlight” (“Always On”, “Always Off”, “Normal Settings”) When “Normal Settings” is selected, the backlight works with the main backlight setting (p. 99).
 - “AV Mode” (“Normal”, “Effect 1”, “Effect 2”, “Effect 3”, “Effect 4”)
 - “Display Size” (“Normal Size”, “Enlarge”, “Full screen”, “Widescreen”, “Cinema Screen”)

- “Sound Effects” (Various sound effects are available, including “Normal”, “Bass” and “Surround” and so on.)
- “Web Link Setting” (“On”, “Off”)

Streaming Player (M 7–3)

You can play back video clip files while downloading them from the mobile network.

You can also register the address of the Web site as a bookmark.





“Multimedia” → “Streaming Player”

1. Select “Last Played”, “Enter URL”, “Favourites”, “Access Log” or “Settings”.

- | | |
|----------------|---|
| “Last Played”: | Shows the last streaming file. |
| “Enter URL”: | Enter the desired address of the Web site.
The browser opens, starts downloading and plays back. |
| “Favourites”: | The address of the Web site is registered. |
| “Access Log”: | Shows a log of the Web sites you have accessed. |
| “Settings”: | The Backlight, Display Size and Sound Effect settings can be changed. |

Camera (M 5)



Launching the Camera

1. Select “Camera” from the Main menu or press .
 - When launching the camera from the Main menu: Select “Still Camera” or “Video Camera” from the Camera menu.
Press  to switch between the still camera and video camera.
 - When launching the camera pressing :
The first time the camera is launched, the still camera is activated.
Press  to switch between the still camera and video camera.
The camera mode (still camera or video camera) used previously is launched from the next time.

Taking Pictures

“Camera” → “Still Camera”

1. Press  to take the picture.
The shutter sounds and the still image of the taken picture is displayed.



2. Press  to save the picture.
The taken picture is saved in Gallery.
To cancel, press .
To send the taken picture, press  in step 2.

Note

- When the video camera is launched, press .
- The portrait or landscape position of the taken photo is automatically changed according to the direction the phone is held.
- When “Auto Save” is set to “On”, the taken picture is automatically saved in Gallery without pressing  again.
When “Background Saving” is set to “On”, your phone is ready to take another picture even before saving is complete. For details, refer to “Saving a Photo in the Background” on page 55.
- When you try to send a picture that has too large a file size, the picture size is resized for the message. The original sized picture is saved in Gallery.

Recording Video Clips

“Camera” → “Video Camera”

- The preview is displayed on the screen.
When in still camera mode, press  to switch to video camera mode.
1. Press .
 2. To stop recording, press .

3. Select “Save”.

The video clip is saved in Gallery.

To view the preview before saving, select “Preview”.

To send the video clip, select “Send” and then select “As Message”, “Bluetooth” or “Infrared”.

For “As Message”

For details, see “MMS” on page 57.

For “Bluetooth”

For details, see “Bluetooth” on page 118.

For “Infrared”

For details, see “Infrared” on page 120.

For further procedures, see “Creating a New Message” on page 57.

Note

- You can only send video clips when “For Message” is selected for the recording time. For details, see “Selecting the Recording Time and Picture Size” on page 55.
- You can take and save up to 3 pictures while recording a video clip. Press  while recording a video clip to save a picture. Pictures are taken and saved in same size as “Record Time/Size” setting. For details, see the “Selecting the Recording Time and Picture Size” on page 55.

Common Functions in the Still and Video Camera Modes

Using the Digital Zoom Function

To Adjust the Zooming Ratio

1. Press  or .

Once the phone has returned to standby, the zoom settings return to default.

Note







- In still camera mode, the zoom function is not available for the picture size 2448×3264 .

Adjusting the Exposure

“Camera” → “Still Camera” → [Options] → “Shooting Settings” → “Exposure”

“Camera” → “Video Camera” → [Options] → “Record Settings” → “Exposure”

1. Press  (Bright) or  (Dark).

     : (Dark → Normal → Bright)





Once the phone has returned to standby, the brightness settings return to default.

Switching the Focus Mode

“Camera” → **“Still Camera”** → **[Options]** → **“Shooting Settings”** → **“Focus”**

“Camera” → **“Video Camera”** → **[Options]** → **“Record Settings”** → **“Focus”**

1. Select the desired option.

- : Centre Auto Focus (still camera mode only)
- : Face Auto Focus (still camera mode only)
- : Auto Focus (video camera mode only)
- : Manual Focus
- : Macro

Tip

- The Face Auto Focus function is available in the still camera mode. For details, see “Using Face Auto Focus” on page 51.



Selecting the Picture or Video Quality

Select the appropriate option.

“Camera” → **“Still Camera”** → **[Options]** → **“Picture Quality”**

“Camera” → **“Video Camera”** → **[Options]** → **“Video Quality”**

1. Select the desired picture or video quality.

- : Super Fine
- : Fine
- : Normal

Note

- The better quality you select, the larger the file size becomes.

Tip



- “Picture Quality” is also available from the following procedure:
“Camera” → “Still Camera Settings”

Using the Self-Timer

“Camera” → **“Still Camera”** → **[Options]** → **“Self-timer”**

“Camera” → **“Video Camera”** → **[Options]** → **“Self-timer”**

1. Select “10sec”, “5sec” or “2sec”.

When you select one of these options, the corresponding indicator (“”, “”, or “”) is displayed on the screen. Select “Off” to cancel the self-timer.

Selecting the Storage Memory

“Camera” → **“Still Camera”** → **[Options]** → **“Settings”** → **“Save New Pictures”**

“Camera” → **“Video Camera”** → **[Options]** → **“Settings”** → **“Save New Videos”**

1. Select the desired location from “To Handset Memory”, “To Memory Card” or “Choice”.

Note

- If you select “Choice”, select the desired location every time you save.

Tip

- “Save New Pictures” is also available from the following procedure:
“Camera” → “Still Camera Settings” → “Settings”
- “Save New Videos” is also available from the following procedure:
“Camera” → “Video Camera Settings” → “Settings”

Auto Save

- “Camera” → “Still Camera” → [Options] → “Settings” → “Auto Save”
- “Camera” → “Video Camera” → [Options] → “Settings” → “Auto Save”

1. Select “On” or “Off”.

Tip

- “Auto Save” is also available from the following procedure:
“Camera” → “Still Camera Settings” or “Video Camera Settings”
→ “Settings”

Using the Help Function

- “Camera” → “Still Camera” → [Options] → “Help”
- “Camera” → “Video Camera” → [Options] → “Help”

Mobile Light

- “Camera” → “Still Camera” → [Options] → “Mobile Light”
- “Camera” → “Video Camera” → [Options] → “Mobile Light”

1. Select the desired mode.

“On” (☀): The light is always on.

“Auto” (☀_{AUTO}): The light turns on if the phone detects that the conditions are dark.

“Low Light” (☀_{LOW}) (still camera mode only):
Select this mode for macro shooting.

“Off”: The light is always off.













The corresponding indicator is displayed on the screen. Select “Off” to turn it off.

Displaying the Data Taken Last Time

“Camera” → “Review”

The picture or video clip taken the last time is displayed.

Common Shortcut Keys

	Still Camera	Video Camera
	Focus Lock	
	Focus	
	Switches Viewfinder between with and without indicators	Switches the display modes in the Preview screen
	Scan Barcode	
	Save New Pictures	Save New Videos
	Picture Size	
	Scene	Microphone
	Picture Quality	Video Quality
	Self-timer	
	Zoom Max/Min	
	Help	
	Mobile Light	
	ISO Film Speed	

Note

- The “Switches the display modes” option is available in “Preview” before you save a video clip. See “Recording Video Clips” on page 47.

Functions in Still Camera Mode

Selecting the Picture Size

You can select the size of pictures. All taken pictures are saved in the JPEG format.

“Camera” → **“Still Camera”** → **[Options]** → **“Picture Size”**

1. Select the desired size.

2448 × 3264/1536 × 2048/1080 × 1920/1200 × 1600/
960 × 1280/768 × 1366/480 × 854/480 × 640/240 × 320/
120 × 160

Tip

- “Picture Size” is also available from the following procedure:
“Camera” → “Still Camera Settings”

Using Face Auto Focus

Faces of up to 5 people can be focused on automatically using this function.

“Camera” → **“Still Camera”** → **[Options]** → **“Shooting Settings”** → **“Focus”**

1. Select “Face Auto Focus”.

Note

- Certain faces may not be recognized and focused on depending on the subject’s status.

Setting ISO Sensitivity

“Camera” → **“Still Camera”** → **[Options]** → **“ISO Sensitivity”**

1. Select from “Auto”, “Auto(High)”, “100”, “200”, “400”, “800”, “1600” or “2500”.

Continuous Shoot

“Camera” → **“Still Camera”** → **[Options]** → **“Modes”** → **“Continuous Shoot”**

1. Select the desired mode.

The following continuous shoot modes are available:

“Off”: The continuous shoots are cancelled.

“4 Pictures”/“9 Pictures” ( / ):

Takes 4 or 9 pictures continuously.

After selecting this mode, select from “Fast”, “Normal”, “Slow” or “Manual”.



“Overlapped” (): Overlaps continuous pictures into one picture and makes an afterimage.
After selecting this mode, select “Fast” or “Normal”.

Note

- When you select “Manual” to take continuous pictures, press  manually at the desired speed.

Taking Panorama Pictures

“Camera” → **“Still Camera”** → **[Options]** → **“Modes”** → **“Panorama”**

1. Select “On” and press .
2. Move the phone slowly to keep the + mark aligned with the assisting lines, and press .
3. Select “Save”.

Note

- The image is captured automatically if the bar in the lower right turns blue before  is pressed in step 2.

To Set the Assisting Lines

“Camera” → **“Still Camera”** → **[Options]** → **“Settings”** → **“Panorama Settings”** → **“Assisting Lines”**

1. Select “On” or “Off”.

Note

- An error message is displayed if you move the phone fast when taking panorama pictures with this setting on.

To Set the AE-Lock

When this setting is enabled, the exposure setting is fixed for the same brightness level.





“Camera” → **“Still Camera”** → **[Options]** → **“Settings”** → **“Panorama Settings”** → **“AE-Lock”**

1. Select “Disable” or “Enable”.

Taking Long Exposure Picture

When you take pictures of the moving objects such as fireworks or take pictures in dark surroundings such as with night photographing, use this function to avoid taking pictures that are underexposed and dark.

“Camera” → **“Still Camera”** → **[Options]** → **“Modes”** → **“Long Exposure”**

1. Select “On” or “Off”.
When “On” is selected, the exposure time is fixed at 4 seconds.
2. Press  to take the picture.
The progress of the exposure and image processing is displayed.
The still image of the taken picture is displayed when the image processing is done.
3. Press  to save the picture.
The taken picture is saved in Gallery.
To cancel, press .
To send the taken picture, press  in step 3.

Note

- When “Long Exposure” is set to “On” during the day or in bright surroundings, the taken picture may become over exposed and stark white.
- Use a fixation tool such as a tripod when using long exposure to prevent camera shake.

Barcode/Scan

You can read QR codes and the text on business cards. For details on reading barcodes, see page 90. For details on scanning business cards, see pages 91.

To Read Barcodes

“Camera” → **“Still Camera”** → **[Options]** → **“Barcode/Scan”** → **“Scan Barcode”**

1. Display the barcode.
2. Press [Scan].
The scanned result is displayed.

To Scan Business Cards

“Camera” → **“Still Camera”** → **[Options]** → **“Barcode/Scan”** → **“Scan Card”**

1. Display the business card.
2. Press [Read].
3. Press [Scan] or .
The scanned result is displayed.

Camera Effects

“Camera” → **“Still Camera”** → **[Options]** → **“Modes”** → **“Camera Effects”**

1. Select from “Sepia” or “Monochrome”.

Selecting a Frame

“Camera” → **“Still Camera”** → **[Options]** → **“Modes”** → **“Add Frame”**

1. Select “Preset Frames” or “Picture Gallery”.
2. Select the desired frame.
When “Preset Frames” is selected, the viewfinder is displayed after selecting the desired frame.
When “Picture Gallery” is selected, the selected frame is confirmed on the display after selecting the desired frame.
Press  to select the frame and display the viewfinder.

Note

- Images larger than 240 pixels [W] × 320 pixels [H] cannot be used.

Selecting the Scene

“Camera” → **“Still Camera”** → **[Options]** → **“Scene”**

1. Select from “Auto”, “Night”, “Sports”, “Text”, “Pet”, “Against Sun” or “Portrait”.

Using the Full Screen

“Camera” → **“Still Camera”** → **[Options]** → **“Settings”** → **“Display Indicators”** → **“Full Viewfinder”**

Note

- To return to the normal viewfinder, select “Normal Viewfinder”.

Tip

- “Full Viewfinder” is also available from the following procedure:
“Camera” → “Still Camera Settings” → “Settings” → “Display Indicators”

Selecting the White Balance

“Camera” → **“Still Camera”** → **[Options]** → **“Shooting Settings”** → **“White Balance”**

1. Select from “Auto”, “Daylight”, “Cloud/Shade”, “Tungsten” or “Fluorescent”.

Selecting the Shutter Sound

“Camera” → **“Still Camera”** → **[Options]** → **“Settings”** → **“Shutter Sound”**

1. Select the desired shutter sound from 6 preset patterns.
To play back the shutter sound, press [Play] in step 1.

Note

- Continuous Shoot uses the specialised shutter sound that cannot be changed using the above settings.
- The shutter sound remains active even when “General Volume” (p. 100) is set to “Silent” to prevent unauthorised use.

Tip

- “Shutter Sound” is also available from the following procedure:
“Camera” → “Still Camera Settings” → “Settings”

Saving a Photo in the Background

“Camera” → **“Still Camera”** → **[Options]** → **“Settings”** → **“Background Saving”**

1. Select “On” or “Off”.

When “On” is selected, the taken picture is automatically saved in Gallery without pressing  again, and your phone is ready to take another picture even before saving is complete.

Note

- When “Background Saving” is set to “On” and “Auto Save” is “Off”, press  to save the taken picture. You can take the next picture while the taken picture is being saved.

Tip

- “Background Saving” is also available from the following procedure:
“Camera” → “Still Camera Settings” → “Settings”

Setting a Function for the Send Key

You can set the method to send a taken picture when  is pressed.

“Camera” → **“Still Camera”** → **[Options]** → **“Settings”** → **“Set Send Key”**

1. Select “Short press” or “Long press”.
2. Select “As Message”, “Bluetooth”, “Via Infrared” or “IrSimple”.

Tip

- “Set Send Key” is also available from the following procedure:
“Camera” → “Still Camera Settings” → “Settings”

Functions in Video Camera Mode



Selecting the Display Size

“Camera” → **“Video Camera”** → **[Options]** → **“Display Size”**

1. Select “Standard” or “Expand”.

Selecting the Recording Time and Picture Size

“Camera” → **“Video Camera”** → **[Options]** → **“Record Time/Size”**

1. Select “For Message” or “Extended Video”.
For Message (): Limits the size to send a message depending on service providers.
Extended Video (): Less than 30 minutes (depending on the memory).
2. Select the desired picture size.
If “For Message” is selected, select “QCIF(176×144)” or “SubQCIF(128×96)”.
If “Extended Video” is selected, select “Wide(864×480)”, “VGA(640×480)”, “QVGA(320×240)”, “HQVGA(240×176)”, “QCIF(176×144)” or “SubQCIF(128×96)”.

Note

- If you select “For Message” for the recording time, the file size is limited depending on the service provider. Therefore, the quality is also limited for the setting.
- “Send” is not displayed after recording in the Extended Video mode.

Tip

- “Record Time/Size” is also available from the following procedure:
“Camera” → “Video Camera Settings”

Recording Video Clips with Sound

To record a video clip with sound, the microphone needs to be activated.

“Camera” → “Video Camera” → [Options] → “Microphone”

1. Select “On” or “Off”.

Note

- The microphone is already turned on in the default setting. Select “Off” to record a video clip without the sound.
- The file size of a video clip can be reduced if the sound is not recorded.

Tip

- “Microphone” is also available from the following procedure:
“Camera” → “Video Camera Settings”

Messages (M 4)

SMS

SMS allows you to send text messages up to 765 characters long. If you send a message of more than 160 characters, it is split into several segments.

MMS

With MMS, you can send images, sound or video to brighten someone's day. Messages of up to 50 KB with images, sound, or video clips can be sent and received.

Email

Email allows you to send messages of up to 300 KB.

Note

- *Some MMS functions may not always be available depending on your network. Contact your service provider for more information.*
- *Maximum message size varies depending on the restrictions set by the service provider.*

Creating a New Message

(SMS/MMS)

“Messages” → “Create Message” → “Create Message”

(Email)

“Messages” → “Create Message” → “Create Email”

1. Select the recipient field.
2. Select the desired method to enter the recipient.
3. For MMS, enter or select the Email address or phone number from the Phonebook. For SMS, enter or select a phone number. For Email, enter or select an Email address.
 - To add multiple Email addresses or phone numbers, highlight the recipient field, press [Options], and select “Edit Recipients” and then select “Add Recipient”. Enter or select the Email address or phone number from the existing Phonebook.
 - To change the recipient types, press [Options], select “Edit Recipients” and highlight the desired recipient. Press [Options] and select “Change to To”, “Change to Cc” or “Change to Bcc”.
 - To add a subject, highlight the subject field and press Ⓞ. Then enter the subject in the subject entry screen and press Ⓞ.
4. Place the cursor in the message field.
5. Press Ⓞ to display the message entry screen. Enter the message and press Ⓞ.

6. Press [Options] and select “Send”.

“Send” is not available when no recipients are set.

After the message is sent, the message is moved to the Sent box.

Note

- *When you create an SMS message, the mode is automatically switched to MMS in the following cases:*
 - *When an Email address is entered in the recipient field.*
 - *When a subject is entered.*
 - *When the size of entered text has exceeded the SMS size limit.*

To Add a Slide Show

1. Perform steps 1 to 5 in “Creating a New Message” on page 57.
2. Press [Options] and select “Add Slide”.
3. Select “Add Slide After” or “Add Slide Before”.
4. Enter another message.

If you wish to set the duration of each slide, highlight your message or other inserted item such as a picture or sound file. Press [Options] and select “Slide Duration”, then select the desired duration. Repeat steps 2 to 4 to add more slides.

To Attach Data

1. In step 6 in “Creating a New Message”, press [Options] and select “Insert Item”.
2. Select “Picture”, “Sound”, “Video”, “My Card”, “Attach Phonebook”, “Attach Appointment”, “Others” or “Flash®”. When selecting “Attach Phonebook” or “Attach Appointment”, go to step 4.
3. Select the desired option and then select the desired file. If you wish to attach pictures, sounds or video clips that are saved, select “Saved Pictures”, “Saved Sound” or “Saved Video”. If you wish to take new pictures, record sounds or video clips, select “Take Picture”, “Record Voice” or “Record Video”.
4. Select the desired data. When attaching an appointment, select the desired day including a schedule entry you wish to add and select the desired schedule entry.

Note

- *When attaching JPEG files, select the appropriate resize option, as the maximum message size for sending varies depending on the service provider.*

To Remove Attachments

1. In step 6 in “Creating a New Message” on page 57, highlight the desired item, press [Options] and then select “Remove Item”.

Using the Sending Options

1. Press [Options] and select “Messaging Settings”.
 - “Delivery Report” (“On”, “Off”) (SMS/MMS): Enables or disables Delivery Report when the message is successfully sent to the recipient.
 - “Expiry Time” (“Maximum”, “1 hour”, “12 hours”, “1 day”, “1 week”) (SMS/MMS): Sets Expiry Time for a message to be saved in the server.
 - “Priority” (“High”, “Normal”, “Low”) (MMS/Email): Prioritises composed messages.
 - “Read Report” (“On”, “Off”) (MMS): Confirms whether or not a report is sent notifying the sender that the message has been read.
2. Press [Options] and select “Send”.

After the message is sent, the message is moved to the Sent box.

Note

- *The current message size displayed while you are creating the message is an approximation.*
- *If a message cannot be sent for some reason, the message stays in the Outbox and the “✉” is displayed in standby.*
- *To send the message in the Outbox, highlight the message, press [Options] and select “Resend”.*

Sending a Message in the Drafts Box

(SMS/MMS)

“Messages” → **“Message”** → **“Drafts”**

(Email)

“Messages” → **“Email”** → **“Drafts”**

1. Highlight the desired message.
2. Press [Options] and select “Edit & Send”.
3. Modify the message, if necessary.
4. Press [Options] and select “Send”.

“Send” is not available when no recipients are set.

Reading a Message

Messages you receive are saved in the Inbox.

(SMS/MMS)

“Messages” → **“Message”** → **“Inbox”**

(Email)

“Messages” → **“Email”** → **“Inbox”**

1. Select a folder.
2. Select the message you wish to view.

Note

- When “Action Settings” in the motion control setting for “Messaging” is set to “On” (p. 104), you can change the size of the text by shaking the phone forward or backward.

Storing the Phone Number of a Sender in the Phonebook

(SMS/MMS)

“Messages” → **“Message”** → **“Inbox”**

(Email)

“Messages” → **“Email”** → **“Inbox”**

1. Select a folder.
2. Highlight the message from which you wish to store the phone number or Email address.
3. Press [Options] and select “Save Address”.
For details on creating a new Phonebook entry, see “Adding a New Entry” on page 37.

Calling the Phone Number of a Sender Embedded in the Message

(SMS/MMS)

“Messages” → **“Message”** → **“Inbox”**

1. Select a folder.
2. Highlight the message containing the phone number you wish to dial.
3. Press [Options] and select “Call Sender”.

Downloading a Single MMS

“Messages” → **“Message”** → **“Inbox”**

1. Highlight the message alert (📧) you wish to download.
2. Press [Options] and select “Download”.

Replying to a Message

(SMS/MMS)

“Messages” → **“Message”** → **“Inbox”**

(Email)

“Messages” → **“Email”** → **“Inbox”**

1. Select a folder.
2. Highlight the message you wish to reply to.
3. Press [Options] and select “Reply” (to sender only).
4. Select “Reply” or “Reply with History”.
5. Enter the message.
6. Press [Options] and select “Send”.
“Send” is not available when no recipients are set.

Forwarding a Message

(SMS/MMS)

“Messages” → **“Message”** → **“Inbox”**

(Email)

“Messages” → **“Email”** → **“Inbox”**

1. Select a folder.
2. Highlight the message you wish to forward.
3. Press [Options] and select “Forward”.
4. Perform steps 1 to 6 in “Creating a New Message” on page 57.

Sorting the Messages in the List

(SMS/MMS)

“Messages” → **“Message”** → **“Inbox”**

(Email)

“Messages” → **“Email”** → **“Inbox”**

1. Select a folder.
2. Press [Options] and select “View Settings”.
3. Select “Sort”.
4. Select the desired sort option.

Cell Broadcasts (M 4–4)

This function may not be available on all mobile phone networks. Contact your service provider for more information.

Enabling/Disabling Cell Broadcasts

“Messages” → **“Cell Broadcasts”** → **“Switch On/Off”**

1. Select “On” or “Off”.

Reading Cell Broadcast Messages



“Messages” → **“Cell Broadcasts”** → **“Read Messages”**

1. Select the desired subject.
2. Scroll the screen to read the message.
3. Press .

Subscribing to Cell Broadcasts

Select the page of the cell broadcast message that you want.

“Messages” → **“Cell Broadcasts”** → **“Settings”** → **“Set Info Subjects”**

1. Press .
2. Highlight the desired subject and press  to check.
3. Press [Save].

Area Info (M 4–5)

Enabling/Disabling Area Info

“Messages” → **“Area Info”**

1. Select “On” or “Off”.

Note

- *This function may not be available on all mobile phone networks. Contact your service provider for more information.*
- *If Area Info is set to “On”, the standby time will decrease.*

Messaging Settings (M 4–6)

General Settings

“Messages” → **“Messaging Settings”** →

“General Settings”

1. Select the item you wish to set up.
 - “Signature”:
Enables or disables “Auto Insert”. Select “Edit” to edit current signature.
 - “Auto Delete”:
Deletes the oldest message automatically, when the Inbox, Sent or Both (Inbox and Sent) is full.
 - “Message List View”:
Switches the mailbox listing.
 - “Inbox Display Settings”
Switches the Inbox listing.

- “Sent Box Display Settings”
Switches the Sent box listing.
- “Scroll Unit”:
Scroll through messages by “Single Line”, “Half Page” or “Whole Page”.
- “Message Type”:
Sets the type of message to send by default when a message is composed. When set to “Free”, the message is sent automatically either as an SMS or MMS as appropriate.
- “Animation View”:
Enables or disables the animation view function. Select “On” to display an animation in the background for specific pictograms when reading messages containing them.

SMS Settings

“Messages” → “Messaging Settings” → “SMS Settings”

1. Select the item you wish to set up.
 - “Delivery Report”:
Enables or disables Delivery Report request.
 - “Automatic Resend”:
Tries to resend the failed SMS message up to two times (“On” or “Off” selection).
 - “Expiry Time”:
This indicates the number of days and hours for which a message you send may remain undelivered to the message recipient. During this period, the message service centre will continually try to deliver the message to the recipient.
 - “Message Centre”:
Enter the message centre number.
If you wish to enter a country code for a message to an international number, long press  until a + sign is displayed.
 - “Reply Path”:
Enables or disables adding a reply path to the message.

MMS Settings

“Messages” → “Messaging Settings” → “MMS Settings”

1. Select the item you wish to set up.
 - “MMS Accounts”:
Select the desired account or select “Create New” to enter the following settings.
“Profile Name”: MMS profile name (unique name)
“Proxy”: Proxy setting for MMS
(When “Use Proxy” is set to “Off”, settings for “Access Point” can be made in place of “Proxy”.)
“Use Proxy”: Setting to connect by Proxy or not
“Relay Server URL”: MMS relay server
 - “Home Download”:
Controls the message download timing inside your network area.
“Always Download”: Downloads messages immediately from the server.
“Always Defer”: Defers message download.
 - “Roaming Download”:
Controls the message download timing when roaming outside of your network.
“Always Download”: Downloads messages immediately from the server.

- “Always Defer”: Defers message download.
- “Delivery Report”:
Enables or disables Delivery Report request.
- “Automatic Resend”:
Tries to resend the failed MMS message up to two times (“On” or “Off” selection).
- “Delivery Report Allow”:
Confirms whether or not a report is sent notifying the sender when you receive a message.
- “Read Report”:
Enables or disables Read Report request.
- “Read Report Allow”:
Enables or disables Read Report Allow when the recipient is required to inform the sender that the message has been read.
- “Expiry Time”:
This indicates the number of days and hours for which a message you send may remain undelivered to the message recipient. During this period, the message service centre will continually try to deliver the message to the recipient.
- “Slide Duration”:
Sets the duration of the slide.
- “Slide Auto Play”:
Enables or disables Slide Auto Play.

- “Send File Settings”:
Sets whether or not to send and save the file settings.
- “Creation Mode”:
When set to “Free”, you can attach files of any format to the mail. When set to “Restricted”, only certain formats and message sizes can be attached.
- “Hide Number”:
Sets whether to show or hide the sender’s address.
- “Delivery Time” (“Immediate”, “1 hour”, “12 hours”, “1 day”, “1 week”):
Sets the time the message is delivered after [Options] is pressed and “Send” is selected.
- “Anonymous Rejection”:
Enables or disables the rejection of messages from anonymous senders.

To Activate the MMS Account Profile

1. Select “MMS Accounts”.
2. Select the desired profile you wish to activate.

Email Settings

“Messages” → “Messaging Settings” → “Email Settings”

To Set an Email Account

1. Select “Email Accounts” and then select “Create New”.

2. Select the item you wish to set up.

“Account Name”: Email account name (unique name)

“Incoming Server”: Server Name, User ID, Password, Port Number, APOP Authentication and Encryption for the incoming server

“Outgoing Server”: Server Name, User ID, Password, Port Number, SMTP Authentication and Encryption for the outgoing server

“Access Point”: Access point for Email

“Email Address”: Email address

“Advanced Settings”: Your Name, Signature, Download Interval, Download Configuration, Max Download Limit, Save Sent Messages



To Activate the Email Account Profile

1. Select “Email Accounts”.

2. Select the desired profile you wish to activate.

Speed Mail

The Speed Mail function allows you to initiate messaging from the standby screen faster, with fewer keys to press.

The digit keys ( to ) can be used for speed mail.



A total of 8 data items can be assigned to these keys.

For details, see page 42.

1. Press a digit key in standby.

2. Press  to display the message screen.

The Email address assigned to the digit key pressed in step 1 is automatically entered in the recipient field.

To add a subject, highlight the subject field and press . Then enter the subject in the subject entry screen and press .

3. Perform steps 4 to 6 in “Creating a New Message” on page 57.

Browser (M 2)

Your phone is already configured to access the mobile Internet.

Your phone contains a WAP/Web browser used for surfing on the mobile Internet, where you can get a lot of useful information.

Normally, pages are designed for a mobile phone.

Main Menu

“Browser” → “Homepage”

The homepage is displayed.

“Browser” → “Bookmarks”

See page 67.

“Browser” → “My Saved Page”

You can view all the screenshots that have been saved onto the handset memory.

“Browser” → “Go to URL”

The URL entry screen is displayed. You can type in the URL of a site directly.





“Browser” → “Access History”

The history of pages you have recently browsed is displayed.

“Browser” → “Browser Settings”

See page 67.

Navigating a WAP or Web Page

- : Moves the cursor in the screen.
- : Executes the highlighted item in the screen when pressed.
- : Launches the option menu if it has not been launched.
Used to select an option from the option menu.
- : Opens the browser when in standby.
Moves to previous page when the browser is active.
-  (short press): Exits the browser.
(long press): Turns off the phone.

Note

- *When “Action Settings” in the motion control setting for “Browser” is set to “On” (p. 104), you can zoom in or zoom out by shaking the phone forward or backward.*
- *When the “Display Change” in the motion control setting for “Browser” is set to “On” (p. 104), you can change screen direction to the portrait position or landscape position according to the phone.*

Editing Bookmarks (M 2–2)

“Browser” → “Bookmarks”

1. Select the desired URL, and press [Options].

You can edit the list of Bookmarks by the following options:
(When a bookmark is highlighted)

- “Edit”: Edits URL address of the bookmark.
- “Add New Bookmark”: Creates new bookmarks.
- “Create Folder”: Creates new folders.
- “Open in New Tab”: Opens the bookmark as a new tab.
(This option is available only from the browser screen.)
- “Send”: Sends the URL address to recipients.
- “Move”: Moves bookmarks to another location or into a folder.
- “Details”: Displays detailed information of the WAP/Web page.
- “Delete”: Deletes a bookmark.
- “Delete All”: Deletes all bookmarks.
(When a folder is highlighted)
- “Add New Bookmark”: Creates new bookmarks.
- “Create Folder”: Creates new folders.
- “Rename Folder”: Renames the folder.
- “Move”: Moves folder and bookmarks in the folder to another location.

“Delete”: Deletes the folder and bookmarks in the folder.

“Delete All”: Deletes all folders and bookmarks.
(When there are no bookmarks)

“Add New Bookmark”: Creates new bookmarks.

“Create Folder”: Creates new folders.

Browser Settings (M 2–6)

“Browser” → “Browser Settings”

“Font Size”: Sets the font size for browsing.

“Scroll Settings”: Sets the scroll units and turns page navigation on/off.

“Cursor Settings”: Sets whether or not to show the cursor, and its speed.

“Downloads”: Sets whether or not to show images or play back sound when accessing a WAP/Web page.

“Memory Operation”: Clears Cache, Cookies, or Authentication information.

“Security Settings”: Adjusts the security prompt level.

“Download to”: Sets the preferred download location.

“Initialise Browser”: Initialises the browser settings and memory.

“Reset Settings”:	Resets all the browser settings to the default settings.
“Zoom Factor”:	Sets the zoom ratio for viewing a page.
“Zoom Area”:	Sets whether or not to enlarge the display area.
“Softkey Area”	Displays or hides the soft keys. The soft key functions are available even when they are not displayed.

Browser Options when Online

After launching the browser, press [Options].

“Forward”:	Goes to the next page.
“Bookmarks”:	See page 67.
“My Saved Page”:	Displays all the browser screenshots saved in the handset memory.
“Copy Text”:	Copies the text on the WAP/Web page.
“Reload Page”:	Reloads the WAP/Web page to get updated information.
“Go to URL”:	Allows you to type in the URL of a site directly. Handset browser will go to the WAP/Web page that you entered.
“Save Items”:	Saves items from the browsing pages.

“Convenient Functions”:	Displays functions for page operation.
“Home”:	Goes to the homepage.
“Settings”:	Displays the settings menu.
“Tab Menu”:	Displays the tab menu. (This option is available only when one window is opened and a URL link is highlighted.)
“Actual Page Width”/“Fit To Screen Width”:	Allows the browser to display in complete page mode or Virtual Screen mode.
“Help”:	Displays the Help screen.
“Exit”:	Exits the browser.

Gallery (M 6)

Gallery contains all your pictures, music and videos. You can also transmit pictures, sounds and video clips via infrared or *Bluetooth* wireless technology to other OBEX-enabled devices.

Picture Gallery (M 6–1)

Viewing Pictures

“Gallery” → **“Picture Gallery”**

1. Select the file you wish to view.
The selected picture is displayed.

Note

- To switch between viewing handset or memory card content, select the first item in the options menu.
- When “Action Settings” in the motion control setting for “Image Viewer” is set to “On” (p. 104), you can zoom in or zoom out by shaking the phone forward or backward. You can also change the picture being viewed by shaking the phone sideways.

Using Images as Wallpaper

“Gallery” → **“Picture Gallery”**

1. Highlight the file you wish to use as wallpaper.
2. Press [Options] and select “Set as Wallpaper”.

Editing Pictures

“Gallery” → **“Picture Gallery”**

1. Highlight the file you wish to edit.
2. Press [Options] and select “Edit”.
3. Select “Picture Editor” or “Composite”.
4. Select the desired option.

Note

- “Picture Editor” may not be available depending on the original picture and copyright issued.

Saving an Image to Phonebook Entries

This option can only be used for pictures saved in the handset memory.

“Gallery” → **“Picture Gallery”**

1. Highlight the file you wish to add to Phonebook.
2. Press [Options] and select “Save to Phonebook”.
To overwrite, select “As New Detail” and select the entry you wish to save.
To save as a new entry, select “As New”.

Video Gallery (M 6–2)

Playing Back Video Clip Files

“Gallery” → “Video Gallery”

1. Select the file you wish to play back.

To pause playback, press .

To resume, press  again.

To stop playback, press .

Note

- To switch between viewing handset or memory card content, select the first item in the options menu.

Using a Video Clip as a Ring Video Clip

You can set your video clip to play back when the phone rings.

“Gallery” → “Video Gallery”

1. Highlight the desired video clip.
2. Press [Options] and select “Set as Ring Video”.

Sound Gallery (M 6–3)

The downloaded sound files and the AMR data recorded by Voice Recorder are managed in Sound Gallery. The default ringtones are not contained within Sound Gallery. Only the sound files that can be played back on the phone are stored in Sound Gallery.

Playing Back Sound Files

“Gallery” → “Sound Gallery”

1. Select the file you wish to play back.

To stop playback, press .

Note

- Playback may not be available for some sound files.
- To switch between viewing handset or memory card content, select the first item in the options menu.

Using the Sound Files as a Ringtone

“Gallery” → “Sound Gallery”

1. Highlight the file you wish to use as a ringtone.
2. Press [Options] and select “Set as ringtone”.

Themes (M 6–4)

You can easily customise the display by using the theme files.

Note

- Preset themes are not included in “Themes” in “Gallery”.

Viewing Previews

“Gallery” → “Themes”

1. Highlight the theme file you wish to preview.
2. Press .

The selected theme file is displayed.

Note

- To switch between viewing handset or memory card content, select the first item in the options menu.

Setting a Theme

“Gallery” → “Themes”

1. Select the desired theme file.

The selected theme file is set as the default theme.

Flash[®] (M 6–6)

Playing Back Flash[®] Files

“Gallery” → “Flash[®]”

1. Select the file you wish to play back.

To stop playback, press .

Note

- Only Flash[®] files up to 150 KB can be played back.

Using Flash[®] as Wallpaper

“Gallery” → “Flash[®]”

1. Highlight the file you wish to use as wallpaper.
2. Press [Options] and select “Set as Wallpaper”.

Using Flash[®] as a Ringtone

“Gallery” → “Flash[®]”

1. Highlight the file you wish to use as a ringtone.
2. Press [Options] and select “Set as ringtone”.

Other Documents (M 6–7)

Opening a Document File

“Gallery” → “Other Documents”

1. Select the desired file.

Note

- To switch between viewing handset or memory card content, select the first item in the options menu.

Common Option Menus

Gallery contains the following folders.

“Gallery” → “Picture Gallery”

“Gallery” → “Video Gallery”

“Gallery” → “Sound Gallery”

“Gallery” → “Themes”

“Gallery” → “Java™ Gallery”

“Gallery” → “Flash®”

“Gallery” → “Other Documents”

Activating Files with Copyright Protection (DRM)

Some pictures, sound files, video clips, Flash® files and theme files have a digital copy protection program, which is called DRM (Digital Rights Management). You need to activate the digital licence permission to open the files. Files protected with DRM are displayed with .

1. Select the appropriate folder for the desired file type.
2. Highlight the file you wish to activate.
3. Press [Options] and select “Get Contents Key”.

Note

- Some pictures with DRM may not be opened even when an attempt is made to activate it.

Sending Gallery Data

1. Select the appropriate folder for the desired file type.
2. Highlight the desired file.
3. Press [Options] and select “Send”.
4. Select “As Message”, “As Email”, “Bluetooth”, “Infrared” or “Send via IrSS”.

Note

- Pictures/Sounds/Video clips/Themes/Flash® files/Other Documents data protected by copyright cannot be sent attached to a message, with the exception of Separate Delivery files.
- When pairing, you need to enter your passcode when establishing contact with a Bluetooth wireless technology enabled device for the first time.

Receiving Gallery Data

When the phone receives Gallery data, a confirmation message is displayed in standby.

1. Select “Yes”.
The received data is saved in the corresponding Gallery folder.

Using Gallery Data

1. Select the appropriate folder for the desired file type (p. 72).
2. Highlight the desired file.
3. Press [Options] and select “Manage Items”.
4. Select the desired option.

“Sort”: Sorts files according to a specific sequence.

“Rename”: Renames the file or folder.

“Create Folder”: Creates a new folder.

“Change List View”: Changes the list view.

“Check All”: Selects all files in the list.

Note

- “Manage Items” is not available for “Java™ Gallery”.

To Delete the File

1. Select the appropriate folder for the desired file type (p. 72).
2. Highlight the desired file.
3. Press [Options] and select “Delete”.

To See the Gallery Details

1. Select the appropriate folder for the desired file type (p. 72).
2. Highlight the file you wish to view the details of.
3. Press [Options] and select “Details”.

Selecting Multiple Files

1. Select the appropriate folder for the desired file type (p. 72).
2. Highlight the file you wish to select.
3. Press [Check].
4. Repeat steps 2 and 3 until you select all the desired files.

Memory Status (M 6–9)

Handset Memory: Pictures, Videos, Sound Gallery, Themes, Java™ Gallery, Flash®, Other Documents, Others, Total and Free

Memory Card: Pictures, Videos, Sound Gallery, Themes, Flash®, Other Documents, Others, Total and Free

“Gallery” → “Memory Status”

1. Select “Handset Memory” or “Memory Card”.

Note

- When a memory card is inserted into the phone, “Temp Card Folder” is additionally displayed above “Memory Status”.
- The shortcut keys for “Temp Card Folder” is M 6–8 and the shortcut keys for “Memory Status” changes to M 6–9.

Java™ (M 1)

Java™ Gallery (M 1–1)

Executing Applications

“Java™” → “Java™ Gallery”

1. Select the title of the application you wish to execute.
2. To end the application, press  and select “End”.

Setting as a Screensaver for the Display

“Java™” → “Java™ Gallery”

1. Highlight the file you wish to use as a screensaver.
2. Press [Options] and select “Set as Screensaver”.

Setting Permission

“Java™” → “Java™ Gallery”

1. Highlight the desired Java™ application.
2. Press [Options] and select “Permission”.
3. Select one of the following options:
 - “Phone Call”: Sets permission to make voice calls.
 - “Network Access”: Sets permission to access the network.
 - “Messaging”: Sets permission to perform SMS messaging.
 - “Autorun”: Sets permission to perform the Autorun function.
 - “Bluetooth Connection”: Sets permission to connect via *Bluetooth*.

“Read User Data”: Sets permission to read user data, such as Phonebook entries, mailbox (Inbox) and Gallery data.

“Write User Data”: Sets permission to write entries in your phone, such as Phonebook entries, mailbox (Inbox) and Gallery data.

“Use Multimedia”: Sets permission to use the multimedia recording.

4. Select one of the following options:

“Always Ask”: The confirmation message is displayed every time the security sensitive function is executed.

“Ask Once”: The confirmation message is displayed the first time the security sensitive function is executed.

“Never Ask”: The confirmation message is not displayed while execution of the security sensitive function is authorised.

“No”: Execution of the security sensitive function is not authorised.

Note

- Options displayed in step 4 depend on the item selected in step 3.
- To clear all the permission settings, select “Reset” in step 3.
- Some permissions are not available for some Java™ applications.

Viewing Application Information

“Java™” → “Java™ Gallery”

1. Highlight the desired Java™ application.
2. Press [Options] and select “Details”.

Deleting an Application

“Java™” → “Java™ Gallery”

1. Highlight the desired Java™ application.
2. Press [Options] and select “Delete”.

Java™ Settings (M 1–2)

Application Volume

“Java™” → “Java™ Settings” → “Application Volume”

1. Press ▲ (or ▶) to increase the volume or press ▼ (or ◀) to decrease the volume and then press ○.

Backlight

“Java™” → “Java™ Settings” → “Backlight” → “Switch On/Off”

1. Select from “Always On”, “Always Off” or “Normal Settings”.

“Always On”: Lit while the application is operated.

“Always Off”: Unlit while the application is operated even if a key is pressed.

“Normal Settings”: Works with the main backlight setting (p. 99).

To Set the Blinking Operation

If set to “Off”, the backlight cannot be controlled from the application.

“Java™” → “Java™ Settings” → “Backlight” → “Blink”

1. Select “On” or “Off”.

Vibration

“Java™” → “Java™ Settings” → “Vibration”

1. Select “On” or “Off”.

Calls & Alarms

“Java™” → “Java™ Settings” → “Calls & Alarms”

1. Select “Voice Call”, “Incoming Message”, “Alarm” or “Push Request”.
2. Select the desired method.

- “Call Priority”, “Message Priority”, “Alarm Priority” or “Request Priority”:

The application is suspended automatically, and you can receive a call or a message, the alarm will sound or *Bluetooth* connection will start.

After finishing the call or receiving the message, or when the alarm or *Bluetooth* connection ends, the suspend indicator (🔕) is displayed letting you know there is a suspended application.

- “Call Notice”, “Message Notice”, “Alarm Notice” or “Request Notice”:

The information is displayed on the first line of the screen while the application continues. If you press (🔕), the application is suspended, and you can receive the call. After finishing the call or receiving the message, the suspend indicator (🔕) is displayed letting you know there is a suspended application.

Set Java™ Wallpaper

To Switch the Java™ Wallpaper On or Off

“Java™” → “Java™ Settings” → “Java™ Wallpaper” → “Switch On/Off”

1. Select “On” or “Off”.

To Set the Activation Time

“Java™” → “Java™ Settings” → “Java™ Wallpaper” → “Activation Time”

1. Enter an activation time from 1 to 10 seconds (in 2 digits) using the keypad.

To Set the Suspend Time

“Java™” → “Java™ Settings” → “Java™ Wallpaper” → “Suspend Time”

1. Set the desired time period from “after 15 min.” to “after 6 hours”.

Surround

You can set surround sound for Java™ applications.

“Java™” → “Java™ Settings” → “Surround”

1. Select “On” or “Off”.

Default Settings

“Java™” → “Java™ Settings” → “Set to Default”

1. Enter your handset code.

The default handset code is “9999”. For details on changing the handset code, see “Change Handset Code” on page 106.

Clearing All Memory

“Java™” → “Java™ Settings” → “Memory All Clear”

1. Enter your handset code.

The default handset code is “9999”. For details on changing the handset code, see “Change Handset Code” on page 106.

Java™ Information (M 1–3)

“Java™” → “Java™ Information”

The information about the licences belonging to Java™ is displayed.

Organiser (M 3)



Calendar (M 3–1)

Creating a New Entry

“Organiser” → **“Tools 1” tab** → **“Calendar”**

1. Select the desired day to which you want to add an event.
2. Select “Add New Entry”.
3. Enter the subject.
4. Enter the start date and time.
5. Select the desired category.
6. Select the reminder time.
When selecting “Other”, enter the desired reminder date and time.
7. Press [Save].

Note

- If the date and time settings have not been entered, the date and time entry screen is displayed (p. 103).
- The reminder will not sound when the profile is set to “Silent”, but will sound when “General Volume” (p. 100) is set to “Silent”.
- You can display the Stamp screen by pressing  in Month and 3Month view. Select the desired category and press .
- The lunar calendar is automatically displayed when “Language” is set to Chinese.

To Change the Settings

1. Select the item you wish to change in the New Entry screen.
 - “Reminder”: Sets options including “Reminder Time”, “Assign Tone/Video” and “Duration” for the reminder.
 - “Repeat”: Sets the number of times the reminder sounds.
 - “Location”: Sets the location for the schedule entry.
 - “Description”: Enables entering a memo for the schedule entry.
 - “Secret”: Sets to show or hide the schedule entry. Set to “On” to make the data secret or select “Off” to leave it as it is.

Viewing a Schedule Entry

“Organiser” → **“Tools 1” tab** → **“Calendar”**











1. Select the day you wish to view.
2. Select the desired entry.

To Search by Date











1. In any view, press [Options] and select “Go to”.
2. Select “Today” to display today or “Enter Date” to enter the desired date.

Tip

- You can control the view by using the following:
Month, 2Month, 3Month or 6Month view

- : Displays the previous month or previous screen.
- : Displays the next month or next screen.
- : Displays the Help screen.
- : Displays the Stamp screen (Month and 3Month view only).
- : Displays the Set Colour screen.
- : Moves the cursor to today.
- : Displays the Find (By Subject) screen.
- : Displays the Go to (Enter Date) screen.
- : Displays the Find (By Category) screen.
- : Moves the cursor to left (the previous day) or to right (the next day).
- : Moves the cursor upward (last week) or downward (next week).

Week view

- : Displays the previous week.
- : Displays the next week.
- : Displays the Help screen.
- : Displays the Set Colour screen.
- : Moves the cursor to today.
- : Displays the Find (By Subject) screen.
- : Displays the Go to (Enter Date) screen.
- : Displays the Find (By Category) screen.
- : Moves the cursor to left (the previous day) or to right (the next day).
- : Moves the Week view up or down (the previous hour or next hour).

Setting a Colour

You can highlight a date or days of the week with seven colour options.

“Organiser” → “Tools 1” tab → “Calendar”

For Date Colour

1. Press [Options] and select “Calendar Settings”.
2. Select “Set Colour”.
3. Select “By Date”.
4. Select the desired colour.

For Days of the Week Colour

1. Press [Options] and select “Calendar Settings”.
2. Select “Set Colour”.
3. Select “By Week” and then select days of the week you wish to colour.
4. Select the desired colour.

Note

- *If the same date is set with both a date colour and a day of the week colour, the date is highlighted in the date colour.*
- *Up to 100 days can be set for the highlights.*

Setting a Holiday

You can set personal holidays in the calendar.

“Organiser” → “Tools 1” tab → “Calendar”

1. Press [Options] and select “Calendar Settings”.
2. Select “Set Holiday”.
3. Enter the name.
4. Enter the date.
5. Select the desired frequency.
6. Press [Save].

Finding a Schedule Entry

To Search by a Subject

“Organiser” → “Tools 1” tab → “Calendar”

1. In any view, press [Options] and select “Find”.
2. Select “By Subject”.
3. Enter a few letters of the subject.
Search results are displayed in time order.

To Search by a Category

“Organiser” → “Tools 1” tab → “Calendar”

1. In any view, press [Options] and select “Find”.
2. Select “By Category”.
3. Select a desired category.
Search results are displayed in time order.

Editing a Schedule Entry

“Organiser” → “Tools 1” tab → “Calendar”

1. Select the day you wish to edit.
2. Highlight the entry you wish to edit, press [Options], then select “Edit”.
3. Select the desired item and modify the entry.
4. Press [Save].

Deleting Schedule Entries

1. In any view, press [Options] and select “Delete”.
2. Select the desired option.
 - “This Appointment” (daily view):
Deletes the selected entry.
 - “All This Day”: Deletes all entries for the selected day.
 - “All This Month” (Month and 3Month view):
Deletes all entries for the selected month.
 - “Last Two Months” (2Month view):
Deletes all entries for the selected two months.
 - “All This Week” (Week view):
Deletes all entries for the selected week.
 - “Up to Last Month” (Month and 3Month view):
Deletes all entries before the selected month.
 - “Up to Last Week” (Week view):
Deletes all entries before the selected week.
 - “All This 6Months” (6Month view):
Deletes all entries for the selected six months.
 - “All Appointments”:
Deletes all entries in this application.

Sending a Schedule Entry

“Organiser” → “Tools 1” tab → “Calendar”

1. Select the day including schedule entries you wish to send.
2. Highlight the entry you wish to send, press [Options], then select “Send”.
3. Select “As Message”, “As Email”, “Via Bluetooth” or “Via Infrared”.

For “Via Bluetooth”

For details, see “Bluetooth” on page 118.

For “Via Infrared”

For details, see “Infrared” on page 120.

Note

- *When pairing, you need to enter your passcode when establishing contact with a Bluetooth wireless technology enabled device for the first time.*

Receiving a Schedule Entry

1. Select “Yes”.
The received entry is saved in the Calendar.
Select “No” to reject.

Viewing the Memory Status

1. In any view, press [Options] and select “Memory Status”.

Alarms (M 3–2)

Setting the Alarms

“Organiser” → **“Tools 1” tab** → **“Alarms”**

1. Select the blank line (—:—) you wish to set an alarm to.
2. Enter the desired time.
3. Press [Save].

To Change the Settings

1. Select the item you wish to change in the Set Alarm screen.
 - **“Subject”**:
Sets the subject for the alarm setting.
 - **“Repeat”**:
Sets the number of times the alarm sounds.
 - **“Assign Tone/Video”**:
Assigns a tone or video clip file to the alarm.
 - **“Snooze”**:
Sets the snooze option.
 - **“Alarm Volume”**:
Sets the desired volume.
The alarm will not sound when “Alarm Volume” is set to “Silent”.
 - **“Vibration”**:
Sets the vibration pattern of the alarm.
For details on selecting a vibration, see “Vibration” on page 102.

- **“Duration”**:
Sets the duration of the alarm.

Resetting an Alarm

“Organiser” → **“Tools 1” tab** → **“Alarms”**

1. Highlight the alarm you wish to reset.
2. Press [Options] and select “Reset Alarm”.

Resetting All Alarms

“Organiser” → **“Tools 1” tab** → **“Alarms”**

1. Highlight an alarm.
2. Press [Options] and select “Clear All”.

Setting for Silent Profile

“Organiser” → **“Tools 1” tab** → **“Alarms”** → **“Settings”**

1. Select “For Silent Profile”.
2. Select “Ring” or “Do not Ring”.

Setting the Alarm to the World Clock Time

“Organiser” → **“Tools 1” tab** → **“Alarms”** → **“Settings”**

1. Select “Link to World Clk”.
2. Select “On” or “Off”.

Tasks (M 3–3)

Creating a New Entry

“Organiser” → **“Tools 1” tab** → **“Tasks”**

1. Select “Add New Entry”.
2. Enter the subject.
3. Enter the due date and time.
4. Press [Save].

Note

- If the date and time settings have not been entered, the date and time entry screen is displayed (p. 103).

To Select the Reminder Time

1. On the New Entry screen, select “Reminder”.
2. Select “Reminder Time”.
3. Select the reminder time.

When selecting “Other”, enter the desired reminder date and time.

To Change the Type of Alarm Tone or Video Clip File

1. On the New Entry screen, select “Reminder”.
2. Select “Assign Tone/Video”.
3. Select “Preset Sounds”, “Sound Gallery”, “Video Gallery” or “Flash®”.

4. Select the desired tone or video clip file.





For details on selecting a ringtone or a ring video clip, see “Assigning a Ringtone or a Ring Video Clip for an Incoming Call” on page 100.

To Change the Duration of Alarm Tone or Video

1. On the New Entry screen, select “Reminder”.
2. Select “Duration”.
3. Select the desired duration.

To Set the Alarm Volume

“Organiser” → **“Tools 1” tab** → **“Tasks”**

1. Press [Options] and select “Alarm Settings”.
2. Select “Alarm Volume”.
3. Press  (or ) to increase the volume or press  (or ) to decrease the volume and then press .

To Set the Vibration

“Organiser” → **“Tools 1” tab** → **“Tasks”**

1. Press [Options] and select “Alarm Settings”.
2. Select “Vibration”.
3. Select “On”, “Link to Sound” or “Off”.

To Set for the Silent Profile

“Organiser” → **“Tools 1” tab** → **“Tasks”**

1. Press [Options] and select “Alarm Settings”.
2. Select “For Silent Profile”.
3. Select “Ring” or “Do not Ring”.

To Set the Priority

1. On the New Entry screen, select “Priority”.
2. Select “Normal”, “High” or “Low”.

To Change the Description

1. On the New Entry screen, select “Description”.
2. Enter a memo for the task entry.

To Make the Entry Secret

1. On the New Entry screen, select “Secret”.
2. Select “On” to make the data secret or select “Off” to leave it as it is.

To Unlock the Secret Settings Temporarily

“Organiser” → **“Tools 1” tab** → **“Tasks”**

1. Press [Options] and select “Unlock Temporarily”.

Note

- *Once the phone has returned to standby, the temporarily unlocked tasks are reset as secret data.*

Making the Entry as Completed or Uncompleted

“Organiser” → **“Tools 1” tab** → **“Tasks”**

1. Highlight the desired entry.
2. Press [Done].
To make the entry incomplete, press [Not Yet].

Finding a Task Entry

To Search by a Subject

“Organiser” → **“Tools 1” tab** → **“Tasks”**

1. Press [Options] and select “Find”.
2. Select “By Subject”.
3. Enter a few letters of the subject and press Ⓞ.
Search results are displayed in time order.

To Search by a Due Date

“Organiser” → **“Tools 1” tab** → **“Tasks”**

1. Press [Options] and select “Find”.
2. Select “By Due Date”.
3. Enter a desired due date and press Ⓞ.
Search results are displayed in time order.

Sending a Task Entry

“Organiser” → **“Tools 1” tab** → **“Tasks”**

1. Highlight the task entry you wish to send.
2. Press [Options] and select “Send”.
3. Select “As Message”, “As Email”, “Via Bluetooth” or “Via Infrared”.

For “Via Bluetooth”

For details, see “Bluetooth” on page 118.

For “Via Infrared”

For details, see “Infrared” on page 120.

Note

- When pairing, you need to enter your passcode when establishing contact with a Bluetooth wireless technology enabled device for the first time.

Viewing the Memory Status

“Organiser” → **“Tools 1” tab** → **“Tasks”**

1. Press [Options] and select “Memory Status”.

Deleting Entries

“Organiser” → **“Tools 1” tab** → **“Tasks”** → **[Options]** → **“Delete”**

1. Select the desired option.

- “This Task”: Deletes the selected entry.
- “All Completed Tasks”: Deletes all checked entries.
- “All Tasks”: Deletes all entries.

Calculator (M 3–4)

“Organiser” → **“Tools 1” tab** → **“Calculator”**



Key operations for calculation are as follows:

To enter a decimal point, press $\left[\frac{\square}{\square} \right]$.

To clear the entered number or function, press $\left[\frac{\square}{\square} \right]$.

To do the calculations, press $\left[\bigcirc \right]$.

To start a new calculation, press $\left[\frac{\square}{\square} \right]$.

Rate Conversion

To Set a Currency Conversion Rate

“Organiser” → **“Tools 1” tab** → **“Calculator”** → **[Options]**
→ **“Currency Converter”** → **“Exchange Rate”**

1. Select “Domestic” or “Foreign”.
2. Enter the domestic or foreign currency.

To Convert a Value

“Organiser” → **“Tools 1” tab** → **“Calculator”**

1. Enter the value to be converted.
2. Press [Options] and select “Currency Converter”.
3. Select “Convert to Domestic” or “Convert to Foreign”.

Expenses Memo (M 3–5)

Recording in the Expenses Memo (M 3–5–1)

“Organiser” → **“Tools 1” tab** → **“Expenses Memo”** → **“Add New Expense”**

1. Enter the expenses using the digit keys.
2. Select the desired category.
Expenses memo is registered.

Viewing Totals (M 3–5–2)

“Organiser” → **“Tools 1” tab** → **“Expenses Memo”** → **“Totals”**

Recorded expenses are displayed on the screen.

To Change Category

1. In the total view, highlight the desired item.
2. Press [Change].
3. Select the desired category.

To Change Amount

1. In the total view, highlight the desired item.
2. Press [Options] and select “Change Amount”.
3. Enter the desired amount using the digit keys.

To Delete a Recorded Item or All Items

1. In the total view, highlight the desired item.
2. Press [Options] and select “Delete Item” or “Delete All”.

Editing the Category Name (M 3–5–3)

“Organiser” → **“Tools 1” tab** → **“Expenses Memo”** → **“Edit Category”**

1. Select the desired category name.
2. Modify the name.

Stopwatch (M 3–▶–1)

You can store 4 lap times when using the stopwatch function.

“Organiser” → **“Tools 2” tab** → **“Stopwatch”**

1. Press [Start].
Press [LAP] to view the lap time before the stopwatch stops.
Last 4 lap times are saved.
2. Press [Stop].

Resetting the Time

1. After stopping the stopwatch, press [Options] and select “Reset”.

Countdown Timer (M 3–▶–2)

“Organiser” → **“Tools 2” tab** → **“Countdown Timer”**

1. Enter the time to count.
You can set the time from 1 second to 60 minutes.
2. Press [Start].
Press [Suspend] to pause the countdown.
Press [Resume] to continue counting.
3. When the countdown has finished, press [Stop] and then press [Start] to start the countdown again.

Editing the Countdown Time

1. In the countdown start screen, press [Options] and select “Edit”.
2. Modify the desired time.

World Clock (M 3–▶–3)

Setting the Time Zone

“Organiser” → **“Tools 2” tab** → **“World Clock”**

1. Press [Edit] and select “Set Time Zone”.
The current time zone is indicated by red line on the world map.
2. Press ◀ or ▶ to change the time zone.
3. Press [Accept].

To Set the Custom Time Zone

“Organiser” → **“Tools 2” tab** → **“World Clock”**

1. Press [Edit] and select “Set Time Zone”.
2. Press [Custom].
3. Enter the desired city name and time difference.

Setting Daylight Saving

“Organiser” → **“Tools 2” tab** → **“World Clock”**

1. Press [Edit] and select “Daylight Saving”.
2. Select “On” or “Off”.

Hour Minder (M 3—▶—4)

Hour Minder function informs you of the time by sounding a tone.

“Organiser” → **“Tools 2” tab** → **“Hour Minder”**

1. Select “Switch On/Off”.
2. Select “On” or “Off”.
3. Select “Select Time”.
4. Select the desired time.
5. Press [OK].
6. Press [Save].

To Change the Settings



“Organiser” → **“Tools 2” tab** → **“Hour Minder”**

1. Select “Advanced”.
2. Select the item you wish to change.
 - “Assign Tone/Video”: Sets the tone or video.
 - “Volume”: Sets the volume of the tone.
 - “Vibration”: Sets the vibration.
 - “Duration”: Sets the duration.
 - “For Silent Profile”: Sets whether to sound the tone when the profile is set to “Silent”.
 - “Link to World Clk”: Sets to sound the tone according to the time of the World Clock.

Document Viewer (M 3—▶—▶—1)

You can view PC files.

“Organiser” → **“Tools 3” tab** → **“Document Viewer”**

1. Select the file you wish to view.
 - To cancel reading, press  or .

Note

- You can view the following types of files with the document viewer: PDF (.pdf), Microsoft Excel (.xls), Microsoft Word (.doc), Microsoft PowerPoint (.ppt).
- For the shortcut keys that can be used in the document viewer, refer to the help by pressing [Options] and selecting “Help”.
- A file of up to 10 MB can be opened.
- Some files may not be displayed correctly depending on the type or size, such as a file of vertical text (not supported) or when the memory runs out while viewing a large file.
- Some PDF files may not be displayed correctly due to a shortage of memory even if the file size is not large when numerous fonts are embedded or image data is pasted.
- Depending on how the PDF file was created, some characters in a PDF file may not be displayed.
- Document files that are saved in Gallery or linked in a WAP/Web page can be viewed with the document viewer.

- When “Action Settings” in the motion control setting for “Document Viewer” is set to “On” (p. 104), you can zoom in or zoom out by shaking the phone forward or backward. You can also change the page being viewed by shaking the phone sideways.
- Document files that are protected with a password cannot be viewed with the document viewer.

Notepad (M 3———2)

You can register up to 500 entries for use in text messages and multimedia messages. The maximum capacity of the Notepad entry is 8192 characters.



Adding Phrases to Notepad

“Organiser” → “Tools 3” tab → “Notepad” → “Add New Entry”

1. Enter the text.
2. Select the desired category.

Editing Notepad

“Organiser” → “Tools 3” tab → “Notepad”

1. Highlight the entry you wish to edit.
2. Press [Options] and select “Edit Text”.
To view the entry, press .
To delete the entry, press [Options] and select “Delete”.
3. Modify the text and press .

Changing the Category

“Organiser” → “Tools 3” tab → “Notepad”

1. Highlight the desired entry.
2. Press [Options] and select “Change Category”.
3. Select the desired category.

Sending Notepad

“Organiser” → “Tools 3” tab → “Notepad”

1. Highlight the entry you wish to send.
2. Press [Options] and select “Send”.
3. Select “As Message”, “Via Bluetooth” and “Via Infrared”.

For “Via Bluetooth”

For details, see “Bluetooth” on page 118.

For “Via Infrared”



For details, see “Infrared” on page 120.

Voice Recorder (M 3———3)





The recorded voice clip is saved in Sound Gallery. Voice clips are saved in .amr format.

Recording a Voice Clip

“Organiser” → “Tools 3” tab → “Voice Recorder”



1. Press  to start recording.
To stop recording before the recording time is over, press .
2. Select “Save” to save the voice clip.

Note

- Press  (or ) or  (or ) to adjust the sound volume when playing back the recorded file.

Sending Voice Clips

“Organiser” → **“Tools 3” tab** → **“Voice Recorder”**

1. Press  to start recording.
To stop recording before the recording time is over, press .
2. Select “Save and Send”.

Selecting the Record Time

“Organiser” → **“Tools 3” tab** → **“Voice Recorder”** → **[Options]** → **“Record Time”**

1. Select “For Message” or “Extended Voice”.
When selecting “Extended Voice”, voice clips are automatically saved in the memory card.

Selecting Storage Memory

“Organiser” → **“Tools 3” tab** → **“Voice Recorder”** → **[Options]** → **“Save Recording to”**

1. Select the desired location.
When selecting “Choice”, you can select the location when saving a voice clip.

Scanner (M 3---4)

With the built-in digital camera, you can read barcodes in QR code format and also read the text on business cards. The scanned data can be saved as a Phonebook entry, URL, Email address and text.

Note

- When scanning does not take place, it may be due to one of the following reasons: type or size of barcode or business card, scratches, dirt, damage, print quality, light reflection, etc.

Reading Barcodes

“Organiser” → **“Tools 3” tab** → **“Scanner”** → **“Scan Barcode”**

1. Display the barcode using the camera.
2. Press [Scan].
3. Press [Options] and select the desired option.
The options vary depending on the scanned data.
“Save”: The result is saved.
“Send Message”: The result is sent as SMS or MMS.
“Save to Notepad”: The result is saved as text.
“Copy”: The result is copied.

To Set the Focus Mode

“Organiser” → **“Tools 3” tab** → **“Scanner”** → **“Scan Barcode”**

1. Press [Options] and select “Focus”.
2. Select “Auto Focus”, “Macro” or “Manual Focus”.

To Use the Continuous Scanning

“Organiser” → **“Tools 3” tab** → **“Scanner”** → **“Scan Barcode”**

1. In scanning mode, press [Options] and select “Continuous Scan”.
2. Select “On” or “Off”.

To Set the Mobile Light

“Organiser” → **“Tools 3” tab** → **“Scanner”** → **“Scan Barcode”**

1. Press [Options] and select “Mobile Light”.
2. Select “On” or “Off”.

To Adjust the Exposure

“Organiser” → **“Tools 3” tab** → **“Scanner”** → **“Scan Barcode”**

1. Press [Options] and select “Exposure”.
2. Select the desired exposure.

Scanning Business Cards

“Organiser” → **“Tools 3” tab** → **“Scanner”** → **“Scan Card”**

1. Frame the business card in the centre of the screen using the camera and press [Read].

To cancel scanning, press [Back] or .

2. Press [Scan] or .

The scanned results are displayed.

3. Press [Assign].

The scanned data is saved to Phonebook.

When the number of characters that can be scanned is exceeded, select “Yes”.

To paste the scanned data to a message, press [Options] and select “Send Message”.

To save the scanned data as a Notepad entry, press [Options] and select “Save to Notepad”.

To copy the scanned data, press [Options] and select “Copy”.

To specify the destination of the scanned data, press [Options] and select “Save to”, and then select the desired destination.

To attach the scanned image to a Phonebook entry, press [Options] and select “Add Image”, and then select “On”.

Note

- Only Simplified Chinese and alphanumerical characters can be scanned.

- *The following items can be saved to a Phonebook entry: name, phone number, fax number, Email address, postal address, postal code, company name, division, post, URL address, notes (date scanned, etc.).*
- *Depending on the business card, the contents may not be scanned or recognized (read) correctly, and characters and symbols not on the business card may be included in the scanned results.*
- *Text cannot be scanned from business cards:*
 - *With background designs*
 - *That are handwritten or have handwriting-like font*
 - *That have both horizontal and vertical text*
 - *That are shown in a display*
- *Scanning may not take place in the following cases:*
 - *The contrast between the text and background is low.*
 - *There is extremely small font used on the business card.*
 - *Italics, ancient characters or irregular characters are used on the business card.*
 - *The business card is printed on glossy paper.*
 - *Logos or logo-type characters are used on the business card.*
 - *Characters are extremely close to each other or are touching.*
- *The scanned data may not be classified as the correct item.*
- *The + symbol for an international number may not be saved to the Phonebook even if it is scanned from the business card.*

- *Make sure the business card is displayed completely in the screen. Be sure that objects other than the business card (especially those with text) are not displayed in the screen.*
- *Scanning is easier when the font displayed is larger, however, if the camera is placed too close to the business card, the text will become out of focus. Hold the camera at least 10 cm away from the business card.*
- *Up to 5 phone numbers and 5 Email addresses can be saved in a Phonebook entry.*

To Select the Focus Mode

“Organiser” → **“Tools 3” tab** → **“Scanner”** → **“Scan Card”**

1. Press [Options] and select “Focus”.
2. Select “Auto Focus”, “Macro” or “Manual Focus”.

To Set the Mobile Light

“Organiser” → **“Tools 3” tab** → **“Scanner”** → **“Scan Card”**

1. Press [Options] and select “Mobile Light”.
2. Select “On” or “Off”.

To Adjust the Exposure

“Organiser” → **“Tools 3” tab** → **“Scanner”** → **“Scan Card”**

1. Press [Options] and select “Exposure”.
2. Select the desired exposure.

To Specify the Destination of the Scanned Data

“Organiser” → **“Tools 3” tab** → **“Scanner”** → **“Scan Card”**

1. Press [Options] and select “Save to”.
2. Select the desired destination.

To Attach the Scanned Image to a Phonebook Entry

“Organiser” → **“Tools 3” tab** → **“Scanner”** → **“Scan Card”**

1. Press [Options] and select “Add Image”.
2. Select “On” or “Off”.



Viewing the Scanned Data

“Organiser” → **“Tools 3” tab** → **“Scanner”** → **“Scanned Results”**

1. Highlight the data you wish to view, then press [View].

Phone Help (M 3---5)

“Organiser” → **“Tools 3” tab** → **“Phone Help”**

1. Select “Settings Method”, “Common Functions” or “Key Operation”.
2. Press  or .

Scratch Pad (M 3---6)

Scratch Pad can be used as a screen memo for the multiple purposes.

Using Scratch Pad

“Organiser” → **“Tools 3” tab** → **“Scratch Pad”**

1. Enter the text.
2. Press  when finished.
3. Select the purpose for using the entry.

The entry can be used for the following purposes:

Save to Notepad, Save as Sticky Note, Save to Calendar, Save to Tasks, Save to Phonebook or Save as Text File

SIM Application (M 10)

You can refer to the information on the SIM card. Contact your service provider for further details.

Settings (M 9)

Phone Settings

Setting a Profile

There are 4 profiles: “Normal”, “Car”, “Silent” and “Original”.

Activating a Profile

“Settings” → **“Phone Settings” tab** → **“Profiles”**

1. Select the desired profile.

Note

- When a profile is set, the corresponding indicator described on page 20 is displayed in standby.
- For “Silent” and “Car” profiles, some of the settings, such as volume level, cannot be changed.

Resetting Profile Settings

“Settings” → **“Phone Settings” tab** → **“Profiles”**

1. Highlight the profile you wish to reset.
2. Press [Reset].
3. Enter your handset code.

The default handset code is “9999”. For details on changing the handset code, see “Change Handset Code” on page 106.

Event Light

“Settings” → **“Phone Settings” tab** → **“Profiles”**

1. Highlight “Car”, “Silent” or “Original”.
2. Press [Edit].
3. Select “Event Light”.
4. Select the desired option.

“For Voice Call”: Flashes when an incoming voice call is received.

“For New Message”: Flashes when a new message is received.

“Java Start”: Flashes when *Bluetooth* notification is received.

“Delivery Report”: Flashes when a delivery report is received.

Status Light

“Settings” → **“Phone Settings” tab** → **“Profiles”**

1. Highlight “Car”, “Silent” or “Original”.
2. Press [Edit].
3. Select “Status Light”.

4. Select the desired option.

- “For Missed Call”: Flashes when an incoming voice call is missed.
- “For New Message”: Flashes when a new message is missed.
- “For Answer Phone”: Flashes when a new answer phone message is saved.
- “Java Start”: Flashes when *Bluetooth* notification is missed.
- “Delivery Report”: Flashes when a delivery report is missed.

Any Key Answer

For details, see page 28.

“Settings” → **“Phone Settings” tab** → **“Profiles”**

1. Highlight “Car”, “Silent” or “Original”.
2. Press [Edit].
3. Select “Any Key Answer”.
4. Select “On” or “Off”.

Answer Phone

For details, see page 107.

“Settings” → **“Phone Settings” tab** → **“Profiles”**

1. Highlight “Silent” or “Original”.
2. Press [Edit].
3. Select “Answer Phone”.
4. Select “On” or “Off”.

Setting the Display

You can change the display settings.

Setting the Wallpaper (M 9–2–1)

“Settings” → **“Phone Settings” tab** → **“Display Settings”**
→ **“Wallpaper”**

1. Select the folder in which the picture you wish to set is contained.
Pictures can be selected from “Preset Pictures”, “Picture Gallery”, “Flash®” or “Other Documents”.
2. Select the desired picture.
3. After displaying the picture, press ©.

Note

- *Some pictures cannot be used because of their picture and data types.*
- *Wallpaper can be linked to a theme. Select “Link to Theme” in step 2.*

Assigning Pictures (M 9–2–2)

To Set Built-in Pictures

“Settings” → **“Phone Settings” tab** → **“Display Settings”**
→ **“Assign Pictures”**

1. Select the desired function to set the picture to.
2. Select “Preset Animation” when you select “Power On” or select “Power Off” in step 1.
Select “Pattern 1”, “Pattern 2” or “Pattern 3” when you select “Incoming Voice Call” or “Alarm” in step 1.

To Set Saved Pictures

“Settings” → **“Phone Settings” tab** → **“Display Settings”**
→ **“Assign Pictures”**

1. Select the desired function to set the picture to.
2. Select “Picture Gallery”, “Flash®” or “Other Documents”.
3. Select the desired picture.
4. After displaying the picture, press Ⓞ.
5. Specify the area you wish to display using the navigation keys, then press Ⓞ.

Note

- *Some pictures cannot be used because of their picture and data types.*

Setting VeilView (M 9–2–3)

“Settings” → **“Phone Settings” tab** → **“Display Settings”**
→ **“VeilView”**

1. Select “Pattern Setting”.
Set the veilview pattern and the scale of the pattern.
If you select “animation” as the scale, the scale of pattern automatically changes continuously.
2. Select “Density Setting”.
Set the veilview density.

Setting the Font (M 9–2–4)

“Settings” → **“Phone Settings” tab** → **“Display Settings”**
→ **“Font Settings”**

To Set the Font Size

1. Select “Font Size”.
2. Select “Menu”, “Entering Text”, “Messaging”, or “Viewing the Web”.
3. Select the desired font size.

To Set the Font Weight

1. Select “Font Weight”.
2. Select “Thin”, “Normal” or “Bold”.

Setting the Standby Display (M 9–2–5)

You can set the standby screen display.

“Settings” → **“Phone Settings” tab** → **“Display Settings”**
→ **“Standby Display”**

1. Select “Clock/Calendar”, “Standby Window”, “Display Icons” or “Show Operator Name”.

Setting the Vivid Mode (M 9–2–6)

“Settings” → **“Phone Settings” tab** → **“Display Settings”**
→ **“Vivid Mode”**

1. Select the desired mode.

Setting the Greeting Message (M 9–2–7)

You can set the message which is displayed when the phone is turned on.

“Settings” → **“Phone Settings” tab** → **“Display Settings”**
→ **“Greeting Message”**

1. Select “Switch On/Off” and then select “On” or “Off”.

Setting the External Display (M 9–2–8)

To Select the Backlight Time Out

“Settings” → **“Phone Settings” tab** → **“Display Settings”**
→ **“External Display”** → **“Duration”**

1. Select the desired time out.
Select “Off” to shut the backlight off.

To Set the Message Incoming Information

“Settings” → **“Phone Settings” tab** → **“Display Settings”**
→ **“External Display”** → **“Messages”**

1. Select “Display” or “Not Display”.

To Set the Date & Time

“Settings” → **“Phone Settings” tab** → **“Display Settings”**
→ **“External Display”** → **“Display Date&Time”**

1. Select the desired display format for the date and time.

To Set the Clock Type

“Settings” → **“Phone Settings” tab** → **“Display Settings”**
→ **“External Display”** → **“Clock Type”**

1. Select the desired clock type.

To Set Incoming Indication

“Settings” → **“Phone Settings” tab** → **“Display Settings”**
→ **“External Display”** → **“Caller Display”**

1. Select “On” or “Off”.

Backlight (M 9–2–9)

You can specify a desired time to elapse before the backlight turns off, which will help conserve battery life.



To Select the Backlight Time Out

“Settings” → **“Phone Settings” tab** → **“Display Settings”**
→ **“Backlight”** → **“Time Out”**

1. Select the desired time.
Select “Off” to shut it off.
When selecting “Other”, enter the desired time.

To Adjust the Brightness of the Backlight

“Settings” → **“Phone Settings” tab** → **“Display Settings”**
→ **“Backlight”** → **“Brightness”**

1. Press  (Light) and  (Dark) to switch between 5 levels of clarity.
2. Press .

Note

- You can set the auto brightness adjustment function by selecting “Auto Sensor” in step 1.

To Adjust the Contrast of the Screen

“Settings” → **“Phone Settings” tab** → **“Display Settings”**
→ **“Backlight”** → **“Dynamic Control”**

1. Select “On” or “Off”.
When selecting “On”, the backlight brightness is automatically adjusted during full screen video playback.

Setting the Display Saving (M 9–2–10)

“Settings” → “Phone Settings” tab → “Display Settings”
→ “Display Saving”

1. Select the desired time.

When you purchase this phone, Display Saving is set to 2 minute.

Note

- To cancel the Display Saving: The display saving continues until either a key is pressed or there is an incoming alert. The first key press only cancels this function. You must press another key in order to perform other operations.

Setting the Dial Number (M 9–2–11)

“Settings” → “Phone Settings” tab → “Display Settings”
→ “Dial Number”

1. Select the desired type of dial number.

Themes (M 9–3)

“Settings” → “Phone Settings” tab → “Themes”







1. Select “Preset Themes” or “My Themes”.
2. Select the desired theme file.

Sound Settings (M 9–4)

“Settings” → “Phone Settings” tab → “Sound Settings”

Volume

“Settings” → “Phone Settings” tab → “Sound Settings”

1. Select “Volume”.
2. Select “For Incoming Call”, “For New Message”, “Java Start”, “Delivery Report” or “General Volume”.
3. Press  (or ) to increase the ringer volume or press  (or ) to decrease the ringer volume and then press . To select “Silent”, press  (or ) at level 1.

Assigning a Ringtone or a Ring Video Clip for an Incoming Call

“Settings” → “Phone Settings” tab → “Sound Settings”



1. Select “Ringtone/Ringvideos”.
2. Select “For Voice Call”.
3. Select “Preset Sounds”, “Sound Gallery”, “Video Gallery” or “Flash[®]”.
4. Highlight the ringtone or the ring video clip you wish to use. To hear the demo play, press [Play].
5. Press .

Note

- Melodies can be selected from “Sound Gallery”, “Preset Sounds” or “Flash[®]”.

Notification

“Settings” → “Phone Settings” tab → “Sound Settings”

1. Select “Ringtone/Ringvideos”.
2. Select “For New Message”, “Java Start” or “Delivery Report”.
3. Select “Assign Tone”.
4. Select the desired folder.
5. Highlight the desired ringtone or ring video clip.
6. Press .
7. Select “For New Message”, “Java Start” or “Delivery Report”.
8. Select “Duration”.
9. Enter the desired duration of message notification in 2 digits using the digit keys.
10. Press .

Keypad Tones

“Settings” → “Phone Settings” tab → “Sound Settings” → “System Sounds” → “Keypad Tones”

1. Select the desired tone pattern.

Warning Tone

“Settings” → “Phone Settings” tab → “Sound Settings” → “System Sounds” → “Warning Tone”

1. Select “Sound” or “Duration”.
For “Sound”, select “Preset Sounds”, “Sound Gallery” or “Off”.
For “Duration”, select the desired time.

Power On/Off Sound

“Settings” → “Phone Settings” tab → “Sound Settings” → “System Sounds”

1. Select “Power On Sound” or “Power Off Sound”.
2. Select “Sound” or “Duration”.
For “Sound”, select “Preset Sounds”, “Sound Gallery” or “Off”.
For “Duration”, enter the desired duration of sound in 2 digits using the digit keys.

Handset Open/Close Sound

“Settings” → **“Phone Settings” tab** → **“Sound Settings”** → **“System Sounds”**

1. Select “Handset Open” or “Handset Close”.
2. Select “Sound” or “Duration”.
For “Sound”, select “Preset Sounds”, “Sound Gallery” or “Off”.
For “Duration”, select the desired time.

Charge Full

“Settings” → **“Phone Settings” tab** → **“Sound Settings”** → **“System Sounds”** → **“Charge Full”**

1. Select “Sound” or “Duration”.
For “Sound”, select “Preset Sounds”, “Sound Gallery” or “Off”.
For “Duration”, select the desired time.

Vibration (M 9–4–4)

“Settings” → **“Phone Settings” tab** → **“Sound Settings”** → **“Vibration”**

1. Select “For Incoming Call”, “For New Message”, “Java Start” or “Delivery Report”.
2. Select “Switch On/Off” and then select “On” or “Link to Sound” to activate.
3. Select “Vibration Pattern” and then select the desired vibration pattern.

Event Light (M 9–4–5)

“Settings” → **“Phone Settings” tab** → **“Sound Settings”** → **“Event Light”**

1. Select “For Voice Call”, “For New Message”, “Java Start” or “Delivery Report”.
2. Select “Switch On/Off” and then select “On” or “Link to Sound” to activate.
3. Select “Light Colour” and then select the desired light colour.

Status Light (M 9–4–6)

“Settings” → **“Phone Settings” tab** → **“Sound Settings”** → **“Status Light”**

1. Select “For Missed Call”, “For New Message”, “For Answer Phone”, “Java Start” or “Delivery Report”.
2. Select “Switch On/Off” and then select “On” to activate.
3. Select “Light Colour” and then select the desired light colour.

Any Key Answer (M 9–4–7)

“Settings” → **“Phone Settings” tab** → **“Sound Settings”** → **“Any Key Answer”**

1. Select “On” or “Off”.

Surround (M 9–4–8)

“Settings” → **“Phone Settings” tab** → **“Sound Settings”** → **“Surround”**

1. Select “On” or “Off”.

Date & Time (M 9–5)

“Settings” → **“Phone Settings” tab** → **“Date & Time”**

1. Select “Set Date/Time”.
2. Enter the day, month, year and time using the digit keys.



To Set Daylight Saving (M 9–5–2)

“Settings” → **“Phone Settings” tab** → **“Date & Time”** → **“Daylight Saving”**

1. Select “On” or “Off”.



To Set the Time Zone

“Settings” → **“Phone Settings” tab** → **“Date & Time”** → **“Set Time Zone”**

1. Press  or  to select the home city to set.
2. Press .

To Customise the Time Zone

“Settings” → **“Phone Settings” tab** → **“Date & Time”** → **“Set Time Zone”**

1. Press [Custom].
2. Enter the city name.
3. Enter the time–zone differences using the digit keys.
Press  or  to switch between – and +.
4. Press .

World Clock (M 9–5–4)

For details, see page 87.

To Select the Time Format (M 9–5–5)

“Settings” → **“Phone Settings” tab** → **“Date & Time”** → **“Time Format”**

1. Select “24 Hour” or “12 Hour”.

To Select the Date Format (M 9–5–6)

“Settings” → **“Phone Settings” tab** → **“Date & Time”** → **“Date Format”**

1. Select from “D–M–Y”, “M–D–Y” or “Y–M–D”.

To Select the Calendar Format (M 9–5–7)

“Settings” → **“Phone Settings” tab** → **“Date & Time”** → **“Calendar Format”**

1. Select “Sunday–Saturday” or “Monday–Sunday”.

Language Setting (M 9–6)

“Settings” → **“Phone Settings” tab** → **“Language”**

1. Select the desired language.

Note

- If you select “Automatic” in step 1, the language preset on the SIM card is selected.
- If the language preset on the SIM card is not supported, then the default language of the phone is selected.

Motion Control Settings (M 9–7)

“Settings” → **“Phone Settings” tab** → **“Motion Control”**

To Set Display Change

You can set whether the screen automatically changes direction to the portrait or landscape position according to the direction of the phone when Document Viewer or the WAP/Web browser is activated.

1. Select “Display Change”.
2. Select “Browser” or “Document Viewer”.
3. Select “On” or “Off”.

To Set the Action (M 9–7–2)

1. Select “Action Settings”.

2. Select the desired settings.

- “Quick Silent”:
Enables switching to Quick Silent mode when the phone is turned over.
- “Music”:
Enables selecting a sound file by shaking the phone sideways.
- “Messaging”:
Enables changing the size of the text by shaking the phone forward or backward.
- “Browser”:
Enables zooming in or zooming out by shaking the phone forward or backward.
- “Document Viewer”:
Enables switching the page by shaking the phone sideways. Enables zooming in or zooming out by shaking the phone forward or backward.
- “Image Viewer”:
Enables switching the image displayed by shaking the phone sideways. Enables zooming in or zooming out by shaking the phone forward or backward.

3. Select “On” or “Off”.

Setting the Sound Output (M 9–8)

“Settings” → **“Phone Settings” tab** → **“Switch Ringtone Output”**

1. Select “Earphone Only” or “Earphone + Speaker”.

Change Menu (M 9–10)

“Settings” → **“Phone Settings” tab** → **“Change Menu”**

1. Select “Standard Menu” or “Large Font Menu”.

Security Settings (M 9–11)

“Settings” → **“Phone Settings” tab** → **“Security Settings”**

Enabling/Disabling the PIN Code

If the PIN code is enabled, you are asked to enter the PIN code each time the phone is switched on. Your PIN code is registered on the SIM card and you should have been made aware of the code when you purchased the SIM card. Contact your service provider for further details.

Select “On” for “PIN Entry” and enter your PIN code if you wish to activate the PIN lock.

Note

- *If you enter the wrong PIN code three times, the SIM card will lock. To remove the lock, contact your service provider or SIM card vendor.*

To Change the PIN Code

This allows you to change the PIN code registered on the SIM card. Before you change the PIN code, select “On” for “PIN Entry”.

Enter the existing PIN code for “Change PIN” after selecting “PIN Entry”, and enter a new PIN code twice.

To Change the PIN2 Code

PIN2 is a second PIN code used to unlock certain features of a SIM card, such as Fixed Dialling and Call Cost metering. Not all SIM cards use the PIN2 code. This menu may not be displayed depending on the type of your SIM card.

Enter the existing PIN2 code for “Change PIN2”, and enter a new PIN2 code twice.

Handset Lock

The Handset Lock prevents unauthorised use of the phone or certain features on the phone when the power is turned on.

Select “On” for “Handset Lock” if you wish to activate the Handset Lock.

Function Lock

By setting this option on, all the functions of your phone will be locked until the correct handset code is entered.

Enter your handset code for “Function Lock” if you wish to activate the Function Lock.

To Turn Off the Function Lock

Enter your handset code in standby to turn the Function Lock off.

Phonebook Lock

The Phonebook Lock function prevents unauthorised use of your Phonebook.

Select “On” to lock or “Off” to unlock for “Phonebook Lock” and enter your handset code.

The default handset code is “9999”. For details on changing the handset code, see “Change Handset Code” on page 106.

History Lock

The History Lock function prevents unauthorised access to Call Log. By setting this option on, Call Log cannot be viewed until the correct handset code is entered.

Press [Check] to lock or [Uncheck] to unlock.

Showing Secret Data

By setting this option on, the hidden data can be displayed.

Select “On” to display or “Off” to hide for “Show Secret Data”. Enter your handset code when you select “On”.

The default handset code is “9999”. For details on changing the handset code, see “Change Handset Code”.

Note

- *The hidden data can be displayed temporarily by shaking the phone. For details, see “Showing Secret Data Temporarily” on page 26.*

Change Handset Code

The default handset code is “9999”.

Select “Change Handset Code” and enter the old handset code, then enter a new handset code twice.

Master Reset

“Settings” → “Phone Settings” tab → “Master Reset” → “Reset Settings”

1. Enter your handset code.

The default handset code is “9999”. For details on changing the handset code, see “Change Handset Code”.

Note

- *Some settings are not deleted by this function. Data stored in Phonebook, etc. is not deleted.*

To Reset All Settings for M1 to M12 and Delete All Created Data (M 9–12–2)

“Settings” → **“Phone Settings” tab** → **“Master Reset”** → **“Reset All”**

1. Enter your handset code.

The default handset code is “9999”. For details on changing the handset code, see “Change Handset Code”.

Call Settings

Answer Phone (M 9––1)

When you cannot answer a call, you can record the caller's message on your phone. After the answering message is played back, the caller can record a message. You can also use this function to record the caller's voice during a call.

“Settings” → **“Call Settings” tab** → **“Answer Phone”**

1. Select “Switch On/Off”.

2. Select “On” to enable this function.

3. Select one of the following options, if necessary.

“Answer Time”: Sets the time before the answering message is played back when this function is enabled.

“Guidance Message”: The contents of the answering message can be checked.

“Volume”: Sets whether or not to play the caller's message while it is being recorded.

Note

- *The Answer Phone function is not available when the power is turned off or when the phone is outside the service area.*
- *Press  while receiving an incoming call to put the call on hold.*

Tip

- Long press  in standby to enable or disable the Answer Phone function.
- During a call, press [Options] and select “Record” to record the caller’s voice.
- You can enable Answer Phone for the profiles “Silent” and “Original”.
- Answer Phone is always enabled for the “Car” profile.

Voicemail & Diverts (M 9--2)

This service can be used to divert incoming calls that you cannot answer. Calls can be diverted to another phone number or to your Voicemail system.

Note

- This service may not be available on all mobile phone networks. Contact your service provider for more information.

To Access the Voicemail Centre

1. Long press  in standby.

To Activate the Voicemail Service

“Settings” → **“Call Settings” tab** → **“Voicemail & Diverts”**
→ **“Voicemail”** → **“Activate”**

1. Select one of the following options:

- “Always”: Diverts all calls without ringing.
- “When Busy”: Diverts incoming calls while you are talking on the phone.
- “No Answer”: Diverts incoming calls if you do not answer a call within a certain period of time.
- “Not Reachable”: Diverts incoming calls when your phone has no network service or is switched off.

If you select “No Answer”, select the period of time from 6 levels (05 to 30 seconds).

2. Press .

To Activate the Diverts Service

Select the appropriate option.

“Settings” → **“Call Settings” tab** → **“Voicemail & Diverts”**
→ **“Diverts”**

1. Select the desired item.
2. Select from “Always”, “When Busy”, “No Answer” or “Not Reachable”.
3. Enter a phone number to which you wish to divert calls or search for it in the Phonebook (p. 37).
If you select “No Answer” in step 2, select the period of time from 6 levels (05 to 30 seconds).
4. Press .

Note

- When “Voice Calls” diverts are set to “Always”, “” is displayed in standby.

To Deactivate the Diverts Service

Select the appropriate option.

“Settings” → **“Call Settings” tab** → **“Voicemail & Diverts”**
→ **“Deactivate”**

1. Select from “Always”, “When Busy”, “No Answer” or “Not Reachable”.
2. Press .

To Cancel the Diverts and Voicemail Service

“Settings” → **“Call Settings” tab** → **“Voicemail & Diverts”**
→ **“Cancel All”**

To Check the Diverts Status

“Settings” → **“Call Settings” tab** → **“Voicemail & Diverts”**
→ **“Status”**

1. Select the diverts option you wish to check.

Showing Your Number (M 9--3)

“Settings” → **“Call Settings” tab** → **“Show Your Number”**

1. Select “On”, “Off” or “Status”.

Note

- Some networks do not support this service. Please check with your service provider for availability.

Restrict Calls (M 9--4)

To activate this option you will need the specified password, which is available from your service provider.

“Settings” → **“Call Settings” tab** → **“Restrict Calls”**

1. Select “Outgoing Calls” or “Incoming Calls”.
“Outgoing Calls”: Restricts outgoing calls.
“Incoming Calls”: Restricts incoming calls.

2. Select one of the following options:

(For “Outgoing Calls”)

“Bar All Outgoing Calls”: Restricts all outgoing calls except emergency calls.

“Bar International Calls”: Restricts all outgoing international calls.

“Only Local & Home”: Restricts all outgoing international calls except to your home country.

(For “Incoming Calls”)

“Bar All Incoming Calls”: Restricts all incoming calls.

“Bar if Abroad”: Restricts all incoming calls when you are outside of the coverage from your registered service provider.

3. Select one of the following options:

“All Services”: Restricts all services.

“Voice Calls”: Restricts all voice calls.

“Messages”: Restricts all messages.

4. Select “On”, “Off” or “Status”.

5. Enter the network password.

To Cancel Settings

“Settings” → “Call Settings” tab → “Restrict Calls”

1. Select “Outgoing Calls” or “Incoming Calls”.
2. Select “Cancel All”.
3. Enter the network password.

Fixed Dialling Numbers

This option is available on most SIM cards for mobile phones. It allows you to configure a SIM card so that it can only be used to make calls to numbers on a predefined list.

Note

- *This service depends on the SIM card.*

To Enable Fixed Dialling Numbers

“Settings” → “Call Settings” tab → “Restrict Calls” → “FDN”

1. Select “Switch On/Off”.
2. Select “On” to enable this function.
3. Enter your PIN2 code.

To Add a New Name

“Settings” → “Call Settings” tab → “Restrict Calls” → “FDN”

1. Select “Edit Dial List”.
2. Select a blank field.
3. Enter your PIN2 code.

4. Add a name and a phone number.

For details on adding a name and phone number, see “Adding a New Entry” on page 37.

5. Press [Save].

Rejecting an Incoming Call

To Reject the Registered Number

“Settings” → **“Call Settings” tab** → **“Restrict Calls”** → **“Rejected Numbers”** → **“Switch On/Off”**

1. Select “On” or “Off”.

To Register the Rejected Number

“Settings” → **“Call Settings” tab** → **“Restrict Calls”** → **“Rejected Numbers”** → **“Set Rejecting Number”**

1. Select a blank field.
2. Enter the desired number.

Rejecting a Call when the Caller’s Number is Withheld

“Settings” → **“Call Settings” tab** → **“Restrict Calls”** → **“Withheld Call”**

1. Select “On” or “Off”.

Changing the Network Password

“Settings” → **“Call Settings” tab** → **“Restrict Calls”** → **“Change N/W Password”**

1. Enter the old network password.
2. Enter a new network password.
3. Enter the new network password again.
If you enter the incorrect password, you are asked to enter the password again.
4. Press .

Minute Minder (M 9--5)

“Settings” → **“Call Settings” tab** → **“Minute Minder”**

1. Select “On” or “Off”.

Auto Answer (M 9--6)

“Settings” → **“Call Settings” tab** → **“Auto Answer”**

1. Enter your handset code.
2. Select “Switch On/Off”.
3. Select “On” or “Off”.

To Set the Answer Time

“Settings” → **“Call Settings” tab** → **“Auto Answer”**

1. Enter your handset code.
2. Select “Answer Time”.
3. Enter the time from 1 to 30 seconds.

Call Waiting (M 9-▶-7)

Note

- *This service may not be available on all mobile phone networks.
Contact your service provider for more information.*

If you wish to be able to receive another incoming call while you have a call in progress, you must activate the Call Waiting service.

“Settings” → **“Call Settings” tab** → **“Call Waiting”**

1. Select “On”, “Off” or “Status”.

Display Call Timer (M 9-▶-8)

“Settings” → **“Call Settings” tab** → **“Display Call Timer”**

1. Select “On” or “Off”.

Display Call Cost (M 9-▶-9)

“Settings” → **“Call Settings” tab** → **“Display Call Cost”**

1. Select “On” or “Off”.

Auto Redial (M 9-▶-10)

“Settings” → **“Call Settings” tab** → **“Auto Redial”**

1. Select “On” or “Off”.

Network Settings

Network Settings (M 9-▶-▶-1)

To Select a Network Automatically

“Settings” → “Network Settings” tab → “Network Settings” → “Select Network” → “Automatic”

To Select the Network Manually

“Settings” → “Network Settings” tab → “Network Settings” → “Select Network” → “Manual”

1. Select the desired network.

To Set Preferred Network

“Settings” → “Network Settings” tab → “Network Settings” → “Select Network” → “Set Preferred”

1. Select the preferred network.

Note

- This service depends on the SIM card.

To Add a New Network

“Settings” → “Network Settings” tab → “Network Settings” → “Select Network” → “Add New Network”

If there are no entries, press  and go to step 2.

If there is an entry, press  and perform the following steps.

1. Select “Add”.
2. Enter the country code (up to 3 digits).
3. Enter the network code (up to 3 digits).
4. Enter a new network name (up to 25 characters).

Showing the Network Information (M 9-▶-▶-1-2)

“Settings” → “Network Settings” tab → “Network Settings” → “Network Information”

Information about the operator is displayed.

Off Line Mode (M 9-▶-▶-2)

“Settings” → “Network Settings” tab → “Off Line Mode”

1. Select “On” or “Off”.

Internet Settings (M 9-▶-▶-3)

Note

- In normal operations, you do not need to change the settings.
- Internet settings have already been entered in your phone depending on your service provider. You may have restrictions on viewing, deleting, copying or modifying the settings. Contact your service provider for details.

Browser Settings (M 9---3-1)

“Settings” → **“Network Settings” tab** → **“Internet Settings”** → **“Browser Settings”** → **“Create New”**

“Profile Name”: Browser profile name (unique name)

“Proxy”: Proxy setting for Browser

(When “Use Proxy” is set to “Off”, settings for “Home” and “Access Point” can be made in place of “Proxy”.)

“Use Proxy”: Setting to connect by Proxy or not

Java™ Settings (M 9---3-2)

“Settings” → **“Network Settings” tab** → **“Internet Settings”** → **“Java™ Settings”** → **“Create New”**

“Profile Name”: Profile name for Java™ application (unique name)

“Proxy”: Proxy setting for Java™ application

(When “Use Proxy” is set to “Off”, settings for “Access Point” can be made in place of “Proxy”.)

“Use Proxy”: Setting to connect by Proxy or not

Streaming Settings (M 9---3-3)

“Settings” → **“Network Settings” tab** → **“Internet Settings”** → **“Streaming Settings”** → **“Create New”**

“Profile Name”: Profile name for streaming (unique name)

“Proxy Address”: Proxy address

“Proxy Port Number”: Port number (1-65535)

“Access Point”: Access point

Proxy Settings (M 9---3-4)

“Settings” → **“Network Settings” tab** → **“Internet Settings”** → **“Proxy Settings”** → **“Create New”**

“Proxy Name”: Proxy name (unique name)

“Proxy Address”: IP address

“Access Point”: Access point

“Home”: Home page URL

“Port Number”: Port number (1-65535)

“Authentication Type”: Authentication type (“HTTP-BASIC” or “HTTP-DIGEST”)

“User Name”: User name for authentication

“Password”: Password for authentication

Access Point Settings (M 9---3-5)

“Settings” → **“Network Settings” tab** → **“Internet Settings”** → **“Access Point Settings”** → **“Create New”**

“Access Point Name”: Access point name (unique name)

“Bearer Type”: Sets the connection type (“GPRS”, “CSD”)

“APN”/“Dialup Number”:
APN setting/CSD connection number setting

“Authentication Type”: Authentication type (“NONE”, “PAP” or “CHAP”)

“User Name”: User name for access point

“Password”: Password for access point

“DNS”: DNS (Domain Name System)

“Linger Time”: Linger Time (1-99999 sec.)

“Data Call Type”: Analog or ISDN

“Data Speed”: 9.6kbits, 14.4kbits

Clearing DNS Cache (M 9---3-6)

“Settings” → **“Network Settings” tab** → **“Internet Settings”** → **“Clear DNS Cache”**

To Activate the Browser/Java™/Streaming Profile

“Settings” → **“Network Settings” tab** → **“Internet Settings”**

1. Select “Browser Settings”, “Java™ Settings” or “Streaming Settings”.
2. Select the desired profile you wish to activate.

To Edit/View/Copy/Delete the Browser/Java™/Streaming/Proxy/Access Point Profile

“Settings” → **“Network Settings” tab** → **“Internet Settings”**

1. Select “Browser Settings”, “Java™ Settings”, “Streaming Settings”, “Proxy Settings” or “Access Point Settings”.
2. Highlight the desired profile.
3. Press [Options] and select the desired option.

“Edit”: Modify the desired item.

“View”: Confirm the data.

“Copy”: Enter the new file name.

“Delete”: Select “Yes” to delete.

Call Log (M 11)



The phone will record the last 30 missed calls, received calls and dialled numbers.

Viewing Call Log

“Call Log”

1. Select from “All Calls”, “Dialled Numbers”, “Missed Calls” or “Received Calls”.

The selected call log list is displayed.

To switch logs, press  or .

2. Select the phone number you wish to view.

If you wish to dial the number, press  to make a voice call.

Sending Messages

1. In the call log list, highlight the phone number or name you wish to send a message to.

2. Press [Options] and select “Create Message”.

For details on creating a message, see “Creating a New Message” on page 57.

Deleting a Call Log

1. In the call log list, press [Options] and select “Delete” or “Delete All”.

Call Timers (M 11–5)

Checking the Duration of the Last Call and All Calls

“Call Log” → “Call Timers”

1. Select “Dialled Calls” or “Received Calls”.

Resetting Call Timers (M 11–5–3)

“Call Log” → “Call Timers” → “Clear Timers”

1. Enter your handset code.

The default handset code is “9999”. For details on changing the handset code, see “Change Handset Code” on page 106.

Call Costs (M 11–6)

Some networks do not support Charging Advice. Please check with your service provider for availability.

Checking the Cost of the Last Call

“Call Log” → “Call Costs” → “Last Call”

Checking the Total Call Cost

“Call Log” → “Call Costs” → “All Calls”

Setting the Charge Rate

“Call Log” → “Call Costs” → “Cost Units” → “Set Units” → “Press [Select]”

1. Enter your PIN2 code.
2. Enter a currency unit (up to 3 characters).
3. Enter a cost per unit.

To enter a decimal point, press .

Setting the Charge Limit

“Call Log” → “Call Costs” → “Max Cost” → “Set Limit” → “Press [Select]”

1. Enter your PIN2 code.
2. Enter a value.

Data Counter (M 11–7)

“Call Log” → “Data Counter”

1. Select “Last Data” or “All Data”.

Resetting All Data Counter (M 11–7–3)

“Call Log” → “Data Counter” → “Clear Counter”

Connectivity (M 12)

Bluetooth (M 12–1)

Keep your phone within a distance of 10 metres from the other *Bluetooth* wireless technology enabled device before searching.

Using the Bluetooth Wireless Function

To Turn On or Off the Bluetooth Wireless Function (M 12–1–1)

“Connectivity” → “Bluetooth” → “Switch On/Off”

1. Select “On” or “Off”.

When “On” is selected, the *Bluetooth* wireless setting is activated, and “” is displayed.

To Search for Devices to be Paired (M 12–1–2)

A maximum of 16 devices can be searched for.

“Connectivity” → “Bluetooth” → “Search for Devices”

1. Select the desired device for pairing.
2. Enter the device passcode.

Note

- You can search for devices even when the *Bluetooth* wireless function is off. Once pairing is started, the phone turns the *Bluetooth* wireless function on automatically.
- You can only select one device for pairing. To change the paired device, see “To Activate the Paired Device”.
- Pairing means authentication has been established between the two devices.

- In order to pair two devices with *Bluetooth* wireless technology, the users should agree on the same passcode for both devices.
- The passcode is used only once, so there is no need to remember it. The passcode can be different each time the devices are connected.
- Devices that do not have a user interface (i.e., headsets and car kits) have a factory–set passcode. See the user guide for the device.

To Activate the Paired Device

“Connectivity” → “Bluetooth” → “Paired Devices”

1. Select the desired device you wish to activate.

To Connect the Only Desired Service

“Connectivity” → “Bluetooth” → “Paired Devices”

1. Highlight the desired device.
2. Press [Options] and select “Select service”.
3. Select “Handsfree function” or “Audio function”.

To Give Priority to the Handsfree Device and/or the Audio Device

“Connectivity” → “Bluetooth” → “Paired Devices”

1. Highlight the desired device.
2. Press [Options] and select “Set to Prior Connect”.
3. Select “Handsfree On” or “Audio On”.

To Rename or Delete the Paired Devices

“Connectivity” → “Bluetooth” → “Paired Devices”

1. Highlight the desired device.
2. Press [Options].
3. Select “Change Name” or “Delete”.
You can rename or delete by pressing  after selecting desired device.

To Send All Data to Other Devices (M 12–1–4)

“Connectivity” → “Bluetooth” → “Send All”

1. Select the desired device.
If a device is not specified, searching starts automatically.
2. Enter your handset code.
The default handset code is “9999”. For details on changing the handset code, see “Change Handset Code” on page 106.
3. Select the desired data to send.
4. Enter the device passcode for unpaired devices.

Note

- If the handsfree device is connected, the confirmation screen to deactivate the handsfree function is displayed. Select “Yes” to deactivate.

Bluetooth Wireless Settings (M 12–1–5)

To Rename Your Phone

“Connectivity” → “Bluetooth” → “Bluetooth Settings” → “Device Name”

1. Enter the new device name.

To Show or Hide Your Phone

“Connectivity” → “Bluetooth” → “Bluetooth Settings” → “Visibility”

1. Select the desired visibility settings.
“Show My Phone”: Allows other devices to recognise your phone.
“Hide My Phone”: Hides your phone from other devices.

To Select the Sound Output

“Connectivity” → “Bluetooth” → “Bluetooth Settings” → “Sound Output”

1. Select “Phone/Earphone” or “Bluetooth Device”.

To Switch the Handsfree Settings

“Connectivity” → “Bluetooth” → “Bluetooth Settings” → “Handsfree Setting”

1. Select “Handsfree Mode” or “Private Mode”.
“Handsfree Mode”: For talking always with the handsfree kit
“Private Mode”: For talking with the device used to receive or make a call

To Set Java™ Application Request

“Connectivity” → “Bluetooth” → “Bluetooth Settings” → “Java™ Application Request”

1. Select “On” or “Off”.

To Turn Off Automatically

“Connectivity” → “Bluetooth” → “Bluetooth Settings” → “Bluetooth Timeout”

1. Select the desired time.

Your phone turns the function off automatically after the specified time.

To See Your Phone Details

“Connectivity” → “Bluetooth” → “My Phone Details”

Infrared (M 12–2)

Keep your phone within a distance of 20 centimetres from the other infrared enabled device before searching. The infrared setting will return to off when no data is transmitted/received via infrared communication.

Infrared communication is only available when the phone is open.

Turning On or Off

“Connectivity” → “Infrared” → “Switch On/Off”

1. Select “On (3 min)” or “Off”.

The infrared setting is activated, and “☎” is displayed.

Sending All Data

“Connectivity” → “Infrared” → “Send All”

1. Enter your handset code.
The default handset code is “9999”. For details on changing the handset code, see “Change Handset Code” on page 106.
2. Select the desired data to send.
3. Enter the authorisation code.

Mass Storage (M 12–3)

“Connectivity” → “Mass Storage”

1. Select “Yes”.

Note

- *Activating Mass Storage mode also activates offline mode.*
- *Mass Storage is not available when the battery is low, a Java™ application is paused, music player is active, or a memory card is not inserted in your phone.*

USB Charge (M 12–4)

“Connectivity” → “USB Charge”

1. Select “Enable” or “Disable”.

Note

- *The battery can be charged with the AC charger regardless of this setting.*

Card Settings (M 12–5)

Formatting Memory Card (M 12–5–2)

“Connectivity” → **“Card Settings”** → **“Format Card”**

1. Enter your handset code.
The default handset code is “9999”. For details on changing the handset code, see “Change Handset Code” on page 106.
2. Select “Yes” to start formatting.

Making a Backup File

With a memory card inserted in your phone, you can back up data in Messages (Inbox, Drafts, Sent Messages), Call Manager, Message Groups, Calendar, Tasks, Notepad, and Bookmarks in the handset memory to the memory card. You can also restore the backup data from the memory card.

“Connectivity” → **“Card Settings”** → **“Backup/Restore”** → **“Backup”**

1. Enter your handset code.
The default handset code is “9999”. For details on changing the handset code, see “Change Handset Code” on page 106.
2. Check off the desired items to back up and press [Execute].
To back up all files, press [Options] and select “Check All” to check off all items. Then press [Execute].
3. Select “Yes” to start backup.

Restoring a Backup File

“Connectivity” → **“Card Settings”** → **“Backup/Restore”** → **“Restore”**

1. Enter your handset code.
The default handset code is “9999”. For details on changing the handset code, see “Change Handset Code” on page 106.
2. Check off the desired items to restore and press [OK].
To restore all files, press [Options] and select “Check All” to check off all items. Then press [OK].
3. Select the desired file to restore and press [OK].
A confirmation message indicating deletion from the handset memory is displayed.
4. Select “Yes” to start restoring.

Deleting a Backup File

“Connectivity” → **“Card Settings”** → **“Backup/Restore”** → **“File Management”**

1. Select the desired folder.
2. Check off the desired files to delete and press [Delete].
To delete all backup files, press [Options] and select “Check All” to check off all files. Then press [Delete].
3. Select “Yes” to start deleting.

Connecting SH1810C to Your PC

You can use the following functions by connecting the SH1810C to your PC using a USB data cable or via *Bluetooth* wireless technology:

- GSM/GPRS modem
- Handset Manager for SH1810C
- Music Manager for SH1810C
- Sync Manager for SH1810C

Note

- *Operation with software not provided by Sharp is not guaranteed.*

System Requirements

Operating System:

Windows 2000*, Windows XP**, Windows Vista

- * Service Pack 4 or later
- ** Service Pack 2 or later

Supported Software:

Microsoft Outlook/Outlook Express

Interface:

USB port or *Bluetooth* wireless port

CD-ROM drive

To use Music Manager, DirectX9 and Windows Media Player 9 or later are required.

GSM/GPRS Modem

You can use SH1810C as a GSM/GPRS modem to access the Internet from your PC. Connect your phone to your PC via *Bluetooth* wireless technology or USB interface. Software installation on your PC is required.

Modem via the USB Data Cable

- 1. Insert the CD-ROM into your PC's CD-ROM drive.**

The SH1810C CD-ROM screen is displayed.

If the SH1810C CD-ROM screen is not displayed, double-click [Launcher.exe] in your CD-ROM.

- 2. Select the USB driver from the on-screen instructions of your CD-ROM, and start installation of USB driver software following the on-screen instructions of your CD-ROM.**
 - During installation, the on-screen instructions ask you to connect your phone to your PC. Power on your phone and attach the phone to the USB port of your PC using the USB data cable.
- 3. Follow the on-screen instructions to complete installation.**
- 4. Select the modem driver from the on-screen instructions of your CD-ROM, and install modem driver software following the on-screen instructions of your CD-ROM.**
- 5. Follow the on-screen instructions to use your phone as a modem driver.**
 - When the on-screen instructions ask for the modem driver type, select the cable as a modem driver.

Modem via Bluetooth Connection

1. Turn on the *Bluetooth* wireless function of your phone.
For details, see “To Turn On or Off the Bluetooth Wireless Function” on page 118.
2. Pair your PC with your phone.
For details on pairing your PC with your phone, see “To Search for Devices to be Paired” on page 118.
3. Insert the CD-ROM into your PC’s CD-ROM drive.
The SH1810C CD-ROM screen is displayed.
If the SH1810C CD-ROM screen is not displayed, double-click [Launcher.exe] in your CD-ROM.
4. Select the modem driver from the on-screen instructions of your CD-ROM, and install modem driver software following the on-screen instructions of your CD-ROM.
5. Follow the on-screen instructions to use your phone as a modem driver.
 - When the on-screen instructions ask for the modem driver type, select *Bluetooth* as a modem driver.

Note

- *Modem communication is not possible while communicating with the Handset Manager via Bluetooth wireless technology or USB interface.*
- *It is not recommended that you make or answer calls when you are using SH1810C as a GSM/GPRS modem. The operation may be interrupted.*

- *Your phone exhausts the battery when connected to a PC, even when not communicating.*
- *For a detailed explanation on how to use the Modem driver, please click and refer to the help on the Modem Driver.*

Handset Manager

You can transmit the following items between your phone and your PC, and can use Phonebook entries on your PC:

- Gallery files (pictures/sounds/video clips/themes/Flash® data/ Other Documents data)
- Phonebook entries
- Schedule entries

Via USB Data Cable

1. Insert the CD-ROM into your PC’s CD-ROM drive.
The SH1810C CD-ROM screen is displayed.
If the SH1810C CD-ROM screen is not displayed, double-click [Launcher.exe] in your CD-ROM.
2. Select Handset Manager from the on-screen instructions of your CD-ROM, and start installation of Handset Manager software following the on-screen instructions of your CD-ROM.
 - If you have not installed the USB driver, follow steps 2 and 3 on page 122.

3. Follow the on–screen instructions to complete installation.
 - During installation, the on–screen instructions ask you to select an interface. Select the USB data cable as an interface.
4. Connect your phone to your PC. Power on your phone and attach the phone to the USB port of your PC using the USB data cable.
5. Launch Handset Manager from the relevant folder.
6. Enter your handset code.
7. Follow the on–screen instructions of Handset Manager.

Via Bluetooth

1. Insert the CD–ROM into your PC’s CD–ROM drive.

The SH1810C CD–ROM screen is displayed.
If the SH1810C CD–ROM screen is not displayed, double-click [Launcher.exe] in your CD–ROM.
2. Select Handset Manager from the on–screen instructions of your CD–ROM, and start installation of Handset Manager software following the on–screen instructions of your CD–ROM.
3. Follow the on–screen instructions to complete installation.
 - During installation, the on–screen instructions ask you to select an interface. Select *Bluetooth* as an interface.

4. Launch Handset Manager from the relevant folder.
5. Enter your handset code.
6. Follow the on–screen instructions of Handset Manager.

Note

- *Some large files may not be able to be transmitted from the PC to the phone.*
- *Applications (Camera, Gallery, etc.) cannot be run when the phone is connected to the PC via Bluetooth wireless technology interface or USB data cable.*
- *If you have already installed Sharp Handset Manager, you need to uninstall the previous one.*
- *If you have trouble with installation, uninstall Handset Manager, restart your PC, reinstall Handset Manager and restart.*
- *For details, see the User Guide Software which is installed within Handset Manager or our web–site, <http://www.sharp–mobile.com>.*

Music Manager

You can manage the playlist and exchange sound files on your PC. Available files are the sound files in the following formats: MP3, AAC, 3GPP.

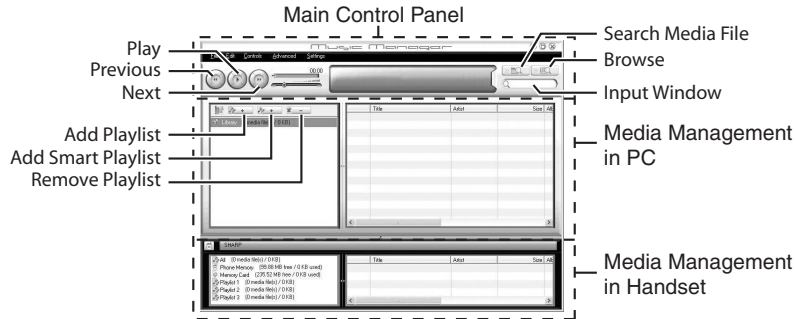

Main Control Panel

Control all the main actions from here.

- Play: Plays back a file.
- Previous: Returns to the top portion of the current file.
- Next: Jumps to the next file.
- Search Media File: Searches a media file.
- Browse: Browses all the media files sorted in Genre/Artist/Album.
- Input Window: Quickly finds the media files in Library or the playlist with keyword entry.

Media Management in PC

Media files in PC can be easily explored in 2 main columns.

- Add Playlist: Creates a new playlist.
- Add Smart Playlist: Creates a new smart playlist.
- Remove Playlist: Removes a playlist.

Media Management in Handset

Media files in Handset can be easily explored in 2 main columns.

- With the drag and drop operation, you can upload the sound files and the playlists from your PC, and also download them to your PC.
- You can create a new playlist and delete an existing playlist.
- With the drag and drop operation, you can add a sound file to a playlist, and delete them from the playlist.
- You can edit the name of a playlist of your PC.
- You can edit the title, artist name, and album name of sound files of your PC (only available in MP3 format).

Sync Manager

You can synchronise the following data with the data of Microsoft Outlook or Outlook Express on your PC.

- Phonebook entries.
- Schedule entries.

Specifications

Memory Card Structure and Contents

Memory Card Structure			Location for Saved Data/Data Used on the Phone	
PRIVATE	SH_ITEMS	My Items	Bookmarks	Backup data for "Bookmarks" in "Browser"(*1)
			Flash®	Data displayed in "Flash®" in "Gallery"
			Other Documents	Files displayed in "Other Documents" in "Gallery"
			Pictures	Images displayed in "Picture Gallery" in "Gallery"
			Sounds & Ringtones	Sound files played back in "Sound Gallery" in "Gallery"
			Themes	Files set in "Themes" in "Gallery"
			Videos	Videos played back in "Video Gallery" in "Gallery"
		SH_Folder	Application management information, etc.(*1)	
		Utility	Saved backup files, etc.(*1)	

Note

- Depending on the size and type of data, playback/viewing may not be available.
- Java™ data cannot be saved on a memory card.
- Do not save data to folders in the memory card other than those listed above.
- When a memory card is inserted into the phone, "Temp Card Folder" is additionally displayed below "Other Documents" in "Gallery". In "Temp Card Folder", the data saved in the root directory in the memory card is displayed.

(*1) These are dedicated folders for backup data.

Safety Precautions and Conditions of Use

Your phone conforms to international regulations insofar as it is used under normal conditions and in accordance with the following instructions.

Conditions of Use

Electromagnetic waves

- Do not switch on your phone aboard an aircraft (as your phone may interfere with the aircraft's electronic systems). Current legislation forbids this use and legal action can be taken against the user.
- Do not switch on your phone in a hospital, except in designated areas.
- Use of your phone's function may affect the performance of medical electronic units (pacemakers, hearing aids, insulin pumps, etc.). When the phone function is on, do not bring it near medical equipment or into areas in which medical equipment is being used. If you have a hearing aid or a pacemaker, only use the phone on the opposite side of your body from where it is located. The phone should be kept at least 6 inches (15.24 cm) from a pacemaker ANYTIME the phone is switched on.
- Do not switch on your phone near gas or flammable substances.

- Observe the rules concerning the use of mobile phones at gasoline stations, chemical plants and at all sites where a risk of explosion exists.

Caring for your phone

- Do not allow children to use your phone without supervision.
- Do not open or attempt to repair your phone yourself. The product can only be repaired by authorised service personnel.
- Do not drop your phone or subject it to severe impacts. Bending the body and pushing the display or keys with extreme force could damage the phone.
- Do not use solvents to clean your phone. Use only a soft, dry cloth.
- Do not carry your phone in your back pocket as it could break when you sit down. The display is made of glass and is particularly fragile.
- Avoid touching the external connector on the underside of the phone, since the delicate components within can be damaged by static electricity.

Battery

- Use your phone only with batteries, chargers and accessories recommended by the manufacturer. The manufacturer disclaims any liability for damage caused by the use of other chargers, batteries or accessories.

- **Network configuration and phone usage will affect talk–time and standby time.**

Using the games or camera will hasten battery consumption.

- **When the battery charging alert is displayed on the screen, charge the battery as soon as possible.** If you continue using your phone ignoring the alert, the phone may cease to function, and all data and settings you have stored may be lost at any moment.
- Before removing the battery from the phone, make sure the phone is switched off.
- Replace and charge the new battery as soon as possible after removing the old one.
- Do not touch the battery terminals. Batteries can cause damage, injury or burns if a conductive material touches exposed terminals. When the battery is detached from the phone, use a cover made of non-conductive material for keeping and carrying the battery safely.
- Recommended temperature for using and storing batteries is approximately 20°C.
- The batteries' performance is limited in low temperatures, particularly below 0°C and the phone may not work temporarily regardless of the amount of remaining battery power.

- Exposing the phone to extreme temperatures will shorten battery life.
- The battery can be charged and discharged hundreds of times but it will eventually wear out. When the operating time (talk-time and standby time) is noticeably shorter than normal, it is time to buy a new battery.

CAUTION

RISK OF EXPLOSION IF BATTERY IS REPLACED BY AN INCORRECT TYPE, DISPOSE OF USED BATTERIES ACCORDING TO THE INSTRUCTIONS

See "Battery Disposal" on page 14.

Aerial Care

- Do not cover the hinge area of the phone (p. 13, No. 31) with your hand when in use as this may interfere with the performance of the built-in aerial. Call quality may deteriorate leading to shortened talk-time and standby time because the mobile phone has to operate on a higher power level than is necessary.
- Use only the aerial supplied or one approved by Sharp for your mobile phone. Using unauthorised or modified aerials may damage the mobile phone. Moreover, since the mobile phone may violate the appropriate regulations, it may lose performance or exceed the limitation of SAR levels.
- To avoid impaired performance, do not damage the aerial of the mobile phone.
- To avoid interfering with blasting operations, please turn off the mobile phone in a blasting area or in a place where a "turn off two-way radio" sign is posted.

Camera Operation

- Learn picture quality, file formats, etc. beforehand.
The taken pictures can be saved in JPEG format.
- Be careful not to move your hand while taking pictures.
If the phone moves while taking a picture, the picture can become blurred. When taking a picture, hold the phone firmly to prevent it from moving, or use the delay timer.
- Clean the lens cover before taking a picture.
Fingerprints, oils, etc. on the lens cover hinder clear focusing. Wipe them off with a soft cloth before taking a picture.
- If you use the camera continuously for too long, the temperature of the phone will increase and the phone may stop working.

Others

- As with any electronic storage unit, data may be lost or corrupted under various circumstances.
- Before connecting the phone with a PC or a peripheral unit, read the operation manual for the other unit carefully.
- If the phone's battery has been removed for some time, or the phone has been reset, the unit's clock and calendar may be reinitialised. The date and time should be updated in this case.
- The phone uses a magnet to recognise that the phone is closed. Do not place magnetic cards near your phone or get the card caught in the phone as it may damage the recorded data.

Environment

- Keep your phone away from extreme heat. Do not leave it on the dashboard of a car or near a heater. Do not leave it in any place that is extremely damp or dusty.
- Since this product is not waterproof, do not use it or store it where fluids such as water can splash onto it. Raindrops, water spray, juice, coffee, steam, perspiration, etc. will also cause malfunctions.

Precautions Concerning Vehicle Use

- It is the user's responsibility to check the local laws governing the use of a mobile phone in vehicles. Pay full attention to driving. Pull off to the side of the road, park the car, and switch off the engine before making or answering a call.
- Use of your phone's function may interfere with the vehicle's electronic systems, such as the ABS anti-lock brakes or the air-bag. To ensure no such problem occurs, please check with your dealer or car manufacturer before connecting your phone.
- Only allow qualified service maintenance personnel to install the vehicle accessories.

The manufacturer disclaims any liability for damage which may result as a consequence of improper use or use contrary to the instructions contained herein.

製品中の有毒有害物質又は元素の名称及び含有量

部品名称		有毒有害物質或元素					
		鉛 (Pb)	水銀 (Hg)	カドミウム (Cd)	六価クロム (Cr(VI))	PBB	PBDE
製品本体	プリント配線基板 (FPC含む)	×	○	○	○	○	○
	キャビネット	○	○	○	○	○	○
	機構部品	○	○	○	○	○	○
	回路部品	×	○	×	○	○	○
同梱物、 オプション	Li-ion電池	×	○	○	○	○	○
	ACチャージャー	×	○	○	○	○	○
	USBケーブル	×	○	○	○	○	○
	Stereo Handsfree	×	○	○	○	○	○

○：当該部材のすべての均質材料中における当該有毒有害物質の含有量がいずれもSJ/T 11363-2006 標準に規定する限量の要求以下であることを表す。

×：少なくとも当該部材のある均質材料中における当該有毒有害物質の含有量がSJ/T 11363-2006 標準に規定する限量の要求を上回ることを表す。

環境保護使用期限：



このマークにある年数は、2006年2月28日公布の「電子情報製品汚染控制管理弁法」ならびにSJ/T 11364-2006「電子信息産品汚染控制標識要求」に基づき、中華人民共和国(台湾、香港及びマカオを除く)で製造、輸入される電子情報製品に適用される「環境保護使用期限」です。

取り扱い説明書に記載されている、この製品に関する安全や使用上の注意をお守りいただき、且つ法律、規定の免責事由がない限り、製造日から起算するこの年限内では、製品中の有毒、有害物質または元素が外部に漏洩したり、突然変異したり、製品の使用により、重大な環境汚染を起こしたり、使用者の人体や財産に重大な損害を与えることはありません。

「環境保護使用期限」は安全使用期限ではありません。特に電気性能安全、電磁安全などの要素により限定された使用期限とは異なります。製品の適切な使用を終えて廃棄する場合、電子情報製品の回収・リサイクルに関する法律・規定に従っていただくようご協力をお願いします。

注)：この年数は「環境保護使用期限」であり、製品の品質保証期間ではありません。ランプ、電池、トナーカートリッジなどの付属品が同梱されている製品の場合、製品と付属品の環境保護使用期限が異なる場合があります。

本表で「×」を表示しているものは、「欧盟2003年2月RoHS指令」において、現在の科学的見地からその物質の除去又は代替が技術的に実行性がないと認められているものであり、且つ特定有害物質の含有量を制限する中華人民共和国(台湾、香港及びマカオを除く)「電子情報製品汚染控制重点管理目錄」対象製品外のものであります。

Out of Warranty List

This limited warranty shall not apply in respect of the following:

- (i) Any deterioration due to normal wear and tear including all plastic surfaces and all other externally exposed parts that are scratched or damaged due to normal customer use.
- (ii) Defects caused by the Product being subjected to any of the following: use in contradiction with the user guide, rough handling, exposure to moisture, dampness or extreme thermal or environmental conditions or rapid changes in such conditions, corrosion, oxidation, unauthorised modifications or connections, unauthorised opening or repair, repair by use of unauthorised spare parts, misuse, improper installation, accident, forces of nature, spillage of food or liquid, influence from chemical products or other acts beyond Sharp's reasonable control (including but not limited to lifetime, and breakage of or damage to aerials) unless the defect was caused directly by defects in materials or workmanship.
- (iii) Products in respect of which the product serial number or the IMEI number has been removed, erased, defaced, altered or made illegible.
- (iv) Defects caused by the fact that the Product was used with or connected to a product or an accessory not manufactured or supplied by Sharp or was used other than for its intended use.
- (v) Defects caused by a defective function of the cellular network.

- (vi) Defects caused by the fact that the battery was short-circuited or seals of the battery enclosure or cells were broken or show evidence of tampering or the battery was used in equipment other than for which it has been specified.
- (vii) Defects caused by the need to upgrade Products software due to changes in cellular network parameters.
- (viii) Products operated outside published maximum ratings.
- (ix) Products rented on a monthly basis.

Charger Plug:

Do not use the AC Charger if the plug does not fit the socket.

Index

- A**
 - Alarms 82
 - Area Info 62
- B**
 - Battery 14, 129
 - Bluetooth 118
 - Browser 66
 - Browser Settings 67
 - Navigating a WAP or Web Page 66
- C**
 - Calculator 85
 - Calendar 78
 - Lunar Calendar 78
 - Call Functions 27, 116
 - Answer Phone 107
 - Auto Redial 112
 - Call Costs 116
 - Call Restrictions 109
 - Call Timers 116
 - Call Waiting 29, 112
 - Conference Call 29
 - Data Counter 117
 - Earpiece Volume 28
 - Emergency Calls 27
 - International Calls 27
 - Make Another Call 29
 - Minute Minder 111
 - Muting the Microphone 30
 - My Phone Number 109
 - Play Messages 41
 - Redialling 28
 - Rejecting a Call 28, 111
 - Speaker 29
 - Speed Dialling 28, 42
 - Voice Call 27, 28
 - Voicemail & Diverts 108
 - Call Log 116
 - Camera 47
 - Background Saving 55
 - Continuous Shoot 52
 - Digital Zoom 48
 - Exposure 48
 - Face Auto Focus 51
 - Focus Mode 49
 - ISO Sensitivity 52
 - Long Exposure 53
 - Mobile Light 13, 50
 - Panorama Pictures 52
 - Picture Quality 49
 - Picture Size 51, 55
 - Recording Time 55
 - Recording Video Clips 47, 56
 - Review 50
 - Scene 54
 - Set Send Key 55
 - Settings 48
 - Shortcut Keys 51
 - Switching Modes 47
 - Taking Pictures 47
 - Video Quality 49
 - Cell Broadcasts 61
 - Characters
 - Changing the Input Method 31
 - Cutting, Copying, Pasting Text 36
 - Entering Characters 31
 - Input Language 31
 - Notepad 89
 - Notepad Entry 36
 - Pictograms 35
 - Conditions of Use 128
 - Connectivity 118
 - Countdown Timer 87
 - D**
 - Display Indicators 19
 - E**
 - Expenses Memo 86
 - F**
 - Flash® 71
 - G**
 - Gallery 69
 - Other Documents 71
 - H**
 - Handset Code 106
 - Help 93
 - Hour Minder 88
 - I**
 - Infrared 120

J

- Java™ 74
 - Java™ Settings 75

M

- Mass Storage 120
- Master Reset 106
- Memory Card 16, 127
- Memory Status 42, 73, 81, 85
- Message 57
 - Attaching/Removing Data 58
 - Creating a Message 57
 - Drafts Box 59
 - Email 57, 65
 - Forwarding a Message 61
 - Mailing List 38
 - MMS 57, 60, 63
 - Reading a Message 60
 - Replying to a Message 60
 - Sending Options 59
 - Settings 62
 - SMS 57, 63
- Motion Control 24, 104
- Multimedia 43
- Music Player 43
 - Adding a File 44

- Adding a New Playlist 44
- Playing Back Music 43
- Sorting 43

N

- Navigating Functions 21

O

- Off Line Mode 113
- Organiser 78

P

- PC Connection 122
- Phonebook
 - Adding New Entry 37
 - Dialling from an Entry 38
 - Editing Entries 39
 - Manage Group 41
 - Message Group 38
 - Saving a Number 37
 - Saving an Address 60
 - Saving an Image 69
 - Searching the List 37
 - Sending a Message 38
 - Storage Memory 37
 - Thumbnail 39
- Phonebook Lock 106

- Picture Gallery 69
- PIN/PIN2 Code 105
- Power On and Off 18

S

- Safety Precautions 128
- Scanner 53, 90
- Scratch Pad 93
- Set Java™ Wallpaper 76
- Settings 95
 - Date & Time 103
 - Display 96
 - Font 97
 - Internet 113
 - Language 104
 - Network 113
 - Profile 95
 - Security 105
 - Sound 100
 - Standby Display 98
- Shortcut Keys 22
- SIM Application 94
- SIM Card 14
- Sound Gallery 70
- Stopwatch 87
- Streaming Player 46

T

- Tasks 83
- Themes 71

U

- USB Charge 120

V

- VeilView 5, 97
- Video Gallery 70
- Videos 44
 - Adding a File 45
 - Adding a New Playlist 45
 - Playing Back Video 44
 - Searching a File 44
 - Settings 45
- Voice Recorder 89

W

- World Clock 87

X

- XT9 Text Input
 - Using XT9 English Mode 32