

減少電磁波影響，請妥適使用

SAR 標準值 2.0 W/kg；送測產品實測為：X.XXX W/kg

本機限在不干擾合法電臺與不受被干擾保障條件  
下於室內使用

This device can be used indoors only when not  
jamming lawful radio stations and when protected  
from interference.

## Declaration of Conformity

# CE 0168

Hereby, Sharp Telecommunications of Europe Limited,  
declares that this WX-T930 is in compliance with the  
essential requirements and other relevant provisions of  
Directive 1999/5/EC.

A copy of the original declaration of conformity can be  
found at the following Internet address:

<http://www.sharp-mobile.com>

# **Introduction**

Congratulations on your new HSDPA WX-T930 phone.

## **About This User Guide**

This user guide is carefully designed to help you learn about your phone's features and operations quickly and effectively.

## **NOTICE**

- We strongly recommend that you keep separate permanent written records of all important data. Data may be lost or altered in virtually any electronic memory product under certain circumstances. Therefore, we assume no responsibility for data lost or otherwise rendered unusable, whether as a result of improper use, repairs, defects, battery replacement, use after the specified battery life has expired or any other cause.
- We assume no responsibility, directly or indirectly, for financial losses or claims from third parties resulting from the use of this product and any of its functions, such as stolen credit card numbers, the loss or alteration of stored data, etc.
- All company and/or product names are trademarks and/or registered trademarks of their respective holders.

- Screen layout may differ from that illustrated in this user guide.
- The information described in this user guide is subject to change without notice.
- All the functions described in this user guide may not be supported by all networks.
- We assume no responsibility for downloaded contents, information, etc. from the network.
- Occasionally, a few black or bright pixels may appear on the screen. Please note that this will not have any impact on any of the features or on performance.

## **Intellectual Property Rights**

According to copyright laws, the reproduction, alteration and use of material which is protected by copyright (music, pictures, etc.) is only permitted for personal or private use. If the user is not in possession of more extensive copyright or has not received the explicit permission from the copyright owner to reproduce, alter or use a copy which has been made or modified in this way, this is considered to be a violation of the copyright laws and gives the copyright owner the right to claim for damages. For this reason, avoid the illegal use of material which is protected by copyright.

Powered by JBlend™ Copyright  
1997-2008 Aplix Corporation. All rights  
reserved.  
JBlend and all JBlend-based trademarks  
and logos are trademarks or registered  
trademarks of Aplix Corporation in Japan  
and other countries.



Powered by Mascot Capsule®/Micro3D Edition™  
Mascot Capsule® is a registered trademark of HI  
CORPORATION  
©2002-2008 HI CORPORATION. All Rights Reserved.

Licensed by Inter Digital Technology Corporation under one  
or more of the following United States Patents and/or their  
domestic or foreign counterparts and other patents  
pending, including U.S. Patents: 4,675,863; 4,779,262;  
4,785,450; 4,811,420; 5,228,056; 5,420,896; 5,799,010;  
5,166,951; 5,179,571 & 5,345,467

#### CP8 PATENT



microSDHC and microSD logos are trademarks.

XT9® is trademarks and/or registered  
trademarks of Nuance Communications,  
Inc. and/or its affiliates in the United  
States and/or other countries.



XT9 Mobile Interface is licensed under  
one or more of the following: U.S. Pat.  
Nos. 5,187,480, 5,818,437, 5,945,928, 5,953,541,  
6,011,554, 6,286,064, 6,307,548, 6,307,549, 6,636,162,  
6,646,573, 6,970,599, 6,801,190, 7,030,863, 7,088,345,  
7,088,861, 7,164,367; Australia Pat. Nos. 727539, 746674,  
747901; Austria Pat. Nos. AT225534, AT221222; Brazil P.I.  
No. 9609807-4; Canada Pat. Nos. 1,331,057, 2,227,904,  
2,278,549, 2,302,595; People's Republic of China Pat.  
Nos. ZL89107372.8, ZL96196739.0, ZL98122778.3,  
ZL200410049543.9; European Pat. Nos. 0 842 463  
(96927260.8), 1 010 057 (98903671.0), 1 018 069  
(98950708.2); United Kingdom Pat. No. 2238414B; Hong  
Kong Standard Pat. No. HK1010924; Japan Pat. Nos.  
3532780, 3492981; Republic of Korea Pat. Nos.  
KR201211B1, KR226206B1, 402252, 552085, 604039;  
Mexico Pat. Nos. 208141, 216023, 218409; New Zealand  
Pat. No. 519928; Russian Federation Pat. Nos. 2206118,  
2214620, 2221268; Republic of Singapore Pat. Nos.  
51383, 66959, 71976, 89076; Taiwan Pat. Nos. 169965,  
1263163; and additional patents are pending worldwide.

Copyright for Pictograph ©2008 Softbank Mobile Corp. or Sharp Corporation. All rights reserved.



The *Bluetooth*® word mark and logos are registered trademarks owned by the Bluetooth SIG, Inc. and any use of such marks by Sharp is under license. Other trademarks and trade names are those of their respective owners.

Licensed by QUALCOMM Incorporated under one or more of the following United States Patents and/or their counterparts in other nations ;

4,901,307 5,490,165 5,056,109 5,504,773 5,101,501  
5,506,865 5,109,390 5,511,073 5,228,054 5,535,239  
5,267,261 5,544,196 5,267,262 5,568,483 5,337,338  
5,600,754 5,414,796 5,657,420 5,416,797 5,659,569  
5,710,784 5,778,338



This product contains NetFront Browser and NetFront Messaging Client of ACCESS CO.,LTD.

ACCESS and NetFront are trademarks or registered trademarks of ACCESS CO., LTD. in Japan and other countries.

NetFront Browser © Copyright 1996-2007 ACCESS CO., LTD.

NetFront Messaging Client © Copyright 2000-2007 ACCESS CO., LTD.

This software is based in part on the work of the Independent JPEG Group.

Microsoft®, Windows®, Windows Vista®, Outlook®, PowerPoint® and Excel® are registered trademarks of Microsoft Corporation in the United States and/or other countries.

Microsoft Word is a product name of Microsoft Corporation in the United States.

Adobe® and Acrobat® are trademarks of Adobe Systems Incorporated.

The face detection technology utilized is FaceSolid™, a product of Morpho, Inc. FaceSolid™ is the trademark of Morpho, Inc.

This product employs Adobe® Flash® Lite™ technology developed by Adobe Systems Incorporated. Adobe® Flash® Lite™ Copyright © 2003-2007 Adobe Systems Incorporated. All rights reserved.



**ADOBE®  
FLASH®  
ENABLED**

Adobe and Flash are either trademarks or registered trademarks of Adobe Systems Incorporated in the United States and/or other countries.

**picssel**



"Document Viewer" is powered by Picssel Technologies.

Picssel, Picssel Powered, Picssel Cube Logo, Picssel File Viewer

and Picssel Document Viewer are Trademarks or Registered Trademarks of the Picssel Group of Companies.

QR Code is a registered trademark of DENSO WAVE INCORPORATED.

IrSS™, IrSimple™ and IrSimpleShot™ are trademarks or registered trademarks of the Infrared Data Association in the U.S.A. and/or in other countries.

Contains iType™ font engine and font from Monotype Imaging Inc. Monotype® is a trademark of Monotype Imaging Inc. registered in the U.S. Patent and Trademark Office and may be registered in certain jurisdictions.

**FAR EASTONE**



[FarEasTone and Logo] are trademarks or registered trademarks of FarEasTone Telecommunications Co., Ltd. in Taiwan and other countries. Customer Service Call: 0800-058-885

Also Sharp Corp. is authorized with bona fide use of the foregoing trademark in relating course of trade in Japan.

Information contained in this manual is the property of FarEasTone and Sharp. FarEasTone and Sharp reserve the right to change product specifications without prior notice. FarEasTone and Sharp reserve the right to change information contained in this manual without prior notice.

This product is licensed under the MPEG-4 Visual Patent Portfolio License for the personal and non-commercial use of a consumer to (i) encode video in compliance with the MPEG-4 Video Standard ("MPEG-4 Video") and/or (ii) decode MPEG-4 Video that was encoded by a consumer engaged in a personal and non-commercial activity and/or was obtained from a licensed video provider. No license is granted or implied for any other use. Additional information may be obtained from MPEG LA. See <http://www.mpegla.com>.

This product is licensed under the MPEG-4 Systems Patent Portfolio License for encoding in compliance with the MPEG-4 Systems Standard, except that an additional license and payment of royalties are necessary for encoding in connection with (i) data stored or replicated in physical media which is paid for on a title by title basis and/or (ii) data which is paid for on a title by title basis and is transmitted to an end user for permanent storage and/or use. Such additional license may be obtained from MPEG LA, LLC. See <http://www.mpegla.com> for additional details.

MPEG Layer-3 audio coding technology licensed from Fraunhofer IIS and Thomson.

## Useful Functions and Services

Your phone offers you the following features:

- Video Calling. You can talk while viewing images of each other on respective screens.
- 3D and colour Java™ games. You can also download various games and applications from FarEasTone via the mobile Internet.
- 3.0-inch full wide VGA (854 × 480 pixels) Advanced Super View (ASV) full colour LCD display with images that are clearer and easier to view.
- A built-in 8M pixel CCD digital camera with an auto focus function for taking pictures and video clips. A face auto focus function for taking pictures is also available.
- Motion control function for enabling easy operation without using any keys.
- A message function for reading and creating SMS messages.
- MMS (Multimedia Messaging Services) for sending picture, sound and video messages to brighten someone's day.
- Email for sending up to 300 KB and receiving mail with attachments.
- A colour WAP/Web browser for accessing information on the mobile Internet.
- Your own ringtones and ring video clips. You can use sound or video clip files as a ringtone or ring video clip.
- A music player that can play back MP3, MPEG-4 and 3GPP format sound files (supported codec of MPEG-4 or 3GPP are AMR, AAC, AAC+, and AAC+e).
- Playback of downloaded sound and video clip files.
- A voice recorder function for recording and playing back voice clips.
- A *Bluetooth*® wireless technology interface for establishing contact and transmitting data with certain devices. You can transmit pictures, sounds, and video clips to OBEX-enabled phones.
- An infrared interface for data communication. You can transmit pictures, sounds, and video clips to OBEX-enabled phones.
- A schedule alarm for creating and sending schedule entries with alarm settings.
- A veilview function for guarding the screen display from being viewed by others.
- A microSD™ memory card slot that expands connectivity with a PC using the memory card.

# Contents

<b>Introduction</b> .....	<b>1</b>	<b>Voice Call/Video Calling Functions</b> .....	<b>32</b>
<b>List of Menu Functions</b> .....	<b>8</b>	<b>Entering Characters</b> .....	<b>40</b>
<b>Your Phone</b> .....	<b>10</b>	Changing the Input Language .....	40
Optional Accessories .....	10	Changing the Input Method .....	41
<b>Getting Started</b> .....	<b>12</b>	User Dictionary .....	45
Inserting/Removing the SIM/USIM Card and the Battery .....	16	Entering Pictograms and Symbols .....	47
Charging the Battery .....	17	Using the Notepad .....	47
Inserting/Removing the Memory Card .....	19	Insert Phonebook Entries .....	48
Connecting the Handsfree Kit .....	20	<b>Call Manager</b> .....	<b>49</b>
Turning Your Phone On and Off .....	21	Sending a Message from the Phonebook ...	52
Display Indicators (Main Display) .....	22	<b>Multimedia</b> .....	<b>57</b>
Display Indicators (External Display) .....	24	<b>Camera</b> .....	<b>64</b>
<b>Navigating Functions</b> .....	<b>25</b>	Launching the Camera .....	64
Main Menu .....	25	Taking Pictures .....	64
Shortcut Keys .....	26	Recording Video Clips .....	65
Shortcuts .....	27	Common Functions in the Still and Video Camera Modes .....	66
<b>Motion Control</b> .....	<b>28</b>	Functions in Still Camera Mode .....	70
		Functions in Video Camera Mode .....	75

<b>Messages</b> .....	<b>77</b>	<b>Safety Precautions and Conditions of Use</b> .....	<b>166</b>
SMS .....	77	Conditions of Use .....	166
Long SMS .....	77	Mobile Light LED Properties .....	167
MMS .....	77	Environment .....	169
Email .....	77	Precautions Concerning Vehicle Use .....	170
<b>FET Mobile Internet</b> .....	<b>89</b>	SAR (Taiwan) .....	170
Navigating a WAP or Web Page .....	90	SAR (Europe) .....	171
<b>Gallery</b> .....	<b>93</b>	FCC NOTICE .....	171
<b>Java™</b> .....	<b>101</b>	<b>Out of Warranty List</b> .....	<b>174</b>
<b>Organiser</b> .....	<b>106</b>	<b>Index</b> .....	<b>175</b>
<b>SIM Application</b> .....	<b>124</b>	<b>Quick Reference</b> .....	<b>179</b>
<b>Settings</b> .....	<b>125</b>		
<b>Call Log</b> .....	<b>151</b>		
<b>Connectivity</b> .....	<b>152</b>		
<b>Connecting WX-T930 to Your PC</b> .....	<b>158</b>		
System Requirements .....	158		
3G/GSM Modem .....	158		
Handset Manager .....	160		
Music Manager .....	161		
Sync Manager .....	163		
<b>Troubleshooting</b> .....	<b>164</b>		



# List of Menu Functions

WX-T930 functions are listed below.

See relevant page for details of each function. The menu's corresponding number is used for shortcuts. For details, see page 26.

<b>1 Java™</b>		<b>3 Organiser</b>		<b>4 Messages</b>		<b>6 Gallery</b>	
1 Java™ Gallery	p. 101	(Tab 1: Tools 1)		1 Create Message	p. 78	1 Picture Gallery	p. 93
2 Java™ Settings	p. 103	1 Calendar	p. 106	2 Message	p. 81	2 Video Gallery	p. 94
3 Java™ Information	p. 105	2 Alarms	p. 111	3 Email	p. 81	3 Sound Gallery	p. 95
		3 Tasks	p. 112	4 Alert Inbox	–	4 Themes	p. 95
		4 Calculator	p. 115	4 Cell Broadcasts	p. 83	5 Java™ Gallery	p. 101
		5 Expenses Memo	p. 116	6 Area Info	p. 84	6 Flash® Documents	p. 96
		(Tab 2: Tools 2)		7 Messaging Settings	p. 84	7 Other	p. 97
<b>2 FET Mobile Internet</b>		1 Stopwatch	p. 117	8 Memory Status	–	8 Memory Status	p. 100
1 Homepage	p. 89	2 Countdown Timer	p. 118				
2 Bookmarks	p. 89	3 World Clock	p. 118	<b>5 Camera</b>	▶ p. 64	<b>7 Multimedia</b>	
3 Alert Inbox	p. 89	4 Hour Minder	p. 119	1 Still Camera	p. 64	1 Video Player	p. 57
4 My Saved Page	p. 89	(Tab 3: Tools 3)		2 Video Camera	p. 65	2 Streaming Player	p. 60
5 Go to URL	p. 89	1 Document Viewer	p. 119	3 Barcode/Scan	p. 72	3 Music Player	p. 60
6 Access History	p. 89	2 Notepad	p. 120	4 Review	p. 68	4 Java™	–
7 Browser Settings	p. 91	3 Voice Recorder	p. 121	5 Still Camera Settings	–	5 Camera	p. 64
		4 Scanner	p. 122	6 Video Camera Settings	–		
		5 Phone Help	p. 123				
		6 Scratch Pad	p. 123				

## 8 Call Manager

- |                         |       |
|-------------------------|-------|
| 1 Phonebook             | p. 49 |
| 2 Add New               | p. 49 |
| 3 Call Voicemail        | –     |
| 4 Manage Groups         | p. 55 |
| 5 My Card               | p. 50 |
| 6 Speed Dial List       | p. 56 |
| 7 Message Groups        | p. 52 |
| 8 Phonebook Settings    | p. 49 |
| 9 Service Dialling No.* | p. 51 |
| 10 Advanced             | p. 54 |

## 9 Settings

(Tab 1: Phone Settings)

- |                          |               |
|--------------------------|---------------|
| 1 Profiles               | p. 125        |
| 2 Display Settings       | p. 126        |
| 3 Themes                 | p. 130        |
| 4 Sound Settings         | p. 131        |
| 5 Date & Time            | p. 134        |
| 6 Language               | p. 135        |
| 7 Motion Control         | p. 28, p. 136 |
| 8 Switch Ringtone Output | p. 136        |
| 9 Earpiece Volume        | –             |
| 10 Change Menu           | p. 136        |
| 11 Security Settings     | p. 137        |
| 12 Master Reset          | p. 139        |

(Tab 2: Call/Video Call)

- |                          |        |
|--------------------------|--------|
| 1 Voicemail & Diverts    | p. 139 |
| 2 Video Calling Settings | p. 141 |
| 3 Show Your Number       | p. 142 |
| 4 Restrict Calls         | p. 143 |
| 5 Minute Minder          | p. 145 |
| 6 Auto Answer            | p. 145 |
| 7 Call Waiting           | p. 146 |
| 8 Display Call Timer     | p. 146 |
| 9 Display Call Cost      | p. 146 |
| 10 Auto Redial           | p. 146 |
- (Tab 3: Network Settings)
- |                     |        |
|---------------------|--------|
| 1 Network Settings  | p. 146 |
| 2 Off Line Mode     | p. 147 |
| 3 Internet Settings | p. 148 |

## 10 SIM Application\*

▶ p. 124

## 11 Call Log

- |                  |        |
|------------------|--------|
| 1 All Calls      | p. 151 |
| 2 Dialed Numbers | p. 151 |
| 3 Missed Calls   | p. 151 |
| 4 Received Calls | p. 151 |
| 5 Call Timers    | p. 151 |
| 6 Call Costs*    | –      |
| 7 Data Counter   | p. 151 |

## 12 Connectivity

- |                 |        |
|-----------------|--------|
| 1 Bluetooth     | p. 152 |
| 2 Infrared      | p. 155 |
| 3 Mass Storage  | p. 156 |
| 4 USB Charge    | p. 156 |
| 5 Card Settings | p. 156 |

\* Depends on SIM/USIM card contents.

## **Your Phone**

Please check the following carefully. Your phone should come complete with:

- HSDPA/3G (UMTS)/GSM 900/1800/1900 GPRS phone
- Rechargeable Li-ion Battery
- AC Charger
- Stereo Handsfree
- Chinese User Guide

## **Optional Accessories**

- Li-ion Spare Battery
- Cigarette Lighter Charger
- USB Data Cable
- Handsfree Microphone Unit
- Stereo Headset





The above accessories may not be available in all regions.



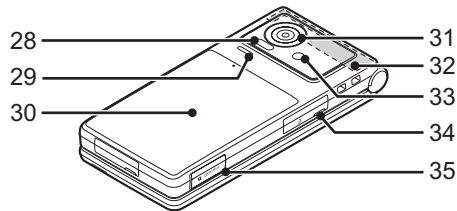
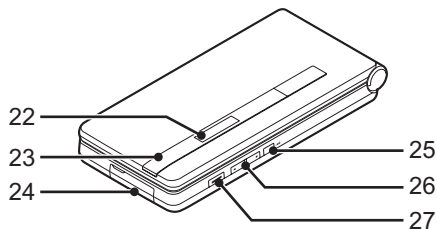
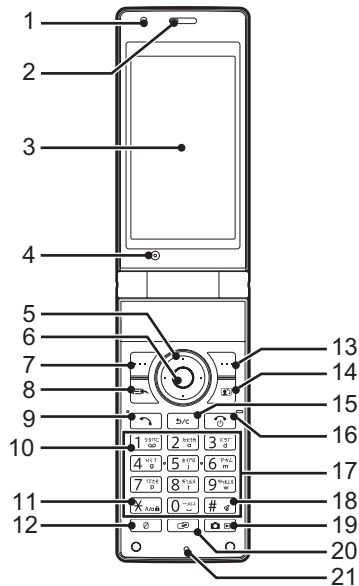

For details, please contact FarEasTone.





## Getting Started





- 1. Light Sensor**
- 2. Earpiece**
- 3. Main Display**
- 4. Sub Camera (Internal Camera)**
- 5. Navigation Keys (Arrow Keys):**    

Moves cursor to highlight a menu item, etc.  
Up arrow key () displays the Calendar and Tag when pressed in stand-by.  
Down arrow key () displays Phonebook entries when pressed in stand-by.  
Left arrow key () displays the Java™ Gallery list when pressed in stand-by.  
Right arrow key () displays Gallery when pressed in stand-by.
- 6. Centre Key:** 

Displays Main menu in stand-by, and executes functions.  
Long press in stand-by to activate video camera.
- 7. Left Soft Key:** 

Executes the function in the lower left of the screen.  
Displays Message menu in stand-by.
- 8. Shortcut Key:** 

Displays Shortcut menu.
- 9. Send/Redial Key:** 

Makes voice calls or accepts calls, and displays the call logs in stand-by.
- 10. Voicemail Key:** 

Long press to connect to the Voicemail centre.  
(Depending on the SIM/USIM card.)
- 11. \* /Shift Key:** 

Switches character input method as follows on the text entry screen.  
In English mode: Abc, ABC, abc and 123. In XT9 mode, XT9 Abc, XT9 ABC, XT9 abc and 123.  
In Traditional Chinese mode: Abc, ABC, abc, 123, XT9 BoPoMoFo, and XT9 Stroke.  
In Simplified Chinese mode: Abc, ABC, abc, 123, XT9 PinYin, and XT9 Stroke.  
Press to enter P, ?, +, - or \* in stand-by.  
Long press in stand-by to lock the keypad.
- 12. VeilView Key:** 

Long press to switch veilview on/off.
- 13. Right Soft Key:** 

Executes the function in the lower right of the screen.  
Accesses “FET Mobile Internet” by opening the browser in stand-by.

**14. Video Telephony Key:** 

Makes video callings or accepts calls, and displays the call logs in stand-by.

**15. Clear/Back Key:** 

Clears the characters before the cursor, returns to the previous screen, etc.

**16. End/Power Key:** 

Ends a call.

Long press to turn power on/off.

**17. Keypad****18. #/Silent Key:** 

Displays symbol and pictogram screen on the text entry screen.

Long press to switch languages on the text entry screen.

Long press in stand-by to switch Profiles settings between the mode most recently activated and Silent mode.

**19. Camera Key:** 

Activates the camera.

Long press to display the data taken the last time.

**20. Profile Menu Key:** 

Displays Profile menu in stand-by.

Long press to switch the Silent profile on/off.

**21. Microphone****22. External Display****23. Small Light:**

Flashes when an incoming call or a new message is received or missed, if Event Light (p. 125) or Status Light (p. 126) is enabled.

**24. External Connector:**

Used to connect either the charger or a USB data cable.

**25. Mobile Light Key:** 

When the phone is open and the camera is active:  
Press to change the Mobile Light mode.

When in standby with the phone either open or closed:

Long press to turn on the Mobile Light.

**26. Side Volume Keys:** 

Press during a call to increase or decrease the earpiece volume.

Press while listening to music (or video) to increase or decrease the earpiece volume.

**27. Side Shutter Key:** 

When the camera is active:

Takes a picture or starts recording a video.

Press halfway to lock the focus.

**28. Infrared Port:**

Sends and receives data via infrared.

**29. Speaker****30. Battery Cover****31. Camera (External Camera)****32. Built-in Aerial:**

Warning: Do not cover the hinge area of the phone with your hand when in use as this may interfere with the performance of the built-in aerial.

**33. Mobile Light:**

Used as an auxiliary light.

**34. Handsfree Kit/Microphone Connector****35. microSD Card Slot**



## Inserting/Removing the SIM/USIM Card and the Battery

1. Slide off the battery cover (① ②).

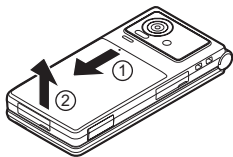

2. Slide the SIM/USIM card into the SIM/USIM holder (③).

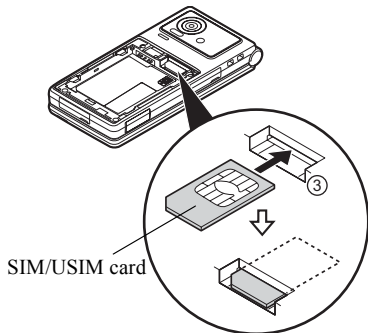

3. Hold the battery so that the metal contacts of the battery are facing down, slide the guides on the top of the battery into the battery slots (④), and then insert it (⑤).

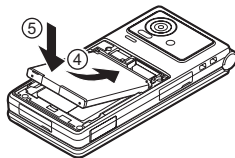

4. Replace the battery cover.

### **Note**

- Make sure that only 3V SIM/USIM cards are used.
- Make sure that the standard accessory battery is used.

## Battery Disposal

The device is battery-powered. In order to protect the environment, please read the following points concerning battery disposal:

- Take the used battery to your local waste depot, dealer or customer service centre for recycling.
- Do not expose the used battery to a naked flame, immerse in water or dispose with the household waste.



Please recycle waste batteries

## Charging the Battery

You must charge the battery for at least XXX minutes before using your phone for the first time.

### Using the Charger

1. Open the cover of the external connector, and connect the charger horizontally to the external socket located at the bottom of the phone until it clicks.
2. Extend the blades of the charger.

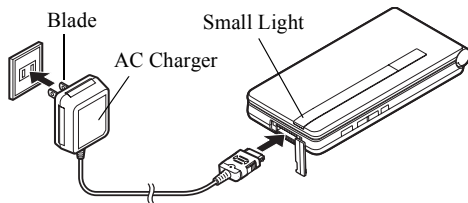

3. Connect the charger to an AC outlet.  
When the phone is charging, the battery indicator icon (  ) displays the current status. The Small Light also lights up.  
Standard charging time: Approx. XXX minutes

### Note

- Charging time may vary depending on the state of the battery and other conditions. (See “Battery” on page 167.)

### To Disconnect the Charger

When charging is completed, the battery indicator icon displays the full charge status. The Small Light also turns off when completed.

1. Unplug the charger from the AC outlet.
2. Push and hold the side buttons of the charger ①, then disconnect the charger from the external socket of the phone ②.

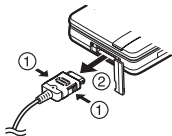

3. Close the cover.

### Note

- Do not use any non-approved chargers as they may damage your phone and invalidate any warranties, see “Battery” on page 167 for details.
- Forcibly disconnecting the charger may cause malfunction.



### To Charge Using the Cigarette Lighter Charger

The optional cigarette lighter charger supplies power for charging from the cigarette lighter socket of a car.





## Battery Level Indicator

The current battery level is displayed in the upper right of the screen.

## Low Battery during Use

When the battery is running low, an alarm will sound and “” or “” is displayed on the screen.

If you are using your phone and you hear the low battery alarm, attach your charger as soon as possible. The phone may not be able to continue normal operation if you continue to use it.

Battery Indicators	Charge Level
	Sufficiently charged
	Charging recommended
	Charging required
	Empty

## Inserting/Removing the Memory Card

### Note

- *Make sure that the phone is turned off before inserting/removing the memory card.*
  - *Be sure to insert the card in the correct direction and orientation.*
  - *Keep all memory cards out of the reach of small children.*
1. Turn off the phone.
  2. Open the microSD card slot cover.

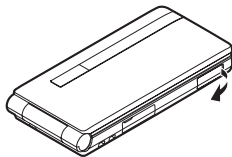



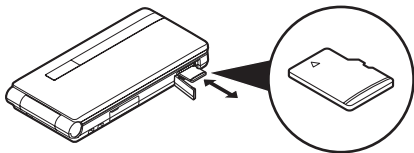

3. Insert the memory card until it clicks. (To remove the memory card, push the memory card until it clicks.)



4. Close the cover.

#### **Tip**

- You see the following indicators when the memory card is in use:
  - : Appears when the card is inserted.
  - : Appears when the card is damaged or unusable. Make sure the card is properly inserted.
  - : Appears when the card is being accessed.
  - : Appears when the card is being read.
  - : Appears when the card is being formatted.

## **Connecting the Handsfree Kit**

1. Open the connector cover.
2. Connect the handsfree kit.

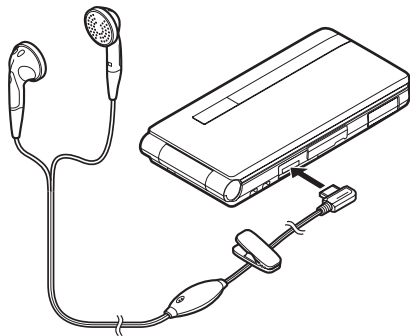

## Turning Your Phone On and Off

To turn the power on or off, long press  for approximately 2 seconds.

### To Enter the PIN Code

If the PIN (Personal Identification Number) code is enabled you are asked to enter the PIN code each time the phone is switched on. For details on setting the PIN code, see “Enabling/Disabling the PIN Code” on page 137.

1. Enter your PIN code.

The PIN code is 4 to 8 digits.

2. Press .

### Note

- If your PIN code is entered incorrectly three times in a row, the SIM/USIM card is locked. See “Enabling/Disabling the PIN Code” on page 137.
- If the clock settings have not been entered, the date and time entry screen is displayed (p. 134).

## To Copy All Phonebook Entries from the SIM/USIM Card









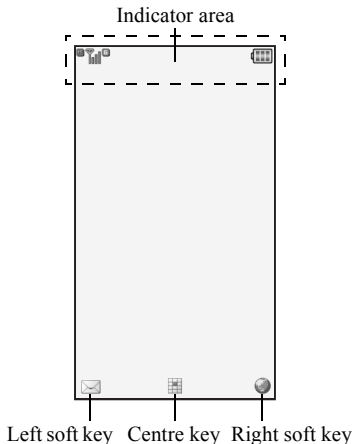









When you insert the SIM/USIM card into your phone for the first time and start the Phonebook application, you are asked whether you wish to copy Phonebook entries on the SIM/USIM card. Follow the on-screen instructions, or you can do it later using the Phonebook menu as follows:

**“Call Manager” → “Advanced” → “Copy All Entries”**

1. Select “From SIM to Handset”.

## Display Indicators (Main Display)



-   : Strength of received signal/Service out of range
  -  : HSDPA
  -  : 3G (UMTS)/GPRS
  -  : GSM
  -  : GPRS enabled
  -  : Roaming outside network
-   : Connection to the server [established/communicating]
-   : Voice call [incoming/in progress]
-    : Video calling communication mode enabled [voice/video/voice and video]
-   : Alerts [text message and multimedia message/Email]
-  : Mailbox full
-  : "Voice Calls" diverts set to "Always"

8. : Connection status [USB cable [stand-by/exchanging information]/IrDA setting [stand-by/exchanging information]/*Bluetooth* wireless setting [stand-by/exchanging information/talking with the *Bluetooth* headset/Hide my phone/playing back music with the *Bluetooth* headset]]
9. : Java™ application [executed/suspended]/Music player
10. : Secure WAP/Web page displayed
11. : Silent/vibration setting [silent/vibration enabled/silent and vibration enabled]
12. : Speaker mode [speaker phone on/microphone muted]
13. : Memory card inserted
14. : Battery level
15. : Daily alarm enabled
16. : Schedule entry enabled [with/without reminder alarm]
17. : Outbox contains unsent messages [text message/multimedia]
18. : WAP/OTA provisioning alerts [WAP alert/OTA provisioning alert/WAP and OTA provisioning alerts]
19. : Voicemail message alert
20. : “Show Secret Data” set to “On”
21. : Function Lock enabled
22. : Keypad Lock enabled
23. (No display)/ : Current profile [Normal/Car/Silent/Personal]
24. : Hour minder enabled
25. : Auto answer enabled



## Display Indicators (External Display)

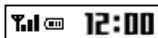

9. : Sound file being played
10. : Streaming
11. : Stopwatch/countdown timer
12. : OBEX data incoming
13. : Voice Recorder activated

### Status Indicators

1. :  
Battery level [sufficiently charged/  
charging recommended/charging  
required/empty]
2. **12:00** : Clock
3. / : Strength of received signal/Service out  
of range
4. / : Missed events
5. : Voice call incoming
6. : Call in progress
7. / : Alerts [messages/Delivery Report]
8. / / :  
Alarm enabled [Daily alarm/Schedule  
alarm/Task alarm]

# Navigating Functions







## Main Menu



All applications are accessed from the Main menu.



To launch applications, you will need to open the Main menu, highlight menu items, and then make selections. For details on menu options, see “List of Menu Functions” on page 8.





The basic operations are as follows.

To Access the Main Menu	Press  in stand-by.
To Select a Menu Item (indicated in quotation marks in this user guide)	Move the cursor using  ,  ,  ,  and press  to select.
To Return to the Previous Screen	Press right soft key if it displays <i>Back</i> .
To Close the Main Menu	Press right soft key if it displays <i>Back</i> .

In certain procedures, you will need to press one of the soft keys (indicated in square brackets in this user guide), which are displayed in the lower left and right of the screen. Press the corresponding soft key ( or ) to execute the function displayed in the screen.

The Organiser and Settings menus have tabs.

The operations for selecting an item in these menus are as follows.

To Access the Desired Tab	Press  or  .
To Select a Menu Item (indicated in quotation marks in this user guide)	Move the cursor using  or  and press  to select.

Each section in this user guide starts with a list of items you will need to select in order (indicated in italics) before performing the procedures shown. Select each item to reveal the next set of items that you have to choose from. Open subsection items after opening those listed in the main section.







Example:

***“Java™”*** → ***“Java™ Settings”***

Example (menu with tabs):

***“Settings”*** → ***“Call/Video Call” tab*** → ***“Video Calling Settings”***

## Shortcut Keys





You can access menus by pressing  and digit keys for the corresponding number on the Main menu. For numbers 10 to 12, press  and  (10),  (11) or  (12). For menus with tabs, press  (or  when necessary) to select the desired tab before pressing the digit keys. See “List of Menu Functions” on page 8.

Shortcuts are listed in the headings of this user guide.

Example (p. 147): To Access “Off Line Mode” Sub Menu

### **Off Line Mode (M 9---2)**

***“Settings”*** → ***“Network Settings” tab*** → ***“Off Line Mode”***

Press   and  twice for the “Network Settings” tab, then press .

Example (p. 55): To Access “Manage Groups” Sub Menu

### **Manage Groups (M 8-4)**



***“Call Manager”*** → ***“Manage Groups”***









Press   .

#### **Note**

- *The shortcut keys work for the first three menu levels only.*

## Shortcuts



Your phone has a shortcut function (press  in stand-by) which enables you to access the desired menu quickly. The default shortcuts are as follows (shortcuts assigned to  can be customised):

- Main Menu
- Scratch Pad
- Enter Phone Number
- : Inbox
- : Create Message
- : Bookmarks
- : Calendar
- : Phonebook
- : Gallery
- : Calculator
- : Alarms
- : Bluetooth



## To Use the Shortcut Key

1. Press  in stand-by.
2. Select the desired item or number.

## To Customise the Assigned Shortcuts

1. Press  in stand-by.
2. Highlight the shortcut you wish to customise from .
3. Press [Options] and select “Assign”.  
The list of the available items is displayed.
4. Select the desired item.

### Note

- To move the item in the list that appears in step 1, highlight the item, press [Options] and select “Move”. Then press  or  to the desired location and press .
- To reset the customised shortcut, press [Options] and select “Set to Default” in step 2.

## Motion Control

Your phone has a sensor which can detect motion or changes in direction. You can change the picture being displayed or enlarge or shrink the contents of the screen in specified applications, just by moving it in a certain way.

For details on the settings for motion control, see “Motion Control Settings” on page 136.

### Holding the Phone Correctly

Open Position  
(Portrait)



Open Position  
(Landscape)

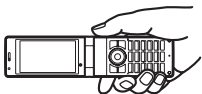

Closed Position



Hold the phone so it fits in the palm of your hand.

### Before Using Motion Control

Make sure that the phone is in the following status.

#### 1. The Display is Turned On

This function is not available when the display is turned off.

To Turn On the Display

Press any side key.

#### 2. Keypad Lock is Deactivated

This function is not available when the keypad is locked.

To Deactivate Keypad Lock

Long press .

#### 3. “Display Change” for Motion Control is Enabled

“Settings” → “Phone Settings” tab → “Motion Control” → “Display Change” → Select the desired settings → “On”

#### 4. “Action Settings” for Motion Control is Enabled

“Settings” → “Phone Settings” tab → “Motion Control” → “Action Settings” → Select the desired action → “On”

## Motion Control Functions

### 1. Change the Direction of the Screen

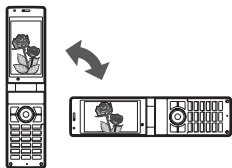

When Document Viewer or the WAP/Web browser is activated, the screen automatically changes direction to the portrait or landscape position according to the direction the phone is held.

### 2. Enlarge or Shrink the Contents of the Screen

Enlarge or shrink the font size of the text in messages by shaking the phone forward or backward. You can also enlarge/shrink pictures being viewed and the screen contents of WAP/Web pages or documents being viewed with Document Viewer.

Open Position  
(Portrait)

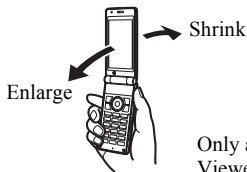

Open Position  
(Landscape)

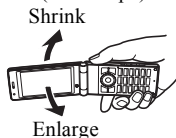

Only available for Document Viewer and WAP/Web pages.

### 3. Select a Sound File or Picture

Select the previous or next picture, sound or document file by shaking the phone once to the left or to the right. You can also change the page being viewed.

Open Position  
(Portrait)



Closed Position

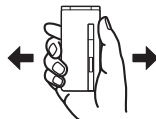

Only available for sound files.

#### 4. Quick Silent

Quickly silence your phone (the ringtone, alarm tone, etc.) just by turning the phone over.

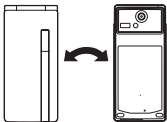

#### Note

- *Make sure to set “Quick Silent” in “Action Settings” to “On” before using this function.*
- *Depending on the volume and the type of sound, some ringtones or alarm tones may not be muted.*

#### Showing Secret Data Temporarily

The hidden data in the Phonebook or Calendar can be displayed temporarily by shaking the phone.

1. Enter the handset code in stand-by.
2. Shake the phone to the left or right.

The hidden data can be displayed temporarily.

To hide the data again, display the stand-by screen and close the phone.

## Practicing the Action (M 9-7-3)

You can practice and confirm the actions set in the motion control settings.

**“Settings”** → **“Phone Settings”** tab → **“Motion Control”** → **“Action Test”**

1. Select “Zoom in/out” or “Select Contents”.
2. Perform the selected action to test the setting.  
A confirmation tone sounds when an action is recognised.

### *Note*

- *Motion control may not function correctly depending on the way the phone is held or shaken.*
- *When shaking the phone, try to keep it as level as possible.*
- *Do not shake the phone at an angle.*

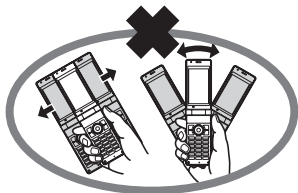



- *When using motion control, make sure to hold on to the phone firmly and not to shake the phone too strongly. Confirm that there is enough space around you to ensure the safety of others. Failing to do so may result in injury or damage to the phone or objects near by.*



## Voice Call/Video Calling Functions

### Making a Voice Call

1. Enter the area code and the phone number you wish to dial, and then press  to dial.

If you enter the wrong number, press  to delete the number to the left of the cursor.



### Emergency Calls

1. Enter 112, 119 or 911 using the keypad and press  to dial.

#### Note

- *Emergency calls may not be able to be made on all mobile phone networks when certain network services and/or phone features are in use. Contact your service provider for more information.*
- *This emergency number can normally be used to make an emergency call in any country, with or without a SIM/USIM card inserted, if a 3G (UMTS)/GSM network is within range.*

### International Calls

1. Long press  until a + (international dialling prefix) sign is displayed.
2. Enter the country code, followed by the area code (without the leading zero) and the phone number, and press  to dial.

### Adding an Entered Phone Number to the Phonebook

1. After entering a phone number, press [Options] and select “Save Number”.  
For details on creating a new entry, see “Adding a New Phonebook Entry” on page 49.

### Showing or Hiding My Phone Number on the Display of the Called Party

1. After entering a phone number, press [Options], select “Show My ID” or “Hide My ID” and press  to dial.

## Speed Dialling





The digit keys (1<sup>1545</sup> to 9<sup>9441</sup>) can be used for speed dial. Up to 8 phone numbers from the Phonebook memory (Handset and SIM/USIM) can be assigned to 2<sup>2442</sup> to 9<sup>9441</sup>. The phone number of the Voicemail centre is assigned to 1<sup>1545</sup>.

For details on setting the speed dial list, see “Speed Dial List” on page 56.

1. To dial a number using the speed dial, long press any of the digit keys (1<sup>1545</sup> to 9<sup>9441</sup>) in stand-by.  
The phone number saved in the speed dial list is dialled.

## Redialling



You can redial numbers in the call log. Select from specific categories or “All Calls”. Specific categories contain up to 30 numbers and the “All Calls” list contains up to 90.

1. Press  in stand-by.
2. Select the category from “All Calls”, “Dialled Numbers”, “Missed Calls” or “Received Calls”.  
To switch logs, press  or .
3. Highlight the phone number you wish to call.
4. Press  to redial a voice call or  to redial a video calling.

## Answering a Voice Call

When an incoming call is detected, the phone rings.

1. Press  or  to answer the call.

Or press any key except , , [Options] or [Busy] when the “Any Key Answer” function is enabled. Set the Any Key Answer function in the profile of each mode (p. 126).

### Tip

- *If you have subscribed to the Calling Line Identification (CLI) service and the caller's network sends the number, the caller's number is displayed on the screen. If the caller's name and number are saved in the Phonebook, the caller's name is displayed on the screen.*
- *If the number is a restricted number, the display shows “Withheld”.*
- *When you receive a call from the person whose picture is registered in the Phonebook, the picture and name are displayed.*

### Rejecting an Incoming Call

1. Press [Options] and select “Reject” while the phone is ringing to reject a call you do not wish to answer.

### Letting the Caller Know You are Unavailable









1. Press [Busy] while the phone is ringing to send a busy tone to the caller.

### In Call Menu (Voice Call)

Your phone has additional functions available while a call is in progress.

#### Adjusting the Earpiece Volume

You can adjust the earpiece volume to five levels.

1. Press  or  to display the Earpiece Volume screen.
2. Press  (or /) to increase the volume of the call or press  (or /) to decrease the volume.
3. Press  when the volume is set to the desired level.

#### Turning the Speaker On and Off

You can talk via the loudspeaker on the phone when it is on.

1. During a call, press .

### Putting a Call on Hold

This function allows you to manage two calls at the same time. If you wish to make another call while you are talking to someone, you can put the current call on hold to call someone else.

#### To Make Another Call during a Call

1. During a call, press [Options] and select “Hold”.  
The current call is put on hold.
2. Press [Options] and select “Enter Number”.
3. Enter the phone number you wish to make another call to, then press .

#### Tip

- You can also make another call by entering the phone number during a call instead of step 1. The current call is automatically put on hold.

## Accessing SMS/MMS Menu during a Call

1. During a call, press [Options] and select “Messages”.

The following options are available: “Create Message” to make an SMS and MMS, or “Inbox”, “Sent” or “Drafts” to access these folders. For details on SMS and MMS, see “SMS” and “MMS” on page 77.

## Call Waiting

This service notifies you of another incoming call while you have a call in progress.

1. During a call, press [Options] and select “Hold & Answer” to answer the second call.

The first call is put on hold and you can now talk to the second caller.

You can also answer the second call by pressing .

## Note

- You need to set “Call Waiting” to “On” if you wish to use the Call Waiting service (p. 146).
- Call Waiting service may not be available on all networks. Contact your service provider for more information.
- If you do not wish to answer the second call, press [Options] and select “Busy” in step 1. If “Reject” is selected, the log of the second call is saved as a missed call.

## Conference Call

Conference call is a call with more than 2 participants. You may include up to 5 participants in a conference call.

### To Make a Conference Call

You must have one active call and one held call.

1. During a call, press [Options] and select “Conference All” to join the conference call.
2. Press  to end the conference call.

### **Note**

- *The conference call service may not be available on all networks. Contact your service provider for more information.*
- *To end the call with all participants, press [Options] and select “End All Call(s)”.*
- *To reject adding more participants to the current party, press [Options] and select “Reject”, or you can send the busy tone by selecting “Busy”.*
- *You have more options for the conference call after selecting “Conference All” in step 1:*
  - *To put all participants on hold, select “Hold All”.*
  - *To put all participants except the current call on hold, select “Private”.*

### **To Add New Participants to the Conference Call**

1. Press [Options] and select “Enter Number”.
2. Enter the number you wish to include in the conference call and press  to dial.
3. Press [Options] and select “Conference All” to join the conference call.

If you wish to add other participants, repeat steps 1 to 3.

### **To End the Call with a Conference Call Participant**

1. During a conference call, highlight the person that you wish to disconnect from the conference call.
2. Press [Options] and select “End This Call”.

### **To Have a Private Conversation with One of the Participants**

If you wish to have a private conversation with one of the participants, you may select the participant from the conference list and put the other participants on hold.

1. During a conference call, select the person that you wish to talk to.
2. Press [Options] and select “Private”.
3. Once you have finished the private conversation, press [Options] and select “Conference All” to return to the conference call.

### **Muting the Microphone**

1. During a call, press [Mute].  
To use the microphone again, press [Unmute].

## Making a Video Calling

### Note

- *Video callings can only be made and received if both parties have 3G capable phones and 3G coverage. See “Display Indicators (Main Display)” on page 22.*
- *Make sure that the battery is fully charged and the signal is strong before using this function.*
- *Turn the loudspeaker on or use a handsfree kit so that you can talk while looking at the video calling screen on the display.*
- *Use the camera to send live video images.*

### Making a Video Calling

To Make a Video Calling by Entering the Phone Number First

1. Enter the area code and the phone number you wish to dial, and then press  to dial.

If you enter the wrong number, press  to delete the number to the left of the cursor.



When connected, the image of the called party and yours are displayed on the screen.

### Tip

- *If the called party’s phone is not video calling enabled, you can press  and enter the phone number again to make a voice call.*

## Answering a Video Calling

When an incoming call is detected, the phone rings.

1. Press  to answer the call with video, or press  or [Options] and select “Hide Picture” to answer with voice only.

### Tip

- *If you have subscribed to the Calling Line Identification (CLI) service and the caller’s network sends the number, the caller’s number is displayed on the screen. If the caller’s name and number are saved in the Phonebook, the caller’s name is displayed on the screen.*

### Rejecting an Incoming Call

1. Press [Options] and select “Reject” while the phone is ringing to reject a call you do not wish to answer.

### Letting the Caller Know You are Unavailable

1. Press [Busy] while the phone is ringing to send a busy tone to the caller of an incoming call letting them know that you cannot answer the call.

## In Call Menu (Video Calling)

### Muting the Microphone

1. During a video calling, press [Options] and select “Mute Microphone”.

To use the microphone again, press [Options] and select “Unmute Microphone”.

### Swapping Images

You can swap images displayed on the video calling screens.

1. During a video calling, press [Options] and select “Switch Images”.
2. Select “Priority to Incoming”, “Priority to Outgoing”, “Incoming Up” or “Outgoing Up”.

### Changing the Outgoing Image

During a video calling, you can switch the image shown to the caller between the camera image and an alternative image.

1. During a video calling, press [Options] and select “Camera Picture”.

2. Select “Internal Camera”, “External Camera” or “Alternative Image”.

“Internal Camera”: The image through the sub camera is displayed and sent to the receiver.

“External Camera”: The image through the camera is displayed and sent to the receiver.

“Alternative Image”: The camera is turned off and the image selected in “Alternative Image” of “Video Calling Settings” (p. 141) is used.

### Turning the Speaker On and Off

You can talk via the loudspeaker on the phone when it is on.

1. During a video calling, press  to turn the loudspeaker on/off.

#### Note

- *In a high-noise environment, you may not be able to continue a call or make a clear call. We recommend that you use the handsfree kit.*
- *With this option, there may be interruption if you increase the earpiece volume. We recommend that you decrease the earpiece volume or use the handsfree kit.*

## Video Calling Settings

### To Adjust the Quality of the Incoming or Outgoing Image

You can adjust the quality of the called party's or caller's image.

1. During a video calling, press [Options] and select "Video Calling Settings".
2. Select "Incoming Picture Quality" or "Outgoing Picture Quality".
3. Select "Normal", "Quality Priority" or "Frame Rate Priority".  
"Normal": The standard quality is used.  
"Quality Priority": The quality of the picture takes precedence over the frame rate.  
"Frame Rate Priority": The frame rate takes precedence over the quality.

### To Turn the Backlight On or Off

You can turn on the backlight of your screen.



1. During a video calling, press [Options] and select "Video Calling Settings".
2. Select "Backlight".

3. Select "Always On", "Always Off" or "As Normal Setting".

When "Always On" is selected, the backlight will always be on during a video calling.

When "As Normal Setting" is selected, the backlight will time out depending on the Backlight setting (p. 129).

### To Adjust the Video Exposure

1. During a video calling, press [Options] and select "Video Calling Settings".
2. Select "Exposure".
3. Press  (Light) or  (Dark).

### To Change the Sub Camera Image to the Alternative Image

During a video calling, you can switch the image shown to the caller between the sub camera image and an alternative image or display an image while putting a call on hold from the saved picture files.

1. During a video calling, press [Options] and select "Camera Picture".
2. Select "Internal Camera", "External Camera" or "Alternative Image".  
If "Alternative Image" is selected, select "Preset Picture" or "Picture Gallery".







## Entering Characters





When entering characters to create Phonebook entries, text messages or multimedia messages, etc., press the corresponding keys.

In multi-tap input method, press each key until the desired character is displayed. For example, press  once for the letter A or twice for the letter B.

Press the following keys to:

- : Enter:  
. (full-stop) , (comma) ? ! : ; ' (apostrophe) " / 1
- : Enter:  
(space) + = < > € £ \$ ¥ % & 0
- : Switch character case among four modes:  
Abc, ABC, abc and 123.
- : Display the pictograms and symbols selection screen.

Long press the following keys to:

-  - : Enter 1-9 numbers.
- : Enter space in Numeric mode or to enter 0 in other modes.
- : Shift between multi-tap and XT9 mode.
- : Display the Input Language options screen.

## Changing the Input Language

1. On the text entry screen, press [Options] and select “Input Language”.
2. Select the desired language.

## Changing the Input Method

1. On the text entry screen, press [Options] and select “Input Method”.
2. Select the input method you wish to use.

Input Method	Input Language = English	Input Language = Traditional Chinese	Input Language = Simplified Chinese
XT9 Mode	XT9 Abc XT9 ABC XT9 abc	XT9 BoPoMoFo XT9 Stroke	XT9 PinYin XT9 Stroke
Multi-tap mode	Abc ABC abc Numeric	Abc ABC abc Numeric	Abc ABC abc Numeric

### Tip

- In XT9 or multi-tap mode, you can switch input mode as follows by pressing .

### English/XT9 mode

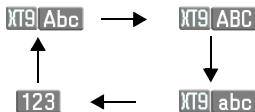

### English/Multi-tap mode

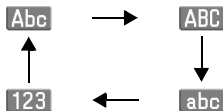





### Traditional Chinese/XT9 mode



## XT9 English Mode

### Using XT9 English Mode

XT9 text input method is a shortcut to enter text easily and quickly.

1. On the text entry screen, press [Options].
2. Select “Input Method”.
3. Select the XT9 mode (XT9 Abc, XT9 ABC, XT9 abc) you wish to change. “**XT9**” is displayed on the screen.
4. Press the keys to enter characters.
5. Press  or  to select the word you wish to input.
6. If you wish to clear the word, highlight it and long press .
7. Press  to complete the selection.













### Tip



- If you press  instead of step 6, a space is inserted next to the selected word.

## XT9 BoPoMoFo and XT9 Stroke Mode

In XT9 BoPoMoFo and XT9 Stroke mode, keys are as follows.

### XT9 BoPoMoFo and XT9 Stroke Mode Keys

Key	BoPoMoFo	Stroke
	ㄅ ㄆ ㄇ ㄏ	一
	ㄉ ㄊ ㄋ ㄌ	丨
	ㄍ ㄎ ㄏ	ノ
	ㄏ ㄏ ㄏ	ㄣ
	ㄏ ㄏ ㄏ	ㄣ
	ㄏ ㄏ ㄏ	Wildcard
	ㄏ ㄏ ㄏ	
	ㄏ ㄏ ㄏ	
	ㄏ ㄏ ㄏ	
	Change Input Method	
	一 X ㄏ	Space
	Go to the pictograms and symbols selection screen.	

 -  : Long press to input corresponding Chinese character displayed in the candidate field.

 : Long press to display the Input Language screen.

### **Changing the Input Method between Stroke and BoPoMoFo**

See “Changing the Input Method” on page 41.

## Using BoPoMoFo Input Mode

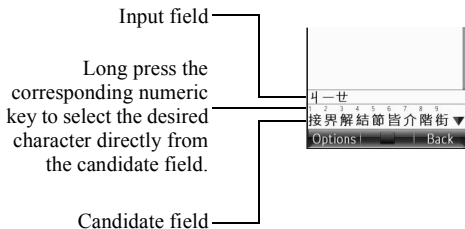

The following is an example of entering “節” for “節日歡樂”.

1. Press [4<sup>ㄐ</sup>], [0<sup>一</sup>], and [7<sup>ㄘ</sup>] (3 times quickly) to enter reading.

The candidates with the same reading are displayed in the candidate field.



2. Long press [5<sup>ㄩ</sup>] if the desired character is displayed.



3. Repeat steps 1 and 2 to complete messages.

### Tip

- When the cursor is placed after one character, the candidate field displays characters most likely to follow.
- If you want to use tone options, press [#\*] instead in step 2 until the desired character is displayed. The tone symbols are displayed in the candidate field. The candidates are displayed. Press the corresponding numeric key ([2<sup>ㄩ</sup>]).



## Using Stroke Mode

The following is an example of entering “節”.

1. Change the input mode to XT9 Stroke mode.
2. Press **3 7** **1 3** **4 9** to display the corresponding stroke for “節”.



3. Press **▼** to move the cursor to the candidate field and press **▲** **▼** **◀** **▶** to highlight the desired candidate, and then press **○**.

You can also enter the character by long pressing the corresponding numeric key.



## User Dictionary

You can create your own word list for alphabet text and XT9 Chinese input.

### English User Dictionary

#### Note

- This function is only available when “Input Language” is set to “English”.

#### To Create a New Entry

1. On the text entry screen, press [Options] and select “User Dictionary”.
2. Select “Add New Word”.
3. Enter a new word.

#### To Edit a Word in the List

1. On the text entry screen, press [Options] and select “User Dictionary”.
2. Highlight the desired word.
3. Press [Options] and select “Edit”.
4. Modify the word.

### To Delete a Word

1. On the text entry screen, press [Options] and select “User Dictionary”.
2. Highlight the desired word.
3. Press [Options] and select “Delete”.
4. Select “Yes” or “No”.

### Chinese User Dictionary

You can enter Chinese characters, alphabet, symbols and numbers for Chinese word lists.

#### *Note*

- *This function is only available when “Input Language” is set to “Traditional Chinese” or “Simplified Chinese”.*

### To Create a New Entry

1. On the text entry screen, press [Options] and select “Chinese User Dictionary”.
2. Select “Add New Word”.
3. Enter a new word.

### To Edit a Word in the List

1. On the text entry screen, press [Options] and select “Chinese User Dictionary”.
2. Highlight the desired word.
3. Press [Options] and select “Edit”.
4. Modify the entry word.

### To Delete a Word

1. On the text entry screen, press [Options] and select “Chinese User Dictionary”.
2. Highlight the desired word.
3. Press [Options] and select “Delete”.
4. Select “Yes” or “No”.

## Entering Pictograms and Symbols

1. On the text entry screen, press [Options] and select “Add Symbol”.

When “Input Language” is set to “English”, the half width symbols screen is displayed first.

When set to “Traditional Chinese” or “Simplified Chinese”, the full width symbols screen is displayed first.

To switch the symbols screen, press .

To switch to the pictogram history screen, press .

To switch the displayed pictogram list on the pictogram input screen, press .

2. Select the pictogram or symbol you wish to use and press .

### **Note**

- *Pictograms are only available for SMS/MMS messages and Notepad.*

## Using the Notepad



You can use the phrases registered in the Notepad when entering characters.

For details on creating a Notepad entry, see “Adding Phrases to the Notepad” on page 120.

1. On the text entry screen, move the cursor to the point you wish to insert the Notepad entry.
2. Press [Options] and select “Advanced”.
3. Select “Insert Note”.
4. Select the desired entry.



## Copying, Cutting and Pasting Text

1. On the text entry screen, press [Options] and select “Advanced”.
2. Select “Copy” or “Cut”.
3. Move the cursor to the first letter to be copied or to be cut, then press .
4. Move the cursor to the last letter to highlight the area, then press .
5. Move the cursor to the point you wish to paste the letters.
6. Press [Options] and select “Advanced”.
7. Select “Paste”.
8. Select the desired item.

## Insert Phonebook Entries

You can insert the entries registered in Phonebook when entering characters.

For details on creating the Phonebook entries, see “Call Manager” on page 49.

1. On the text entry screen, move the cursor to the point you wish to insert the Phonebook Entry.
2. Press [Options] and select “Advanced”.
3. Select “Insert Phonebook Entry”.
4. Select the desired Phonebook Entry.  
The selected entry is inserted.

## **Call Manager (M 8)**

You can store the phone numbers and Email addresses of your friends, family and colleagues in the Phonebook.

Your phone can store up to 1000 entries. For each entry, you can enter information including up to 5 phone numbers and 5 Email addresses. There is a limit to the number of characters that can be entered for each item. The character limit differs for the handset memory and SIM/USIM card memory.

### **Adding a New Phonebook Entry**

The amount of phone numbers that you can store to the SIM/USIM card is dependent on its capacity. Contact your service provider for details.

#### **Selecting the Storage Memory (M 8-8-3)**

You can choose either the phone or SIM/USIM card memory locations to store the new entry.

**“Call Manager”** → **“Phonebook Settings”** → **“Save to”**

1. Select from “Handset”, “SIM” or “Choice”.

#### **Tip**

- “Choice” prompts you to choose the memory every time you save a new entry.

#### **Registering a New Entry (M 8-2)**

**“Call Manager”** → **“Add New”**

If you select the “Choice” option for the memory to be used, the selection is between “To Handset” and “To SIM”.

1. Select the field you wish to fill in, and enter the relevant information.
2. Press [Save] when finished.

#### **Tip**

- To create an entry, at least one field must be filled (“Last Name”, “First Name”, “Add Phone Number” or “Add Email Address” for the handset memory; “Name”, “Add Phone Number” or “Add Email Address” for the USIM memory; “Name” or “Add Phone Number” for the SIM memory).

### **Saving an Unregistered Number (M 8-8-5)**

After a call ends, you can have the confirmation screen asking you if you wish to register the number to the Phonebook.

*“Call Manager”* → *“Phonebook Settings”* → *“Save Unregistered”*

1. Select “Incoming Call” or “Outgoing Call”.
2. Select “On” or “Off”.

### **Registering My Card (M 8-5)**

You can register and edit your own contact as with other Phonebook entries.

*“Call Manager”* → *“My Card”*

### **Searching for an Entry**

You can search for the desired entry by entering the first few letters of the name or by sorting the entries.

### **Changing the List Displayed (M 8-8-2)**

*“Call Manager”* → *“Phonebook Settings”* → *“Source”*

1. Select from “Handset”, “SIM” or “Both”.

### **Finding a Name**

*“Call Manager”* → *“Phonebook”*

1. Enter the first few letters of the name.

The first name corresponding to the entered letters is highlighted.

### **Sorting the Phonebook Entries (M 8-8-1)**

When Simplified Chinese is selected, you can change the listing order of the Phonebook entries to PinYin order or by different groups.

When another language is selected, you can change the listing order of the Phonebook entries to BoPoMoFo order or by different groups.

*“Call Manager”* → *“Phonebook Settings”* → *“View Phonebook”*

1. For Simplified Chinese, select “By PinYin” or “By Group”. For another language, select “By BoPoMoFo” or “By Group”.



### Selecting the Search Mode (M 8-8-4)

“Call Manager” → “Phonebook Settings” → “Search Mode”





1. For Simplified Chinese, select “Character Search”, “PinYin Search” or “English Search”. For another language, select “Character Search”, “BoPoMoFo Search” or “English Search”.

### Dialling from the Phonebook

“Call Manager” → “Phonebook”

1. Highlight the desired entry and press  (voice call) or  (video calling).

#### Tip

- If more than one phone number is registered for the entry, highlight the desired phone number after step 1 and press  (voice call) or  (video calling).
- You can also dial from the details screen of the Phonebook. On the details screen, select the desired phone number and press  (voice call) or  (video calling).

### Dialling a Service Phone Number (M 8-9)

Certain SIM/USIM cards contain service phone numbers that can be dialled. Contact your SIM/USIM card vendor for more information. On the Phonebook screen, “Service Dialling No.” is displayed.

“Call Manager” → “Service Dialling No.”

1. Select the desired service phone number.

#### Tip

- If the SIM/USIM card contains only one service phone number, you can dial it in step 1 by pressing .
- If no service phone number is stored in the SIM/USIM card, this menu cannot be selected.

## Sending a Message from the Phonebook

### “Call Manager” → “Phonebook”

1. Select the desired entry including the phone number or Email address you wish to use.
2. Select the desired phone number or Email address.
3. When a phone number is selected in step 2, select “Create Message”.

For further procedures, see “Creating a New Message” on page 78.

## Using Mailing Lists (M 8-7)

You can create a mailing list to send the same message to a group of recipients at once. Up to 20 groups can be registered.

### To Create a New Mailing List

#### “Call Manager” → “Message Groups” → “Add New Group”

1. Enter the group name.  
The new group name is displayed following the last group on the Group List screen.

To Add Recipients to a Group  
Up to 20 recipients can be registered in each list.

#### “Call Manager” → “Message Groups”

1. Select the desired group name.
2. Select “Assign New Entry”.
3. Select the desired entry.  
The detailed screen is displayed.
4. Select the desired phone number or Email address.

#### *Tip*

- *If you modify the entry assigned in the group, you need to re-assign it to the group. Select the entry, press [Options], then select “Re-assign Entry” in step 2.*
- *To remove an entry from the group, select the entry, press [Options], then select “Remove Entry” in step 2.*
- *To remove a group, press [Options] and select “Delete” in step 1.*

### To Send a Message Using a Mailing List

#### “Call Manager” → “Message Groups”

1. Highlight the desired group name.
2. Press [Options] and select “Create Message”.  
For further procedures, see “Creating a New Message” on page 78.

## Editing Phonebook Entries

*“Call Manager”* → *“Phonebook”*

1. Highlight the entry you wish to edit.
2. Press [Options] and select “Edit”.
3. Modify the information.
4. Press [Save] when finished.

## Adding a Thumbnail to Entries

Only Phonebook entries saved to the handset can have thumbnails attached to them.

*“Call Manager”* → *“Phonebook”*

1. Highlight the desired entry.
2. Press [Options] and select “Edit”.
3. Select “Picture”.
4. Select “Assign Picture”.
5. Select the desired picture.
6. Press [Save] when finished.

### *Note*

- *If you delete a picture in the handset memory, the corresponding thumbnail is also deleted.*
- *You can take a picture for a thumbnail by selecting “Take Picture” in step 4.*

## Assigning a Ringtone or a Ring Video Clip to Each Entry

*“Call Manager”* → *“Phonebook”*

1. Highlight the desired entry.
2. Press [Options] and select “Edit”.
3. Select “Tone/Video for Voice Call”, “Tone/Video for Video Calling” or “Tone/Video for New Message”.
4. Select “Assign Tone”.
5. Select “Preset Sounds”, “Sound Gallery”, “Video Gallery” or “Flash<sup>®</sup>”.
6. Select the desired tone or video clip.  
For details on selecting a ringtone or a ring video clip, see “Assigning a Ringtone or Ring Video Clip for an Incoming Call” on page 131.
7. Press [Save] when finished.

## Deleting Phonebook Entries

### Deleting All Phonebook Entries

*“Call Manager”* → *“Advanced”* → *“Delete All”*

1. Select from “Handset Entries”, “SIM Entries” or “Both Entries”.
2. Enter your handset code.

The default handset code is “9999”. For details on changing the handset code, see “Changing the Handset Code” on page 138.

### Deleting a Phonebook Entry

*“Call Manager”* → *“Phonebook”*

1. Highlight the desired entry.
2. Press [Options] and select “Delete”.

## Managing the Phonebook

### Copying Phonebook Entries between SIM/USIM Card and Handset

*“Call Manager”* → *“Advanced”* → *“Copy All Entries”*

1. Select “From SIM to Handset” or “From Handset to SIM”.

#### *Note*

- *When you insert the SIM/USIM card into your phone for the first time and start the Phonebook application, the confirmation screen is displayed automatically, asking you if you wish to copy or not. The number of Phonebook entries to be copied varies depending on the SIM/USIM capacity.*
- *If the memory space is not enough to save all entries, you cannot complete copying.*

## Sending a Phonebook Entry

*“Call Manager”* → *“Phonebook”*

1. Highlight the desired entry.
2. Press [Options] and select “Send Phonebook”.
3. Select “As Message”, “As Email”, “Via Bluetooth” or “Via Infrared”.

### For “As Message”

For details, see “MMS” on page 77.

### For “As Email”

For details, see “Email” on page 77.

### For “Via Bluetooth”

For details, see “Bluetooth” on page 152.

### For “Via Infrared”

For details, see “Infrared” on page 155.

## Receiving a Phonebook Entry

When the phone receives a Phonebook entry, a confirmation message is displayed in stand-by.

1. Select “Yes”.  
The received entry is saved in the Phonebook.  
Select “No” to reject.

### Tip

- For details on entering Infrared or Bluetooth wireless settings, see “Connectivity” on page 152.

## Manage Groups (M 8-4)

Different ringtones can be set for each group. If you do not change a group ringtone, the ringtone assigned in the Profiles menu is used.

*“Call Manager”* → *“Manage Groups”*

1. Highlight the desired group.
2. Press [Options] and select “Assign Tone/Video”.
3. Select “For Voice Call”, “For Video Calling” or “For New Message”.
4. Select “Assign Tone”.
5. Select “Preset Sounds”, “Sound Gallery”, “Video Gallery” or “Flash®”.
6. Select the desired tone or video clip.

For details on selecting a ringtone or a ring video clip, see “Assigning a Ringtone or Ring Video Clip for an Incoming Call” on page 131.

## Editing the Group Name

You can edit group names to be assigned to the Phonebook entries.

*“Call Manager”* → *“Manage Groups”*

1. Highlight the desired group name.
2. Press [Edit] and select “Edit Name”.
3. Modify the name.





## Speed Dial List (M 8-6)

You can set a maximum of 8 phone numbers in the Speed Dial list (p. 33).



### Setting Phonebook Entries in the Speed Dial List

To Create a New Entry for Speed Dial or Speed Mail

*“Call Manager”* → *“Speed Dial List”*

1. Select an empty entry.
2. Press [Assign].
3. Select the desired Phonebook entry.
4. Select the desired phone number.
5. Press .  
You can now also assign an Email address for Speed Mail.
6. Select the desired Email address.
7. Press .
8. Press [Save] to save the details to the selected digit key.

#### Tip

- *The nine digit keys (-) correspond to Speed Dial list numbers.*

To Change the Speed Dial List or the Speed Mail List

*“Call Manager”* → *“Speed Dial List”*

1. Select the entry you wish to change.
2. Press [Options] and select “Change”.
3. Select the “Call number” or “Mail address” you wish to modify.
4. Press [Change].
5. Select the phone number or Email address to assign.  
If you wish to remove the entry, select “Do not Assign”.
6. Press [Save].

#### Note

- *If you wish to set or edit entries in the Speed Mail List, the following procedure is also available: “Messages” → “Messaging Settings” → “Speed Mail List”*

## Memory Status

This function helps you to check the memory used in the Phonebook.

*“Call Manager”* → *“Advanced”* → *“Memory Status”*

## **Multimedia (M 7)**

### **Video Player (M 7-1)**

Video Player supports MPEG-4, 3GPP and H.264 format video files.

#### **Playing Back Video Clip Files**

**“Multimedia”** → **“Video Player”** → **“My Videos”**

1. Select “Handset Memory” or “Memory Card”.
2. Select “All Videos” or the desired playlist.
3. Select the desired file.

To pause playback, press .

To stop playback, press .

#### **Tip**

- You can control the Video Player by using the following keys:

: Increases or decreases the volume.

 (long press): Mutes.

: Jumps to the next file.



: Returns to the start of the current file.

: Jumps to the previous file.

 (long press): Fast-forwards.

 (long press): Rewinds.

The side keys can be used to change the volume level.

- Pressing  changes the size of the video display in the following order: Normal Size, Enlarge, Full screen, Widescreen and Cinema Screen. Note that this does not change the Display Size setting.
- Pressing  displays the help information.



To Play Back or Resume Playback of the Last File (M 7-1-1)

**“Multimedia”** → **“Video Player”** → **“Last Played Video”**

#### **Searching for a File to Be Played Back**

**“Multimedia”** → **“Video Player”** → **“My Videos”**

1. Select “Handset Memory” or “Memory Card”.
2. Select “All Videos” or the desired playlist.
3. Press [Options] and select “Search”.
4. Enter a few letters of the title and press .

Search results are displayed with the first matching title highlighted (non-matching titles are greyed out). Press  or  to select other matching titles. The search will match the entered text with any part of the title.

## Adding a File to the Playlist

You can add files to a playlist.

**“Multimedia”** → **“Video Player”** → **“My Videos”**

1. Select “Handset Memory” or “Memory Card”.
2. Select “All Videos” or the desired playlist.
3. Highlight the file you wish to add to the playlist.
4. Press [Options] and select “Add to Playlist”.

The playlists are displayed. For details on creating a playlist, see “Adding a New Playlist”.

5. Select the desired playlist.

The file highlighted in step 3 is saved.

To delete files from the playlist, highlight the file in the playlist and press [Options]. Then select “Delete from Playlist”.

## Adding a New Playlist

You can create a playlist and register desired files in it.

**“Multimedia”** → **“Video Player”** → **“My Videos”**

1. Select “Handset Memory” or “Memory Card”.
2. Press [Options] and select “Add New Playlist”.
3. Enter the desired playlist name.
4. Press .



### Note

- To delete the playlist, highlight the playlist and press [Options]. Then select “Delete Playlist”.

## To Play Back SD VIDEO

Video clips with the “ASF” format can also be managed with SD VIDEO.

**“Multimedia”** → **“Video Player”** → **“SD VIDEO”**

1. Select the desired file.
  - To pause playback, press .
  - To resume, press  again.
  - To delete a file, highlight the file, press [Options] and select “Delete”.

## Settings (M 7-1-5)

You can select a play mode for “Playback Pattern”, “Backlight”, “AV Mode”, “Display Size”, “Sound Effects” and “Web Link Setting” when playing back video clip files.

### “Multimedia” → “Video Player” → “Settings”

1. Select from “Playback Pattern”, “Backlight”, “AV Mode”, “Display Size”, “Sound Effects” or “Web Link Setting”.
2. Select from the following:
  - “Playback Pattern”
    - “Normal”: Plays back all files in the selected folder once and stops playback.
    - “Repeat”: Continues playback of selected file in the selected folder.
    - “Repeat All”: Continues playback of all files in the selected folder.
    - “Random”: Plays back files in the selected folder at random.
  - “Backlight”
    - “Always On”: Lit while the file is played back.
    - “Always Off”: Unlit while the file is played back even if a key is pressed.

“Normal Settings”: Works with the main backlight setting (p. 129).

- “AV Mode”  
Various AV modes are available, including “Normal”, “Effect 1”, “Effect 2”, “Effect 3” and “Effect 4”.
- “Display Size”
  - “Normal Size”: Displays the file in its original size.
  - “Enlarge”: Displays the file in an enlarged size.
  - “Full screen”: Displays the file on the full screen.
  - “Widescreen”: Displays the file on the wide screen.
  - “Cinema Screen”: Displays the file on the cinema screen.
- “Sound Effects”  
Various sound effects are available, including “Normal”, “Bass” and “Surround”.
- “Web Link Setting”
  - “On”: The browser is launched if a URL is included in the video contents.
  - “Off”: The browser is not launched even if a URL is included in the video contents.

## Downloading Video Clip Files (M 7-1-4)

**“Multimedia”** → **“Video Player”** → **“Download Videos”**

The video clip file download site is displayed.

## Streaming Player (M 7-2)

You can play back video clip files while downloading them from the mobile network.

You can also register the address of the Web site as a bookmark.

**“Multimedia”** → **“Streaming Player”**

1. Select **“Last Played”**, **“Enter URL”**, **“Favourites”**, **“Access Log”** or **“Settings”**.

**“Last Played”**: Shows the last streaming file.

**“Enter URL”**: Enter the desired address of the Web site. The browser opens, starts downloading and plays back.

**“Favourites”**: The address of the Web site is registered.

**“Access Log”**: Shows a log of the Web sites you have accessed.

**“Settings”**: The Backlight, Display Size and Sound Effect settings.

## Music Player (M 7-3)

Music Player supports MP3, MPEG-4 and 3GPP format sound files. You can access other menus while listening to sound files.



### Playing Back Sound Files

**“Multimedia”** → **“Music Player”** → **“My Music”**

1. Select the item you wish to play back.
  - **“All Music”**:  
All sound files are displayed.
  - **“Artists”**:  
The names of all artists are displayed.  
When an artist is selected, all of their albums are displayed.  
When an album is selected, all of the sound files in the selected album are displayed.
  - **“Albums”**:  
The names of all albums are displayed.  
When an album is selected, all of the sound files in the selected album are displayed.
  - **“Playlists”**:  
All playlists are displayed.  
When a playlist is selected, all of the sound files in the selected playlist are displayed.

## 2. Select the desired sound file.

To pause playback, press .

To stop playback, press  and go back to stand-by, then press  again. Select “Yes” when the pop-up appears.

### Note

- Select “My Music” to update the list of available music tracks.
- You are asked whether or not to play sounds when the Silent mode is activated.
- When “Action Settings” in the motion control setting for “Music” is set to “On” (p. 136), you can change the sound file being played back by shaking the phone sideways.
- When you receive a call, playback of the current file is paused, and you can receive the call. After the call ends, playback resumes automatically.

### Tip

- You can return to the Main menu screen while playing back the file in the background.
- You can create your playlist by listing only the desired files (p. 63).
- Sound files in both the handset and the memory card are displayed in a single view.

- When listening to music using an A2DP compatible Bluetooth handsfree device, play back the file from Music Player.

- To select the playback pattern, press [Options] and select “Playback Pattern”.

“Normal”: Plays back all files in the selected folder once and stops playback.

“Repeat”: Continues playback of selected file in the selected folder.

“Repeat All”: Continues playback of all files in the selected folder.

“Random”: Plays back files in the selected folder at random.

“Random Repeat”:  
Continues playback of files in the selected folder at random.

- While in the Music Player, the player can be controlled by using the following keys:

: Increases or decreases the volume.

 (long press): Mutes.

: Jumps to the next file.

: Returns to the start of the current file.

: Jumps to the previous file.

 (long press): Fast-forwards.

 (long press): Rewinds.

: Plays back the file in the background.



The side keys can be used to change the volume level.

To Play Back or Resume Playback of the Last File  
“**Multimedia**” → “**Music Player**”

1. Select “Last Played Music”.  
“Currently Playing” is displayed when a file is being played back.

### Searching for a File to Be Played Back

“**Multimedia**” → “**Music Player**” → “**My Music**”

1. Select “All Music” or the desired album or playlist.
2. Press [Options] and select “Search”.
3. Enter a few letters of the title and press .  
Search results are displayed with the first matching title highlighted (non-matching titles are greyed out). Press  or  to select other matching titles. The search will match the entered text with any part of the title.

### Sorting Files

“**Multimedia**” → “**Music Player**” → “**My Music**” → “**All Music**”

1. Press [Options] and select “Sort”.
2. Select “By Title”, “By Artist”, “By Album” or “By Genre”.  
Sort results are displayed.

### Adding a File to the Playlist

You can add files to a playlist.

“**Multimedia**” → “**Music Player**” → “**My Music**” → “**All Music**”

1. Highlight the file you wish to add to the playlist.
2. Press [Options] and select “Add to Playlist”.  
The playlists are displayed. For details on adding a playlist, see “Adding a New Playlist” on page 63.
3. Select the desired playlist.  
The file highlighted in step 1 is saved.  
To delete files from the playlist, highlight the file in the playlist and press [Options]. Then select “Delete from Playlist”.

#### Note

- You can store up to 99 files in one playlist. However, the total number of files stored on your phone cannot exceed 350 files.

## Adding a New Playlist

You can create your own playlist, storing and managing your favourite tracks and the order of tracks.

**“Multimedia”** → **“Music Player”** → **“My Music”** → **“Playlists”**

1. Press [Options] and select “Add New Playlist”.
2. Enter the desired playlist name.

### *Note*

- *To delete the playlist, highlight the playlist and press [Options]. Then select “Delete Playlist”.*
- *You can create up to 99 playlists.*

## Downloading Music Files

**“Multimedia”** → **“Music Player”** → **“Download Music”**





The music file download site is displayed.



## Camera (M 5)





Your phone has a built-in digital camera that allows you to take pictures and record video clips wherever you are. This section starts with basic functions and operational procedures to take, save and send pictures and video clips, followed by common and unique functions to camera and video modes.

### Launching the Camera



1. Select “Camera” from the Main menu or press .
  - When launching the camera from the Main menu:  
Select “Still Camera” or “Video Camera” from the Camera menu.  
Press  to switch between the still camera and video camera.
  - When launching the camera by pressing :  
The first time the camera is launched, the still camera is activated.  
Press  to switch between the still camera and video camera.  
The camera mode (still camera or video camera) used previously is launched from the next time.

### Taking Pictures



“Camera” → “Still Camera”

1. Press  to take the picture.  
The shutter sounds and the still image of the taken picture is displayed.
2. Press  to save the picture.  
The taken picture is saved in Gallery.  
To cancel, press .  
To send the taken picture, press  in step 2.

#### Note

- When the video camera is launched, press .
- The portrait or landscape position of the taken picture is automatically changed according to the direction the phone is held.
- When “Auto Save” is set to “On”, the taken picture is automatically saved in Gallery without pressing  again.  
When “Background Saving” is set to “On”, your phone is ready to take another picture even before saving is complete. For details, refer to “Saving a Photo in the Background” on page 74.
- When you try to send a picture that is too large in size, the picture size is resized for the message. The original sized picture is saved in Gallery.

### Tip

- You can activate the camera by long pressing  in stand-by.
- You can lock the focus by pressing  before taking a picture or recording a video clip.



## Recording Video Clips

You can record a video clip with your phone.

### “Camera” → “Video Camera”

The preview is displayed on the screen.

When in still camera mode, press  to switch to video camera mode.

1. Press .
2. To stop recording, press .
3. Select “Save”.

The video clip is saved in Gallery.

To view the preview before saving, select “Preview”.

To send the video clip, select “Send” and then select “As Message”, “Bluetooth” or “Infrared”.

### For “As Message”

For details, see “MMS” on page 77.

### For “Bluetooth”

For details, see “Bluetooth” on page 152.

### For “Infrared”

For details, see “Infrared” on page 155.

For further procedures, see “Creating a New Message” on page 78.

### Note

- You can only send video clips when “For Message” is selected for the recording time. For details, see “Selecting the Recording Time and Picture Size” on page 75.
- You can take and save up to 3 pictures while recording a video clip. Press  while recording a video clip to save a picture. Pictures are taken and saved in same size as the “Record Time/Size” setting. For details, see “Selecting the Recording Time and Picture Size” on page 75.

## Common Functions in the Still and Video Camera Modes

### Using the Digital Zoom Function

To Adjust the Zooming Ratio

1. Press  or .

Once the phone has returned to stand-by, the zoom settings return to default.



#### Note



- In still camera mode, the zoom function is not available for the picture size 2448 × 3264.

### Adjusting the Exposure

“Camera” → “Still Camera” → [Options] → “Shooting Settings” → “Exposure”

“Camera” → “Video Camera” → [Options] → “Record Settings” → “Exposure”

1. Press  (Bright) or .

  : (Dark → Normal → Bright)





Once the phone has returned to stand-by, the brightness settings return to default.

### Switching the Focus Mode

“Camera” → “Still Camera” → [Options] → “Shooting Settings” → “Focus”

“Camera” → “Video Camera” → [Options] → “Record Settings” → “Focus”

1. Select the desired option.

- : Centre Auto Focus (still camera mode only)
- : Face Auto Focus (still camera mode only)
- : Auto Focus (video camera mode only)
- : Manual Focus
- : Macro

#### Tip

- The Face Auto Focus function is available in the still camera mode. For details, see “Using Face Auto Focus” on page 70.

## Selecting the Picture or Video Quality

Select the appropriate option.

**“Camera” → “Still Camera” → [Options] → “Picture Quality”**

**“Camera” → “Video Camera” → [Options] → “Video Quality”**

1. Select the desired picture or video quality.

: Super Fine

: Fine

: Normal

### Note

- *The better quality you select, the larger the file size becomes.*

### Tip

- *“Picture Quality” is also available from the following procedure:  
“Camera” → “Still Camera Settings”*

## Using the Self-Timer

Select the appropriate option.

**“Camera” → “Still Camera” → [Options] → “Self-timer”**

**“Camera” → “Video Camera” → [Options] → “Self-timer”**

1. Select “10sec”, “5sec” or “2sec”.

When you select one of these options, the corresponding indicator (“10”, “05”, or “02”) is displayed on the screen.

Select “Off” to cancel the self-timer.

## Selecting the Storage Memory

Select the appropriate option.

**“Camera” → “Still Camera” → [Options] → “Settings” → “Save New Pictures”**

**“Camera” → “Video Camera” → [Options] → “Settings” → “Save New Videos”**

1. Select the desired location from “To Handset Memory”, “To Memory Card” or “Choice”.

### Note

- *If you select “Choice”, select the desired location every time you save.*

### Tip

- *“Save New Pictures” is also available from the following procedure:  
“Camera” → “Still Camera Settings” → “Settings”*
- *“Save New Videos” is also available from the following procedure:  
“Camera” → “Video Camera Settings” → “Settings”*

## Auto Save

You can set the phone to save pictures and video clips automatically.

**“Camera”** → **“Still Camera”** → **[Options]** → **“Settings”** → **“Auto Save”**

**“Camera”** → **“Video Camera”** → **[Options]** → **“Settings”** → **“Auto Save”**

1. Select “On” or “Off”.

### Tip

- “Auto Save” is also available from the following procedure:  
“Camera” → “Still Camera Settings” or “Video Camera Settings” → “Settings”

## Using the Help Function

**“Camera”** → **“Still Camera”** → **[Options]** → **“Help”**

**“Camera”** → **“Video Camera”** → **[Options]** → **“Help”**

## Mobile Light

### To Change the Mobile Light Mode

Set the mobile light according to your purpose.

**“Camera”** → **“Still Camera”** → **[Options]** → **“Mobile Light”**

**“Camera”** → **“Video Camera”** → **[Options]** → **“Mobile Light”**

1. Select the desired mode.

- |                     |  |
|---------------------|--|
| “On” (☀):           | The light is always on.  |
| “Auto” (☀<br>AUTO): | The light turns on if the phone detects that the conditions are dark.  |
| “Low Light” (🔍):    | (still camera mode only):<br>Select this mode for macro shooting.  |
| “Off”:              | The light is always off.<br>The corresponding indicator is displayed on the screen. Select “Off” to turn it off. |

### Displaying the Data Taken Last Time

**“Camera”** → **“Review”**

The picture or video clip taken the last time is displayed.

## Switching between the Internal and External Cameras

You can also switch between the internal (sub) camera and external (main) camera.













“Camera” → “Still Camera” → [Options] → “Shooting Settings”

“Camera” → “Video Camera” → [Options]

1. Select “Switch to Int. Camera” or “Switch to Ext. Camera”.

## Common Shortcut Keys

If multiple options exist, they switch each time you press each of the following keys.

	Still Camera	Video Camera
	Focus Lock	
	Focus	
	Switches Viewfinder between with and without indicators	Switches the display modes in the Preview screen
	Scan Barcode	
	Save New Pictures	Save New Videos
	Picture Size	
	Scene	Microphone
	Picture Quality	Video Quality
	Self-timer	
	Zoom Max/Min	
	Help	
	Mobile Light	
	ISO Film Speed	

### Note

- The “Switches the display modes” option is available in “Preview” before you save a video clip. See “Recording Video Clips” on page 65.

## Functions in Still Camera Mode

### Selecting the Picture Size

You can select the size of pictures. All taken pictures are saved in the JPEG format.

“Camera” → “Still Camera” → [Options] → “Picture Size”

1. Select the desired size.

(External Camera) 2448 × 3264/1536 × 2048/  
1080 × 1920/1200 × 1600/  
960 × 1280/768 × 1366/  
480 × 854/480 × 640/  
240 × 320/120 × 160  
(Internal Camera) 240 × 320/120 × 160

### Tip

- “Picture Size” is also available from the following procedure:  
“Camera” → “Still Camera Settings”

### Using Face Auto Focus

Faces of up to 5 people can be focused on automatically using this function.

“Camera” → “Still Camera” → [Options] → “Shooting Settings” → “Focus”

1. Select “Face Auto Focus”.

### Note

- Certain faces may not be recognised and focused on depending on the subject’s status.

### Setting ISO Sensitivity

“Camera” → “Still Camera” → [Options] → “Shooting Settings” → “ISO Sensitivity”

1. Select from “Auto”, “Auto(High)”, “100”, “200”, “400”, “800”, “1600” or “2500”.

## Continuous Shoot

There are various modes for taking continuous shots.

**“Camera” → “Still Camera” → [Options] → “Modes” → “Continuous Shoot”**

### 1. Select the desired mode.

The following continuous shoot modes are available:

“Off”:

The continuous shoots are cancelled.

“4 Pictures”/“9 Pictures” (  /  ):

Takes 4 or 9 pictures continuously.

After selecting this mode, select from “Fast”, “Normal”, “Slow” or “Manual”.

“Overlapped” (  ):

Overlaps continuous pictures into one picture and makes an afterimage.



After selecting this mode, select “Fast” or “Normal”.

### Note

- When you select “Manual” to take continuous pictures, press  manually at the desired speed.

## Taking Panorama Pictures

**“Camera” → “Still Camera” → [Options] → “Modes” → “Panorama”**

1. Select “On” and press .
2. Move the phone slowly to keep the + mark aligned with the assisting lines, and press .
3. Select “Save”.

### Note

- The image is captured automatically if the bar in the lower right turns blue before  is pressed in step 2.

### To Set the Assisting Lines

**“Camera” → “Still Camera” → [Options] → “Settings” → “Panorama Settings” → “Assisting Lines”**

1. Select “On” or “Off”.

### Note

- An error message is displayed if you move the phone fast when taking panorama pictures with this setting on.



## To Set the AE-Lock

When this setting is enabled, the exposure setting is fixed for the same brightness level.

**“Camera”** → **“Still Camera”** → **[Options]** → **“Settings”** → **“Panorama Settings”** → **“AE-Lock”**

1. Select “Disable” or “Enable”.

## Taking Long Exposure Pictures

When you take pictures of moving objects such as fireworks or take pictures in dark surroundings such as with night photographing, use this function to avoid taking pictures that are underexposed and dark.

**“Camera”** → **“Still Camera”** → **[Options]** → **“Modes”** → **“Long Exposure”**

1. Select “On” or “Off”.

When “On” is selected, the exposure time is fixed at 4 seconds.

2. Press  to take the picture.

The progress of the exposure and image processing is displayed.

The still image of the taken picture is displayed when the image processing is done.

3. Press  to save the picture.

The taken picture is saved in Gallery.

To cancel, press .

To send the taken picture, press  in step 3.

## Note

- When “Long Exposure” is set to “On” and is used during the day or in bright surroundings, the taken picture may become over exposed and stark white.
- Use a fixation tool such as a tripod when using long exposure to prevent camera shake.

## Barcode/Scan

You can read barcodes in QR code format. For details, see page 122.

**“Camera”** → **“Still Camera”** → **[Options]** → **“Barcode/Scan”** → **“Scan Barcode”**

1. Display the barcode.
2. Press [Scan].

The scanned result is displayed.

## Camera Effects

You can select from various camera effects.

**“Camera”** → **“Still Camera”** → **[Options]** → **“Modes”** → **“Camera Effects”**

1. Select from “Sepia” or “Monochrome”.

## Selecting a Frame

You can select the frame from preset patterns or Picture Gallery.

**“Camera”** → **“Still Camera”** → **[Options]** → **“Modes”** → **“Add Frame”**

1. Select “Preset Frames” or “Picture Gallery”.
2. Select the desired frame.

When “Preset Frames” is selected, the viewfinder is displayed after selecting the desired frame.

When “Picture Gallery” is selected, the selected frame is confirmed on the display after selecting the desired frame. Press **⊙** to select the frame and display the viewfinder.

### Note

- Images larger than 240 pixels [W] × 320 pixels [H] cannot be used.

## Selecting the Scene

You can select the appropriate mode by scene when you take a picture.

**“Camera”** → **“Still Camera”** → **[Options]** → **“Scene”**

1. Select from “Auto”, “Night”, “Sports”, “Text”, “Pet”, “Against Sun” or “Portrait”.

## Using the Full Screen

You can display the preview on the full screen without the soft key area and indicator area.

**“Camera”** → **“Still Camera”** → **[Options]** → **“Settings”** → **“Display Indicators”** → **“Full Viewfinder”**

### Note

- To return to the normal viewfinder, select “Normal Viewfinder”.

### Tip

- “Full Viewfinder” is also available from the following procedure:  
**“Camera”** → **“Still Camera Settings”** → **“Settings”** → **“Display Indicators”**

## Selecting the White Balance

“Camera” → “Still Camera” → [Options] → “Shooting Settings” → “White Balance”

1. Select from “Auto”, “Daylight”, “Cloud/Shade”, “Tungsten” or “Fluorescent”.

## Selecting the Shutter Sound

“Camera” → “Still Camera” → [Options] → “Settings” → “Shutter Sound”

1. Select the desired shutter sound from 6 preset patterns.

To play back the shutter sound, press [Play] in step 1.

### Note

- *Continuous Shoot uses the specialised shutter sound that cannot be changed using the above settings.*
- *The shutter sound remains active even when “General Volume” (p. 131) is set to “Silent” to prevent unauthorised use.*

### Tip

- “Shutter Sound” is also available from the following procedure:  
“Camera” → “Still Camera Settings” → “Settings”

## Saving a Photo in the Background

“Camera” → “Still Camera” → [Options] → “Settings” → “Background Saving”

1. Select “On” or “Off”.

When “On” is selected, the taken picture is automatically saved in Gallery without pressing  again, and your phone is ready to take another picture even before saving is complete.

### Note

- *When “Background Saving” is set to “On” and “Auto Save” is “Off”, press  to save the taken picture. You can take the next picture while the taken picture is being saved.*

### Tip

- “Background Saving” is also available from the following procedure:  
“Camera” → “Still Camera Settings” → “Settings”

## Setting a Function for the Send Key

You can set the method to send a taken picture when  is pressed.

“Camera” → “Still Camera” → [Options] → “Settings” → “Set Send Key”

1. Select “Short press” or “Long press”.
2. Select “As Message”, “Bluetooth”, “Via Infrared” or “IrSimple”.

### Tip

- “Set Send Key” is also available from the following procedure:  
“Camera” → “Still Camera Settings” → “Settings”

## Functions in Video Camera Mode



### Selecting the Display Size

“Camera” → “Video Camera” → [Options] → “Display Size”

1. Select “Standard” or “Expand”.

### Selecting the Recording Time and Picture Size

“Camera” → “Video Camera” → [Options] → “Record Time/Size”

1. Select “For Message” or “Extended Video”.  
“For Message” (): Limits the size to send a message depending on service providers.  
“Extended Video” (): Less than 30 minutes (depending on the memory).
2. Select the desired picture size.  
If “For Message” is selected, select “QCIF(176×144)” or “SubQCIF(128×96)”.  
If “Extended Video” is selected, select “Wide(864×480)”, “VGA(640×480)”, “QVGA(320×240)”, “HQVGA(240×176)”, “QCIF(176×144)” or “SubQCIF(128×96)”.

### **Note**

- If you select “For Message” for the recording time, the file size is limited depending on the service provider. Therefore, the quality is also limited for the setting.
- “Send” is not displayed after recording in the Extended Video mode.

### **Tip**

- “Record Time/Size” is also available from the following procedure:  
“Camera” → “Video Camera Settings”

## **Recording Video Clips with Sound**

To record a video clip with sound, the microphone needs to be activated.

“Camera” → “Video Camera” → [Options] → “Microphone”

1. Select “On” or “Off”.

### **Note**

- The microphone is already turned on in the default setting. Select “Off” to record a video clip without the sound.
- The file size of a video clip can be reduced if the sound is not recorded.

### **Tip**

- “Microphone” is also available from the following procedure:  
“Camera” → “Video Camera Settings”

## **Messages (M 4)**

Your phone allows you to send and receive text messages, multimedia messages and Emails. It is compatible with most POP3 Email providers.

### **SMS**

SMS allows you to send text messages up to 70 Chinese or 160 English characters in one SMS. If the number of characters in an SMS exceeds this limit, the message is split into several segments. For example, if a message contains 100 Chinese characters, it is sent as two SMS messages.

As a general rule, if both Chinese and English characters are used, one Chinese character is counted as two English characters. For punctuation symbols and special symbols, the character count will depend on whether it is full-width or half-width. When the symbol is full-width, it is counted as two English characters or one Chinese character. When the symbol is half-width, it is counted as one English character.

### **Long SMS**

WX-T930 supports Long SMS, which allows you to send text messages up to 335 Chinese or 765 English characters. If the number of characters in a message exceeds this number, the message is automatically delivered by MMS and the charge for an MMS is applied.

### **MMS**

With MMS, you can send images, sound or video to brighten someone's day. Messages of up to 300 KB with images, sound, or video clips can be sent and received.

### **Email**

Email allows you to send messages of up to 300 KB.

#### ***Note***

- *Some MMS functions may not always be available depending on your network. Contact your service provider for more information.*
- *Maximum message size varies depending on the restrictions set by the service provider.*

## Creating a New Message

(SMS/MMS)

“Messages” → “Create Message” → “Create Message”

(Email)

“Messages” → “Create Message” → “Create Email”

1. Select the recipient field.
2. Select the desired method to enter the recipient.
3. For MMS, enter or select the Email address or phone number from the Phonebook. For SMS, enter or select a phone number. For Email, enter or select an Email address.
  - To add multiple Email addresses or phone numbers, highlight the recipient field, press [Options], select “Edit Recipients” and select “Add Recipient”. Enter or select the Email address or phone number from the existing Phonebook.
  - To change the recipient mode, press [Options], select “Edit Recipients” and highlight the desired recipient. Press [Options] and select “Change to To”, “Change to Cc” or “Change to Bcc”.

- To add a subject, highlight the subject field and press Ⓞ. Then enter the subject in the subject entry screen and press Ⓞ.
4. Place the cursor in the message field.
  5. Press Ⓞ to display the message entry screen. Enter the message and press Ⓞ.
  6. Press [Options] and select “Send”.

“Send” is not available when no recipients are set. After the message is sent, the message is moved to the Sent box.

### Note

- When you create an SMS message, the mode is automatically switched to MMS in the following cases:
  - When an Email address is entered in the recipient field.
  - When a subject is entered.
  - When the size of entered text has exceeded the SMS size limit.

### Tip

- To send the same message to a group of recipients, select “Select Message Group” in step 2, then select the desired group name. For details on creating a mailing list, see “To Create a New Mailing List” on page 52.

## To Add a Slide Show

1. Perform steps 1 to 5 in “Creating a New Message” on page 78.
2. Press [Options] and select “Add Slide”.
3. Select “Add Slide After” or “Add Slide Before”.
4. Enter another message.

If you wish to set the duration of each slide, highlight your message or other inserted item such as a picture or sound file. Press [Options] and select “Slide Duration”, then select the desired duration. Repeat steps 2 and 3 to add more slides.

### **Tip**

- *You can create messages up to 300 KB. Each slide can contain one picture and/or one sound file or video clip.*

## To Attach Data

1. In step 6 in “Creating a New Message” on page 78, press [Options] and select “Insert Item”.
2. Select “Picture”, “Sound”, “Video”, “My Card”, “Attach Phonebook”, “Attach Appointment”, “Others” or “Flash<sup>®</sup>”.

When selecting “Attach Phonebook” or “Attach Appointment”, go to step 4.

3. Select the desired option and then select the desired file.

If you wish to attach pictures, sounds or video clips that are saved, select “Saved Pictures”, “Saved Sound” or “Saved Video”.

If you wish to take new pictures, record sounds or video clips, select “Take Picture”, “Record Voice” or “Record Video”.

4. Select the desired data.

When attaching an appointment, select the desired day including a schedule entry you wish to add and select the desired schedule entry.

### **Note**

- *When attaching JPEG files, select the appropriate resize option, as the maximum message size for sending varies depending on the service provider.*

## To Remove Attachments

1. In step 6 in “Creating a New Message” on page 78, highlight the desired item, press [Options] and then select “Remove Picture”, “Remove Sound”, “Remove Video” or “Remove Item”.



## Using the Sending Options

You can use the message sending options for each type of message.

1. Press [Options] and select “Messaging Settings”.
  - “Delivery Report” (“On”, “Off”) (SMS/MMS): Enables or disables Delivery Report when the message is successfully sent to the recipient.
  - “Expiry Time” (“Maximum”, “1 hour”, “12 hours”, “1 day”, “1 week”) (SMS/MMS): Sets Expiry Time for a message to be saved in the server.
  - “Priority” (“High”, “Normal”, “Low”) (MMS/Email): Prioritises composed messages.
  - “Read Report” (“On”, “Off”) (MMS): Confirms whether or not a report is sent notifying the sender that the message has been read.
2. Press [Options] and select “Send”.

After the message is sent, the message is moved to the Sent box.

### **Note**

- *The current message size displayed while you are creating the message is an approximation.*
- *If a message cannot be sent for some reason, the message stays in the Outbox and the “” is displayed in stand-by.*
- *To send the message in the Outbox, highlight the message, press [Options] and select “Resend”.*

### **Tip**

- *To save the message without sending, press [Options] and select “Save to Drafts” in step 6 in “Creating a New Message” on page 78.*
- *You can send the following items attached to multimedia messages. Details are given in the following sections.*
  - *Gallery data*
  - *Phonebook entry*
  - *Schedule entry created by Calendar, etc.*
- *You can use the Notepad option to help you compose messages. For details on using this option, see “Using the Notepad” on page 47.*

## **Sending a Message in the Drafts Box** (SMS/MMS)

*“Messages” → “Message” → “Drafts”*

(Email)

*“Messages” → “Email” → “Drafts”*

1. Highlight the desired message.
2. Press [Options] and select “Edit & Send”.
3. Modify the message, if necessary.
4. Press [Options] and select “Send”.  
“Send” is not available when no recipients are set.

## **Reading a Message**

Messages you receive are saved in the Inbox.

(SMS/MMS)

*“Messages” → “Message” → “Inbox”*

(Email)

*“Messages” → “Email” → “Inbox”*

1. Select a folder.
2. Select the message you wish to view.

### **Note**

- When “Action Settings” in the motion control setting for “Messaging” is set to “On” (p. 136), you can change the size of the text by shaking the phone forward or backward.

## **Storing the Phone Number of a Sender in the Phonebook**

(SMS/MMS)

*“Messages” → “Message” → “Inbox”*

(Email)

*“Messages” → “Email” → “Inbox”*

1. Select a folder.
2. Highlight the message from which you wish to store the phone number or Email address.
3. Press [Options] and select “Save Address”.

For details on creating a new Phonebook entry, see “Adding a New Phonebook Entry” on page 49.

## **Calling the Phone Number of a Sender Embedded in the Message**

(SMS/MMS)

*“Messages” → “Message” → “Inbox”*

1. Select a folder.
2. Highlight the message containing the phone number you wish to dial.
3. Press [Options] and select “Call Sender”.

## Downloading a Single MMS

*“Messages” → “Message” → “Inbox”*

1. Select a folder.
2. Highlight the message alert (  ) you wish to download.
3. Press [Options] and select “Download”.

## Replying to a Message or to All Addresses

*(SMS/MMS)*

*“Messages” → “Message” → “Inbox”*

*(Email)*

*“Messages” → “Email” → “Inbox”*

1. Select a folder.
2. Highlight the message you wish to reply to.
3. Press [Options] and select “Reply” (to sender only) or “Reply All” (to all other recipients listed in the original To or Cc lists).
4. Select “Reply” or “Reply with History”.
5. Enter the message.
6. Press [Options] and select “Send”.

“Send” is not available when no recipients are set.

## Forwarding a Message

*(SMS/MMS)*

*“Messages” → “Message” → “Inbox”*

*(Email)*

*“Messages” → “Email” → “Inbox”*

1. Select a folder.
2. Highlight the message you wish to forward.
3. Press [Options] and select “Forward”.
4. Perform steps 1 to 6 in “Creating a New Message” on page 78.

## Sorting the Messages in the List

*(SMS/MMS)*

*“Messages” → “Message” → “Inbox”*

*(Email)*

*“Messages” → “Email” → “Inbox”*

1. Select a folder.
2. Press [Options] and select “View Settings”.
3. Select “Sort”.
4. Select the desired sort option.

## Cell Broadcasts (M 4-5)

You can receive cell broadcast messages or general messages such as weather forecasts and traffic reports. This information is broadcast to subscribers in certain network areas.

This function may not be available on all mobile phone networks. Contact your service provider for more information.

### Enabling/Disabling Cell Broadcasts

*“Messages” → “Cell Broadcasts” → “Switch On/Off”*

1. Select “On” or “Off”.

### Reading Cell Broadcast Messages

*“Messages” → “Cell Broadcasts” → “Read Messages”*

1. Select the desired subject.
2. Scroll the screen to read the message.
3. Press .

### Setting Languages for Cell Broadcast Messages

*“Messages” → “Cell Broadcasts” → “Settings” → “Language”*

1. Highlight the desired language and press  to check.
2. Press [Save].

### Subscribing to Cell Broadcasts

Select the page of the cell broadcast message that you want.

*“Messages” → “Cell Broadcasts” → “Settings” → “Set Info Subjects”*

1. Select “Add/Remove”.
2. Highlight the desired subject and press  to check.
3. Press [Save].

#### *Tip*

- *If the desired subject is not in the list that appears in step 2, select “Create Subject” in step 1, then enter the subject code to add a page. For details on the subject code, contact your service provider.*

## Area Info (M 4-6)

The Area Info is the message information that operators send to subscribers in certain areas.

When you receive Area Info, the message (area code) is displayed in stand-by.

### Enabling/Disabling Area Info

“Messages” → “Area Info”

1. Select “On” or “Off”.

#### Note

- *This function may not be available on all mobile phone networks. Contact your service provider for more information.*
- *If Area Info is set to “On”, the stand-by time will decrease.*

## Messaging Settings (M 4-7)

### General Settings

“Messages” → “Messaging Settings” → “General Settings”

1. Select the item you wish to set up.
  - “Signature”:  
Enables or disables “Auto Insert”. Select “Edit” to edit current signature.

- “Auto Delete”:  
Sets whether to delete the oldest message automatically when the Inbox, Sent or Both (Inbox and Sent) is full.
- “Message List View”:  
Switches the mailbox listing.
- “Inbox Display Settings”:  
Switches the Inbox listing.
- “Sent Box Display Settings”:  
Switches the Sent box listing.
- “Scroll Unit”:  
Scroll through messages by “Single Line”, “Half Page” or “Whole Page”.
- “Message Type”:  
Sets the type of message that can be created to either SMS or MMS. When set to “Free”, the message is sent automatically either as an SMS or MMS as appropriate.  
When set to “SMS”, the functions for MMS are not available.
- “Animation View”:  
Enables or disables the animation view function. Select “On” to display an animation in the background for specific pictograms when reading messages containing them.

## SMS Settings

**“Messages”** → **“Messaging Settings”** → **“SMS Settings”**

1. Select the item you wish to set up.

- **“Delivery Report”**:  
Enables or disables Delivery Report request.
- **“Automatic Resend”**:  
Tries to resend the failed SMS message up to two times (“On” or “Off” selection).
- **“Expiry Time”**:  
This indicates the number of days and hours for which a message you send may remain undelivered to the message recipient. During this period, the message service centre will continually try to deliver the message to the recipient.
- **“Message Centre”**:  
Enter the message centre number. Up to 2 numbers can be registered.  
If you wish to enter a country code for a message to an international number, long press  until a + sign is displayed.
- **“Reply Path”**:  
Enables or disables adding a reply path to the message.

- **“Connection Type”**:  
Sets the preferred connection type (“GPRS Preferred”, “CSD Preferred”).

## MMS Settings

**“Messages”** → **“Messaging Settings”** → **“MMS Settings”**

1. Select the item you wish to set up.

- **“MMS Accounts”**:  
Select the desired account or select “Create New” to enter the following settings.  
**“Profile Name”**: MMS profile name (unique name)  
**“Proxy”**: Proxy setting for MMS  
**“Relay Server URL”**: MMS relay server
- **“Home Download”**:  
Controls the message download timing inside your network area.  
**“Always Download”**: Downloads messages immediately from the server.
- **“Always Defer”**: Defers message download.

- “Roaming Download”:  
Controls the message download timing when roaming outside of your network.
- “Always Download”:  
Downloads messages immediately from the server.
- “Always Defer”:  
Defers message download.
- “Delivery Report”:  
Enables or disables Delivery Report request.
- “Automatic Resend”:  
Tries to resend the failed MMS message up to two times (“On” or “Off” selection).
- “Delivery Report Allow”:  
Confirms whether or not a report is sent notifying the sender when you receive a message.
- “Read Report”:  
Enables or disables Read Report request.
- “Read Report Allow”:  
Enables or disables Read Report Allow when the recipient is required to inform the sender that the message has been read.
- “Expiry Time”:  
This indicates the number of days and hours for which a message you send may remain undelivered to the message recipient. During this period, the message service centre will continually try to deliver the message to the recipient.
- “Slide Duration”:  
Sets the duration of the slide.
- “Slide Auto Play”:  
Enables or disables Slide Auto Play.
- “Send File Settings”:  
Sets whether or not to send and save the file settings.
- “Max Message Size”:  
Sets the maximum message size for sending and disables sending MMS messages exceeding that size.
- “Creation Mode”:  
When set to “Free”, you can attach files of any format to the mail. When set to “Restricted”, only files in certain formats and size can be attached. The “Restricted” setting has priority over “Max Message Size”.

- “Hide Number”:  
Sets whether to show or hide the sender’s address.
- “Delivery Time” (“Immediate”, “1 hour”, “12 hours”, “1 day”, “1 week”):  
Sets the time the message is delivered after [Options] is pressed and “Send” is selected.
- “Anonymous Rejection”:  
Enables or disables the rejection of messages from anonymous senders.

#### To Activate the MMS Account Profile

1. Select “MMS Accounts”.
2. Select the desired profile you wish to activate.

## Email Settings

“Messages” → “Messaging Settings” → “Email Settings”

### To Set an Email Account

1. Select “Email Accounts” and then select “Create New”.
2. Select the item you wish to set up.

“Account Name”: Email account name (unique name)

“Incoming Server”: Server Name, User ID, Password, Port Number, APOP Authentication and Encryption for the incoming server

“Outgoing Server”: Server Name, User ID, Password, Port Number, SMTP Authentication and Encryption for the outgoing server

“Access Point”: Access point for Email

“Email Address”: Email address

“Advanced Settings”: Your Name, Signature, Download Interval, Download Configuration, Max Download Limit, Save Sent Messages





## To Activate the Email Account Profile

1. Select “Email Accounts”.
2. Select the desired profile you wish to activate.

### Speed Mail

The Speed Mail function allows you to initiate messaging from the stand-by screen faster, with fewer keys to press.



The digit keys ( to ) can be used for speed mail.

A total of 8 data items can be assigned to these keys.

For details, see page 56.

1. Press a digit key in stand-by.
2. Press  to display the message screen.

The Email address assigned to the digit key pressed in step 1 is automatically entered in the recipient field.

To add a subject, highlight the subject field and press . Then enter the subject in the subject entry screen and press .
3. Perform steps 4 to 6 in “Creating a New Message” on page 78.

## **FET Mobile Internet (M 2)**

Your phone is already configured to access FET Mobile Internet.

FET Mobile Internet is a new mobile Internet portal which is your gateway to a new world of information, games, music and services.

Because your phone uses 3G (UMTS), it has a system that is faster than previous ways of getting mobile information. Also, the connection is ‘always on’ which means there is no need to wait for dialling up. You only have to pay for the data you send or receive, not how long you’re connected.

Your phone contains a WAP/Web browser used for surfing on the mobile Internet, where you can get a lot of useful information. Normally, pages are designed for a mobile phone.

Your phone is already set up to FET Mobile Internet site for Browser/MMS Settings.

### **Main Menu**

***“FET Mobile Internet”*** → ***“Homepage”***

The FET Mobile Internet service page is displayed.

***“FET Mobile Internet”*** → ***“Bookmarks”***

See page 90.

***“FET Mobile Internet”*** → ***“Alert Inbox”***

WAP Push alerts are displayed.

***“FET Mobile Internet”*** → ***“My Saved Page”***

You can view all the screenshots that have been saved onto the handset memory.

***“FET Mobile Internet”*** → ***“Go to URL”***

The URL entry screen is displayed. You can type in the URL of a site directly.





***“FET Mobile Internet”*** → ***“Access History”***

The history of pages you have recently browsed is displayed.

***“FET Mobile Internet”*** → ***“Browser Settings”***

See page 91.

## Navigating a WAP or Web Page

- : Moves the cursor in the screen.
- : Launches the option menu if it has not been launched.  
Used to select an option from the option menu.
- : Executes the highlighted item in the screen.
- : Launches “FET Mobile Internet” by opening the browser when in stand-by.  
Moves to previous page when the browser is active.
-  (short press): Exits the browser.  
(long press): Turns off the phone.

### Note

- When “Action Settings” in the motion control setting for “Browser” is set to “On” (p. 136), you can zoom in or zoom out by shaking the phone forward or backward.
- When “Display Change” in the motion control setting for “Browser” is set to “On” (p. 136), you can change screen direction to the portrait position or landscape position according to the phone.

## Editing Bookmarks (M 2-2)

### “FET Mobile Internet” → “Bookmarks”

1. Select the desired URL, and press [Options].  
You can edit the list of Bookmarks by the following options:  
(When a bookmark is highlighted)  
“Edit”: Edits the URL address of the bookmark.  
“Add New Bookmark”:  
Creates new bookmarks.  
“Create Folder”:  
Creates new folders.  
“Open in New Tab”:  
Opens a bookmark in a new tab. (This option is available only when the options menu is opened from the browser screen.)  
“Send”:  
Sends the URL address to recipients.  
“Move”:  
Moves bookmarks to another location or into a folder.  
“Details”:  
Displays detailed information of the WAP/ Web page.  
“Delete”:  
Deletes a bookmark.  
“Delete All”:  
Deletes all bookmarks.

(When a folder is highlighted)

- “Add New Bookmark”: Creates new bookmarks.
- “Create Folder”: Creates new folders.
- “Rename Folder”: Renames the folder.
- “Move”: Moves folder and bookmarks in the folder to another location.
- “Delete”: Deletes the folder and bookmarks in the folder.
- “Delete All”: Deletes all folders and bookmarks.

(When there are no bookmarks)

- “Add New Bookmark”: Creates new bookmarks.
- “Create Folder”: Creates new folders.

## **Browser Settings (M 2-7)**

***“FET Mobile Internet” → “Browser Settings”***

- “Font Size”: Sets the font size for browsing.
- “Scroll Settings”: Sets the scroll units and turns page navigation on/off.
- “Cursor Settings”: Sets whether or not to show the cursor, and its speed.
- “Downloads”: Sets whether or not to show images or play back sound when accessing a WAP/Web page.
- “Memory Operation”: Clears Cache, Cookies, or Authentication information.
- “Security Settings”: Adjusts the security prompt level.
- “Download to”: Sets the preferred download location.
- “WAP Push”: Sets whether you need confirmation for Push messages.

“Initialise Browser”:	Initialises the browser settings and memory.
“Reset Settings”:	Resets all the browser settings to the default settings.
“Zoom Factor”:	Sets the zoom ratio for viewing a page.
“Zoom Area”:	Sets whether or not to enlarge the display area.
“SoftKey Area”:	Displays or hides the soft keys. The soft key functions are available even when they are not displayed.

### Browser Options when Online

You can use the various options of the browser.

1. After launching the browser, press [Options] and select the desired option.

“Alert Inbox”:	Displays WAP Push alerts.
“Forward”:	Goes to the next page.
“Bookmarks”:	Displays the Bookmarks menu. See page 90.
“My Saved Page”:	Displays all the browser screenshots saved in the handset memory.
“Copy Text”:	Copies the text on the WAP/ Web page.

“Reload Page”:	Reloads the WAP/Web page to get updated information.
“Go to URL”:	Allows you to type in the URL of a site directly. Handset browser will go to the WAP/Web page that you entered.
“Save Items”:	Saves items from the browsing pages.
“Convenient Functions”:	Displays functions for page operation.
“Home”:	Goes to the homepage.
“Settings”:	Displays the settings menu.
“Tab Menu”:	Displays the tab menu. (This option is available only when one window is opened and a URL link is highlighted.)
“Actual Page Width”/“Fit To Screen Width”:	Allows the browser to display in complete page mode or Virtual Screen mode.
“Help”:	Displays the browser help screen.
“Exit”:	Exits the browser.

## **Gallery (M 6)**

Gallery contains all your pictures, music and videos. You can also transmit pictures, sounds and video clips via infrared or *Bluetooth* wireless technology to other OBEX-enabled devices.

### **Picture Gallery (M 6-1)**

Pictures that are taken by your phone's camera or images that are downloaded from mobile Internet sites can be viewed, edited and organised.

#### **Viewing Pictures**

**“Gallery”** → **“Picture Gallery”**



1. Select the file you wish to view.

The selected picture is displayed.

#### **Note**

- *To switch between viewing handset or memory card content, select the first item in the options menu.*
- *When “Action Settings” in the motion control setting for “Image Viewer” is set to “On” (p. 136), you can zoom in or zoom out by shaking the phone forward or backward. You can also change the picture being viewed by shaking the phone sideways.*

#### **Tip**

- *You can scroll through your pictures with  and .*
- *To change the default view of pictures (Icon View, Inline Display, Grid View or Display Preview), press [Options], select “Manage Items” and then select “Change List View”.*

#### **Using Images as Wallpaper**

**“Gallery”** → **“Picture Gallery”**

1. Highlight the file you wish to use as wallpaper.
2. Press [Options] and select “Set as Wallpaper”.

#### **Editing Pictures**

**“Gallery”** → **“Picture Gallery”**

1. Highlight the file you wish to edit.
2. Press [Options] and select “Edit”.
3. Select “Picture Editor” or “Composite”.
4. Select the desired option.

#### **Note**

- *“Picture Editor” may not be available depending on the original picture and copyright issued.*

## Saving an Image to Phonebook Entries

You can use this option only for pictures saved in the handset memory.

**“Gallery”** → **“Picture Gallery”**

1. Highlight the file you wish to add to Phonebook.
2. Press [Options] and select “Save to Phonebook”.  
To save as a new entry, select “As New”.  
To overwrite, select “As New Detail” and then select the data you wish to save.  
For details on entering a name, see “Adding a New Phonebook Entry” on page 49.

## Downloading Picture Files

**“Gallery”** → **“Picture Gallery”** → **“Download More”**

The picture file download site is displayed.

### Tip

- For other option menus, see “Common Option Menus” on page 97.

## Video Gallery (M 6-2)

Video clips that are recorded by your phone’s video camera or video clips that are downloaded from mobile Internet sites can be viewed and organised.

### Playing Back Video Clip Files

**“Gallery”** → **“Video Gallery”**

1. Select the file you wish to play back.  
To pause playback, press ⏸.  
To resume, press ⏪ again.  
To stop playback, press ⏹.

### Note

- To switch between viewing handset or memory card content, select the first item in the options menu.

### Using a Video Clip as a Ring Video Clip

You can set your video clip to play back when the phone rings.

**“Gallery”** → **“Video Gallery”**

1. Highlight the desired video clip.
2. Press [Options] and select “Set as Ring Video”.

### Tip

- For other option menus, see “Common Option Menus” on page 97.

## Downloading Video Clip Files

**“Gallery”** → **“Video Gallery”** → **“Download More”**

The video clip file download site is displayed.

## Sound Gallery (M 6-3)

The downloaded sound files and the AMR data recorded by Voice Recorder are managed in Sound Gallery. The default ringtones are not contained within Sound Gallery. Only the sound files that can be played back on the phone are stored in Sound Gallery.

### Playing Back Sound Files

**“Gallery”** → **“Sound Gallery”**

1. Select the file you wish to play back.

To stop playback, press .

### Note

- *Playback may not be available for some sound files. A2DP function is available only when playing back from music player and is not available when playing back from Gallery.*
- *To switch between viewing handset or memory card content, select the first item in the options menu.*

## Using the Sound Files as a Ringtone

**“Gallery”** → **“Sound Gallery”**

1. Highlight the file you wish to use as a ringtone.
2. Press [Options] and select “Set as ringtone”.

### Tip

- *For other option menus, see “Common Option Menus” on page 97.*

## Downloading Sound Files

**“Gallery”** → **“Sound Gallery”** → **“Download More”**

The sound file download site is displayed.

## Themes (M 6-4)

You can easily customise the display by using the theme files.

### Note

- *Preset themes are not included in “Themes” in “Gallery”.*

## Viewing Previews

**“Gallery”** → **“Themes”**

1. Highlight the theme file you wish to preview.
  2. Press .
- The selected theme file is displayed.

### Note

- *To switch between viewing handset or memory card content, select the first item in the options menu.*



## Setting a Theme

“Gallery” → “Themes”

1. Select the desired theme file.

The selected theme file is set as the default theme.

### Tip

- *Even after a theme is set, you can set a wallpaper regardless of the set theme. In this case, the other items follow the set theme.*
- *For other option menus, see “Common Option Menus” on page 97.*

## Downloading Theme Files

“Gallery” → “Themes” → “Download More”

The theme file download site is displayed.

## Flash<sup>®</sup> (M 6-6)

### Playing Back Flash<sup>®</sup> Files

“Gallery” → “Flash<sup>®</sup>”

1. Select the file you wish to play back.

To stop playback, press .

### Note

- *Flash<sup>®</sup> files of up to 150 KB can be played back.*

### Using Flash<sup>®</sup> Files as Wallpaper

“Gallery” → “Flash<sup>®</sup>”

1. Highlight the file you wish to use as wallpaper.
2. Press [Options] and select “Set as Wallpaper”.

### Using the Flash<sup>®</sup> Files as a Ringtone

“Gallery” → “Flash<sup>®</sup>”

1. Highlight the file you wish to use as a ringtone.
2. Press [Options] and select “Set as ringtone”.

## Other Documents (M 6-7)

Some types of files are stored in the Other Documents folder of the phone. You can edit and use these files as Gallery data.

### Opening a Document File

**“Gallery” → “Other Documents”**

1. Select the desired file.

#### *Note*

- *To switch between viewing handset or memory card content, select the first item in the options menu.*

#### *Tip*

- *For other option menus, see “Common Option Menus”.*

## Common Option Menus

For using the desired file type, first select the appropriate folder in the Gallery menu. Gallery contains the following folders.

**“Gallery” → “Picture Gallery”**

**“Gallery” → “Video Gallery”**

**“Gallery” → “Sound Gallery”**

**“Gallery” → “Themes”**

**“Gallery” → “Java™ Gallery”**

**“Gallery” → “Flash®”**

**“Gallery” → “Other Documents”**

### Activating Files with Copyright Protection (DRM)

Some pictures, sound files, video clips, Flash® files and theme files have a digital copy protection program, which is called DRM (Digital Rights Management). You need to activate the digital licence permission to open the files. Files protected with DRM are displayed with .

1. Select the appropriate folder for the desired file type.
2. Highlight the file you wish to activate.
3. Press [Options] and select “Get Contents Key”.

### **Note**

- *Some pictures with DRM may not be opened even when an attempt is made to activate it.*

### **Sending Gallery Data**

For details on Infrared and *Bluetooth* wireless technology, see “Connectivity” on page 152.

1. Select the appropriate folder for the desired file type (p. 97).
2. Highlight the desired file.
3. Press [Options] and select “Send”.
4. Select “As Message”, “As Email”, “Bluetooth” or “Infrared”.

#### **For “As Message”**

For details, see “MMS” on page 77.

#### **For “As Email”**

For details, see “Email” on page 77.

#### **For “Bluetooth”**

For details, see “Bluetooth” on page 152.

#### **For “Infrared”**

For details, see “Infrared” on page 155.

### **Note**

- *Pictures/Sounds/Video clips/Themes/Flash® files/ Other Documents data protected by copyright cannot be sent attached to a message, with the exception of Separate Delivery files.*
- *When pairing, you need to enter your passcode when establishing contact with a Bluetooth wireless technology enabled device for the first time.*

### **Receiving Gallery Data**

When the phone receives Gallery data, a confirmation message is displayed in stand-by.

1. Select “Yes”.

The received data is saved in the corresponding Gallery folder.

### **Tip**

- *For details on Infrared or Bluetooth wireless settings, see “Connectivity” on page 152.*

## Using Gallery Data

You can copy, move, sort, rename, and delete the saved Gallery data.

1. Select the appropriate folder for the desired file type (p. 97).
2. Highlight the desired file.
3. Press [Options] and select “Manage Items”.
4. Select the desired option.

“Sort”: Sorts files according to a specific sequence.

“Rename”: Renames the file or folder.

“Create Folder”: Creates a new folder.

“Change List View”:

Changes the list view.

“Check All”: Selects all files in the list.

### Note

- “Manage Items” is not available for “Java™ Gallery”.

### To Delete the File

1. Select the appropriate folder for the desired file type (p. 97).
2. Highlight the desired file.
3. Press [Options] and select “Delete”.

### To See the Gallery Details

1. Select the appropriate folder for the desired file type (p. 97).
2. Highlight the file you wish to view the details of.
3. Press [Options] and select “Details”.

### Selecting Multiple Files

You can select more than one item from Gallery for moving, copying, managing and deleting.

### Note

- The following procedure applies when entries other than “Download More” are highlighted.

1. Select the appropriate folder for the desired file type (p. 97).
2. Highlight the file you wish to select.
3. Press [Check].
4. Repeat steps 2 and 3 until you select all the desired files.

### Tip

- To remove the check, highlight the file again and select “Uncheck” in step 3.
- If you wish to unselect all, select “Manage Items” in step 3 and select “Uncheck All”.

## Memory Status (M 6-8)

This function helps you to check the memory status of the handset memory or memory card. Memory status covers the following:

Handset Memory: Pictures, Videos, Sound Gallery, Themes, Java™ Gallery, Flash®, Other Documents, Others, Total and Free

Memory Card: Pictures, Videos, Sound Gallery, Themes, Flash®, Other Documents, Others, Total and Free

***“Gallery” → “Memory Status”***

1. Select “Handset Memory” or “Memory Card”.

## Java™ (M 1)

### Java™ Gallery (M 1-1)

The list of Java™ applications is displayed.



Downloaded applications are displayed in order starting from the latest one.

#### Downloading Applications

*“Java™” → “Java™ Gallery” → “Download More”*

1. Select the desired application.

Before downloading the application you are asked to confirm what you are about to receive. After checking the information on the confirmation screen, the application can be downloaded.

2. Press  to start downloading.
3. Press  when finished.

#### *Note*

- *User authentication may be required before downloading the application on some information screens.*

### Executing Applications

*“Java™” → “Java™ Gallery”*

1. Select the title of the application you wish to execute.

The selected application is executed. When using network connection type applications, connection to the network can be selected.

2. To end the application, press  and select “End”.

### Setting as a Screensaver for the Display

*“Java™” → “Java™ Gallery”*

1. Highlight the file you wish to use as a screensaver.
2. Press [Options] and select “Set as Screensaver”.

## Setting Permission

You can set permission for selected Java™ applications.

“Java™” → “Java™ Gallery”

1. Highlight the desired Java™ application.

2. Press [Options] and select “Permission”.

3. Select one of the following options:

- “Phone Call”: Sets permission to make voice calls.
- “Network Access”: Sets permission to access the network.
- “Messaging”: Sets permission to perform SMS messaging.
- “Autorun”: Sets permission to perform the Autorun function.
- “Bluetooth Connection”: Sets permission to connect via *Bluetooth*.
- “Read User Data”: Sets permission to read user data, such as Phonebook entries, mailbox (Inbox) and Gallery data.
- “Write User Data”: Sets permission to write entries in your phone, such as Phonebook entries, mailbox (Inbox) and Gallery data.

“Use Multimedia”: Sets permission to use the multimedia recording.

4. Select one of the following options:

- “Always Ask”: The confirmation message is displayed every time network access is executed.
- “Ask Once”: The confirmation message is displayed the first time network access is executed.
- “Never Ask”: The confirmation message is not displayed while execution of network access is authorised.
- “No”: Execution of network access is not authorised.

### Note

- Options displayed in step 4 depend on the item selected in step 3.
- To clear all the permission settings, select “Reset” in step 3.
- “Bluetooth Connection”, “Read User Data” and “Write User Data” may not be available for some Java™ applications in step 3.

## Viewing Application Information

You can check the information of Java™ applications.

*“Java™” → “Java™ Gallery”*

1. Highlight the desired Java™ application.
2. Press [Options] and select “Details”.

## Deleting an Application

You can delete an application in the folder.

*“Java™” → “Java™ Gallery”*





1. Highlight the desired Java™ application.
2. Press [Options] and select “Delete”.

## Java™ Settings (M 1-2)

### Application Volume (M 1-2-1)

You can set the volume of the application such as the sound effect to one of the five levels or silent. When the profile is set to “Silent”, the “General Volume” setting (p. 131) has priority.

*“Java™” → “Java™ Settings” → “Application Volume”*

1. Press  (or ) to increase the volume or press  (or ) to decrease the volume and then press .

### Backlight

*“Java™” → “Java™ Settings” → “Backlight” → “Switch On/Off”*

1. Select from “Always On”, “Always Off” or “Normal Settings”.
  - “Always On”: Lit while the application is operated.
  - “Always Off”: Unlit while the application is operated even if a key is pressed.
  - “Normal Settings”: Works with the main backlight setting (p. 129).



## To Set the Blinking Operation

This setting enables the backlight to be controlled by the application. If set to “Off”, the backlight cannot be turned on from the application.

“Java™” → “Java™ Settings” → “Backlight” → “Blink”

1. Select “On” or “Off”.

## Vibration (M 1-2-3)

When the vibrator is set in the application, you can choose whether the operation is enabled or disabled.

“Java™” → “Java™ Settings” → “Vibration”

1. Select “On” or “Off”.

## Calls & Alarms (M 1-2-4)

The priority of incoming calls, alarms and *Bluetooth* connection while an application is operating can be set.

“Java™” → “Java™ Settings” → “Calls & Alarms”

1. Select “Voice Call”, “Video Calling”, “Incoming Message”, “Alarm” or “Push Request”.

2. Select the desired method.

- “Call Priority”, “Message Priority”, “Alarm Priority” or “Request Priority”:

The application is suspended automatically, and you can receive a call or a message, the alarm will sound or *Bluetooth* connection will start.

After finishing the call or receiving the message, or when the alarm or *Bluetooth* connection ends, the suspend indicator (🔌) is displayed letting you know there is a suspended application.

- “Call Notice”, “Message Notice”, “Alarm Notice” or “Request Notice”:

The information is displayed on the first line of the screen while the application continues. If you press , the application is suspended, and you can receive the call. After finishing the call or receiving the message, the suspend indicator (🔌) is displayed letting you know there is a suspended application.

## Screensavers

You can download screensaver applications for the stand-by screen and set the time period for the screensaver to activate.

**“Java™” → “Java™ Settings” → “Java™ Wallpaper” → “Switch On/Off”**

1. Select “On” or “Off”.

To Set the Activation Time

**“Java™” → “Java™ Settings” → “Java™ Wallpaper” → “Activation Time”**

1. Enter an activation time from 1 to 10 seconds (in 2 digits) using the keypad.

To Set the Suspend Time

**“Java™” → “Java™ Settings” → “Java™ Wallpaper” → “Suspend Time”**

1. Set the desired time period from “after 15 min.” to “after 6 hours”.

## Surround (M 1-2-6)

1. You can set surround sound for Java™ applications.

**“Java™” → “Java™ Settings” → “Surround”**

1. Select “On” or “Off”.

## Default Settings (M 1-2-8)

**“Java™” → “Java™ Settings” → “Set to Default”**

1. Enter your handset code.

The default handset code is “9999”. For details on changing the handset code, see “Changing the Handset Code” on page 138.

## Clearing All Memory (M 1-2-9)

**“Java™” → “Java™ Settings” → “Memory All Clear”**

1. Enter your handset code.

The default handset code is “9999”. For details on changing the handset code, see “Changing the Handset Code” on page 138.

## Java™ Information (M 1-3)

**“Java™” → “Java™ Information”**

The information about the licences belonging to Java™ is displayed.

## **Organiser (M 3)**

### **Calendar (M 3-1)**

The calendar allows you to easily schedule appointments.

These entries can also be sent via *Bluetooth* wireless technology to a PC to share the same schedules. When you exchange entries with other devices, the date and time displayed may be different to that of the original data depending on the data format of the receiving device.

#### **Creating a New Entry**

*“Organiser”* → *“Tools 1”* tab → *“Calendar”*

1. Select the desired day to which you want to add an event.
2. Select “Add New Entry”.
3. Enter the subject.
4. Enter the start date and time.
5. Select the desired category.
6. Select the reminder time.  
When selecting “Other”, enter the desired reminder date and time.
7. Press [Save].

#### **Note**

- *If the date and time settings have not been entered, the date and time entry screen is displayed (p. 134).*
- *The reminder will not sound when the profile is set to “Silent”, but will sound when “General Volume” (p. 131) is set to “Silent”.*
- *You can display the Stamp screen by pressing [2<math>\rightarrow</math>] in the monthly and 3-month calendar view. Select the desired category.*

#### **To Change the Settings**

1. Select the item you wish to change in the New Entry screen.
  - “Reminder”: Sets options including “Reminder Time”, “Assign Tone/Video” and “Duration” for the reminder.
  - “Repeat”: Sets the number of times the reminder sounds.
  - “Location”: Sets the location for the schedule entry.
  - “Description”: Enables entering a memo for the schedule entry.
  - “Secret”: Sets to show or hide the schedule entry. Set to “On” to make the data secret or select “Off” to leave it as it is.

## Viewing a Schedule Entry

“Organiser” → “Tools 1” tab → “Calendar”

1. Select the day you wish to view.
2. Select the desired entry.

### To Search by Date

1. In any view, press [Options] and select “Go to”.
2. Select “Today” to display today or “Enter Date” to enter the desired date.

### Tip

- You can control the view by using the following:  
Monthly, 2-month, 3-month or 6-month view

: Displays the previous month or previous screen.

: Displays the next month or next screen.

: Displays the Help screen.

: Displays the Stamp screen (monthly and 3-month view only).

: Displays the Set Colour screen.

: Moves the cursor to today.

: Displays the Find (By Subject) screen.

: Displays the Go to (Enter Date) screen.

: Displays the Find (By Category) screen.

: Moves the cursor to left (the previous day) or to right (the next day).

: Moves the cursor upward (last week) or downward (next week).

### Weekly view

: Displays the previous week.

: Displays the next week.

: Displays the Help screen.

: Displays the Set Colour screen.

: Moves the cursor to today.

: Displays the Find (By Subject) screen.

: Displays the Go to (Enter Date) screen.

: Displays the Find (By Category) screen.

: Moves the cursor to left (the previous day) or to right (the next day).

: Moves the cursor upward (the previous hour) or downward (the next hour).

## Setting a Colour

You can highlight a date or days of the week with seven colour options.

For Date Colour

**“Organiser”** → **“Tools 1” tab** → **“Calendar”**

1. Press [Options] and select “Calendar Settings”.
2. Select “Set Colour”.
3. Select “By Date”.
4. Select the desired colour.

### Note

- To reset the colour setting, select “Reset Colour” in step 3.

For Days of the Week Colour

**“Organiser”** → **“Tools 1” tab** → **“Calendar”**

1. Press [Options] and select “Calendar Settings”.
2. Select “Set Colour”.
3. Select “By Week” and then select days of the week you wish to colour.
4. Select the desired colour.

### Tip

- The selected date/days are also highlighted on the calendar on the stand-by screen.

### Note

- If the same date is set with both a date colour and a day of the week colour, the date is highlighted in the date colour.
- Up to 100 days can be set for the highlights.

## Setting a Holiday

You can set personal holidays in the calendar.

**“Organiser”** → **“Tools 1” tab** → **“Calendar”**

1. Press [Options] and select “Calendar Settings”.
2. Select “Set Holiday”.
3. Enter the name.
4. Enter the date.
5. Select the desired frequency.
6. Press [Save].

## Finding a Schedule Entry

You can search for a schedule entry by subject or category.

### To Search by a Subject

**“Organiser”** → **“Tools 1” tab** → **“Calendar”**

1. In any view, press [Options] and select “Find”.
2. Select “By Subject”.
3. Enter a few letters of the subject.  
Search results are displayed in time order.

### To Search by a Category

**“Organiser”** → **“Tools 1” tab** → **“Calendar”**

1. In any view, press [Options] and select “Find”.
2. Select “By Category”.
3. Select a desired category.  
Search results are displayed in time order.

## Editing a Schedule Entry

**“Organiser”** → **“Tools 1” tab** → **“Calendar”**

1. Select the day you wish to edit.
2. Highlight the entry you wish to edit, press [Options], then select “Edit”.
3. Select the desired item and modify the entry.
4. Press [Save].

## Deleting Schedule Entries

1. In any view, press [Options] and select “Delete”.
2. Select the desired option.
  - “This Appointment” (daily view):  
Deletes the selected entry.
  - “All This Day”:  
Deletes all entries for the selected day.
  - “All This Month” (monthly and 3-month view):  
Deletes all entries for the selected month.
  - “Last Two Months” (2-month view):  
Deletes all entries for the selected two months.
  - “All This Week” (weekly view):  
Deletes all entries for the selected week.
  - “Up to Last Month” (monthly and 3-month view):  
Deletes all entries before the selected month.
  - “Up to Last Week” (weekly view):  
Deletes all entries before the selected week.

“All This 6Months” (6-month view):  
Deletes all entries for the selected six months.

“All Appointments”:  
Deletes all entries in this application.

### **Sending a Schedule Entry**

“Organiser” → “Tools 1” tab → “Calendar”

1. Select the day including schedule entries you wish to send.
2. Highlight the entry you wish to send, press [Options], then select “Send”.
3. Select “As Message”, “As Email”, “Via Bluetooth” or “Via Infrared”.

For “Via Bluetooth”

For details, see “Bluetooth” on page 152.

For “Via Infrared”

For details, see “Infrared” on page 155.

#### **Note**

- *When pairing, you need to enter your passcode when establishing contact with a Bluetooth wireless technology enabled device for the first time.*

### **Receiving a Schedule Entry**

When the phone receives a schedule entry, a confirmation message is displayed in stand-by.

1. Select “Yes”.

The received entry is saved in the Calendar. Select “No” to reject.

#### **Tip**

- *For details on entering Infrared or Bluetooth wireless settings, see “Connectivity” on page 152.*

### **Viewing the Memory Status**

1. In any view, press [Options] and select “Memory Status”.

## Alarms (M 3-2)

### Setting the Alarms

The alarm function allows you to be alerted at a specified time.

Note that you need to set the current date and time before setting the alarm function if it has not been done already.

**“Organiser”** → **“Tools 1” tab** → **“Alarms”**

1. Select the blank line (--:--) you wish to set an alarm to.
2. Enter the desired time.
3. Press [Save].

### To Change the Settings

1. Select the item you wish to change in the Set Alarm screen.
  - “Subject”:  
Sets the subject for the alarm setting.
  - “Repeat”:  
Sets the number of times the alarm sounds.
  - “Assign Tone/Video”:  
Assigns a tone or video clip file to the alarm.
  - “Snooze”:  
Sets the snooze option.

- “Alarm Volume”:  
Sets the desired volume.  
The alarm will not sound when “Alarm Volume” is set to “Silent”.
- “Vibration”:  
Sets the vibration pattern of the alarm.  
For details on selecting a vibration, see “Vibration” on page 133.
- “Duration”:  
Sets the duration of the alarm.

### Resetting an Alarm

**“Organiser”** → **“Tools 1” tab** → **“Alarms”**

1. Highlight the alarm you wish to reset.
2. Press [Options] and select “Reset Alarm”.

### Resetting All Alarms

**“Organiser”** → **“Tools 1” tab** → **“Alarms”**

1. Press [Options] and select “Clear All”.



## Setting for Silent Profile

You can set whether to sound the alarm when the profile is set to “Silent”.

*“Organiser” → “Tools 1” tab → “Alarms” → “Settings” → “For Silent Profile”*

1. Select “Ring” or “Do not Ring”.

## Setting the Alarm to the World Clock Time

You can set the alarm to sound according to the time of the World Clock.

*“Organiser” → “Tools 1” tab → “Alarms” → “Settings” → “Link to World Clk”*

1. Select “On” or “Off”.

## Tasks (M 3-3)

You can register your schedule as task entries for a given date or time.

### Creating a New Entry

*“Organiser” → “Tools 1” tab → “Tasks”*

1. Select “Add New Entry”.
2. Enter the subject.
3. Enter the due date and time.
4. Press [Save].

### Note

- *If the date and time settings have not been entered, the date and time entry screen is displayed (p. 134).*

### To Select the Reminder Time

1. On the New Entry screen, select “Reminder”.
2. Select “Reminder Time”.
3. Select the reminder time.  
When selecting “Other”, enter the desired reminder date and time.

### To Change the Type of Alarm Tone or Video Clip File

1. On the New Entry screen, select “Reminder”.
2. Select “Assign Tone/Video”.
3. Select “Preset Sounds”, “Sound Gallery”, “Video Gallery” or “Flash<sup>®</sup>”.
4. Select the desired tone or video clip file.  
For details on selecting a ringtone or a ring video clip, see “Assigning a Ringtone or Ring Video Clip for an Incoming Call” on page 131.

### To Change the Duration of Alarm Tone or Video

1. On the New Entry screen, select “Reminder”.
2. Select “Duration”.
3. Select the desired duration.

### To Set the Alarm Volume

#### **“Organiser”** → **“Tools 1” tab** → **“Tasks”**

1. Press [Options] and select “Alarm Settings”.
2. Select “Alarm Volume”.
3. Press ▲ (or ▶) to increase the volume or press ▼ (or ◀) to decrease the volume and then press ○.

### To Set the Vibration

#### **“Organiser”** → **“Tools 1” tab** → **“Tasks”**

1. Press [Options] and select “Alarm Settings”.
2. Select “Vibration”.
3. Select “On”, “Link to Sound” or “Off”.

### To Set for the Silent Profile

You can set whether to sound the alarm when the profile is set to “Silent”.

#### **“Organiser”** → **“Tools 1” tab** → **“Tasks”**

1. Press [Options] and select “Alarm Settings”.
2. Select “For Silent Profile”.
3. Select “Ring” or “Do not Ring”.

### To Set the Priority

1. On the New Entry screen, select “Priority”.
2. Select “Normal”, “High” or “Low”.

### To Change the Description

1. On the New Entry screen, select “Description”.
2. Enter a memo for the task entry.

### To Make the Entry Secret

1. On the New Entry screen, select “Secret”.
2. Select “On” to make the data secret or select “Off” to leave it as it is.

## To Unlock the Secret Settings Temporarily

You can show the secret tasks temporarily.

**“Organiser”** → **“Tools 1” tab** → **“Tasks”**

1. Highlight the desired entry.
2. Press [Options] and select “Unlock Temporarily”.

### Note

- *Once the phone has returned to stand-by, the temporarily unlocked tasks are reset as secret data.*

## Making the Entry Completed or Uncompleted

**“Organiser”** → **“Tools 1” tab** → **“Tasks”**

1. Highlight the desired entry.
2. Press [Done].

To make the entry incomplete, press [Not Yet].

## Finding a Task Entry

### To Search by a Subject

**“Organiser”** → **“Tools 1” tab** → **“Tasks”**

1. Press [Options] and select “Find”.
2. Select “By Subject”.
3. Enter a few letters of the subject and press Ⓞ.

Search results are displayed in time order.

### To Search by a Due Date

**“Organiser”** → **“Tools 1” tab** → **“Tasks”**

1. Press [Options] and select “Find”.
2. Select “By Due Date”.
3. Enter a desired due date and press Ⓞ.

Search results are displayed in time order.

## Sending a Task Entry

**“Organiser”** → **“Tools 1” tab** → **“Tasks”**

1. Highlight the task entry you wish to send.
2. Press [Options] and select “Send”.
3. Select “As Message”, “As Email”, “Via Bluetooth” or “Via Infrared”.

### For “Via Bluetooth”

For details, see “Bluetooth” on page 152.

### For “Via Infrared”

For details, see “Infrared” on page 155.

### Note

- *When pairing, you need to enter your passcode when establishing contact with a Bluetooth wireless technology enabled device for the first time.*

## Viewing the Memory Status

*“Organiser”* → *“Tools 1” tab* → *“Tasks”*

1. Press [Options] and select “Memory Status”.

## Deleting Entries

*“Organiser”* → *“Tools 1” tab* → *“Tasks”*

1. Highlight the desired entry.
2. Press [Options] and select “Delete”.
3. Select the desired option.
  - “This Task”: Deletes the selected entry.
  - “All Completed Tasks”: Deletes all checked entries.
  - “All Tasks”: Deletes all entries.

## Calculator (M 3-4)

The calculator function performs the 4 arithmetic calculations using up to 12 digits.

*“Organiser”* → *“Tools 1” tab* → *“Calculator”*



Key operations for calculation are as follows:

To enter a decimal point, press  $\boxed{.}$ .

To clear the entered number or function, press  $\boxed{C}$ .

To do the calculations, press  $\boxed{=}$ .

To start a new calculation, press  $\boxed{C}$ .

## Rate Conversion

You can also use the calculator as a currency calculator to convert from/to a home currency using a conversion rate that you enter.

To Set a Currency Conversion Rate

**“Organiser”** → **“Tools 1” tab** → **“Calculator”** → **[Options]** → **“Currency Converter”** → **“Exchange Rate”**

1. Select “Domestic” or “Foreign”.
2. Enter the domestic or foreign currency.

To Convert a Value

**“Organiser”** → **“Tools 1” tab** → **“Calculator”**

1. Enter the value to be converted.
2. Press [Options] and select “Currency Converter”.
3. Select “Convert to Domestic” or “Convert to Foreign”.

## Expenses Memo (M 3-5)

You can record an expenses memo with pre-defined or edited categories.

**Recording in the Expenses Memo (M 3-5-1)**

**“Organiser”** → **“Tools 1” tab** → **“Expenses Memo”** → **“Add New Expense”**

1. Enter the expenses using the digit keys.
2. Select the desired category.

Expenses memo is registered.

**Viewing Totals (M 3-5-2)**

**“Organiser”** → **“Tools 1” tab** → **“Expenses Memo”** → **“Totals”**

Recorded expenses are displayed on the screen.

To Change Category

1. In the total view, highlight the desired item.
2. Press [Change].
3. Select the desired category.

### To Change Amount

1. In the total view, highlight the desired item.
2. Press [Options] and select “Change Amount”.
3. Enter the desired amount using the digit keys.

### To Delete a Recorded Item or All Items

1. In the total view, highlight the desired item.
2. Press [Options] and select “Delete Item” or “Delete All”.

### Editing the Category Name (M 3-5-3)

*“Organiser” → “Tools 1” tab → “Expenses Memo”  
→ “Edit Category”*

1. Select the desired category name.
2. Modify the name.

### Stopwatch (M 3-1-1)

You can store 4 lap times when using the stopwatch function.

*“Organiser” → “Tools 2” tab → “Stopwatch”*

1. Press [Start].  
Press [LAP] to view the lap time before the stopwatch stops. Last 4 lap times are saved.
2. Press [Stop].

#### *Tip*

- *You can save a record of lap times and the stop time by pressing [Options] and selecting “Save to Notepad”.*

### Resetting the Time

1. After stopping the stopwatch, press [Options] and select “Reset”.

## Countdown Timer (M 3--2)

*“Organiser”* → *“Tools 2” tab* → *“Countdown Timer”*

1. Enter the time to count.  
You can set the time from 1 second to 60 minutes.
2. Press [Start].  
Press [Suspend] to pause the countdown.  
Press [Resume] to continue counting.
3. When the countdown has finished, press [Stop] and then press [Start] to start the countdown again.



### Editing the Countdown Time

1. In the countdown start screen, press [Options] and select “Edit”.
2. Modify the desired time.

## World Clock (M 3--3)

### Setting the Time Zone

*“Organiser”* → *“Tools 2” tab* → *“World Clock”*

1. Press [Edit] and select “Set Time Zone”.  
The current time zone is indicated by red line on the world map.
2. Press  or  to change the time zone.
3. Press [Accept].

### To Set the Custom Time Zone

*“Organiser”* → *“Tools 2” tab* → *“World Clock”*

1. Press [Edit] and select “Set Time Zone”.
2. Press [Custom].
3. Enter the desired city name and time difference.

### Setting Daylight Saving

*“Organiser”* → *“Tools 2” tab* → *“World Clock”*

1. Press [Edit] and select “Daylight Saving”.
2. Select “On” or “Off”.

## Hour Minder (M 3--4)

Hour Minder function informs you of the time by sounding a tone.

**“Organiser”** → **“Tools 2” tab** → **“Hour Minder”**

1. Select “Switch On/Off”.
2. Select “On” or “Off”.
3. Select “Select Time”.
4. Select the desired time.
5. Press [OK].
6. Press [Save].

To Change the Settings

**“Organiser”** → **“Tools 2” tab** → **“Hour Minder”**

1. Select “Advanced”.
2. Select the item you wish to change.

“Assign Tone/Video”:

Assigns a tone or video clip file.

“Volume”:

Sets the volume.

“Vibration”:

Sets the vibration.

“Duration”:

Sets the duration.

“For Silent Profile”:

Sets whether to sound a tone when the profile is set to “Silent”.

“Link to World Clk”:



Sets to sound a tone according to the time of the World Clock.

## Document Viewer (M 3---1)

You can view PC documents.

**“Organiser”** → **“Tools 3” tab** → **“Document Viewer”**

1. Select the file you wish to view.

To cancel reading, press  or .

**Note**

- You can view the following types of files with the document viewer: PDF (.pdf), Microsoft Excel (.xls), Microsoft Word (.doc), Microsoft PowerPoint (.ppt).
- For the shortcut keys that can be used in the document viewer, refer to the help by pressing [Options] and selecting “Help”.
- A file of up to 10 MB can be opened.
- Some files may not be displayed correctly depending on the type or size, such as a file of vertical text (not supported) or when the memory runs out while viewing a large document.
- Some PDF files may not be displayed correctly due to a shortage of memory even if the file size is not large when numerous fonts are embedded or image data is pasted.



- Depending on how the PDF document was created, some characters in a PDF file may not be displayed.
- Document files that are saved in Gallery or linked in a WAP/Web page can be viewed with the document viewer.
- When “Action Settings” in the motion control setting for “Document Viewer” is set to “On” (p. 136), you can zoom in or zoom out by shaking the phone forward or backward. You can also change the page being viewed by shaking the phone sideways.
- Document files that are protected with a password cannot be viewed with the document viewer.

## Notepad (M 3-▶-▶-2)

You can register up to 500 entries for use in text messages and multimedia messages. The maximum capacity of the Notepad entry is 8192 characters.

### Adding Phrases to the Notepad

“Organiser” → “Tools 3” tab → “Notepad” → “Add New Entry”

1. Enter the text.
2. Select the desired category.

### Editing Notepad Entries

“Organiser” → “Tools 3” tab → “Notepad”

1. Highlight the entry you wish to edit.
2. Press [Options] and select “Edit Text”.  
To view the entry, press Ⓞ.  
To delete the entry, press [Options] and select “Delete”.
3. Modify the text and press Ⓞ.

### Changing the Category

“Organiser” → “Tools 3” tab → “Notepad”

1. Highlight the desired entry.
2. Press [Options] and select “Change Category”.
3. Select the desired category.

## Sending Notepad Entries

**“Organiser”** → **“Tools 3” tab** → **“Notepad”**

1. Highlight the entry you wish to send.
2. Press [Options] and select “Send”.
3. Select “As Message”, “Via Bluetooth” or “Via Infrared”.

For “Via Bluetooth”

For details, see “Bluetooth” on page 152.

For “Via Infrared”

For details, see “Infrared” on page 155.

## Voice Recorder (M 3-▶-▶-3)

This allows you to record a voice clip, which can be used to remind you of schedule entries or be sent within a multimedia message. The recorded voice clip is saved in Sound Gallery. Voice clips are saved in .amr format.

### Recording a Voice Clip

**“Organiser”** → **“Tools 3” tab** → **“Voice Recorder”**

1. Press Ⓞ to start recording.  
To stop recording before the recording time is over, press Ⓞ.
2. Select “Save” to save the voice clip.

### Note

- Press ▲ (or □) or ▼ (or ▽) to adjust the sound volume when playing back the recorded file.

## Sending Voice Clips

**“Organiser”** → **“Tools 3” tab** → **“Voice Recorder”**

1. Press Ⓞ to start recording.  
To stop recording before the recording time is over, press Ⓞ.
2. Select “Save and Send”.

## Selecting the Record Time

**“Organiser”** → **“Tools 3” tab** → **“Voice Recorder”** → **[Options]** → **“Record Time”**

1. Select “For Message” or “Extended Voice”.  
When selecting “Extended Voice”, voice clips are automatically saved to a memory card.

## Selecting Storage Memory

**“Organiser”** → **“Tools 3” tab** → **“Voice Recorder”** → **[Options]** → **“Save Recording to”**

1. Select the desired location.  
When selecting “Choice”, you can select the location when saving a voice clip.

## Scanner (M 3-▶-▶-4)

With the built-in digital camera, you can read barcodes in QR code format. The scanned data can be saved as a Phonebook entry, URL, Email address and text.

### Note

- *When scanning does not take place, it may be due to one of the following reasons: type or size of barcode, scratches, dirt, damage, print quality, light reflection, etc.*

## Reading Barcodes

**“Organiser”** → **“Tools 3” tab** → **“Scanner”** → **“Scan Barcode”**

1. Display the barcode using the camera.
2. Press [Scan].
3. Press [Options] and select the desired option.

The options vary depending on the scanned data.

- |                    |                                   |
|--------------------|-----------------------------------|
| “Save”:            | The result is saved.              |
| “Send Message”:    | The result is sent as SMS or MMS. |
| “Save to Notepad”: | The result is saved as text.      |
| “Copy”:            | The result is copied.             |

## To Set the Focus Mode

**“Organiser”** → **“Tools 3” tab** → **“Scanner”** → **“Scan Barcode”**

1. Press [Options] and select “Focus”.
2. Select “Auto Focus”, “Macro” or “Manual Focus”.

## To Use Continuous Scanning

**“Organiser”** → **“Tools 3” tab** → **“Scanner”** → **“Scan Barcode”**

1. In scanning mode, press [Options] and select “Continuous Scan”.
2. Select “On” or “Off”.

## To Set the Mobile Light

**“Organiser”** → **“Tools 3” tab** → **“Scanner”** → **“Scan Barcode”**

1. Press [Options] and select “Mobile Light”.
2. Select “On” or “Off”.

## To Adjust the Exposure

**“Organiser”** → **“Tools 3” tab** → **“Scanner”** → **“Scan Barcode”**

1. Press [Options] and select “Exposure”.
2. Select the desired exposure.

## Viewing the Scanned Data



*“Organiser”* → *“Tools 3” tab* → *“Scanner”* → *“Scanned Results”*

1. Highlight the data you wish to view, then press [View].

## Phone Help (M 3---5)

You can view the help list and use it to guide you in the phone's functions.

*“Organiser”* → *“Tools 3” tab* → *“Phone Help”*

1. Select “Settings Method”, “Common Functions” or “Key Operation”.
2. Press  or .

## Scratch Pad (M 3---6)

Scratch Pad can be used as a screen memo for multiple purposes.

### Using the Scratch Pad

*“Organiser”* → *“Tools 3” tab* → *“Scratch Pad”*

1. Enter the text.
2. Press  when finished.
3. Select the purpose for using the entry.

The entry can be used for the following purposes:  
Save to Notepad, Save as Sticky Note, Save to Calendar, Save to Tasks, Save to Phonebook or Save as Text File

## **SIM Application (M 10)**

You can refer to the information on the SIM/USIM card. Contact your service provider for further details.

# **Settings (M 9)**

## **Phone Settings**

### **Setting a Profile (M 9-1)**

There are 4 profiles: “Normal”, “Car”, “Silent” and “Personal”.

### **Activating a Profile**

**“Settings” → “Phone Settings” tab → “Profiles”**

1. Select the desired profile.

#### **Note**

- *When a profile is set, the corresponding indicator described on page 23 is displayed in stand-by.*
- *The settings of “Normal” profile cannot be changed.*
- *For “Silent” and “Car” profiles, some of the settings, such as volume level, cannot be changed.*

#### **Tip**

- *In stand-by, long press  to switch Profiles between Silent mode and the profile most recently activated.*

### **Resetting Profile Settings**

**“Settings” → “Phone Settings” tab → “Profiles”**

1. Highlight the profile you wish to reset.
2. Press [Reset].

3. Enter your handset code.

The default handset code is “9999”. For details on changing the handset code, see “Changing the Handset Code” on page 138.

### **Event Light**

You can set the Small Light to flash when receiving an incoming call or a new message.

**“Settings” → “Phone Settings” tab → “Profiles”**

1. Highlight “Car”, “Silent” or “Personal”.
2. Press [Edit].
3. Select “Event Light”.
4. Select the desired option.

“For Voice Call”: Flashes when an incoming voice call is received.

“For Video Calling”: Flashes when an incoming video calling is received.

“For New Message”: Flashes when a new message is received.

“Java Start”: Flashes when *Bluetooth* notification is received.

“Delivery Report”: Flashes when a delivery report is received.



## Status Light

You can set the Small Light to flash when you miss any incoming calls or new messages.

**“Settings”** → **“Phone Settings” tab** → **“Profiles”**

1. Highlight “Car”, “Silent” or “Personal”.
2. Press [Edit].
3. Select “Status Light”.
4. Select the desired option.
  - “For Missed Call”: Flashes when an incoming voice call is missed.
  - “For New Message”: Flashes when a new message is missed.
  - “Java Start”: Flashes when *Bluetooth* notification is missed.
  - “Delivery Report”: Flashes when a delivery report is missed.

## Any Key Answer

You can answer a call by pressing any key except , , [Options] or [Busy]. For details, see page 33.

**“Settings”** → **“Phone Settings” tab** → **“Profiles”**

1. Highlight “Car”, “Silent” or “Personal”.
2. Press [Edit].
3. Select “Any Key Answer”.
4. Select “On” or “Off”.

## Setting the Display (M 9-2)

You can change the display settings.

### Setting the Wallpaper (M 9-2-1)

Your phone includes preset pictures to be used as wallpaper in stand-by. Pictures taken with the phone’s digital camera or images downloaded from a WAP site can also be used as wallpaper.

**“Settings”** → **“Phone Settings” tab** → **“Display Settings”** → **“Wallpaper”**

1. Select the folder in which the picture you wish to set is contained.  
Pictures can be selected from “Preset Pictures”, “Picture Gallery”, “Flash<sup>®</sup>” or “Other Documents”.
2. Select the desired picture.
3. After displaying the picture, press .

#### Note

- *Some pictures cannot be used because of their picture and data types.*
- *Wallpaper can be linked to a theme. Select “Link to Theme” in step 2.*

## Assigning Pictures (M 9-2-2)

Pictures can be displayed when turning the power on or off, when receiving an incoming call, or when operating the alarm.

Pictures taken with the phone's digital camera or images downloaded from a WAP site can be used.

### To Set Built-in Pictures

**“Settings”** → **“Phone Settings” tab** → **“Display Settings”** → **“Assign Pictures”**

1. Select the desired function to set the picture to.
2. Select “Preset Animation” when you select “Power On” or select “Power Off” in step 1.  
Select “Pattern 1”, “Pattern 2” or “Pattern 3” when you select “Incoming Voice Call”, “Incoming Video Call” or “Alarm” in step 1.

### To Set Saved Pictures

**“Settings”** → **“Phone Settings” tab** → **“Display Settings”** → **“Assign Pictures”**

1. Select the desired function to set the picture to.
2. Select “Picture Gallery”, “Flash<sup>®</sup>” or “Other Documents”.
3. Select the desired picture.
4. After displaying the picture, press .

5. Specify the area you wish to display using the navigation keys, then press .

### Note

- *Some pictures cannot be used because of their picture and data types.*

## Setting VeilView (M 9-2-3)

**“Settings”** → **“Phone Settings” tab** → **“Display Settings”** → **“VeilView”**

1. Select “Pattern Setting”.  
Set the veilview pattern and the scale of the pattern. If you select “Animation” as the scale, the scale of the pattern automatically changes continuously.
2. Select “Density Setting”.  
Set the veilview density.

### Note

- *Veilview can be linked to a theme. Select “Theme” in step 1.*



## Setting the Font (M 9-2-4)

To Set the Font Size

*“Settings”* → *“Phone Settings”* tab → *“Display Settings”* → *“Font Settings”* → *“Font Size”*

1. Select “Menu”, “Entering Text”, “Messaging” or “Viewing the Web”.
2. Select the desired font size.

To Set the Font Weight

*“Settings”* → *“Phone Settings”* tab → *“Display Settings”* → *“Font Settings”* → *“Font Weight”*

1. Select “Thin”, “Normal” or “Bold”.

## Setting the Stand-by Display (M 9-2-5)

You can set the stand-by screen display.

*“Settings”* → *“Phone Settings”* tab → *“Display Settings”* → *“Standby Display”*

1. Select “Clock/Calendar”, “Standby Window”, “Display Icons” or “Show Operator Name”.

## Setting the Vivid Mode (M 9-2-6)

*“Settings”* → *“Phone Settings”* tab → *“Display Settings”* → *“Vivid Mode”*

1. Select the desired mode.

## Setting the Greeting Message (M 9-2-7)

You can set the message which is displayed when the phone is turned on.

*“Settings”* → *“Phone Settings”* tab → *“Display Settings”* → *“Greeting Message”*

1. Select “Switch On/Off” and then select “On” or “Off”.

### *Tip*

- *If you wish to edit the message, select “Edit Message” in step 1 and enter a message (up to 10 characters).*

## Setting the External Display (M 9-2-8)

To Select the Backlight Time Out

*“Settings”* → *“Phone Settings”* tab → *“Display Settings”* → *“External Display”* → *“Duration”*

1. Select the desired time out.  
Select “Off” to shut the backlight off.

To Set the Message Incoming Information

**“Settings”** → **“Phone Settings” tab** → **“Display Settings”** → **“External Display”** → **“Messages”**

1. Select “Display” or “Not Display”.

To Set the Date & Time

**“Settings”** → **“Phone Settings” tab** → **“Display Settings”** → **“External Display”** → **“Display Date&Time”**

1. Select the desired display format for the date and time.

To Set the Clock Type

**“Settings”** → **“Phone Settings” tab** → **“Display Settings”** → **“External Display”** → **“Clock Type”**

1. Select the desired clock type.

To Set Incoming Indication

**“Settings”** → **“Phone Settings” tab** → **“Display Settings”** → **“External Display”** → **“Caller Display”**

1. Select “On” or “Off”.

## **Backlight (M 9-2-9)**

The backlight will turn off if you do not press the keypad for a certain length of time. You can specify a desired time to elapse before the backlight turns off, which will help conserve battery life.

### **Tip**

- *When you purchase this phone, Backlight is set to 15 seconds.*

To Select the Backlight Time Out Duration



**“Settings”** → **“Phone Settings” tab** → **“Display Settings”** → **“Backlight”** → **“Time Out”**

1. Select the desired time.

When selecting “Other”, enter the desired time.  
Select “Off” to shut it off.

To Adjust the Brightness of the Backlight

**“Settings”** → **“Phone Settings” tab** → **“Display Settings”** → **“Backlight”** → **“Brightness”**

1. Press  (Light) and  (Dark) to switch between 5 levels of clarity.
2. Press .

### **Note**

- *You can set the auto brightness adjustment function by selecting “Auto Sensor” in step 1.*

To Adjust the Contrast of the Screen

**“Settings”** → **“Phone Settings” tab** → **“Display Settings”** → **“Backlight”** → **“Dynamic Control”**

1. Select “On” or “Off”.

When selecting “On”, the backlight brightness is automatically adjusted during full screen video playback.

### **Setting the Display Saving (M 9-2-10)**

The screen of this phone will automatically turn off after a given amount of time. You can change the length of time before the Display Saving goes into effect, which will help conserve battery life.

**“Settings”** → **“Phone Settings” tab** → **“Display Settings”** → **“Display Saving”**

1. Select the desired time.

When you purchase this phone, Display Saving is set to 2 minutes.

#### **Note**

- *To cancel Display Saving: Display saving continues until either a key is pressed or there is an incoming alert. The first key press only cancels this function. You must press another key in order to perform other operations.*

### **Setting the Dial Number (M 9-2-11)**

You can set the type of number which is displayed when making a call.

**“Settings”** → **“Phone Settings” tab** → **“Display Settings”** → **“Dial Number”**

1. Select the desired type of dial number.

### **Themes (M 9-3)**

You can easily customise the display by using the theme files.

The theme files downloaded from a WAP site can be used.

**“Settings”** → **“Phone Settings” tab** → **“Themes”**

1. Select “Preset Themes” or “My Themes”.
2. Select the desired theme file.

#### **Tip**

- *Even after a theme is set, you can set a wallpaper regardless of the set theme. In this case, the other items follow the set theme.*

## Sound Settings (M 9-4)

You can use this menu to check or edit the current profile settings (except “Any Key Answer”).

**“Settings”** → **“Phone Settings” tab** → **“Sound Settings”**

### Volume (M 9-4-1)

You can adjust the volume for incoming voice calls, SMS/MMS/Email messages and other sounds to one of seven levels.

**“Settings”** → **“Phone Settings” tab** → **“Sound Settings”** → **“Volume”**

1. Select “For Incoming Call”, “For New Message”, “Java Start”, “Delivery Report” or “General Volume”.
2. Press ▲ (or ►) to increase the ringer volume or press ▼ (or ◀) to decrease the ringer volume and then press ○.

To select “Silent”, press ▼ (or ◀) at level 1.

## Assigning a Ringtone or Ring Video Clip for an Incoming Call

You can set a ringtone or ring video clip for incoming voice calls and video callings. For ringtones, you can select from different tones including patterns, sound effects and melodies or set a sound in Sound Gallery as the default ringtone. For ring video clips, you can set a video clip in Video Gallery as the default ring video clip.

**“Settings”** → **“Phone Settings” tab** → **“Sound Settings”** → **“Ringtone/Ringvideos”**

1. Select “For Voice Call” or “For Video Calling”.
2. Select “Preset Sounds”, “Sound Gallery”, “Video Gallery” or “Flash®”.
3. Highlight the ringtone or ring video clip you wish to use.
4. Press ○.



### Note

- Melodies can be selected from “Sound Gallery”, “Preset Sounds” or “Flash®”.

## Notification

When receiving messages, *Bluetooth* notification or delivery reports, your phone will notify you of their arrival with the ringtone or ring video clip you specify.

**“Settings”** → **“Phone Settings” tab** → **“Sound Settings”** → **“Ringtone/Ringvideos”**

1. Select “For New Message”, “Java Start” or “Delivery Report”.
2. Select “Assign Tone”.
3. Select the desired folder.
4. Highlight the desired ringtone or ring video clip.  
For details on selecting a ringtone or a ring video clip, see “Assigning a Ringtone or Ring Video Clip for an Incoming Call” on page 131.
5. Press .
6. Select “For New Message”, “Java Start” or “Delivery Report”.
7. Select “Duration”.
8. Enter the desired duration of message notification in 2 digits using the digit keys.
9. Press .

## Keypad Tones

When the keypad tone is set on, you will hear a confirmation tone each time you press any key.

**“Settings”** → **“Phone Settings” tab** → **“Sound Settings”** → **“System Sounds”** → **“Keypad Tones”**

1. Select the desired tone pattern.

## Warning Tone

Your phone can be set to emit a warning tone when an error occurs.

**“Settings”** → **“Phone Settings” tab** → **“Sound Settings”** → **“System Sounds”** → **“Warning Tone”**

1. Select “Sound” or “Duration”.  
For “Sound”, select “Preset Sounds”, “Sound Gallery” or “Off”.  
For “Duration”, select the desired time.

## Power On/Off Sound

Your phone can be set to emit a sound when it is switched on or off.

***“Settings” → “Phone Settings” tab → “Sound Settings” → “System Sounds”***

1. Select “Power On Sound” or “Power Off Sound”.

2. Select “Sound” or “Duration”.

For “Sound”, select “Preset Sounds”, “Sound Gallery” or “Off”.

For “Duration”, enter the desired duration of sound in 2 digits using the digit keys.

## Handset Open/Close Sound

Your phone can be set to emit a sound when it is opened or closed.

***“Settings” → “Phone Settings” tab → “Sound Settings” → “System Sounds”***

1. Select “Handset Open” or “Handset Close”.

2. Select “Sound” or “Duration”.

For “Sound”, select “Preset Sounds”, “Sound Gallery” or “Off”.

For “Duration”, select the desired time.

## Charge Full

Your phone can be set to emit a sound when it is fully charged.

***“Settings” → “Phone Settings” tab → “Sound Settings” → “System Sounds” → “Charge Full”***

1. Select “Sound” or “Duration”.

For “Sound”, select “Preset Sounds”, “Sound Gallery” or “Off”.

For “Duration”, select the desired time.

## Vibration (M 9-4-4)



***“Settings” → “Phone Settings” tab → “Sound Settings” → “Vibration”***

1. Select “For Incoming Call”, “For New Message”, “Java Start” or “Delivery Report”.

2. Select “Switch On/Off” and then select “On” or “Link to Sound” to activate.

3. Select “Vibration Pattern” and then select the desired vibration pattern.

### Tip

- When you select “On” for “For Incoming Call”, “” or “” is displayed in stand-by.

### **Event Light (M 9-4-5)**

*“Settings” → “Phone Settings” tab → “Sound Settings” → “Event Light”*

1. Select “For Voice Call”, “For Video Calling”, “For New Message”, “Java Start” or “Delivery Report”.
2. Select “Switch On/Off” and then select “On” or “Link to Sound” to activate.
3. Select “Light Colour” and then select the desired light colour.

### **Status Light (M 9-4-6)**

*“Settings” → “Phone Settings” tab → “Sound Settings” → “Status Light”*

1. Select “For Missed Call”, “For New Message”, “Java Start” or “Delivery Report”.
2. Select “Switch On/Off” and then select “On” to activate.
3. Select “Light Colour” and then select the desired light colour.

### **Any Key Answer (M 9-4-7)**

*“Settings” → “Phone Settings” tab → “Sound Settings” → “Any Key Answer”*

1. Select “On” or “Off”.

### **Surround (M 9-4-8)**

You can set surround sound.

*“Settings” → “Phone Settings” tab → “Sound Settings” → “Surround”*

1. Select “On” or “Off”.



### **Date & Time (M 9-5)**

You need to set the correct time and date in order for your phone’s various time-based functions to work correctly.

*“Settings” → “Phone Settings” tab → “Date & Time”*

1. Select “Set Date/Time”.
2. Enter the day, month, year and time using the digit keys.

#### **Tip**

- *When you enter the time in the 12-hour format, press  or  to switch between am and pm. The order in which the date and time is displayed is based on the format setting.*



### **To Set Daylight Saving (M 9-5-2)**

*“Settings” → “Phone Settings” tab → “Date & Time” → “Daylight Saving”*

1. Select “On” or “Off”.



To Set the Time Zone (M 9-5-3)

**“Settings”** → **“Phone Settings” tab** → **“Date & Time”**  
→ **“Set Time Zone”**

1. Press  or  to select the home city to set.
2. Press .

To Customise the Time Zone

**“Settings”** → **“Phone Settings” tab** → **“Date & Time”**  
→ **“Set Time Zone”**

1. Press [Custom].
2. Enter the city name.
3. Enter the time-zone differences using the digit keys.  
Press  or  to switch between – and +.
4. Press .

World Clock (M 9-5-4)

For details, see page 118.

To Select the Time Format (M 9-5-5)

**“Settings”** → **“Phone Settings” tab** → **“Date & Time”**  
→ **“Time Format”**

1. Select “24 Hour” or “12 Hour”.

To Select the Date Format (M 9-5-6)

**“Settings”** → **“Phone Settings” tab** → **“Date & Time”**  
→ **“Date Format”**

1. Select from “D-M-Y”, “M-D-Y” or “Y-M-D”.

To Select the Calendar Format (M 9-5-7)

**“Settings”** → **“Phone Settings” tab** → **“Date & Time”**  
→ **“Calendar Format”**

1. Select “Sunday-Saturday” or “Monday-Sunday”.

### Language Setting (M 9-6)

You can change the language displayed on the phone.

**“Settings”** → **“Phone Settings” tab** → **“Language”**

1. Select the desired language.

#### Tip

- You can also change the input language on the text entry screen (p. 40).

#### Note

- If you select “Automatic” in step 1, the language preset on the SIM/USIM card is selected.
- If the language preset on the SIM/USIM card is not supported, then the default language of the phone is selected.



## Motion Control Settings (M 9-7)

*“Settings” → “Phone Settings” tab → “Motion Control”*

### To Set Display Change

You can set whether the screen automatically changes direction to the portrait or landscape position according to the direction of the phone when Document Viewer or the WAP/Web browser is activated.

1. Select “Display Change”.
2. Select “Browser” or “Document Viewer”.
3. Select “On” or “Off”.

### To Set the Action (M 9-7-2)

1. Select “Action Settings”.
2. Select the desired setting.

“Quick Silent”:  
Enables switching to Quick Silent mode when the phone is turned over.

“Music”:  
Enables selecting a sound file by shaking the phone sideways.

“Messaging”:  
Enables changing the size of the text by shaking the phone forward or backward.

“Browser”:  
Enables zooming in or zooming out by shaking the phone forward or backward.

“Document Viewer”:  
Enables switching the page by shaking the phone sideways. Enables zooming in or zooming out by shaking the phone forward or backward.

“Image Viewer”:  
Enables switching the image displayed by shaking the phone sideways. Enables zooming in or zooming out by shaking the phone forward or backward.

3. Select “On” or “Off”.

## Setting the Sound Output (M 9-8)

*“Settings” → “Phone Settings” tab → “Switch Ringtone Output”*

1. Select “Earphone Only” or “Earphone + Speaker”.

## Change Menu (M 9-10)

You can change the type of menu to display.

*“Settings” → “Phone Settings” tab → “Change Menu”*

1. Select “Standard Menu” or “Large Font Menu”.

## Security Settings (M 9-11)

You can set various locks on your phone such as PIN Entry and Handset Lock.

“Settings” → “Phone Settings” tab → “Security Settings”

### Enabling/Disabling the PIN Code

If the PIN code is enabled, you are asked to enter the PIN code each time the phone is switched on. Your PIN code is registered on the SIM/USIM card and you should have been made aware of the code when you purchased the SIM/USIM card. Contact your service provider for further details.

Select “On” for “PIN Entry” and enter your PIN code if you wish to activate the PIN lock.

#### Note

- *If you enter the wrong PIN code three times, the SIM/USIM card will lock. To remove the lock, contact your service provider or SIM/USIM card vendor.*

### To Change the PIN Code

This allows you to change the PIN code registered on the SIM/USIM card. Before you change the PIN code, select “On” for “PIN Entry”.

Enter the existing PIN code for “Change PIN” after selecting “PIN Entry”, and enter a new PIN code twice.

### To Change the PIN2 Code

PIN2 is a second PIN code used to unlock certain features of a SIM/USIM card, such as Fixed Dialling and Call Cost metering. Not all SIM/USIM cards use the PIN2 code. This menu may not be displayed depending on the type of your SIM/USIM card.

Enter the existing PIN2 code for “Change PIN2”, and enter a new PIN2 code twice.

### Handset Lock

The Handset Lock prevents unauthorised use of the phone or certain features on the phone when the power is turned on. By setting this option on, your phone or certain features on your phone are locked until the correct handset code is entered.

Select “On” for “Handset Lock” if you wish to activate the Handset Lock.

## Function Lock

By setting this option on, all the functions of your phone will be locked until the correct handset code is entered.

Enter your handset code after selecting “Function Lock”.

### To Turn Off the Function Lock

Enter your handset code in stand-by to turn the Function Lock off.

## Phonebook Lock

The Phonebook Lock function prevents unauthorised use of your Phonebook.

Select “On” to lock or “Off” to unlock for “Phonebook Lock” and enter your handset code.

The default handset code is “9999”. For details on changing the handset code, see “Changing the Handset Code”.

## History Lock

The History Lock function prevents unauthorised access to Call Log. By setting this option on, Call Log cannot be viewed until the correct handset code is entered.

Press [Check] to lock or [Uncheck] to unlock.

## Showing Secret Data

By setting this option on, the hidden data can be displayed.

Select “On” to display or “Off” to hide for “Show Secret Data”. Enter your handset code when you select “On”.

The default handset code is “9999”. For details on changing the handset code, see “Changing the Handset Code”.

### Note

- *The hidden data can be displayed temporarily by shaking the phone. For details, see “Showing Secret Data Temporarily” on page 30.*

## Changing the Handset Code

The default handset code is “9999”.

Select “Change Handset Code” and enter the old handset code, then enter a new handset code twice.

## Master Reset (M 9-12)

You can return the settings for M1 to M11 to the default settings.

**“Settings”** → **“Phone Settings” tab** → **“Master Reset”** → **“Reset Settings”**

1. Enter your handset code.

The default handset code is “9999”. For details on changing the handset code, see “Changing the Handset Code” on page 138.

### Note

- *Some settings are not deleted by this function. Data stored in Phonebook, etc. is not deleted.*

To Reset All Settings for M1 to M11 and Delete All Created Data (M 9-12-2)

**“Settings”** → **“Phone Settings” tab** → **“Master Reset”** → **“Reset All”**

1. Enter your handset code.

The default handset code is “9999”. For details on changing the handset code, see “Changing the Handset Code” on page 138.

## Call/Video Call

### Voicemail & Diverts (M 9-1-1)

This service can be used to divert incoming calls that you cannot answer. Calls can be diverted to another phone number or to your Voicemail system.

### Note

- *This service may not be available on all mobile phone networks. Contact your service provider for more information.*

To Activate the Voicemail Service

**“Settings”** → **“Call/Video Call” tab** → **“Voicemail & Diverts”** → **“Voicemail”** → **“Activate”**

1. Select one of the following options:

“Always”:	Diverts all calls without ringing.
“When Busy”:	Diverts incoming calls while you are talking on the phone.
“No Answer”:	Diverts incoming calls if you do not answer a call within a certain period of time. Select the period of time from 6 levels (05 to 30 seconds).
“Not Reachable”:	Diverts incoming calls when your phone has no network service or is switched off.

2. Press .

## To Activate the Diverts Service

Select the appropriate option.

**“Settings”** → **“Call/Video Call”** tab → **“Voicemail & Diverts”** → **“Diverts”**

1. Select the desired item.
2. Select from “Always”, “When Busy”, “No Answer” or “Not Reachable”.
3. Enter a phone number to which you wish to divert calls or search for it in the Phonebook (p. 50).  
If you select “No Answer” in step 2, select the period of time from 6 levels (05 to 30 seconds).
4. Press .

### Note

- When “Voice Calls” diverts are set to “Always”,  is displayed in stand-by.

## To Deactivate the Diverts Service

Select the appropriate option.

**“Settings”** → **“Call/Video Call”** tab → **“Voicemail & Diverts”** → **“Deactivate”**

1. Select from “Always”, “When Busy”, “No Answer” or “Not Reachable”.
2. Press .

## To Cancel the Diverts and Voicemail Service

Once you have changed the diverts settings, you can cancel them all with this service.

**“Settings”** → **“Call/Video Call”** tab → **“Voicemail & Diverts”** → **“Cancel All”**

## To Check the Diverts Status

**“Settings”** → **“Call/Video Call”** tab → **“Voicemail & Diverts”** → **“Status”**

1. Select the diverts option you wish to check.

## Video Calling Settings (M 9-2)

Set various types of functions and services for video callings.

### To Select an Image for the Alternative Image (M 9-2-1)

You can select an image shown to the other party between the sub camera image and an alternative image from the saved picture files.

**“Settings”** → **“Call/Video Call” tab** → **“Video Calling Settings”** → **“Camera Picture”**

1. Select “Default Image” or “Alternative Image”.

For “Default Image”, select “Internal Camera”, “External Camera” or “Alternative Image”.

For “Alternative Image”, select “Preset Picture”, “Picture Gallery” or “Theme”.

### To Select the Picture Quality

Select the desired data format for your environment.

**“Settings”** → **“Call/Video Call” tab** → **“Video Calling Settings”** → **“Incoming Picture Quality”**

**“Settings”** → **“Call/Video Call” tab** → **“Video Calling Settings”** → **“Outgoing Picture Quality”**

1. Select “Normal”, “Quality Priority” or “Frame Rate Priority”.

Select “Frame Rate Priority” to perform faster communication.

### To Assign Hold Guidance Picture (M 9-2-4)

You can display an image saved in the phone on your display while you are putting a call on hold.

**“Settings”** → **“Call/Video Call” tab** → **“Video Calling Settings”** → **“Hold Guidance Picture”**

1. Select “Preset Picture”, “Picture Gallery” or “Theme”.
2. Select the desired picture.

### To Set the Backlight (M 9-2-5)

With this setting on, the phone’s backlight is on when making a video calling.

**“Settings”** → **“Call/Video Call” tab** → **“Video Calling Settings”** → **“Backlight”**

1. Select “Always On”, “Always Off” or “As Normal Setting”.

The “As Normal Setting” option depends on the backlight setting of the display (p. 129).

To Turn On or Off the Speaker (M 9--2-6)

**“Settings”** → **“Call/Video Call” tab** → **“Video Calling Settings”** → **“Loudspeaker”**

1. Select “On” to turn on the loudspeaker or select “Off” to turn it off.

To Mute the Microphone (M 9--2-7)

You can mute the microphone while making a video calling.

**“Settings”** → **“Call/Video Call” tab** → **“Video Calling Settings”** → **“Mute Microphone”**

1. Select “On” to mute or “Off” to cancel mute.

To Set the Remote Monitor

You can set the phone to answer video callings automatically.

**“Settings”** → **“Call/Video Call” tab** → **“Video Calling Settings”** → **“Remote Monitor”**

1. Enter your handset code.
2. Select “Switch On/Off”.
3. Select “On” or “Off”.

To Set the Auto Answer List

Register phone numbers to the Auto Answer list.

**“Settings”** → **“Call/Video Call” tab** → **“Video Calling Settings”** → **“Remote Monitor”**

1. Enter your handset code.
2. Select “Auto Answer List”.
3. Select a blank field.
4. Enter the desired number.

To Set the Answer Time

**“Settings”** → **“Call/Video Call” tab** → **“Video Calling Settings”** → **“Remote Monitor”**

1. Enter your handset code.
2. Select “Answer Time”.
3. Enter the time from 0 to 30 seconds (in 2 digits).

**Showing Your Number (M 9--3)**

This lets you control whether to show your phone number when calling another party or not.

**“Settings”** → **“Call/Video Call” tab** → **“Show Your Number”**

1. Select “On”, “Off” or “Status”.

**Note**

- *Some networks do not support this service. Please check with your service provider for availability.*

## Restrict Calls (M 9-4)

This function lets you place restrictions on incoming and outgoing calls. To activate this option you will need the specified password, which is available from your service provider.

***“Settings” → “Call/Video Call” tab → “Restrict Calls”***

1. Select “Outgoing Calls” or “Incoming Calls”.

“Outgoing Calls”: Restricts outgoing calls.

“Incoming Calls”: Restricts incoming calls.

2. Select one of the following options:

(For “Outgoing Calls”)

“Bar All Outgoing Calls”:  
Restricts all outgoing calls  
except emergency calls.

“Bar International Calls”:  
Restricts all outgoing  
international calls.

“Only Local & Home”:  
Restricts all outgoing  
international calls except to  
your home country.

(For “Incoming Calls”)

“Bar All Incoming Calls”:  
Restricts all incoming calls.

“Bar if Abroad”:  
Restricts all incoming calls  
when you are outside of the  
coverage from your  
registered service provider.

3. Select one of the following options:

“All Services”:  
Restricts all services.

“Voice Calls”:  
Restricts all voice calls.

“Video Callings”:  
Restricts all video callings.

“Messages”:  
Restricts all messages.

4. Select “On”, “Off” or “Status”.

5. Enter the network password.

To Cancel Settings

***“Settings” → “Call/Video Call” tab → “Restrict Calls”***

1. Select “Outgoing Calls” or “Incoming Calls”.

2. Select “Cancel All”.

3. Enter the network password.



## Fixed Dialling Numbers

This option is available on most SIM/USIM cards for mobile phones. It allows you to configure a SIM/USIM card so that it can only be used to make calls to numbers on a predefined list.

### Note

- This service depends on the SIM/USIM card.

### To Enable Fixed Dialling Numbers

**“Settings”** → **“Call/Video Call” tab** → **“Restrict Calls”** → **“FDN”**

1. Select “Switch On/Off”.
2. Select “On” to enable this function.
3. Enter your PIN2 code.

### To Add a New Name

**“Settings”** → **“Call/Video Call” tab** → **“Restrict Calls”** → **“FDN”**

1. Select “Edit Dial List”.
2. Select a blank field.
3. Enter your PIN2 code.
4. Add a name and a phone number.

For details on adding a name and phone number, see “Adding a New Phonebook Entry” on page 49.

5. Press [Save].

## Rejecting an Incoming Call

You can register phone numbers you do not wish to answer.

### To Reject the Registered Number

**“Settings”** → **“Call/Video Call” tab** → **“Restrict Calls”** → **“Rejected Numbers”** → **“Switch On/Off”**

1. Select “On” or “Off”.

### To Register the Rejected Number

**“Settings”** → **“Call/Video Call” tab** → **“Restrict Calls”** → **“Rejected Numbers”** → **“Set Rejecting Number”**

1. Select a blank field.
2. Enter the desired number.

## Rejecting a Call when the Caller’s Number is Withheld

**“Settings”** → **“Call/Video Call” tab** → **“Restrict Calls”** → **“Withheld Call”**

1. Select “On” or “Off”.

## Changing the Network Password

***“Settings” → “Call/Video Call” tab → “Restrict Calls” → “Change N/W Password”***

1. Enter the old network password.
2. Enter a new network password.
3. Enter the new network password again.

If you enter the incorrect password, you are asked to enter the password again.

4. Press .

## Minute Minder (M 9--5)

Minute Minder function informs you of your talk time by sounding a tone after every minute.

***“Settings” → “Call/Video Call” tab → “Minute Minder”***

1. Select “On” or “Off”.

## Auto Answer (M 9--6)

You can set the phone to answer voice calls automatically.

***“Settings” → “Call/Video Call” tab → “Auto Answer”***

1. Enter your handset code.
2. Select “Switch On/Off”.
3. Select “On” or “Off”.

To Set the Answer Time

***“Settings” → “Call/Video Call” tab → “Auto Answer”***

1. Enter your handset code.
2. Select “Answer Time”.
3. Enter the time from 1 to 30 seconds.

## Call Waiting (M 9-7)

### Note

- *This service may not be available on all mobile phone networks. Contact your service provider for more information.*

If you wish to be able to receive another incoming call while you have a call in progress, you must activate the Call Waiting service.

**“Settings”** → **“Call/Video Call” tab** → **“Call Waiting”**

1. Select “On”, “Off” or “Status”.

## Display Call Timer (M 9-8)

**“Settings”** → **“Call/Video Call” tab** → **“Display Call Timer”**

1. Select “On” or “Off”.

## Display Call Cost (M 9-9)

**“Settings”** → **“Call/Video Call” tab** → **“Display Call Cost”**

1. Select “On” or “Off”.

## Auto Redial (M 9-10)

**“Settings”** → **“Call/Video Call” tab** → **“Auto Redial”**

1. Select “On” or “Off”.

## Network Settings

### Network Settings (M 9-1)

To Select a Service Automatically

Each time the power is turned on, your phone selects a service automatically.

**“Settings”** → **“Network Settings” tab** → **“Network Settings”** → **“Select Service”**

1. Select “Auto”.

To Select a Service Manually

**“Settings”** → **“Network Settings” tab** → **“Network Settings”** → **“Select Service”**

1. Select “GSM”.

### Note

- *When “GSM” is selected for the network setting, functions for 3G service, such as video callings or high speed data access, cannot be used.*

### To Select a Network Automatically

Each time the power is turned on, your phone always tries to connect to the preferred network.

If your phone is not connected to the network, you can perform the following immediately to establish the preferred network connection.

***“Settings” → “Network Settings” tab → “Network Settings” → “Select Network” → “Automatic”***

### To Select the Network Manually

***“Settings” → “Network Settings” tab → “Network Settings” → “Select Network” → “Manual”***

1. Select the desired network.

### To Edit the Preferred List

***“Settings” → “Network Settings” tab → “Network Settings” → “Select Network” → “Set Preferred”***

1. Select the name of the network you wish to edit.
2. Select “Insert” to insert over the selected position, “Add to End” to insert at the end or “Delete” to delete.

### To Add a New Network

***“Settings” → “Network Settings” tab → “Network Settings” → “Select Network” → “Add New Network”***

1. Select “Add”.
2. Enter the country code (up to 3 digits).
3. Enter the network code (up to 3 digits).
4. Enter a new network name (up to 25 characters).
5. Select the desired network type.
6. Enter either 2G (GSM) or 3G for the network type.

### Showing the Network Information

**(M 9---1-3)**

***“Settings” → “Network Settings” tab → “Network Settings” → “Network Information”***

Information about the operator is displayed.

### Off Line Mode (M 9---2)

When the Off Line Mode is set to “On”, the phone cuts off the network connections and stops searching for available networks to connect.

***“Settings” → “Network Settings” tab → “Off Line Mode”***

1. Select “On” or “Off”.

## Internet Settings (M 9---3)

### Note

- In normal operations, you do not need to change the settings.
- Internet settings have already been entered in your phone depending on your service provider. You may have restrictions on viewing, deleting, copying or modifying the settings. Contact your service provider for details.

## Browser Settings (M 9---3-1)

**“Settings”** → **“Network Settings”** tab → **“Internet Settings”** → **“Browser Settings”** → **“Create New”**

- “Profile Name”: Browser profile name (unique name)
- “Proxy”: Proxy setting for Browser (when “Use Proxy” is On)
- “Access Point”: Access point for Browser (when “Use Proxy” is Off)
- “Use Proxy”: Setting to connect by Proxy or not
- “Home”: Home page URL (when “Use Proxy” is Off)

## Java™ Settings (M 9---3-2)

**“Settings”** → **“Network Settings”** tab → **“Internet Settings”** → **“Java™ Settings”** → **“Create New”**

- “Profile Name”: Profile name for Java™ application (unique name)
- “Proxy”: Proxy setting for Java™ application (when “Use Proxy” is On)
- “Access Point”: Access point for Java™ application (when “Use Proxy” is Off)
- “Use Proxy”: Setting to connect by Proxy or not

### Streaming Settings (M 9-3-3)

**“Settings”** → **“Network Settings” tab** → **“Internet Settings”** → **“Streaming Settings”** → **“Create New”**

- “Profile Name”: Profile name for streaming (unique name)
- “Proxy Address”: Proxy address
- “Proxy Port Number”: Port number (1-65535)
- “Access Point”: Access point

### Proxy Settings (M 9-3-4)

**“Settings”** → **“Network Settings” tab** → **“Internet Settings”** → **“Proxy Settings”** → **“Create New”**

- “Proxy Name”: Proxy name (unique name)
- “Proxy Address”: IP address
- “Access Point”: Access point
- “Home”: Home page URL
- “Port Number”: Port number (1-65535)
- “Authentication Type”: Authentication type (“HTTP-BASIC” or “HTTP-DIGEST”)
- “User Name”: User name for authentication
- “Password”: Password for authentication

### Access Point Settings (M 9-3-5)

**“Settings”** → **“Network Settings” tab** → **“Internet Settings”** → **“Access Point Settings”** → **“Create New”**

- “Access Point Name”: Access point name (unique name)
- “APN”: APN setting
- “Authentication Type”: Authentication type (“NONE”, “PAP” or “CHAP”)
- “User Name”: User name for access point
- “Password”: Password for access point
- “DNS”: DNS (Domain Name System)
- “Linger Time”: Linger Time (1-99999 sec.)

### Re-provisioning Settings (M 9-3-6)

**“Settings”** → **“Network Settings” tab** → **“Internet Settings”** → **“Re-provisioning Settings”** → **“Execute Pending”**

### Clearing DNS Cache (M 9-3-7)

**“Settings”** → **“Network Settings” tab** → **“Internet Settings”** → **“Clear DNS Cache”**

### To Activate the Browser/Java™/Streaming Profile

**“Settings”** → **“Network Settings” tab** → **“Internet Settings”**

1. Select “Browser Settings”, “Java™ Settings” or “Streaming Settings”.
2. Select the desired profile you wish to activate.

### To Edit/View/Copy/Delete the Browser/Java™/Streaming/Proxy/Access Point Profile

**“Settings”** → **“Network Settings” tab** → **“Internet Settings”**

1. Select “Browser Settings”, “Java™ Settings”, “Streaming Settings”, “Proxy Settings” or “Access Point Settings”.
2. Highlight the desired profile.
3. Press [Options] and select the desired option.
  - “Edit”: Modify the desired item.
  - “View”: Confirm the details of the profile.
  - “Copy”: Enter the new file name.
  - “Delete”: Select “Yes” to delete.

## **Call Log (M 11)**

The phone will record the last 30 missed calls, received calls and dialled numbers.

### **Viewing Call Log**

#### ***“Call Log”***

1. Select from “All Calls”, “Dialled Numbers”, “Missed Calls” or “Received Calls”.  
The selected call log list is displayed.  
To switch logs, press ◀ or ▶.
2. Select the phone number you wish to view.  
If you wish to dial the number, press [☎] to make a voice call or [☎] to make a video calling.

#### ***Tip***

- *You can also confirm call logs by pressing [☎] in stand-by.*

### **Sending Messages**

1. In the call log list, highlight the phone number or name you wish to send a message to.
2. Press [Options] and select “Create Message”.  
For details on creating a message, see “Creating a New Message” on page 78.

### **Deleting a Call Log**

1. In the call log list, press [Options] and select “Delete” or “Delete All”.

## **Call Timers (M 11-5)**

This function lets you check the duration of your calls.

### **Checking the Duration of the Last Call and All Calls**

#### ***“Call Log” → “Call Timers”***

1. Select “Dialled Calls” or “Received Calls”.

### **Resetting Call Timers (M 11-5-3)**

#### ***“Call Log” → “Call Timers” → “Clear Timers”***

1. Enter your handset code.

The default handset code is “9999”. For details on changing the handset code, see “Changing the Handset Code” on page 138.

## **Data Counter**

You can confirm the number of bytes used in the data transmission.

#### ***“Call Log” → “Data Counter”***

1. Select “Last Data” or “All Data”.

### **Resetting All Data Counter**

#### ***“Call Log” → “Data Counter” → “Clear Counter”***



## **Connectivity (M 12)**

By configuring the settings in this menu, you can connect to *Bluetooth* wireless technology or infrared enabled phones, as well as PCs (USB connection is possible using Data Cable accessory).

### **Bluetooth (M 12-1)**

For using the *Bluetooth* wireless function, you need to search for other *Bluetooth* wireless technology enabled devices to establish contact with your phone. Keep your phone within a distance of 10 metres from the devices before searching.

#### **Using the Bluetooth Wireless Function**

To Turn On or Off the Bluetooth Wireless Function (M 12-1-1)

**“Connectivity” → “Bluetooth” → “Switch On/Off”**

1. Select “On” or “Off”.

When “On” is selected, the *Bluetooth* wireless setting is activated, and “” is displayed.

To Search for Devices to be Paired (M 12-1-2)  
A maximum of 16 devices can be searched for.

**“Connectivity” → “Bluetooth” → “Search for Devices”**

1. Select the desired device for pairing.
2. Enter the device passcode.

#### **Note**

- *You can search for devices even when the Bluetooth wireless function is off. Once pairing is started, the phone turns the Bluetooth wireless function on automatically.*
- *You can only select one device for pairing. To change the paired device, see “To Activate the Paired Device” on page 153.*
- *Pairing means authentication has been established between the two devices.*
- *In order to pair two devices with Bluetooth wireless technology, the users should agree on the same passcode for both devices.*
- *The passcode is used only once, so there is no need to remember it. The passcode can be different each time the devices are connected.*
- *Devices that do not have a user interface (i.e., headsets and car kits) have a factory-set passcode. See the user guide for the device.*

### Tip

- You can save battery power by turning the Bluetooth wireless function off while it is not in use. Turn the Bluetooth wireless function off in “To Turn On or Off the Bluetooth Wireless Function” on page 152 or in “To Turn Off Automatically” on page 155.
- During a call, you can divert voice calls to the paired handsfree device. Press [Options], select “Transfer Audio” and then “To Handset” or “To Bluetooth”.

### To Activate the Paired Device

All paired devices are shown in a list.

**“Connectivity”** → **“Bluetooth”** → **“Paired Devices”**

1. Select the desired device you wish to activate.

### To Only Connect the Desired Service

**“Connectivity”** → **“Bluetooth”** → **“Paired Devices”**

1. Highlight the desired device.
2. Press [Options] and select “Select service”.
3. Select “Handsfree function” or “Audio function”.

To Give Priority to the Handsfree Device and/or the Audio Device

**“Connectivity”** → **“Bluetooth”** → **“Paired Devices”**

1. Highlight the desired device.
2. Press [Options] and select “Set to Prior Connect”.
3. Select “Handsfree On” or “Audio On”.

To Rename or Delete the Paired Devices

**“Connectivity”** → **“Bluetooth”** → **“Paired Devices”**

1. Highlight the desired device.
2. Press [Options].
3. Select “Change Name” or “Delete”.

You can rename or delete by pressing  after selecting the desired device.

## To Send All Data to Other Devices (M 12-1-4)

You can send all the data for applications such as Phonebook, Calendar, Tasks to selected devices.

**“Connectivity”** → **“Bluetooth”** → **“Send All”**

1. Select the desired device.

If a device is not specified, searching starts automatically.

2. Enter your handset code.

The default handset code is “9999”. For details on changing the handset code, see “Changing the Handset Code” on page 138.

3. Select the desired data to send.

4. Enter the device passcode for unpaired devices.

### **Note**

- *If the handsfree device is connected, the confirmation screen to deactivate the handsfree function is displayed. Select “Yes” to deactivate.*

## Bluetooth Wireless Settings (M 12-1-5)

With this setting you can rename your phone, prevent other devices from recognising your phone and turn the *Bluetooth* wireless function off automatically to save battery power, etc.

### To Rename Your Phone

You can rename your phone. The name is shown on other devices when your phone is detected.

**“Connectivity”** → **“Bluetooth”** → **“Bluetooth Settings”** → **“Device Name”**

1. Enter the new device name.

### To Show or Hide Your Phone

**“Connectivity”** → **“Bluetooth”** → **“Bluetooth Settings”** → **“Visibility”**

1. Select the desired visibility settings.

“Show My Phone”: Allows other devices to recognise your phone.

“Hide My Phone”: Hides your phone from other devices.

To Select the Sound Output

***“Connectivity” → “Bluetooth” → “Bluetooth Settings” → “Sound Output”***

1. Select “Phone/Earphone” or “Bluetooth Device”.

To Switch the Handsfree Settings

***“Connectivity” → “Bluetooth” → “Bluetooth Settings” → “Handsfree Setting”***

1. Select “Handsfree Mode” or “Private Mode”.  
“Handsfree Mode”: For talking always with the handsfree kit  
“Private Mode”: For talking with the device used to receive or make a call

To Set Java™ Application Request

You can set whether to accept Java™ application requests from other devices.

***“Connectivity” → “Bluetooth” → “Bluetooth Settings” → “Java™ Application Request”***

1. Select “On” or “Off”.

To Turn Off Automatically

***“Connectivity” → “Bluetooth” → “Bluetooth Settings” → “Bluetooth Timeout”***

1. Select the desired time.  
Your phone turns the function off automatically after the specified time.

To See Your Phone Details (M 12-1-6)

***“Connectivity” → “Bluetooth” → “My Phone Details”***

## **Infrared (M 12-2)**

In order to use the Infrared function, you need to search for other infrared enabled devices to establish contact with your phone. Keep your phone within a distance of 20 centimetres before searching. The infrared setting will return to off when no data is transmitted/received via infrared communication.

Infrared communication is only available when the phone is open.

### **Turning On or Off (M 12-2-1)**

***“Connectivity” → “Infrared” → “Switch On/Off”***

1. Select “On (3 min)” or “Off”.  
The infrared setting is activated, and “☎” is displayed.

### **Sending All Data (M 12-2-2)**

**“Connectivity”** → **“Infrared”** → **“Send All”**

1. Enter your handset code.  
The default handset code is “9999”. For details on changing the handset code, see “Changing the Handset Code” on page 138.
2. Select the desired data to send.
3. Enter the authorisation code.

### **Mass Storage (M 12-3)**

You can set the phone to connect to a PC via Mass Storage mode.

**“Connectivity”** → **“Mass Storage”**

1. Select “Yes”.

#### **Note**

- *Activating Mass Storage mode also activates offline mode.*
- *Mass Storage is not available when the battery is low, a Java™ application is paused, Music Player is active, or a memory card is not inserted in your phone.*

### **USB Charge (M 12-4)**

You can set the phone to charge via USB, connected to a PC.

**“Connectivity”** → **“USB Charge”**

1. Select “Enable” or “Disable”.

### **Card Settings (M 12-5)**

#### **Formatting Memory Card (M 12-5-2)**

**“Connectivity”** → **“Card Settings”** → **“Format Card”**

1. Enter your handset code.  
The default handset code is “9999”. For details on changing the handset code, see “Changing the Handset Code” on page 138.
2. Select “Yes” to start formatting.

## Making a Backup File

With a memory card inserted in your phone, you can back up data in Messages (Inbox, Drafts, Sent Messages), Call Manager, Message Groups, Calendar, Tasks, Notepad, and Bookmarks in the handset memory to the memory card. You can also restore the backup data from the memory card.

***“Connectivity” → “Card Settings” → “Backup/Restore” → “Backup”***

1. Enter your handset code.

The default handset code is “9999”. For details on changing the handset code, see “Changing the Handset Code” on page 138.

2. Check off the desired items to back up and press [Execute].

To back up all files, press [Options] and select “Check All” to check off all items. Then press [Execute].

3. Select “Yes” to start backing up the data.

## Restoring a Backup File

***“Connectivity” → “Card Settings” → “Backup/Restore” → “Restore”***

1. Enter your handset code.

The default handset code is “9999”. For details on changing the handset code, see “Changing the Handset Code” on page 138.

2. Check off the desired items to restore and press [OK].  
To restore all files, press [Options] and select “Check All” to check off all items. Then press [OK].
3. Select the desired file to restore and press [OK].  
A confirmation message indicating deletion from the handset memory is displayed.
4. Select “Yes” to start restoring.

## Deleting a Backup File

***“Connectivity” → “Card Settings” → “Backup/Restore” → “File Management”***

1. Select the desired folder.
2. Check off the desired files to delete and press [Delete].  
To delete all backup files, press [Options] and select “Check All” to check off all files. Then press [Delete].
3. Select “Yes” to start deleting.

## **Connecting WX-T930 to Your PC**

You can use the following functions by connecting the WX-T930 to your PC using a USB data cable or via *Bluetooth* wireless technology:

- 3G/GSM modem
- Handset Manager for WX-T930
- Music Manager for WX-T930
- Sync Manager for WX-T930

### **Note**

- *Operation with software not provided by Sharp is not guaranteed.*

## **System Requirements**

Operating System:

Windows 2000\*, Windows XP\*\*, Windows Vista

\* Service Pack 4 or later

\*\* Service Pack 2 or later

Supported Software:

Microsoft Outlook/Outlook Express

Interface:

USB port or *Bluetooth* wireless port

CD-ROM drive

To use Music Manager, DirectX9 and Windows Media Player 9 or later are required.

## **3G/GSM Modem**

You can use WX-T930 as a 3G/GSM modem to access the Internet from your PC. Connect your phone to your PC via *Bluetooth* wireless technology or USB interface. Software installation on your PC is required.

### **Modem via the USB Data Cable**

1. Insert the CD-ROM into your PC's CD-ROM drive.  
The WX-T930 CD-ROM screen is displayed.  
If the WX-T930 CD-ROM screen is not displayed, double-click [Launcher.exe] in your CD-ROM.
2. Select the USB driver from the on-screen instructions of your CD-ROM, and start installation of USB driver software following the on-screen instructions of your CD-ROM.
  - During installation, the on-screen instructions ask you to connect your phone to your PC. Power on your phone and attach the phone to the USB port of your PC using the USB data cable (optional accessory).
3. Follow the on-screen instructions to complete installation.

4. Select the modem driver from the on-screen instructions of your CD-ROM, and install modem driver software following the on-screen instructions of your CD-ROM.
5. Follow the on-screen instructions to use your phone as a modem driver.
  - When the on-screen instructions ask for the modem driver type, select the cable as a modem driver.

### **Modem via Bluetooth Connection**

1. Turn on the *Bluetooth* wireless function of your phone.  
For details, see “To Turn On or Off the Bluetooth Wireless Function” on page 152.
2. Pair your PC with your phone.  
For details on pairing your PC with your phone, see “To Search for Devices to be Paired” on page 152.
3. Insert the CD-ROM into your PC’s CD-ROM drive. The WX-T930 CD-ROM screen is displayed. If the WX-T930 CD-ROM screen is not displayed, double-click [Launcher.exe] in your CD-ROM.

4. Select the modem driver from the on-screen instructions of your CD-ROM, and install modem driver software following the on-screen instructions of your CD-ROM.
5. Follow the on-screen instructions to use your phone as a modem driver.
  - When the on-screen instructions ask for the modem driver type, select *Bluetooth* as a modem driver.

### **Note**

- *Modem communication is not possible while communicating with the Handset Manager via Bluetooth wireless technology or USB interface.*
- *It is not recommended that you make or answer calls when you are using WX-T930 as a GSM/GPRS modem. The operation may be interrupted.*
- *Your phone exhausts the battery when connected to a PC, even when not communicating.*
- *For a detailed explanation on how to use the modem driver, please click and refer to the help on the modem driver.*



## Handset Manager

You can transmit the following items between your phone and your PC, and can use Phonebook entries on your PC:

- Gallery files (pictures/sounds/video clips/themes/Flash<sup>®</sup> files/Other Documents data)
- Phonebook entries
- Schedule entries

### Via USB Data Cable

1. Insert the CD-ROM into your PC's CD-ROM drive. The WX-T930 CD-ROM screen is displayed. If the WX-T930 CD-ROM screen is not displayed, double-click [Launcher.exe] in your CD-ROM.
2. Select Handset Manager from the on-screen instructions of your CD-ROM, and start installation of Handset Manager software following the on-screen instructions of your CD-ROM.
  - If you have not installed the USB driver, follow steps 2 and 3 on page 158.

3. Follow the on-screen instructions to complete installation.
  - During installation, the on-screen instructions ask you to select an interface. Select the USB data cable as an interface.
4. Power on your phone and attach the phone to the USB port of your PC using the USB data cable (optional accessory).
5. Launch Handset Manager from the relevant folder.
6. Enter your handset code.
7. Follow the on-screen instructions of Handset Manager.

For details, see the User Guide Software which is installed within Handset Manager or our web-site, <http://www.sharp-mobile.com>.

## Via Bluetooth

1. Insert the CD-ROM into your PC's CD-ROM drive. The WX-T930 CD-ROM screen is displayed. If the WX-T930 CD-ROM screen is not displayed, double-click [Launcher.exe] in your CD-ROM.
2. Select Handset Manager from the on-screen instructions of your CD-ROM, and start installation of Handset Manager software following the on-screen instructions of your CD-ROM.
3. Follow the on-screen instructions to complete installation.
  - During installation, the on-screen instructions ask you to select an interface. Select *Bluetooth* as an interface.
4. Launch Handset Manager from the relevant folder.
5. Enter your handset code.
6. Follow the on-screen instructions of Handset Manager.

## Note

- *Some large files may not be able to be transmitted from the PC to the phone.*
- *Applications (Camera, Gallery, etc.) cannot be run when the phone is connected to the PC via Bluetooth wireless technology interface or USB data cable.*
- *If you have already installed Sharp Handset Manager, you need to uninstall the previous one.*
- *If you have trouble with installation, uninstall Handset Manager, restart your PC, reinstall Handset Manager and restart.*
- *For details, see the User Guide Software which is installed within Handset Manager or our web-site, <http://www.sharp-mobile.com>.*

## Music Manager

You can manage the playlist and exchange sound files on your PC. Available files are the sound files in the following formats: MP3, AAC, 3GPP.

## Tip

- *MP3 files with two or more periods (".") used in the file name cannot be saved.*

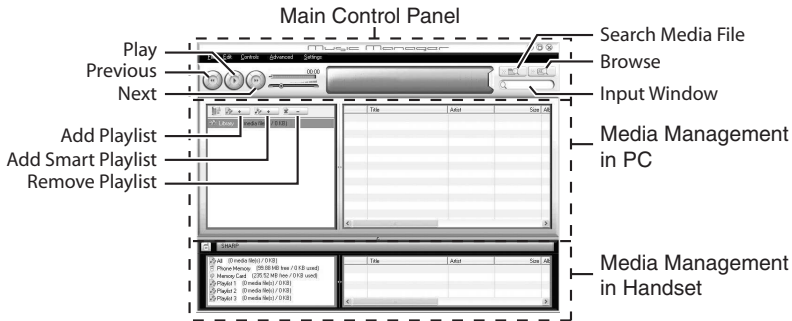

## Main Control Panel

Control all the main actions from here.

- Play: Plays back a file.
- Previous: Returns to the top portion of the current file.
- Next: Jumps to the next file.
- Search Media File: Searches for a media file.
- Browse: Browses all the media files sorted in Genre/Artist/Album.
- Input Window: Quickly finds the media files in Library or the playlist with keyword entry.

## Media Management in PC

Media files in PC can be easily explored in 2 main columns.

- Add Playlist: Creates a new playlist.
- Add Smart Playlist: Creates a new smart playlist.
- Remove Playlist: Removes a playlist.

## Media Management in Handset

Media files in Handset can be easily explored in 2 main columns.

- With the drag and drop operation, you can upload the sound files and the playlists from your PC, and also download them to your PC.
- With the drag and drop operation, you can change the order of tracks in the playlist of your PC.
- You can create a new playlist and delete an existing playlist.
- With the drag and drop operation, you can add a sound file to a playlist, and delete them from the playlist.
- You can edit the name of a playlist of your PC.
- You can edit the title, artist name, and album name of sound files of your PC (only available in MP3 format).

### **Tip**

- *To add tracks from your PC into the Music Manager library, go to “Advanced” then search music tracks.*
- *Once you have created your list, drag the list to the WX-T930 area on Music Manager, and the files will be uploaded to the WX-T930. If one or more of the files is already stored on the handset, Music Manager will not upload them again; the playlist will play the track already uploaded.*

- *Music Manager also allows you to import existing playlists (M3U file type) that you may have created using other media programs.*
- *Use Smart Playlist to automatically add tracks to a playlist based on criteria you can select.*

## **Sync Manager**

You can synchronise the following data with the data of Microsoft Outlook or Outlook Express on your PC.

- Phonebook entries
- Schedule entries

### **Tip**

- *You can set up Sync Manager to start up and synchronise automatically after you connect your phone to your PC via the USB data cable.*

## Troubleshooting

Problem	Solution
The phone does not turn on.	<ul style="list-style-type: none"><li>• Make sure the battery is properly inserted and charged.</li></ul>
PIN code or PIN2 code is rejected.	<ul style="list-style-type: none"><li>• Make sure you have entered the correct code (4 to 8 digits).</li><li>• Your SIM/USIM card/protected functions will become locked after three unsuccessful attempts.</li><li>• Contact your SIM/USIM provider if you do not have the correct PIN code.</li></ul>
The SIM/USIM card becomes locked.	<ul style="list-style-type: none"><li>• Enter the PUK code (8 digits) provided by your service provider (if supported).</li><li>• If the attempt is successful, enter the new PIN code and confirm your phone is operational again. Otherwise contact your dealer.</li></ul>

Problem	Solution
The display is difficult to read.	<ul style="list-style-type: none"><li>• Adjust the backlight brightness for the display.</li></ul>
Phone functions do not work after the phone is turned on.	<ul style="list-style-type: none"><li>• Check the radio signal strength indicator as you may be outside the service area.</li><li>• Check to see if any error message is displayed when you turn your phone on. If so, contact your dealer.</li><li>• Make sure the SIM/USIM card is correctly inserted.</li></ul>
Call quality is poor.	<ul style="list-style-type: none"><li>• Your current location may not provide good call quality (i.e., in a car or train). Move to a location where radio signal strength is greater.</li></ul>
Cannot send or receive text message.	<ul style="list-style-type: none"><li>• Make sure you are correctly subscribed for the Short Message Service, that the network supports this service, and that the centre number is set up correctly. If not, contact your network service provider.</li></ul>

Problem	Solution
Calls cannot be made or received.	<ul style="list-style-type: none"> <li>• If the message "Insert SIM Card" is displayed when the phone is switched on, you cannot use your SIM/USIM card or the SIM/USIM card is damaged. Contact your dealer or network service provider.</li> <li>• Check your call barring, fixed dialling setting, remaining battery and call forwarding settings.</li> <li>• Check if your phone is currently performing data communication using Infrared (IrDA), <i>Bluetooth</i> wireless technology interface or a USB data cable.</li> <li>• Check the remaining balance if you are using a pre-paid SIM/USIM card.</li> </ul>
Cannot access network service.	<ul style="list-style-type: none"> <li>• Check where your account has been registered and where the service is available.</li> </ul>
Limited memory available.	<ul style="list-style-type: none"> <li>• Delete any unnecessary data.</li> </ul>

Problem	Solution
Cannot connect to Multimedia Messaging Service provider.	<ul style="list-style-type: none"> <li>• MMS settings and configuration may be missing or incorrect or the network does not support it. Check your service provider's access point number. Contact your service provider to confirm the correct settings.</li> </ul>
Call is terminated unexpectedly.	<ul style="list-style-type: none"> <li>• Magnetised objects such as health necklaces placed near the phone may terminate the call. Keep your phone away from such objects.</li> </ul>
No entries are displayed in the Phonebook.	<ul style="list-style-type: none"> <li>• Confirm that the Source setting (Handset or SIM/USIM) is correct.</li> </ul>
Cannot receive OBEX data.	<ul style="list-style-type: none"> <li>• The OBEX data can only be received in stand-by.</li> </ul>

## **Safety Precautions and Conditions of Use**

Your phone conforms to international regulations insofar as it is used under normal conditions and in accordance with the following instructions.

### **Conditions of Use**

#### **Electromagnetic waves**

- Do not switch on your phone aboard an aircraft (as your phone may interfere with the aircraft's electronic systems). Current legislation forbids this use and legal action can be taken against the user.
- Do not switch on your phone in a hospital, except in designated areas.
- Use of your phone's function may affect the performance of medical electronic units (pacemakers, hearing aids, insulin pumps, etc.). When the phone function is on, do not bring it near medical equipment or into areas in which medical equipment is being used. If you have a hearing aid or a pacemaker, only use the phone on the opposite side of your body from where it is located. The phone should be kept at least 6 inches (15.24 cm) from a pacemaker ANYTIME the phone is switched on.

- Do not switch on your phone near gas or flammable substances.
- Observe the rules concerning the use of mobile phones at gasoline stations, chemical plants and at all sites where a risk of explosion exists.

#### **Caring for your phone**

- Do not allow children to use your phone without supervision.
- Do not open or attempt to repair your phone yourself. The product can only be repaired by authorised service personnel.
- Do not drop your phone or subject it to severe impacts. Bending the body and pushing the display or keys with extreme force could damage the phone.
- Do not use solvents to clean your phone. Use only a soft, dry cloth.
- Do not carry your phone in your back pocket as it could break when you sit down. The display is made of glass and is particularly fragile.
- Avoid touching the external connector on the underside of the phone, since the delicate components within can be damaged by static electricity.

## Mobile Light

### **Do not use Mobile Light near people's faces.**

Eyesight may be temporarily affected leading to accidents.

### **CAUTION**

Use of controls, adjustments or performance of procedure other than those specified herein may result in hazardous radiation exposure. As the emission level from Mobile Light LED used in this product is harmful to the eyes, do not attempt to disassemble the cabinet. Servicing is limited to qualified servicing station only.

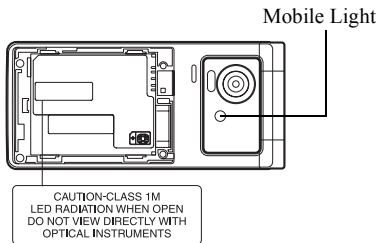
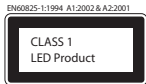

## **Mobile Light LED Properties**

- Emission Duration: Continuous
- Wavelength  
White: 400-700 nm
- Maximum Emission Output  
White: 240  $\mu$ W (1.2 mW inside handset)

## **Battery**

- Use your phone only with batteries, chargers and accessories recommended by the manufacturer. The manufacturer disclaims any liability for damage caused by the use of other chargers, batteries or accessories.
- Network configuration and phone usage will affect talk-time and stand-by time.**  
Using the games or camera will hasten battery consumption.
- When the battery charging alert is displayed on the screen, charge the battery as soon as possible.**  
If you continue using your phone ignoring the alert, the phone may cease to function, and all data and settings you have stored may be lost at any moment.
- Before removing the battery from the phone, make sure the phone is switched off.
- Replace and charge the new battery as soon as possible after removing the old one.



- Do not touch the battery terminals. Batteries can cause damage, injury or burns if a conductive material touches exposed terminals. When the battery is detached from the phone, use a cover made of non-conductive material for keeping and carrying the battery safely.
- Recommended temperature for using and storing batteries is approximately 20°C.
- The batteries' performance is limited in low temperatures, particularly below 0°C and the phone may not work temporarily regardless of the amount of remaining battery power.
- Exposing the phone to extreme temperatures will shorten battery life.
- The battery can be charged and discharged hundreds of times but it will eventually wear out. When the operating time (talk-time and stand-by time) is noticeably shorter than normal, it is time to buy a new battery.

#### CAUTION

RISK OF EXPLOSION IF BATTERY IS REPLACED  
BY AN INCORRECT TYPE,  
DISPOSE OF USED BATTERIES ACCORDING  
TO THE INSTRUCTIONS

See “Battery Disposal” on page 17.

#### Aerial Care

- Do not cover the hinge area of the phone (p. 15, No. 31) with your hand when in use as this may interfere with the performance of the built-in aerial. Call quality may deteriorate leading to shortened talk-time and stand-by time because the mobile phone has to operate on a higher power level than is necessary.
- Use only the aerial supplied or one approved by Sharp for your mobile phone. Using unauthorised or modified aerials may damage the mobile phone. Moreover, since the mobile phone may violate the appropriate regulations, it may lose performance or exceed the limitation of SAR levels.
- To avoid impaired performance, do not damage the aerial of the mobile phone.
- To avoid interfering with blasting operations, please turn off the mobile phone in a blasting area or in a place where a “turn off two-way radio” sign is posted.

## **Camera Operation**

- Learn picture quality, file formats, etc. beforehand.  
The taken pictures can be saved in JPEG format.
- Be careful not to move your hand while taking pictures.  
If the phone moves while taking a picture, the picture can become blurred. When taking a picture, hold the phone firmly to prevent it from moving, or use the delay timer.
- Clean the lens cover before taking a picture.  
Fingerprints, oils, etc. on the lens cover hinder clear focusing. Wipe them off with a soft cloth before taking a picture.

## **Others**

- As with any electronic storage unit, data may be lost or corrupted under various circumstances.
- Before connecting the phone with a PC or a peripheral unit, read the operation manual for the other unit carefully.
- If the phone's battery has been removed for some time, or the phone has been reset, the unit's clock and calendar may be reinitialised. The date and time should be updated in this case.

- Do not place magnetic cards near your phone as it may damage the recorded data.

## **Environment**

- Keep your phone away from extreme heat. Do not leave it on the dashboard of a car or near a heater. Do not leave it in any place that is extremely damp or dusty.
- Since this product is not waterproof, do not use it or store it where fluids such as water can splash onto it. Raindrops, water spray, juice, coffee, steam, perspiration, etc. will also cause malfunctions.

## Precautions Concerning Vehicle Use

- It is the user's responsibility to check the local laws governing the use of a mobile phone in vehicles. Pay full attention to driving. Pull off to the side of the road, park the car, and switch off the engine before making or answering a call.
- Use of your phone's function may interfere with the vehicle's electronic systems, such as the ABS anti-lock brakes or the air-bag. To ensure no such problem occurs, please check with your dealer or car manufacturer before connecting your phone.
- Only allow qualified service maintenance personnel to install vehicle accessories.

The manufacturer disclaims any liability for damage which may result as a consequence of improper use or use contrary to the instructions contained herein.

## SAR (Taiwan)

Your Sharp mobile phone has been designed, manufactured and tested so as not to exceed the limits for exposure to electromagnetic fields as required by the NCC. These limits are part of comprehensive guidelines developed by independent scientific organisations. The guidelines include a substantial safety margin designed to assure the safety of the phone user and others and to take into account variations in age and health, individual sensitivities and environmental conditions. The NCC rules provide for the amount of radio frequency electromagnetic energy absorbed by the body when using a mobile phone to be measured by reference to the Specific Absorption Rate (SAR). The SAR limit for the general public is currently 2.0 watts per kilogram averaged over 10 grams of body tissue. Your Sharp mobile phone SAR value is X.XXX W/kg. This has been tested to ensure that this limit is not exceeded even when the phone is operating at its highest certified power. In use however your Sharp mobile phone may operate at less than full power because it is designed to use only sufficient power to communicate with the network.

## **SAR (Europe)**

Your Sharp mobile phone has been designed, manufactured and tested so as not to exceed the limits for exposure to electromagnetic fields recommended by the Council of the European Union. These limits are part of comprehensive guidelines developed by independent scientific organisations. The guidelines include a substantial safety margin designed to assure the safety of the phone user and others and to take into account variations in age and health, individual sensitivities and environmental conditions. European standards provide for the amount of radio frequency electromagnetic energy absorbed by the body when using a mobile phone to be measured by reference to the Specific Absorption Rate (SAR). The SAR limit for the general public is currently 2 watts per kilogram averaged over 10 grams of body tissue. Your Sharp mobile phone SAR value is 0.601 watts per kilogram. This has been tested to ensure that this limit is not exceeded even when the phone is operating at its highest certified power. In use however your Sharp mobile phone may operate at less than full power because it is designed to use only sufficient power to communicate with the network.

## **FCC NOTICE**

This device complies with part 15 of the FCC Rules.

Operation is subject to the following two conditions:

- (1) This device may not cause harmful interference, and
- (2) this device must accept any interference received, including interference that may cause undesired operation.

### **Information to User**

This equipment has been tested and found to comply with the limits of a Class B digital device, pursuant to Part 15 of the FCC Rules. These limits are designed to provide reasonable protection against harmful interference in a residential installation. This equipment generates, uses and can radiate radio frequency energy and, if not installed and used in accordance with the instructions, may cause harmful interference to radio communications.

However, there is no guarantee that interference will not occur in a particular installation; if this equipment does cause harmful interference to radio or television reception, which can be determined by turning the equipment off and on, the user is encouraged to try to correct the interference by one or more of the following measures:

1. Reorient/relocate the receiving antenna.
2. Increase the separation between the equipment and receiver.
3. Connect the equipment into an outlet on a circuit different from that to which the receiver is connected.
4. Consult the dealer or an experienced radio/TV technician for help.

**CAUTION:** Changes or modifications not expressly approved by the manufacturer responsible for compliance could void the user's authority to operate the equipment.

### **Exposure to Radio Waves**

#### **THIS MODEL PHONE MEETS THE GOVERNMENT'S REQUIREMENTS FOR EXPOSURE TO RADIO WAVES.**

Your wireless phone is a radio transmitter and receiver. It is designed and manufactured not to exceed the emission limits for exposure to radio frequency (RF) energy set by the Federal Communications Commission of the U.S. Government. These limits are part of comprehensive guidelines and establish permitted levels of RF energy for the general population. The guidelines are based on standards that were developed by independent scientific organizations

through periodic and thorough evaluation of scientific studies. The standards include a substantial safety margin designed to assure the safety of all persons, regardless of age and health.

The exposure standard for wireless mobile phones employs a unit of measurement known as the Specific Absorption Rate, or SAR. The SAR limit set by the FCC is 1.6 W/kg.\* Tests for SAR are conducted using standard operating positions specified by the FCC with the phone transmitting at its highest certified power level in all tested frequency bands. Although the SAR is determined at the highest certified power level, the actual SAR level of the phone while operating can be well below the maximum value. This is because the phone is designed to operate at multiple power levels so as to use only the power required to reach the network. In general, the closer you are to a wireless base station aerial, the lower the power output.

Before a phone model is available for sale to the public, it must be tested and certified to the FCC that it does not exceed the limit established by the government-adopted requirement for safe exposure. The tests are performed in positions and locations (e.g., at the ear and worn on the body) as required by the FCC for each model. The highest SAR value for this model phone when tested for use at the ear is 0.612 W/kg and when worn on the body, as described in this user guide, is 0.504 W/kg.

Body-worn Operation; This device was tested for typical body-worn operations with the back of the phone kept 1.5 cm from the body. To maintain compliance with FCC RF exposure requirements, use accessories that maintain a 1.5 cm separation distance between the user's body and the back of the phone. The use of belt-clips, holsters and similar accessories should not contain metallic components in its assembly.

The use of accessories that do not satisfy these requirements may not comply with FCC RF exposure requirements, and should be avoided. While there may be differences between the SAR levels of various phones and at various positions, they all meet the government requirement for safe exposure.

The FCC has granted an Equipment Authorization for this model phone with all reported SAR levels evaluated as in compliance with the FCC RF emission guidelines. SAR information on this model phone is on file with the FCC and can be found under the Display Grant section of <http://www.fcc.gov/oet/fccid> after searching on FCC ID APYHRO00084.

Additional information on Specific Absorption Rates (SAR) can be found on the Cellular Telecommunications & Internet Association (CTIA) web-site at <http://www.phonefacts.net>.

- \* In the United States and Canada, the SAR limit for mobile phones used by the public is 1.6 watts/kg (W/kg) averaged over one gram of tissue. The standard incorporates a substantial margin of safety to give additional protection for the public and to account for any variations in measurements.

## **Out of Warranty List**

This limited warranty shall not apply in respect of the following:

- (i) Any deterioration due to normal wear and tear including all plastic surfaces and all other externally exposed parts that are scratched or damaged due to normal customer use.
- (ii) Defects caused by the Product being subjected to any of the following: use in contradiction with the user guide, rough handling, exposure to moisture, dampness or extreme thermal or environmental conditions or rapid changes in such conditions, corrosion, oxidation, unauthorised modifications or connections, unauthorised opening or repair, repair by use of unauthorised spare parts, misuse, improper installation, accident, forces of nature, spillage of food or liquid, influence from chemical products or other acts beyond Sharp's reasonable control (including but not limited to lifetime, and breakage of or damage to aerials) unless the defect was caused directly by defects in materials or workmanship.
- (iii) Products in respect of which the product serial number or the IMEI number has been removed, erased, defaced, altered or made illegible.

- (iv) Defects caused by the fact that the Product was used with or connected to a product or an accessory not manufactured or supplied by Sharp or was used other than for its intended use.
- (v) Defects caused by a defective function of the cellular network.
- (vi) Defects caused by the fact that the battery was short-circuited or seals of the battery enclosure or cells were broken or show evidence of tampering or the battery was used in equipment other than for which it has been specified.
- (vii) Defects caused by the need to upgrade Products software due to changes in cellular network parameters.
- (viii) Products operated outside published maximum ratings.
- (ix) Products rented on a monthly basis.

### **Charger Plug:**

Do not use the AC Charger if the plug does not fit the socket.

# **Index**

- A**
  - Alarms 111
  - Area Info 84
- B**
  - Battery 16, 167
- C**
  - Calculator 115
  - Calendar 106
  - Call Functions 32, 151
    - Auto Redial 146
    - Call Restrictions 143
    - Call Timers 146, 151
    - Call Waiting 35, 146
    - Conference Call 35
    - Data Counter 151
    - Earpiece Volume 34
    - Emergency Calls 32
    - International Calls 32
    - Make Another Call 34
    - Minute Minder 145
    - Muting the
      - Microphone 36, 38, 142
    - My Phone
      - Number 142
    - Redialling 33
  - Rejecting a Call 34, 37, 144
  - Sending a Busy Tone 34, 37
  - Speaker 34, 38, 142
  - Speed Dialling 33, 56
  - Video Calling 38, 141
  - Voice Call 32, 34
  - Voicemail & Diverts 139
- Call Log 151
- Camera 64
  - Background Saving 74
  - Continuous Shoot 71
  - Digital Zoom 66
  - Exposure 66
  - Face Auto Focus 70
  - Focus Mode 66
  - ISO Sensitivity 70
  - Long Exposure 72
  - Mobile Light 68
  - Panorama 71
  - Picture Quality 67
  - Picture Size 70, 75
  - Recording Time 75
- Recording Video
  - Clips 65, 76
  - Review 68
  - Scene 73
  - Set Send Key 75
  - Settings 66
  - Shortcut Keys 69
  - Switching Modes 64
  - Taking Pictures 64
  - Video Quality 67
- Cell Broadcasts 83
- Characters
  - Changing the Input Method 41
  - Cutting, Copying, Pasting Text 48
  - Entering Characters 40
  - Input Language 40
  - Notepad 47, 120
  - Pictograms 47
  - Stroke mode 45
  - User Dictionary 45
- Chinese User
  - Dictionary 46
  - Creating 46
  - Deleting 46
  - Editing 46
- Conditions of Use 166
- Connectivity 152
- Countdown Timer 118
- D**
  - Display Indicators 22
  - Document Viewer 119
- E**
  - Expenses Memo 116
- F**
  - FET Mobile Internet 89
    - Browser Settings 91
    - Navigating a WAP or Web Page 90
  - Flash® 96
- G**
  - Gallery 93
  - Other Documents 97
- H**
  - Handset Code 138
  - Help 123
  - Hour Minder 119
- I**
  - Infrared 155



**J**

Java™ 101  
Java™ Settings 103

**M**

Mass Storage 156  
Master Reset 139  
Memory Card 19  
Memory Status 56, 100,  
110, 115  
Messaging 77  
    Attaching/Removing  
    Data 79  
    Creating a Message 78  
    Drafts Box 81  
    Email 77, 87  
    Forwarding a  
    Message 82  
    Mailing List 52  
    MMS 77, 82, 85  
    Reading a Message 81  
    Replying to a  
    Message 82  
    Sending Options 80  
    Settings 84  
    SMS 77, 85  
Motion Control 28, 136  
Multimedia 57

Music Player 60  
    Adding a File 62  
    Adding a New  
    Playlist 63  
    Downloading  
    Music 63  
    Playing Back  
    Music 60  
    Searching for a File 62  
    Sorting 62

**N**

Navigating Functions 25

**O**

Off Line Mode 147  
Organiser 106

**P**

PC Connection 158  
Phonebook  
    Adding New Entry 49  
    Dialling from an  
    Entry 51  
    Editing Entries 53  
    Manage Groups 55  
    Message Groups 52  
    Saving a Number 50  
    Saving an Address 81  
    Saving an Image 94

Searching the List 50  
Sending a Message 52  
Storage Memory 49  
Thumbnail 53

Phonebook Lock 138  
Pictures 93  
PIN/PIN2 Code 137  
Power On and Off 21

**S**

Safety Precautions 166  
Screensavers 105  
Settings 125  
    Date & Time 134  
    Display 126  
    Font 128  
    Internet 148  
    Language 135  
    Network 146  
    Profiles 125  
    Security 137  
    Sound 131

Shortcut Keys 26  
SIM Application 124  
SIM/USIM Card 16  
Sound Gallery 95  
Stopwatch 117  
Streaming 60

**T**

Tasks 112  
Themes 95  
Troubleshooting 164

**U**

USB Charge 156

**V**

VeilView 5, 127  
Video Gallery 94  
Videos 57  
    Adding a File 58  
    Adding a New  
    Playlist 58  
    Downloading  
    Video 60  
    Playing Back Video 57  
    Searching for a File 57  
    Settings 59  
Voice Recorder 121

**W**

World Clock 118

## **X**

XT9 Text Input

Using BoPoMoFo

Input mode 44

Using Stroke mode 45

Using XT9 English

Mode 42



# Quick Reference WX-T930

## Function Key Shortcuts

To display the Main menu.	ⓘ
To mute and unmute the microphone during a call.	☎ [Mute]
To turn Silent mode on.	Long press [M].

## Special Features

To adjust earpiece volume during a call	Press [V] or [V] a few times.
To display: Individual Call Timer	ⓘ [0-9] [5] [7], then select "Received Calls" or "Dialled Calls".
Reset Call Timer	ⓘ [0-9] [5] [7], then select "Clear Timers".

## Navigating Menus

Press ⓘ to display the Main menu.

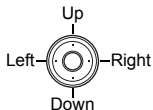

## Messages

Press ⓘ during stand-by and select "Messages".  
Press [M] or [M] to scroll.  
Press ⓘ.

## Create Message

- \_\_\_\_\_ Create Message
- \_\_\_\_\_ Create Email

## Message

- \_\_\_\_\_ Create Message
- \_\_\_\_\_ Inbox
- \_\_\_\_\_ Drafts
- \_\_\_\_\_ Sent
- \_\_\_\_\_ Outbox
- \_\_\_\_\_ Templates

## Email

- \_\_\_\_\_ Create Email
- \_\_\_\_\_ Inbox
- \_\_\_\_\_ Drafts
- \_\_\_\_\_ Sent
- \_\_\_\_\_ Outbox
- \_\_\_\_\_ Templates

## Alert Inbox

## Cell Broadcasts

- \_\_\_\_\_ Switch On/Off
- \_\_\_\_\_ Read Messages
- \_\_\_\_\_ Settings

## Area Info

- \_\_\_\_\_ On
- \_\_\_\_\_ Off

## Messaging Settings

- \_\_\_\_\_ General Settings
- \_\_\_\_\_ SMS Settings
- \_\_\_\_\_ MMS Settings
- \_\_\_\_\_ Email Settings
- \_\_\_\_\_ Speed Mail List

## Memory Status

## Basic Operation

Power On/Off	Long press [P].
Make a call	Enter number, press [C].
Answer a call	Press [C].
End a call	Press [E].

## Phonebook

Storing name and number

1. Enter the phone number in stand-by.
2. Press [O] [Options], select "Save Number" & "As New".
3. Fill each field.
4. Press [S] [Save].

## Camera/Video

Taking pictures/Recording video clips

1. Press [C], select "Camera".
2. Press [M] to switch between photo and video camera modes.
3. Press ⓘ to take a picture or video.

## Voice Recorder

Press ⓘ, select "Organiser", press [R] twice, then select "Voice Recorder".

## Voice Mail

Long press [V] (FET Voice Mail as default setting).  
Alternatively, direct dial [2] [2] [2] (FET Voice Mail as default setting).

# WX-T930 Quick Reference Menu

Press during stand-by mode.

Press , , , or to navigate to required location.

	<b>1 Java™</b>
1-1	Java™ Gallery
1-2	Java™ Settings
1-3	Java™ Information

	<b>2 FET Mobile Internet</b>
2-1	Homepage
2-2	Bookmarks
2-3	Alert Inbox
2-4	My Saved Page
2-5	Go to URL
2-6	Access History
2-7	Browser Settings

	<b>3 Organiser</b>
(Tab 1; Tools 1)	
3-1	Calendar
3-2	Alarms
3-3	Tasks
3-4	Calculator
3-5	Expenses Memo
(Tab 2; Tools 2)	
3-1	Show Watch
3-2	Countdown Timer
3-3	World Clock
3-4	Hour Minder
(Tab 3; Tools 3)	
3-1	Document Viewer
3-2	No-lepad
3-3	Voice Recorder
3-4	Scanner
3-5	Phone Help
3-6	Scratch Pad

	<b>4 Messages</b>
4-1	Create Message
4-2	Message
4-3	Alert Inbox
4-4	Alert Inbox
4-5	Cell Broadcasts
4-6	Area Info
4-7	Messaging Settings
4-8	Memory Status

	<b>5 Camera</b>
5-1	Still Camera
5-2	Video Camera
5-3	Barcode Scan
5-4	Review
5-5	Still Camera Settings
5-6	Video Camera Settings

	<b>6 Gallery</b>
6-1	Picture Gallery
6-2	Video Gallery
6-3	Sound Gallery
6-4	Themes
6-5	Java™ Gallery
6-6	Flash®
6-7	Other Documents
6-8	Memory Status

	<b>7 Multimedia</b>
7-1	Video Player
7-2	Streaming Player
7-3	Music Player
7-4	Java™
7-5	Camera

	<b>8 Call Manager</b>
8-1	Phonebook
8-2	Add New
8-3	Call Voicemail
8-4	Manage Groups
8-5	My Card
8-6	Speed Dial List
8-7	Message Logs
8-8	Phonebook Settings
8-9	Service Dialling No.
8-10	Advanced

	<b>9 Settings</b>
(Tab 1; Phone Settings)	
9-1	Profiles
9-2	Display Settings
9-3	Themes
9-4	Sound Settings
9-5	Date & Time
9-6	Language
9-7	Motion Control
9-8	Screen Timeout
9-9	Emergency Volume
9-10	Change Menu
9-11	Security Settings
9-12	Master Reset
(Tab 2; Call/Video Call)	
9-1	Voicecall & Diverts
9-2	Video Calling Settings
9-3	Show Your Number
9-4	Restrict Calls
9-5	Minute Minder
9-6	Auto Answer
9-7	Call Waiting
9-8	Call Timer
9-9	Display Call Cost
9-10	Auto Redial
(Tab 3; Network Settings)	
9-1	Network Settings
9-2	Off Line Mode
9-3	Internet Settings



	<b>10 SIM Application</b>
--	---------------------------

	<b>11 Call Log</b>
11-1	All Calls
11-2	Dialled Numbers
11-3	Missed Calls
11-4	Received Calls
11-5	Call Timers
11-6	Call Costs
11-7	DAB Counter

	<b>12 Connectivity</b>
12-1	Bluetooth
12-2	Infrared
12-3	Mass Storage
12-4	USB Charge
12-5	Car Charger

English user manual:  
Maker: SHARP CORPORATION  
Importer: FarEasTone Telecommunications Co., Ltd.  
Address: 468, Ruei Guang Rd., Nei Hu, Taipei Taiwan  
Tel: +886 2 8793 5000  
[www.fetnet.net](http://www.fetnet.net)

FarEasTone mobile customers please dial 888 for customer services