

SH-04A

ISSUE DATE:

'09. ●

NAME:

PHONE NUMBER:

MAIL ADDRESS:

INSTRUCTION MANUAL



^{NTT}**docomo**

docomo **PRO** series







Precautions (ALWAYS FOLLOW THESE DIRECTIONS)

- Before use, read these “Precautions” carefully and use your FOMA properly. Keep this manual in a safe place for future reference.
- These precautions contain information intended to prevent bodily injury to the user and to surrounding people, as well as damage to property, and must be observed at all times.

The following symbols indicate the different degrees of injury or damage that may occur if information provided is not observed and the FOMA terminal is used improperly.

 Danger	This symbol indicates that “death or serious bodily injury may directly and immediately result from improper use”.
 Warning	This symbol indicates that “death or serious bodily injury may result from improper use”.
 Caution	This symbol indicates that “bodily injury and/or property damage may result from improper use”.

The following symbols indicate specific directions.

 Don't	Indicates a prohibited action.
 No disassembly	Indicates not to disassemble the device.
 No wet hands	Indicates not to handle the device with wet hands.
 No liquids	Indicates not to use the device near water or get it wet.
 Instruction	Indicates that instructions specified are compulsory (must be followed).
 Unplug	Indicates that the power cord must be unplugged from the outlet.

“Precautions” is explained in the following six sections.

- Handling the FOMA terminal, battery pack, adapters (chargers), and FOMA card (general) P. 11
- Handling the FOMA terminal P. 12
- Handling battery pack P. 15
- Handling adapters (chargers) P. 16
- Handling FOMA card P. 17
- Handling mobile phones near electronic medical equipment P. 17

Handling the FOMA terminal, battery pack, adapters (chargers), and FOMA card (general)

 Danger



Do not use, store, or leave the FOMA terminal, battery pack, adapters (chargers) or FOMA card in locations subject to high temperatures, such as near a fire, in direct sunlight, or inside a car on a hot day.

The FOMA terminal may become deformed or malfunction. In addition, the battery pack may leak, overheat, explode, catch fire or suffer performance loss and a reduced service life. Part of the casing may also become hot and cause burns.



No disassembly

Do not attempt to disassemble or modify. In addition, do not attempt to solder.

May cause accidents such as fire, bodily injury, electric shock or malfunction. In addition, the battery pack may leak, overheat, explode or catch fire.



No liquids

Do not get the FOMA terminal, battery pack, adapters (chargers) or FOMA card wet.

Contact with water, pet urine, and other liquids may cause overheating, electric shock, fire, malfunction or bodily injury. Be attentive to where and how you use the handset.



Instruction

Use only the battery packs and adapters (chargers) specified by NTT DOCOMO for use with the FOMA terminal.

The use of devices other than those specified may cause the FOMA terminal, battery pack or other devices to leak, overheat, explode, catch fire or malfunction.

- Battery Pack SH18
 - Desktop Holder SH24
 - FOMA AC Adapter 01/02
 - FOMA DC Adapter 01/02
 - FOMA Dry Battery Adapter 01
 - FOMA USB Cable with Charge Function 02
 - FOMA Portable Charging Adapter 01
- ※ For information on other compatible products, contact a docomo Shop or retailer.

 Warning



Don't

Do not place the battery pack, FOMA terminal, adapters (chargers), or FOMA card inside cooking appliances such as microwave ovens or pressure cookers.

The battery pack may leak, overheat, explode or catch fire, and the FOMA terminal and adapters (chargers) may overheat, emit smoke or catch fire. The internal circuitry may also be damaged.



Don't

Do not subject the FOMA terminal to strong impacts or throw it.

The battery pack may leak, overheat, explode or catch fire. Other devices may also be damaged or cause a fire.



Don't

Do not allow conductive materials (such as metal objects and pencil lead) to come into contact with the charger terminal or external device terminal. In addition, do not insert such objects.

The battery pack may short-circuit and cause a fire or malfunction.



Instruction

Make sure to turn off the mobile phone in locations such as gas stations where flammable gas is generated.



In addition, do not charge the battery. It may cause a gas explosion or fire.

To use Osaifu-Keitai in locations such as gas stations, make sure to turn off the power in advance (If the IC card lock is set, disable the lock before turning off the power).

-  **Instruction** If you notice anything unusual, such as an unusual odor, overheating, discoloration or deformation during use, charging or storage, immediately follow the instructions below.
1. **Unplug the power cord from the outlet or cigarette lighter socket.**
 2. **Turn off the FOMA terminal.**
 3. **Remove the battery pack from the FOMA terminal.**

Continued use (charging) may cause overheating, explosion, or fire. In addition, the battery pack may leak.

Caution

-  **Don't** **Do not leave the FOMA terminal on unstable surfaces, such as on a wobbling table or sloped surface.**
- The FOMA terminal may fall and cause injury or be damaged.
-
-  **Don't** **Do not store the FOMA terminal in locations that are subject to humidity, dust or high temperatures.**
- May cause a malfunction.

-  **Instruction** **If being used by a child, have a guardian teach him/her the proper handling procedures. In addition, check that the child is using the FOMA terminal as directed.**

May result in bodily injury.

-  **Instruction** **Keep the FOMA terminal out of the reach of young children.**
- A young child may swallow components or suffer other bodily injury.

-  **Instruction** **Be very careful when using the FOMA terminal connected to adapters (chargers) repeatedly or for long periods of time.**
- The FOMA terminal, battery pack or adapters (chargers) may become warm if i-αppli, Videophone, or 1Seg is used for a long time while charging. Touch high temperature areas for a prolonged period of time may cause skin irritations, itchiness, or low-temperature burn in some people.

Handling the FOMA terminal

Warning

-  **Don't** **Do not aim the Infrared port towards the eyes.**

May cause eye injury. In addition, do not aim or direct the Infrared port towards another Ir device as this may cause the device to malfunction.

-  **Don't** **Do not point the illuminated light directly at someone's eyes.**

May damage eyesight. May also cause momentary sight loss or startle someone and cause an accident.

-  **Don't** **Do not put the FOMA terminal in the place where it could be affected by an expanded airbag, e.g., on the dashboard.**

If the air bag inflates, the FOMA terminal may hit you or others around you, resulting in bodily injury or damage to the FOMA terminal or other property.

-  **Don't** **If you are using electronic medical equipment, do not put the FOMA terminal in your breast pocket or in the inside pocket of your jacket.**

Using the FOMA terminal in close proximity to electronic medical equipment may cause the equipment to malfunction.



Don't

Do not allow water or other liquids, metal, flammable material, or other foreign objects to enter the FOMA card or microSD Card port on the FOMA terminal.

May cause a fire, electric shock or other malfunctions.



Don't

Do not shine the light at anyone driving a car or other vehicles.

This may prevent a driver from driving safely and cause a traffic accident.



Instruction

Turn off the FOMA terminal in areas where the use of mobile phones is prohibited, such as in aircraft or hospitals.

The FOMA terminal may interfere with the operation of electronic devices and electronic medical equipment. In addition, if Auto power ON function is set to ON, disable this function before turning off your mobile phone. Follow the instructions given by the respective medical facilities regarding the use of mobile phones on their premises. In addition, actions such as using on a mobile phone aboard aircraft are prohibited and may be punishable by law.



Instruction

During a call in which Hands-free is set, keep the FOMA terminal away from the ears. When you attach the earphone/microphone to the FOMA terminal to play games or music, do not make the volume too loud.

Excessive high volume may damage your hearing. Also it may prevent you from hearing the ambient sounds and cause an accident.



Instruction

If you have a weak heart, take extra precautions when setting functions such as the Vibrator and Ring tone volume for incoming calls.

Various settings may have effects on your heart.



Instruction

If you hear thunder while using the FOMA terminal outdoors, put the antenna back into the FOMA terminal, immediately turn it off and move to a safe location.

There is a risk of being struck by lightning and suffering electric shock.



Instruction

Turn the FOMA terminal off near high-precision electronic devices or devices that use weak electronic signals.

The FOMA terminal may interfere with the operation of electronic devices.

Take particular care with the following devices:

Hearing aids, implanted cardiac pacemakers, implanted cardioverter-defibrillators, or other electronic medical equipment. Fire alarms, automatic doors, and other equipment controlled by electronic signals. If you use an implanted cardiac pacemaker, implanted cardioverter-defibrillator or other electronic medical equipment, contact the respective manufacturer or vendor to check whether the operation of the equipment is affected by signals.



Instruction

In case that the display part or camera lens is damaged, make sure to pay attention to a broken glass and the exposed inside of the FOMA terminal.

The surface of the display is covered by a protective film or the surface of camera lens are covered by a plastic panel so as to minimize the possibility of glass scattering. However, touching the broken display or camera lens may cause injury.

Caution



Do not swing the FOMA terminal by its antenna, strap, etc.

The FOMA terminal may hit you or others around you, resulting in bodily injury or damage to the FOMA terminal or other property.



Do not use the FOMA terminal in area with many people.

The antenna may hit others, resulting in an accident such as bodily injury.



Do not use the FOMA terminal with the damaged antenna.

Touching the antenna may cause an accident such as burn or other injuries.



When using Motion tracking, confirm the safety of surroundings, hold the FOMA terminal securely and do not swing it around more than necessary.

Use Motion tracking to operate by tilting and shaking (or swinging) the FOMA terminal. The FOMA terminal may hit people or objects, if shaken (or swung) too much, and cause a serious accident or damage, etc.



If using Motion tracking with the FOMA terminal to which metallic straps or others are attached, be careful not to hit people or objects with the straps.

May result in bodily injury or damage to the FOMA terminal or other property.



Never place a magnetic card near or in the FOMA terminal.

The stored magnetic data in cash cards, credit cards, telephone cards, floppy disks, etc. may be erased.



Never place magnetized items near the FOMA terminal.

Putting highly magnetized items closer may cause a malfunction.



If the display is broken and the liquid crystal then leaks, do not lick or inhale the liquid or get the liquid on your skin. If the liquid comes into contact with your eyes or mouth, immediately rinse your eyes or mouth with clean water and see a doctor. If the liquid comes into contact with your skin or clothes, immediately wipe it off with alcohol, and wash with water and soap.

May result in loss of eyesight and harmful to your skin.



While the ring tone is ringing or a melody is played on the FOMA terminal, do not put the ears closer to the speaker.

This may cause hearing loss.



On the surface of the display, there is a protective film for securing the safety (for preventing the reinforced glass panel from shattering) in case of the damage caused by a drop, impact, etc. Do not forcibly peel off or scratch this film.

Using the FOMA terminal with the film removed may cause a bodily injury when the display is damaged.

 **Using the FOMA terminal in an automobile may sometimes affect the electronic equipment in some vehicle models.**

In such cases, stop using the FOMA terminal, as this could impede safe driving.

 **Use of the FOMA terminal may cause skin irritations such as itchiness, rashes or eczema in some people. If this occurs, immediately stop using the FOMA terminal and seek medical treatment.**

The following parts contain metals.

Part	Material	Surface treatment
Surface of FOMA terminal (back of display side)	Magnesium	Coating
Surface of FOMA terminal (slide hinge section on the back of display side)	SUS	
Metal section of 1Seg antenna	Brass	Nickel plating
External connector terminal	SUS	
Inside microSD Memory Card slot		
Charger terminal		Gold plating

 **Do not close the FOMA terminal on your fingers or objects such as the strap.**
May result in bodily injury or cause a malfunction.

 **Watch 1Seg in a well-lit place, keeping a certain distance from the screen.**
Otherwise, eyesight may be decreased.

Handling battery pack

Check the type of battery using the information printed on the battery pack label.

Label	Battery type
Li-ion 00	Lithium-ion

Danger

 **Do not touch terminals with metallic objects such as wires. In addition, do not carry or store the battery pack with metallic necklaces, etc.**
The battery pack may leak, overheat, explode or catch fire.

 **If you are having difficulty fitting the battery pack to the FOMA terminal, do not use excessive pressure to force the battery into place. Check that the battery pack is facing the correct direction before you attach it.**

The battery pack may leak, overheat, explode or catch fire.

 **Do not throw the battery pack into a fire.**

The battery pack may leak, overheat, explode or catch fire.

 **Do not puncture, hit with a hammer or step on the battery pack.**

The battery pack may leak, overheat, explode or catch fire.

 **If the battery fluid comes into contact with your eyes, do not rub your eyes but immediately rinse your eyes with clean water. Then seek prompt medical treatment.**

May result in loss of eyesight.

Warning



If any trouble is found on the battery pack due to an external impact such as a deformation or scratches caused by a drop, immediately stop using it.

The battery pack may leak, overheat, explode or catch fire. Other equipment may also be damaged or catch fire.



If the battery pack is not fully charged after the specified time has elapsed, stop charging.

The battery pack may leak, overheat, explode or catch fire.



If the battery pack leaks or emits an unusual odor, immediately stop use and move it away from any flame or fire.

The battery fluid is flammable and could ignite, causing a fire or explosion.



Prevent your pet from biting the battery pack.

The battery pack may leak, overheat, explode or catch fire. Other equipment may also be damaged or catch fire.

Caution



Do not dispose of used battery packs in ordinary garbage.

May cause fires or damage to the environment. Place tape over the terminals to insulate unnecessary battery packs, and take them to a docomo Shop, retailer or institution that handles used batteries in your area.



Do not charge a wet battery pack.

The battery pack may overheat, catch fire or explode.



If the battery fluid comes into contact with your skin or clothing, stop using the FOMA terminal immediately and rinse it off thoroughly with clean water.

Battery fluid is harmful to your skin.

Handling adapters (chargers)

Warning



Do not use if the adapter's (charger's) cord or power cord is damaged.

May cause electric shock, overheating or fire.



Never use the AC adapter or desktop holder in humid locations such as a bathroom.
May result in electric shock.



The DC adapter should only be used in negative grounded vehicles. Never use these adapters in positive grounded vehicles.
May cause a fire.



Do not touch the FOMA terminal or adapters (chargers) if you hear thunder.
There is a risk of being struck by lightning and suffering electric shock.



Take care not to short-circuit the charging terminal when connected to an outlet or cigarette lighter socket. Also, take care not to allow any part of your body (hands, fingers, etc.) to come into contact with the charging terminal.
May result in a fire, equipment malfunction, electric shock or bodily injury.



Don't

Place the charger and desktop holder on stable surfaces when charging. In addition, do not cover or wrap the charger or desktop holder with clothing or bedding.

The FOMA terminal may detach, overheat, or cause a fire or malfunction.



Don't

Do not place heavy objects on the adapter's (charger's) cord or power cord.

May cause an electric shock or fire.



No wet hands

Do not handle the cord and plug of the adapters (chargers) with wet hands.

May result in electric shock.



Instruction

Always use the specified power supply and voltage.

Using the incorrect voltage may cause a fire or malfunction.

When using overseas, use the AC adapter that is available overseas.

AC adapter: 100V AC

DC adapter: 12/24V DC (for negative grounded vehicles only)

AC adapter available overseas: 100 to 240V AC (Connect only with household AC outlet)



Instruction

If the fuse in the DC adapter blows, always replace it with a fuse of the specified type.

Using the fuse other than the specified one may cause a fire or malfunction. Refer to the respective manuals for information on the correct fuse specifications.



Instruction

Wipe off any dust on the power plug.

May cause a fire.



Instruction

When plugging the AC adapter into the outlet, make sure that no metallic straps or other metallic objects are caught between the plug and the socket.

May cause electric shock, short-circuiting or fire.



Instruction

Always grasp the power plug when unplugging the adapters (chargers) from the outlet or cigarette lighter socket. Do not forcibly pull by the adapter's (charger's) cord or power cord.

Pulling on the cord may damage the cord and cause an electric shock or fire.



Unplug

Unplug the power cord from the outlet when not using for a long time.

May cause an electric shock, fire, or malfunction.



Unplug

Should water or other liquids enter the adapters (chargers), remove the power plug from the outlet or cigarette lighter socket immediately.

May cause an electric shock, smoke emission or fire.



Unplug

Always unplug the power plug from the outlet or cigarette lighter socket before cleaning the adapters (chargers).

May result in electric shock.

Handling FOMA card

Caution



Instruction

Be careful with the cutting surface when detaching the FOMA card (IC).

May cause injuries to your hand or fingers.

Handling mobile phones near electronic medical equipment

The precautions detailed here conform to the guidelines drawn up by the Electromagnetic Compatibility Conference Japan, regarding the protection of electronic medical equipment from signals emitted by mobile phones.

Warning



Instruction

Observe the following in hospitals or other medical facilities.

- Do not take your FOMA terminal into operating rooms, ICUs (Intensive Care Units) or CCUs (Coronary Care Units).
- Turn off your FOMA terminal inside hospital wards.
- Turn off your FOMA terminal even when you are in an area outside hospital wards, such as a hospital lobby, since electronic medical equipment may be in use nearby.
- Where a medical facility has specific instructions prohibiting the carrying and use of mobile phones, observe those instructions strictly.
- If Auto power ON function is set to ON, disable this function before turning off your mobile phone.



Instruction

Turn off your FOMA terminal in crowded places such as rush-hour trains in case somebody nearby is using an implanted cardiac pacemaker or implanted cardioverter-defibrillator.

Electromagnetic signals may affect the operation of implanted cardiac pacemakers and implanted cardioverter-defibrillators.



Instruction

If you have an implanted cardiac pacemaker or an implanted cardioverter-defibrillator, always carry or use your FOMA terminal at least 22 cm away from your implant.

Electromagnetic signals may affect the operation of implanted cardiac pacemakers and implanted cardioverter-defibrillators.



Instruction

Patients receiving medical treatment away from a hospital or medical facility (e.g. home treatment) who are using electronic medical equipment other than implanted cardiac pacemakers or implanted cardioverter-defibrillators should consult the respective manufacturers for information regarding the effects of signals on the equipment.

Electromagnetic signals may affect the operation of electronic medical equipment.

Handling precautions

General notes

● Do not expose to water.

FOMA terminal, battery pack, adapters (chargers) and FOMA card are not waterproof. Do not use in humid or steamy areas such as bathrooms and avoid exposing to rain and other forms of moisture. If FOMA terminal is carried close to skin, perspiration may cause internal components to corrode and result in malfunction. Note that if problem is found to be due to moisture, handset and parts are not covered by warranty and in some cases may be irreparable. Even where repairs are possible, repair charges will be incurred since damage is not covered by warranty.

● Clean only with a soft and dry cloth (such as the type used for eyeglasses).

The surface of the handset's LCD has a special coating to improve the visibility of the color display. Forceful rubbing of LCD with a dry cloth may scratch LCD surface. Handle the handset carefully and clean using a soft and dry cloth (such as the type used for eyeglasses). Note also that LCD coating may peel off or stain if moisture or soiling is left on the surface for a long period. Never use chemicals such as alcohol, thinners, benzene or detergents, as these agents may erase the printing on the handset or cause discoloration.

- **Occasionally clean terminals with a dry cotton swab.**

Unclean terminals may result in poor connections and loss of power. Additionally, keep terminal clean with a dry cloth or cotton swab to prevent charge performance loss.

- **Do not place the handset near an air conditioning vent.**

Condensation formed due to rapid changes in temperature may cause internal corrosion and lead to malfunction.

- **Do not apply excessive force to the FOMA terminal and battery pack when using them.**

Carrying the handset in a tightly packed bag, or sitting on the handset in your pocket may cause a damage to display, other internal components or battery pack, or result in malfunction. Keeping an external connector device plugged into the external connector terminal (earphone/microphone terminal) may cause a damage to the connector or result in malfunction.

- **Read the manuals supplied with the FOMA terminal, adapters (chargers), and desktop holder carefully.**

- **Do not rub or scratch the display with metal, etc.**

May scratch the handset and cause malfunction or damage.

Notes about the FOMA terminal

- **Do not forcefully press a surface of the touch panel, or operate with a pointed object such as a fingernail, ballpoint pen, pin, etc.**
May damage the touch panel.
- **Avoid using the handset in extremely high or low temperatures.**
Use the FOMA terminal within the range of a temperature between 5°C and 35°C and a humidity between 45% and 85%.
- **Using the handset close to landline phones, TVs or radios may affect the operation of such equipment. Move as far away as possible from such items before use.**
- **Keep a separate memo and note information stored in the FOMA terminal.**
DOCOMO shall not be liable for any loss of content.
- **Do not drop or otherwise subject the FOMA terminal to severe impact.**
May cause a malfunction.
- **When connecting an external connector device to the external connector terminal (earphone/microphone terminal), do not put it in obliquely or do not pull it while it is plugged in.**
May damage the handset and cause malfunction.
- **Do not close the FOMA terminal on strap, etc.**
May damage the handset and cause malfunction.

- **FOMA terminal may become warm during using or charging but this is not a malfunction.**
- **Do not leave the camera in direct sunlight.**
May cause discoloration or burn-in.
- **Use the FOMA terminal with the external connector terminal cover on.**
Dust, water and others enter inside and cause a malfunction.
- **Do not use the FOMA terminal without the back cover.**
May detach the battery pack or cause malfunction or damage.
- **Do not paste a label or sticker on the back of the FOMA terminal display.**
The FOMA terminal is caught by the label or sticker when opened or closed, and it may cause malfunction or damage.
- **While using a microSD Card, do not remove the card or turn off the FOMA terminal.**
May cause data loss or malfunction.

Notes about battery pack

- **Battery pack is a consumable product.**
Though usage time varies with use, change battery if battery level is extremely low even after fully charged. Purchase a specified new battery pack.
- **Charge battery in areas where ambient temperature is between 5°C and 35°C.**
- **Always charge the battery before the first use or after not using battery for a long time.**

- The usage time for a battery depends on the usage and deterioration of battery pack.
- Depending on usage, the battery may swell as it approaches the end of its service life but this will not cause problems.
- **Do not store or leave the battery pack with no battery left.**
May lower the performance or shorten the life of the battery pack.
- **Note the followings when the battery pack is stored for a long term.**
 - The storage with the battery pack fully charged (immediately after charging is completed)
 - The storage with no battery level (cannot turn the FOMA terminal on)
May lower the performance or shorten the life of the battery pack. The second level of the battery pack icon is recommended as the battery level for long-term storage.

Notes about adapters (chargers)

- Charge battery in areas where ambient temperature is between 5°C and 35°C.
 - Do not charge battery pack in the following locations:
 - Areas with high humidity or dust, or in areas exposed to strong vibrations
 - Close to landline phones, TVs, radios, etc.
 - **Adapters (chargers) may become warm during charging but this is not a malfunction.**
- Do not use DC adapter to charge battery when the car engine is not running.
May cause car battery to run down.
 - When using an outlet with a feature to prevent the plug from being removed accidentally, follow instructions in the outlet user's guide.
 - Do not subject to strong force or impacts. Also, do not disfigure the charger terminals.
May cause a malfunction.
 - When putting back the stand of the desktop holder, do not catch a finger or the cord of the adapters (chargers).
May result in bodily injury or cause a malfunction.

Notes about FOMA card

- Do not apply unnecessary force when inserting/removing the FOMA card.
- FOMA card may become warm during using but this is not a malfunction.
- Customer is responsible for malfunctions arising from inserting FOMA card into a different IC card reader/writer.
- Always keep IC area clean.
- Clean only with a soft and dry cloth (such as the type used for eyeglasses).
- Keep a separate memo and note information stored in the FOMA card.
DOCOMO shall not be liable for any loss of content.

- To protect the environment, please take any unnecessary FOMA cards to your local docomo Shop or retailer.
- Avoid using in extremely high or low temperatures.
- Do not damage, touch haphazardly or short-circuit the IC.
May cause data loss or malfunction.
- Do not drop or otherwise subject the FOMA card to severe impact.
May cause a malfunction.
- Never bend or place heavy objects on the FOMA card.
May cause a malfunction.
- Do not insert the FOMA card to the FOMA terminal with a label or sticker attached on the card.
May cause a malfunction.

Notes on using Bluetooth function

- FOMA terminal supports the security function that merit may not be sufficient depending on the configuration. Take care of the security while making communication using Bluetooth function.
- Even if any leak of data or information occurs while making communication using Bluetooth function, DOCOMO shall not be liable for any loss of content.

Before Using the Handset

Component names and functions	24
Viewing display	28
Operations with touch panel	<Touch panel>33
Setting and selecting menu	36
Displaying Support Book	<Support Book>40
Using FOMA card	<FOMA card>40
Attaching/Removing battery pack	44
Charging	45
Checking battery level	<Battery level>49
Turning power ON/OFF	<Power ON/OFF>50
Changing screen display to English	<Select language>50
Making initial setting	<Initial setting>50
Setting date and time	<Date settings>51
Notifying the other party of your phone number	<Notify caller ID>52
Checking your own phone number	<Own number>52

Component names and functions

Before Using the Handset

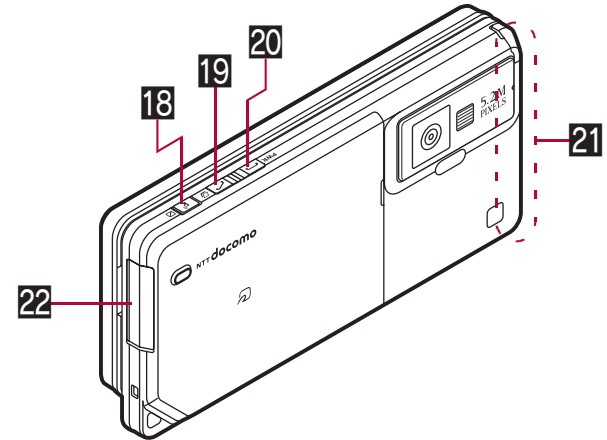
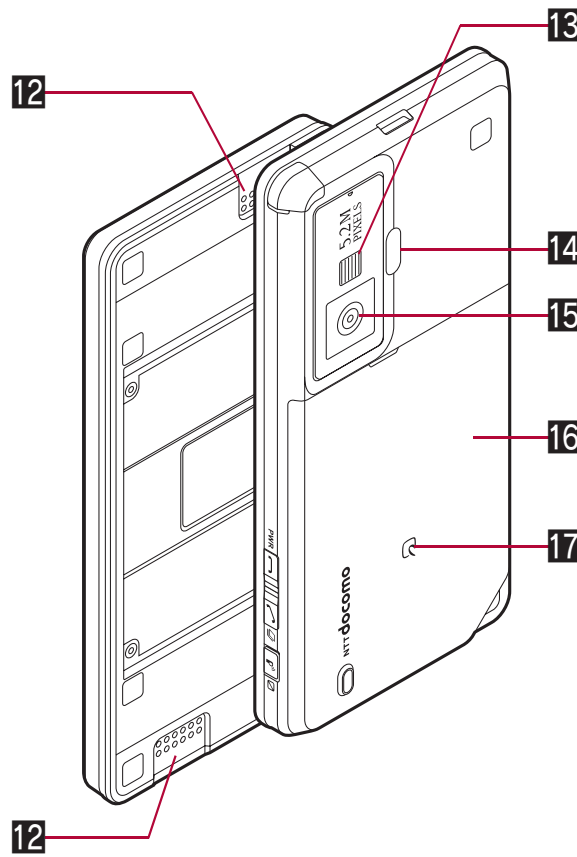
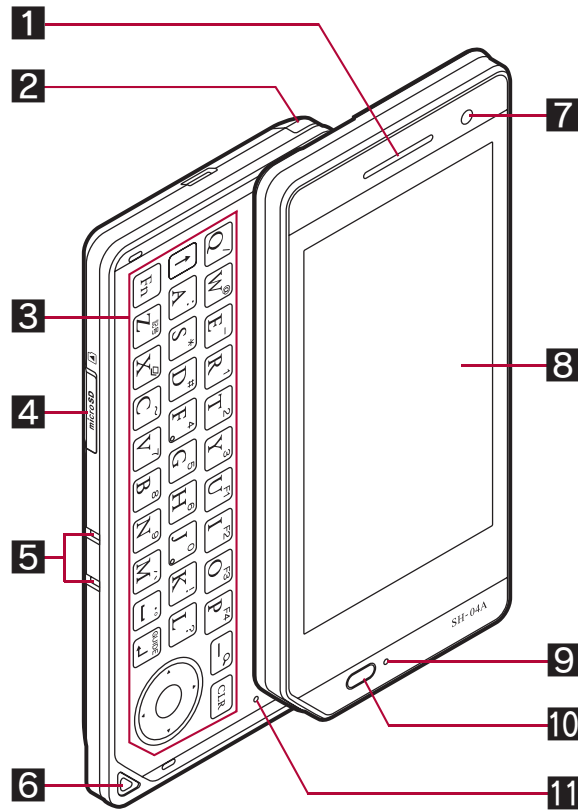

Using earphone
 Connect an earphone compatible with external connector terminal (sold separately). When using an earphone which does not support external connector terminal, connect with an earphone plug adapter for external connector terminal (sold separately).

Connection example for flat-plug earphone/microphone with switch (sold separately)

Connector
 Flat-plug earphone terminal
 Flat-plug connector of flat-plug earphone/microphone with switch (sold separately)

※ Key illustrations are examples and may look different from actual keys.

1 Earpiece

- Listen to the other party's voice.
- Listen to Record message/Voice memo.

2 1Seg antenna (📖 P. 227)

- Use to receive 1Seg.

3 Keybord (📖 P. 26, P. 404)**4 microSD Card slot (📖 P. 334)****5 Charger terminal (📖 P. 48)**

- Terminal for charging with the desktop holder.

6 Strap ring**7 Brightness sensor (📖 P. 103)**

- The sensor detects the light of the surrounding area and automatically adjusts the display brightness and turns on/off the keypad backlight.
- Do not cover the sensor area with your hand or a sticker. May interfere with the sensor.

8 Display (📖 P. 28)**9 Called/Charging LED**

- Flashes while receiving a call, etc. (📖 P. 107).
- Illuminates while charging (📖 P. 45).

10 Front clear key 

- Press to return to the previous screen.
- Use to delete text or phone numbers.
- Press to disable the lock of touch panel, side key and front clear key. Press for 1+ seconds to lock again (📖 P. 120).

11 Mouthpiece/Microphone

- Sends out your own voice.

12 Speakers

- Emits ring tones, music, etc.
- Emits the other party's voice during hands-free operation.

13 Picture light

- Illuminates while activating the camera (📖 P. 202).
- Illuminates/Flashes during shooting (📖 P. 207, P. 209).

14 Infrared port

- Use for the Ir communication (📖 P. 351).
- Use for the Ir remote control (📖 P. 356).

15 Camera

- Use to shoot still pictures or movies (📖 P. 202).
- Use to send a camera image shot during a Videophone call to the other party (📖 P. 54).

16 Back cover (📖 P. 44)

- A radio frequency-preventing sticker is attached on the back of the back cover. Do not peel off this sticker.

17  mark

- The iC card is included (The iC card cannot be removed). Use Osaifu-Keitai holding the  mark up to the scanning device (📖 P. 287).
- Use to send and receive data via the iC communication (📖 P. 356).

18 Shutter/PushTalk key  (P)

- Press to use the PushTalk phonebook (📖 P. 78).
- Press while using a camera to shoot (📖 P.000).
- Press for 1+ seconds to enable/disable the VeilView (📖 P. 110).

19 Start/Hands-free key 

- Press in the close position to display the Dial input screen (📖 P. 35).
- Press to make or receive a voice call.
- Press to use Hands-free (📖 P. 55, P. 76).
- Press for 1+ seconds in the close position to turn on/off the picture light.
- Press for 1+ seconds while using a function to use Multi Assistant (📖 P. 370).

20 Power/End key 

- Press for 2+ seconds to turn the power on/off (📖 P. 50).
- Use to end the function being used and return to stand-by display.

21 FOMA antenna

- An antenna is built in. To speak in better conditions, do not cover the antenna area by hand.

22 External connector terminal

- Integrated terminal used while charging, connecting the earphone, etc.
- Connect to an external device such as AC adapter/DC adapter, FOMA USB Cable with Charge Function 02 (sold separately) (📖 P. 47, P. 345).

Keyboard

- The following mainly explains operations in the stand-by display. For details on inputting text (P. 404)

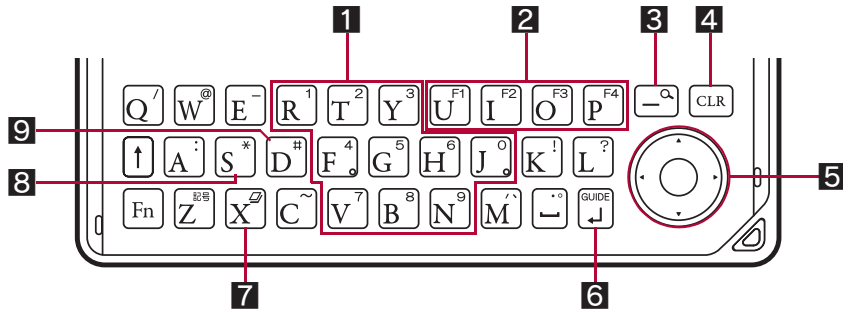

- Numeric key [1] to [N]**
 - Enter a phone number or number.
 - Press [R], [T], or [Y] for 1+ seconds to use assigned functions (P. 380).
 - Press [F] for 1+ seconds to check your present location (P. 296).
 - Press [G] for 1+ seconds to set font size collectively (P. 110).
 - Press [H] for 1+ seconds to turn on/off the Bluetooth power (P. 393).
 - Press [V] for 1+ seconds to record Voice memos or play Voice memos/Recorded messages (P. 70, P. 384).
 - Press [B] for 1+ seconds to start to use 2in1 or switch modes (P. 423, P. 424).
 - Press [N] for 1+ seconds to reset Kisekae Tool settings or Font style setting (P. 105, P. 109).
- Keys for operation guidance [U] to [P]**
 - Press to execute the functions of the operation guidance (P. 27).
- Quick search key [magnifying glass]**
 - Press to use Quick search (P. 381).
- Clear key [CLR]**
 - Press to display the i-Channel list (P. 182).
 - Press to return to the previous screen.
 - Use to delete texts and phone numbers.
 - Press with holding [Fn] to work in the same way as [1].

- Multi-guide key [circle with dot]**
 - Move the cursor to select an item and execute or set (P. 27).
 - Press to display Menu, Redial list screen, Received calls list screen, i-Widget screen and Shortcut menu.
 - Press for 1+ seconds to use Lock selection (P. 119).
 - Press for 1+ seconds to display the Sent messages history (P. 150).
 - Press for 1+ seconds to display the Received messages history (P. 150).
 - Press for 1+ seconds to adjust the earpiece volume (P. 96).
- Guidance key [down arrow]**
 - Press to display the operation guidance (P. 27).
- X/MULTI key [X]**
 - Press to use Multi Assistant (P.000).
- S/X key [S]**
 - Enter *.
 - Press for 1+ seconds in stand-by/while receiving a call to enable/disable the Public mode (Drive mode) (P. 67).
- D/# key [D]**
 - Enter #.
 - Press for 1+ seconds in stand-by/while receiving a call to enable/disable the Manner mode (P. 99).

Opening the FOMA terminal

To open the FOMA terminal, push its display side up as shown.

Close position

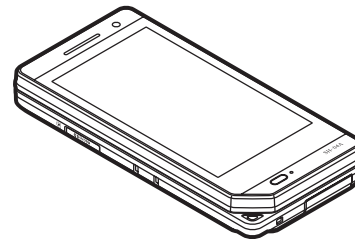

Open position



- When making a Videophone call in the open position, use the earphone/microphone (sold separately) or use hands-free.

■ Changing vertical/horizontal view

The display is automatically changed between the vertical view and the horizontal view just by tilting the FOMA terminal as shown. Use the FOMA terminal with closed and turned sideways or longways.

In the open position, the screen is displayed in the horizontal view regardless of direction of the FOMA terminal.

- The screen may not be changed depending on the function and screen in use.
- The vertical/horizontal view may not work properly immediately after the screen/power is turned on.

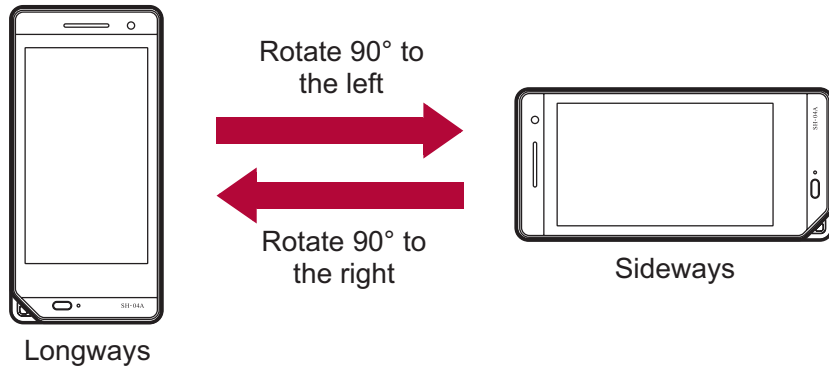

- The display may not be changed depending on the function.

■ Operation guidance

The operation guidance appears at the lower part of the display.

■ Close position

Directly touch the keys for operation guidance to select or execute the menus items in the guidance.



■ Open position

Press the keys allotted as follows to select or execute the menus items in the guidance.

- If the operation guidance is not displayed, press to display. Press again to hide.
- For inputting texts, press with holding (P.000).

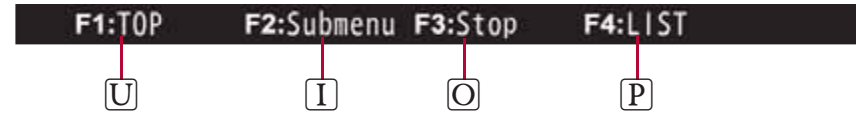

- The operation guidance for i-appli can also be operated by pressing its allotted keys to . Presence or absence of the operation guidance, or position for the guidance may differ depending on software.

■ Operation guidance menu

In the operation guidance, menus appear according to the used function and situation.

The following table describes examples of the main operation guidance menus that appear.

OK	Sets the selected item
Submenu	Displays the Submenu
Full	Displays selected images, etc. in full screen
Show all	Displays sorted files, etc. as a list
IrSS	Sends via Ir communication
Mail	Displays the compose message screen
Send	Sends a message
Cancel	Cancels the operation such as receiving a message
SelAll/ClrAll	Selects/Disables all selectable items (Up to 50 items can be selected/disabled depending on the function)
Page ▲/Page ▼	Scrolls the display by page
▶ page / ◀ page	Switches pages

Viewing display

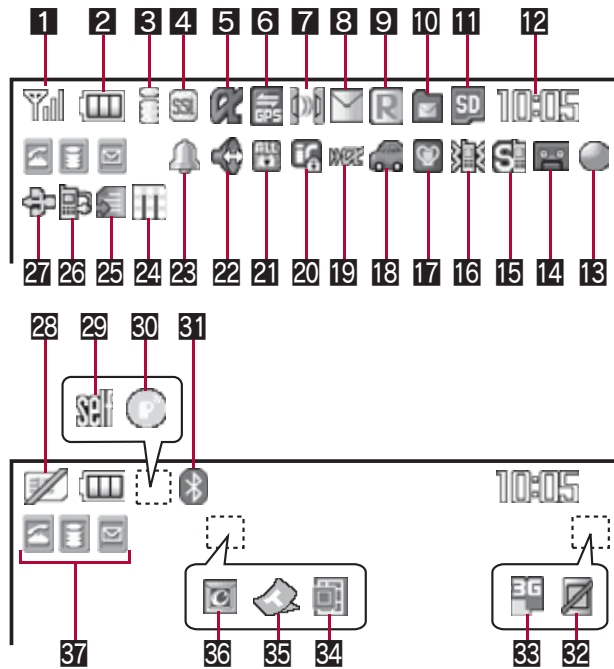

1 Signal status

	Indication of the signal strength
	Strong ← → Weak

- When appears, the handset is outside the service area or in a place with no signal. Signal icon can be changed (P. 106).

2 Battery level/Charging (P. 49)

	Battery level
	Charging

- Battery icon can be changed (P. 106).

3 i-mode/Full Browser (P. 164, P. 190)

	Indicates i-mode/Full Browser status
--	--------------------------------------

4 SSL (P. 166, P. 190)

	SSL compatible sites are viewed SSL compatible Internet web pages are viewed SSL/TLS pages are viewed
--	---

- When appears while Multi Assistant is used, function such as i-mode, Full Browser, i-αappli or Software update is being used with Multi Assistant.

5 i-αappli (P. 261)

	i-αappli is being activated i-αappli stand-by is being activated
	i-αappli stand-by is set*
	i-αappliDX is being activated i-αappliDX stand-by is being activated
	i-αappliDX stand-by is set*







* i-αappli is set as the stand-by display, but cannot be used.

- The i-αappli icons do not appear in the i-Widget screen.

6 GPS (P. 296, P. 304)

	Location request menu is set to [Loc. provision:ON]/ [Reject No. unset] Location request menu is set to [Permission sched.] and Location provision is permitted
	Location request menu is set to [Permission sched.] and Location provision is rejected
	GPS positioning

7 Ir communication/Bluetooth communication/External device

	Data is communicated with another device using the Ir communication function (P. 351) Data is sent using the Ir remote control (P. 356)
	Data is communicated with another device using the Bluetooth function (P. 395)
	Connected to commercially available Bluetooth compatible keyboard (P. 394)
 (green)	Connected to an external device and transmitting packets
 (red)	Connected to an external device and sending/receiving packet data
	Connected to an external device and transmitting 64K data

8 i-mode mail/SMS/Area Mail received (P. 138)

	Indicates the status of the i-mode mail/SMS/Area Mail reception Indicates the status of the memory to store received mail
---	--

9 Message R/F received (P. 155)



	Indicates the reception status of the Message R/F Indicates the status of the memory to store Message R/F
---	--

10 Storage status of i-mode center (P. 138, P. 155)

	Indicates the storage status of the mail and Message R/F
--	--

- The status may not always be indicated even if messages are held at the i-mode center.

11 microSD Card (P. 334)

 (gray)	microSD Card is inserted
 (pink)	microSD Card is being used

12 Clock display (P. 51)



- Small clock icon can be changed (P. 106).

13 1Seg being recorded (P. 235)

	1Seg is being recorded
---	------------------------

14 Record message (P. 69)

	Record message is set
---	-----------------------

- When there are messages,  to  appears, indicating the total number of both types of messages. When there are three Record messages (voice calls) and two Record messages (Videophone),  appears.

15 Silent (P. 95)

	The phone ring volume [Silent] is set
---	---------------------------------------

16 Vibrator (P. 97)

	Vibration mode is set
---	-----------------------

17 Manner mode (P. 99)

	Manner mode is set
---	--------------------

18 Public mode (Drive mode) (P. 67)

	Public mode (Drive mode) is set
---	---------------------------------







19 i-appli call (P. 276)



	New i-appli call
---	------------------

20 IC card lock (P. 288)





	IC card is locked
--	-------------------

21 Restriction indicator (P. 115, P. 121)

	Secret mode is set
	Secret data is being edited
	Keypad dial lock
	All lock is set
	Function lock is set
	Keypad dial lock and Function lock are set
 (red)	Secret mode, Function lock and Keypad dial lock are set

 (blue)	Touch panel/Side key lock, Secret mode, Function lock and Keypad dial lock are set
	Touch panel/Side key lock is set

22 Hands-free (☞ P. 55, P. 76, P. 393)

 (red)	Hands-free in progress
 (green)	USB hands-free in progress
	Mute in progress (only when in the open position)
	Bluetooth hands-free in progress

23 Alarm (☞ P. 236, P. 372, P. 377)



	Alarm is set Schedule alarm is set* Reception reserve alarm is set* Recording reserve alarm is set* Wakeup TV is set*
---	---

* Appears only when an Alarm is set for that day.

24 Music&Video Channel program reservation (☞ P. 245)

	Appears 12 hours before Music&Video Channel program distribution
---	--

25 i-mode mail send reservation (☞ P. 138)

	Mail with send reservation
	Mail failed to be automatically sent

26 Earphone/microphone connection (☞ P. 388)



	When voice/Videophone call in Auto answer setting is set to [ON] and while an earphone/microphone (sold separately) is connected When PushTalk in Auto answer setting is set to [ON]
---	---

- Appears when Auto answer for PushTalk is set even if an earphone/microphone is not connected.

27 USB mode (☞ P. 345)

	FOMA USB Cable with Charge Function 02 (sold separately) is connected in the Communication mode
---	---

28 FOMA card error

	Appears when FOMA card is malfunctioning or not inserted
	Appears when a card other than the FOMA card is inserted



29 Self mode (☞ P. 117)

	Self mode is set
---	------------------

30 PushTalk (☞ P. 76)

	During PushTalk transmission
---	------------------------------

31 Bluetooth (☞ P. 391)

 (blue)	Stand-by for Bluetooth registration Stand-by for Bluetooth connection Connected to Bluetooth
 (gray)	During power saver mode for Bluetooth (Appears when data is not transmitted from the FOMA terminal for a set length of time)





- The Bluetooth icon does not appear during SSL page display.

32 VeilView (☞ P. 110)



	VeilView is set
---	-----------------

- The VeilView icon does not appear during International roaming or while 1Seg is recorded.

33 3G/GSM

 (green)	3G network (Packet transmission is available)
 (red)	3G network (Packet transmission is not available)
	GSM/GPRS network (Packet transmission is available)
	GSM/GPRS network (Packet transmission is not available)

34 Status of Comics setting (P. 363)

	Frame display is set
	Page display is set

- Status of Comics setting icon does not appear during hands-free operation or receiving information display.

35 ToruCa (P. 290)

	Unread ToruCa
---	---------------

- The ToruCa icon does not appear during hands-free operation, receiving information display or e-comic display.





















36 Receiving information (P. 185)























	New information
---	-----------------

- Receiving information icon does not appear during hands-free operation.

37 Multitask (P. 370)

Indicates functions that are running.

	Four or more applications are running		Shoot still picture
			Shoot movie
	Videophone		Character reader (OCR)
	Voice call		Bar code reader
	Phonebook		Card reader
	PushTalk/ PushTalk phonebook		Information reader
			Shotdeco
	Modem transmission (appears during data transmission)		Voice recorder
			Schedule
	Software update		Text memo, Stand-by memo
	Map/GPS		Calculator
	Bluetooth function		Manga&BookReader

	Receive via Ir/iC/USB/ Bluetooth communication		Quick search
			ToruCa
	i-alpha		Alarm
	i-mode, i-Channel, WEB Mail		Timer
	Full Browser, Internet movie player		microSD
			General settings
	i-concier		Voice memo/Record message
	Receive information		
	Mail, SMS, Message R/F, Check new messages		Document Viewer
			1Seg
	Mail/Decome-Anime/SMS being composed		Reception reserve/ Recording reserve alarm sounds
	Received calls		Data Security Service
	Received messages		Data box
	Redial		MUSIC
	Sent messages		Own number

- microSD Card is referred to as [microSD] or [SD] on the FOMA terminal (P. 334).
- Some of the screen shots in this manual have been modified or abbreviated.
- The display for the FOMA terminal is manufactured using high-precision technology, but it may occasionally contain dots that fail to light or that remains permanently lit. This is not a malfunction.

Checking notices with stock icon

Display stock icons in stand-by when a call is missed or new mail is received. In stand-by, select stock icons to check notice details.

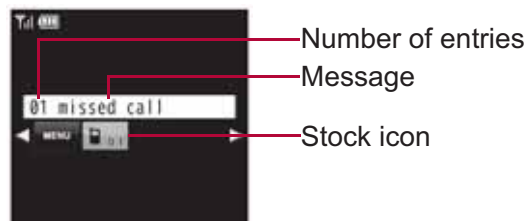

Stock icon type

Icon	Message	Page
	xx missed call*1	P. 68
	Recorded messages xx message/xx message	P. 70
	xx voice mail*1	P. 415
	xx mail message	P. 139, P. 160
	xx New Message R	P. 156
	xx New Message F	P. 156
	xx new ToruCa	P. 290
	New auto send result	P. 138
	Update complete	P. 497
	Check update	P. 497
	Update required	P. 495
	Check for update	P. 495
	USB mode setting	P. 345
	Download successful (Music&Video Channel)	P. 245
	Download failed (Music&Video Channel)	P. 245
	Charge limit exceeded	P. 385

Icon	Message	Page
	Send loc - No resp	P. 306
	Send loc - Resp	P. 306
	Send loc - Failed	P. 306
	New i-appli call	P. 276
MENU	Custom menu/Basic menu/Menu*2	P. 38

*1 When the 2in1 mode is set to [Dual mode], the number of [A mode] and [B mode] appears each.

*2 The message that appears differs depending on the menu screen or position of the FOMA terminal.

1 In stand-by, a stock icon appears.

2 Select the stock icon.

- Touch the stock icon to point the cursor and touch again.
- After the details are checked, the stock icon and message disappear.

- Stock icons do not appear while the i-motion set as stand-by is played or the i-appli stand-by is being activated.

Displaying and operating i-Widget

In the i-Widget screen, multiple i-Widget can be activated simultaneously and viewed as a list.

- For details on operation of i-Widget P. 282



i-Widget screen

- 1** Area where Widget appli is pasted
- 2** Setting status icons for Widget appli
 - For details on the setting status icons
☞ P. 261
- 3** Operation guidance
 - Available menus appear.

Activating i-concier with popup message

Display popup messages in the stand-by display when information is received. Activate i-concier with the popup messages to check information details.



- 1** In stand-by, a popup message appears.
- 2** Select the popup message.
 - Touch the popup message to point the cursor and touch again.
 - The popup message disappears after activating i-concier.

- Calendar or Stand-by memo does not appear while a popup message appears.

Touch panel

Operations with touch panel

- Operate by putting the finger on the touch panel (screen).
- In this manual, operations with touch panel are mainly explained.

Touch panel

- The operations differ depending on the function and screen in use. The message stating that the operation is not available appears when the touch panel cannot be used.
- Operate the touch panel inside the operating range of touch panel in the figure. However, the area where the operation guidance appears cannot be touched in the open position.
- The notation of operation described in this manual and its meaning are shown as follows.

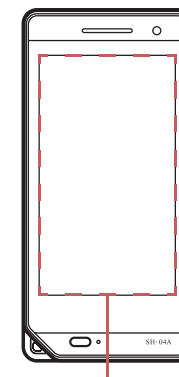

Operating range of touch panel

Touch

Put the finger on the touch panel and put it off.

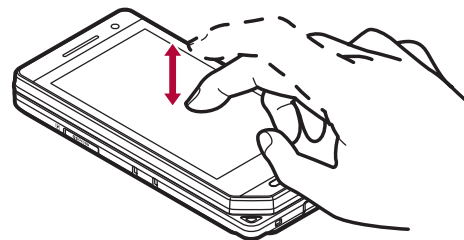

Slide

Keep the finger on the touch panel and slide it.

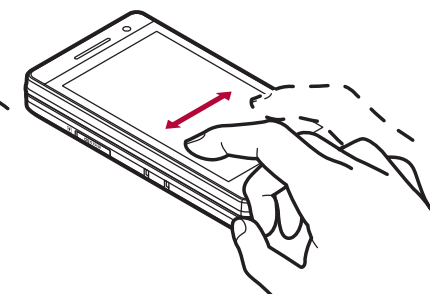

Quick slide

Quickly slide the finger and put it off.

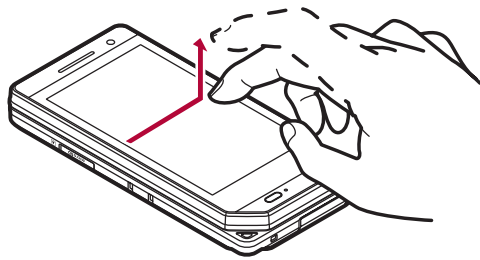
**Putting the distance between two fingers apart/closer**

Put two fingers on the touch panel and slide them with putting the distance between two fingers apart/closer.

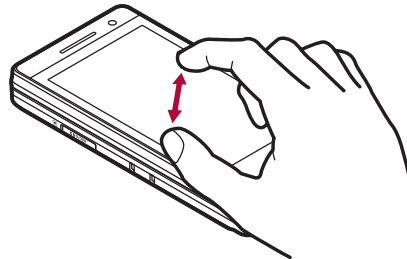

- When putting the finger on the touch panel, the tone sounds and the vibrator is activated. However, they may not be activated in some cases, such as activating a camera, playing music, etc.
 - The volume can be changed (🔊 P. 96). The tone cannot be changed.
 - The vibrator can be set to ON/OFF (🔊 P. 97).

When using the touch panel

- The touch panel does not work when operated with a gloved finger or with foreign objects placed on the operation pad.
- Note that operating with a wet finger or putting a sticker to the touch panel (display) may cause a malfunction.

Using menus or functions

Select each menu or keys by touching.

Operations in stand-by

Activate various functions such as activating the Stand-by Display Touch Launcher, moving the position of clock, changing the stand-by display, etc. by the touch operation in the stand-by display.

Selecting menu or item

Select a menu such as the Custom menu or a menu in the Stand-by Display Touch Launcher, etc. by touching the menu icon.

For a menu in list format, touch the object to point the cursor and touch again to select.

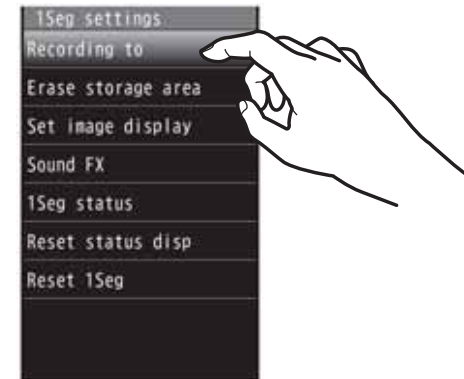
Example: 1Seg setting menu

■ Switching pages

When a menu contains multiple pages, quickly slide to the left/right to switch pages.

Example: Mail setting

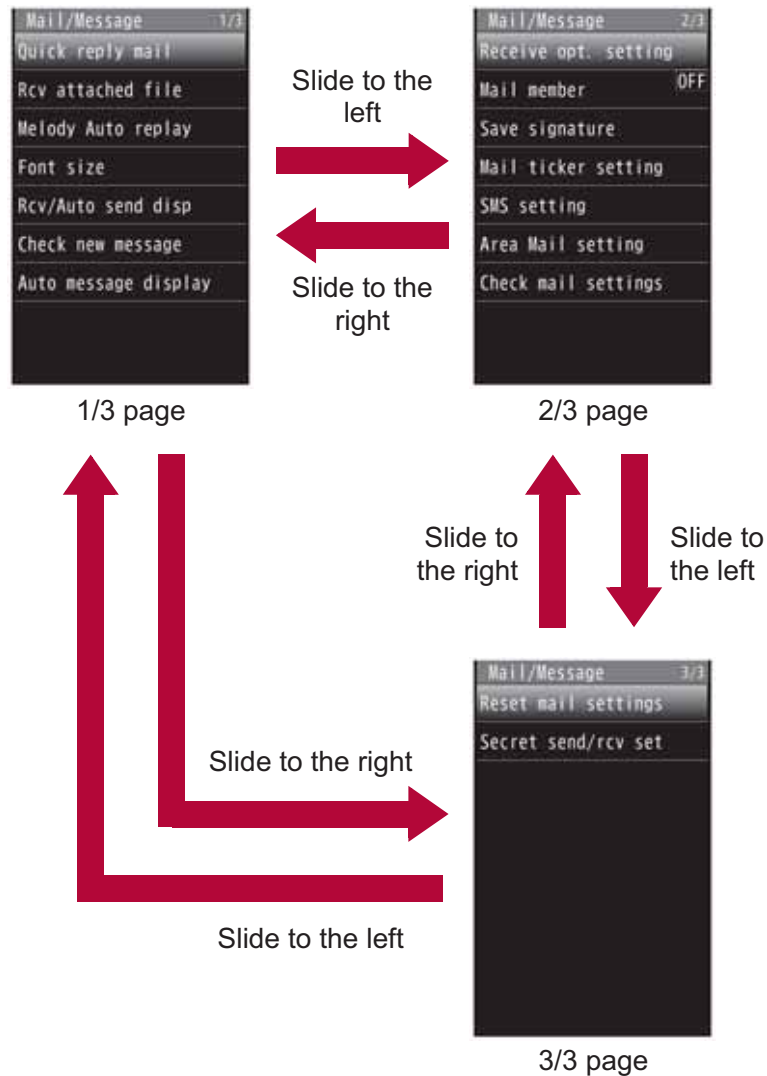

■ Submenu (☞ P. 40)

■ Control key

- While using the function, touch the screen to display control keys.

Example: MUSIC Player



- Touch the area other than the control keys to hide the control keys (excluding 1Seg).
- Touch [Next] to display next keys.

● The control keys always appear while camera is activated or music data is played (excluding while displaying images/lyrics).

■ Slide operation

- The slide operation is available for adjusting the volume or scrolling the screen.
- Be careful not to touch a key displayed on the screen.

■ Number entry

When numbers such as the phone number, terminal security code, or Pin code are required to be entered, the numeric panel appears in the close position. Touch the numeric part.



If an input field appears for time setting, etc., touch the field to move the cursor there and enter numbers in the position.



■ Character entry (☞ P.000)

Locking touch panel

The touch panel is automatically locked while making a voice/Videophone/ PushTalk call, receiving a call, or calling (including while playing a reply message, recording sounds, and recording Voice memo (during call)) to prevent from errors.

- To temporarily disable the lock: Press .
 - Press  for 1+ seconds to lock again.
- Touch panel lock is temporarily disabled when the FOMA terminal is opened. It is locked again when the FOMA terminal is closed.
- This function is not linked with Touch panel/Side key lock (P. 120).

e.g.) During a call



Locking screen

Setting and selecting menu

Set, change or save functions from the menu screens.

The explanations in this manual are based on how to retrieve a function from the Custom menu. As for functions retrieved from the Stand-by Display Touch Launcher and the Quick Settings, how to retrieve from those menus is individually explained.

Setting start menu <Menu priority>

Set the start menu that displayed when  is selected in the Stand-by Display Touch Launcher.

- When Stand-by touch launcher display is set to [OFF], touch the wall paper on the stand-by display (excluding an area where the clock or i-Channel ticker is displayed, and the Pict area) to display the start menu.

Start menu	Characteristics
Custom menu	<p>The preset Kisekae Tool (P. 104) can be selected and set. Each Kisekae Tool consists of different functions and designs. Kisekae Tools can be downloaded from sites and used.</p> <p>Preset Kisekae Tools</p> <ul style="list-style-type: none"> ■ Black ■ シンプル(Simple) ■ 拡大メニュー(Large) ■ ダイレクトメニュー
Basic menu	Select the icon displayed on the menu to retrieve the function.

- 1 In the Stand-by Display Touch Launcher, select  ▶ [Settings] ▶ [Disp/LED/Power saver] ▶ [Menu priority].**
 - In the Custom menu/Basic menu: Select [Submenu] ▶ [Menu priority].
- 2 Select the start menu ▶ [Yes].**

■ Switching set start menu temporarily

Switch the start menu temporarily. When the stand-by display reappears, the start menu returns to the one set in Menu priority. Use the Horizontal display menu.

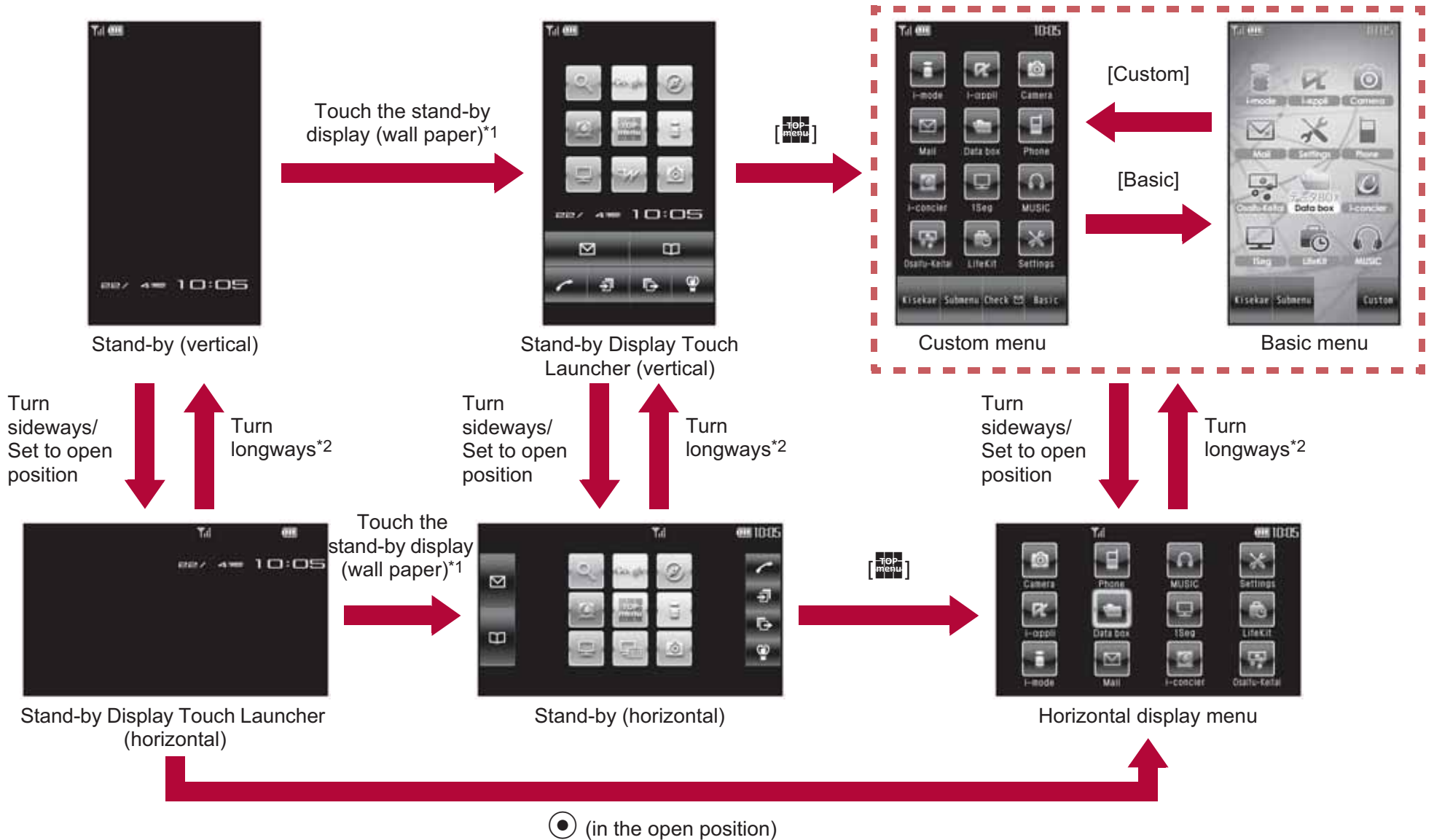

*1 When Stdbych Inhdsp is set to [OFF], the Start menu/Horizontal display menu appears.

*2 Turning is not available in the open position.

Retrieving a function from each menu

- For details on operating shortcut menu P. 380
- For details on the available functions P. 446
- All menus can be operated by the touch operation, or with .
- Touch a menu item to select from the Custom menu or Basic menu. For menus in list format, such as 1Seg setting, touch a menu item to point the cursor and touch again. When a menu contains multiple pages, quickly slide to the left/right to change pages. Alternatively, scroll or change pages with .
- The method for selecting functions may differ depending on the Kisekae Tool set for the Custom menu.
- Press or to re-select a function, and the previous screen reappears. Press to return to stand-by.

When a stock icon (P. 32) appears in stand-by, select **MENU** to show the each menu.

Touch operation or the way of activating 1Seg with the Multi-guide key is explained as an example below.

Retrieving from the Custom menu

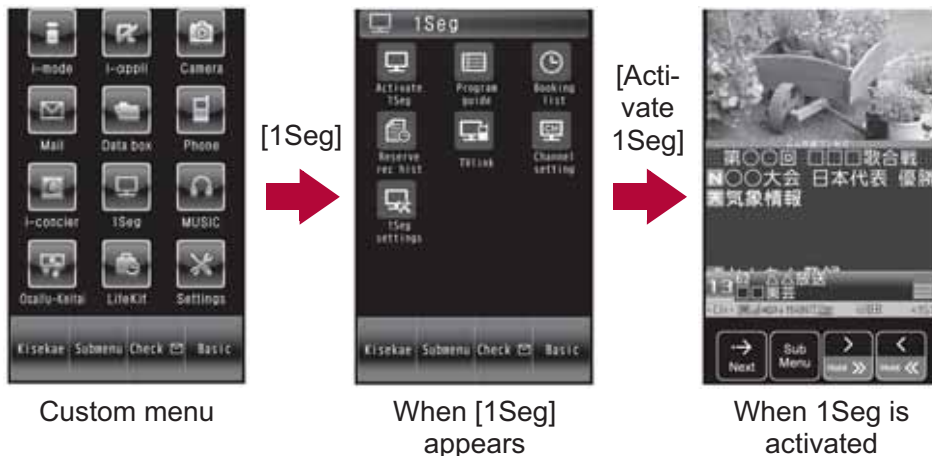

Retrieving from the Basic menu

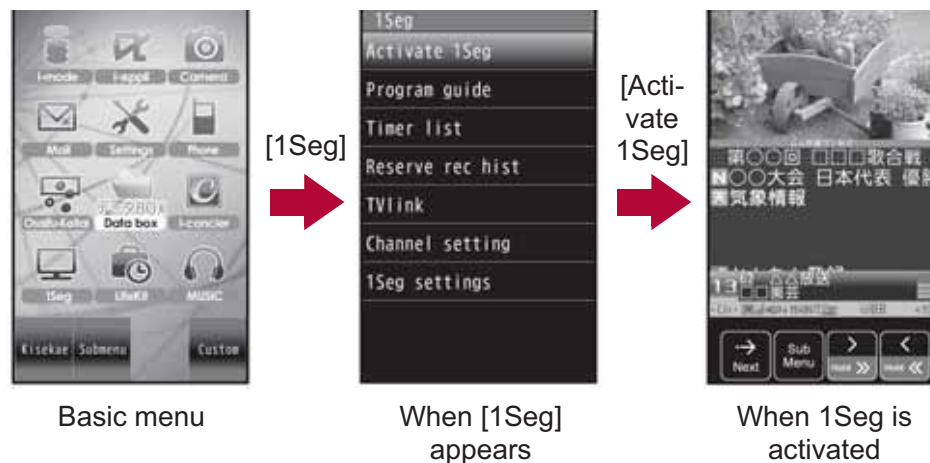

Retrieving from the Horizontal display menu

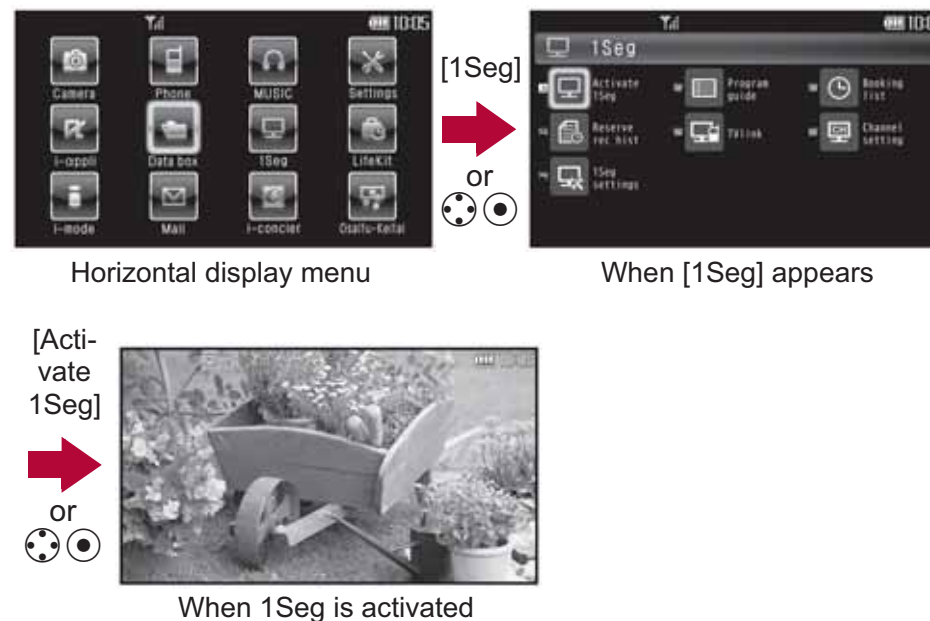



- When the Custom menu image is changed by Kisekae Tool, the operation may differ from the description in this manual. In this case, switch the menu screen to the Basic menu (P. 36) or perform the Reset menu screen (P. 105).

- Press the key corresponding to the menu item number when connecting the Bluetooth compatible keyboard to select a function. However, in the Custom menu/Horizontal display menu, a function may not be selected by using the menu item numbers.

Retrieving a function from Quick Settings

Touch the Pict area in the stand-by display to display the Quick Settings. Touch each key to point the cursor and touch again to activate related setting menus.

- Press  or touch the area other than the Quick Settings to return to the stand-by display.
- For details on the available functions  P.000

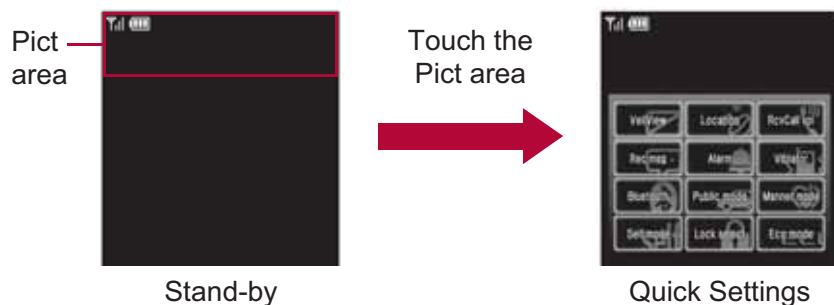



Retrieving a function from Stand-by Display Touch Launcher

Touch the wall paper on the stand-by display (excluding an area where the clock or i-Channel ticker is displayed, and the Pict area) to display the Stand-by Display Touch Launcher. Touch each key in the Stand-by Display Touch Launcher to activate the corresponding function.

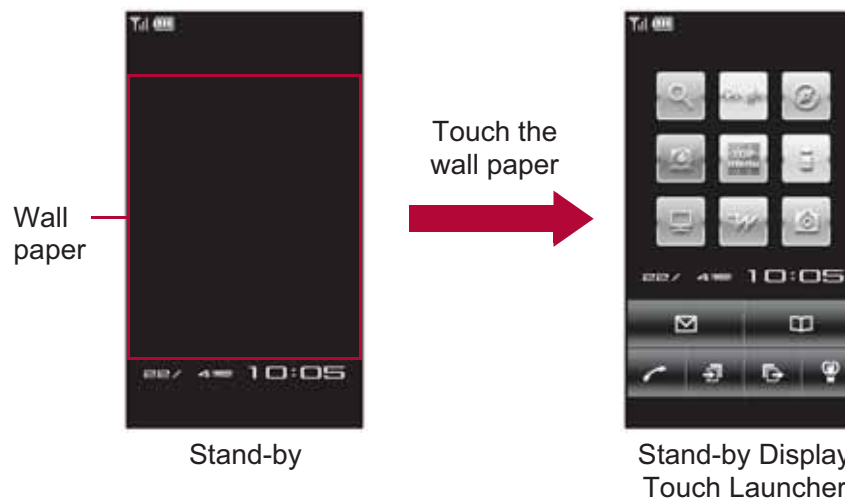
- For details on the available functions  P.000



- If no operations are performed for approximately 5 seconds, , , or  is pressed, or the area other than the Stand-by Display Touch Launcher is touched, the stand-by display reappears.

Setting whether to display Stand-by Display Touch Launcher <Stdbych to ch disp>



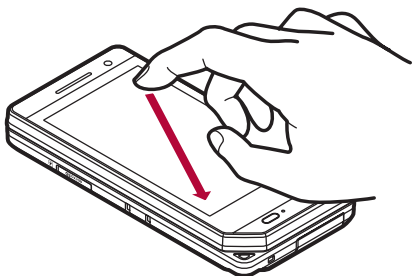

- 1 In the Custom menu, select [Settings] ▶ [Disp/LED/Power saver] ▶ [Set screen] ▶ [Stdbych to ch disp].
- 2 Select the setting.

Selecting a function from Submenu

While using the function, slide from the upper right to the lower left (or from the upper left to the lower right) to display the Submenu.



Submenu screen

- To display the Submenu, touch [] of the control key, [Submenu] in the operation guidance or [] on the upper part of the screen, or press .
- When the Submenu contains multiple pages, slide up/down to scroll the screen and display items.
- To hide the Submenu, touch the area other than the Submenu. Press  or  to return to the previous screen (menu).

● Submenu may not appear depending on the function.

Support Book

Displaying Support Book

Use this function for unsure operations. After the Support Book appears, check the explanation and operation procedures of each function. In addition, directly start functions that were looked up in the Support Book.

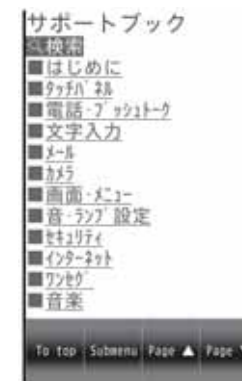

- 1 In the Stand-by Display Touch Launcher, select [] ▶ [Support Book].
- 2 Select a menu or item.
 - To start functions directly: Select the function to start ▶ [Yes].

FOMA card

Using FOMA card

A FOMA card is an IC card that records personal information, such as phone numbers. A FOMA card can store phonebook data and SMS. By switching FOMA cards, multiple FOMA terminals can be used for different purposes as needed.

- If a FOMA card is not inserted, transmission functions such as voice/Videophone/PushTalk calls, i-mode, mail transmission and packet transmission are not available on the FOMA terminal.

Inserting/Removing FOMA card

- Before inserting or removing the FOMA card, turn off the power, position the back facing upwards and remove the battery pack. Close and hold the FOMA terminal firmly with your both hands.

Inserting FOMA card

1 Hook a finger on the tab and pull the tray out (1).

- Pull out the tray straight until it stops.

2 Hold the FOMA card with the IC facing down and set on the tray (2).

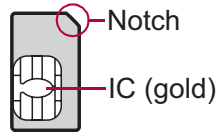

3 Push the tray all the way in (3).

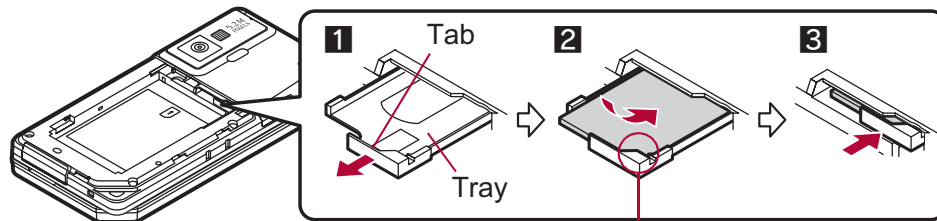

Fit the notch of the FOMA card to that of the tray.

Removing FOMA card

1 Hook a finger on the tab, pull the tray out (1) and remove the FOMA card (2).

- Do not allow the FOMA card to fall when removing it.

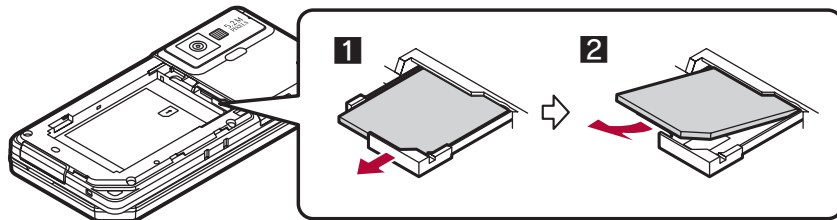

- Inserting or removing the FOMA card forcibly may damage the card or deform the tray. Use caution.
- Refer to the FOMA card user's guide for more information on the FOMA card.
- Do not misplace the FOMA card once it is taken out.
- When the tray falls off, slide the tray in straight along the guide rail.

Security codes

The FOMA card has a "PIN1 code" and a "PIN2 code".

Both are set to [0000] by default but can be changed to a four- to eight-digit number by the user (P. 114).

FOMA card security functions

<FOMA card security functions>

The FOMA terminal has built-in FOMA card security functions (FOMA card restriction functions) as functions for protecting personal data and files.

- When data or files are retrieved using any of the following methods or i-appli is running with the FOMA card inserted into the FOMA terminal, FOMA card security functions are automatically set in the retrieved data or files.
 - When a file such as an image, melody or PDF is downloaded from a site or Internet web page
 - When a site or Internet web page is saved as a screen memo
 - When i-mode mail with a file attached is received
 - When i-appli is running
- Data, files or software with FOMA card security functions run only when in use with the FOMA card inserted at time of acquisition. Display, play, attach to i-mode mail, run software, send data using Ir communication function and iC communication function, and copy to microSD Card can be executed. These operations cannot be performed if a different FOMA card is inserted.
- The following indicates the data for which FOMA card security is set.

■ Melody	■ Image (including animation and Flash movie)
■ Screen memo	■ Chaku-uta®/Chaku-uta full®
■ Chara-den	■ File attached to Message R/F

Continued on next page ▶▶

- i-motion
- PDF data
- Kisekae Tool
- Machi-chara
- Download dictionary
- Download font
- Contents transfer compatible data
- Image in Message R/F
- Music&Video Channel program
- Deco-mail template with data which FOMA card security functions are set
- Decome-Anime Template
- e-book/e-dictionary/e-comic saved in the [Comic] folder
- File attached to i-mode mail other than the following
 - ToruCa
 - Phonebook
 - Schedule
 - Bookmark
 - Documents
- ※ “Chaku-uta” is a registered trademark of the Sony Music Entertainment (Japan) Inc.
- The following indicates the settings saved in the FOMA card.
 - Own number
 - Select language
 - SMS center
 - SMS input character
 - PIN setting
 - SSL certificates
 - SMS expiry
- The following explanation refers to the FOMA card inserted at time of data/files retrieval as “one’s own FOMA card” and other FOMA cards as “another’s FOMA card”.

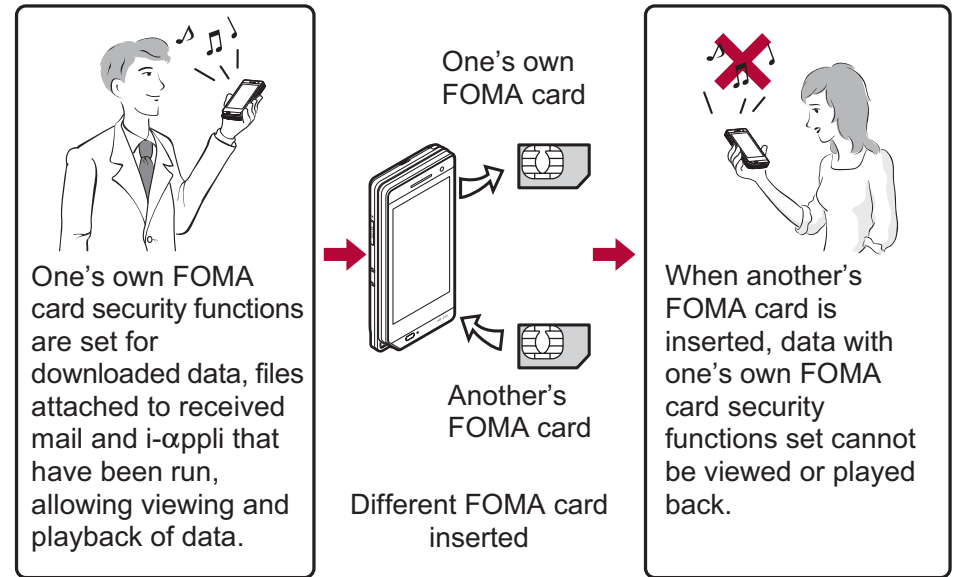

- When one’s own FOMA card is replaced with another’s FOMA card, the data or files for which FOMA card security functions are set cannot be set as stand-by displays or ring tones.
 - When a FOMA card is replaced with another’s FOMA card, FOMA card security functions are activated and if data or file retrieved from a site is set as the stand-by display or ring tone, the setting is reset to the default. When one’s own FOMA card is re-inserted, the setting returns.
- Example: When setting [Melody A], for which FOMA card security functions are set, as a ring tone**
- When one’s own FOMA card is taken out or is replaced with another’s FOMA card, ring tone returns to default setting. When one’s own FOMA card is put back, the ring tone returns to [Melody A].
- FOMA card security functions cannot be set for data received using Ir communication or data transmission functions, and still pictures/movies, etc. shot with the FOMA terminal.
 - It is possible to move or delete data or files for which FOMA card security functions are set even when another’s FOMA card is inserted.
 - Running i-appli by selecting highlighted text in i-mode mail details screen cannot be performed or retrieved when FOMA card security functions are set.

- If the FOMA card is replaced with another's FOMA card after i-αpli stand-by is set, the set i-αpli cannot be activated in stand-by, and the image set in Stand-by display appears.

FOMA card type

Note the following differences between “FOMA card (blue)” and “FOMA card (green/white)” used on the FOMA terminal.

Function	FOMA card (blue)	FOMA card (green/white)	Page
Number of phone number digits available in the FOMA card phonebook	Up to 20 digits	Up to 26 digits	P. 86
Client certificate operations for FirstPass	Not available	Available	P. 179
Use of WORLD WING	Not available	Available	P. 430
Service Numbers	Not available	Available	P. 421

About WORLD WING

WORLD WING is a DOCOMO's FOMA international roaming service that makes it possible to use the mobile phone number registered in Japan to make and receive calls even overseas by the FOMA card (green/white) and supported FOMA terminal.

- If subscribed to the FOMA service after September 1, 2005, subscription for “WORLD WING” is not required. However, if subscription for “WORLD WING” is canceled at or after subscription for the FOMA service, subscription for “WORLD WING” is required again.
- If subscribed to the FOMA service before August 31, 2005 but not subscribed to “WORLD WING”, subscription for “WORLD WING” is required.
- Some payment plans are not available.
- When the FOMA card (green/white) is lost or stolen overseas, promptly contact DOCOMO and conduct a procedure for canceling the use of service. Refer to General Inquiries on the back of this manual for inquiries. Note that transmission/calling charges after the FOMA card is lost or stolen are incurred to the subscriber.

Attaching/Removing battery pack

Use the Battery Pack SH18 exclusive to the FOMA terminal.

- Turn off the power, close the FOMA terminal, and hold it in your both hands before attaching or removing the battery pack.

■ Attaching battery pack

- 1 Push the catch on the back cover in the direction of the arrow (1), slide approximately 2 mm (2) and remove the back cover (3).

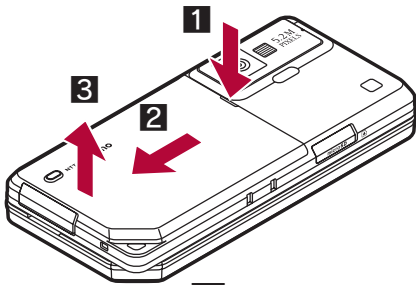

- 2 Attach the battery pack (4).

- The FOMA terminal has tabs that make it easy to attach. Attach the battery pack with a recycle mark side faced up.

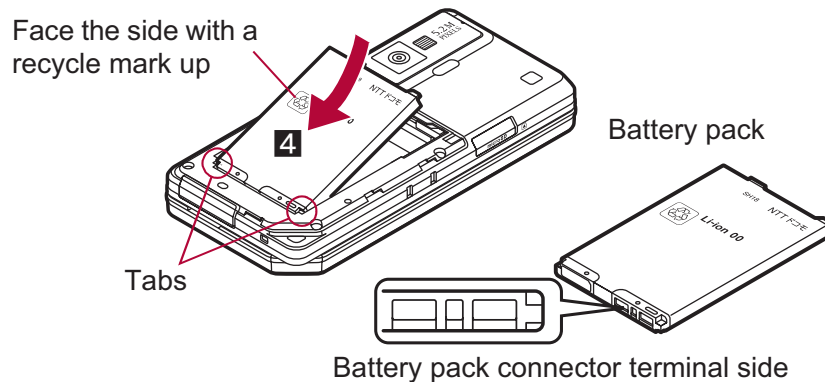

- 3 Attach the back cover (5).

- Attach the back cover as shown in the illustration and then push the back cover and slide into place.

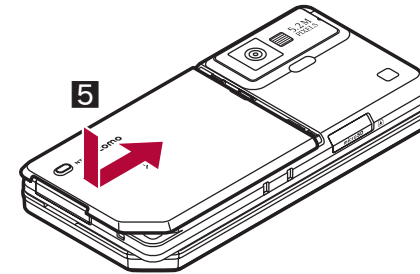

■ Removing battery pack

- 1 Follow step 1 of “Attaching battery pack” to remove the back cover.

- 2 Remove the battery pack.

- The battery pack has a tab that makes it easy to remove. Hook a finger on the tab to prevent excessive force on it and remove the battery pack upward.

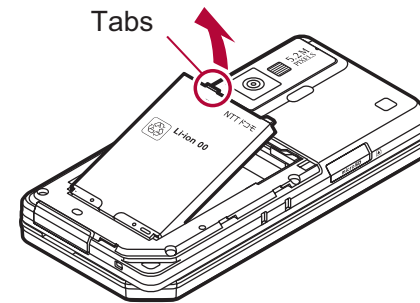

- Using unnecessary force when attaching or removing the battery pack may damage the connector terminal for the battery pack (charger terminal) on the FOMA terminal.
- Firmly close the back cover. If not closed firmly, the back cover may come off and the battery pack may fall out due to vibration.

Charging

The battery pack is not fully charged at the time of purchase. Be sure to charge the battery using the exclusive AC or DC adapter (sold separately) before use.

■ Cautions while charging

- Do not charge for long periods of time with the power left on. If the FOMA terminal is left on after charging is complete, the battery pack charge decreases.

In such cases, the AC or DC adapter charges the battery again.

However, depending on when the FOMA terminal is disconnected from the AC or DC adapter, the battery charge level may be low, the battery alert tone may sound, or the battery may only be usable for a short time.

- When the battery is empty and terminal is recharging, charging LED may not illuminate immediately.
- If the battery empty alert is displayed, the alert tone sounds and the power cannot be turned on, charge the battery for a while.
- If the battery empty alert is displayed and charging begins within 60 seconds of the alert tone, the status returns to normal.
- While charging, terminal may not turn on even when charging LED is illuminated in red. Charge longer and try turning power on again.
- Frequently recharging the battery when its power is still remaining enough may shorten the life of the battery pack. It is recommended to use the battery to a certain level before recharging.
- The battery pack cannot be charged by itself.

■ Estimated charge times and LED display

The following figures are estimated times for charging an empty battery pack with the FOMA terminal turned off.

FOMA AC Adapter 01/02	Approx. \$\$ min
FOMA DC Adapter 01/02	Approx. \$\$ min

- Charging LED illuminates in red while charging, and it turns off when charging is completed.

- Check that the battery pack has been properly attached when charging LED flashes red. The LED also flashes red when the battery pack has reached the end of its service life.
- The battery pack can also be charged with the FOMA terminal turned on (▶□ on the display flashes during charging). When charging is completed, charging LED turns off, and ▶□ on the display changes to □□□.
- When the battery becomes warm, charging may automatically stop even if the battery has not been fully charged. Charging resumes after the temperature lowers to an appropriate temperature. While charging is stopped, charging LED turns off (▶□ on the display flashes while stopped).

■ Estimated times of use when fully charged

Continuous talk time	FOMA/3G		Voice call: Approx. \$\$ min
			Videophone call: Approx. \$\$ min
	GSM		Voice call: Approx. \$\$ min
Continuous stand-by time	FOMA/3G	3G/GSM setting: 3G	When mobile: Approx. \$\$ hr
		3G/GSM setting: AUTO	When mobile: Approx. \$\$ hr
	GSM	3G/GSM setting: AUTO	At rest: Approx. \$\$ hr
1Seg watching time			Approx. \$\$ min

- Continuous talk time is estimated as the usage time at normal transmission signal strength, and continuous stand-by time is estimated as the usage time while moving with the FOMA terminal closed at normal signal strength. Using i-mode reduces talk (transmission)/stand-by time. When i-Channel is subscribed, information is automatically received and updated, so talk (transmission)/stand-by time will be reduced. In addition, when shooting or editing an image, watching 1Seg, composing i-mode mail, activating the downloaded i-αppli or the i-αppli stand-by, or using MUSIC Player, i-motion player, Bluetooth function or data communication, the talk (transmission)/stand-by time will be reduced even if calls or i-mode transmission are not made. Some i-αppli software may continue transmission even after downloading. To avoid this, set not to connect in advance.
- The actual usage time is a combination of stand-by time and talk time, and the longer the talk time, the shorter the stand-by time becomes.
- 1Seg watching time is estimated as the watching time at normal transmission signal strength with the Flat-plug Stereo Earphone set P01 (sold separately) used.
- Talk (transmission)/stand-by time may be reduced by about half or 1Seg watching time may be shortened depending on battery pack status, function used, temperature and other environmental conditions, or signal strength (no signal or weak signal).

■ Battery pack service life

- Battery pack is a consumable product. Service time per charge is gradually reduced every time the battery is charged.
- When service time per charge is reduced to about half of the default time, this means that the battery pack is approaching the end of its service life. In such a case, it is recommended to replace the battery pack as soon as possible. Depending on usage, the battery pack may swell as it approaches the end of its service life but this will not cause problems.
- If i-αppli, Videophone, or 1Seg is used while charging for a long time, the service life of the battery pack may become shorter than estimated.
- To protect the environment, return used batteries to NTT DOCOMO, any DOCOMO retailer, or a recycling agency.



Li-ion 00

■ About charging batteries

- Refer to user's guide of FOMA AC Adapter 01/02 (sold separately), FOMA AC Adapter 01 for Global use (sold separately), or FOMA DC Adapter 01/02 (sold separately).
- FOMA AC Adapter 01 covers only 100V AC. FOMA AC Adapter 02/ FOMA AC Adapter 01 for Global use covers from 100 to 240V AC.
- The shape of the plug for the AC adapter is for 100V AC (for domestic use). To use the AC adapter of 100 to 240V AC overseas, a conversion plug adapter that is compatible with the voltage of your country of stay is required. Do not use a transformer for use overseas to charge the battery.

Charging by using AC adapter/DC adapter

[Read “FOMA AC Adapter 01/02 (sold separately) and FOMA DC Adapter 01/02 (sold separately) user’s guide” carefully.]

- Battery pack can be charged even in the open position.

1 Open the external connector terminal cover (1) and insert the AC or DC adapter connector horizontally into the external connector terminal (2).

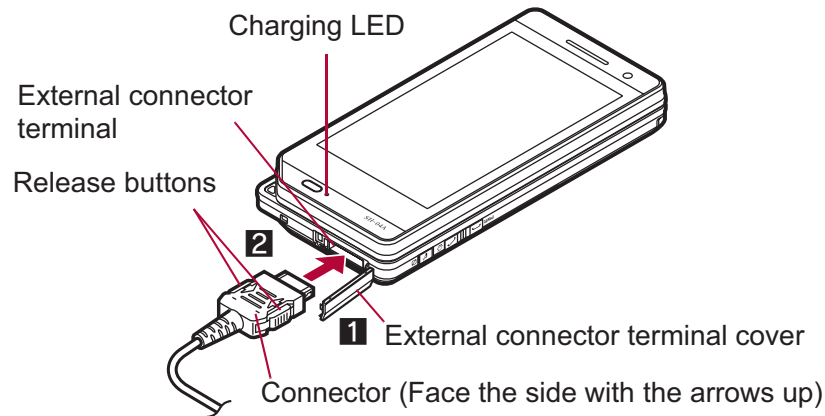

- Check the direction (See diagram) of the connector, keep it parallel with the FOMA terminal and firmly push all the way in until it clicks.

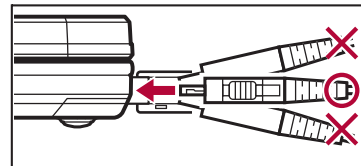

2 When inserting the AC adapter power plug into an outlet or inserting the DC adapter power plug into a car cigarette lighter socket, Charge start sound is heard, charging LED illuminates, and charging starts.

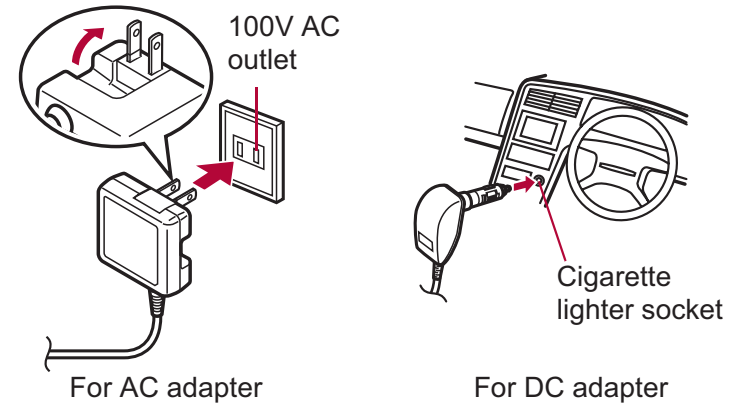

3 When Charge end sound is heard and charging LED turns off, charging is complete.

- When removing the connector, always hold the release buttons on both sides (1) and unplug it by pulling out horizontally (2).

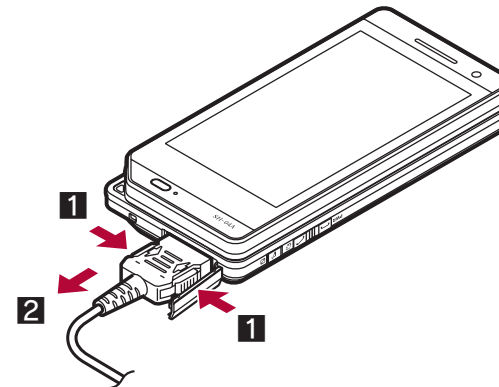

- Do not forcibly insert or remove. May cause damage to the external connector terminal and the connector.
- Pull the adapter out of the outlet or cigarette lighter socket if it will not be used for a long time.
- Do not forcefully pull the external connector terminal cover. May damage the cover.
- Do not place objects near the FOMA terminal when charging. May damage the FOMA terminal.

When using a DC adapter

- The DC adapter should only be used in negative grounded vehicles (12 and 24V DC).
- Do not use with the car engine shut off. May drain the car battery.
- The DC adapter fuse (2A) is a consumable. For replacement, purchase a new fuse at a local automobile supply shop.
- Refer to the FOMA DC Adapter 01/02 user's guide for details.

Charging by using desktop holder

[Read "Desktop Holder SH24 (sold separately) user's guide" carefully.]

- 1 Face the side with the arrows of the AC adapter connector up and insert it into the connector terminal of the desktop holder (1).**
 - Keeping the connector parallel with the desktop holder, firmly push it all the way in until it clicks.
- 2 Insert the AC adapter power plug into an outlet (2).**
- 3 When placing the FOMA terminal in the desktop holder, Charge start sound is heard, charging LED illuminates, and charging starts.**
 - Place the FOMA terminal in the direction of the arrow until it clicks as the figure shows (3).

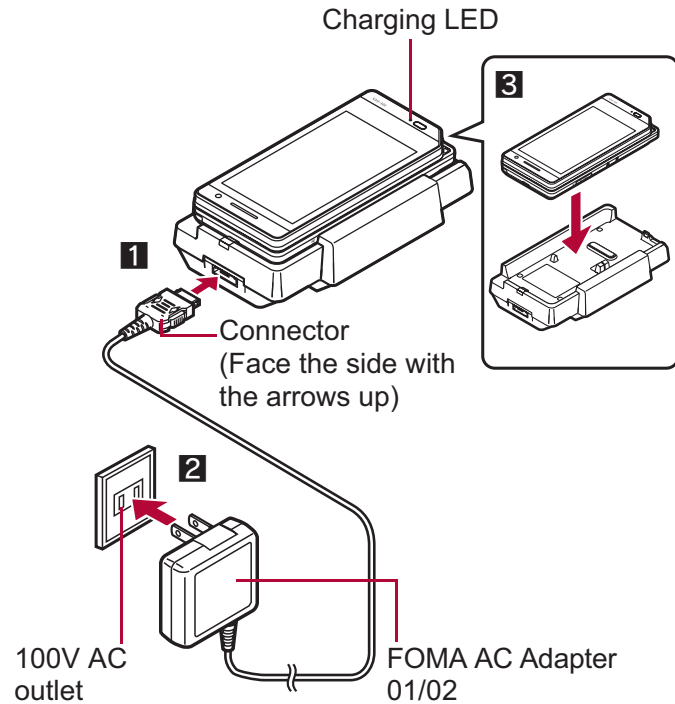

4 When Charge end sound is heard and charging LED turns off, charging is complete.

- Hold the desktop holder and lift the FOMA terminal out.





Charging with the desktop holder stood up
 Charging becomes available with the desktop holder stood up by using the stand behind the desktop holder.

- Do not force to make the stand behind stand up.

- Pull the AC adapter out of the outlet when left unused for a long period of time.
- When Charge start sound is not heard or when charging LED does not illuminate, check that the FOMA terminal is placed securely in the desktop holder (except when terminal is turned off, Manner mode is set or Charge start sound is Silent).
- When placing the FOMA terminal in the desktop holder, be careful that the strap is not caught in between the handset and the desktop holder.



Battery level

Checking battery level

	Battery level is still sufficient.
	Battery level is low.
	Battery is almost empty. Charge the battery.
	Battery is empty (Power will turn off soon).
	Battery pack is being charged.

Checking battery level with sound and display

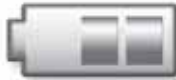
- 1 In the Custom menu, select **[Settings]** ▶ **[General settings]** ▶ **[Check status]** ▶ **[Battery level]**.

Graphic			
Sound	Three beeps	Two beeps	One beep
Status	Battery is sufficiently full.	Battery is running low.	Battery is almost empty. Charge the battery.

- Wait approximately 2 seconds and the display disappears.
- The battery level sound is heard at the volume set in Key/Touch sound (🔊 P. 96).

If battery runs out

[Battery empty. Unsaved data will be lost. Ending current operation] appears if battery starts to run out (Select [Agree] to clear the message). After a while, an alert tone sounds. The warning screen stating that the battery runs out appears, handset operations are disabled and power turns off after approximately 60 seconds.



- During a voice/Videophone call, the alert tone sounds and [Battery empty. Unsaved data will be lost. Ending current operation] appears. The call is disconnected after approximately 20 seconds. At the same time, the screen above appears and after approximately 60 seconds, the power turns off.
- Alert tone does not sound when Manner mode or Public mode (Drive mode) is set (Alert tone sounds during a call).

Power ON/OFF

Turning power ON/OFF

Turning power ON

1 Press  (for 2+ seconds).

- It may take some time for the wakeup screen to appear.
- The wakeup screen appears followed by the initial settings screen. Proceed to Initial setting (☞ P. 50).
- If initial settings have been completed, the screen shown on the right appears when power is turned on. This screen is called the “stand-by display”.

Welcome mail

- “Welcome^{††}デコメアニメ^{∩∩}” (Welcome^{††}Decome-Anime^{∩∩}) and “緊急速報「エリアメール」のご案内” (Information of Early Warning “Area Mail”) are saved by default.
- To check a welcome mail: In stand-by, select the stock icon  (mail message).
 - For details on the following operations ☞ P. 143



Stand-by display

- If initial settings are not yet completed, the setting screen appears every time the power is turned on.
- If the FOMA card is not inserted, [Insert UIM] and a FOMA card error appear (☞ P. 30).
- When [Enter PIN1 code] appears, enter the PIN1 code (☞ P. 114).
- When a FOMA card is replaced with a new card, the terminal security code (four to eight digits) must be entered after turning on the terminal. If a correct terminal security code is entered, stand-by display appears. When a wrong terminal security code is entered five times, the power is turned off. However, turning on the power again is possible.
- When  appears, the handset is outside the service area or in a place with no signal. Move to a place where the icon disappears.

Turning power OFF

1 Press  (for 2+ seconds).

- It may take some time for the power to be turned off (The end screen appears on the display until the power is turned off).

Select language

Changing screen display to English

1 In the Custom menu, select [設定] ▶ [一般設定] ▶ [Bilingual] ▶ [English].

- To switch the display language from English to Japanese: In the Custom menu, select [Settings] ▶ [General settings] ▶ [Select language] ▶ [日本語].

- If a FOMA card is inserted, settings are saved to the FOMA card as well. When the setting of the FOMA terminal handset and the setting of the inserted FOMA card are different, the setting in the FOMA card is prioritized.

Initial setting

Making initial setting

The initial settings screen appears automatically when the power is turned on for the first time. Each setting item can also be set from Menu (When the initial settings are complete, the stand-by display appears).

- Date and time settings
 - Key/Touch sound
 - Font size settings
 - Change terminal security code
 - Location request menu
- When items that have not been set remain, the setting screen appears every time the power is turned on.

1 Set the date and time (☞ P. 51).

2 Register a terminal security code (☞ P. 113).

3 Set the Key/Touch sound (☞ P. 96).

4 Set GPS Location provision ON/OFF (☞ P. 304).

5 Set the font size (☞ P. 109).

- When the initial settings are complete, the software update function confirmation screen appears. Read the description and select [Agree] (When the initial settings are made from the menu or the software update is set to other than [auto-update], the confirmation screen does not appear).

- Press [] to cancel the initial settings.

Date settings

Setting date and time

Set the date and time on the FOMA terminal.

- 1 In the Custom menu, select [Settings] ▶ [General settings] ▶ [Date settings].



- 2 Select the [Auto time correction] field ▶ select the setting.

- ◆ Select [ON] ▶ [Complete].
- ◆ Select [OFF] ▶ select the [Date] field ▶ enter the date ▶ [OK] ▶ select the [Time] field ▶ enter the time (24-hour format) ▶ [OK] ▶ [Complete].
 - When entering month, day and time, add 0 before numbers one through nine (example: 01, 02, 03, etc.).
 - Set the date and time from 00:00 January 1, 2001 to 23:59 December 31, 2050.

- When Limit settings is set to [Enable], the terminal security code must be entered in the Date settings.

- The date and time that are set are saved even if the battery pack is removed, but if the battery pack remains removed for approximately 30 seconds or more, the settings are reset. Also, if the battery remains empty, the settings may be reset. When this happens, set again after charging the battery.
- If the date and time are not set correctly, the following functions cannot be used properly.

■ Redial, Received calls	■ Auto power ON/OFF
■ Alarm	■ Schedule
■ SSL (authentication)	■ i-appli Auto start
■ Starting i-appliDX	■ Reception, Recording
■ Machi-chara	■ Software update
■ Pattern definitions update	
■ Record message (voice), Record message (Videophone calls)	
■ Camera image titles/shooting date	
■ Playback of i-motion or music data with expiration date/period for replay	
■ View of e-books/e-dictionaries/e-comics with expiration date/period for browse	

When Auto time correction is set to [ON]

- When the power is turned on, the FOMA terminal adjusts the time by connecting to the network's time information.
- If the FOMA terminal does not adjust the time even when the power is turned on, turn off the power and restart.
- Time may not be adjusted depending on the signal status.
- Time may be off by a few seconds.
- When time difference is adjusted overseas, the local time and date and ☎ appear in Redial, Received calls, Received/Sent messages history (SMS only), and Received/Sent messages list. The received/sent messages are not displayed in order of the displayed time and date but the mail reception/send.
- ☎ does not appear in the Unsent messages for mail messages. If the date order display is set for the Unsent messages, unsent messages are displayed in the order of the displayed time and date.
- Time correction may not be performed depending on the overseas network.

- During overseas use, Japan time and local time (or time set in City) appear in the dual display except for the following cases.
 - When Auto time correction is set to [ON] and time correction information is not being received from an overseas network
 - When Auto time correction is set to [OFF] and City is set to the city in the same time zone as Japan

■ Changing time zone manually <City>

1 In the Date settings screen, select the [Auto time correction] field ▶ [OFF] ▶ [City].

2 Select a time zone ▶ select a city ▶ [Complete].

Notify caller ID

Notifying the other party of your phone number

Display your number (caller ID) on the other party's phone (display) when making a voice/Videophone/PushTalk call.

- Handset number (caller ID) is important personal information. Be very careful about your caller ID setting.
- The Notify caller ID function is available only on compatible phone devices.

Setting Notify caller ID/No caller ID in advance

1 In the Custom menu, select [Settings] ▶ [NW Services] ▶ [Notify caller ID].

2 Select [Activate/Deactivate].

- To check the setting: Select [Check setting].

3 Select the setting.

- To notify caller ID: Select [Yes].
- To not notify caller ID: Select [No].

- Notify caller ID setting cannot be set from outside the service area.

Own number

Checking your own phone number

- When checking your own phone number during a call  P. 55

1 In the Custom menu, select [Phone] ▶ [Owner Information].

- Alternatively, press [J] in the Horizontal display menu.
- To switch between Number A and Number B (when 2in1 [Dual mode] is used): Select [Number A]/[Number B].

- When changing the Number B of 2in1, use any of the following methods to obtain the correct Number B.
 - Set 2in1 function OFF and then perform 2in1 setting again to set 2in1 function ON
 - Check the 2in1 subscription
- When a FOMA card exchange (2in1 subscriber → 2in1 nonsubscriber) is performed, set 2in1 function OFF.
- When a FOMA card exchange (2in1 subscriber → 2in1 subscriber) is performed, check the 2in1 subscription.
- For details on Owner information  P. 382

Overseas Use

Outline of international roaming (WORLD WING)	430
Available services overseas	431
Before use overseas	431
Making a call at your country of stay	434
Receiving a call overseas	435
Setting network communication system <3G/GSM setting>	435
Setting a search method of telecommunications carrier <Network search mode>	436
Setting a telecommunications carrier to preferentially connect to <PLMN setting>	436
Displaying a telecommunications carrier during roaming <Operator name disp>	437
Activating roaming guidance <Roaming guidance>	437
Setting incoming call to reject during roaming <Call barring>	437
Using Missed Call Notice function during roaming <Missed Call Notice>	438
Using network services during roaming <Int'l services>	438

Outline of international roaming (WORLD WING)

International roaming (WORLD WING) is a service that enables you, using overseas telecommunications carrier's networks, to make calls and use i-mode.

Use this FOMA terminal for voice/Videophone calls, i-mode and SMS with the phone number and mail address used in Japan.

Network services such as Voice Mail and Call Forwarding Services can also be used.

- This service is available in the 3G network and GSM/GPRS network service areas. Refer to the DOCOMO "International Services website" for details on the area.
- By default, the FOMA terminal is set to automatically switch networks (P. 436).
- Refer to the following before using the FOMA terminal overseas.
 - "Mobile Phone User's Guide [International Services]"
 - "Mobile Phone User's Guide [Network Services]"
 - PDF file "海外ご利用ガイド" pre-installed in [My Documents] of Data box

Country codes of major countries

The following shows "Country code" used when making international calls (P. 61) or setting International dial assist (P. 62).

- For other country codes and details, refer to the DOCOMO "International Services website".

Country/Region	Code	Country/Region	Code
Australia	61	Maldives	960
Austria	43	Netherlands	31
Belgium	32	New Caledonia	687
Brazil	55	New Zealand	64
Canada	1	Norway	47
China	86	Peru	51
Czech	420	Philippines	63
Egypt	20	Russia	7
Fiji	679	Singapore	65
Finland	358	South Korea	82
France	33	Spain	34
Germany	49	Sweden	46
Greece	30	Switzerland	41
Hong Kong	852	Tahiti (French Polynesia)	689
Hungary	36		
India	91	Taiwan	886
Indonesia	62	Thailand	66
Italy	39	Turkey	90
Japan	81	U.K.	44
Macau	853	U.S.A.	1
Malaysia	60	Vietnam	84

Available services overseas

The available communication services overseas are as follows.

Communication service	Explanation	3G	GSM	GPRS
Voice call*1, 2	Make or receive calls in your country of stay or make international calls to Japan or to other countries with the same phone number as used in Japan while abroad.	○	○	○
Videophone*1, 2	Make international Videophone calls to users of the specified 3G telecommunications carriers overseas and FOMA users in Japan.	○	×	×
i-mode mail	Send or receive i-mode mail overseas with the same address as used in Japan.	○	×	○
i-mode*3	Use i-mode overseas.	○	×	○
i-Channel*3, 4	Use i-Channel overseas.	○	×	○
i-concier*5	Use i-concier overseas.	○	×	○
i-Widget*6	Use i-Widget overseas.	○	×	○
SMS	Send or receive SMS overseas with the same phone number as used in Japan.	○	○	○
Packet transmission by connecting a PC, etc.*7	Use packet transmission overseas.	○	×	○

*1 When the 2in1 is used, calling from Number B is not available overseas.

*2 When Multi Number is used, calling from Additional Number is not available overseas.

*3 Overseas use settings for i-mode is required.

*4 i-Channel setting is required. Packet transmission charges are incurred for each i-Channel reception (including Basic channel).

*5 Overseas use settings for i-concier is required. Packet transmission charges are incurred for each information reception.

*6 Setting for i-Widget roaming is required. Multiple Widget appli may attempt transmission when i-Widget screen appears. In such case, packet transmission charges are incurred for each transmission.

*7 Unable to use 64K data communication by connecting a PC, etc.

- Some services are not available depending on the telecommunications carrier or network. Refer to the DOCOMO “International Services website” for information on available countries and regions, and telecommunications carriers.
- Overseas packet transmission charges differ from those in Japan (Free call in Japan does not apply).
- 日英版しゃべって翻訳 for SH (J-E Speech Translation for SH) is available overseas (P. 267).
- GPS function is not available overseas. An error screen appears and packet transmission charges are incurred when the site of GPS Service settings is accessed overseas.

Before use overseas

The following items must be checked before departure, at your country of stay, and after homecoming.

Preparation before departure

Prepare below in Japan before using the FOMA terminal overseas.

About contract

- If subscribed to the FOMA service after September 1, 2005, a subscription for “WORLD WING” is not required. However, if a subscription for “WORLD WING” is canceled at or after a subscription for the FOMA service, a subscription for “WORLD WING” is required again.

- If subscribed to the FOMA service before August 31, 2005 but not subscribed to “WORLD WING”, a subscription for “WORLD WING” is required. Some payment plans are not available.
- Insert the WORLD WING compatible FOMA card (other than blue) to the FOMA terminal (☎ P. 41).

■ About charging batteries

- Precautions for handling the AC adapter ☎ P. 16
- Methods for charging the AC adapter ☎ P. 45

■ About browsing i-mode sites

To browse i-mode site overseas, the settings for overseas use must be made from iMenu in advance.

i-mode site: Select [iMenu] ▶ [English] ▶ [Options] ▶ [International Settings] ▶ [i-mode services Settings].

- Refer to “Mobile Phone User’s Guide [International Services]” and “Mobile Phone User’s Guide [i-mode] FOMA version” for details.

■ About setting network service

If subscribed to network services, Voice Mail Service, Call Forwarding Service or other services can be used overseas.

- Some network services may not be set or checked depending on overseas telecommunications carrier. In addition, some network services are available only in Japan. Refer to “Mobile Phone User’s Guide [International Services]” and “Mobile Phone User’s Guide [Network Services]” before departure.
- To use network services overseas, set Remote Control (☎ P. 422, P. 438) to “Activate”.

■ About inquiries overseas

For lost, stolen, and cost settlement, or malfunction of the FOMA terminal overseas, refer to “Loss or theft of FOMA terminal or payment of cumulative cost overseas” or “Failures encountered overseas” on the back of this manual. Note that any call or transmission charges incurred after the FOMA terminal is lost or stolen are charged to the subscriber.

- Add the “International call access code (Table 1)” or “International prefix number for the universal number (Table 2)” that is assigned to your country of stay, to the head of your phone number for inquiries.

- For the latest information of the international call access code and the international prefix number for the universal number, refer to the DOCOMO “International Services website”.

International call access codes of major countries (Table 1)

The following shows the International call access codes of major countries.

- Communication charges to Japan will apply.

Country/Region	Code	Country/Region	Code
Australia	0011	Monaco	00
Belgium	00	Netherlands	00
Brazil	0021/ 0014	New Zealand	00
		Norway	00
Canada	011	Philippines	00
China	00	Poland	00
Czech	00	Portugal	00
Denmark	00	Russia	810
Finland	00	Singapore	001
France	00	South Korea	001
Germany	00	Spain	00
Greece	00	Sweden	00
Hong Kong	001	Switzerland	00
Hungary	00	Taiwan	002
India	00	Thailand	001
Indonesia	001	Turkey	00
Ireland	00	U.A.E.	00
Italy	00	U.K.	00
Luxemburg	00	U.S.A.	011
Macau	00	Vietnam	00
Malaysia	00		

International prefix number for the universal number (Table 2)

The following shows the International prefix number for the universal number of each country.

- Communication charges or other charges to your country of stay will apply.
- Communication charges to your country of stay will apply when calling from the mobile phone.

Country/Region	Code	Country/Region	Code
Argentina	00	Luxemburg	00
Australia	0011	Malaysia	00
Austria	00	Netherlands	00
Belgium	00	New Zealand	00
Brazil	0021	Norway	00
Bulgaria	00	Peru	00
Canada	011	Philippines	00
China	00	Portugal	00
Columbia	009	Singapore	001
Denmark	00	South Africa	09
Finland	990	South Korea	001
France	00	Spain	00
Germany	00	Sweden	00
Hong Kong	001	Switzerland	00
Hungary	00	Taiwan	00
Ireland	00	Thailand	001
Israel	014	U.K.	00
Italy	00	U.S.A.	011

- Some codes may not be used.
- Note that the universal number may not be used for calls from a mobile phone, payphone or hotel.
- The universal number can be used only for countries listed above.
- Calling from a hotel may cost you extra call charges requested by the hotel (You are responsible for the call charges). Confirm with the hotel before making calls.

Using at your country of stay

The service is available in the 3G network and GSM/GPRS network service areas.

The FOMA terminal is set to automatically search for the network when the power is turned on, and to be connected to the available telecommunications carrier in your country of stay.

- When Auto time correction (P. 51) is set to [ON], if information with time and time differences is received from overseas telecommunications carrier which is being connected, time and time differences on the FOMA terminal clock are corrected. The correction timing differs depending on the telecommunications carrier.
- Auto time correction may not be available overseas. In such case, correct the time manually (P. 51).
- If the connected telecommunications carrier is changed when Auto time correction is set to [ON], a screen notifying that time difference is adjusted may appear.
- When Operator name display (P. 437) is set to [Display on], the telecommunications carrier connected appears in stand-by.
- When Clock display (P. 100) is set to [ON(Large)], the local time and Japan time appear (excluding regions keeping the same standard time as Japan time).
- Talk time or stand-by time may be reduced to half the normal time depending on the network condition of your country of stay.

Setting after homecoming

By default, the FOMA terminal is set to automatically search for the network and to be connected to the FOMA network when the power is turned on after homecoming.

- If the Network search mode is set to [Manual], switch to the FOMA network (DOCOMO) manually or change to [Auto].
- Set the 3G/GSM setting to [AUTO] or [3G].

Making a call at your country of stay

Make a call from overseas using the international roaming service.

Making a call outside your country of stay (including Japan)

Make a call from your country of stay to Japan or other countries.

1 In stand-by, press ▶ keep touching [0(+)] ▶ enter country code, area code (city code) and other party's phone number.

- When the area code (city code) begins with **0**, omit the **0** when dialing (However, include **0** when making a call to landline phones in some countries or regions such as Italy).

2 Select or press (Phone)/select [V.phone].

■ Making an international call outside your country of stay using Country code conversion

Set Country code conversion (P. 62) to [ON] and set the country code frequently called to easily make an international call.

- **0** at the beginning of a phone number is automatically converted to the country code set in Country code conversion.

Example: Make a call from phonebook

1 In the Stand-by Display Touch Launcher, select ▶ select the other party.

2 Select [Phone] or press (Phone)/select [V.phone].

3 Select [Call].

- To dial a phone number as stored in the phonebook: Select [Original number].

■ Making a call to the phone in country saved in Set country code

Save a country code using Set country code (P. 63) to select a country code before making an international call.

- The following operation is available overseas only.

1 In stand-by, press ▶ enter a phone number ▶ [Submenu] ▶ [Add prefix setting] ▶ [International Call].

2 Select the country code.

3 Press (Phone)/select [V.phone].

Making a call in your country of stay

Make a domestic call at your country of stay in the same way as you do in Japan.

1 In stand-by, press ▶ enter a phone number.

2 Press (Phone)/select [V.phone].

- Always dial the area code (city code), even when the number is in the same area.
- When making a domestic call at your country of stay using the phonebook, select [Original number] in step 3 of “Making an international call outside your country of stay using Country code conversion” on P. 434.

- Refer to the DOCOMO “International Services website” for details on available countries, country codes and telecommunications carriers.
- Even when Notify caller ID of the network service (P. 52) is set to “Send ID”, [Unavailable] or [User unset] appears depending on the telecommunications carrier, and the caller ID may not be displayed correctly.

Making a call to a WORLD WING subscriber overseas

When making a call to a “WORLD WING” subscriber overseas, make an international call to Japan regardless of your country of stay.

- 1 In stand-by, press **[V]** ▶ keep touching **[0(+)]** ▶ enter country code **81 (Japan)** and the other party's mobile phone number excluding **0**.
- 2 Select **[↶]** or press **[V]** (Phone)/select **[V.phone]**.

Receiving a call overseas

Receive a call overseas in the same way as you do in Japan.

- 1 Press **[V]** to receive an incoming call.
 - Speak to the caller.

- Even when a caller tried to notify of caller ID, it might not be notified depending on the used telecommunications carrier.
- When a call is received during international roaming, the call is forwarded from Japan. Call charges to Japan are incurred by the caller and receiving charges by the receiver.

Having calls to your FOMA terminal

Having calls made to your FOMA terminal from Japan

To receive an international call from Japan, have your phone number dialed just as a domestic call in Japan.

090 (or **080**)-XXXX-XXXX

- Calling from Received calls may not be available since the phone number may not be displayed correctly.

Having calls made to your FOMA terminal from countries other than Japan

Have the international call access code and **81** (Japan) added to the beginning of your phone number, and **0** excluded as an international call to Japan regardless of your country of stay.

International call access code of the country of the caller-81-90 (or *80*)-XXXX-XXXX

3G/GSM setting

Setting network communication system

Set the communication system supporting your area and telecommunications carrier.

- 1 In the Custom menu, select **[Settings]** ▶ **[Phone settings]** ▶ **[Other settings]** ▶ **[International Roam.]** ▶ **[3G/GSM setting]**.
- 2 Select the communication method.

Network search mode

Setting a search method of telecommunications carrier

- Set to manually select a telecommunications carrier.
- Re-search a network to set another telecommunications carrier.
- Check that the Network search mode is set to [Auto] when  appears even after homecoming.
- If telecommunications carrier is selected with [Manual] set abroad, manually set to the FOMA network (DOCOMO) again or change to [Auto] after homecoming.

1 In the Custom menu, select [Settings] ▶ [Phone settings] ▶ [Other settings] ▶ [International Roam.] ▶ [Network search mode].

2 Select the setting.

- ◆ Select [Auto] ▶ [Yes].
 - When [Auto] is set: Select [Auto].
- ◆ Select [Manual] ▶ select a telecommunications carrier.
 - The telecommunications carrier is changed.
- ◆ Select [Network re-search].
 - The host network is changed automatically if the Network search mode is set to [Auto]. If set to [Manual], select a telecommunications carrier.

Checking communication services available

<In-area status>

Check the status whether making a call, data transmission or packet transmission is available.

1 In the Custom menu, select [Settings] ▶ [Phone settings] ▶ [Other settings] ▶ [In-area status] ▶ [Agree].

PLMN setting

Setting a telecommunications carrier to preferentially connect to

Specify the priority order of telecommunications carriers connected to when the Network search mode is set to [Auto]. Save up to 20.

1 In the Custom menu, select [Settings] ▶ [Phone settings] ▶ [Other settings] ▶ [International Roam.] ▶ [Network search mode] ▶ [PLMN setting].

- To check the saved telecommunications carrier's detailed information: Select the telecommunications carrier.

2 Point the cursor to the priority order ▶ [Submenu].

3 Select the saving method.

- ◆ Select [PLMN manual select] ▶ enter a country code (MCC) ▶ [OK] ▶ enter a network code (MNC) ▶ [OK] ▶ select a communication method.
- ◆ Select [UPLMN by list] ▶ select a telecommunications carrier ▶ select a communication method.
 - To search a telecommunications carrier from country name: Select [UPLMN by list] ▶ [Search] ▶ select a country name ▶ select a telecommunications carrier ▶ select a communication method.
- ◆ Select [Set VPLMN to PLMN].
 - Save the telecommunications carrier currently connected to.
- ◆ Select [Change priority] ▶ select a destination.
- ◆ Select [Delete] ▶ [Delete one].
- ◆ Select [Delete] ▶ [Delete all] ▶ enter the terminal security code ▶ [OK].

4 Select [Yes].

Operator name disp

Displaying a telecommunications carrier during roaming

Set whether to display a telecommunications carrier name currently connected to in stand-by during international roaming.

1 In the Custom menu, select [Settings] ▶ [Phone settings] ▶ [Other settings] ▶ [International Roam.] ▶ [Operator name disp].

2 Select the setting ▶ [Yes].

■ When displaying a telecommunications carrier

Telecommunications carrier name

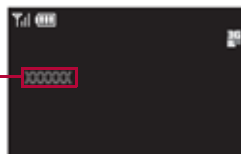

Roaming guidance

Activating roaming guidance

When a call is received during international roaming, the caller hears the guidance stating that international roaming is activated.

● Make this setting while still in Japan.

1 In the Custom menu, select [Settings] ▶ [Other NW Services] ▶ [Roaming guidance].

2 Select an item.

3 Select [Yes].

Call barring

Setting incoming call to reject during roaming

Set the FOMA terminal to reject calls during roaming. Select whether to bar all incoming calls or only the Videophone and 64K data communication calls.

- Depending on the overseas telecommunications carrier, the setting cannot be made.
- Unable to use 64K data communication overseas.

1 In the Custom menu, select [Settings] ▶ [Phone settings] ▶ [Other settings] ▶ [International Roam.] ▶ [Call barring].

2 Select an item.

- ◆ Select [Activate] ▶ [Yes] ▶ select the barring method ▶ enter the network security code ▶ [OK].
- ◆ Select [Deactivate] ▶ [Yes] ▶ enter the network security code ▶ [OK].
- ◆ Select [Check setting].

Missed Call Notice

Using Missed Call Notice function during roaming

When the FOMA terminal is outside the service area, turned off, or a received call cannot be answered during International roaming, the information of the call (Received date and time or caller ID) is notified with SMS.

- 1** In the Custom menu, select [Settings] ▶ [Phone settings] ▶ [Other settings] ▶ [International Roam.] ▶ [Missed Call Notice].
- 2** Select an item.
 - ◆ Select [Activate] ▶ [Yes].
 - ◆ Select [Deactivate] ▶ [Yes].
 - ◆ Select [Check setting].

Int'l services

Using network services during roaming

Use network services such as Voice Mail and Call Forwarding from overseas.

- Set at a country to stay.
- Voice Mail and Call Forwarding subscription are required to use Voice Mail (Int.) and Call Forward (Int.).
- To use network services overseas, set Remote Control (P. 422) to "Activate" in advance.
- If operated from overseas, international call charges for your country of stay are incurred.

- 1** In the Custom menu, select [Settings] ▶ [Phone settings] ▶ [Other settings] ▶ [International Roam.].
- 2** Select an item.
 - ◆ Select [Voice Mail(Int.)] ▶ select an item of Voice Mail Service.
 - ◆ Select [Call Forward (Int.)] ▶ select an item of Call Forwarding Service.
 - ◆ Select [Remote access (Int.)].
 - ◆ Select [Caller ID req (Int.)].
 - ◆ Select [Roam. guidance(Int.)].
 - ◆ Select [MissedCallNoticeInt.].
- 3** Select [Yes] ▶ operate according to the voice guidance.

Introduction of options and related devices

Combine the FOMA terminal with various optional accessories (sold separately) for expanded personal and business use. Some products may not be available in certain areas. Contact a docomo Shop or retailer for details. Refer to the user's guide of each product for more details.

- FOMA AC Adapter 01*1/02*1
- Battery Pack SH18
- Back Cover SH29
- Desktop Holder SH24
- Earphone Terminal P001*2
- Flat-plug Stereo Earphone Set P01*3
- Flat-plug Earphone/Microphone with Switch P01*3/P02*3
- Stereo Earphone Set P001*2
- Earphone/Microphone with Switch P001*2/P002*2
- Earphone/Microphone 01
- Stereo Earphone Set 01
- Earphone Plug Adapter P001*3
- Earphone Plug Adapter for External connector terminal 01
- Earphone Plug Adapter 01
- FOMA USB Cable*4
- Wireless Earphone Set 02
- FOMA AC Adapter 01 for Global use*1
- FOMA DC Adapter 01/02
- FOMA Indoor Booster Antenna*5
- In-Car Hands-Free Kit 01*6
- FOMA In-Car Hands-free Cable 01
- In-Car Holder 01*7
- FOMA Dry Battery Adapter 01
- Carry Case L 01
- Bone conduction microphone/receiver 01*3/02
- FOMA USB Cable with Charge Function 02*4
- FOMA Portable Charging Adapter 01
- FOMA Indoor Booster Antenna (Stand Type)*5

*1 Refer to P. 43 for details on charging with an AC adapter.

*2 Connect Earphone Plug Adapter for External connector terminal 01 and Earphone Plug Adapter to use these options and accessories.

- *3 Connect Earphone Plug Adapter for External connector terminal 01 to use these options and accessories.
- *4 The use of USB HUB may not work correctly.
- *5 For use only in Japan.
- *6 FOMA In-Car Hands-Free Cable 01 is required to charge and connect with the USB cable.
- *7 Activate Touch panel/Side key lock to use the In-Car Holder 01.

Interfacing to external devices

Play back movies saved on microSD Cards on the FOMA terminal by using supported external devices.* microSD Cards are sold separately. Purchase microSD Cards at home electronics shops (☎ P. 345).

For details on compatible devices, refer to <http://k-tai.sharp.co.jp/support/d/sh-04a/>. Or, contact the number below.

- Play i-motion created on external devices (including music data in AAC format) on the FOMA terminal (☎ P. 260).
- * Some movies cannot be played back depending on the file format or the type of external device.

Sharp Data Communication Support Center

TEL: 03-5396-2351

Hours: 10:00 A.M. to 12:00 noon, 1:00 P.M. to 5:00 P.M.,
Monday through Friday

(Closed on weekends, national holidays, and company holidays)

- Check the phone number carefully before dialing.

Specific Absorption Rate (SAR) of mobile phone

This model phone SH-04A meets the MIC's* technical regulation for exposure to radio waves.

The technical regulation established permitted levels of radio frequency energy, based on standards that were developed by independent scientific organizations through periodic and thorough evaluation of scientific studies. The regulation employs a unit of measurement known as the Specific Absorption Rate, or SAR. The SAR limit is 2 watts/kilogram (W/kg)** averaged over ten grams of tissue. The limit includes a substantial safety margin designed to assure the safety of all persons, regardless of age and health. The value of the limit is equal to the international guidelines recommended by ICNIRP***. All phone models should be confirmed to comply with the regulation, before they are available for sale to the public. The highest SAR value for this model phone is 0.928 W/kg. It was taken by the Telecom Engineering Center (TELEC), a Registered Certification Agency on the Radio Law. The test for SAR was conducted in accordance with the MIC testing procedure using standard operating positions with the phone transmitting at its highest permitted power level in all tested frequency bands. While there may be differences between the SAR levels of various phones and at various positions, they all meet the MIC's technical regulation. Although the SAR is determined at the highest certified power level, the actual SAR of the phone during operation can be well below the maximum value. For further information about SAR, please see the following websites:

World Health Organization (WHO)

<http://www.who.int/peh-emf/>

ICNIRP

<http://www.icnirp.de/>

MIC

<http://www.tele.soumu.go.jp/e/e/e/body/index.htm>

TELEC

http://www.telec.or.jp/ENG/Index_e.htm

NTT DOCOMO

<http://www.nttdocomo.co.jp/english/product/>

SHARP Corporation

<http://www.sharp.co.jp/products/menu/phone/cellular/sar/index.html>

* Ministry of Internal Affairs and Communications

** The technical regulation is provided in Article 14-2 of the Ministry Ordinance Regulating Radio Equipment.

*** International Commission on Non-Ionizing Radiation Protection

European RF Exposure Information

Your mobile device is a radio transmitter and receiver. It is designed not to exceed the limits for exposure to radio waves recommended by international guidelines. These guidelines were developed by the independent scientific organization ICNIRP and include safety margins designed to assure the protection of all persons, regardless of age and health.

The guidelines use a unit of measurement known as the Specific Absorption Rate, or SAR. The SAR limit for mobile devices is 2 W/kg and the highest SAR value for this device when tested at the ear was 0.683 W/kg*.

As SAR is measured utilizing the devices highest transmitting power the actual SAR of this device while operating is typically below that indicated above. This is due to automatic changes to the power level of the device to ensure it only uses the minimum level required to reach the network. The World Health Organization has stated that present scientific information does not indicate the need for any special precautions for the use of mobile devices. They note that if you want to reduce your exposure then you can do so by limiting the length of calls or using a hands-free device to keep the mobile phone away from the head.

* The tests are carried out in accordance with international guidelines for testing.

Declaration of Conformity

CE 0168

Hereby, Sharp Telecommunications of Europe Ltd, declares that this SH-04A is in compliance with the essential requirements and other relevant provisions of Directive 1999/5/EC.

A copy of the original declaration of conformity can be found at the following internet address:

<http://www.sharp.co.jp/k-tai/>

FCC Notice

- This device complies with part 15 of the FCC Rules. Operation is subject to the following two conditions: (1) This device may not cause harmful interference, and (2) this device must accept any interference received, including interference that may cause undesired operation.
- Changes or modifications not expressly approved by the manufacturer responsible for compliance could void the user's authority to operate the equipment.

Information to User

This equipment has been tested and found to comply with the limits of a Class B digital device, pursuant to Part 15 of the FCC Rules. These limits are designed to provide reasonable protection against harmful interference in a residential installation. This equipment generates, uses and can radiate radio frequency energy and, if not installed and used in accordance with the instructions, may cause harmful interference to radio communications. However, there is no guarantee that interference will not occur in a particular installation; if this equipment does cause harmful interference to radio or television reception, which can be determined by turning the equipment off and on, the user is encouraged to try to correct the interference by one or more of the following measures:

1. Reorient/relocate the receiving antenna.
2. Increase the separation between the equipment and receiver.
3. Connect the equipment into an outlet on a circuit different from that to which the receiver is connected.
4. Consult the dealer or an experienced radio/TV technician for help.

FCC RF Exposure Information

Your handset is a radio transmitter and receiver. It is designed and manufactured not to exceed the emission limits for exposure to radio frequency (RF) energy set by the Federal Communications Commission of the U.S. Government. The guidelines are based on standards that were developed by independent scientific organisations through periodic and thorough evaluation of scientific studies. The standards include a substantial safety margin designed to assure the safety of all persons, regardless of age and health.

The exposure standard for wireless handsets employs a unit of measurement known as the Specific Absorption Rate, or SAR. The SAR limit set by the FCC is 1.6 W/kg.

The tests are performed in positions and locations (e.g., at the ear and worn on the body) as required by the FCC for each model. The highest SAR value for this model handset when tested for use at the ear is 0.685 W/kg and when worn on the body, as described in this user guide, is 0.582 W/kg. Body-worn Operation; This device was tested for typical body-worn operations with the back of the handset kept 1.5 cm from the body. To maintain compliance with FCC RF exposure requirements, use accessories that maintain a 1.5 cm separation distance between the user's body and the back of the handset. The use of beltclips, holsters and similar accessories should not contain metallic components in its assembly.

The use of accessories that do not satisfy these requirements may not comply with FCC RF exposure requirements, and should be avoided.

The FCC has granted an Equipment Authorization for this model handset with all reported SAR levels evaluated as in compliance with the FCC RF emission guidelines. SAR information on this model handset is on file with the FCC and can be found under the Display Grant section of <http://www.fcc.gov/oet/fccid> after searching on FCC ID APYHRO00088.

Additional information on Specific Absorption Rates (SAR) can be found on the Cellular Telecommunications & Internet Association (CTIA) Website at <http://www.phonefacts.net>.

Export Administration Regulations

The Japan Export Administration Regulations ("Foreign Exchange and International Trade Law" and its related laws) will be applied to this product and its accessories under certain conditions. The Export Administration Regulations are also applied. To export or reexport this terminal and its accessories, conduct all legally required procedures at your own risk and expense. For details on the procedures, contact the Ministry of Economy, Trade and Industry or the US Department of Commerce.

Intellectual property rights

Copyrights and rights of portrait

- Data with third party copyrights such as text, images, music and software that is downloaded or acquired via Internet web pages, shot by the FOMA terminal, or acquired from TV or other video cannot be duplicated, altered or publicly transmitted without rightful party's consent. Only duplicating, quoting, etc. for personal use is permitted under copyright laws.

Even if for personal use, filming and recording may be prohibited for demonstrations, performances and exhibitions.

Also, shooting another's image or posting another's image on Internet web pages without their consent may constitute a violation of one's right to their image.

Registered trademarks and trademarks





- "FOMA", "mova", "ToruCa", "PushTalk", "PushTalkPlus", "mopera", "mopera U", "FirstPass", "Chara-den", "Deco-mail", "Chaku-motion", "i-motion mail", "i-appli", "i-appliDX", "i-motion", "i-mode", "i-Channel", "iD", "DCMX", "WORLD WING", "Public mode", "DoPa", "WORLD CALL", "Dual Network", "visualnet", "V-live", "Security Scan", "musea", "sigmarion", "OFFICEED", "IMCS", "i-area", "2in1", "Chokkan Game", the "i-mode" logo, the "FOMA" logo, the "i-appli" logo, the "DCMX" logo, the "iD" logo, the "HIGH-SPEED" logo are trademarks or registered trademarks of NTT DOCOMO, INC.
- Free Dial logo mark is a registered trademark of NTT Communications Corporation.
- **symbian** This product includes software licensed from Symbian Software Ltd.
Symbian, Symbian OS and other associated Symbian marks are all trademarks of Symbian Software Ltd.
© 1998-2008 Symbian Software Ltd. All rights reserved.

- Catch Phone (Call Waiting) is a registered trademark of Nippon Telegraph and Telephone Corporation.
- Multitask is a registered trademark of NEC Corporation.
- This product is equipped with NetFront Browser, NetFront Sync Client and NetFront Browser DTV Profile Wireless Edition by ACCESS Co., Ltd. for an internet browser or other application software.
- This product adopts Media: specifications of ACCESS CO., Ltd. for activating broadcasting contents.
Copyright © 1996-2008 ACCESS CO., LTD.
- ACCESS, NetFront and Media: are trademarks or registered trademarks of ACCESS Co., Ltd. in the United States, Japan and other countries.

ACCESS™ NetFront®

- Microsoft®, Windows®, Windows Vista®, PowerPoint® and Windows Media® are trademarks or registered trademarks of Microsoft Corporation in the U.S.A. and other countries.
- Microsoft Excel and Microsoft Word are product names of Microsoft Corporation in the U.S.A.
- Java and all Java-based trademarks and logos are trademarks or registered trademarks of Sun Microsystems, Inc. in the U.S.A. and other countries.
- QuickTime is a registered trademark of Apple Inc., in the US and other countries.
- QR code is a registered trademark of Denso Wave Inc.
- microSDHC Logo is a trademark.
- Powered by JBlend™ Copyright 2002-2008 Aplix Corporation.
All rights reserved.
JBlend and JBlend related trademarks are registered trademarks or trademarks of Aplix Corporation in Japan and other countries.



-  Document Viewer is powered by Picstel Technologies.
Picstel, Picstel Powered, Picstel Viewer, Picstel Document Viewer and the Picstel cube logo are trademarks or registered trademarks of Picstel Technologies and/or its affiliates.
- “AXISFont” is a trademark of AXIS Inc. in Japan.
- This handset features LCFONT, developed by Sharp Corporation, to make the LCD easier to view and read. LCフォント/LCFONT and  are registered trademarks of Sharp Corporation.
- Heisei font is an intellectual property of Font Development and Promotion Center of Japanese Standards Association, and “SH Heisei Mincho” is a font developed by DynaComware Corp. with a license.
- DynaFont is a registered trademark of DynaComware Taiwan Inc.
- McAfee® is registered trademarks or trademarks of McAfee, Inc. and/or its affiliates in the U.S.A. and other countries.
- Gガイド, G-GUIDE, Gガイドモバイル, G-GUIDE MOBILE and the G-GUIDE related logos are registered trademarks of Gemstar-TV Guide International, Inc. and/or its affiliates in Japan. 
- Google and Google Map for Mobile are trademarks of Google Inc.
- IrSimple™, IrSS™ or IrSimpleShot™ are trademarks of Infrared Data Association®.
- F e l i C a , which uses non-contact IC card technology, was created by Sony Corporation.
- F e l i C a is a registered trademark of Sony Corporation.
-  is a registered trademark of FeliCa Networks, Inc.
- Napster is a registered trademark of Napster, LLC. and/or its affiliates in the US and/or other countries.
- Dolby and the double-D symbol are registered trademarks of Dolby Laboratories.
- FlashFX® Pro™ is a trademark or registered trademark of the Datalight, Inc. in the US.
(U.S. Patent Office 5,860,082/6,260,156)

- PhotoSolid®, FaceSolid™, FrameSolid®, ImageScouter™, and ImageSurf™ are the trademarks or the registered trademarks of Morpho, Inc.
- “AQUOSケータイ”, “Desktop clock”, “VeilView”, “Egao focus shutter”, “Furimuki shutter”, “Shotdeco”, “Wakeup TV”, “Stand-by Display Touch Launcher”, “Long Touch Menu”, “Quick Settings”, and “Quick Stand-by Display Setting” are trademarks or registered trademarks of Sharp Corporation.
- All other company names and product names are trademarks or registered trademarks of the respective companies.

Others

- Under the MPEG-4 Visual Patent Portfolio License, customers have licensed permission for the following use of this product to engage in non-profit personal use. Other uses are not permitted.
 - Encoding MPEG-4 standard video (henceforth referred to as MPEG-4 video).
 - Decoding an MPEG-4 video that a customer not engaged in personal commercial activities has encoded.
 - Decoding an MPEG-4 video obtained from a licensed provider. For details on other intended uses, contact MPEG LA, LLC.
- This product is licensed under the MPEG-4 Systems Patent Portfolio License for encoding in compliance with the MPEG-4 Systems Standard. An additional license and payment of royalties are necessary in the following cases.
 - Data stored or replicated in physical media which is paid for on a title by title basis.
 - Data which is paid for on a title by title basis and is transmitted to an end user for permanent storage and/or use.
 Such additional license may be obtained from MPEG LA, LLC. Contact MPEG LA, LLC for additional details.

- This product is licensed under the AVC patent portfolio license for the personal and noncommercial use of a consumer to (i) encode video in compliance with the AVC standard (henceforth referred to as AVC video) and/or (ii) decode AVC video that was encoded by a consumer engaged in a personal and noncommercial activity and/or was obtained from a video provider licensed to provide AVC video. No license is granted or shall be implied for any other use. Additional information may be obtained from MPEG LA, L.L.C.
See [HTTP://WWW.MPEGLA.COM](http://www.mpegla.com)
- This product is licensed under the VC-1 Patent Portfolio License for the personal and noncommercial use of a consumer to (i) encode video in compliance with the VC-1 standard (henceforth referred to as VC-1 video) and/or (ii) decode VC-1 video that was encoded by a consumer engaged in a personal and noncommercial activity and/or was obtained from a video provider licensed to provide VC-1 video. No license is granted or shall be implied for any other use. Additional information may be obtained from MPEG LA, L.L.C.
See [HTTP://WWW.MPEGLA.COM](http://www.mpegla.com)
- Contains Adobe® Flash® Lite™ and Adobe Reader® LE technology by Adobe Systems Incorporated
Adobe Flash Lite Copyright © 2003-2008 Adobe System Incorporated. All rights reserved.
Adobe Reader LE Copyright © 1993-2007 Adobe Systems Incorporated. All rights reserved.
Adobe, Adobe Reader, Flash, and Flash Lite are either registered trademarks or trademarks of Adobe Systems Incorporated in the United States and/or other countries.
- This product includes modules developed by the Independent JPEG Group.
- This product uses the GestureTek technology.
Copyright © 2006-2008, GestureTek, Inc. All Rights Reserved.
- This product is equipped with “Fugue” by Kyoto Software Research, Inc. for a file system function.



Fugue ©1999-2008 Kyoto Software Research, Inc. All rights reserved.

- Manufactured under license from Dolby Laboratories.
- Bluetooth software stack of this product is developed by TOSHIBA CORPORATION, and contains Toshiba Embedded Bluetooth Stack for Symbian with the copyright of TOSHIBA CORPORATION.
- Content owners use Windows Media digital rights management (WMDRM) technology to protect their intellectual property, including copyrights. This device uses WMDRM software to access WMDRM-protected contents. If the WMDRM software fails to protect the content, content owners may ask Microsoft to revoke the software’s ability to use WMDRM to play or copy protected content. Revocation does not affect unprotected content. When you download licenses for protected content, you agree that Microsoft may include a revocation list with the licenses. Content owners may require you to upgrade WMDRM to access their content. If you decline an upgrade, you will not be able to access content that requires the upgrade.
- CP8 PATENT
- This manual refers to each OS (Japanese version) as follows.
 - Windows Vista is an abbreviation of Windows Vista® (Home Basic, Home Premium, Business, Enterprise, Ultimate).
 - Windows XP is an abbreviation of Microsoft® Windows® XP Professional operating system or Microsoft® Windows® XP Home Edition operating system.
 - Windows 2000 is an abbreviation of Microsoft® Windows® 2000 Professional operating system.
- The Bluetooth word mark and logos are owned by Bluetooth SIG, Inc. and any use of such marks by NTT DOCOMO, INC. is under license. Other trademarks and trade names are those of their respective owners.

- Internet dictionary embedded in this product uses the BSD license.
Copyright © 2002,2003, Stefan Haustein, Oberhausen, Rhld., Germany
All rights reserved
 - Redistribution and use in source and binary forms, with or without modification, are permitted provided that the following conditions are met:
 - Redistributions of source code must retain the above copyright notice, this list of conditions and the following disclaimer.
Redistributions in binary form must reproduce the above copyright notice, this list of conditions and the following disclaimer in the documentation and/or other materials provided with the distribution.
 - Neither the name of the <ORGANIZATION> nor the names of its contributors may be used to endorse or promote products derived from this software without specific prior written permission.

THIS SOFTWARE IS PROVIDED BY THE COPYRIGHT HOLDERS AND CONTRIBUTORS "AS IS" AND ANY EXPRESS OR IMPLIED WARRANTIES, INCLUDING, BUT NOT LIMITED TO, THE IMPLIED WARRANTIES OF MERCHANTABILITY AND FITNESS FOR A PARTICULAR PURPOSE ARE DISCLAIMED. IN NO EVENT SHALL THE COPYRIGHT OWNER OR CONTRIBUTORS BE LIABLE FOR ANY DIRECT, INDIRECT, INCIDENTAL, SPECIAL, EXEMPLARY, OR CONSEQUENTIAL DAMAGES (INCLUDING, BUT NOT LIMITED TO, PROCUREMENT OF SUBSTITUTE GOODS OR SERVICES; LOSS OF USE, DATA, OR PROFITS; OR BUSINESS INTERRUPTION) HOWEVER CAUSED AND ON ANY THEORY OF LIABILITY, WHETHER IN CONTRACT, STRICT LIABILITY, OR TORT (INCLUDING NEGLIGENCE OR OTHERWISE) ARISING IN ANY WAY OUT OF THE USE OF THIS SOFTWARE, EVEN IF ADVISED OF THE POSSIBILITY OF SUCH DAMAGE.

Quick Manual

How to use Quick Manual

Remove the Quick Manual attached to the end of this manual by cutting along the perforations and fold it as shown below. Carry the Quick Manual "Overseas Use" when the mobile phone is used with the International Roaming (WORLD WING) overseas.

■ Folding Quick Manual

- Be careful of injuries when cutting out the Quick Manual.

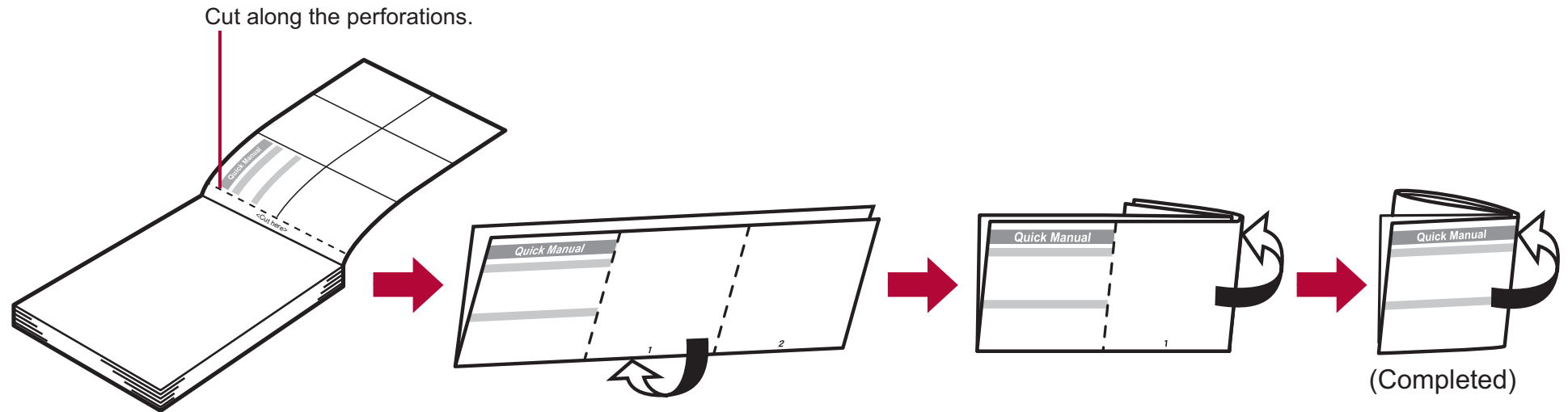

This manual is produced using recyclable material. Please recycle when no longer needed.

Quick Manual

Registration/Contacts

General Inquiries <docomo Information Center>

0120-005-250 (toll free)

- ※ Service available in: English, Portuguese, Chinese, Spanish, Korean.
- ※ Available from mobile phones and PHSs.
- For DOCOMO mobile phones (In Japanese only)

(No prefix) 151 (toll free)

- ※ Unavailable from fixed-line telephones, etc.
- For fixed-line telephones (In Japanese only)

0120-800-000 (toll free)

- ※ Available from mobile phones and PHSs.
- Please confirm the phone number before you dial.

If you have problems with your FOMA

For DOCOMO mobile phones (In Japanese only)

(No prefix) 113 (toll free)

- ※ Unavailable from fixed-line telephones, etc.
- For fixed-line telephones (In Japanese only)

0120-800-000 (toll free)

- ※ Available from mobile phones and PHSs.
- Please confirm the phone number before you dial.

Adding entries to phonebook (Phone)

- 1 In the Stand-by Display Touch Launcher, select [App] ▶ [Submenu] ▶ [New] ▶ [Phone].
- 2 Enter a name ▶ [OK] ▶ ▶ enter a phone number ▶ [OK] ▶ select a phone type icon ▶ ▶ enter a mail address ▶ [OK] ▶ select a mail address type icon ▶ [Complete] ▶ [OK] ▶ select Add to PushTalk PB.

Other save items

- : Group
- : Company/school
- : Department
- : Title
- : Postal code
- : Postal address
- : Location info
- : Birthday
- : Memo
- : Secret code
- : Select ring tone
- : Mail ring tone
- : Called LED color
- : Called LED pattern
- : Mail/Message LED color
- : Mail LED pattern
- : Picture call set
- : Substitute image

Adding entries to phonebook from Redials/Received calls

- 1 In the Stand-by Display Touch Launcher, select [Redial/Received] ▶ point the cursor to a phone number ▶ [Submenu] ▶ [Add to phonebook] ▶ [Save new to phone] ▶ add to the phonebook.

Editing phonebook entries

- 1 In the Stand-by Display Touch Launcher, select [App] ▶ point the cursor to a name ▶ [Submenu] ▶ [Edit data] ▶ [Edit] ▶ select an item ▶ edit.

Text input

Changing input mode

- 1 In the text input screen, select [Chara] ▶ select the input mode.

Switching upper/lower case

- 1 Enter a character ▶ [^A/a].

Deleting text

- 1 Point the cursor to the text and press .

Using phrases

- 1 In the text input screen, select [Submenu] ▶ [Phrase(Hold F4)] ▶ select a phrase ▶ [OK].

Entering pictographs/symbols

- 1 In the text input screen, select [Pict/Sym].
 - To enter symbols: Select [Symbol].
 - To enter pictographs: Select [Pict].
 - To switch between pictograph and Deco-mail pictograph: Select [Pict]/[Pict-D].
 - To switch between single- and double-byte symbols: Select [Fulpitch]/[Hlfpitch].

Entering emoticons

- 1 In the text input screen, select [Submenu] ▶ [Emoticon(Hold F3)] ▶ select an emoticon.

Cutting/Copying/Pasting text

Ex.) When entering a message

- 1 In the text input screen, select [Submenu] ▶ [Copy]/[Cut] ▶ move the cursor to the start position ▶ [Start].
- 2 Move the cursor to the end position ▶ [Copy]/[Cut].

- 3 Select [Submenu] ▶ [Paste].

- 4 Move the cursor to the paste position ▶ [Paste].

Text input example

Ex.) 今日のテニス3時

- 1 In the text input screen, select [か] (twice) ▶ [Conv] ▶ [今日].

- As each hiragana character is entered, conversion candidates appear and they can be selected.



- 2 Select [Conv] ▶ [の].
- 3 Select [た][な][さ] ▶ [1-tch] ▶ [テニス].
 - Select [1-tch] for One-touch conversion.
- 4 Select [Chara] ▶ [1] ▶ [3].

- Select [Chara] (five times) for single-byte alphanumeric mode.

5 Select [Chara] ▶ [あ] ▶ [さ] (twice) ▶ [°A/a] ▶ [Conv] ▶ [時].

- Select [°A/a] for dakuten mark.

6 Select [Pict/Sym] ▶ .



Changing font (font style)

1 In the Custom menu, select [Settings] ▶ [Disp/LED/Power saver] ▶ [Font style] ▶ [Font style setting] ▶ select the font.



Changing font size

1 In the Custom menu, select [Settings] ▶ [Disp/LED/Power saver] ▶ [Font style] ▶ [Font size] ▶ [Individual setting] ▶ select the [Input] field ▶ select the font size ▶ [Yes].



- To change collectively: In stand-by, press  (for 1+ seconds).

Camera



Shooting still pictures

1 In the Stand-by Display Touch Launcher, select  ▶  ▶ .

Shooting panoramic pictures

1 In the still picture shooting screen, select [Submenu] ▶ [Select size] ▶ [Panorama(2560×640)] ▶  ▶ move the FOMA terminal to either direction of left or right ▶  ▶ .

Shooting movies

1 In the still picture shooting screen, select [Submenu] ▶ [Switch camera-mode] ▶ [Movie] ▶  ▶  ▶ [Save].

Displaying still pictures

1 In the Custom menu, select [Data box] ▶ [My picture] ▶ select a still picture.

Playing back movies

1 In the Custom menu, select [Data box] ▶ [i-motion] ▶ select a movie.

Watching 1Seg

Performing Automatic channel setting

1 In the Custom menu, select [1Seg] ▶ [Channel setting].
2 Point the cursor to the save destination ▶ [Submenu] ▶ [Auto channel set] ▶ [Yes].

3 Select an area ▶ select a prefecture/district ▶ [OK] ▶ [Yes] ▶ [Yes].

Selecting a channel list

1 In the Custom menu, select [1Seg] ▶ [Channel setting] ▶ select a channel list.

Watching 1Seg

1 In the Custom menu, select [1Seg] ▶ [Activate 1Seg].

- To record a movie of 1Seg programs: While watching

1Seg, keep touching .

- To record 1Seg programs as a still picture: While

watching 1Seg, touch .

Watching videos







1 In the Custom menu, select [Data box] ▶ [1Seg] ▶ select a video.

Music playback

Using MUSIC Player

1 In the Custom menu, select [Data box] ▶ [MUSIC] ▶ select music data.

Operations for MUSIC Player

To pause/play	 or 
To stop	
To adjust the volume	 / 
To play previous song/return to the beginning of song	

To play next song	
To end MUSIC Player	 ▶ [Yes]

Mail

Composing and sending i-mode mail

1 In the Stand-by Display Touch Launcher, select  ▶ [Compose message] ▶ select the [To] field ▶ select the input method.

- ◆ Select [Search phonebook] ▶ select a recipient.
- ◆ Select [Sent messages] ▶ select a recipient.
- ◆ Select [Rcvd messages] ▶ select a recipient.
- ◆ Select [Mail members] ▶ select a mail member.
- ◆ Select [Direct input] ▶ enter an address ▶ [OK].

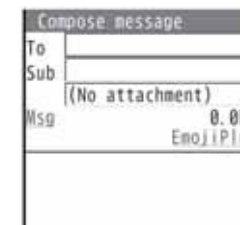

- 2 Select the [Sub] field ▶ enter a subject ▶ [OK] ▶ [Msg] ▶ enter the message text ▶ [OK] ▶ [Send].

Sending Deco-mail

- 1 In the text input screen, select [Submenu] ▶ [Decorate mail] ▶ select a decoration type ▶ specify decoration ▶ input text ▶ [OK] ▶ [Send].

Attaching a file

- 1 In the Stand-by Display Touch Launcher, select [✉] ▶ [Compose message] ▶ select the attachment field (No attachment) ▶ select the file to attach.
 - ◆ Select [Image] ▶ point the cursor to the image ▶ [OK].
 - ◆ Select [Melody] ▶ point the cursor to the melody ▶ [OK].
 - ◆ Select [i-motion] ▶ point the cursor to i-motion ▶ [OK].
 - ◆ Select [ToruCa] ▶ point the cursor to ToruCa ▶ [OK].
 - ◆ Select [PDF] ▶ point the cursor to the PDF ▶ [OK].

- ◆ Select [Phonebook] ▶ select a save destination ▶ select a name.
- ◆ Select [Schedule] ▶ select a save destination (▶ select a day)* ▶ select a schedule.
 - * No operation is needed if [microSD] is selected as the save destination
- ◆ Select [Bookmark] ▶ select a save destination ▶ select a bookmark.
- ◆ Select [Document] ▶ point the cursor to the file ▶ [OK].
- ◆ Select [Other] ▶ select a file.
- ◆ Select [Start cam (still)] ▶ [📷]/[📷] (P) ▶ [Save]/[📷] (P).
- ◆ Select [Start cam (movie)] ▶ [Rec]/[📷] (P) ▶ [Stop]/[📷] (P) ▶ [Save].

Composing and sending SMS

- 1 In the Stand-by Display Touch Launcher, select [✉] ▶ [Compose SMS] ▶ select the [To] field ▶ [Direct input] ▶ enter an address ▶ [OK] ▶ [Msg] ▶ enter the message ▶ [OK] ▶ [Send].

Receiving mail automatically

- 1 Mail is automatically received.
- 2 Select [Mail] ▶ select the mail.

Checking new i-mode mail

- 1 In the Stand-by Display Touch Launcher, select [✉] ▶ [Check new messages].
 - SMS: In the Stand-by Display Touch Launcher, select [✉] ▶ [Check new SMS].

Replying to i-mode mail

- 1 In the received message details screen, select [Submenu] ▶ [Reply/Forward].
- 2 Select the reply method.
- 3 Compose and send a mail.

Forwarding i-mode mail

- 1 In the received message details screen, select [Submenu] ▶ [Reply/Forward] ▶ [Forward].
- 2 Enter an address and send a mail.

Menu list

Retrieving functions from the Custom menu/Basic menu

- 1 In the Stand-by Display Touch Launcher, select [ⓘ].
- 2 In the Custom menu/Function menu, select the function.
- 3 In the Menu list, select the function.

Switching between the Custom menu/Basic menu

- 1 In the Custom menu/Basic menu, select [Basic]/[Custom].

Snd/Vibrator/Manner

Select volume	Received call volume, phone ring vol, Mail ring vol, PushTalk tone vol, Key/Touch sound, Standby i-motion, Charge start sound, Charge end sound, Timer sound, GPS volume
---------------	--

Snd/Vibrator/Manner

Select sound	Select ring tone, Select mail tone, PushTalk tone, Shutter sound, Timer sound, GPS tone
Vibrator	Vibration mode, Mail vibration, GPS vibrator, Touch vibrator
Manner mode	ON (Normal, Silent, Original), OFF
Headset setting	
Ring time setting	Mail ring time set, PT ring time set, GPS ring time set
Set mute ring time	
Hold/On hold tone	Set on hold tone, Set hold tone
Sound playback	Melody stereo fx, Melody equalizer, Pref playback sound

Disp/LED/Power saver

Set screen	Stand-by display, Clock display, Calendar display, Stand-by memo disp, Stdbych Inch disp, Desktop clock, Stdbych slide-link set
Font style	Font style setting, Font size
Themes	Kisekae Tool, Call/Rcv display, Send/Rcv display, Animate notices, Signal/batt/s clock, Machi-chara, Color theme setting
LED settings	Called LED, Mail LED, Notice LED, In-call LED, Alarm/Timer LED, IC card LED, Slide-linked LED, GPS LED
Display img quality	Vibrant image mode, Control by scene

Disp/LED/Power saver	
Light/Power saver	Norm (auto bright), Norm (fixed bright), Eco mode (Pwr saver), Original Eco mode
VeilView	Linked manner, Pattern, Pattern density
Menu priority	

-18-

General settings	
Check status	Owner Information, Check memory, Battery level, Check settings
Text input setting	User dictionary, Dwnld dictionary, Edit phrase, Clear memory terms
Auto power ON/OFF	Auto power ON, Auto power OFF, Link alarm/power ON
Date settings	
Select language	
USB mode setting	
Scanning function	Update, Set auto-update, Set scan, Version
Software update	
Reset settings	

-19-

NW Services	
Voice Mail	Check messages, Play Messages, Activate VoiceMail, Set ring time, Deactivate VoiceMail, Check setting, Voice Mail setting, Notification setting, Notification, V.phone Voice Mail
Call waiting	Activate, Deactivate, Check setting
Forwarding	Activate, Deactivate, Register number, If FWD number busy, Check setting
Nuis. call blocking	Register caller, Register selected No, Delete all entries, Delete last entry, Check No of entries

-20-

NW Services	
Notify caller ID	Check setting, Activate/Deactivate
Caller ID request	Activate, Deactivate, Check setting
Talk time/cost	
2in1 setting	Mode switching, Phonebook 2in1 set, Stand-by display, Set call/receive No., 2in1 function OFF, Receive avoidance
In-call arrival act	Set arrival act, Arrival Call Act

-21-

Other NW Services	
Remote Control	Activate, Deactivate, Check setting
Dual network	Switching, Check setting
English guidance	Guidance setting, Check setting
Service Numbers	ドコモ故障問合せ, ドコモ総合案内・受付
Additional service	USSD, Reply message
Multi number	Set multi number, Check setting, Number setting
Chaku-moji	Create message, Message display
Roaming guidance	Activate, Deactivate, Check setting

-22-

Phone settings	
In-call settings	Noise reduction, Reconnect signal, Quality alarm
Headset sw to call	
Incoming settings	Auto answer setting, Melody Call setting
Videophone set	Redial voice call, Set sending image, Display setting, Subscreen position, Visual preference, Notify switch mode, Hands-free V.phone, V-phone while packet
Record message	Record message, Answering duration, Reply message, V.phone reply image
Set PushTalk	Set PT arrival act, Hands-free PT
Setting when slid	
Self mode	
Other settings	Int'l prefix, Sub address, Int'l dial assist, International Roam., In-area status

-23-

<Cut here>

Security	
Secret mode	
UIM Settings	PIN1 code input set, Change PIN1 code, Change PIN2 code
Accept/Reject calls	Accept calls, Reject calls, Reject unknown, User unset, Reject payphone, Reject not support
Show call/received	Show rcvd calls, Show redial
Show sent/received	Show sent messages, Show rcvd messages
Lock settings	All lock, Keypad dial lock, Function lock, Multi lock set, IC card lock, Multi lock auto-set
Change security code	
Writing authentic	
Delete all data	Delete user data, Del secret data

i-concier settings	
Incoming settings	Select volume, Select sound, Vibrator, Ring time setting, LED setting
Information display	
Other settings	
Initial setting	
Own number	

Quick Settings	
VeliView	Bluetooth
Location	Public mode
RcvCall vol	Manner mode
Rec msg	Self mode
Alarm	Lock select
Vibrator	Eco mode

Stand-by Display Touch Launcher

	Quick search
	Full Browser (Google)
	Mapping appli
	i-concier
	Start menu
	i-mode menu
	1Seg
	i-Widget (longways)
	Program guide i-appli (sideways)

	Shoot still picture
	Mail menu
	Phonebook
	Dial input screen
	Received calls
	Redial
	Manner mode setting

Other functions

Activate Multi Assistant (Multitask)	(for 1+ seconds)
--------------------------------------	------------------

Network services

※ When the confirmation screen appears, select [Yes].

Voice Mail Service

Voice Mail Service is a paid option (monthly fees apply) that requires subscription.

1 In the Custom menu, select [Settings] ▶ [NW Services] ▶ [Voice Mail].

2 Select [Activate VoiceMail] ▶ [Activate VoiceMail].

- To deactivate: Select [Deactivate VoiceMail].
- To play messages: Select [Play Messages] ▶ [Play(voice call)]/[Play(videophone)].
- To check messages: Select [Check messages].

Call Waiting

Call Waiting is a paid option (monthly fees apply) that requires subscription.

1 In the Custom menu, select [Settings] ▶ [NW Services] ▶ [Call waiting].

2 Select [Activate].

- To deactivate: Select [Deactivate].
- To check settings: Select [Check setting].

Call Forwarding Service

Call Forwarding Service is a free option (no monthly fees) that requires subscription.

1 In the Custom menu, select [Settings] ▶ [NW Services] ▶ [Call Forwarding].

2 Select [Activate] ▶ [Activate].

- To deactivate: Select [Deactivate].
- To check settings: Select [Check setting].

Caller ID Request Service

Subscription is not required (no monthly fees).

1 In the Custom menu, select [Settings] ▶ [NW Services] ▶ [Caller ID request].

2 Select [Activate].

- To deactivate: Select [Deactivate].
- To check settings: Select [Check setting].

Icon list

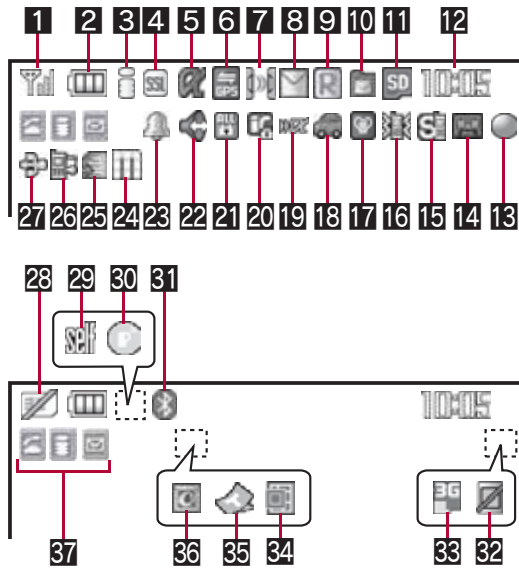

-30-

1		Signal status
2		Battery level
		Charging
3		i-mode/Full Browser
4		SSL
5		i-appli
6		GPS
7		Ir communication/Bluetooth communication/External device
8		i-mode mail/SMS/Area Mail received
9		Message R/F received
10		Storage status of i-mode center
11		microSD Card is inserted
		microSD Card is being used

-31-

12		Clock display
13		1Seg being recorded
14		Record message
15		Silent
16		Vibrator
17		Manner mode
18		Public mode (Drive mode)
19		i-appli call
20		IC card lock
21		Restriction indicator
22		Hands-free
		Mute in progress (only when in the open position)
		Bluetooth hands-free

-32-

23		Alarm
24		Music&Video Channel program reservation
25		i-mode mail send reservation
26		Earphone/Microphone connection
27		USB mode
28		FOMA card is malfunctioning or not inserted
		Non-FOMA card is inserted
29		Self mode
30		PushTalk
31		Bluetooth
32		VeilView

-33-

33		3G/GSM
34		Status of Comics setting
35		ToruCa
36		Receiving information
37		Multitask

※ Refer to P. 28 to P. 31 of the manual for detailed explanations of displayed icons.

-34-

<Emergency contacts in case of loss or other accidents>

Omakase Lock

※ Omakase Lock is a paid service. However, if Omakase Lock is subscribed while or at the same time as when the use of FOMA terminal is suspended, or if the user is a member of docomo Premier Club, the usage fee of Omakase Lock is not charged. Additionally, if Keitai Anshin Pack (Mobile Phone Security Package) is subscribed, Omakase Lock is available for a flat-rate.

Enable/Disable Omakase Lock

0120-524-360 Office hours: 24hours

Other contacts

<Contacts: >

<Contacts: >

<Contacts: >

※ Please confirm the phone number before you dial.

-35-

Quick Manual “Overseas Use”

**Loss or theft of FOMA terminal or payment of cumulative cost overseas
<docomo Information Center> (24-hour service)**

For DOCOMO mobile phones

International call access code of your country of stay (Table 1) -81-3-5366-3114* (toll free)

* Communication charges to Japan will apply when you make a call from a fixed-line telephone.

※ If you use the SH-04A, you should dial the number +81-3-5366-3114.

For fixed-line telephones

<Universal number>

International prefix number for the universal number (Table 2) -800-0120-0151*

* Communication charges or other charges to your country of stay will apply.

※ See P.19 to P.20 and P.21 to P.22 for international call access codes of major countries (Table1) and international prefix number for the universal number (Table2).

<Cut here>

Setting remote access

Setting in Japan

1 In the Custom menu, select [Settings] ▶ [Other NW Services] ▶ [Remote Control] ▶ [Activate] ▶ [Yes].

Setting in overseas

1 In the Custom menu, select [Settings] ▶ [Phone settings] ▶ [Other settings] ▶ [International Roam.] ▶ [Remote access (Int.)] ▶ [Yes] ▶ operate according to the voice guidance.

Correcting date and time automatically

1 In the Custom menu, select [Settings] ▶ [General settings] ▶ [Date settings] ▶ select the [Auto time correction] field ▶ [ON] ▶ [Complete].

**Failures encountered overseas
<Network Technical Operation Center>
(24-hour service)**

For DOCOMO mobile phones

International call access code of your country of stay (Table 1) -81-3-6718-1414* (toll free)

* Communication charges to Japan will apply when you make a call from a fixed-line telephone.

※ If you use the SH-04A, you should dial the number +81-3-6718-1414.

For fixed-line telephones

<Universal number>

International prefix number for the universal number (Table 2) -800-5931-8600*

* Communication charges or other charges to your country of stay will apply.

※ See P.19 to P.20 and P.21 to P.22 for international call access codes of major countries (Table1) and international prefix number for the universal number (Table2).

Setting time zone manually

- 1 In the Custom menu, select [Settings] ▶ [General settings] ▶ [Date settings] ▶ select the [Auto time correction] field ▶ [OFF].
- 2 Select [City] ▶ select a city ▶ [Complete].

Available network

3G network	Available
GSM network	Available
GPRS network	Available

Setting network communication system

1 In the Custom menu, select [Settings] ▶ [Phone settings] ▶ [Other settings] ▶ [International Roam.] ▶ [3G/GSM setting] ▶ select the communication method.

Preparing for overseas use

Refer to the following before using the FOMA terminal overseas.

- “Mobile Phone User’s Guide [International Services]”
- “Mobile Phone User’s Guide [Network Services]”
- PDF file “海外ご利用ガイド” pre-installed in [My Documents] of Data box

Setting i-mode

Setting in Japan

1 In the Stand-by Display Touch Launcher, select [iMenu] ▶ [English] ▶ [Options] ▶ [International Settings] ▶ [i-mode services Settings] ▶ [Yes] ▶ select the [Enter i-mode Password] field ▶ enter the i-mode password ▶ [OK] ▶ [OK].

Setting in overseas

1 In the Stand-by Display Touch Launcher, select [iMenu] ▶ [English] ▶ [International Settings] ▶ [i-mode services Settings] ▶ [Yes] ▶ select the [Enter i-mode Password] field ▶ enter the i-mode password ▶ [OK] ▶ [OK].

Available services overseas

Communication service	3G	GSM	GPRS
Voice call	○	○	○
Videophone	○	×	×
i-mode mail	○	×	○
i-mode	○	×	○
i-Channel	○	×	○
i-concier	○	×	○
i-Widget	○	×	○
SMS	○	○	○
Packet transmission by connecting a PC, etc.	○	×	○

- Unable to use 64K data communication by connecting a PC, etc. overseas.

Setting a search method of telecommunications carrier

Network search mode

Default setting: Auto (Automatically switches telecommunications carriers)

- 1 In the Custom menu, select [Settings] ▶ [Phone settings] ▶ [Other settings] ▶ [International Roam.] ▶ [Network search mode].
- 2 Select [Auto] ▶ [Yes].
 - To manually switch telecommunications carriers: Select [Manual] ▶ select a telecommunications carrier.
 - To re-search for the host network: Select [Network re-search].

-6-

Setting a telecommunications carrier to preferentially connect to

- 1 In the Custom menu, select [Settings] ▶ [Phone settings] ▶ [Other settings] ▶ [International Roam.] ▶ [Network search mode] ▶ [PLMN setting] ▶ point the cursor to the number of the priority order ▶ [Submenu].
- 2 Select [PLMN manual select] ▶ enter a country code (MCC) ▶ [OK] ▶ enter a network code (MNC) ▶ [OK] ▶ select a communication method ▶ [Yes].
 - To save from a telecommunications carrier list: Select [UPLMN by list] ▶ select a telecommunications carrier ▶ select a communication method ▶ [Yes].
 - To save the telecommunications carrier currently connected to: Select [Set VPLMN to PLMN] ▶ [Yes].
 - To change the priority: Select [Change priority] ▶ select a destination ▶ [Yes].

-7-

Displaying a telecommunications carrier name in stand-by

Telecommunications carrier name

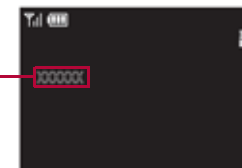

- 1 In the Custom menu, select [Settings] ▶ [Phone settings] ▶ [Other settings] ▶ [International Roam.] ▶ [Operator name disp] ▶ [Display on] ▶ [Yes].

-8-

Setting after homecoming

If Network search mode is set to [Auto], reset Network search mode to the FOMA network (DOCOMO) automatically when the power is turned on after homecoming.

- **Setting to FOMA network (DOCOMO) manually**
- 1 In the Custom menu, select [Settings] ▶ [Phone settings] ▶ [Other settings] ▶ [International Roam.] ▶ [Network search mode] ▶ [Manual] ▶ [DOCOMO].

-9-

Making a call

Making a call outside your country of stay (including Japan)

- **Using + to make an international call**

- 1 In stand-by, press [0] ▶ keep touching [0(+)] ▶ enter the country code, area code (city code) and other party's phone number ▶ [↵] or [Phone]/[V.phone].

- When the area code (city code) begins with 0, omit the 0 when dialing. However, include 0 when making a call to landline phones in some countries or regions such as Italy.

- **Making an international call outside your country of stay using country code conversion**

0 at the beginning of a phone number is automatically converted to the country code set in Country code conversion.

Example: Make a call from the phonebook

- 1 In the Stand-by Display Touch Launcher, select [Phone] ▶ select the other party ▶ [Phone] or [Phone]/[V.phone] ▶ [Call].

-10-

- **Making an international call**

Save a country number using Set country code to select a country code before making an international call.

The following operation is available overseas only.

- 1 In stand-by, press [0] ▶ enter a phone number ▶ [Submenu] ▶ [Add prefix setting] ▶ [International Call] ▶ select the country code ▶ [↵] or [Phone]/[V.phone].

Making a call in your country of stay

- 1 In stand-by, press [0] ▶ enter a phone number ▶ [↵] or [Phone]/[V.phone].

- **Making a call to the phone in your country of stay using phonebook**

- 1 In the Stand-by Display Touch Launcher, select [Phone] ▶ select the other party ▶ [Phone] or [Phone]/[V.phone] ▶ [Original number].

-11-

■ Making a call to a WORLD WING subscriber overseas

Even when making a call to the phone in your country of stay, make an international call to Japan if the call recipient is a "WORLD WING" subscriber overseas.

- 1 In stand-by, press **[M]** ▶ keep touching **[0(+)]** ▶ enter **81** ▶ enter the other party's mobile phone number excluding the first **0** ▶ **[↵]** or **[M]** (Phone)/**[V.phone]**.

Receiving calls

- 1 Press **[M]** to answer an incoming call.

■ Having calls made to your FOMA terminal from Japan

Enter the phone number in the same way as it is entered in Japan and make a call.

■ Having calls made to your FOMA terminal from countries other than Japan

Enter *international call access code of the country of the caller-81-user's phone number* excluding the first **0** and make a call.

Setting roaming guidance

Make this setting while still in Japan.

※ When the confirmation screen appears, select [Yes].

- 1 In the Custom menu, select **[Settings]** ▶ **[Other NW Services]** ▶ **[Roaming guidance]**.
- 2 Select **[Activate]**.
 - To deactivate: Select **[Deactivate]**.
 - To check settings: Select **[Check setting]**.

Call barring

● Depending on the overseas telecommunications carrier, the setting cannot be made.

- 1 In the Custom menu, select **[Settings]** ▶ **[Phone settings]** ▶ **[Other settings]** ▶ **[International Roam.]** ▶ **[Call barring]**.
- 2 Select **[Activate]** ▶ **[Yes]** ▶ select the barring method ▶ enter the network security code ▶ **[OK]**.
 - To deactivate: Select **[Deactivate]** ▶ **[Yes]** ▶ enter the network security code ▶ **[OK]**.
 - To check settings: Select **[Check setting]**.

Missed Call Notice

- 1 In the Custom menu, select **[Settings]** ▶ **[Phone settings]** ▶ **[Other settings]** ▶ **[International Roam.]** ▶ **[Missed Call Notice]**.
- 2 Select **[Activate]** ▶ **[Yes]**.
 - To deactivate: Select **[Deactivate]** ▶ **[Yes]**.
 - To check settings: Select **[Check setting]**.

Using network service

- Set in your country of stay.
- To use network service overseas, set Remote Control to "Activate".
- ※ When the confirmation screen appears, select [Yes].
- ※ Operate according to the voice guidance.

Voice Mail (Int.)

- 1 In the Custom menu, select **[Settings]** ▶ **[Phone settings]** ▶ **[Other settings]** ▶ **[International Roam.]** ▶ **[Voice Mail(Int.)]**.
- 2 Select **[Activate Voice Mail]**.
 - To deactivate: Select **[Deactivate]**.
 - To play messages: Select **[Play Messages]**.
 - To set the service: Select **[Voice Mail settings]**.

Call Forward (Int.)

- 1 In the Custom menu, select **[Settings]** ▶ **[Phone settings]** ▶ **[Other settings]** ▶ **[International Roam.]** ▶ **[Call Forward (Int.)]**.
- 2 Select **[Activate]**.
 - To deactivate: Select **[Deactivate]**.
 - To set the service: Select **[Settings]**.

Roaming guidance (Int.)

- 1 In the Custom menu, select **[Settings]** ▶ **[Phone settings]** ▶ **[Other settings]** ▶ **[International Roam.]** ▶ **[Roam. guidance(Int.)]**.

Missed Call Notice (Int.)

- 1 In the Custom menu, select **[Settings]** ▶ **[Phone settings]** ▶ **[Other settings]** ▶ **[International Roam.]** ▶ **[MissedCallNoticeInt.]**.

Country codes of major countries

The following shows "Country code" used when making international calls or setting International dial assist.

Country/Region	Code	Country/Region	Code
Australia	61	Hong Kong	852
Austria	43	Hungary	36
Belgium	32	India	91
Brazil	55	Indonesia	62
Canada	1	Italy	39
China	86	Japan	81
Czech	420	Macau	853
Egypt	20	Malaysia	60
Fiji	679	Maldives	960
Finland	358	Netherlands	31
France	33	New Caledonia	687
Germany	49	New Zealand	64
Greece	30	Norway	47

Country/Region	Code	Country/Region	Code
Peru	51	Tahiti (French Polynesia)	689
Philippines	63		
Russia	7	Taiwan	886
Singapore	65	Thailand	66
South Korea	82	Turkey	90
Spain	34	U.K.	44
Sweden	46	U.S.A.	1
Switzerland	41	Vietnam	84

※ For other country codes and details, refer to the DOCOMO “International Services website”.

-18-

International call access codes of major countries (Table 1)

The following shows the International call access codes of major countries.

Country/Region	Code	Country/Region	Code
Australia	0011	Hungary	00
Belgium	00	India	00
Brazil	0021/ 0014	Indonesia	001
		Ireland	00
Canada	011	Italy	00
China	00	Luxemburg	00
Czech	00	Macau	00
Denmark	00	Malaysia	00
Finland	00	Monaco	00
France	00	Netherlands	00
Germany	00	New Zealand	00
Greece	00	Norway	00
Hong Kong	001	Philippines	00

-19-

Country/Region	Code	Country/Region	Code
Poland	00	Taiwan	002
Portugal	00	Thailand	001
Russia	810	Turkey	00
Singapore	001	U.A.E.	00
South Korea	001	U.K.	00
Spain	00	U.S.A.	011
Sweden	00	Vietnam	00
Switzerland	00		

-20-

International prefix number for the universal number (Table 2)

The following shows the International prefix number for the universal number of each country.

Country/Region	Code	Country/Region	Code
Argentina	00	Hong Kong	001
Australia	0011	Hungary	00
Austria	00	Ireland	00
Belgium	00	Israel	014
Brazil	0021	Italy	00
Bulgaria	00	Luxemburg	00
Canada	011	Malaysia	00
China	00	Netherlands	00
Columbia	009	New Zealand	00
Denmark	00	Norway	00
Finland	990	Peru	00
France	00	Philippines	00
Germany	00	Portugal	00

-21-

Country/Region	Code	Country/Region	Code
Singapore	001	Switzerland	00
South Africa	09	Taiwan	00
South Korea	001	Thailand	001
Spain	00	U.K.	00
Sweden	00	U.S.A.	011

-22-

About inquiries overseas

For lost, stolen, and cost settlement, or malfunction of the FOMA terminal overseas, refer to “Loss or theft of FOMA terminal or payment of cumulative cost overseas” on the cover of Quick Manual “Overseas Use” or “Failures encountered overseas” on P.1.

- Add the “International call access code (Table 1)” or “International prefix number for the universal number (Table 2)” that is assigned to your country of stay, to the head of your phone number for inquiries.

-23-

Check/change the subscription, apply for various services, and request various information materials online.

From i-mode

iMenu ▶ お客様サポート (User Support) ▶ お申込・お手続き (Applications/Procedures) ▶ 各種お申込・お手続き (Various Applications/Procedures)
Packet communication charges free

From a PC

My docomo (<http://www.mydocomo.com/>) ▶ 各種お申込・お手続き (Various Applications/Procedures)

- ※ You will need your "Network Security Code" to access the site from i-mode.
- ※ No packet communication charges are incurred when accessing the site from i-mode. Accessing from overseas will incur charges.
- ※ You will need your "docomo ID/Password" to access the site from PC.
- ※ If you do not have or you have forgotten your "Network Security Code" or "docomo ID/Password", contact the number listed in General Inquiries on the back of this manual.
- ※ The site may not be available depending upon the content of your subscription.
- ※ You may not be able to access some site services due to system maintenance, etc.

Please follow proper etiquette

When using your FOMA terminal, please be considerate of those around you.

Turn off your FOMA terminal in the following places

■ When in an area where use is prohibited

There are places where the use of mobile phones is prohibited. Be sure to turn off your FOMA terminal in the following places.

★On an aircraft ★In a hospital

- ※ There are people outside hospital wards who also use electric medical equipment. Please make sure that your FOMA terminal is turned off in the lobby and waiting room.

■ While driving

Using a mobile phone in hand while driving is regarded as a punishable act.

- ※ If there is no choice but to receive a call, use Hands-free and tell the caller that you will "call back", and then pull over to a safe place to make a call.

■ When in crowded places such as rush-hour trains in case somebody nearby is using an implanted cardiac pacemaker or implanted cardioverter-defibrillator

Your FOMA terminal may affect the operation of such equipment.

■ When in public places such as theaters, movie theaters, or museums

Use of your FOMA terminal in quiet public places will annoy others.

Be careful of where you use your FOMA terminal and the volume of your voice and the ring tone

- When using your FOMA terminal in a restaurant or a hotel lobby, lower your voice.
- In crowded places, be careful not to obstruct other pedestrians.

Be considerate of the privacy of the individuals around you



Please be considerate of the privacy of individuals around you when taking and sending images using a camera-enabled mobile phones.

The following functions will help you to keep your manners in public

There are useful functions you can use to set your FOMA terminal not to answer incoming calls, and to silence all sounds.

● Manner mode (☎ P. 98)/Original manner mode (☎ P. 99)

Silences the Key/Touch sound and all the sounds from the FOMA terminal, and Record message is set (Manner mode). When in the Manner mode, automatically set functions (Record message, Vibrator, Mic sensitivity up, Ring tone, Mail ring tone, alarm tone, Key/Touch sound and Low battery alarm) can be set to ON (enable)/OFF (disable) (Original manner mode).

● Public mode (Drive mode/Power OFF) (☎ P. 67, P. 68)

The caller hears a guidance message stating that the receiver is driving, or in the place where the receiver should refrain from using the mobile phone or turn off the power. The call is disconnected.

● Vibration mode (☎ P. 97)

Notifies incoming calls by vibration.

● Record message (☎ P. 68)

When you are unable to take a call, the Record message function records the caller's message.

- ※ You can also use optional services such as Voice Mail Service (☎ P. 414) and Call Forwarding Service (☎ P. 417).