



General Inquiries
<docomo Information Center>

(Business hours: 9:00 a.m. to 8:00 p.m.)

☎ 0120-005-250 (toll free)

※ Service available in: English, Portuguese, Chinese, Spanish, Korean.
 ※ Unavailable from part of IP phones.

(Business hours: 9:00 a.m. to 8:00 p.m. (open all year round))

■ From DOCOMO mobile phones ■ From land-line phones
 (In Japanese only) (In Japanese only)

☎ (No prefix) 151 (toll free) **☎ 0120-800-000** (toll free)

※ Unavailable from land-line phones, etc. ※ Unavailable from part of IP phones.

● Please confirm the phone number before you dial.

● For Applications or Repairs and After-Sales Service, please contact the above-mentioned information center or the docomo Shop etc. near you on the NTT DOCOMO website.

NTT DOCOMO website <http://www.nttdocomo.co.jp/english/>

Repairs

(Business hours: 24 hours (open all year round))

■ From DOCOMO mobile phones ■ From land-line phones
 (In Japanese only) (In Japanese only)

☎ (No prefix) 113 (toll free) **☎ 0120-800-000** (toll free)

※ Unavailable from land-line phones, etc. ※ Unavailable from part of IP phones.

Loss or theft of handset or payment of cumulative cost overseas
<docomo Information Center>

(available 24 hours a day)

From DOCOMO mobile phones

International call access code for the country you stay **-81-3-6832-6600*** (toll free)

* You are charged a call fee to Japan when calling from a land-line phone, etc.
 ※ If you use SH-90D, you should dial the number +81-3-6832-6600 (to enter "+", touch "0" for a while).

From land-line phones

<Universal number>

Universal number international prefix **-8000120-0151***

* You might be charged a domestic call fee according to the call rate for the country you stay.

※ For international call access codes for major countries and universal number international prefix, refer to DOCOMO International Services website.

Failures encountered overseas
<Network Support and Operation Center>

(available 24 hours a day)

From DOCOMO mobile phones

International call access code for the country you stay **-81-3-6718-1414*** (toll free)

* You are charged a call fee to Japan when calling from a land-line phone, etc.
 ※ If you use SH-06D, you should dial the number +81-3-6718-1414 (to enter "+", touch "0" for a while).

From land-line phones

<Universal number>

Universal number international prefix **-8005931-8600***

* You might be charged a domestic call fee according to the call rate for the country you stay.

※ For international call access codes for major countries and universal number international prefix, refer to DOCOMO International Services website.

- If you lose your handset or have it stolen, immediately take the steps necessary for suspending the use of the handset.
- If the handset you purchased is damaged, bring your handset to a repair counter specified by DOCOMO after returning to Japan.

Don't forget your mobile phone... or your manners!

When using your mobile phone in a public place, don't forget to show common courtesy and consideration for others around you.

Sales: NTT DOCOMO, INC.
 Manufacturer: SHARP Corporation

To prevent damage to the environment, bring used battery packs to a docomo service counter, a docomo agent or a recycle center.



AQUOS PHONE ZETA
SH-09D

取扱説明書 '12.●







docomo **NEXT** series

Precautions (ALWAYS FOLLOW THESE DIRECTIONS)

- Before use, read these “Precautions” carefully and use your handset properly. Keep this manual in a safe place for future reference.
 - These precautions contain information intended to prevent bodily injury to the user and to surrounding people, as well as damage to property, and must be observed at all times.
- The following symbols indicate the different degrees of injury or damage that may occur if information provided is not observed and the handset is used improperly.

 Danger	This symbol indicates that “death or serious bodily injury may directly and immediately result from improper use”.
 Warning	This symbol indicates that “death or serious bodily injury may result from improper use”.
 Caution	This symbol indicates that “minor injury and/or property damage may result from improper use”.

The following symbols indicate specific directions.

 Don't	Indicates a prohibited action.
 No disassembly	Indicates not to disassemble the device.
 No wet hands	Indicates not to handle the device with wet hands.
 No liquids	Indicates not to use the device near water or get it wet.
 Instruction	Indicates that instructions specified are compulsory (must be followed).
 Unplug	Indicates that the power cord must be unplugged from the outlet.

Handling the handset, battery pack, adapters (including charger micro USB adapter), desktop holder and docomo mini UIM card (general)

Danger



Don't

Do not use, store or leave the equipment in locations subject to high temperatures, such as near a fire, in direct sunlight or inside a vehicle on a hot day.

May cause fires, burns or bodily injury.



Don't

Do not place the equipment inside cooking appliances such as microwave ovens or pressure cookers.

May cause fires, burns, bodily injury or electric shock.



Do not attempt to disassemble or modify the equipment.

No disassembly

May cause fires, burns, bodily injury or electric shock.



Do not get the equipment wet with water, drinking water, pet urine, etc.

No liquids

May cause fires, burns, bodily injury or electric shock.

Refer to the following for details on waterproofness.



Instruction

Use only the battery packs and adapters (including charger micro USB adapter) specified by NTT DOCOMO for use with the handset.

May cause fires, burns, bodily injury or electric shock.

Warning



Don't

Do not subject the equipment to strong force or impacts or throw it.

May cause fires, burns, bodily injury or electric shock.



Don't

Do not allow conductive materials (such as metal objects and pencil lead) to come into contact with the charger terminal, external connector terminal or earphone/microphone terminal. In addition, do not insert such objects.

May cause fires, burns, bodily injury or electric shock.



Don't

Do not cover or wrap the equipment with bedding, etc. when using or charging.

May cause fires or burns.



Instruction

Be sure to turn off the handset and not to charge the battery in locations such as gas stations where flammable gas is generated.

May cause a gas explosion or fire.

To use Osaifu-Keitai in locations such as gas stations, be sure to turn off the power in advance (If the Osaifu-Keitai lock setting is activated, disable the lock before turning off the power).



Instruction

If you notice anything unusual, such as an unusual odor, overheating, discoloration or deformation during use, charging or storage, immediately follow the instructions below.

- **Unplug the power cord from the outlet or cigarette lighter socket.**
- **Turn off the handset.**
- **Remove the battery pack from the handset.**

May cause fires, burns, bodily injury or electric shock.

Caution



Don't

Do not leave the equipment on unstable surfaces, such as on a wobbly table or sloped surface.

May fall and cause injury.



Don't

Do not store the equipment in locations that are subject to humidity, dust or high temperatures.

May cause fires, burns or electric shock.



Instruction

If being used by a child, have a guardian teach him/her the proper handling procedures. In addition, check that the child is using the equipment as directed.

May result in bodily injury.



Instruction

Keep the equipment out of the reach of young children.

A young child may swallow the equipment or suffer other bodily injury.



Instruction

Be very careful when using the handset connected to adapters (including charger micro USB adapter) repeatedly or for long periods of time.

The handset, battery pack or adapters (including charger micro USB adapter) may become warm if 1Seg etc. is used for a long time while charging. Touching high temperature areas for a prolonged period of time may cause skin irritations, itchiness or low-temperature burns in some people.

Handling the handset



Warning



Don't

Do not aim the infrared port towards the eyes.

May cause eye injury.



Don't

Do not aim the infrared port towards home electric appliances with an infrared device during infrared communication.

May interfere with the operation of infrared devices and cause an accident.

Do not point the illuminated light directly at someone's eyes. Especially when you shoot still pictures or moving pictures of young children, keep 1 m or more distance from them.

Do not use Mobile light near people's faces. Eyesight may be temporarily affected leading to accidents.

EN60625-1:1994 A1:2002 & A2:2001



Mobile light

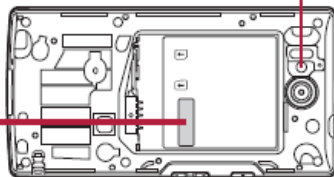

CAUTION-CLASS 1M
LED RADIATION WHEN OPEN
DO NOT VIEW DIRECTLY WITH
OPTICAL INSTRUMENTS

CAUTION:

Use of controls, adjustments or performance of procedure other than those specified herein may result in hazardous radiation exposure. As the emission level from Mobile light LED used in this product is harmful to the eyes, do not attempt to disassemble the cabinet. Servicing is limited to qualified servicing station only.

Mobile light source LED characteristics

- a) Continuous illumination
- b) Wavelength
 - White: 400-700 nm
 - Red: 600-670 nm
- c) Maximum output
 - White: 249 μ W (inside handset 1.21 mW)
 - Red: 41 μ W (inside handset 884 μ W)



Do not allow water or other liquids, metal, flammable material or other foreign objects to enter the docomo mini UIM card or microSD Card slot on the handset.

May cause fires, burns, bodily injury or electric shock.



Don't

Do not shine the light at anyone driving a car or other vehicles.

May prevent a driver from driving safely and cause a traffic accident.



Instruction

Turn off the handset in areas where the use of mobile phones is prohibited, such as in aircraft or hospitals.

May interfere with the operation of electronic devices and electronic medical equipment.

Follow the instructions given by the respective medical facilities regarding the use of mobile phones on their premises.

Actions such as using a mobile phone aboard aircraft are prohibited and punishable by law.

However, follow the instructions on use of the handset given by the airline if the handset can be used aboard aircraft by setting the handset such as setting it not to emit radio wave.



Instruction

Keep the handset away from the ears during a call in which hands-free is set or while the ring tone is ringing. When you attach the earphone/microphone, etc. to the handset to play games, music, etc., do not make the volume too loud.

Excessive high volume may damage your hearing.

Also, it may prevent you from hearing ambient sounds and cause an accident.

Earphone Signal Level

The maximum output voltage for the music player function, measured in accordance with EN 50332-2, is 50 mV.



Instruction

If you have a weak heart, take extra precautions when setting functions such as the vibrator and ring tone volume for incoming calls.

May have harmful effects on your heart.



Instruction

If you are using electronic medical equipment, contact the respective manufacturer or dealer to check whether the operation of the equipment is affected by signals.

May interfere with the operation of electronic medical equipment, etc.



Instruction

Turn off the handset near high-precision electronic devices or devices that use weak electronic signals.

May interfere with the operation of electronic devices.

Take particular care with the following devices

Hearing aids, implanted cardiac pacemakers, implanted cardioverter-defibrillators or other electronic medical equipment. Fire alarms, automatic doors, and other equipment controlled by electronic signals. If you use an implanted cardiac pacemaker, implanted cardioverter-defibrillator or other electronic medical equipment, contact the respective manufacturer or dealer to check whether the operation of the equipment is affected by signals.



Instruction

If the display part or camera lens is damaged, be careful of broken glass and the exposed inside of the handset.

The surface of the display is covered by a protective film while the surface of the camera lens is covered by a plastic panel so as to minimize the possibility of glass scattering. However, touching the broken or exposed parts may cause injury.

Caution



Don't

Do not swing the handset by its antenna, strap, etc.

May hit you or others around you, resulting in bodily injury.



Don't

Do not use a damaged handset.

May cause fires, burns, bodily injury or electric shock.



Don't

For using a motion sensor and geomagnetic sensor, check the safety around, hold the handset and do not swing them more than necessary.

May cause injury etc.



Don't

If the display is broken and the liquid crystal then leaks, do not get the liquid on your skin (face, hands, etc.).

May result in loss of eyesight and harm to your skin.

If the liquid comes into contact with your eyes or mouth, immediately rinse your eyes or mouth with clean water and see a doctor.

If the liquid comes into contact with your skin or clothes, immediately wipe it off with alcohol, and wash with water and soap.



Don't

The surface of the display is covered with a protective film for ensuring the security against any damages caused by the handset being dropped or receiving a strong impact etc. Do not remove the film forcibly or damage it.

Using the equipment with the film removed may damage the display and cause bodily injury.



Instruction

If you use the handset in a vehicle, contact the vehicle manufacturer or dealer to check whether the operation of the vehicle is affected by signals.

May interfere with the operation of electronic equipment in some vehicle models. In such cases, stop using the handset.



Instruction

Use of the handset may cause skin irritations such as itchiness, rashes or eczema in some people. If this occurs, immediately stop using the handset and seek medical treatment.



Instruction

Look at the display in a well-lit place, keeping a certain distance from the screen.

Otherwise, eyesight may be weakened.

Handling battery pack

Check the type of battery using the information printed on the battery pack label.

Label	Battery type
Li-ion00	Lithium-ion



Danger



Don't

Do not touch terminals with metallic objects such as wires. In addition, do not carry or store the battery pack with metallic necklaces, etc.

The battery pack may catch fire, explode, overheat or leak.



Don't

Check that the battery pack is facing the correct direction before you attach it to the handset. If you are having difficulty fitting the battery pack to the handset, do not use excessive pressure to force the battery into place.

The battery pack may catch fire, explode, overheat or leak.



Don't

Do not throw the battery pack into a fire.

The battery pack may catch fire, explode, overheat or leak.



Don't

Do not puncture, hit with a hammer or step on the battery pack.

The battery pack may catch fire, explode, overheat or leak.



Instruction

If the battery fluid, etc. comes into contact with your eyes, do not rub your eyes but immediately rinse your eyes with clean water. Then seek prompt medical treatment.

May result in loss of eyesight.



Warning



Don't

If any trouble such as a deformation or scratches caused by dropping the battery pack is found, never use it.

The battery pack may catch fire, explode, overheat or leak.



Instruction

If the battery pack leaks or emits an unusual odor, immediately stop using it and move it away from any naked flames or fire.

The battery fluid is flammable and could ignite, causing a fire or explosion.



Instruction

Do not allow a pet to bite the battery pack.

The battery pack may catch fire, explode, overheat or leak.

Caution



Do not dispose of used battery packs in ordinary garbage.

Don't

May cause fires or damage to the environment. Place tape over the terminals to insulate unnecessary battery packs, and take them to a docomo Shop, retailer or institution that handles used batteries in your area.



Do not use or charge a wet battery pack.

Don't

The battery pack may catch fire, explode, overheat or leak.



If the battery fluid, etc. leaks, do not get the liquid on your skin (face, hands, etc.).

Instruction

May result in loss of eyesight and harm to your skin.

If the liquid comes into contact with your eyes, mouth, skin or clothes, immediately rinse them with clean water.

If the liquid, etc. comes into contact with your eyes or mouth, see a doctor immediately after rinsing your eyes or mouth.

Handling adapters (including charger micro USB adapter) and desktop holder

Warning



Do not use if the cord of the adapter (including charger micro USB adapter) is damaged.

Don't

May cause fires, burns or electric shock.



Never use the AC adapter or the desktop holder in humid locations such as a bathroom.

Don't

May cause fires, burns or electric shock.



The DC adapter should only be used in negative grounded vehicles. Never use it in positive grounded vehicles.

Don't

May cause fires, burns or electric shock.



Do not touch adapters (including charger micro USB adapter) if you hear thunder.

Don't

May cause electric shock.



Take care not to short-circuit the charger terminal when connected to an outlet or cigarette lighter socket. Also, take care not to allow any part of your body (hands, fingers, etc.) to come into contact with the charger terminal.

Don't

May cause fires, burns or electric shock.



Do not place heavy objects on the cord of the adapter (including charger micro USB adapter).

Don't

May cause fires, burns or electric shock.



When plugging/unplugging the AC adapter into/from the outlet, do not allow metallic straps or other metallic objects to come into contact with the prongs of the plug.

Don't

May cause fires, burns or electric shock.



Do not handle the cord of the adapters (including charger micro USB adapter), the desktop holder or the outlet with wet hands.

No wet hands

May cause fires, burns or electric shock.



Always use the specified power supply and voltage.

Instruction

When using overseas, use the AC adapter that is available overseas.

Using the incorrect voltage may cause fire, burns or electric shock.

AC adapter: 100V AC

DC adapter: 12/24V DC (for negative grounded vehicles only)

AC adapter available overseas: 100 to 240V AC
(Connect only with a household AC outlet)



If the fuse in the DC adapter blows, always replace it with a fuse of the specified type.

Instruction

May cause fires, burns or electric shock. Refer to the respective manuals for information on the correct fuse specifications.



Wipe off any dust on the power plug.

Instruction

May cause fires, burns or electric shock.



Fully plug the AC adapter into the outlet.

Instruction

May cause fires, burns or electric shock.



Always grasp the adapters when unplugging the power plug from the outlet or cigarette lighter socket. Do not forcibly pull by the cord of the adapter (including charger micro USB adapter).

Instruction

May cause fires, burns or electric shock.



Unplug

Unplug the power plug from the outlet or cigarette lighter socket when not using for a long time.

May cause fires, burns or electric shock.



Unplug

Should water or other liquids enter the equipment, remove the power plug from the outlet or cigarette lighter socket immediately.

May cause fires, burns or electric shock.



Unplug

Always unplug the power plug from the outlet or cigarette lighter socket before cleaning the equipment.

May cause fires, burns or electric shock.

Notes on using Bluetooth function

- The handset supports the security function that meets the Bluetooth specification for security during communication using Bluetooth functions. However, the security may not be sufficient depending on the configuration. Take care of the security while making communication using Bluetooth function.
- Even if any leak of data or information occurs while making communication using Bluetooth function, DOCOMO shall not be liable for any loss of content.
- The handset can use headset, hands-free, audio, keyboard, object push, serial port and phone book access. Also, audio/video remote-control may be available depending on the audio (only with compatible Bluetooth devices).
- Radio frequencies
The radio frequencies the Bluetooth function of the handset uses are as follows.



- ① 2.4: This radio equipment uses the 2.4 GHz band.
- ② FH: The modulation system is the FH-SS system.
- ③ 1: The estimated coverage distance is 10 m or less.

- ④ ■■■ : All radio frequencies between 2400 MHz and 2483.5 MHz are used and the frequencies for mobile object identifiers shall not be avoided.

- **Cautions on using Bluetooth devices**
Bluetooth operates at radio frequencies assigned to the in-house radio stations for a mobile object identifier that have to be licensed and is used in production lines of a factory, specific unlicensed low power radio stations, and amateur radio stations (hereafter, referred to “another radio station”) in addition to industrial, scientific, medical devices or home electric appliances such as microwave ovens.
 1. Before using the handset, make sure that “another radio station” is not operating nearby.
 2. If radio interference between the handset and “another radio station” occurs, avoid interference by moving immediately to another place or “turning off the power”.
 3. Contact the number listed in “General Inquiries” on the back of this manual for further details.

Notes about wireless LAN (WLAN)

- Wireless LAN (WLAN) uses radio waves to communicate information. Therefore, it has an advantage of freely connecting to the LAN within the service area. On the other hand, if security setting is not set, it is possible for a malicious third party to intercept the communication contents or hack. It is recommended to set security setting at your own risk and judgement.

● Wireless LAN

Do not use wireless LAN near magnetic devices such as electric appliances or AV/OA devices or in radio waves.

- Magnetism or radio waves may increase noises or disable communications (especially when using a microwave oven).
- When used near TV, radio, etc., reception interference may occur or channels on the TV screen may be disturbed.
- If there are multiple wireless LAN access points nearby and the same channel is used, search may not work correctly.

● Radio frequencies

The radio frequencies the WLAN-installed devices use are indicated on the battery storage section of the main body of the handset. The following are the descriptions:

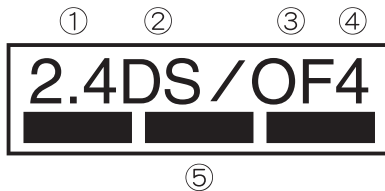

- ① 2.4: This radio equipment uses the 2400 MHz band.
- ② DS: The modulation system is the DS-SS system.
- ③ OF: The modulation system is the OFDM system.
- ④ 4: The estimated coverage distance is 40 m or less.
- ⑤ ■■■■■ ■■■■■ ■■■■■ : All radio frequencies between 2400 MHz and 2483.5 MHz are used and the frequencies for mobile object identifiers shall not be avoided.

Available channels for the handset's wireless LAN are between 1 to 13. Note that other channel access points cannot be connected.

Available channels vary depending on the country. For use in an aircraft, contact the airline beforehand.

There are restrictions on the use of wireless LAN in some countries or regions such as France. If you intend to use wireless LAN overseas, check the local laws and regulations beforehand.

- **Cautions on using 2.4 GHz devices**
WLAN-installed devices operate at radio frequencies assigned to the in-house radio stations for a mobile object identifier (radio stations requiring a license) used in production lines of a factory, specific unlicensed low power radio stations (radio stations requiring no license), and amateur radio stations (radio stations requiring a license) in addition to industrial, scientific, medical devices or home electric appliances such as microwave ovens.

1. Before using this device, make sure that the in-house radio stations for a mobile object identifier, specific unlicensed low power radio stations and amateur radio stations are not operating nearby.
2. If the device causes harmful radio interference to the in-house radio stations for a mobile object identifier, immediately change the radio frequency or stop use, and contact the number listed in "General Inquiries" on the back of this manual for crosstalk avoidance, etc. (e.g. partition setup).
3. If the device causes radio interference to specific unlicensed low power radio stations for a mobile object identifier or amateur radio stations, contact the number listed in "General Inquiries" on the back of this manual for further details.

FeliCa reader/writer

- **The FeliCa reader/writer function in the handset uses weak electric waves in the handling of which does not require a license of radio station.**
- **The frequency in use is the 13.56 MHz band. When another reader/writer is being used nearby, keep enough distance from it. Make sure that there is no radio station using the same frequency band in the nearby area.**

Caution

- **Never use the handset that is modified. Using a modified device violates the Radio Law.**

The handset has acquired the certification of conformity with technical regulations for the specified radio station based on the Radio Law, and the “Technical Conformity Mark ” is printed on the model nameplate of the handset as a proof. If the screws of handset are removed and a modification is given to the inside, the certification of conformity with technical regulations will become invalid. Never use the handset without the valid certification. Doing so violates the Radio Law.
- **Be careful when using the handset while driving a motor vehicle.**

Using a mobile phone in hand while driving is regarded as a punishable act. However, the punishment has no application in some cases such as when rescuing sick and injured people or maintaining public safety.
- **Use the FeliCa reader/writer function only in Japan.**

The FeliCa reader/writer function in the handset conforms to the domestic radio wave standards. Using the function overseas may result in punishment.

- **Never change the basic software improperly.**

This may be regarded as a conversion of software and repairs may be refused.
- **Be careful not to connect the handset to PC using the microUSB cable for PC (sample) in areas where the use of mobile phones is prohibited.**

Power may turn on automatically.

■ Removing back cover

- 1 Securely hold the surrounding section of camera, put fingers on the center of the back cover and hook the tip of a finger under the concave portion of the back cover to remove

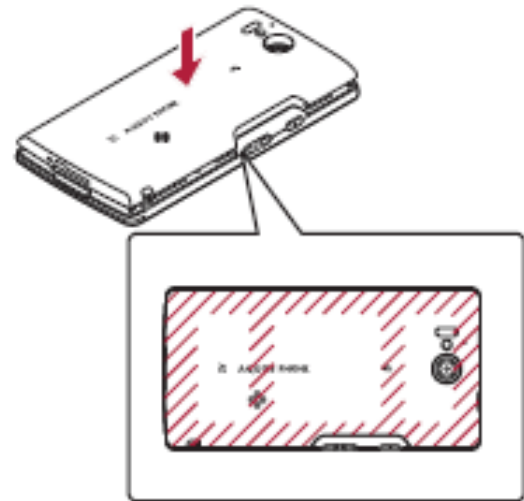
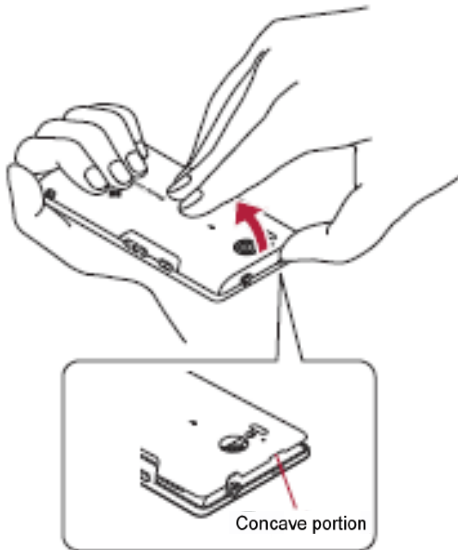

- Securely close the back cover. If not closed securely, the back cover may come off and the battery pack may fall out due to vibration. May damage the waterproof/dust-proof performance and allow water to seep or dust to get in.
- The back cover may be damaged if it is inserted or removed forcibly. Be careful not to apply excessive force on it.

■ Attaching back cover

- 1 Confirm the direction of the back cover, adjust it to the direction of the handset and press the surrounding section (shaded section) of the back cover securely to attach

- Make sure there is no space between the back cover and the handset.

- To maintain waterproof/dust-proof performance, replacement of parts is required every 2 years regardless of whether the handset appears normal or abnormal. DOCOMO replaces the parts as a chargeable service. Bring the handset to a repair center that DOCOMO specifies.

Battery pack

- Use the Battery Pack SH37 exclusive to the handset.
- For attaching or removing the battery pack, turn off the power, position the back facing upwards, and hold the handset securely with your both hands.

■ Attaching battery pack

1 Remove the back cover

2 Attach the battery pack

- With the recycle mark side turned up, place the connector terminal of the handset to that of the battery pack and attach the battery pack.

Connector terminal

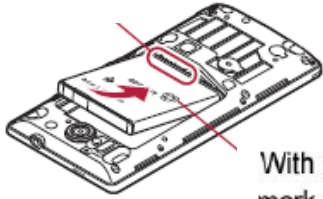

With recycle
mark side up

3 Attach the back cover

Removing battery pack

1 Remove the back cover

2 Remove the battery pack

- The battery pack has a tab that makes it easy to remove. Hook a finger on the tab to prevent excessive force on it and remove the battery pack upward.

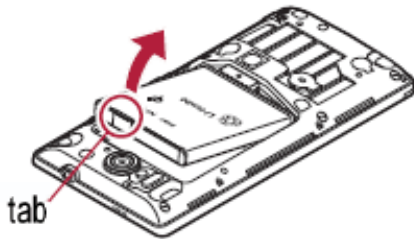

3 Attach the back cover

- Using unnecessary force when attaching or removing the battery pack may damage the connector terminal for the battery pack (charger terminal) on the handset.

Charging

The battery pack is not fully charged at the time of purchase. Be sure to charge the battery before use.

- It is recommended that the accompanying desktop holder be used for charging to prevent water from seeping or dust from getting in caused by forgetting to close the external connector terminal cover
- The accompanying FOMA charger micro USB adapter SH01/FOMA charging micro USB adapter T01 (sold separately) is required to charge with the AC adapter (sold separately) or DC adapter (sold separately).

Cautions while charging

- Do not charge for a long time with the power left on. If the handset is left on after charging is complete, the battery pack charge decreases. In that case, the AC or DC adapter charges the battery again. However, depending on the time when the handset is disconnected from the AC or DC adapter, the battery charge level may be low or the battery may only be usable for a short time.
- If the handset is left for a long time even after the charging is completed, the battery level may decrease.
- When the battery is empty and the handset is being charged, charging lamp may not illuminate immediately. However, charging is in progress.
- If the battery empty alert is displayed and the power cannot be turned on, charge the battery for a while.

- While charging, the handset may not turn on even when charging lamp is illuminated in red. Charge longer and try turning power on again.
- Frequently recharging the battery when its power is still remaining enough may shorten the life of the battery pack. It is recommended to use the battery to a certain level before recharging.

■ AC adapter and DC adapter

- Refer to user's guide of FOMA AC Adapter 01/02 (sold separately), AC Adapter 03(sold separately), DC Adapter 03(sold separately) or FOMA DC Adapter 01/02(sold separately).
- FOMA AC Adapter 01 covers only 100V AC. FOMA AC Adapter 02/ AC Adapter 03 from 100 to 240V AC.
- The shape of the plug for the AC adapter is for 100V AC (for domestic use). To use the AC adapter of 100 to 240V AC overseas, a conversion plug adapter that is compatible with the voltage of your country of stay is required. Do not use a voltage converter for overseas travel to charge the battery.

Charging with AC adapter/DC adapter

[Read the user's guides of FOMA AC Adapter 01/02 (sold separately) and FOMA DC Adapter 01/02 (sold separately)]

1 Insert the AC or DC adapter connector horizontally into the external connector terminal of the FOMA charger micro USB adapter SH01/FOMA charging micro USB adapter T01 (1)

- Check the direction (front or rear) of the connector, keep it parallel with the FOMA charger micro USB adapter SH01/FOMA charging micro USB adapter T01 and securely push all the way in until it clicks.

2 Open the external connector terminal cover of the handset and insert the microUSB plug of the FOMA charger micro USB adapter SH01/FOMA charging micro USB adapter T01 horizontally into the external connector terminal (2)

- Check the direction (front or rear) of the microUSB plug and insert it horizontally.
- The following illustration is an example to insert the FOMA charger micro USB adapter SH01.

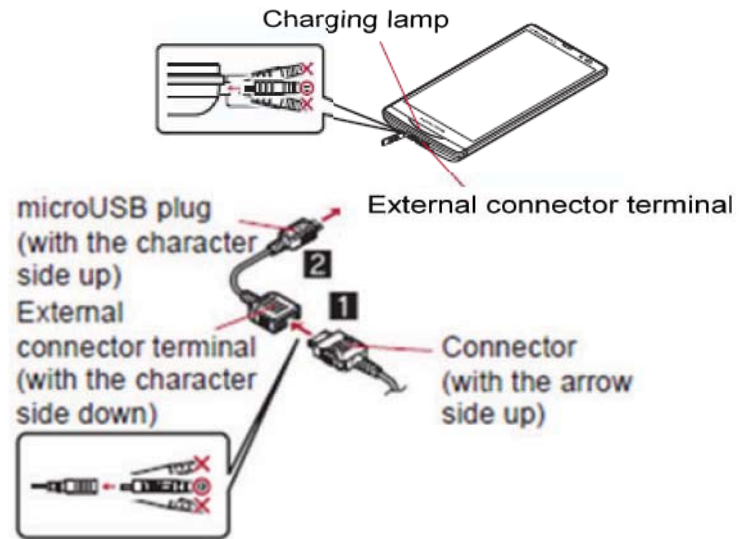

3 When inserting the AC adapter power plug into an outlet or inserting the DC adapter power plug into a car cigarette lighter socket, charging lamp illuminates and charging starts

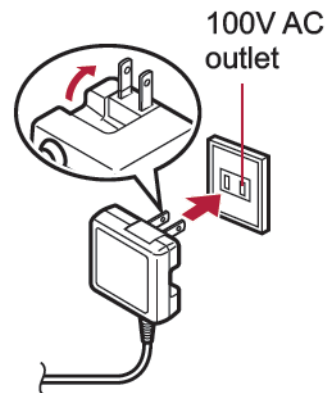

For AC adapter



For DC adapter

4 When charging lamp turns off, charging is complete

- When charging is complete, remove the microUSB plug horizontally from the handset (1).
- When removing the connector from the FOMA charger micro USB adapter SH01/ FOMA charging micro USB adapter T01, always hold the release buttons on both sides (2) and unplug it horizontally (3).



- Do not forcibly insert or remove. May cause damage to the external connector terminal, the microUSB plug and the connector.
- Pull the adapter out of the outlet or cigarette lighter socket if it will not be used for a long time.
- Do not forcibly pull the external connector terminal cover. May damage the cover.
- Do not place objects near the handset when charging. May damage the handset.

When using a DC adapter

- The DC adapter should only be used in negative grounded vehicles (12 and 24V DC).
- Do not use with the car engine shut off. May drain the car battery.

- The DC adapter fuse (2A) is a consumable. For replacement, purchase a new fuse at a local vehicle supply shop.
- Refer to the user's guide of FOMA DC Adapter 01/02 for details.

Charging with microUSB cable for PC

When the handset is turned on, you can charge the handset by connecting the handset to a PC with the microUSB cable for PC (sample).

- Install the USB driver to the PC in advance.
 - For details on installing USB driver, refer to "Manual for USB Driver Installation" in PDF format in the following site.
http://k-tai-sharp.co.jp/support/d/sh-06d/download.html#usb_driver
- For details on connecting to a PC P. 34

Turning power ON/OFF

Turning power ON

1 (for at least 2 seconds)

- When you turn the power on for the first time, the initial setting screen is displayed. Each setting item can also be set from menus
- If the initial setting screen for docomo service is displayed, operate by following the instructions on the screen.

Turning power OFF

1 (for at least 1 second) ▶ [Power off] ▶ [OK]

■ Sleep mode

The screen is off and the sleep mode is activated when [⏻] is pressed or the handset is not in use for a set length of time.

Press [⏻] in the sleep mode to deactivate the sleep mode.

■ Touch panel lock

When the power is turned on or the sleep mode is deactivated, the touch panel is locked.

Drag [⏻] to [🔒] to unlock.



Key operation in touch panel unlock screen

- To set/disable the manner mode: [⏻] (for at least 1 second)
- To turn on the mobile light: [⏻] (for at least 1 second)
 - Press any of the keys or touch [⏻] to turn it off.
- To turn off power: [⏻] (for at least 2 seconds)

- If there is an unchecked missed call etc., an icon is displayed on the unlock screen. If you slide the icon upward before unlocking the touch panel, the corresponding screen is displayed.
- The mobile light will automatically turn off approximately 30 seconds after it turns on.

Basic operation

Operation of touch panel

You can operate by touching the touch panel (display) directly with your finger.

- Operations differ depending on the function and screen in use.

Cautions when using the touch panel

- The touch panel is designed to be lightly touched with your finger. Do not forcefully press with your finger or press with a pointed object (fingernail, ballpoint pen, pin, etc.).
- In the following cases, the touch panel may not work even if you touch it. May cause a malfunction.
 - Operation with a gloved finger
 - Operation with a fingernail
 - Operation with foreign objects placed on the operation pad
 - Operation on the touch panel on which a protective sheet or a sticker is put
 - Operation while the touch panel is wet
 - Operation with fingers wet with sweat or water

■ Touch

Touch a key or an item displayed on the screen to select or set it.

1 Put your finger on the touch panel and put it off

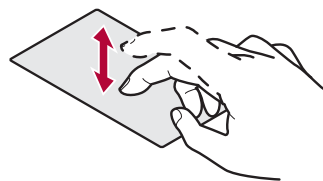

■ Touch for a while

When you touch the screen for a while, a menu may appear depending on the function and screen in use.

1 Keep your finger on the touch panel

■ Slide/Drag

Slide your finger up/down while a menu is displayed etc. to scroll the screen or slide (drag) an icon, widget, etc. to move it to the desired position while keeping touching it.

In addition, when you touch a menu or item by mistake, slide your finger away from the menu or item to cancel the selection.

1 Keep your finger on the touch panel and slide it

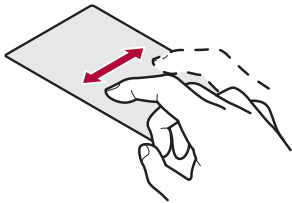

■ Flick

Flick your finger to the left/right in the home screen etc. to switch pages.

1 Move your finger like sweeping the touch panel

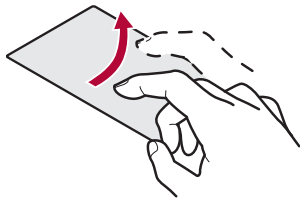

■ Pinch out/Pinch in

Pinch out/Pinch in while displaying an image etc. to zoom in/out.

1 Put two fingers on the touch panel and slide them with putting a distance between two fingers apart (pinch out)/closer (pinch in)

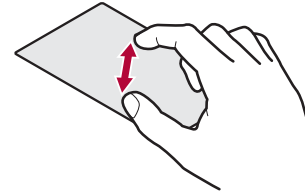

Wi-Fi settings

If you use Wi-Fi function of the handset, you can use mail or internet by connecting to your home, corporate network or access points of public wireless LAN service.

The radio interference with Bluetooth devices

- Wireless LANs (IEEE 802.11b/g/n) use the same frequency band (2.4 GHz) as Bluetooth devices. Therefore, using the wireless LAN device near a Bluetooth device may cause radio interference, lowering of communication speed, noise or connection failure. In this case, turn off the Bluetooth device or keep the handset and the wireless LAN device at least approximately 10 m away from the Bluetooth device.
- Packet communication is also available while Wi-Fi function is enabled. Wi-Fi connection is prioritized while Wi-Fi connection is set, but the connection will be automatically switched to that of 3G/GPRS network once Wi-Fi connection is terminated. Note that packet communication charges will be incurred in such cases.
- Refer to the manual of your wireless LAN base unit when using the access point at home.
- Operate access point registration near the access point.
- Enable Wi-Fi before setting.

1 In the home screen, [⊖] ▶
[Settings] ▶ [Wireless &
networks] ▶ [Wi-Fi settings]

2 Select an item

- **Wi-Fi:** Enable Wi-Fi function.
- **Network notification:** You get notified by the notification icon when open Wi-Fi network is detected.
- **Wi-Fi sleep policy:** Set the timing to switch Wi-Fi sleep.
- **Easy Wi-Fi registration:** Register WPS-compatible access point.
- **Auto login settings:** You can set the handset to log in DOCOMO Public Wireless LAN Service automatically when you come within its service area.
- **Add Wi-Fi network:** Register access points which are not compatible with WPS manually.
- Available access points are displayed as items in “Wi-Fi networks”. To connect, select an access point to be used ▶ [Connect].
 - If you select an access point protected by security, enter the password (security key).

[Easy Wi-Fi registration]

- The registration process takes a few minutes. After completion of the registration of the access point, check that the proper connection to the access point is acquired.

[Auto login settings]

- Separate subscription is required to use DOCOMO Public Wireless LAN Service.
- In some service areas, automatic login function may be unavailable.
- If you set Auto-login to [ON], the handset logs in automatically when coming within the service area. Note that high charges may be incurred if your subscription is Mzone daily plan and you set Auto-login to [ON].

- This function may become unavailable according to change of the log-in page contents of DOCOMO Public Wireless LAN Service. In this case, log in via the browser.

[Add Wi-Fi network]

- This function supports WEP, WPA/WPA2 PSK, 802.1xEAP as the security setting.

Detailed settings

- 1 In the home screen, [⊖] ▶
[Settings] ▶ [Wireless & networks] ▶ [Wi-Fi settings] ▶
☰ ▶ [Advanced]

2 Select an item

- **Use static IP:** Specify a static IP address and set whether to connect to Wi-Fi network.
- **IP address:** Set the IP address.
- **Gateway:** Set the gateway.
- **Netmask:** Set the network mask.
- **DNS 1:** Set the DNS 1.
- **DNS 2:** Set the DNS 2.

- You can confirm the MAC address and the IP address of the handset in Advanced.

Disconnecting

- 1 In the home screen, [⊖] ▶
[Settings] ▶ [Wireless & networks] ▶ [Wi-Fi settings]
- 2 Select the connected access point ▶ [Forget]

- Disconnect with the password retained.

- When you terminated the connection with Wi-Fi function disabled, enable Wi-Fi function to connect automatically if the previously connected access point is available.

Wi-Fi tethering

Tethering function that connects Wi-Fi compatible devices to the Internet by using the handset as a Wi-Fi access point is available.

- You can connect to up to five Wi-Fi compatible devices simultaneously.
- This function is available inside the FOMA service area. However, this function may be interrupted depending on the conditions on communications or on network congestion.
- This function is not available when docomo mini UIM card is not inserted or in cases in which the FOMA service is canceled or stopped.

- 1 In the home screen, [⊖] ▶
[Settings] ▶ [Wireless & networks] ▶ [Portable hotspot]

2 Select an item

- **Portable Wi-Fi hotspot:** Enable the Wi-Fi tethering.
 - Check the details of the precautions before use.
- **Portable Wi-Fi hotspot settings:** Set the Wi-Fi tethering settings such as network SSID and security.
 - [Configure Wi-Fi hotspot] ▶ set each item ▶ [Save] to set Wi-Fi hotspot. Set security setting if necessary. The security setting supports WPA2 PSK.
- **Help:** Display Help information.

Setting up mail account

- 1 In the home screen, [⊖] ▶ [Email]**
 - Only when an account is not set, the account setting screen appears.
- 2 Enter mail address and password ▶ [Next]**
 - Provider information is preset for some mail accounts, and a receiving mail server and a sending mail server are automatically set.
 - When you use an account whose provider information is not preset, it is necessary to set a receiving mail server and a sending mail server manually. For details on those settings, contact the Internet service provider you use.
- 3 Enter an account name and your name ▶ [Done]**

- The account which is registered first is automatically given priority to normal use. To change the priority, enable [Default account] on the setting screen for the account on which you want to place priority.
- When the account type is Exchange, entering “¥UsernameDomain” in the “Domain¥Username” area is required to set a receiving mail server manually depending on the provider to use. Contact the administrator of the server for details.

Setting up Google account, etc.

- 1 In the home screen, [⊖] ▶ [Settings] ▶ [Accounts & sync] ▶ [Add account]**
- 2 Select the account type**
- 3 Set up an account**

- When activating the application that requires an account without setting the account, the account setup screen appears.
- Keep a separate memo of the set account and password.

Deleting your account

- 1 In the home screen, [⊖] ▶ [Settings] ▶ [Accounts & sync]**
- 2 Select an account ▶ [Remove account] ▶ [Remove account]**

Retrieving your Google account password

If you forget your Google account password, retrieve it.

- 1 In the home screen, [⊖] ▶ [Browser]**
- 2 Enter “http://www.google.com/” in the URL entry field ▶ [→] ▶ [more] ▶ [Sign In] ▶ [Can’t access your account?] ▶ follow the instructions on the screen**

Call/Network Services

Making a call

1 In the home screen, [☰] ▶
[Phone] ▶ [Dial]

2 Enter a phone number

- Always dial the area code, even when it is a local number.
- You can set to notify/not to notify the other party of your phone number for each call by adding “186”/“184” to the head of the phone number.

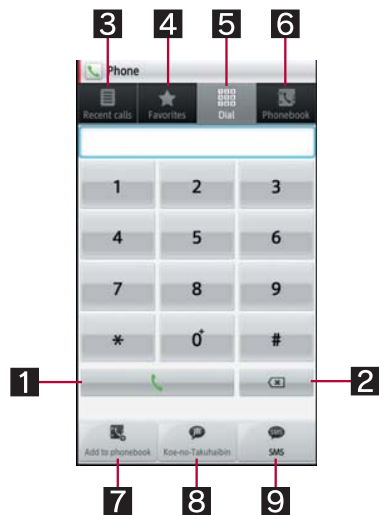

1 Call

- Make a call. Also, if there is an outgoing history, touch to enter the latest outgoing history when the phone number has not been entered.

2 Delete

- Delete an entered number.

3 Outgoing/Incoming history

4 Favorites

- Display the phonebook set to [Favorites] by groups.

5 Dial

- Display the dial screen.

6 Phonebook

7 Add to phonebook

8 Koe-no-Takuhaibin

9 SMS

3 [↵]

4 [End] to end the call

Entering a push-button phone signal

1 In the home screen, [☰] ▶
[Phone] ▶ [Dial]

2 Enter a phone number ▶ [*] (for at least 1 second)

3 Enter a number to send ▶ [↵]

Emergency call

Emergency calls	Phone number
Emergency call to police	110
Emergency call to fire station/medical assistance	119
Emergency call at sea	118

- The handset supports “Location notification of emergency call”.
When dialing an emergency number such as 110, 119, and 118, the information of your location (location information) is automatically notified to the agency that received the emergency call (e.g. the police station).
Depending on your location and the reception status of the signal, the agency that received the emergency call may not be able to confirm the exact location.
If you are not sending your caller ID by calling with “184” added or other means, your location information and phone number are not notified. However, if the agency that received the emergency call considers your location information and phone number necessary for important purposes, such as life saving, the agency can retrieve them regardless of your settings.
In addition, the area/timing to introduce “Location notification of emergency call” depends on the state of preparation in each agency that receives emergency calls.
- In Japan, you cannot call to the emergency number (110, 119 or 118) from the PIN code entry screen and PUK (PIN Unlock Key) entry screen, with a docomo mini UIM card locked.

- When calling 110, 119, and 118 from your handset, the police or fire stations may return your call for verification purposes. State that you are calling from a mobile phone, and give your phone number and exact location. Remain stationary to ensure that you are not disconnected while making an emergency call, and keep handset turned on to receive calls for approximately 10 minutes afterwards.
- Depending on the region, calls to the police or fire station may not be connected.

International call (WORLD CALL)

WORLD CALL is an international calling service available from DOCOMO handset in Japan.

WORLD CALL is registered when FOMA services are registered (excluding users who did not apply for WORLD CALL).

- You can call to about 240 countries and regions worldwide. Calling to a fixed-phone and mobile phone overseas is available.
- For information on available countries and telecommunications carriers, refer to “Mobile Phone User’s Guide [International Services]” or the DOCOMO International Services website.
- WORLD CALL charges are billed with the monthly FOMA service charges.
- Commission and monthly usage fees are free.
- Contact “General Inquiries” on the back of this manual for details on WORLD CALL.
- To make an international call through a company other than DOCOMO, contact the representative companies for instructions.

- The caller ID may not be notified or displayed correctly depending on some overseas telecommunications carriers. In this case, making a call with incoming call history is not available.

[Calling Method]

- When calling to a fixed-line phone: 010 ▶ country code ▶ area code (city code) ▶ the other party's phone number ▶ [↵]
- When calling to a mobile phone: 010 ▶ country code ▶ the other party's phone number ▶ [↵]
- For the other parties' phone numbers and area codes (city codes) that begin with "0", omit the "0" when entering (except some countries or regions such as Italy).
- Alternatively, enter "009130-010" as usual or "+" instead of "010".

Receiving a call

1 When a call is received, the ring tone sounds and the incoming lamp flashes

- If you press  during an incoming call, you can stop incoming ring tone or vibrator.

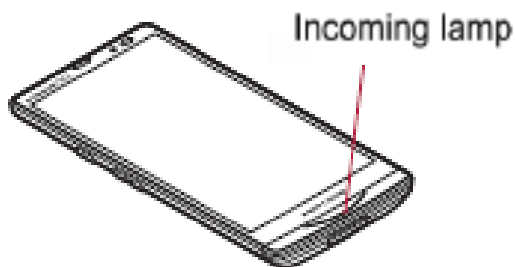

2 Receive a call

- When [Activate] is displayed, operate after touching [Activate].



1 Accept

- You can receive a call.

2 Reject

- You can reject an incoming call.

3 [End] to end the call

■ Answering by answering memo

1 When a call is received, the ring tone sounds and the incoming lamp flashes

2 ▶ [Absence Memo]

■ Placing a call on hold

1 When a call is received, the ring tone sounds and the incoming lamp flashes

2 ▶ [On hold]

Infrared communication

Using infrared communication

Use infrared communication to send and receive data to and from other handsets which also support infrared communication.

- Send and receive phonebook entries, sp-mode mails, profiles, memos, schedules, bookmarks, ToruCa, data shot by camera, etc.
- The handset infrared communication function complies with IrMC™ 1.1 standard. However, depending on the data, some data may not be sent or received even when the other party's handset complies with IrMC™ 1.1 standard.
- The handset Ir send and receive functions comply with IrSimple™ standard.
- Infrared communication is not available in Offline(airplane) mode.
- To enter docomo application password or Lock No. and to enter authentication code are required for sending and receiving all data items. The authentication code is a password exclusively for infrared communication. Before starting data communication, the sender and receiver must enter the same user-specified four-digit code.

When using infrared communication

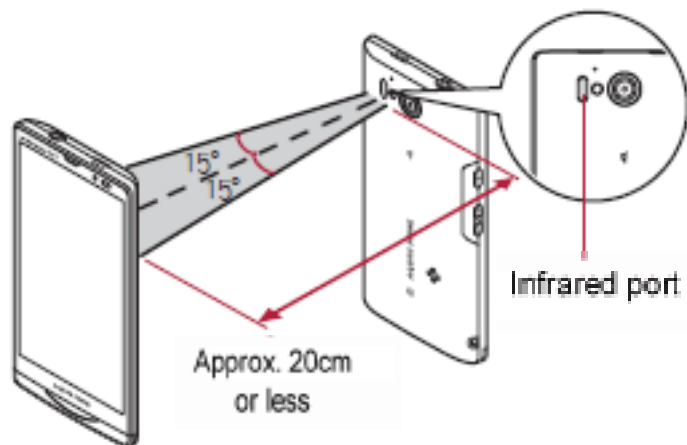

- Face the Infrared ports of the receiver's and sender's handset each other and set the distance between them to approximately 20 cm or less as shown.
- While doing infrared communication, keep the Infrared ports facing each other and do not move them.
- Infrared communication may not function properly in areas of direct sunlight, directly under fluorescent lights or near other equipment using infrared signals.
- If either of the Infrared ports is dirty, infrared communication will become difficult. Take care not to scratch the ports, and wipe off any dirt with a soft cloth.

Sending and receiving by Infrared

- Insert a microSD Card in advance. However, sending and receiving just single data may not require the microSD Card.
- When sending data, you can also operate from each function (menu).

1 In the home screen, [] ▶ [Send and Receive by Infrared]

2 Select an item

- **Receive:** Receive single data.
- **Receive all:** Receive all data.
- **Send:** Select data and send.
- **Send all:** Send all data by selecting an application.
- **Send image and video settings:** Set the format of when sending images or videos.
- Perform the operation for receiving and sending at the same time.
- After the operation for receiving, the handset waits to receive data. Infrared communication automatically begins when data is sent from sender's handset within approximately 30 seconds.

- Note that if you select [Delete all before registration] when receiving all data, all data registered to the target function are deleted.
- Receiving all data is not available depending on the data type.
- When you send 3D images, select [Contents Manager] in the screen to select an application.
- When available memory space in the save destination becomes insufficient, the data being received to that point are saved and receiving ends.
- IrSS™ communication performs communication without confirming the response of the receiver side, since it uses a simplex communication. For this reason, the sender side completes the communication normally even if the receiver side does not.

iC communication



Using iC communication

You can send and receive data with other handsets equipped with iC communication function.

- Make initial setting of Osaifu-Keitai in advance.
- In the following cases, you cannot perform iC communication.
 - During Offline(airplane) mode
 - During Osaifu-Keitai lock
- In the following cases, data may not be sent via iC communication.
 - During a call
 - During charging
 - During earphone/microphone connection
 - During USB connection

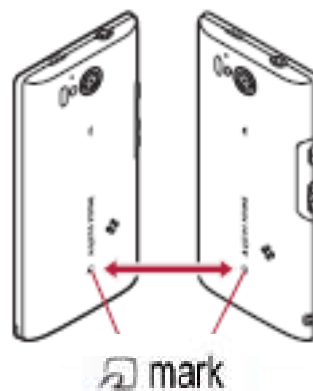
When using iC communication



- Use while placing the  mark of receiver's handset on that of sender's handset as shown.
- Do not move the handset until sending and receiving of data is completed.
- There may be some cases in which data are poorly sent and received or the screen is off by positioning the handset near depending on the other party's handset. In that case, put a distance between the  marks apart/closer or slide them up/down or to the left/right.

Sending and receiving by iC

To enter authentication code is required for sending and receiving all data items. The authentication code is a password exclusively for iC communication. Before starting data communication, the sender and receiver must enter the same user-specified four-digit code. In addition, to enter Lock No. may be required for sending all data items.

- Insert a microSD Card in advance. However, sending and receiving just single data may not require the microSD Card.

■ Sending data

Example: Still picture

- 1 In the home screen, [⊖] ▶
[Contents Manager]
- 2 Touch a still picture for a while ▶
[Share] ▶ [Send by IC]
- 3 Place the  mark on that of the other party's handset
- 4 [Ok]

■ Receiving data

- 1 Place the  mark on that of the other party's handset
- 2 [Accept]
- 3 Touch the status bar ▶ select received data

Bluetooth function

You can connect the handset to Bluetooth devices wirelessly.

- Wireless communications with all the Bluetooth devices are not completely guaranteed.
- Bluetooth function is not available in Offline(airplane) mode.

Supported version and supported profiles

■ Supported version

Bluetooth Specification Ver.3.0+EDR*1

■ Supported profiles*2 (Supported services)

HSP: Headset Profile*3

HFP: Hands Free Profile*4

A2DP: Advanced Audio Distribution Profile*5

AVRCP: Audio/Video Remote Control Profile*5

HID: Human Interface Device Profile*6

OPP: Object Push Profile*7

SPP: Serial Port Profile*8

PBAP: Phone Book Access Profile*9

- *1 The handset and all Bluetooth function-installed devices have ensured that they conform to the Bluetooth specification according to the rules that the Bluetooth SIG defines, and are all authenticated. However, operating methods might differ or data might not be exchanged even when they are connected wirelessly, depending on the features or specifications of connecting devices.
- *2 Standardizes the communication procedures of Bluetooth device per feature of a device.
- *3 Connect commercially available Bluetooth compatible Headset to the handset to talk wirelessly.
- *4 Connect a commercially available Bluetooth compatible hands-free device such as a car navigation system to the handset to talk during hands-free operation using the car navigation system.
- *5 Connect Wireless Earphone Set 02 (sold separately) or commercially available Bluetooth compatible audio device to the handset to play music, sound of 1Seg, etc. wirelessly. Also, remote control operation may be available from Bluetooth devices. However, compatible devices are limited depending on the data type.

- *6 Connect commercially available Bluetooth compatible keyboard to Bluetooth devices to enable you to enter characters with a keyboard.
- *7 Connect a Bluetooth device to the handset with the File transfer service to send and receive data between them.
- *8 Set the virtual connection with a serial cable and interconnect between devices.
- *9 Transfer phonebook data in the handset to a Bluetooth device. Data is not displayed correctly on the other party's device depending on the contents of the transferred phonebook data.

- Refer to the manual for the Bluetooth device as well.
- When connecting the Wireless Earphone Set 02, connect it from the handset.
- You cannot listen to sounds regardless of data type with Bluetooth devices which are not compatible with SCMS-T.

Precautions for handling the Bluetooth device

Note the following when using the Bluetooth device.

- Note the following to make good connection.
 - Keep the distance between the handset and another Bluetooth device within approximately 10 m with no obstructions in sight. The distance that can make connection may be shorter when there are obstructions between them or depending on the conditions of the surroundings (such as walls or furniture) and the structure of a building. Especially when there is a wall or floor of reinforced concrete between them, they may be unable to connect with each other. Note the above mentioned distance is not guaranteed.

- Move the handset and another Bluetooth device as far away as possible from home electric appliances, AV devices, OA devices, etc. before connection. The Bluetooth device is liable to be adversely affected by a microwave oven, so move it as far away as possible from the microwave oven while using it. Otherwise, normal connection cannot be performed when electric devices are powered on or Bluetooth devices may cause noises or reception failure on a TV or radio set (TV images may degrade for specific channels of UHF or satellite broadcasting).
- Move the Bluetooth device to a place that connection is possible when there is a broadcast station or radio near the Bluetooth device, and the handset cannot be connected to the device. Strong radio waves may prevent connection between Bluetooth devices.
- Wireless connection is available with Bluetooth device put in a bag or pocket. However, lowering of communication speed or noise may result when you are in between the Bluetooth device and the handset.
- Electromagnetic signals from the Bluetooth device may affect the operation of electronic medical equipment. As some cases may result in accident, turn off the handset and other Bluetooth devices in the following place.
 - On trains ■ On airplanes ■ In hospitals
 - Nearby automatic doors or fire alarms
 - In places such as gas stations where flammable gas is generated

The radio interference with Wi-Fi compatible devices

- The Bluetooth devices use the same frequency band (2.4 GHz) as wireless LANs (IEEE 802.11b/g/n). Therefore, using the Bluetooth device near a wireless LAN device may cause the radio interference, lowering of communication speed, noise or connection fail. In this case, turn off the wireless LAN device or keep the handset and the Bluetooth device at least approximately 10 m away from the wireless LAN.

Bluetooth settings

- Set after enabling Bluetooth function.
- To register/connect a Bluetooth device, the Bluetooth passkey may need to be entered. Before starting the registration, decide the 1- to 16-digit number. Enter the same number on the handset and the other party's Bluetooth device.

1 In the home screen, [⊕] ▶ [Settings] ▶ [Wireless & networks] ▶ [Bluetooth settings]

2 Select an item

- **Bluetooth**: Enable Bluetooth function.
- **Device name**: Change the handset's name.
- **Discoverable**: Set whether to receive a search request from other Bluetooth devices.
- **Discoverable timeout**: Set the time that can receive a search request.
 - Enable Discoverable in advance.
- **aptX**: Set whether to use aptX™.
- **Detailed Bluetooth Settings**: Set Bluetooth function.

- **Scan for devices**: Search for the Bluetooth devices around the handset and register them in it. Depending on Bluetooth device, it may start connecting after completing registration.
 - Set the other party's Bluetooth device to the registration stand-by status in advance.
- Touch a paired Bluetooth device for a while ▶ [Options...] to change the connection type.

- If you fail to connect, connection may become available after re-registration of Bluetooth devices.

[Bluetooth]

- When the Bluetooth function is enabled, the handset is set to receive a registration request/connection request from other Bluetooth devices. Enable Discoverable in advance to allow the handset to be searched for by other Bluetooth devices.
- While in connection stand-by, even if a connection request from a Bluetooth device is received, connection may not be made depending on the signal strength etc.

[Discoverable]

- Setting is disabled automatically when the period of time set for Discoverable timeout passed after enabling.

[Scan for devices]

- For details on the operations of the other party's Bluetooth device, refer to the manuals of the Bluetooth device to be used.

When receiving registration request from Bluetooth device or connection request from unregistered Bluetooth device

1 Registration request/Connection request from Bluetooth device

2 [Pair]

- Entering the Bluetooth passkey may be necessary depending on the other party's Bluetooth device.
- The request confirmation screen of Bluetooth connection may be displayed.

Disabling registration of Bluetooth device

1 In the Bluetooth setting screen, touch the Bluetooth device to disable the registration for a while ▶ [Unpair]/[Disconnect & unpair]

Disabling connection of Bluetooth device

1 In the Bluetooth setting screen, select the Bluetooth device to disable the connection ▶ [OK]

Sending and receiving by Bluetooth

- Insert a microSD Card in advance. However, sending just single data may not require the microSD Card.

Sending data

Example: Still picture

1 In the home screen, [⊖] ▶ [Contents Manager]

2 Touch a still picture for a while ▶ [Share] ▶ [Bluetooth]

- Set the receiving Bluetooth device to receive data.

3 Select a Bluetooth device to connect to

Receiving data

1 Send data from the sender's Bluetooth device

2 Touch the status bar ▶ select data to receive ▶ [Accept]

3 Touch the status bar ▶ select data to receive

- Note that if you select [Delete all before registration] at receiving all data, all data registered to the target function are deleted.
- Some data cannot be received all.
- When available memory space in the save destination becomes insufficient, the data being received to that point are saved and receiving ends.

External connector device

Connecting the handset and PC

- 1** Insert the handset side connector of the microUSB cable for PC (sample) horizontally into the external connector terminal on the handset (**1**)
- 2** Insert the PC side connector of the microUSB cable for PC horizontally into the USB connector on the PC (**2**)

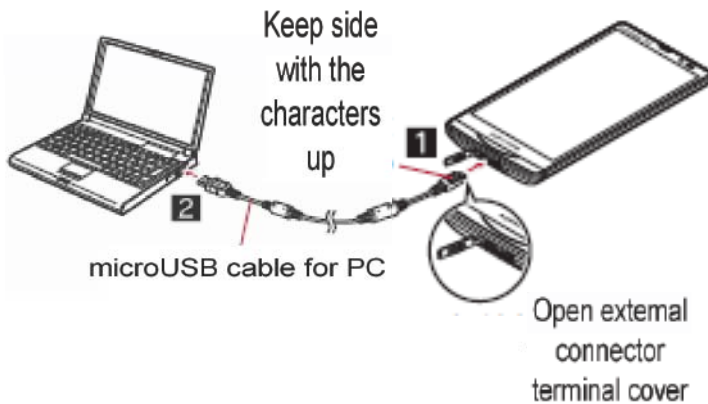

- Windows XP, Windows Vista and Windows 7 all of which are Japanese version are available OS for the connection.

- Use a USB cable “microUSB cable for PC”. USB cables for PC are not available, since the connector shape is different.
- The use of a USB HUB may not work correctly.
- Do not remove the microUSB cable for PC while exchanging data with PC. Data may be damaged.

Osaifu-Keitai

Osaifu-Keitai is a function which has built-in IC card and allows you to pay, use as coupons or collect stamps by simply holding the handset over the scanning device at stores.

Moreover, you can access sites and web pages by holding the handset over the scanning device, and get the latest coupon, deposit electronic money and check your usage by using communication. In addition, for your secure use, you can lock functions of Osaifu-Keitai when you lost the handset.

For details on Osaifu-Keitai, refer to “ご利用ガイドブック (spモード編)” (Mobile Phone User’s Guide [sp-mode]) (in Japanese only).

※ To use Osaifu-Keitai compatible service, settings are necessary on a website or an application.

- The handset malfunctions may cause data (including electronic money, points, etc.) saved in the IC card to be lost or changed (Note that as a rule, you will be asked to delete data when leaving your handset for repairs, etc., since we cannot keep your handset with such data still remaining in it). For the service such as a reissue, restoration, temporary keeping or transfer of the data, contact your provider of Osaifu-Keitai compatible service. Be sure to use the Osaifu-Keitai compatible service including a backup service for important data.
- DOCOMO shall not be liable for any loss or change of data in the IC card or other damages of Osaifu-Keitai service caused by any reason such as malfunctions and upgrading.
- When the handset is stolen or lost, immediately contact your provider of Osaifu-Keitai compatible service for handling methods.

iC transfer service

iC transfer service is a service that enables you to move the data saved in the IC card to new Osaifu-Keitai from the old one when changing Osaifu-Keitai such as by changing models or repairing the handset.

iC transfer service is available at a docomo Shop near you.

For details on iC transfer service, refer to “ご利用ガイドブック (spモード編)” (Mobile Phone User’s Guide [sp-mode]) (in Japanese only).

Using Osaifu-Keitai

- To use Osaifu-Keitai compatible services, download the Osaifu-Keitai compatible application from Osaifu-Keitai compatible sites and make the setting. Some services do not need to download the Osaifu-Keitai compatible application.

1 In the home screen, [☎] ▶ [Osaifu-Keitai]





- If the initial setting is not completed, the initial setting screen appears.

2 Select a service

- You cannot use Osaifu-Keitai in the following situations. However, you can pay by holding the handset over a scanning device.
 - In Offline(airplane) mode
 - When you are charging the handset, connecting a microUSB cable for PC (sample) to it or connecting an earphone/microphone to it while the docomo mini UIM card is not inserted/When the handset has never received radio wave

Holding over scanning device

Hold the  mark of the handset over the scanning device to use as electronic money or railway tickets, to retrieve ToruCa, etc.

- Pay attention to the following points when holding the  mark over the scanning device.
 - Do not contact between the handset and the scanning device
 - Hold the  mark directly above the scanning device
 - Slowly hold the  mark over the center of the scanning device
 - If the scanning device does not recognize the built-in IC card, hold the  mark over the scanning device and move the handset around
 - Do not attach a metallic substance on the  mark side

1 Hold the mark over the scanning device

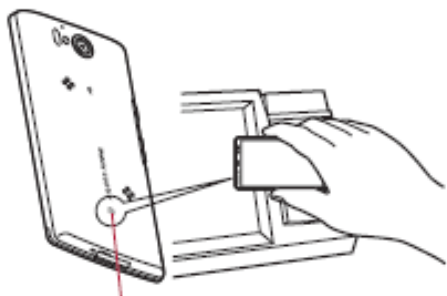

 mark

2 Confirm that the data is scanned

Osaifu-Keitai lock setting

Lock the function of Osaifu-Keitai.

- Perform the same operation to disable the lock.

1 In the service list screen,  ▶
[Osaifu-Keitai Lock Setting] ▶ [Next]

2 Enter the Lock No. ▶ [OK] ▶ [OK]

Before use overseas

Check before departure

Check followings in Japan before using the handset overseas.

Subscription

- Check the status of a subscription for WORLD WING. For details, contact “General Inquiries” on the back of this manual.

Charging battery

- Use FOMA AC Adapter 01 for Global use (sold separately) or FOMA AC Adapter 02 (sold separately) as an AC adapter for charging while traveling overseas.

Charge

- Overseas charges (call charges, packet communication charges) differ from those in Japan.
- Since some applications automatically perform packet communication, the packet communication charges may be higher. Contact the application provider for the operation of each application.

Set before departure

Network service settings

If you subscribed to network services, network services such as Voice Mail Service and Call Forwarding Service are available from overseas. However, some network services are not available.

- To use network services overseas, setting Remote operations to “Activate” is required. Remote operations can be set in your country of stay.

- Some network services that can be set/disabled etc. may not be available depending on overseas telecommunications carriers.

Check in your country of stay

The handset automatically connects to the available telecommunications carrier when you turn the power on in your country of stay.

Connection

When telecommunications carriers (☎ P. 39) is set to [Select automatically], the suitable network is automatically selected.

Overseas packet communication charges are available with a fixed amount of charges as an upper limit per day by connecting to a compatible operator for telecommunications carriers manually. To use this service, subscription to flat-rate packet communication services is required. For details, refer to “Mobile Phone User’s Guide [International Services]” or the DOCOMO International Services website.

Viewing the display

- The type of network in use appears in the status bar.

: During 3G communication/3G available

: During GSM communication/GSM available

- While international roaming, [R] appears on the upper left of the signal icon.
- Connected operator can be checked in the status panel.

Date & time

If [Automatic] of Date & time is enabled, the handset receives information with time and time differences from overseas telecommunications carrier, then time and time differences are corrected.

- Time and time differences may not be adjusted correctly depending on overseas telecommunications carrier. In such a case, set time zone manually.
- The correction timing differs depending on the telecommunications carrier.

Inquiries

- When the handset or the docomo mini UIM card is lost or stolen overseas, promptly contact DOCOMO and conduct a procedure for canceling the use of service from your country of stay. Refer to the back of this manual for inquiries. Note that communication/calling charges after the handset or the docomo mini UIM card is lost or stolen are incurred to the subscriber.
- For land-line phone, etc., “International call access number” of your country of stay or “Universal number international prefix” is required.

Check after homecoming

The handset automatically connects to the DOCOMO network after homecoming. If it fails, perform the following setting.

- Set Network Mode to [3G/GSM(Auto)] (P. 39).
- Set telecommunications carriers to [Select automatically] (P. 39).

Settings to use overseas

At the time of purchase, the handset is set to automatically search for and switch to available networks. When you want to manually switch networks, set by performing following operations.

1 In the home screen, [☰] ▶
[Settings] ▶ [Wireless &
networks] ▶ [Mobile networks]

2 Select an item

- **Data enabled:** Enable data communication.
- **Data roaming:** For details on Data roaming
P. 38
- **Network Mode:** For details on Network Mode
P. 39
- **Access Point Names:** Set an access point.
- **Network operators:** For details on Network operators P. 39

Data roaming

Set whether to use data communication when roaming.

1 In the home screen, [☰] ▶
[Settings] ▶ [Wireless &
networks] ▶ [Mobile networks] ▶
[Data roaming]

Network mode

Set a network to use.

1 In the home screen, [] ▶
[Settings] ▶ [Wireless & networks] ▶ [Mobile networks] ▶
[Network Mode]

2 Select an item

- **3G/GSM(Auto)**: Switch to an available network automatically.
- **3G**: Use 3G network.
- **GSM**: Use GSM/GPRS network.

Network operators

Search for networks and set a network operator to use.

1 In the home screen, [] ▶
[Settings] ▶ [Wireless & networks] ▶ [Mobile networks] ▶
[Network operators]

- Search for networks and a list of network operators is displayed.

2 Select a network operator

- To search for network operators again:
[Search networks]
- To select a network operator automatically:
[Select automatically]

- When networks are not searched, disable [Data enabled] ( P. 38).
- If you manually set network operators overseas, set to [Select automatically] after returning to Japan.

Making/Receiving a call in your country of stay

Making a call outside your country of stay (including Japan)

1 In the home screen, [] ▶
[Phone] ▶ [Dial]

2 “+” (touch “0” for a while) ▶ enter country code, area code (city code) and the other party’s phone number ▶ []

- Alternatively, enter a phone number ▶ [] ▶ [International call] ▶ select a country code to enter a country code.
 - The first “0” of the area code (city code) will be omitted.
- When the area code (city code) begins with “0”, omit the “0” when dialing (Include the “0” when making a call to some countries or regions such as Italy).

- Even if you notify the caller ID, [Unknown] or [ID Unsent] appears depending on the telecommunications carrier, and the caller ID may not be displayed correctly.

Making a call using International dial assist

When you make a call to other countries from your country of stay, you can make an international call with simple operation using International dial assist.

- Set International dial assist in advance.
- The first “0” of a phone number will be converted to the country code you set in Country code automatically.

1 In the home screen, [☎] ▶ [Phone] ▶ [Dial]

2 Enter a phone number ▶ [↵]

3 [Converted number]

Setting of International dial assist

1 In the home screen, [☎] ▶ [Settings] ▶ [Call settings] ▶ [Overseas setting] ▶ [International dial assist]

2 Select an item

- **Automatic conversion function:** Set whether to make calls using International dial assist.
- **Country code:** Set country code to use when using International dial assist.
- **International prefix:** Set international prefix to use when using International dial assist.

Making a call in your country of stay

You can make a domestic call in your country of stay in the same way as you do in Japan.

- Always dial the area code (city code), even when the number is in the same area.

Making a call to a WORLD WING subscriber overseas

When you make a call to a “WORLD WING” subscriber overseas, the call is made as an international call to Japan regardless of your country of stay.

1 In the home screen, [☎] ▶ [Phone] ▶ [Dial]

2 “+” (touch “0” for a while) ▶ enter country code “81” (Japan), the other party’s mobile phone number excluding the first “0” ▶ [↵]

Receiving a call

You can receive a call overseas in the same way as you do in Japan.

- When a call is received during international roaming, the call is forwarded from Japan. Call charges to Japan are incurred by the caller and receiving charges by the receiver.

Having calls to your handset

When having calls made to your handset from Japan, have your phone number dialed just as a domestic call in Japan.

When having calls made to your handset from countries other than Japan, have the international call access number and “81” (Japan) added to the beginning of your phone number with the first “0” excluded as an international call to Japan regardless of your country of stay.

International call access number of the country of the caller-81-90 (or 80)-XXXX-XXXX

Specific Absorption Rate (SAR) of Mobile Phone

This model SH-09D mobile phone complies with Japanese technical regulations and international guidelines regarding exposure to radio waves.

This mobile phone was designed in observance of Japanese technical regulations regarding exposure to radio waves (*1) and limits to exposure to radio waves recommended by a set of equivalent international guidelines. This set of international guidelines was set out by the International Commission on Non-Ionizing Radiation Protection (ICNIRP), which is in collaboration with the World Health Organization (WHO), and the permissible limits include a substantial safety margin designed to assure the safety of all persons, regardless of age and health condition.

The technical regulations and international guidelines set out limits for radio waves as the Specific Absorption Rate, or SAR, which is the value of absorbed energy in any 10 grams of tissue over a 6-minute period. The SAR limit for mobile phones is 2.0 W/kg. The highest SAR value for this mobile phone when tested for use at the ear is 0.53W/kg. There may be slight differences between the SAR levels for each product, but they all satisfy the limit.

The actual SAR of this mobile phone while operating can be well below that indicated above. This is due to automatic changes to the power level of the device to ensure it only uses the minimum required to reach the network. Therefore in general, the closer you are to a base station, the lower the power output of the device.

This mobile phone can be used in positions other than against your ear. This mobile phone satisfies the international guidelines when used with a carrying case or a wearable accessory approved by NTT DOCOMO, INC. (*2). In case you are not using the approved accessory, please use a product that does not contain any metals, and one that positions the mobile phone at least 1.5 cm away from your body.

The World Health Organization has stated that “a large number of studies have been performed over the last two decades to assess whether mobile phones pose a potential health risk. To date, no adverse health effects have been established as being caused by mobile phone use.”

Please refer to the WHO website if you would like more detailed information.

http://www.who.int/docstore/peh-emf/publications/facts_press/fact_english.htm

Please refer to the websites listed below if you would like more detailed information regarding SAR.

Ministry of Internal Affairs and Communications Website:

<http://www.tele.soumu.go.jp/e/sys/ele/index.htm>

Association of Radio Industries and Businesses Website:

<http://www.arib-emf.org/index02.html> (in Japanese only)

NTT DOCOMO, INC. Website:

<http://www.nttdocomo.co.jp/english/product/sar/>

SHARP Corporation Website:

<http://www.sharp.co.jp/products/menu/phone/cellular/sar/index.html> (in Japanese only)

- *1 Technical regulations are defined by the Ministerial Ordinance Related to Radio Law (Article 14-2 of Radio Equipment Regulations).
- *2 Regarding the method of measuring SAR when using mobile phones in positions other than against the ear, international standards (IEC62209-2) were set in March of 2010. On the other hand, technical regulation is currently being deliberated on by national council (As of October , 2011).

European RF Exposure Information

Your mobile device is a radio transmitter and receiver. It is designed not to exceed the limits for exposure to radio waves recommended by international guidelines. These guidelines were developed by the independent scientific organization ICNIRP and include safety margins designed to assure the protection of all persons, regardless of age and health.

The guidelines use a unit of measurement known as the Specific Absorption Rate, or SAR. The SAR limit for mobile devices is 2 W/kg and the highest SAR value for this device when tested at the ear was 0.342 W/kg※.

As SAR is measured utilizing the devices highest transmitting power the actual SAR of this device while operating is typically below that indicated above. This is due to automatic changes to the power level of the device to ensure it only uses the minimum level required to reach the network.

The World Health Organization has stated that present scientific information does not indicate the need for any special precautions for the use of mobile devices. They note that if you want to reduce your exposure then you can do so by limiting the length of calls or using a hands-free device to keep the mobile phone away from the head.

-
- * The tests are carried out in accordance with international guidelines for testing.

Declaration of Conformity

CE0168

In some countries/regions, such as France, there are restrictions on the use of Wi-Fi. If you intend to use Wi-Fi on the handset abroad, check the local laws and regulations beforehand.

Hereby, Sharp Telecommunications of Europe Ltd, declares that this SH-06D is in compliance with the essential requirements and other relevant provisions of Directive 1999/5/EC.
A copy of the original declaration of conformity can be found at the following Internet address:
<http://www.sharp.co.jp/k-tai/> (in Japanese only)

FCC Notice

- This device complies with part 15 of the FCC Rules.
Operation is subject to the following two conditions:
(1) This device may not cause harmful interference, and (2) this device must accept any interference received, including interference that may cause undesired operation.

- Changes or modifications not expressly approved by the manufacturer responsible for compliance could void the user's authority to operate the equipment.

Information to User

This equipment has been tested and found to comply with the limits of a Class B digital device, pursuant to Part 15 of the FCC Rules. These limits are designed to provide reasonable protection against harmful interference in a residential installation. This equipment generates, uses and can radiate radio frequency energy and, if not installed and used in accordance with the instructions, may cause harmful interference to radio communications.

However, there is no guarantee that interference will not occur in a particular installation; if this equipment does cause harmful interference to radio or television reception, which can be determined by turning the equipment off and on, the user is encouraged to try to correct the interference by one or more of the following measures:

1. Reorient/relocate the receiving antenna.
2. Increase the separation between the equipment and receiver.
3. Connect the equipment into an outlet on a circuit different from that to which the receiver is connected.
4. Consult the dealer or an experienced radio/TV technician for help.

FCC RF Exposure Information

Your handset is a radio transmitter and receiver. It is designed and manufactured not to exceed the emission limits for exposure to radio frequency (RF) energy set by the Federal Communications Commission of the U.S. Government.

The guidelines are based on standards that were developed by independent scientific organizations through periodic and thorough evaluation of scientific studies. The standards include a substantial safety margin designed to assure the safety of all persons, regardless of age and health. The exposure standard for wireless handsets employs a unit of measurement known as the Specific Absorption Rate, or SAR. The SAR limit set by the FCC is 1.6 W/kg.

The tests are performed in positions and locations (e.g., at the ear and worn on the body) as required by the FCC for each model. The highest SAR value for this model handset when tested for use at the ear is 0.568 W/kg and when worn on the body, as described in this user guide, is 0.676 W/kg.

Body-worn Operation; This device was tested for typical body-worn operations with the back of the handset kept 1.0 cm from the body. To maintain compliance with FCC RF exposure requirements, use accessories that maintain a 1.0 cm separation distance between the user's body and the back of the handset. The use of beltclips, holsters and similar accessories should not contain metallic components in its assembly.

The use of accessories that do not satisfy these requirements may not comply with FCC RF exposure requirements, and should be avoided.

The FCC has granted an Equipment Authorization for this model handset with all reported SAR levels evaluated as in compliance with the FCC RF emission guidelines. SAR information on this model handset is on file with the FCC and can be found under the Display Grant section of <http://www.fcc.gov/oet/ea/fccid/> after searching on FCC ID APYHRO00170.

Additional information on Specific Absorption Rates (SAR) can be found on the Cellular Telecommunications & Internet Association (CTIA) Website at <http://www.ctia.org/>.

- The abbreviations of operating systems (Japanese versions) below are used in this manual.
 - Windows 7 stands for Microsoft® Windows® 7 (Starter, Home Basic, Home Premium, Professional, Enterprise and Ultimate).
 - Windows Vista stands for Windows Vista® (Home Basic, Home Premium, Business, Enterprise and Ultimate).
 - Windows XP indicates the Microsoft® Windows® XP Professional operating system or Microsoft® Windows® XP Home Edition operating system.
- The Bluetooth word mark and logos are owned by the Bluetooth SIG, INC. and any use of such marks by NTT DOCOMO, INC. is under license. Other trademarks and trade names are those of their respective owners.
- Google, Google logo, Android, Android Market, Gmail, Google Maps, Google Talk, Google Maps Navigation, Google Latitude, Google Places, Google Voice Search, YouTube, and YouTube logo are trademarks or registered trademarks of Google Inc.
- Mercury 3D is a generic name of 3D conversion technology of Mercury System Co.,Ltd. The authorization by Mercury System Co.,Ltd. (Mercury@Mercury3d.co.jp) is required to convert still image received from other media (except still pictures taken by the handset) to 1920 × 1080 pixels or bigger 3D image for commercial use.
- Eco Backlight Control uses Assertive Display technology by Apical Limited.



- This product contains Audio Enhancement technology by AM3D.