

au

AQUOS PHONE *SERIE*



ISW16SH

Basic Manual

Contents

Safety Precautions

Getting Ready

Basic Operations

Character Input

Phone

Settings

Appendix/Index

Preface

Thank you for buying the “AQUOS PHONE SERIE ISW16SH” (simply called the “ISW16SH” or the “product” from here on). Before using the product, be sure to read the “Basic Manual” (this PDF manual) on the au homepage to ensure correct use. After you have finished reading this PDF manual, be sure to store it and the printed manuals (Accessories) in safe places so that you can retrieve them whenever you need them. If you lose the printed manuals (Accessories), contact an au shop or Customer Service Center.

Operating Instructions

■ “Basic Manual” (This PDF Manual)

This manual describes basic operations of major functions. For detailed descriptions of various functions, refer to the “Instruction Manual application” (Japanese) that can be used on the product or “Full Instruction Manual” (Japanese) on the au homepage:

<http://www.au.kddi.com/torisetsu/index.html>

■ “Instruction Manual Application” (Japanese)

You can use the “Instruction Manual application” on the product to check detailed operational procedures. Also, you can activate intended functions from an explanation screen depending on the functions. On the home screen, tap [APPS] → [Instruction Manual].

- To use the application for the first time, you need to download and install it by following on-screen instructions.

■ Downloading Manuals

You can download the “Basic Manual” (this PDF manual) and the “Instruction Manual” (Accessory) (Japanese) or “Full Instruction Manual” (Japanese) in PDF format from the au homepage.

Safety Precautions

Before you start using the product, be sure to read the “Safety Precautions” to ensure correct use. For troubleshooting, check the symptom of the product in auお客様サポート (au Customer Support) on the au homepage:
<http://cs.kddi.com/support/komatta/kosho/index.html>

When Using the Product

- Communication is not possible even inside the service area in places where the signal does not reach (e.g. tunnels and basements). Also, communication may not be possible in poor reception areas. Communication may be interrupted if you move into poor reception areas during a communication.
- A feature of digital communication made on the product is that consistent, high communications quality continues to be maintained down to a weak signal limit. Accordingly, communication may be interrupted if this limit has been reached during a communication.
- Since the product uses radio waves, the possibility of communication intercepts by third parties cannot be eliminated. (Though the CDMA/GSM/UMTS system has highly secured confidential communication features.)
- The product is compatible with the international roaming service. Each network service described in this manual varies depending on the area and service content.
For details, refer to "Global Passport Owner's Guide".
- Since the product is a radio station under the Radio Law, you may be asked to temporarily submit the product for inspection in accordance with the Radio Law.
- When you insert the micro au IC-Card, the product number information of your cell phone is automatically sent to KDDI CORPORATION for maintenance and monitoring operational status of your cell phone.
- Take care not to inconvenience people around you when you use the product in a public place.
- When the product is used by a child, parents or guardians should thoroughly read this PDF manual and teach the child how to use it.

Cell Phone Etiquette

Cell phones always emit weak radio waves when power is on. Use cell phones in an enjoyable and safe manner without forgetting to be considerate of others around you.

■ Use of cell phones is not allowed in the following places!

- Do not use a cell phone while driving a car or riding a motorbike or bicycle. It may cause a traffic accident. Use of a cell phone while driving a car or motorbike is prohibited by law. Use of a cell phone while riding a bicycle may be punishable by some regulations.
- Be sure to turn off the product while you are aboard an airplane. Otherwise, safety of your flight may be compromised.

■ Be considerate of where you use the cell phone and how loudly you talk!

Do not make calls in theaters, museums, libraries, and other similar places. Turn power off or turn on the manner mode so as not to disturb others around you by ringtones.

- Do not use the cell phone on a street where you might interrupt the flow of pedestrians.
- Move to areas where you will not inconvenience others on trains, in hotel lobbies, etc.
- Refrain from talking in a loud voice.
- Obtain the permission of other people before you take their photos with the cell phone's camera.

■ Be considerate of people around you!

- Some people close to you in crowded places such as packed trains may be using a cardiac pacemaker. Turn the cell phone off in such places.
- Abide by the rules of hospitals and other medical institutions where it is forbidden to use or carry cell phones.

List of Packaged Items

Before you start using the product, make sure that you have all the following packaged items with the product.

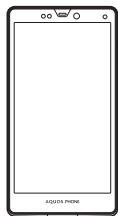

ISW16SH

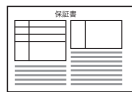

Warranty
(Japanese)

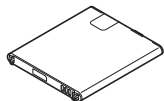

Battery pack (SHI16UAA)



microSD memory card
(2 GB) (Sample)

- This is inserted in the ISW16SH at the time of purchase.

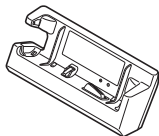

Desktop holder
(SHI16PUA)

- Instruction Manual (Japanese)
- Setting Guide (Japanese)
- Before Using the Product (Japanese)
- Global Passport Owner's Guide (Japanese)

The following items are not included in the package.

- AC adapter
- Earphone
- microUSB cable

- Purchase a specified charger (sold separately).
- Illustrations in this manual are only for reference. They may look different from the actual product.

Using au Disaster Countermeasure Application

au Disaster Countermeasure is an application in which you can use Disaster Message Board, Early warning mail (earthquake early warnings, disaster/evacuation information and tsunami warnings) and Disaster Voice Delivery Service.

1 On the home screen, [APPS] → [au災害対策] (au Disaster Countermeasure).

The au disaster countermeasure menu is displayed.

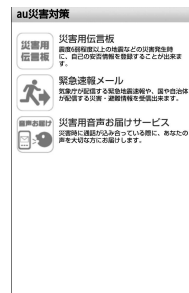

(au disaster countermeasure menu)

■ Using Disaster Message Board

Disaster Message Board is a service to enable customers in disaster areas to register their safety information via IS NET when large-scale disasters, such as an earthquake whose Japan seismic scale is approximately 6-lower or more, occur. The registered safety information can be checked by customers using au phones, and also from other carriers' cell phones, PCs, etc.

For details, refer to "Disaster Message Board Service" on the au homepage.

1 From the au disaster countermeasure menu, [災害用伝言板] (Disaster Message Board).

Follow the on-screen instructions for registration/confirmation.

memo

- To register the safety information, an e-mail address (~ezweb.ne.jp) is required. Set the mail address in advance.
- It is unavailable while connecting via Wi-Fi®.
- The Company does not guarantee the quality of this service. The Company, regardless of the cause, shall not be liable for any problems related to registration of safety information due to the concentration of access to this service or equipment errors, any loss due to the damage, ruination, etc. of safety information or any loss arising from registered safety information.

■ Using Early Warning Mail

Early warning mail is a service to collectively deliver earthquake early warnings and tsunami warnings provided by the Japan Meteorological Agency and disaster/evacuation information provided by the national government or the local governments to au phones in the specified areas.

At the time of purchase, receiving setting of early warning mail (earthquake early warnings and disaster/evacuation information) is set to “受信する” (Receive). You can receive tsunami warnings by setting 災害・避難情報 (Disaster/Evacuation information).

When receiving an earthquake early warning, secure your safety and act composedly according to the surrounding situations.

When receiving a tsunami warning, leave sea coasts immediately and evacuate to safe places such as hills and strongly-built tall buildings.

1 From the au disaster countermeasure menu, [緊急速報メール] (Early warning mail).

The inbox is displayed.

Select a mail to check to display the details of the mail.

削除

(Delete)

Delete received mails.

設定 (Settings)	緊急地震速報 (Earthquake early warning) Set whether to receive earthquake early warnings. • Tap [受信する] (Receive)/[受信しない] (Not receive) → [OK]. 災害・避難情報 (Disaster/Evacuation information) Set whether to receive disaster/evacuation information and tsunami warnings. • Tap [受信する] (Receive)/[受信しない] (Not receive) → [OK]. 音量 (Volume) Set the volume of the receiving sound. バイブ (Vibrator) Set whether to activate the vibrator at the time of reception. マナー時の鳴動 (Linkage to the manner mode) Set whether to notify you with the manner mode settings applied in the manner mode. 緊急地震速報 (Earthquake early warning) Check the operations of the receiving sound and vibrator for earthquake early warnings. 災害・避難情報 (Disaster/Evacuation information) Check the operations of the receiving sound and vibrator for disaster/evacuation information and tsunami warnings.
------------------	---

memo

- This service is available only in Japan (Not available overseas).
- Early warning mail is free of both information charges and communication charges.
- Early warning mails cannot be received while the power is turned off or during a call.
- Early warning mails may not be received during communication such as while sending and receiving SMSs (C-mails)/e-mails and while using the browser or when you are in a place where the signal cannot be received (e.g. tunnels and basements) or the signal is weak, even within the service area.
- Early warning mails which failed to be received will not be able to be received again.
- When you receive an early warning mail, the dedicated alarm tone rings. The alarm tone cannot be changed.

- Information intended for the areas of other than your present location may be received.
- As for this service, the Company shall not be liable for any damage incurred on the users resulted from failure or delay of information delivery due to communication disturbance or system failure, contents of the information or other problems that are not supposed to be blamed on the Company.
- For details on earthquake early warnings and tsunami warnings provided by the Japan Meteorological Agency, refer to the agency's homepage.
<http://www.jma.go.jp/>

Earthquake early warning

- Earthquake early warning notifies areas where a strong shaking (Japan seismic scale 4 or more) is expected when an earthquake whose maximum Japan seismic scale is predicted of 5-lower or more has been detected.
- This service detects an earthquake (P-wave, preliminary tremors) near the seismic center immediately after the earthquake occurs and automatically calculates its location, scale and predicted strength of the shaking. After that, you will be notified of the earthquake as soon as possible within a few seconds to dozens of seconds before a strong shaking from the earthquake (S-wave, principal shock) occurs.
- In the vicinity of the seismic center, a strong shaking may reach you before an earthquake early warning.
- The earthquake early warning distribution system provided by this service is different from that provided by TV, radio and other communication media and thus the arriving time of earthquake early warnings may be different among those media.

Tsunami warning

- Tsunami warning notifies areas including target sea coasts of tsunami warnings (major tsunami and tsunami) provided by the Japan Meteorological Agency.

Disaster/Evacuation information

- Disaster/Evacuation information notifies information related to the safety of citizens, such as evacuation advisories, evacuation orders or various alarms delivered by the national government or the local governments.

Using Disaster Voice Delivery Service

Disaster Voice Delivery Service is a service to record voices with a smartphone and deliver them as a voice message to people to whom you want to deliver the information that you are safe when large-scale disasters occur.

From the au disaster countermeasure menu, [災害用音声お届けサービス] (Disaster Voice Delivery Service).

Sending voices (Send)

Tap “声をお届け” (Send voices) and operate in order of “①お届け先を選択” (Select to whom to send) → “②お届けしたい声を録音” (Record voices to send).

* You can also select to whom to send your voices from the address book.

Receiving voices (Receive)

You will be notified via a pop-up screen or an SMS (C-mail) that a voice message has been received. You can listen to the message by receiving (downloading) and playing the voice message.

- If the receivers are using a smartphone on which an au Disaster Countermeasure application supporting Disaster Voice Delivery Service is not enabled or using an au cell phone, they will be notified via an SMS (C-mail).
- If the receivers are notified via an SMS (C-mail), the information will not be saved in the au Disaster Countermeasure application.

memo

- Sending and receiving voice messages are available only when you are using 3G network. Disable wireless LAN (Wi-Fi®) communication etc. before use.
- Voice messages can be recorded for up to 30 seconds.
- Voice messages can be exchanged only among au cell phones (interoperation with other carriers' cell phones will be available from the spring of 2013).
- Voices may not be heard when the media sound volume is set to low or the manner mode is set.
- When a microSD memory card is not inserted or no free space is left on the main unit (memory) or microSD memory card, voice messages may not be saved or played.
- Some cell phones cannot receive voice messages. For details, refer to the au homepage.

Contents

Preface	ii
Operating Instructions	ii
Safety Precautions.....	ii
When Using the Product	1
Cell Phone Etiquette	1
List of Packaged Items	2
Using au Disaster Countermeasure Application	2
Contents	5

Safety Precautions

Illustrations and Descriptions in This Manual ...	7
Exemptions	8
Safety Precautions (Observe Strictly)	8
Handling Precautions.....	17
Available Security Codes.....	21
Security Codes	21
Functions to Protect Your Privacy.....	21
PIN Code	21
Notes on Waterproof and Dustproof Properties	22
Notes on Using Bluetooth®/Wireless LAN (Wi-Fi®) Functions	27
Frequency Band.....	27
Precautions about Bluetooth®.....	27
Precautions about Wireless LAN (Wi-Fi®).....	28
Notes on Packet Communication Charge	29
Notes on Google Play/au Market/Applications	29

Getting Ready

Names and Functions of Parts	30
------------------------------------	----

Attaching/Removing the Battery Pack	32
Attaching the Battery Pack.....	32
Removing the Battery Pack.....	33
Using a Strap	34
Using the micro au IC-Card	34
micro au IC-Card.....	34
Attaching the micro au IC-Card	35
Removing the micro au IC-Card	36
Using a microSD Memory Card.....	36
microSD Memory Card.....	36
Attaching a microSD Memory Card	37
Removing the microSD Memory Card	38
Charging.....	38
Charging	38
Charging with the Desktop Holder and the Specified AC Adapter (Sold Separately)	39
Charging with the Specified AC Adapter (Sold Separately)/Specified DC Adapter (Sold Separately)	40
Charging with a PC	41
Turning the Power On/Off.....	42
Turning the Power On	42
Turning the Power Off	42
Restarting the Product	42
Sleep Mode	42
Welcome Sheet(Lock Screen)	43
Switching the Display Language to English.....	43

Basic Operations

Using the Touch Panel.....	44
Using the Touch Keys.....	45
Using the 3-Line Home	45
Viewing the 3-Line Home	45
Using Menu on the Home Screen	46
Main Application List.....	47
Using the Status Bar	48
Icons.....	48
Using the Notification/Status Panel	50

Character Input

Switching Software Keyboards	51
Viewing the Character Input Screen.....	51
Character Input Method.....	53
Entering Characters	53
Switching Character Input Modes	53
Entering Emoji/Symbol/Facemark	54

Phone

Making Calls	55
Entering a Phone Number and Making a Call	55
Using Menu on the Phone Number Entry Screen	57
Operations on the Call Screen.....	57
Calling Overseas from au Phones (au International Call Service).....	57
Receiving Calls	58
Answering an Incoming Call	58
Putting a Call on Hold	58
Sending SMS (C-mail) to an Incoming Call	58
Using Menu While Receiving a Call.....	59
Checking Your Phone Number	59
Checking Your Profile	59

Settings

Displaying Setting Menu	60
-------------------------------	----

Appendix/Index

Appendix	61
Introduction of Related Accessories.....	61
Using Earphones	62
Using an Earphone/Microphone with Switch or Earphone/Microphone	62
Troubleshooting.....	63
Updating Software or OS.....	64

Mobile Update (Software Update) 64

Major Update (OS Update)..... 66

After-Sales Service 66

Available Data Formats 68

Main Specifications..... 69

Specific Absorption Rate (SAR) of Cell Phones
 71

CE Declaration of Conformity 72

FCC Notice 74

Export Administration Regulations 75

Intellectual Property Rights 75

Index..... 80

Illustrations and Descriptions in This Manual

Note on Key Illustrations

In this manual, the key illustrations are simplified as shown below.

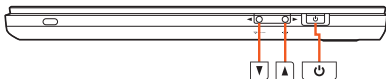

Description of Operations for Selecting Item/Icon/Key etc.

In this manual, operation procedures are described as below.

Description	Explanation
On the home screen, [APPS] → [Phone] → Enter "141" → [Call].	Tap [APPS] at the top of the home screen and tap [Phone]. Then tap in order of [1..], [4] and [1..]. Lastly, tap [Call].
[Power] (hold down for at least 2 seconds)	Hold [Power] down for at least 2 seconds.

* Tapping is to select a key or icon displayed on the screen by lightly tapping it with your finger.

Notes on Illustrations/Screenshots

The screenshots in this manual are simplified and may look different from the actual screens. Also, part of the screen may be abbreviated.

Actual screen



In this manual

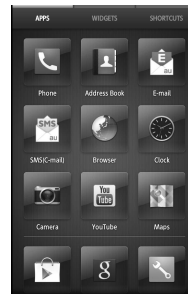

In this manual, part of the screen such as icons are abbreviated.

memo

- Explanations of this manual are based on the case when the product is held vertically. If you hold it horizontally, menu items/icons/on-screen keys etc. may be different.
- Menu items, layers and icons described in this manual may be different according to functions being used and conditions.
- "microSD™ memory card", "microSDHC™ memory card" and "microSDXC™ memory card" are abbreviated as "microSD memory card" or "microSD".

Exemptions

- The Company is not liable for any damages arising from earthquakes, lightning, storms, floods or other natural disasters, as well as fires, actions by third parties, other accidents, intentional or mistaken operation by the customer, or use under other unusual conditions outside the responsibility of the Company.
- The Company is not liable for any incidental damages (change/disappearance of saved content, loss of business income, disruption of business, etc.) arising from use of or inability to use the product.
It is recommended that you keep a copy of important phone numbers etc.
- The Company is not liable for any damages arising from failure to observe the described content of this manual.
- The Company is not liable for any damages arising, for example, from malfunction caused by combination with connected devices or software not related to the Company.
- Captured image data or downloaded data may sometimes be altered or lost due to faults, repair or other handling of the product. The Company is not liable for any damage or lost income resulting from recovery of these data.
- It is recommended you keep a copy of important data in your PC's hard disk, etc. Whatever the cause of fault or malfunction may be, the Company assumes no responsibility for alteration or loss of saved information.
- *The Company* as appears on the product refers to the following companies:
Sold by: KDDI CORPORATION, Okinawa Cellular Telephone Company
Manufactured by: SHARP CORPORATION

memo

- Reproduction of the content of this manual in part or in whole is prohibited.
- The content of this manual is subject to change without notice.
- Every effort has been made in the preparation of this manual. Should you notice any unclear points, omissions, etc., feel free to contact us.



Safety Precautions (Observe Strictly)

- **Before using the product, thoroughly read these safety precautions for proper use. After reading, store the precautions in a safe place.**

These "Safety Precautions" describe instructions that should be observed to prevent damage to property or injury to the customer or others using the product.

These instructions are divided into the following categories.

■ Explanation of Indications Used in This Manual

 DANGER	This symbol indicates the potential and imminent danger of death or serious injury ^{*1} to a person.
 WARNING	This symbol indicates the possibility of death or serious injury ^{*1} to a person.
 CAUTION	This symbol indicates the possibility of personal injury ^{*2} to a person or physical damage ^{*3} .





*1 Serious injury: This refers to loss of sight, injury, burns (high- and low-temperature), electric shock, broken bones, injuries with residual aftereffects from poisoning, etc., or injuries requiring hospital admission for treatment or long-term hospital attendance as an outpatient.

*2 Injury: This refers to injuries, burns (high- and low-temperature), electric shock, etc. that do not require hospital admission for treatment or long-term hospital attendance as an outpatient.

*3 Physical damage: This refers to extended damage to buildings, furniture, livestock or pets.

■ Explanation of Graphic Symbols Used in This Manual

 Prohibited	Indicates an action that is not allowed.
--	--

	Indicates that handling with wet hands is not allowed.
	Indicates that disassembly is not allowed.
	Indicates that use in a place where the product is likely to get wet or allowing the product to get wet is not allowed.
	Indicates an action that must be done.
	Indicates that the power plug must be disconnected from the power outlet.

■ Precautions Common to the Main Unit, Battery Pack, Charger, micro au IC-Card, Peripheral Devices



DANGER

Be sure to read the following hazards before use.



Instruction

Be sure to use only the specified peripheral devices. Use of other peripheral devices might cause overheating, ignition, rupture, fault, or leakage of liquid.



Prohibited

Do not use, store or leave the product in hot places (e.g. by the fire, near a heater, under a kotatsu, in direct sunlight, in a car in the hot sun). Doing so might cause ignition, rupture, fault, fire or injury.



Instruction

Before entering an area where flammable gas is generated such as a gas station, be sure to turn off the product. Do not charge the battery. Failure to observe these precautions might cause the gas to catch fire. In addition, when using NFC/Osaifu-Keitai® payment function at a gas station, be sure to turn off the power in advance. (If NFC/Osaifu-Keitai® has been locked, cancel the lock before turning off the power.)



Prohibited

Do not put the product in a cooking apparatus such as microwave oven or a pressure vessel. Doing so might cause leakage of liquid, ignition, rupture, fault, fire or injury.



Prohibited

Do not throw the product into a fire or heat it. Doing so might cause ignition, rupture or fire.



Prohibited

Do not short-circuit the charger terminal, the external connection jack and the earphone/microphone jack. Do not allow conductive foreign objects (metal fragments, pencil leads, etc.) to come into contact with or get inside a terminal/jack. Doing so might cause fire or a fault.



Prohibited

When using a metal accessory, do not allow the metal part come in contact with the connection jack or power outlet. Doing so might cause electric shock, ignition, injury or a fault.



Prohibited

Do not expose the camera lens to direct sunlight for an extended period. Doing so might cause ignition, rupture or fire by the light-collecting mechanism of the lens.



Disassembly prohibited

The customer is not allowed to disassemble, modify or repair the product. Doing so might cause a fault, ignition, electric shock, or injury. The Company is not liable even in the event of any nonconformities arising on the product or peripheral devices as a result of modification, etc. Modification of the product is in violation of the Radio Law.



WARNING

Be sure to read the following warnings before use.



Prohibited

Do not drop or subject to strong impact, such as throwing. Doing so might cause rupture, overheating, ignition or a fault.



Prohibited

Do not use outside when you can hear thunder. Doing so might risk lightning strikes and electric shock.



Prohibited

Do not let your hands, fingers and other parts of the body touch the external connection jack or earphone/microphone jack. Doing so might cause electric shock, injury or a fault.



Prohibited

If the product is damaged because it is dropped or something, and its display is cracked or internal parts are exposed, do not touch the cracked display or exposed parts with your hands. Doing so might cause electric shock or injury from damaged parts. Contact an au shop or Secure cell phone support center.



Wetting with water prohibited

Although the product model has waterproof property, stop use if liquid such as water gets inside the main unit from the external connection jack cover or the battery cover. Continued use of the product in this state might cause overheating, ignition or a fault.



Prohibited

When removing the battery cover, do not exert more than necessary force. The battery pack might jump out, for example, and cause injury or a fault.



Prohibited

Do not operate the product while driving an automobile or motorized bicycle, riding a bicycle or walking. Doing so may compromise traffic safety and cause an accident.



Instruction

If charging is not completed after the specified charging time, stop charging. Failure to do so might cause leakage of liquid, overheating, rupture or ignition.



Prohibited

Do not leave in places within the reach of small children. Small children might swallow part of the equipment by mistake and choke on them, or might drop them by mistake and cause accidents or injury.

**CAUTION**

Be sure to read the following cautions before use.



Prohibited

Do not store the product in places subject to direct sunlight (e.g. in automobiles), places that get hot, places that get extremely cold, and in humid or dusty places. Doing so might cause overheating, ignition, deformation or a fault.



Prohibited

Do not leave on unstable places such as rocky stands or tilting surfaces. Dropping the product may cause injury or damage. Be especially careful while the vibration is set. Also, pay sufficient attention to impact, etc.



Prohibited

Do not cover or wrap the product with bedding, etc. while using or charging the product. Doing so might cause fire, fault or injury.



Prohibited

Do not touch the main unit, the battery pack or specified chargers (sold separately) for a long time while power is being supplied from an external source. Doing so might cause low-temperature burns.



Instruction

The product may become hot by prolonged use especially in high-temperature environment. Be careful when using the product touching your skin for a long time, as it might cause low-temperature burns.



Prohibited

Do not use power outlets or wiring apparatus beyond its rating. Also, exceeding rating, for example, by connecting multiple devices to a single power strip might cause overheating and fire.



Prohibited

Do not use the product with the battery cover removed.



Prohibited

Do not place near corrosive chemicals or in places where corrosive gas is generated. Doing so might cause a fault or loss of internal data.



Prohibited

Do not leave or store with the battery cover removed from the main unit. Doing so might allow dust or other foreign objects to get inside and cause a fault.



Instruction

Stop use if there is smoke, abnormal odor or noise, excessive overheating, or other abnormalities. During charging, disconnect the specified charger (sold separately) from the power outlet or the socket, make sure that the product is not overheating before turning the power off, remove the battery pack and contact an au shop or Secure cell phone support center. Also, if you have dropped or damaged the product, do not continue to use it in that state, and contact an au shop or Secure cell phone support center.



Instruction

When inserting an earphone, etc. into the product, adjust the volume to the proper level. Setting too loud a volume or using the earphone continuously for a long period of time might adversely affect your ears. Also, raising the volume too high might prevent you from hearing sounds around you, which might in turn lead to a traffic accident at a railroad crossing or pedestrian crossing.



Instruction

When adjusting the volume with an earphone, etc. inserted into the product, raise the volume a little at a time. If you raise the volume too much from the outset, sudden loud noise from the earphone, etc. might adversely affect your ears.



Instruction

When using a charger or external device, insert/remove the connector straight to/from the jack. Make sure the orientation of the connector is correct. Failure to do so might cause damage or a fault.



Prohibited

When removing the battery cover, do not insert a sharp tipped object. Doing so may damage or deform the battery cover, resulting in fault because of water intrusion.



Instruction

When small children use the equipment, have the guardian teach them the proper handling procedures so as to avoid potential dangerous situations. In addition, check that they are using the equipment as directed during use. Failure to do so might cause injury etc.

■ Main Unit



WARNING Be sure to read the following warnings before use.



Prohibited

Do not use a cell phone while driving a car or riding a motorbike or bicycle. It may cause a traffic accident. Use of a cell phone while driving a car or motorbike is prohibited by law. Use of a cell phone while riding a bicycle may be punishable by some regulations.



Prohibited

Do not turn off the product while you are aboard an airplane. Otherwise, the product may affect electronic devices and safety of your flight may be compromised. If your cell phone is permitted to be used on an airplane, use it appropriately by following instructions from the airline company. Do not connect the product with a PC aboard an airplane using the microUSB cable 01 (sold separately), since the product is automatically turned on.



Instruction

The product sometimes affects high-precision electronic devices. So, turn it off near such devices. (Examples of electronic devices that might be affected by the product include cardiac pacemakers, hearing aids, other electronic medical devices, fire alarms, and automatic doors. If you are using an electronic medical device, contact the device manufacturer or retailer for information about the possible effects of radio waves.)



Instruction

When using the product near an implanted pacemaker, implanted cardioverter-defibrillator or other electronic medical device, radio waves might affect these units and devices. So, please observe the following.

1. Those with an implanted pacemaker or implanted cardioverter-defibrillator should carry or use the product at least 22 cm away from the pacemaker or cardioverter-defibrillator.
2. Turn the product off in crowded trains or other crowded places, since there may be people with a cardiac pacemaker or implanted cardioverter-defibrillator nearby.
3. Pay attention to the following points when using the product inside medical institutions.
 - Do not bring the product into operating theaters, intensive-care units (ICU) and coronary care units (CCU).
 - Turn the product off in hospital wards. Do not connect the product with a PC in hospital wards using the microUSB cable 01 (sold separately), since the product is automatically turned on.
 - Even if you are in a lobby, etc., be sure to turn the product off when there are electronic medical devices nearby.
 - When a medical institution has laid down designated areas where use of the product is prohibited or is not allowed to be brought in, abide by the instructions of that medical institution.
4. When using electronic medical devices other than an implanted pacemaker and implanted cardioverter-defibrillator outside a medical institution (e.g. home medical treatment), check individually with the manufacturer of the electronic medical device regarding the influence of radio waves.



Prohibited

Do not forget to stay alert to your surroundings when calling, messaging, browsing the Internet, shooting photos, playing games, watching TV (1Seg) or listening to music. Failure to do so might cause a fall or traffic accident.



Prohibited

Do not send data by infrared communication with the infrared port pointing toward eyes. Doing so might affect eyes. Also, sending data with the infrared port pointing toward some other infrared device might cause false operation, etc.



Prohibited

Do not point the illuminated light directly at someone's eyes. Be especially careful not to shoot small children from a very close distance. Do not use Mobile light near people's faces. Eyesight may be temporarily affected leading to accidents. Precautions:

The mobile light source used for the product may emit the light over the safety level for eyes when operations such as undirected adjustments are intentionally made. Therefore, do not disassemble the product.

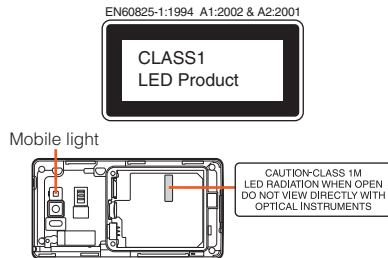

Prohibited

Do not light the mobile light toward a driver of a car, motorbike or bicycle. If dazzled by the light, the driver might become unable to drive and cause an accident.



Instruction

Sometimes, very rarely some people demonstrate symptoms such as temporary muscle spasms, loss of consciousness, etc. by watching repeatedly flickering screens. Those with a past history of this should consult with a physician beforehand.

**CAUTION**

Be sure to read the following cautions before use.



Instruction

Use of the main unit in an automobile sometimes affects on-vehicle electronic devices, though this rarely happens. If this happens, stop use since this may impair safe travel.



Instruction

If you feel any abnormality with your skin, immediately consult a dermatologist. Itching, rashes, eczema, etc. sometimes occurs depending on your physical constitution and condition.

The materials of parts used on the product are as follows.

Part	Material	Surface treatment
Outer case (display frame part)	PA resin	Acrylic UV cured coating (tin-based deposition)
Earpiece	ABS resin	None
Outer case (side)	PA resin	Acrylic UV cured coating
Battery cover	PC resin	Acrylic UV cured coating
External connection jack cover	PC resin Elastomer resin	Acrylic UV cured coating None
Earphone/Microphone jack	PA resin	None
TV antenna	PA resin SUS Nickel-titanium alloy	None None None
Power key	PC resin	Acrylic UV cured coating (tin-based deposition)
Volume up/down key	PC resin	Acrylic UV cured coating
Display	Hardened glass (Shatterproof sheet of surface: PET)	Acrylic hard coating
Camera lens decoration	Acrylic resin	Hard coating
Infrared port cover	Acrylic resin	Hard coating
Mobile light lens	ABS resin	None
Charger terminal	SUS	Gold plating

The materials of parts used on the desktop holder are as follows.

Part	Material	Surface treatment
Outer case (front/rear)	ABS resin	None
Switching knob	POM resin	None
Contact lever	POM resin	None
Contact terminal	Phosphor bronze	Gold plating
Connection jack (microUSB)	SUS	Tin plating
Screw	Carbon steels for cold heading	Trivalent chromate
Rubber leg	Polyurethane resin	None
Locking lever (left/right)	POM resin	None



Prohibited

Do not bring the product close to magnetized objects such as cash cards, floppy disks, credit cards, and prepaid cards. Doing so might result in loss of recorded information.



Prohibited

Do not allow liquids, metal objects, burnable items, and other foreign matter to get inside the microSD memory card slot. Doing so might cause fire, electric shock or a fault.



Prohibited

Do not swing the product around by holding the strap, TV antenna, etc. Doing so might cause an accident or damage.



Instruction

Use the product with the covers of external connection jack, etc. closed. If the covers are open, dirt or water may get inside causing a fault.



Instruction

Stow the TV antenna when not watching TV (1Seg). If you operate the product for calling, etc. with the TV antenna extended, it might cause unexpected injury by hitting your face, etc.



Instruction

If you have a weak heart, be careful when setting the incoming vibration and ringtone volume to prevent adverse effects on your heart.



Instruction

Pay attention to items becoming stuck to the main unit. The speaker uses magnets, and so thumbtacks and pins, craft knife blades, staples, and other metal objects sometimes become stuck to the main unit, and cause unexpected injury. Before using the product, be sure to check that there are no foreign objects on the speaker or other parts.



Instruction

Be careful not to put the product directly on sand at a beach, etc. Sand or other small particles might get inside the earpiece, mouthpiece, speaker or earphone/microphone jack causing the volume to drop. If sand gets inside the product's main unit, it might cause overheating or a fault.



Instruction

When using the product for calling or data communication, be careful not to keep the product in direct contact with your skin for a prolonged period, or not to cover the product with paper, cloth, bedding, etc. The main unit might get hot, causing fire, burns or a fault.



Prohibited

Do not use the product in a crowded place. Doing so may cause others to be hit by the cell phone, resulting in an unexpected injury.



Prohibited

Do not swing the product with the TV antenna pulled out. Doing so may cause injury or deform or damage the TV antenna.

Battery Pack



(The battery pack of the product is a lithium-ion battery.)

The battery pack is not fully charged at the time of purchase. Charge the battery before using the product.

**DANGER****Be sure to read the following hazards before use.**

Prohibited

Do not short-circuit the contact terminal of the battery pack.



Prohibited

Do not fail to connect the battery pack to the product in the correct orientation. Connecting in an incorrect orientation might cause rupture, fire or overheating. Do not try to forcibly connect the battery pack, instead thoroughly check the contact terminal before connection.



Prohibited

Do not puncture the battery pack with a nail, hit it with a hammer or step on it. Doing so might cause leakage of liquid, overheating, rupture or ignition.



Prohibited

Do not allow metal objects (such as necklaces and hairpins) to come in contact with the contact terminal when carrying or storing the battery pack. Doing so might cause fire or a fault due to a short circuit.



Disassembly prohibited

Do not disassemble, modify or directly solder the battery pack. Doing so might cause overheating, ignition or rupture.



Prohibited

Do not use a battery pack that has been dropped, stepped on, damaged, or leaking battery liquid. Immediately move the battery pack away from fire if you notice leakage of liquid or unusual odor. Failure to do so might cause the leaked liquid to catch fire resulting in ignition or rupture.



Wetting with water prohibited

Do not wet the battery pack with water, seawater, pet urine, etc. A wet battery pack might cause overheating, rupture or ignition. If you drop the product into water by mistake, immediately turn off the power, remove the battery pack, and contact an au shop or Secure cell phone support center. Never charge the wet battery pack.



Instruction

If the liquid leaking from inside gets on your skin or clothes, immediately rinse it off with water to avoid injury. If the liquid gets into your eyes, do not rub but wash your eyes with water, and immediately consult a doctor to avoid the risk of losing your eyesight.



Instruction

The battery pack is a consumable item. If the performance of a battery pack does not recover (e.g. the usable time after each charge has become extremely short), the battery pack is at the end of service life, so stop use and buy a new one of the specified type. Failure to do so might cause overheating, ignition, rupture or leakage. Note that the length of service life varies depending on the usage condition, etc.



Instruction

Be careful not to have the battery pack bitten by your pet. It might cause leakage, overheating, rupture or ignition.



Instruction

When removing the battery pack from the product, always hold the PULL tab or protruding edge and pull it upward. Attempting to remove the battery pack by inserting a sharp tipped object such as a pen may cause ignition or damage.

Charger**WARNING****Be sure to read the following warnings before use.**

Prohibited

Do not use at other voltages than the specified power supply voltage. Doing so might cause ignition, fire, overheating, or electric shock.

- Common AC adapter 01 (sold separately): 100 V AC (for domestic use in Japan)
Do not charge with single-phase 200 V or voltage converters for overseas travel.
- AC adapter available overseas other than the adapters above: 100 V AC to 240 V AC
- DC adapter (sold separately): 12/24 V DC (for negative grounded vehicles only)



Instruction

Firmly insert the power plug of the specified charger (sold separately) into the power outlet or cigarette lighter socket down to the base of its pins. Incomplete insertion of the power plug might result in electric shock or fire caused by overheating and ignition. Do not use damaged specified charger (sold separately) or loose power outlets or cigarette lighter sockets.



Instruction

If the fuse in the common DC adapter 01/03 (sold separately) blows, replace it with a fuse of the specified type (250 V, 1 A). Replacing with a different type of fuse might cause overheating or ignition. (For information about fuse replacement, carefully read the manual for the common DC adapter 01/03 (sold separately).)



Prohibited

Do not damage, modify, twist, pull or place a heavy object on the cable of the specified charger (sold separately). Do not use a damaged cable. Doing so might cause an electric shock, short circuit or fire.



Prohibited

Do not let your hands, fingers and other parts of the body touch the charger terminal. Doing so might cause electric shock, injury or a fault.



Prohibited

If you hear thunder, do not touch the power plug. Doing so might cause an electric shock as a result of a lightning strike.



Disconnect plug from power outlet

Before cleaning the specified charger (sold separately), unplug its power plug from the outlet or cigarette lighter socket. If the plug remains plugged in when you clean the charger, it might cause an electric shock or short circuit. Also, wipe off dust on the power plug of the specified charger (sold separately). If the plug is left covered with dust, it might cause fire.



Instruction

Wipe off dust on the power plug. Failure to do so might cause fire, burns or electric shock.



Instruction

Install and position in-car devices where they do not hinder driving or safety equipment such as airbags. Failure to do so might cause a traffic accident. Install in-car devices following the instructions of their manuals.



Disconnect plug from power outlet

When the charger is not to be used for a long time, disconnect the charger's power plug from the power outlet or cigarette lighter socket. Failure to do so might cause electric shock, fire or a fault.



Wetting with water prohibited

The desktop holder and specified charger (sold separately) are not waterproof. Never use in places subject to direct splashing with water, pet urine, etc. or in humid places such as a bathroom. Doing so might cause overheating, fire or electric shock. In the event that a charger is splashed with liquid, immediately disconnect its power plug.



Prohibited

Do not use the desktop holder inside a car. Doing so may cause an accident because driving could be hindered.

**CAUTION****Be sure to read the following cautions before use.**

Wetting with water prohibited

Do not use in humid places such as bath areas. Doing so might cause electric shock or a fault.



Wet hands prohibited

Do not plug or unplug the specified charger (sold separately) with wet hands. Doing so may cause electric shock or fault.



Instruction

Charge the battery in a stable place. If placed on an inclined surface or wobbly stand, the product might fall causing injury or damage. Be especially careful while the vibration is set. In addition, do not cover or wrap a charger with a cloth or bedding. Doing so might cause fire or a fault.



Disconnect plug from power outlet

When unplugging the power plug of the specified charger (sold separately) from the outlet or cigarette lighter socket, hold the charger to do so. If you pull the cable, it might be damaged, causing overheating, ignition or electric shock.



Prohibited

Do not use the common DC adapter 01/03 (sold separately) with the car engine stopped. Doing so might result in draining of the car battery.



Prohibited

Do not leave the specified charger (sold separately) connected to the main unit with the battery pack removed. Doing so might cause ignition or electric shock.



Prohibited

When you use the desktop holder to charge, do not connect it to the external connection jack of the main unit. Doing so may cause not only failure to properly charge the battery but also fault.

micro au IC-Card



WARNING

Be sure to read the following warnings before use.



Prohibited

Do not put the micro au IC-Card in a cooking apparatus such as a microwave oven or a pressure vessel. Doing so might cause melting, overheating, fuming, loss of data or a fault.



CAUTION

Be sure to read the following cautions before use.



Instruction

Be careful not to injure your hand or finger when attaching/removing the micro au IC-Card.



Instruction

Use only the devices specified by the Company to insert the micro au IC-Card in. Using a device not specified by the Company might cause loss of data or a fault.
For the specified devices, contact an au shop or Customer Service Center.



Disassembly prohibited

Do not disassemble or modify the micro au IC-Card. Doing so might cause loss of data or a fault.



Prohibited

Do not use or leave the micro au IC-Card in hot places such as by a fire or a heater. Doing so might cause melting, overheating, fuming, loss of data or a fault.



Prohibited

Do not throw the micro au IC-Card into a fire or heat it. Doing so might cause melting, overheating, fuming, loss of data or a fault.



Prohibited

Do not touch the IC (metal) part of the micro au IC-Card or short-circuit it. Doing so might cause loss of data or a fault.



Prohibited

Do not drop the micro au IC-Card or subject it to strong impact. Doing so might cause a fault.



Prohibited

Do not fold, bend or place a heavy object on the micro au IC-Card. Doing so might cause a fault.



Wetting with water prohibited

Do not wet the micro au IC-Card. Doing so might cause a fault.



Prohibited

Do not scratch the IC (metal) part of the micro au IC-Card. Doing so might cause a fault.



Prohibited

Do not store the micro au IC-Card in dusty places. Doing so might cause a fault.



Prohibited

Do not store the micro au IC-Card in places exposed to direct sunlight or hot and humid places. Doing so might cause a fault.



Instruction

Store the micro au IC-Card out of reach of small children. Accidental swallow might cause suffocation, injury, etc.

Handling Precautions

These precautions are provided to ensure that performance can be fully demonstrated.

Thoroughly read these precautions to ensure correct use.

■ Precautions common to the main unit, battery pack, charger, micro au IC-Card, peripheral devices

- Do not apply excessive force to the product during use. Be sure not to put the product into a tightly packed bag or place a heavy object on the product in a bag. Sitting on the product in your pocket might damage the display or internal circuit board resulting in a malfunction.

Keeping an external device connected to the external connection jack might damage the connector resulting in a malfunction. Such damage and malfunction are not covered by the warranty, even if there is no external damage.

- To ensure waterproof property (equivalent to IPX5 and IPX7) of the product, use the product with the battery cover and external connection jack cover tightly closed.

Note that the waterproof property is not guaranteed in every usage condition. Do not allow water to get inside the product or splash water on the battery pack, charger or optional accessories. Do not attach/remove the battery cover or open/close the external connection jack cover in the rain or with water drops on the surface of the product. Doing so might cause water intrusion resulting in internal corrosion.

Malfunctions determined to be caused by water intrusion are not covered by the warranty.

- Do not use the product in extremely hot, cold or humid places. (Use within an ambient temperature range of 5°C to 35°C and humidity range of 35% to 85%. Using at a temperature of 36°C to 40°C is allowed only when you use in a bathroom etc. temporarily.)

- Do not use in places subject to lots of dust or vibration.

- Clean the charger terminal, external connection jack, earphone/microphone jack on the main unit and connection jack on the desktop holder with dry cotton swabs, etc. every now and then. A soiled terminal/jack might cause poor connection. When cleaning it, do not exert a strong force to clean it to prevent deformation.

- Clean the product with a soft dry cloth (such as the type used for eyeglasses). Forceful rubbing with a dry cloth may scratch the display. The display may be stained if splash or smear is left attached to the surface. Wiping the product using alcohol, thinner, benzene, detergent, etc. might erase the printing on the outer casing or cause discoloration.

- Use as far away as possible from fixed-line phones, TVs and radios. Use nearby might affect them.

- The product may become warm while charging or during other operations, depending on the situation, but this is not abnormal.

- Turn off the power of the main unit before removing the battery pack. If you remove the battery pack with the power on, saved data might be altered or lost.

- When the temperature of the product gets high during use, the product may temporarily lower the screen brightness or may stop part of its functions to protect the main unit.

■ Main unit

- Do not forcefully press, tap or intentionally subject the display to strong impact. Doing so might cause scratching or damage.

- Do not forcefully press your fingernails, sharp objects or hard objects against keys or display surface. Doing so might cause scratching or damage.

The touch panel is designed to be lightly touched by fingers. Do not apply strong pressure with your fingers or sharp-pointed objects (such as fingernails, ballpoint pens and pins) on the touch panel.

In the following cases, the product may not respond to touching the touch panel, or errors in operation may occur.

- Operation with gloved hands
- Operation with fingernails
- Operation with a foreign object placed on the touch panel
- Operation with a protective sheet or sticker on the touch panel
- Operation with water drops left or frozen on the surface
- Operation with wet or sweaty fingers
- Operation under water

- Do not remove the stickers printed with the serial numbers on the back of the battery pack that can be seen when it is removed. These stickers prove that the product and the communication module you are using comply with the Radio Law and Telecommunications Business Law.

- Never use modified au cell phones. Use of a modified device violates the Radio Law.
The product has acquired the certification of conformity with technical regulations for the specified radio station based on the Radio Law, and the "Technical Conformity Mark  " is printed on the nameplate of the product as a certificate.
If the screws of the product are removed and modifications are made to the internal components, the certification of conformity with technical regulations will become invalid. Never use the product without the valid certification. Doing so violates the Radio Law.
- To prevent unlawful modification, the product has been designed so that it cannot be easily disassembled. Modifying the product is prohibited by the Radio Law.
- Contents saved in the product, such as contacts, mails and bookmarks might be altered or lost by an accident, fault, repair or mishandling. Be sure to keep a copy of important contents. Note that the Company assumes no responsibility for any damages or lost profits resulting from altered or lost contents.
- Note that content data (both charged or free content) saved on the product cannot be returned to the customer when the product is replaced for repair of a fault, for example.
- The product uses liquid crystal for its display. The display response speed may become slow when the ambient temperature is low, which is due to the property of liquid crystal and not a malfunction. The display response speed will return to normal at room temperature.
- Although the display used on the product is made using high-precision technology, some pixels (dots) might be lit or out at all times. This is not a malfunction.
- Take care not to inconvenience people around you when you use the product in a public place.
- You are recommended to store copies of individual data such as still pictures you took, videos and music in your PC by sending each file as mail attachment, etc. Note, however, that you may not be able to make copies of some copyrighted data even by the above-mentioned means.
- Take care not to place magnetized items such as magnetic cards, speakers and TV sets near the product, as it might cause malfunction.
Putting strong magnetism close to the product might cause false operation.

- When you put the product in your pocket or bag, take care so that the display does not come in contact with metal objects or other hard objects, as it might cause scratching or damage. Also, be careful not to scratch or damage the display by using a strap whose metal or other hard part comes in contact with the display.
- When suddenly brought into a warm place from a cold place, or when in a humid location, or when used where temperature suddenly changes (e.g. near the air discharge port of an air conditioner), water drops (i.e. condensation) sometimes are formed inside the product. Note that when used under conditions such as this, humidity might cause corrosion or a fault.
- When wiping the display, wipe with a soft, dry cloth. Use of a moistened cloth, glass cleaner or other similar liquid might cause a fault.
- When connecting/disconnecting an external device to/from the external connection jack or earphone/microphone jack, make sure to insert/remove the connector or earphone plug of the external device straight to/from the jack.
- Note that applying unnecessary force with an external device connected to the external connection jack or earphone/microphone jack may cause damage.
- Do not discard the product together with regular trash. Please cooperate in the collection of the product when it is no longer needed to protect the environment and effectively use resources. Old products are collected at au shops and other places.
- Insert only a microSD memory card into the microSD memory card slot on the product.
- Do not exert excessive force when attaching/removing a microSD memory card. Doing so might injure your hands or fingers.
- While writing/reading data to/from a microSD memory card, do not subject the product to vibration or impact, remove the battery pack or turn off the power. Doing so might cause loss of data or a fault.
- When hearing the other party's voice, make sure that the earpiece is placed at the center of your ear. If the earpiece (audio output port) is closed by the ear lobe, it may be hard to hear the voice.
- Even if you cover the mouthpiece to make your voice inaudible to the other party, the other party can hear your voice.
- When using handsfree call, take care to keep the speaker at a safe distance from your ears, as the speaker volume may be too loud.

- Attach the battery cover securely. NFC/FeliCa function may not work properly. Also, if you deform the battery cover, forcefully press the inside of the battery cover on which the sheet is pasted or remove the sheet, NFC/FeliCa communications may be hindered.
- Do not cover the light sensor with your finger or put a sticker on it. Doing so may hinder the light sensor from detecting the ambient brightness and functioning correctly.
- Do not put a sticker, etc. on the proximity sensor. Doing so may cause the sensor to malfunction and make the display always turned off while receiving a call or during a call.
- If the display gets damaged, immediately stop use and contact an au shop or Secure cell phone support center. Keeping using it may cause injury.
- Putting a sticker, etc. on the display or a key may cause malfunction or shortened usage time. Also, doing so may damage the product.
- When answering a call while the TV antenna is pulled out or it is kept standing (e.g. while you are watching TV (1Seg)), take lots of care especially to the tip of the TV antenna so that it will not do any harm on surrounding people nor touch your own eye.
- If you put magnetized objects, metal straps, etc. close to the product, the speaker section sometimes emits sounds. This is not a fault.
- Note that if you forcefully pull external connection jack cover or apply excessive force on it, it may be damaged.
- When you put the product in your pocket or bag, do not forget to replace the TV antenna to its original position. Also, do not forcefully pull out or bend the TV antenna intentionally. Doing so may cause injury or damage.
- Bright places such as under the direct sunlight sometimes make it hard to see the display. This is not a fault.

■ Touch panel

- Use your finger to operate the touch panel. Do not use ballpoint pens, pencils or other sharp-pointed objects. Using such objects does not only hinder correct operation of the touch panel, but also might cause scratching or damage to the display.
- Do not put stickers or sheets (e.g. commercially available protective films, peep prevention sheets) on the display. Doing so might hinder correct operation of the touch panel.

- Do not operate the touch panel with fingernails. Doing so might result in split nails or jammed fingers.
- If the display surface is dirty or wet with sweat or water, it may not function correctly. In such case, wipe the display surface with a dry, soft cloth.
- When carrying the product in your pocket or bag, take care not to put the touch panel close to metals or other conductive materials, as it might cause false operation of the touch panel.

■ Battery pack

- Use in very hot or cold environments, for example, when left in an automobile with the windows closed in summer, will cause the battery capacity to drop and shorten the available battery usage time. This will also shorten the battery pack's service life. Try to use the battery pack as much as possible at room temperature.
- When the battery pack is not to be used for a long time, remove the battery cover and remove the battery pack from the main unit, and store it away from hot and humid places.
- Charge the battery before using the product for the first time after purchase, or if you have not used the product for a long time.
- The battery pack is a consumable item. If the performance of a battery pack does not recover after charge, the battery pack is at the end of service life, so buy a new one of the specified type. Note that the length of service life varies depending on the usage condition, etc.
- Do not discard battery packs together with regular trash. Please cooperate in the collection of used battery packs to protect the environment and effectively use resources. au shops and other retailers collect used battery packs.
- Battery packs sometimes swell up as they approach the end of their service life. This is due to the properties of lithium-ion batteries, and is not a problem in terms of safety.

■ Charger

- When not using the specified charger (sold separately), remove its power plug from the power outlet or the cigarette lighter socket.

- Do not wrap the power cord of the specified charger (sold separately) around the power plug or desktop holder. Doing so might cause electric shock, overheating or fire.
- Do not forcibly bend the charger's plug or the connection between the connector and power cord. Doing so might cause electric shock, overheating or fire.

■ micro au IC-Card

- The micro au IC-Card is lent to you by au. In case of loss or damage, the card will be replaced at your expense. When malfunction is suspected, or in case of theft or loss, contact an au shop or PiPiT.
- Do not forcibly remove or insert the micro au IC-Card. Be careful not to exert excessive force when inserting the card into your au cell phone.
- You are responsible for any damage caused by inserting your micro au IC-Card into some other IC card reader/writer, etc.
- The micro au IC-Card may become warm during use, but this is not a malfunction and you can continue to use the card.
- Keep the IC (metal) part of your micro au IC-Card clean. Wipe the card with a dry, soft cloth (such as for cleaning eyeglasses) for cleaning.
- Do not put stickers, etc. on the micro au IC-Card.
- Do not touch the IC (metal) part of the micro au IC-Card when inserting or removing it.

■ Camera

- When using the camera, follow common rules of etiquette regarding camera use.
- Image data might be altered or lost due to malfunction, repair or mishandling of the product. The Company takes no responsibility for recovery of altered or lost data, damages resulting from altered or lost data, and lost profits.
- When photographing important occasions (such as a wedding), take a trial shot and check the shot image to make sure it is correctly shot.
- Do not use the camera for recording commercially available books or information of which photographing is not allowed.

- Do not leave the camera lens exposed to direct sunlight. Imaging elements might be discolored or burnt.

■ Music, videos and TV (1Seg)

- Do not listen to music, watch videos or TV (1Seg) while driving a car or motorbike, or riding a bicycle. Use of cell phones while driving a car or motorbike is prohibited by law. (Use of cell phones while riding a bicycle may also be punishable by law.) In addition, stay alert to the traffic around you even when walking. Surrounding sounds might not be heard clearly, and gazing at the screen may distract your attention causing a traffic accident. Be especially careful at railroad crossings, platforms and pedestrian crossings.
- Take care not to listen at ear-splitting volume for a long time, as it might affect hearing.
- Be careful of sound leakage from earphones in trains or other places with many people around you.

■ Copyrights and rights of portrait

- If the data you shot or recorded using the product or part or whole of the data you downloaded from the Internet etc. is protected by the third party's copyright, you are not allowed to copy, distribute, publicly send, modify the data without consent of the copyright holder, except for personal use, under the copyright law.
In addition, do not use or modify portraits or names of other individuals without their consent, as it may infringe on rights of portrait.
Note that shooting and recording might be restricted at some live performances, shows and exhibitions even for personal use.
- Be careful about the copyright and portrait right when posting still pictures you shot, etc. on Internet homepages.

■ Backup content on the product

- Please back up important content recorded or downloaded to the product to an outside source. Content recorded to memory on the product sometimes disappears or is altered by unexpected factors, such as static electricity or a fault, repair, mishandling, etc.
 - * How to make backups: Store important data such as phonebook data, music, shot still pictures and videos on microSD memory cards. You can also send files as mail attachment or transfer to your PC. Note, however, that there are some data that cannot be copied by using these means.

Available Security Codes

Security Codes

The product has various security codes that you can use. The available security codes are as follows. Do not forget the various security codes that are set as they are necessary for various operations and contracts.

■ Security code

Example of usage	① To do remote operation of voice mail and call forwarding services from a landline phone ② To use Customer Service Center and to do various inquiries, applications, and modifications on the au homepage
Initial value	A four digit number chosen by the customer and noted on the application form

■ Security key

Example of usage	To set and release Restrict address book etc.
Initial value	1234

■ PIN Code

Example of usage	To prevent unauthorized use of the micro au IC-Card by third parties
Initial value	1234

■ Lock No. (NFC/Osaifu-Keitai lock)

Example of usage	To use the "NFC/Osaifu-Keitai lock"
Initial value	1234

Functions to Protect Your Privacy

The product has the following functions to protect the privacy of saved data.

- Lock folder

- NFC / Osaifu-Keitai lock
- Screen lock
- Restrict address book

PIN Code

■ PIN1 Code

To prevent unauthorized use of the micro au IC-Card by a third party, you can set the product to require PIN1 code entry every time the power is turned on. You also need to enter PIN1 code when setting whether PIN1 code entry is required.

If PIN code is incorrectly entered three times consecutively, the PIN code will be locked. You can unlock the PIN code using PUK code.

- PIN1 code is "1234" and PIN1 code entry is set to not be required at the time of purchase. You can change PIN1 code to any four- to eight-digit number, and set PIN1 code entry to be required as necessary.

■ PUK Code

In case PIN1 code is locked, you can unlock it by entering PUK code.

- PUK code is an eight-digit number given at the time of purchase, which is printed on the back side of the plastic card on which your micro au IC-Card is attached.
- After entering PUK code, you need to set a new PIN1 code.
- If PUK code is incorrectly entered ten times consecutively, contact an au shop, PiPit or Customer Service Center.
- "PIN1 code" is not reset by initializing the product.

memo

- When the PIN code is locked, the product may be restarted for the security reasons.

Notes on Waterproof and Dustproof Properties

Before using the product, thoroughly read the contents of “Notes on Waterproof and Dustproof Properties” to ensure correct use. Failure to follow the contents described in these sections may cause intrusion of water, sand or other foreign material, resulting in overheating, ignition, electric shock, injury or fault.

Proper operations of the product are not guaranteed in every possible condition during actual use. Faults determined, after an inspection, to be caused by mishandling by the customer such as by using the product without following the contents written on “Notes on Waterproof and Dustproof Properties” are not covered by the warranty.

Waterproof and Dustproof Properties of the Product

The product has a protection rating (JIS C 0920) for waterproof property equivalent to IPX5^{*1} and IPX7^{*2} and for dustproof property equivalent to IP5X^{*3} on the condition that the external connection jack cover is securely closed as well as the battery cover is securely attached (Based on the experiments by the Company).

- *1 IPX5 means that the cell phone continues to function as a phone after being subjected to a water jet (approximately 12.5 liters/min) discharged from a water pouring nozzle (inner diameter: 6.3 mm), from all directions and approximately 3 meters away from the cell phone for at least 3 minutes.
- *2 IPX7 means that the cell phone continues to function as a phone after being gently lowered into a tank filled with still tap water (at room temperature) to the depth of 1 meter, immersed at the bottom for approximately 30 minutes and then taken out of the tank.
- *3 IP5X means the level of dust protection. The cell phone continues to function as a phone in safety after it is left in a device containing dust (diameter: 75 μm or smaller) for 8 hours, agitated and then taken out.

Waterproof and dustproof properties of the product enable you

- To use the product in the rain without an umbrella. (with a precipitation of 20 mm/hour or smaller)

- To use the product in places with water such as in bathrooms, lavatories, kitchens or at the poolside. However, do not submerge it in the bathtub or swimming pool or get it wet with water other than tap water.
- To wash the product with the low-pressure water flow of a tap water (6 liters/min or lower) at the room temperature (5°C to 35°C).

Handling the product

- Attach the battery cover and close the external connection jack cover securely. Even a fine obstacle (one hair, one grain of sand, tiny fiber, etc.) put between contact surfaces may cause intrusion of water or dust.
- If liquid such as water is splashed onto the product with the battery cover removed or the external connection jack cover opened, the liquid may seep inside and cause electric shock or fault. Stop using it, turn off the power, remove the battery pack and then contact an au shop near you or Secure cell phone support center.
- When the product is wet, wipe it with a dry and clean cloth.
- When your hand or the product is wet, never attach/remove the battery cover or open/close the external connection jack cover.
- The product is resistant to fresh and tap water at room temperature (5°C to 35°C) only.
- Do not use the earphone when any jack is wet or sand or dust is attached to it. Doing so may cause fault such as impairment of the waterproof/dustproof property.

Dustproof property of the product

- The dustproof property of the product only guarantees a protection rating equivalent to IP5X and does not guarantee its performance under other using conditions such as when the product is directly put on sand such as a beach.
- If dust is attached to the product, immediately wash it away with water or otherwise clear it completely before use.

■ Notes on Using the Product

- Do not let the product get wet with or submerged into the following liquids.
 - Water containing soap, detergent or bath powder
 - Seawater or water from a swimming pool
 - Hot spring, hot water, etc.
- If the product gets wet with seawater, water from a swimming pool, soft drink, etc. or dust, sand, mud, etc. is attached on the product, immediately wash it away. When it gets dry and coagulated on the product, the stains get hard to get rid of and may cause fault.
- Using the product without completely washing sand or mud away may cause fault such as scratches and damages on the main unit.
- Do not immerse the product in a bathtub or swimming pool. Also, do not use it under water. (including key operations.)
- The product is not designed to withstand high water pressure. Do not expose the product to a strong water flow with tap water, shower, etc. (6 liters/min or more) or submerge it under water.
- Do not leave the product in a humid place such as a bathroom for an extended period of time. Also, do not use the product in a bathroom for an extended period of time.
- To prevent condensation, wait until the product reaches room temperature before you bring it from a cold place into a bathroom etc. If condensation occurs, leave it in room temperature until the condensation is removed.
- Do not get the product wet with hot water, use it in saunas or expose it to hot air from hair dryer etc.
- Do not place the product where it gets extremely hot or cold such as near a stove or in a refrigerator.
- Volumes may temporarily become lower due to water entering in the mouthpiece, earpiece, and speaker. Drain water and dry the product well before use.
- When water drops are attached on the touch panel or you perform touch operations with your hand wet, the product may not properly function.
- The product does not float on water.

- Do not use the product in heavy rain.
- Do not leave the product wet. Doing so may let the liquids freeze on the product in cold places or otherwise cause fault.
- Do not drop or otherwise subject the product to strong impact or jab the mouthpiece, earpiece, speaker, etc. with a cotton swab or any sharp object. Doing so may cause scratching, deformation, etc. on/ of the product, resulting in impairment of waterproof/dustproof property.
- Do not place the product directly on sand at a sandbox, beach, etc. or on mud. Grains of sand may get into the earpiece, speaker, etc., causing the volume to drop.
- Packaged items (battery pack and desktop holder) or optional accessories are not waterproof/dustproof. When you watch 1Seg etc. with the product set on the desktop holder among packaged items, do not use them in places where water is regularly used such as a bathroom, shower room, kitchen and lavatory even if the specified AC adapter (sold separately) is not connected to the desktop holder.
- If the battery cover or external connection jack cover degrades or is damaged, the waterproof and dustproof properties cannot be maintained. In such case, contact an au shop near you or Secure cell phone support center.

■ Maintaining the Waterproof and Dustproof Properties

■ Rubber seals

The rubber seals on the external connection jack cover and battery cover are important to maintain the waterproof property. Be sure to observe the following items.

- Do not remove or scratch them.
- When closing the external connection jack cover and battery cover, do not get the rubber seals caught. Also, do not insert sharp objects into gaps around the external connection jack cover and battery cover or the earphone/microphone jack section. Doing so may damage the rubber seals and cause intrusion of water or dust.
- It is recommended to replace the parts for maintaining the waterproof and dustproof properties (pay service) once every two years regardless of whether any abnormality is present. For information on part replacement, contact an au shop near you or Secure cell phone support center.

■ Precautions on Charging

The battery pack, desktop holder, specified charger (sold separately) and optional accessories are not waterproof/dustproof. Be sure to check the following items before and after charging.

- Check that the product is not wet. If it is wet or after it gets wet, drain water well and wipe remaining water off with a clean dry cloth etc. before setting it on the desktop holder among the packaged items or opening the external connection jack cover.
- If you charge the battery with the external connection jack cover open, be sure to tightly close the cover when charging is finished. It is recommended to use the desktop holder among the packaged items to charge the battery to prevent water and dust from entering from the external connection jack.
- Never charge the battery if the product is wet. Doing so may cause electric shock, short circuit, etc., resulting in fire or fault.

- Do not touch the desktop holder among the packaged items or specified charger (sold separately) with wet hands. Doing so may cause electric shock.
- Do not splash water onto the desktop holder among the packaged items, specified charger (sold separately) or optional accessories when using the equipment. Do not use the equipment in places where water is regularly used such as a bathroom, shower room, kitchen and lavatory. Doing so may cause fire or electric shock.

■ Washing the Product

If any stain, dust, sand, soft drink, etc. is attached to the surface of the product, gently wipe it off with a cloth and wash the product under a mild water flow (up to 6 liters/min) of tap water at room temperature (5 °C to 35°C) approximately 10 cm away from the faucet or shower head.

Make sure that the battery cover is attached, holding the external connection jack cover so that it does not open, and wash the product with your hands without using a brush or sponge. After washing the product, drain water off and then use the product.

- Make sure that the battery cover and external connection jack cover are securely closed before washing the product.
- Do not wash the product with a washing machine or an ultrasound bath.
- The earphone/microphone jack section is especially subject to stain such as dust or sand adhesion. Wash away stain carefully so as not to keep it remaining in the section. Also, after washing it away, make sure the section gets sufficiently dried off before using the product. Using the product with sand or water drops remaining in the jack sections may cause fault.
- When cleaning the earphone/microphone jack section, do not use tools such as a cotton swab or jam a cloth into the jack section. Doing so may cause fault such as impairment of waterproof/dustproof property.

- Never put the product in a microwave oven for drying it. Doing so may cause the battery pack to leak liquid, overheat, rupture or ignite. Also, doing so may cause the product to overheat, emit smoke, ignite or cause destruction of circuit components.
- Do not expose the product to hot air from a hair dryer or leave it in a high temperature environment for drying it. Doing so may cause the product to deform, discolor, get out of order, etc.

■ Draining Water

If the product gets wet, make sure to drain water remaining in the “earphone/microphone jack section”, “earpiece (receiver) section”, “mouthpiece (microphone) section”, “speaker section”, “camera lens fringe section”, “key section”, etc.

1 Wipe off water on the surface of the product carefully with a dry and clean cloth etc.

- If a strap is attached, dry it sufficiently as well.

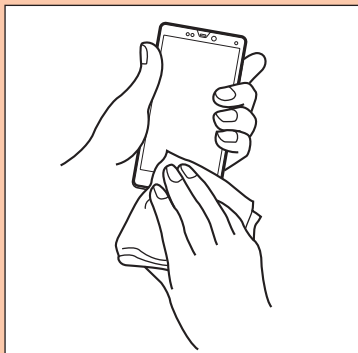

2 Hold the product securely and shake it approximately 20 times until there is no more water splashing.

- Make sure of the safety around you and shake the product while holding it securely not to let it drop.

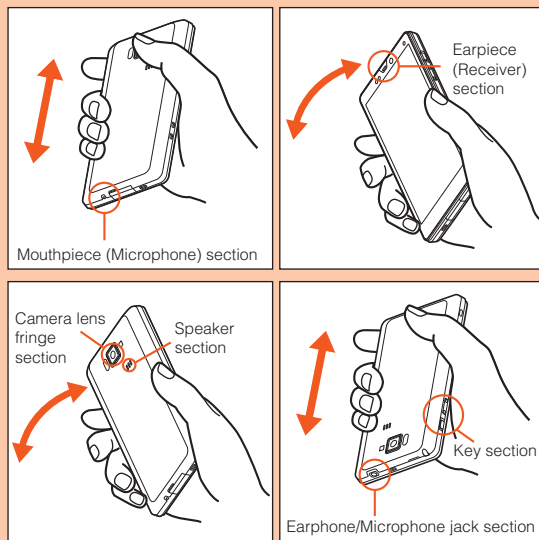

3 Wipe off water remaining in the grooves of each section by gently putting the product against a dry and clean cloth etc.

- Since water is sometimes left in the grooves of each section, clear them of water by putting a cloth against their openings and gently patting them. Make sure that there is no more water or foreign objects remaining in them.

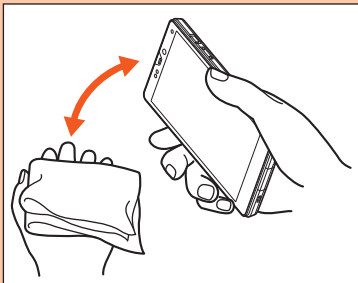

4 Lay out a dry cloth etc. beneath and leave the product on the cloth at room temperature for approximately 2 to 3 hours to dry it.

- Water, if any, remaining in the main body may ooze up after wiping off.
- Do not wipe off water remaining in the grooves directly by a cotton swab etc.

■ Precautions to be taken after water draining

Do not use the product with water drops still left on it.

- Doing so may cause call disruption or cause clothes or bags to get wet.
- Doing so may cause short circuit of a jack section of the earphone etc.
- Doing so may cause fault due to the water drops frozen in a cold place.

Notes on Using Bluetooth®/Wireless LAN (Wi-Fi®) Functions

Frequency Band

Bluetooth® and wireless LAN (Wi-Fi®) functions (2.4 GHz band) of the product use frequencies in the 2.4 GHz band ranging from 2.402 GHz to 2.480 GHz.

- Bluetooth® function: 2.4FH1

2.4FH1

The product uses the 2.4 GHz band.

FH-SS is used as the modulation scheme. The interference distance is about 10 m or less.

Bands of mobile unit identification devices cannot be avoided.

- Wireless LAN (Wi-Fi®) function: 2.4DS/OF4

2.4DS/OF4

The product uses the 2.4 GHz band.

DS-SS and OFDM are used as the modulation schemes. The interference distance is about 40 m or less.

Bands of mobile unit identification devices can be avoided.

Channels available with the 2.4 GHz band wireless LAN (Wi-Fi®) of the product are between 1 to 13.

Available channels differ depending on the country.

For use in airplane, check with the airline company in advance.

Precautions about Bluetooth®

- The Bluetooth® function of the product conforms to the domestic standards of Japan and FCC standards and EC directives, and has been certified. Use of the Bluetooth® function may be restricted in some countries/regions. If you are using the Bluetooth® function overseas, check the relevant laws and regulations of the country/region you visit.
- The 2.4 GHz band used by wireless LAN (Wi-Fi®) and Bluetooth® devices is shared by various other devices. For this reason, Bluetooth® device use technologies for minimizing effects from other devices using the same radio frequency band. In some cases, however, the communication speed and connectable range may be decreased, or disconnection may occur, due to interference by other devices.
- The communication speed and connectable range vary depending on the distance between communication devices, obstacles and the Bluetooth® devices used.

■ Bluetooth® function precautions

The frequencies used by the Bluetooth® function of the product are in the 2.4 GHz band. In this frequency band, other similar wireless stations, in-plant wireless stations for mobile unit identification that require a license for use, such as factory production lines, specific small power wireless stations that do not require licenses, amateur wireless stations (collectively called "other wireless stations" from here on) are operated in addition to home electrical appliances such as microwave ovens, devices for industrial, scientific and medical devices.

1. Before using the product, make sure that "other wireless stations" are not in operation nearby.
2. In the event that instances of radio wave interference have occurred between the product and "other wireless stations", immediately either relocate the product or stop operation of the device (stop emission of radio waves).

3. If you are unclear on any points or are troubled by anything, contact an au shop or Customer Service Center.

Precautions about Wireless LAN (Wi-Fi®)

- The 2.4 GHz band wireless LAN (Wi-Fi®) function of the product conforms to the domestic standards of Japan, FCC standards and EC directives, and has been certified. Use of the 2.4 GHz band wireless LAN (Wi-Fi®) function is restricted in some countries/regions such as France.
If you are using the wireless LAN (Wi-Fi®) function overseas, check the relevant laws and regulations of the country/region you visit.
- The 5 GHz band wireless LAN (Wi-Fi®) function of the product conforms to the domestic standards of Japan and has been certified.
You cannot use the wireless LAN (Wi-Fi®) function overseas.
- Do not use the product in places where electromagnetic waves are generated or near electric products, AV and OA equipment, or other magnetized devices.
- Subjecting the product to magnetic or electrical noise might increase noise and prevent it from performing communications. (The product is particularly susceptible to noise when it used near a microwave oven.)
- Using the product near a TV, radio or similar appliance might cause reception interference and disrupt TV images.
- Searching might not be successful if there are multiple wireless LAN (Wi-Fi®) access points near the product or the same channel is being used.

■ 2.4 GHz band wireless LAN (Wi-Fi®) precautions

The frequencies used by the wireless LAN (Wi-Fi®) function of the product are in the 2.4 GHz and 5 GHz band. In the 2.4 GHz frequency band, other similar wireless stations, in-plant wireless stations for mobile unit identification that require a license for use, such as factory production lines, specific small power wireless stations that do not require licenses, amateur wireless stations (collectively called "other wireless stations" from here on) are operated in addition to home electrical appliances such as microwave ovens, devices for industrial, scientific and medical devices.

1. Before using the product, make sure that "other wireless stations" are not in operation nearby.
2. In the event that instances of radio wave interference have occurred between the product and "other wireless stations", immediately either relocate the product or stop operation of the device (stop emission of radio waves).
3. If you are unclear on any points or are troubled by anything, contact an au shop or Customer Service Center.

■ 5 GHz band wireless LAN (Wi-Fi®) function precautions

In the 5 GHz frequency band, three channels of 5.2 GHz/5.3 GHz/5.6 GHz band (W52/W53/W56) are available.

- W52 (5.2 GHz band/36, 40, 44, 48 ch)
- W53 (5.3 GHz band/52, 56, 60, 64 ch)
- W56 (5.6 GHz band/100, 104, 108, 112, 116, 120, 124, 128, 132, 136, 140 ch)

Making a communication with 5.2 GHz/5.3 GHz band (W52/W53) outdoors is prohibited by the Radio Law.

memo

- Connections between the product and all other Bluetooth® and wireless LAN (Wi-Fi®) devices have not been confirmed. Therefore, connections with all Bluetooth® and wireless LAN (Wi-Fi®) devices are not guaranteed.
- The product supports security features for wireless communications that are compliant with the Bluetooth® and wireless LAN (Wi-Fi®) standard specifications, but the security may not be sufficient depending on the usage environment and configuration. Be careful when making data communication using Bluetooth® or wireless LAN (Wi-Fi®) function.
- Wireless LAN (Wi-Fi®) has the advantage that it can be freely connected anywhere within the radio wave range, as it uses radio waves for exchanging information. At the same time, there is a risk that a malicious third party may obtain unauthorized access if security settings have not been configured. You are recommended to configure security settings before using wireless LAN (Wi-Fi®) at your decision and responsibility.
- The Company assumes no responsibility for leakage of data or information that may occur during Bluetooth®/wireless LAN (Wi-Fi®) communication.
- Since Bluetooth® and wireless LAN (Wi-Fi®) functions use the same frequency band, using the both functions at the same time may cause radio wave interference resulting in decreased communication speed or disconnection from the network. If connection fails, stop using either of the Bluetooth® and wireless LAN (Wi-Fi®) functions.

Notes on Packet Communication Charge

- Since constant Internet connection is possible with the product, packet communication may be performed automatically by some applications, resulting in high packet communication charges. Therefore, subscription to the flat-rate/discount service for packet communication charges is recommended.
- To browse homepages, download applications, communicate using applications, send/receive e-mails and configure various settings, connection to the Internet is required, to which packet communication charge applies.
 - * Packet communication charge does not apply to Wi-Fi® connection.
 - * A separate monthly fee is required for using WiMAX services.

Notes on Google Play/au Market/ Applications

- Be sure to check the security of the application, then install it at your own risk. Some applications might cause virus infection, damage various data, and send out your location information, usage history or personal information stored in your cell phone via the Internet.
- The Company assumes no responsibility for any problems that might be caused by applications you have installed. In such case, you may be charged a repair fee even during the warranty period.
- The Company assumes no responsibility for any disadvantage brought to you or any third party by applications you have installed.
- Insertion of a microSD memory card is necessary to use some applications.
- Some applications prohibit the product from entering sleep mode while they are active, or rapidly drain the battery while running in the background.
- Operation procedures and screen appearances of the applications preinstalled in the product and those installed by you are subject to change without notice as a result of version upgrade. In addition, operation procedures described in this manual may differ from the actual procedures.

Names and Functions of Parts

Front

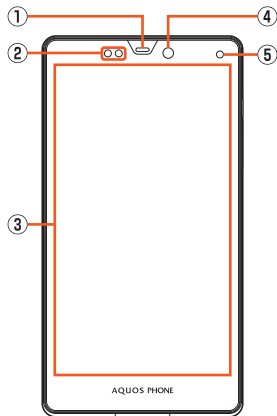

- ① **Earpiece (Receiver)**
Emits voice of the other party during a call, messages in Answering memo, etc.
- ② **Proximity sensor/Light sensor**
Proximity sensor prevents operating the touch panel incorrectly during a call.
Light sensor detects the ambient brightness and adjusts the brightness of display.
- ③ **Display (Touch panel)**
- ④ **In camera lens**
- ⑤ **Charging/Incoming indicator**
Illuminates in red while charging.
Flashes according to the settings when receiving a call or mail.

Left Side/Right Side

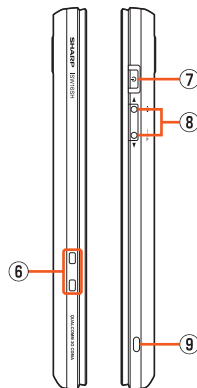

- ⑥ **Charger terminal**
Use it to charge with the desktop holder.
- ⑦ **Power key**
Sets sleep mode.
Hold it down to turn on/off the power, set the manner mode, etc.
- ⑧ **Volume up/down key**
Adjusts the volume.
Hold ▲ down on the Welcome Sheet(Lock Screen) to turn on the mobile light.
Hold ▼ down on the home screen or Welcome Sheet(Lock Screen) to enable/disable the manner mode.
- ⑨ **Strap eyelet**
String the hole with the cord of a strap.

■ Top/Bottom

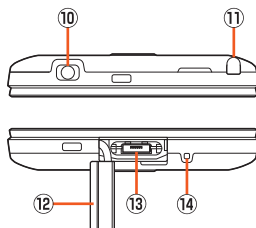

⑩ Earphone/Microphone jack

⑪ TV antenna

Extend and use it to watch 1Seg. It has no influence on calls or data communications if you extend the TV antenna when talking on the product, using browser, etc.

⑫ External connection jack cover

⑬ External connection jack

Use it to connect the product to the common AC adapter 03 (sold separately), the microUSB cable 01 (sold separately), SHARP microUSB-18-pin (charger) conversion cable 01 (sold separately), USB cable for related accessories (commercially available), MHL cable (commercially available), etc.

⑭ Mouthpiece (Microphone)

Transmits your voice to the other party during a call. It is also used for recording sounds. Take care not to cover the microphone with your fingers etc. when using it.

■ Back

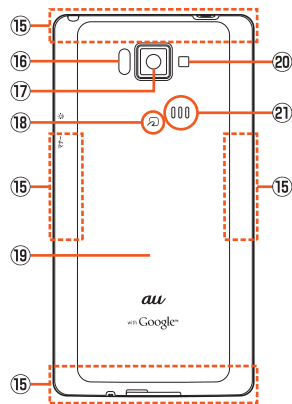

⑮ Internal antennas area

Do not cover the internal antennas area with your hand when you talk on the product, use the Internet, Wi-Fi®, Bluetooth® or WiMAX function or retrieve GPS information (the upper and lower part on the back of the main unit affect calls, the lower part on the back of the main unit affects Internet, the center part on the back of the main unit affects WiMAX function, the upper part on the back of the main unit affects other functions). Also, do not paste stickers etc. around the internal antennas area. Doing so may make the quality of calls/communications deteriorate.

⑯ Infrared port

Sends and receives data via infrared communication.

⑰ Out camera lens

- 18 **FeliCa mark**
Hold it over a reader/writer when using NFC/Osaifu-Keitai®.
Sends and receives data via IC communication.
- 19 **Battery cover**
- 20 **Mobile light**
- 21 **Speaker**
Emits ringtones, alarm tones, etc.

■ Back (Inside the Battery Cover)

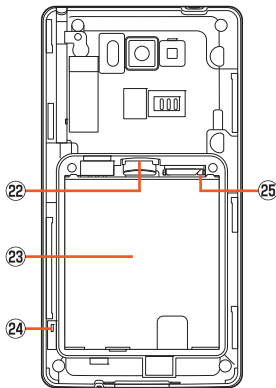

- 22 **microSD memory card slot**
- 23 **Battery pack**
- 24 **Strap hook**
Attach a strap. For details, refer to "Using a Strap" (▶ P.34).
- 25 **Tray**
Use it when you insert the micro au IC-Card.

memo

- ⦿ Do not remove the cover etc. put inside the battery cover.
- ⦿ When you connect the common AC adapter 03 (sold separately), the microUSB cable 01 (sold separately), etc. to the product, some applications may not function properly since the geomagnetic sensor is affected by the magnetism of connected devices. Use the product after removing cables.

Attaching/Removing the Battery Pack

Attaching the Battery Pack

Use only the battery pack for the product.

1 Remove the battery cover on the back of the main unit.

Hook a fingertip (nail) on the concave portion of the battery cover with the center of the battery cover pressed (①), and then remove the battery cover by pulling up in the direction of the arrow (②).

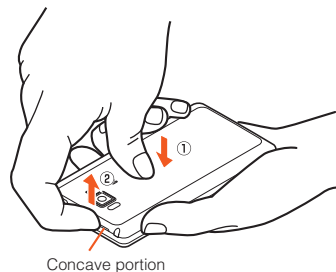

- 2** After making sure that the PULL tab is closely attached to the battery pack, align the contacts on the battery pack with those of the product and then insert the battery pack securely.

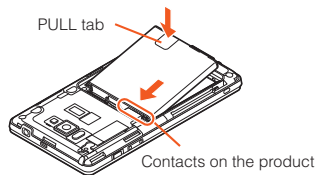

- 3** After attaching the battery cover, press the battery cover securely from ① to ⑦ in order, and make sure that there is no gap.

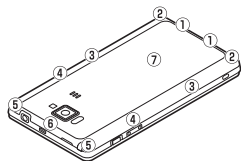

memo

- When removing the battery cover, do not warp it too much.
- Before attaching the battery pack, make sure that the micro au IC-Card is inserted properly.
- Make sure to close the battery cover securely with no gap left in order to maintain the waterproof property.
- Failure to follow the correct procedure when attaching the battery pack may result in damage to the battery pack or the battery cover.

Removing the Battery Pack

Before removing the battery pack, turn the product off and remove the battery cover.

- 1** Remove the battery pack.

Remove the battery pack by pulling up the PULL tab in the direction of the arrow.

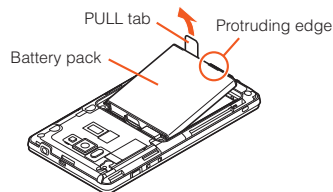

memo

- When removing the battery pack, pull the PULL tab up.
Or use the protruding edge to remove it. Doing otherwise may result in damage to the main unit or the battery connections.

Using a Strap

You can put a commercially available strap on the product. Depending on how to put the strap, the battery cover may come off, and that causes the strap to come off. Put the strap after removing the battery cover.

1 Put the string of the strap through the strap eyelet on the side of the main unit.

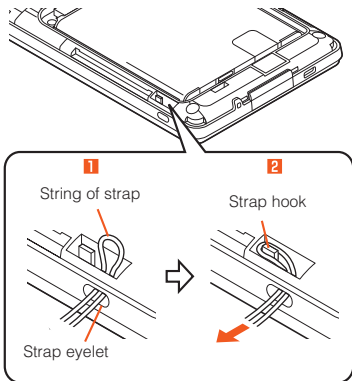

2 Put the string of the strap on the strap hook of the main unit and pull the string lightly in the direction of the arrow without letting it come off.

When you put the string, make sure that it is not twisted.

3 Make sure that the strap does not come off and attach the battery cover.

Make sure that there is no space between the battery cover and the main unit.

memo

- ⊙ Do not put multiple straps on the strap hook.
- ⊙ When you attach the battery cover, make sure that the strap does not come off.
- ⊙ The strap may come off when you attach the battery cover with the string not hooked properly on step 2. Also, be sure that there is no space between the battery cover and the main unit when attaching the battery cover.
- ⊙ Do not swing the main unit by holding the strap. Doing so may result in an accident such as injury, fault or damage. Also, do not use a damaged strap.

Using the micro au IC-Card

micro au IC-Card

The micro au IC-Card records your personal information such as phone numbers.

The product is compatible with micro au IC-Card only. You cannot use the product by inserting the au IC-Card for au phones and smartphones instead.

micro au IC-Card



IC (metal) part

memo

- ◎ Note the following points, which may cause malfunction or damage, when handling the micro au IC-Card.
 - Do not touch the IC (metal) part of the micro au IC-Card or the IC card terminal inside the product.
 - Insert the micro au IC-Card in the correct direction.
 - Do not use force to attach or remove the micro au IC-Card.
- ◎ Do not lose the micro au IC-Card after it has been removed.
- ◎ Make sure to unplug the microUSB plug of the common AC adapter 03 (sold separately) etc. from the product when attaching or removing the micro au IC-Card.

■ When the micro au IC-Card is not inserted

If the micro au IC-Card is not inserted, the following operations are unavailable.

- Making*/Receiving a call
- Sending/Receiving mails
- Confirming your own phone number/own mail address
- Setting UIM card lock

* Making an emergency call to 110 (Police), 119 (Fire and Ambulance) and 118 (Regional Coast Guard) and making a call to 157 (Customer Service Center) are also unavailable.

Besides the above, functions which requires your phone number etc. may not be available.

Also, you cannot use the product with a card other than a micro au IC-Card inserted.

■ Restriction Settings with PIN Code

You can set the product to restrict the use of the product by others through changing the PIN code or locking the UIM card in order to protect your important private information while you are using your micro au IC-Card.

Attaching the micro au IC-Card

Before attaching the micro au IC-Card, turn the product off and remove the battery pack.

1 Pull the tab of the tray in the direction of the arrow.

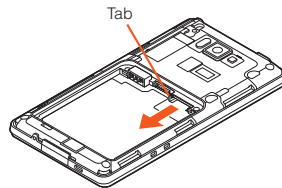

2 Insert the micro au IC-Card into the tray with the IC (metal) side down and insert them securely.

Insert the micro au IC-Card in the correct direction.

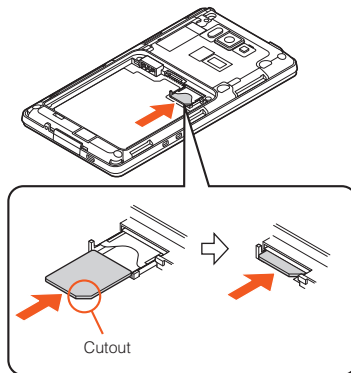

3 Attach the battery pack and the battery cover.

memo

- ⊙ Inserting the micro au IC-Card and the tray not deeply enough may prevent the product from functioning properly.
- ⊙ When the tray comes off, insert the tray straightly.

Removing the micro au IC-Card

Before removing the micro au IC-Card, turn the product off and remove the battery pack.

1 Pull the tab of the tray in the direction of the arrow and remove the micro au IC-Card.

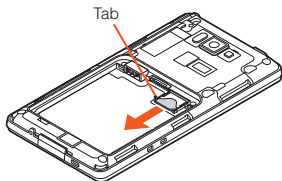

2 Attach the battery pack and battery cover.

Using a microSD Memory Card

microSD Memory Card

You can save, move and copy data by attaching one of microSD memory cards (including microSDHC memory cards and microSDXC memory cards) in the product.

memo

- ⊙ The maximum file size available on a microSD memory card is 2 GB per file when saving data to a microSD memory card.
- ⊙ A microSD memory card initialized on other devices may not work on the product properly. On the home screen, tap [APPS] → [Settings] → [microSD & phone storage] → [Erase microSD] → [Erase microSD] → unlock → [Erase everything] to initialize the microSD memory card.
- ⊙ To play/display data on the microSD memory card, on the home screen, tap [APPS] → [Contents Manager] and use Contents Manager.
- ⊙ Some copyright protected data may not be played on the product even if they can be moved/copied from a PC etc. to a microSD memory card successfully.
- ⊙ microSDXC memory cards are available only on SDXC compatible devices. If you attach a microSDXC memory card to a device that does not support SDXC, the message inducing you to initialize the card appears. Do not initialize the card.
If you initialize a microSDXC memory card on a device that does not support SDXC, it will erase data on the microSDXC memory card and rewrite the file system. The part of space on the microSDXC memory card may become unavailable.

■ Handling Precautions

- Do not turn off the product or subject it to impact while microSD memory card data is being accessed. Doing so creates the risk of data corruption.
- The following microSD memory cards have been confirmed for operation based on the criteria by the Company. For operation confirmation results of other microSD memory cards, contact each microSD memory card manufacturer.

* Note that the provided information is the information checked for operation. The Company shall not guarantee all operations to you.

<microSD/microSDHC/microSDXC Memory Card>

Manufacturer	2 GB	4 GB	8 GB	16 GB	32 GB	64 GB
Toshiba	○	○	○	○	○	—
Panasonic	○	○	○	○	○	—
SanDisk	○	○	○	○	○	○
ADTEC	○	○	○	○	○	—
Buffalo	○	○	○	○	○	—
Sony	○	○	○	○	○	—

○: Confirmed operation

—: Unconfirmed operation or not for sale

As of May 2012

* Between 4 GB and 32 GB are for microSDHC memory card.

* 64 GB is for microSDXC memory card.

* Operation is confirmed for microSD memory cards that are sold as of May 2012. For the latest information on operation confirmation, visit the au homepage or contact the Customer Service Center.

■ Attaching a microSD Memory Card

Before attaching a microSD memory card, turn the product off and remove the battery pack.

- 1 Confirm the direction of the microSD memory card and insert it slowly in the direction of the arrow.**

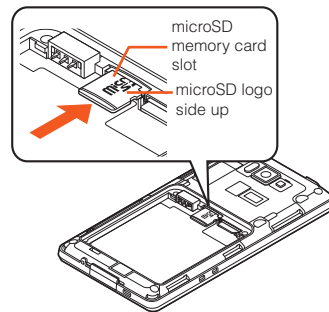

- 2 Attach the battery pack and the battery cover.**

memo

- Make sure that the top and bottom of the microSD memory card are facing correctly.
Trying to force a wrongly oriented card into the slot could make it impossible to remove the card and result in damage.
- Do not touch the terminal part of a microSD memory card.

Removing the microSD Memory Card

Before removing the microSD memory card, turn the product off and remove the battery pack.

1 Remove slowly the microSD memory card in the direction of the arrow.

Pull slowly the microSD memory card straight out.

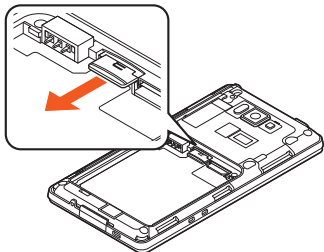

2 Attach the battery pack and the battery cover.

memo

- Do not remove the microSD memory card forcefully. Doing so may result in damage to the microSD memory card or the product or data loss.
- Applications installed to a microSD memory card cannot be used once you removed the microSD memory card.
- The microSD memory card may become warm after a long time use, but this is not a fault.

Charging

Charging

When you purchase the product, the battery pack is not fully charged. Be sure to charge the battery pack before use.

The usage times are as follows.

Continuous standby time	Approx. 360 hours (while 3G is used) Approx. 160 hours (while 3G and Wi-Fi® are used) Approx. 210 hours (while 3G and WiMAX are used)
Continuous talk time	Approx. 510 min

* These times are based on the case when the product is used in Japan. For details on the usage time overseas, refer to "Main Specifications" (▶ P. 69).

memo

- The product and the battery pack may become warm during charging, but this is not a fault.
- Charging the battery pack while using the camera function etc. may lengthen the charging time.
- If you perform various operations with a specified charger (sold separately) connected to the product, charging/electric discharge may take place repeatedly in a short time. Frequently charging the battery pack shortens its service life.
- If the charging/incoming indicator flashes in red, check whether the battery pack is properly attached, an external device is properly connected to the product, etc. If the indicator flashes even after you have checked that, stop charging the battery pack and contact an au shop or Secure cell phone support center.
- Properly close the external connection jack cover. Also, do not pull it forcibly or twist it.

◎ The continuous talk time and continuous standby time are average usage times combining the time during which a cell phone is carried around by a user and properly receives radio waves plus the time during which a cell phone is stationary and properly receives radio waves. According to usage conditions such as battery level status and temperature, the signal strength in a place where the cell phone is used, settings of functions, etc., the usage times may be reduced to less than half under the following cases.

- A cell phone is frequently used in a place where  (out of service area indicator) appears on it.
- The Wi-Fi® function, WiMAX function, Bluetooth® function, mail function, camera function, 1Seg function, location information, etc. is used.
- A cell phone is set not to enable sleep mode because of an application etc.
- Applications which remain activated in the background are used.

◎ If you stop charging while the charging/incoming indicator still illuminates during charging, the cell phone may be left not fully charged even if  appears on it. In such case, the average usage times shorten.

Charging with the Desktop Holder and the Specified AC Adapter (Sold Separately)

The followings are the explanation of how to connect the desktop holder and the common AC adapter 03 (sold separately) to charge. For details on the specified AC adapter (sold separately), refer to "Introduction of Related Accessories" (▶ P. 61).

Charging time	Approx. 200 min
---------------	-----------------

1 Insert the microUSB plug of the common AC adapter 03 (sold separately) to the connection jack of the desktop holder.

Confirm the direction of the microUSB plug and insert it in the direction of the arrow.

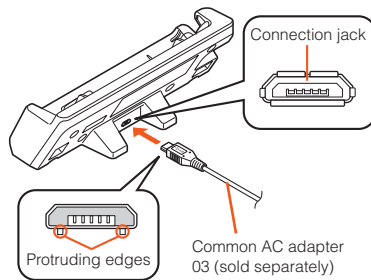

2 Place the main unit on the desktop holder.

Insert the main unit with the locking tabs of the desktop holder fitted into the concave portions of the main unit.

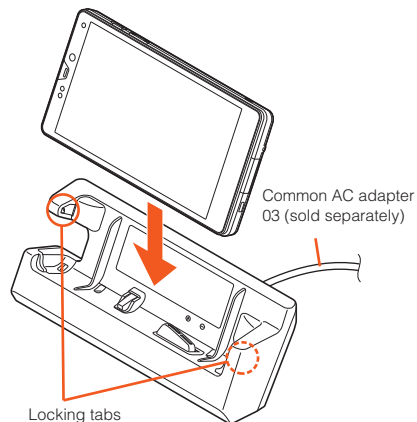

- 3 Plug the common AC adapter 03 (sold separately) power plug into a 100 V AC power outlet.**

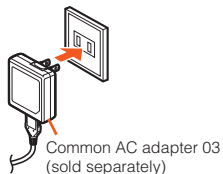

The charging/incoming indicator illuminates in red, and the battery icon appears with ⚡ superimposed. When charging is finished, the charging/incoming indicator goes out.

- 4 When charging is finished, remove the main unit from the desktop holder and unplug the common AC adapter 03 (sold separately) power plug from the power outlet.**

Hold the desktop holder and remove the main unit from it. Pull the microUSB plug of the common AC adapter 03 (sold separately) straight out from the desktop holder.

memo

- ◎ When using the desktop holder, connect only the specified AC adapter (sold separately). Connecting equipment not specified such as a PC or portable charger to the desktop holder may cause a malfunction. Do not connect such equipment to the desktop holder.

Charging with the Specified AC Adapter (Sold Separately)/Specified DC Adapter (Sold Separately)

The following are the explanation of how to connect the common AC adapter 03 (sold separately)/the common DC adapter 03 (sold separately) to charge. For details on the specified AC adapter (sold separately)/DC adapter (sold separately), refer to “Introduction of Related Accessories” (▶ P.61).

Charging time is as shown below.

Common AC adapter 03 (sold separately)	Approx. 190 min
Common DC adapter 03 (sold separately)	Approx. 280 min

- 1 Open the external connection jack cover of the product.**

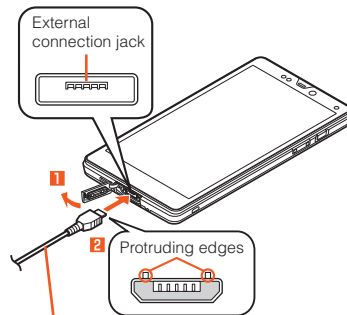

Common AC adapter 03 (sold separately)/
Common DC adapter 03 (sold separately)

2 Confirm the direction of the microUSB plug of the common AC adapter 03 (sold separately)/the common DC adapter 03 (sold separately) and insert it in the direction of the arrow to the external connection jack of the product.

3 Plug the common AC adapter 03 (sold separately) power plug into a 100 V AC power outlet/Plug the common DC adapter 03 (sold separately) plug into a cigarette lighter socket.

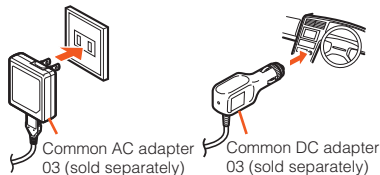

The charging/incoming indicator illuminates in red, and the battery icon appears with ⚡ superimposed. When charging is finished, the charging/incoming indicator goes out.

4 When charging is finished, pull the microUSB plug of the common AC adapter 03 (sold separately)/common DC adapter 03 (sold separately) straight out from the external connection jack of the product.

5 Close the external connection jack cover of the product.

6 Unplug the common AC adapter 03 (sold separately) power plug from the power outlet/Unplug the common DC adapter 03 (sold separately) plug from the cigarette lighter socket.

memo

- Although you can charge the battery pack while the power is turned on, charging time lengthens.
- If you charge the battery pack when the battery has run out, the charging/incoming indicator may not illuminate soon. However, charging is in progress.

Charging with a PC

When you connect the product to a USB port of a PC through which the battery pack can be charged, the charging/incoming indicator illuminates in red and charging starts. When charging is finished, the charging/incoming indicator goes out.

- 1** Connect the microUSB cable 01 (sold separately) to a USB port of a PC after the PC is activated completely.
- 2** Connect the microUSB cable 01 (sold separately) to the product after the product is activated completely.

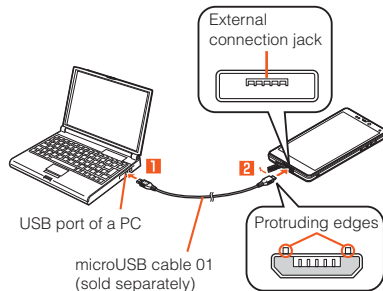

memo

- If you use the microUSB cable to charge the battery pack, it may take the battery pack longer to be fully charged than if you use the specified AC adapter (sold separately).
- The product supports two microUSB plug shapes.
- Turn the protruding side of the microUSB plug up and insert the microUSB plug to the external connection jack of the product straightly. Inserting the microUSB plug in the wrong direction may result in damage to the external connection jack of the product.
- The product is turned on when it is connected while the power is turned off.
- If you charge the battery pack when the battery has run out, the charging/incoming indicator may not illuminate. In such case, use the specified AC adapter (sold separately) for charging.

Turning the Power On/Off**Turning the Power On**

- 1**  (hold down for at least 2 seconds).

memo

- The initial setting of the touch panel will be executed until "AQUOS PHONE" disappears from the screen after the power is turned on. Do not touch the screen, otherwise touch panel operations may not be performed properly.

Turning the Power Off

- 1**  (hold down for at least 2 seconds).
- 2** [Power off] → [OK].

Restarting the Product

Turn off the product once and restart.

- 1**  (hold down for at least 2 seconds).
- 2** [Reboot] → [OK].

Sleep Mode

If you press  or no operation is made for a specified time, the screen is turned off temporarily, and then sleep mode is set.

Disabling Sleep Mode

- 1**  while sleep mode is set.

memo

- In some applications in use, the screen which was displayed before sleep mode is set may be displayed when sleep mode is disabled.
- Do not touch the screen when you disable sleep mode. Otherwise touch panel operations may not be performed properly.

Welcome Sheet(Lock Screen)

The Welcome Sheet(Lock Screen) is displayed if you disable sleep mode.

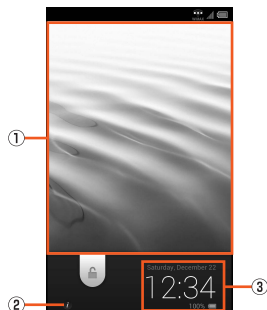

《Welcome Sheet(Lock Screen)》

Slide “” to the bottom of the screen to unlock.

Slide “” up to display , , and . Tap them to activate the following applications.

- : Camera
- : Phone
- : E-mail

When you receive a missed call/new e-mail/new SMS (C-mail), the notification bar is displayed. Slide the notification bar down to display the corresponding screen.

① Wallpaper

If multiple images are set in “Welcome sheet (lock screen)” in advance, flick to the left/right to switch the wallpapers.

② Owner info key

When you tap with “Owner info” in “Lock & Security” set, the owner info is displayed in the Info Area.

Tap “” to hide it.

③ Info Area

Flick to the left/right to switch the weather, stock prices information, music operation keys and date and time.

- The music operation keys are displayed only while an application for music playback is being activated. They may not be displayed depending on the application.

memo

- ◎ When the Welcome Sheet(Lock Screen) is displayed for the first time, its tutorial is displayed. Confirm the contents and follow the on-screen instructions.

Switching the Display Language to English

You can switch the display language for function names and other items to English.

1 On the home screen, [アプリ] (APPS).

2 [設定] (Settings).

3 [言語と文字入力] (Language & input).

4 [言語(Language)を選択] (Select language).

5 [English].

Using the Touch Panel

The display on the product is a touch panel operated by touching it with your finger.

- The touch panel is designed to be touched lightly by your finger. Do not exert too much pressure with your finger or press sharp-pointed objects (fingernails, ballpoint pens, pins, etc.) against it.
- In the following cases, the touch panel may not work even if you touch it. It may also cause a malfunction.
 - Operation with a gloved finger
 - Operation with your fingernails
 - Operation with foreign objects placed on the operation pad
 - Operation with protective sheets or stickers on the touch panel
 - Operation when the display is wet or fogged
 - Operation with wet or sweaty fingers
 - Operation under water

■ Tap/Double Tap

Tap: Gently touch a screen and then immediately release your finger.
Double tap: Tap the same position twice.

- Select an item or icon displayed on the screen. Double tap on the browser etc. to enlarge/reduce the screen.



■ Long Touch

Keep touching an item with your finger.

- Display context menu etc.



■ Slide

While your finger is gently touching the screen, trace it to the desired direction to move over when all items cannot be displayed within the screen.

- Scroll screen or switch pages. In addition, operate gauge and bar when adjusting volume and brightness.



Flick

Operate the screen by quickly moving (flicking) your finger up, down, right, or left.

- Switch pages, enter characters by flick input, etc.



Pinch

Touch the screen with two fingers and widen (pinch-out) or narrow (pinch-in) the fingers' distance.

- Enlarge/Reduce the screen of the browser etc.

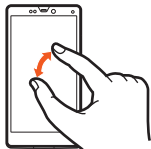

Drag

While your finger is gently touching an item or icon, trace it to the desired position to move or perform other operations.



Using the Touch Keys

The following icons appear on the Navigation Bar and can be used as touch keys.

Icon	Description
	Returns to a previous screen.
	Displays the home screen.
	Displays an option menu.
	Displays recent applications.

Using the 3-Line Home

Viewing the 3-Line Home

The 3-Line Home is a home screen which consists of the Apps Sheet, the Widget Sheet and the Shortcut Sheet. You can use the function by tapping an icon/a widget/shortcut on each sheet.



- ① Status bar
- ② Sheet Switcher

Tap it to switch the Apps Sheet, the Widget Sheet and the Shortcut Sheet.

- ③ Apps Sheet/Widget Sheet/Shortcut Sheet
- ④ Navigation Bar
- ⑤ Separator

Pinch out vertically on the home screen to add the separator. To delete the separator, pinch in vertically.

memo

- ◎ When the 3-Line Home is displayed for the first time, its operation guide is displayed. Confirm the contents and follow the on-screen instructions.

Switching Sheets

On the Sheet Switcher, tap "APPS", "WIDGETS" or "SHORTCUTS", or slide/flick the home screen to the left/right to switch each sheet.

Switching sheets



Using Menu on the Home Screen

- 1 Slide down at the top of each sheet.

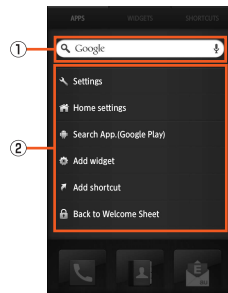







(Menu)











- ① Quick search box
- ② Menu

2	Settings	Makes various settings for the product. • For details, refer to "Displaying Setting Menu" (▶P.60).
	Home settings	About home Tap "View tutorial" to display the operation guide for the 3-Line Home. Layout Sets the layout of the 3-Line Home. Scroll setting Sets the scroll type for the 3-Line Home. Theme Sets the theme of the 3-Line Home.
	Search App.(Google Play)	Use Google Play.
	Add widget	Pastes the selected widget on the Widget Sheet.

Add shortcut	Pastes the selected shortcut on the Shortcut Sheet.
Back to Welcome Sheet	Displays the Welcome Sheet(Lock Screen).

Main Application List

Icon	Name of icon	Description
	Phone	Make a call and confirm histories. (▶ P.55)
	E-mail	Exchange mails with e-mail compatible cell phones and PCs.
	SMS(C-mail)	Exchange mails between cell phones by using phone numbers as the destination.
	Settings	From Settings, set up and manage functions. (▶ P.60)
	au Easy Setting	Supports settings for using convenient functions and services provided by au. For details, refer to "Setting Guide".
	Instruction Manual	Check the contents written in "Full Instruction Manual" (Japanese). You can search explanations of a function that you want to use by using the table of contents, index and search engine. Also, you can easily search explanations often confirmed by putting bookmarks on them.
	NFC Menu	Shows compatible applications list with the NFC service, sets NFC lock, or makes NFC settings.

Icon	Name of icon	Description
	au Wi-Fi接続ツール (au Wi-Fi connection tool)	Use Wi-Fi® easily in the spot where au Wi-Fi SPOT is available. Also, you can set Wi-Fi® easily with a wireless LAN (Wi-Fi®) access point on which "Simple connection" is available.
	安心アプリ制限 (Restrict Applications)	Restrict applications or functions that you do not want your children to use.
	Facebook	Use Facebook.
	Skype	Makes a call or exchanges instant messages (chat).
	Friends Note	"au one Friends Note" can manage Native Address Book of your phone and multiple social networking services in just one application.
	auテレビ.Gガイド (au TV. G-GUIDE program table)	View TV program table or search programs. Functions using 1Seg or remote timer recording can be used.
	LISMO Player	Plays music or checks information about the playing music.
	au ID Setting	Set au ID. For details, refer to "Setting Guide".
	au Market	Allows you to install Android applications recommended by au.
	auスマートパス (au Smart Pass)	You can enjoy over 500 apps by ¥390 per month! Also coupon, present, photo storage and security apps are available! Please enjoy your safety and comfortable smartphone life!
	3LM	Lock the product remotely in case of theft or loss of the product.

Icon	Name of icon	Description
	リモートサポート (Remote Support)	Call for technical supports on the phone operations by sharing the screen that you are watching with au operators.
	ウイルスバスター (VirusBuster)	Blocks improper applications and sites in order to protect young people.
	auサービスリスト (au service list)	Use services and applications of au/KDDI easily from lists.
	GREE MARKET (GREE Market)	This application allows you to browse games and other content provided by au GREE. You do not need a GREE account in order to use this application.
	au災害対策 (au Disaster Countermeasure)	Use Disaster Message Board, Early warning mail (earthquake early warnings, disaster/evacuation information and tsunami warnings) and Disaster Voice Delivery Service. (▶P.2)
	auお客さまサポート (au Customer Support)	You can check the subscription contents or monthly usage of your au phones etc. with this application. You can change your rate plan, apply for optional services and so on at au Customer Support website.

* Requires download and installation to use.

memo

- When you tap an icon to use the corresponding function, communication charges may be incurred depending on the function.
If you have not subscribed to IS NET, au.NET charges (525 yen including tax for the used month) and communication charges are incurred.
- The design of icons etc. may be changed without prior notice.

















○ Besides the above, some applications are installed on the product. For details, refer to "Instruction Manual application" (Japanese).

Using the Status Bar

Icons

The notification icons to notify you of a missed call, a new mail message or a running operation are displayed on the left side of the status bar, while the status icons to show the status of the product are on the right side.

Examples of Notification Icon

Icon	Description
	Missed call
	E-mail information  : New e-mail message  : E-mail message failed to be sent
	New mail message (SMS (C-mail))
	New mail message (PC-mail)
	New mail message (Gmail)
	Alarm terminated <ul style="list-style-type: none"> • Appears when the alarm is terminated without the operation for terminating the alarm.
	Schedule notification of the calendar
	1Seg information  : Watching information, Recording reservation information  : Recording information
	Playing music
	USB debug connecting
	Making a call, talking, receiving a call
	Putting a call on hold
	Answering memo

Icon	Description
	Skype™ au status : Signed in : New event
	Energy saving setting : Waza-ari mode : Emergency mode
	Space on the main unit (system) available less than approx. 10 %
	USB tethering in use
	Wi-Fi® tethering/Wi-Fi Direct in use
	Bluetooth® file receiving request
	GPS in use • The GPS information positioning icon is displayed as an animation.
	USB connecting
	Data upload, File sending : Uploading data, Sending file, Finished sending file, Failed to send file : Finished uploading data : Waiting to upload data • The uploading data icon and the sending file icon are displayed as animations.
	Downloading, Finished downloading, Installing data or application, Receiving, Finished receiving file, Failed to receive file • The installing icon and the receiving file icon are displayed as animations.
	Finished installing
	Update available
	Major Update (OS Update) available
	Icons collected

memo

© Some icons appear with their number superimposed on them.

Examples of Status Icon

Icon	Description
	Time
	Alarm set
	Battery level ~ : Battery level display : No battery • While charging, the battery icon appears with superimposed.
	Airplane mode set
	Signal strength (Receiving electric field) ~ : Level display : Out of service area • The icon indicating network appears at the upper left. • During a communication, the icon appears with superimposed.
	Character type : Kanji : Half-width alphabet : Half-width numeric : Half-width Katakana : Full-width alphabet : Full-width numeric : Full-width Katakana : Character code
	Manner mode status : Standard manner mode : Drive manner mode : Silent manner mode
	During a call using hands-free
	Microphone set to "mute" during a call
	Home Network status : Suspending (Green): Preparing (Blue): Running
	Wi-Fi® signal strength ~ : Level display • During a communication, the icon appears with superimposed.

Icon	Description
	<p>WiMAX signal strength</p> <ul style="list-style-type: none"> : Level display : Out of service area/Not connecting : Powering down : Idling • During a communication, the icon appears with
	<p>Bluetooth® in use</p> <ul style="list-style-type: none"> : Waiting : Connecting
	<p>Answering memo set</p> <ul style="list-style-type: none"> : No Answering memo : Answering memo (one to nine entries) : Answering memo (ten entries)
	NFC/Osaifu-Keitai® function locked
	"NFC R/W P2P" set to ON

Using the Notification/Status Panel

In the notification/status panel, you can check the details on notification icons and status icons or activate an application corresponding to the icon.

You can also set the manner mode, VeilView, etc.

1 Slide the status bar down.

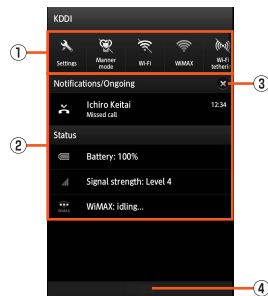

(Notification/Status panel)

① Function key

You can switch settings of the frequently used function by one touch.

Tap "Settings" to make various settings for the product.

- For details, refer to "Displaying Setting Menu" (▶ P.60).

② Notification area

You can check the status of the product and contents of notifications. You can tap to activate a corresponding application depending on the information.

③ Clear

You can clear all the notifications by tapping the key.

④ Close bar

You can hide the notification/status panel by sliding it up.

Switching Software Keyboards

To display the software keyboard, tap a character input field in the character entry screen for adding contacts, creating a message, etc. The following software keyboards are available for the product.

12Key	Characters are arranged in the same order as of the keyboard on a conventional cell phone. You can enter a character, changing characters by repeatedly tapping the character entry key.
QWERTY	Characters are arranged in the same order as of the keyboard on a conventional PC. You can enter a displayed character by tapping the character entry key.

1 On the character entry screen, [] → [Change input UI] → [Set QWERTY keyboard]/[Set 12 keyboard].

Flick Input

When the software keyboard is "12 Key", you can enter a desired character by flicking the key up, down, left or right without tapping the key repeatedly.

When you touch a key, the candidates that can be entered by flick input are displayed. By flicking the key in the direction of a desired character being displayed, the character is entered in the character entry area. For example, you can enter "A" by only tapping "ABC", and you can enter "B" by flicking "ABC" left.



Viewing the Character Input Screen

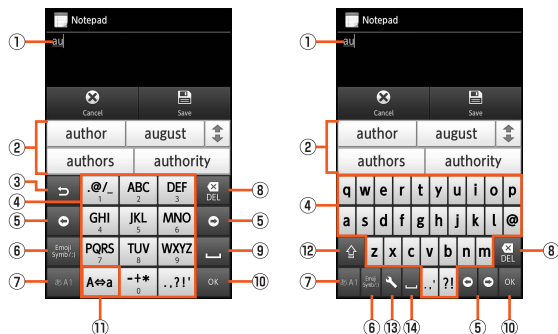



(Character entry screen (12 Key))

(Character entry screen (QWERTY))

- Character entry area**
- Prediction candidates list/Relational prediction candidates list/Normal conversion candidates list**

If the predictive conversion is enabled, the prediction candidates list is displayed when characters are entered. If the relational prediction is enabled, the relational prediction candidates list is displayed when you select a candidate.

Enter characters and tap "Convert" to display the normal conversion candidates list.

- You can enlarge the candidates list area by tapping "  ". Tap "  " to return it to the original display.

- Reverse toggle key/Undo key**

 : Displays the characters assigned to the same key in the reverse rotation.

 : Cancels the last operation such as returning the determined characters to the undetermined state by tapping the key.

④ Character entry key

You can enter a character assigned to each key.

⑤ Cursor key

Moves the cursor to the left and right. Enters a space by moving the cursor to the right at the end of a text. Change the range of the characters for character input and conversion.

⑥ Emoji, Symbol and Facemark key/Kana and Alphanumeric key

: Displays the emoji/symbol/facemark list.

: Displays katakana, alphabet, number and predicted date and time assigned to the entered characters as conversion candidates.

• Tap "" to return to the previous display.

Flick Emoji, Symbol and Facemark key/Kana and Alphanumeric key to the right to display Quote apps list. Select an application to activate.

⑦ Input mode key

When you switch the input modes, the display changes as follows.

: Kanji

: Half-width alphabet

: Half-width numeric

: Half-width Katakana

: Full-width alphabet

: Full-width numeric

: Full-width Katakana

: Character code

⑧ Delete key

Deletes the selected character or the character on the left of the cursor. When the cursor is at the beginning, the character on the right of the cursor is deleted.

⑨ Settings key/Space key/Conversion key

: Displays the iWnn IME menu.

: Enters a space.

• Appears in alphabet and katakana entry.

: Displays the normal conversion candidates list.

⑩ OK key/Line feed key

: Determines the entering characters.

: Inserts a line feed at the cursor position.

• The display is changed depending on the application or entering item.

⑪ Space key/Uppercase/Lowercase characters switch key

: Enters a space.

: Switches the entered alphabet to the uppercase/lowercase one.

: Switches the entered character to the uppercase/lowercase one or add dakuten/handakuten to the character.

⑫ Shift key

You can switch uppercase character entry and lowercase character entry by tapping the shift key. The display changes as follows each time you tap it.

: Lowercase character entry

: Uppercase character entry

: Uppercase character entry lock

You can switch the symbols to enter by tapping the key in numeric entry.

⑬ Setting key

Displays the iWnn IME menu.

⑭ Space key/Conversion key

: Enters a space.

: Displays the normal conversion candidates list.

memo

- ◎ While the prediction candidates list/relational prediction candidates list/normal conversion candidates list is not displayed, tap “- Flick from the right edge to the left edge or from the left edge to the right edge: QWERTY keyboard/12 keyboard input
- Flick from the bottom edge to the top edge: Handwriting input
- Flick from the top edge to the bottom edge: Voice input

Character Input Method

Entering Characters

You can enter characters with the software keyboards. The wildcard prediction, predictive conversion and relational prediction function are also available for character input.

Example: When entering “大阪”

- 1** On the character entry screen, enter “おおさか”.
- 2** Select “大阪” from conversion candidates.

memo

Predictive conversion

- ◎ In the prediction candidates list, tap “

Using Wildcard Prediction

Conversion candidates predicted from the number of the entered characters are displayed and can be entered.

Example: When entering “Call”

- 1** On the character entry screen, enter “C”.

- 2** [] → [] → [].

Each time you tap “

- 3** Select “Call” from conversion candidates.

Switching Character Input Modes

- 1** On the character entry screen, [] → [Change input mode].
- 2** Select the input mode.

memo

- ◎ The input mode is switched in order of “Half-width alphabet” → “Half-width numeric” → “Kanji” each time you tap the input mode key. Also, slide the input mode key to the left/right to switch “Kanji”/“Half-width alphabet”/“Half-width numeric”.
- ◎ Some input modes cannot be used depending on the screen or the application.

Entering Emoji/Symbol/Facemark

- 1 On the character entry screen, [].

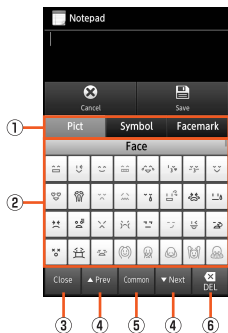

(Emoji/Symbol/Facemark list screen)

① **Character switching tab**

Switches the emoji/symbol/facemark.

② **Emoji/Symbol/Facemark list**

Displays the emoji/symbol/facemark list for each category.

- Long touch a facemark to edit it. However, facemarks in the “History” field cannot be edited.

③ **Close key**

Returns to the character entry screen.

④ **Page switching key**

Displays the previous/next categories or pages.

⑤ **Character switching key**

 : Displays emojis converted automatically when sent to a cell phone of another carrier.

 : Displays normal emojis.

 : Displays full-width symbols.

 : Displays half-width symbols.

⑥ **Delete key**

Deletes the selected character or the character on the left of the cursor. When the cursor is at the beginning, the character on the right of the cursor is deleted.

2 Select an emoji/a symbol/facemark.

memo

- ◎ Some lists cannot be displayed and some emojis/symbols/facemarks cannot be entered depending on the screen you operate.

Making Calls

Entering a Phone Number and Making a Call

- 1 On the home screen, [APPS] → [Phone].

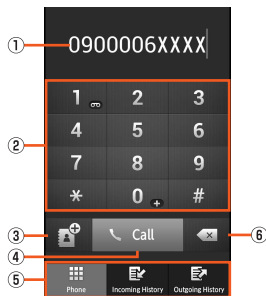

(Phone number entry screen)

- 1 **Phone number entry field**

Enter numbers of up to 32-digit.

- 2 **Number key**

- 3 **Address book key**

Make a call by selecting a contact information from the address book. Or you can register the entered phone number to the address book.

- 4 **Call key**

Make a call. Also, if there is an outgoing history, the latest outgoing history is entered by tapping the key when the phone number has not been entered.

- 5 **Screen switching tab**

Switches the phone number entry screen/incoming history list screen/outgoing history list screen.

- 6 **Delete key**

Deletes one digit on the left of the cursor. If you long touch the key, all the numbers on the left of the cursor are deleted and all the numbers are deleted when there is no number on the left of the cursor.

- 2 **Enter a phone number.**

When calling to a fixed-line phone, enter the phone number starting with the area code even if you are in the same area.

- 3 **[Call] → Talk.**

Press / during a call to adjust the earpiece volume (the other party's voice).

- 4 **[End call].**

memo

- Even when "In Call" is displayed, the other party may not have taken the call. Start talking after making sure that the other party has taken the call.
- If you cover the screen while making a call/talking, it is turned off.
- The call fees when calling with "1401" will be subtracted from the balance registered at the time of purchase of an au prepaid card.
- You can play the answering/voice mail saved by Answering Service by long touching "1" without entering the phone number on the phone number entry screen.
- Note that even if you cover the mouthpiece, the sound can be conveyed to the other party.
- Even if "Airplane mode" is set, you can call to the emergency number (110, 119, 118) and the Customer Service Center (157).
- Execute the following operations to return to the call screen after activating another application during a call.
 - Tap to return to the home screen, activate "Phone" and tap "Return to call in progress".
 - Slide the status bar down and tap "Current call".

Dial services available from au phones

- ◎ The following dial services are available.
 - Call with fixed-line phones throughout Japan
 - Call with cell phones, PHS and car phones throughout Japan
 - 010 (au international call service: Subscription is unnecessary)
 - 171 (Disaster emergency message dial)
 - 177 (Weather forecast: The area code is necessary)
 - 117 (Time signal)
 - 104 (Directory assistance)
 - 115 (Sending telegrams)
 - 110 (Emergency call to Police)*
 - 119 (Emergency call to Fire and Ambulance)*
 - 118 (Emergency call to Regional Coast Guard Headquarters)*
 - 157 (Customer Service Center)
 - Maritime telephone
 - * The numbers are emergency call numbers.
- ◎ The following NTT services are unavailable.
 - Collect call
 - Message service
 - Dial Q2
 - 116 (NTT business information)

Emergency Call Location Notification

The product supports "Emergency call location notification" so that if you make an emergency call to Police, Fire and Ambulance or Regional Coast Guard Headquarters, your current location (GPS information) will be transmitted to the agency receiving the emergency call.

memo

- ◎ In this section, Police (110), Fire and Ambulance (119) and Regional Coast Guard Headquarters (118) are collectively referred to as the emergency call receiving agency.
- ◎ This feature may not yet be available at some emergency call receiving agencies.
- ◎ If you add "184" before the emergency call number 110/119/118, the emergency call receiving agency will not be notified of your location and phone number.

- ◎ In places where signal reception from GPS satellites or a base station is relatively poor, such as in an underground mall, inside a building or behind a tall building, the emergency call receiving agency may be notified of some other place different from your actual location.
- ◎ When GPS cannot be used to notify of your location, base station signal is used instead.
- ◎ When making an emergency call to Police, Fire and Ambulance or Regional Coast Guard Headquarters, always confirm where you are, and tell them your exact location on the phone. Note that depending on the area where you are calling, your call may not be connected to the agency having jurisdiction over that area.
- ◎ If the emergency call receiving agency determines that human lives and health are in danger, they will be able to acquire the caller's location information during the call or within a certain period of time after the call.

Using P (Pause) Dial

If you have entered a touch-tone signal to send in advance, you can send the touch-tone signal by tapping "Yes" during a call. It is convenient for using various information services and automated reservation services.

Example: To call "03-0001-XXXX (bank's phone number)" and send a branch code "22X" and an account number "123XX"

- 1 On the phone number entry screen, enter a bank's phone number "030001XXXX".**
- 2 [☰] → [Add Prefix] → [Add P] → Enter a branch code "22X".**
- 3 [☰] → [Add Prefix] → [Add P] → Enter an account number "123XX".**

You can enter multiple touch-tone signals at the same time by entering P (pause) between touch-tone signals.

- 4 [Call] → [Yes] → [Yes].**

If you make a call, the confirmation screen is displayed. Make sure that the receiver receives the call, and tap "Yes". Each time you tap "Yes", a touch-tone signal is sent.

Using Menu on the Phone Number Entry Screen

1 On the home screen, [APPS] → [Phone] → [☰].

2	Create SMS	Create an SMS (C-mail).
	Add Prefix	Add a prefix to the phone number.
	Restrict Calls Setting	Set whether to restrict making a call. <ul style="list-style-type: none"> • Even while Restrict Calls Setting is set to ON, you can make a call to emergency call numbers and 157 (Customer Service Center). Even in roaming, you can make a call to emergency call numbers.
	Settings	Perform call settings.

Operations on the Call Screen

Volume	Adjust the earpiece volume (the other party's voice).
Mute/Mute OFF	Set whether to convey your voice to the other party.
DIAL	Display number keys. You can send touch-tone signals and add a call.
Voice Memo	Record the other party's voice and your voice during a call. <ul style="list-style-type: none"> • You can record up to 10 memos with the recording time per memo up to approximately 60 seconds. If the number of memos exceeds 10, memos are deleted from the oldest one. If all voice memos are protected, you cannot record new one.
Speaker/ Speaker OFF	Set whether to call using hands-free.
Address Book	Display the address book.

Using Menu on the Call Screen

1 During a call, [☰].

2	Bluetooth ON/ Bluetooth OFF	Connect to/Disconnect from a Bluetooth® headset sold separately.
	Quote to Call log	Display the outgoing history/incoming history list screen.
	Quote from profile	Display the profile screen.
	Add Call	You can add a call.

Calling Overseas from au Phones (au International Call Service)

You can make international calls without any special procedure from the product.

Example: To call "212-123-XXXX" in the USA from the product

1 On the home screen, [APPS] → [Phone].

2 Enter the international access code "001010" or "010".

Long touch "0" to enter "+" and "001010" is automatically added when calling.

3 Enter the country code of the USA "1".

4 Enter the area code "212".

If the area code starts with "0", dial it without including the "0" (There are some exceptions such as fixed-line phones in some countries or regions including Italy and Moscow).

5 Enter the phone number of the other party "123XXXX" → [Call].

memo

- The monthly limit fee is set for the au International Call Service. The au International Call Service is unavailable from when the limit fee is confirmed to be exceeded until the end of the same month.
- Even if you cannot use the service by exceeding the limit fee, you can use from the first day of the next month. Also, you can use the domestic call as usual while the service is stopped.
- International call charges are billed together with monthly local call charges.
- If you do not wish to use the service, you can set not to use the au International Call Service.
For au International Call Service:
From au phones 157 (area code not required) (toll free)
From fixed-line phones ☎0077-7-111 (toll free)
Open 9:00 to 20:00 (everyday)

Receiving Calls**Answering an Incoming Call****1 Slide “Answer” down during an incoming call.**

When you receive a call while the backlight illuminates (except for when the Welcome Sheet(Lock Screen) is displayed), tap “Answer”.

2 Talk → [End call].**Display During an Incoming Call**

The following contents are displayed during an incoming call.

- The other party’s phone number is displayed on your screen if he/she notifies you of the phone number. Information such as name is also displayed if his/her phone number and name are registered to the address book. Set face image/body image is displayed on your screen if face image/body image is set.
- If the other party does not notify you of his/her phone number, the reason is displayed on your screen.
“ID Unsent”“Pay Phone”“Not Support”

* Appears when the other party makes a call using a phone which cannot send any phone number.

memo**To mute the ringtone when receiving a call**

- If you press **T** during an incoming call, you can silence the ringtone and stop vibrator or incoming lamp.

When receiving a call while using another function

- When you receive a call while using the address book, mail, etc., the incoming call is prioritized. The function which you have used will be available after the call ends.
- When you receive a call while recording with the voice recorder etc., recording is interrupted and the recorded data is saved.

Putting a Call on Hold**1 Slide “Answer Holding” down during an incoming call.**

When you receive a call while the backlight illuminates (except for when the Welcome Sheet(Lock Screen) is displayed), tap “Answer Holding”.

The call is put on hold. The other party will hear voice guidance indicating that the call is put on hold.

2 [Answer] while the call is put on hold.

The hold state is released.

memo

- The call charges are charged on the other party who has made a call to you while the call is put on hold as well.
- If you disable the hold state once, you cannot put the call on hold again.
- You can put the call on hold only when the product is used in Japan.

Sending SMS (C-mail) to an Incoming Call**1 Slide “Quick reply” down during an incoming call.**

When you receive a call while the backlight illuminates (except for when the Welcome Sheet(Lock Screen) is displayed), tap “Quick reply”.

2 Select a message to send.

You can create and send an SMS (C-mail) by tapping "Custom message...".

The incoming call is disconnected. The other party will hear voice guidance stating that "こちらはauです。おかけになった電話をお呼びしましたが、お出になりません。" (This is au. We called the number you have dialed, but no response).

memo

- ◎ If the other party's phone number is not notified, Quick responses is not available. Also, Quick responses may not be available depending on the communication condition.

Using Menu While Receiving a Call

1 [☰] during an incoming call.

2	Absence Memo	Answer a call with the message of the Answering memo and record the other party's message. <ul style="list-style-type: none">• While recording an Answering memo, tap [☰] → [Rcv. ON]/[Rcv. OFF] to turn on/off the other party's voice.
	Reject	Disconnect an incoming call. The other party will hear voice guidance stating that "こちらはauです。おかけになった電話をお呼びしましたが、お出になりません。" (This is au. We called the number you have dialed, but no response).
	Forwarding	Forward an incoming call to the specified phone number without answering it.
	Silent	Silence the ringtone and stop vibrator or incoming lamp.

memo

- ◎ When forwarding an incoming call without specifying a phone number, the call is forwarded to Answering Service if you have activated the service. Also, when Answering Service is suspended, you cannot forward calls.

Checking Your Phone Number

Checking Your Profile

1 On the home screen, [APPS] → [Settings] → [Profile].

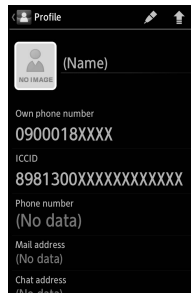

(Profile screen)

memo

- ◎ If a micro au IC-Card is not inserted, "auIC Card(UIM) error. Please insert card" appears when checking your profile. Tap "OK" to display the profile screen. However, information such as Own phone number or ICCID is not displayed. Also, some operations, such as attaching the contents of the profile to mail, may not be carried out. Insert a micro au IC-Card and turn on power again.

Displaying Setting Menu

From Settings, set up and manage functions. You can personalize the wallpaper or ringtone, set up security, initialize data, etc.

1 On the home screen, [APPS] → [Settings].

Item	Description
Profile	Information such as name or residence can be registered, as well as phone number etc. registered in advance. Also, you can attach the information to a mail etc.
Sound settings	Set the manner mode, adjust the call ringtone volume, key touch tone volume, vibration, playback volume, etc.
Wallpaper & display	Make setting for displays such as brightness of the screen and switching text fonts.
Energy saving settings	Activate Energy save.
au ID setting	Set au ID. • For details, refer to "Setting Guide".
microSD & phone storage	Check memory space of microSD memory card and the product, initialize microSD memory card, etc.
Battery	Display battery usage for functions in use per item.
Call	Check talk time and make call settings such as Answering Service (Voice Mail).
Home applications	Switch home applications to use.
Pedometer setting	Make pedometer settings.
Application	Uninstall and forcibly stop installed applications, clear cache, etc.
Wi-Fi	Make Wi-Fi® settings.
Wireless output	Set wireless connection to TVs with a wireless connection function.

Item	Description
Bluetooth	Make Bluetooth® settings.
WiMAX	Make WiMAX settings.
Data usage	Display the data traffic record.
Network settings	Make network settings such as Airplane mode and Home network settings.
Account & sync	Make basic settings for managing online service accounts or synchronizing data.
Location services	Make settings of location information.
Lock & Security	Make Screen lock or security settings.
Language & input	Set the language to be displayed and make character input settings. Make Google voice input settings and Text-to-speech settings.
Reset all	Restore the default settings.
External connection	Set earphone type to use, and make USB connection settings.
Date & time	Set the display format etc. of the date and time.
Accessibility	Set user support services.
Developer options	Set tools etc. for developing applications.
Device info	Check your own phone number, signal level, etc. Perform software update.
Initial setting	Make initial settings. • For details, refer to "Setting Guide".

Appendix

Introduction of Related Accessories

■ Battery Pack (SHI16UAA)

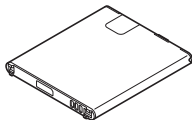

■ Desktop Holder (SHI16PUA)

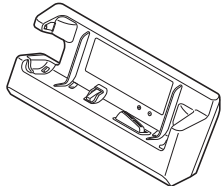

■ au Carrying Case F Black (0105FCA) (sold separately)

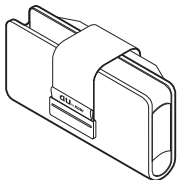

- Common AC Adapter 01 (0202PQA) (sold separately)
- Common AC Adapter 02 (0203PQA) (sold separately)
- Common AC Adapter 03 (0301PQA) (sold separately)
- Common AC Adapter 03 Navy (0301PBA) (sold separately)

- Common AC Adapter 03 Green (0301PGA) (sold separately)
- Common AC Adapter 03 Pink (0301PPA) (sold separately)
- Common AC Adapter 03 Blue (0301PLA) (sold separately)
- AC Adapter MIDORI (0205PGA) (sold separately)
- AC Adapter AO (0204PLA) (sold separately)
- AC Adapter SHIRO (0204PWA) (sold separately)
- AC Adapter MOMO (0204PPA) (sold separately)
- AC Adapter CHA (0204PTA) (sold separately)
- AC Adapter REST (LS1P002A) (sold separately)
- AC Adapter RANGERS (LS1P003A) (sold separately)
- AC Adapter CHARGY (LS1P001A) (sold separately)
- AC Adapter WORLD OF ALICE (LS1P004A) (sold separately)
- AC Adapter KiiRoll (L01P005A) (sold separately)
- AC Adapter JUPITRIS (White) (L02P001W) (sold separately)
- AC Adapter JUPITRIS (Red) (L02P001R) (sold separately)
- AC Adapter JUPITRIS (Blue) (L02P001L) (sold separately)
- AC Adapter JUPITRIS (Pink) (L02P001P) (sold separately)
- AC Adapter JUPITRIS (Champagne) (L02P001N) (sold separately)

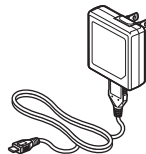

Common AC adapter 03



- Illustrations and forms may not match depending on the AC adapter you use.
- Common AC adapter 01 can only be used in Japan. When you use an AC adapter overseas, choose available one from among the above-mentioned models (except for Common AC adapter 01) to use.

■ Answering Calls

- 1 Press the switch of the earphone/microphone with switch during an incoming call.
- 2 Press the switch of the earphone/microphone with switch to end the call.

Troubleshooting

Before you assume that the product is malfunctioning, check the following:

Trouble	Detail
Cannot turn on the power.	<ul style="list-style-type: none"> • Is the battery pack charged? (▶ P.38) • Is the battery pack attached properly? (▶ P.32) • Did you hold  down? (▶ P.42)
Cannot charge the battery.	<ul style="list-style-type: none"> • Is the battery pack attached properly? (▶ P.32) • Is the power plug of the specified charger (sold separately) securely plugged into an outlet or a cigarette lighter socket? (▶ P.38) • Are the desktop holder, charger terminal, etc. clean? (▶ P.17) • If you use Fast transfer mode, make sure the USB driver is installed to the PC. For the USB driver and install manual, refer to the Support page in SH DASH (http://k-tai.sharp.co.jp/support/a/isw16sh/).
Battery usage time is short.	<ul style="list-style-type: none"> • Make sure you do not often use the product in places where  (out of service area) is displayed. (▶ P.49) • Make sure the battery does not approach the end of its service life. (▶ P.13) • Is the battery pack charged enough? (▶ P.38) • Suspend the functions not being used. (▶ P.50)

Trouble	Detail
Cannot operate the touch panel as intended.	<ul style="list-style-type: none"> • Make sure you are not operating with hands wearing gloves etc. • Make sure you are not operating with the tip of a fingernail or with foreign object between the screen and your fingers. • Check the proper operation of touch panel. (▶ P.44) • Restart the product. (▶ P.42)
Cannot operate the keys/ touch panel.	<ul style="list-style-type: none"> • Turn off the power and then turn it on again. • Is the power turned on? (▶ P.42)
Screen response is slow when you tap on the screen/press the keys.	<ul style="list-style-type: none"> • Screen response may be slowed down when a large amount of data is stored in the product or being transmitted between the main unit and a microSD memory card.
auIC card(UIM) error. is displayed.	<ul style="list-style-type: none"> • Is a micro au IC-Card inserted? (▶ P.34)
Cannot make calls.	<ul style="list-style-type: none"> • Is a micro au IC-Card inserted? (▶ P.34) • Did you enter the correct phone number? (Did you enter the phone number starting with the area code?) (▶ P.55) • Is the power turned on? (▶ P.42) • Did you tap "Call" after entering a phone number? (▶ P.55)
Cannot receive calls.	<ul style="list-style-type: none"> • Is reception good enough? (▶ P.49) • Is the product within the service area? (▶ P.49) • Is the power turned on? (▶ P.42) • Is a micro au IC-Card inserted? (▶ P.34)
Cannot hear the other party.	<ul style="list-style-type: none"> • Is the earpiece volume set to other than minimum? (▶ P.55) • Make sure you are not covering the earpiece with your ear. Place the earpiece over your earhole.
Cannot use NFC/Osaifu-Keitai®.	<ul style="list-style-type: none"> • Make sure the battery has not run out. (▶ P.38)

Trouble	Detail
Cannot recognize a microSD memory card/ Cannot find target data.	<ul style="list-style-type: none"> Is a microSD memory card inserted properly? (▶ P.37) Make sure data is not saved on the main unit (memory). Data can be saved on the main unit (memory) besides a microSD memory card.
The power is turned off automatically.	<ul style="list-style-type: none"> Make sure the battery has not run out. (▶ P.38)
The power is turned off while the wake-up logo is displayed.	<ul style="list-style-type: none"> Make sure the battery has not run out. (▶ P.38)
 (out of service area indicator) appears.	<ul style="list-style-type: none"> Is reception good enough? (▶ P.49) Is the product within the service area? (▶ P.49) Is your finger etc. off the area around the internal antenna? (▶ P.31)
Wi-Fi® cannot be connected.	<ul style="list-style-type: none"> Is reception for Wi-Fi® good enough? (▶ P.49)
WiMAX cannot be connected.	<ul style="list-style-type: none"> Is reception for WiMAX good enough? (▶ P.49)
A message indicating that charging is necessary appears.	<ul style="list-style-type: none"> The battery pack is almost empty. (▶ P.38)
When making a call, a beeping sound is heard from the earpiece and a connection cannot be established.	<ul style="list-style-type: none"> Is reception good enough? (▶ P.49) Is the product within the service area? (▶ P.49) The wireless line is busy or the other party is on another line. Try again later.
Cannot use the microphone of earphone/microphone.	<ul style="list-style-type: none"> Make sure "Without microphone" is not set for "Earphone type". (▶ P.62) Is the connector of the microphone inserted properly? Insert the connector securely.
Cannot operate the respective address book settings.	<ul style="list-style-type: none"> Is the other party's phone number notified? If there is no notification, the settings of the address book are not enabled.
Cannot operate the camera.	<ul style="list-style-type: none"> Is there enough power left in the battery pack? (▶ P.38)

For more details, contact the Customer Service Center.

From a fixed-line phone, **☎ 0077-7-111**

From an au cell phone, **157** without area code

Updating Software or OS

Mobile Update (Software Update)

The product supports the mobile update. The mobile update is a function to update software of the product.

The methods for updating software of the product available by the mobile update are described as follows. Restarting the product before and after software update is required regardless of the updating method. When the automatic updating style is set, the product will automatically restart.

Method	Detail
Manual update	Check whether software update is necessary or not by connecting the product to the network. <ul style="list-style-type: none"> When it is necessary, you can choose whether to update immediately or to update later (update reservation).
Automatic update	Update software when receiving a software update notification from au. <ul style="list-style-type: none"> You can also choose whether to automatically update (automatic updating style) or to display the confirmation screen (user approval style) after receiving the notification.

1 On the home screen, [APPS] → [Settings] → [Device info] → [Software update].

Update	<p>Check whether software update is necessary or not (manual update). The confirmation starts when you tap "Execute". When it is necessary, you can choose whether to update immediately or to update later (update reservation).</p> <ul style="list-style-type: none"> • If you want to update immediately, tap "Execute" to start the download of data needed for software update. When the download has completed and the product has restarted, software will be updated. • If you want to update later (update reservation), tap "++予約" to start the download of data needed for software update. When the download has completed, the screen for setting the date and time to start software update will be displayed. If you set the date and time → tap [+ +予約], the product will automatically restart at the set time of the day for the update and software will be updated.
Auto Setup	<p>Set whether to automatically start the download of data needed for software update and to update software when receiving a notification for the update in automatic updating style.</p>
Reserve Time	<p>Change the set date and time to start software update.</p> <ul style="list-style-type: none"> • If you tap "++解除", you can cancel the update reservation.
Reminder	<p>Set whether to display a notification for the update repeatedly.</p>

memo

- ◎ If you enable "Automatic date & time" in "Date & time" or change the settings of "Set date" and "Set time" after setting the date and time to start software update, the update reservation will be canceled.

- ◎ If you cancel the update reservation, carry out "Update" once again to update software. When you carry out "Update" after canceling the update reservation, restart the product by following the screen.

Notes on Software Update

- You are charged for data communication when connecting to the Internet from the product by using packet communication.
 - When software update is necessary, you will be informed on au homepage, etc. For details, contact an au shop or Customer Service Center (call toll-free 157). In addition, users of the ISW16SH will receive a notice from au, when software update is necessary to improve the functionality of the ISW16SH.
 - It is recommended to back up your data before updating software.
 - If the mobile update has failed or stopped, perform the same procedures again.
 - If the mobile update fails, it may become impossible to operate the product. If this happens, bring it to an au shop or PiPit (not accepted by some shops).
 - Charge the battery sufficiently before starting update. If the battery level is insufficient or the battery runs out during the update, the mobile update will fail.
 - Check out the signal reception status. The mobile update may fail if the product is in a place with bad signal reception status.
 - Various data registered on the product (address books, mails, still pictures, music data, etc.) and information of settings will not be changed even after software is updated. However, note that data may not be protected depending on the state of the product (fault, damage, getting wet with water, etc.).
 - After software is updated, the download of next update software may automatically start (consecutive update).
 - The mobile update is not available when using overseas network.
- Do not conduct the following operations during the mobile update**
- Do not remove the battery pack during software update. Doing so may cause the mobile update failure.
 - Do not move during software update.

The following operations are not available during the mobile update

- Operations are not available during software update. Making a call to 110 (Police), 119 (Fire and Ambulance), 118 (Regional Coast Guard Headquarters) or 157 (Customer Service Center) is not available either. Also, the alarm etc. does not function.

■ When an Update Notification (Automatic Updating Style) is Received

When a "software update notification" in automatic updating style is received, the download of data needed for software update will automatically start. When the download has completed, software will be updated.

memo

- When you set "Auto Setup" to "OFF", the confirmation screen is displayed in the same way as in user approval style.

■ When an Update Notification (User Approval Style) is Received

When a software update notification in user approval style is received, the confirmation screen is displayed.

■ When you want to update immediately

Tap "Execute" to start the download of data needed for software update. When the download has completed and the product has restarted, software will be updated.

■ When you want to update later

Tap "" to stop the update. Carry out the mobile update again with "Update".

Major Update (OS Update)

Major update is a function to update the OS of the product.

1 On the home screen, [APPS] → [Settings] → [Device info] → [Major Update].

2 Confirm update	Check manually whether update is available. <ul style="list-style-type: none">• When a message indicating that a new version has been released appears, tap "OK" to activate the browser and display methods for the major update. Confirm the details.
Start update	Carry out OS update via Wi-Fi®. <ul style="list-style-type: none">• Data for the update are save on microSD memory cards. Insert one in advance.
Check for updates	Set whether to regularly and automatically check the presence of new update available.

After-Sales Service

■ When Asking for Repair

For repair, contact Secure cell phone support center.

During the warranty period	Repairs will be done based on the <terms of services of the free-of-charge repair warranty> described on the warranty card.
Outside the warranty period	We shall repair the product for a charge as requested by the customer if repair renders it usable.

memo

- Before handing in the product for repair, make a backup of the contents of memory since they may disappear during repair. Note that the Company shall not be liable for any damages and loss of income should the contents of memory be altered or lost.
- Recycled parts that meet the Company's quality standards are sometimes used for repair.

◎ Old au phones collected via Replacement cell phone delivery service will be reused as cell phones for replacement after they are recovered and repaired. Also, old mechanical parts replaced via the au after-sales service will be collected and recycled by the Company and cannot be returned to the customer.

■ Performance Parts for Repair

The Company retains performance parts for repair of the ISW16SH main unit and its peripherals for 6 years after discontinuation of production. "Performance parts for repair" refers to parts required for maintaining the functions of the product.

■ Warranty Card

At the store of purchase, thoroughly check and read the name of the retailer, date of purchase and other necessary details filled in on the warranty card, and be sure to keep it in a safe place.

■ Secure cell phone support plus

An after-sales service membership program on a monthly basis called "Secure cell phone support plus" (monthly fee: 399 yen including tax) is available for using your au cell phone for a long time without worries. This service expands coverage for many troubles including malfunction, theft and loss. For details of this service, check on the au homepage or contact Secure cell phone support center.

memo

- ◎ You can apply for membership only at the time of purchasing your au cell phone.
- ◎ Once you cancel the membership, you cannot reapply for it until you purchase an au cell phone next time.
- ◎ Note that when changing the model or purchasing an extra cell phone, this service only covers the most recently purchased au cell phone.
- ◎ When an au cell phone is handed over to you or someone else, the Secure cell phone support plus membership is also handed over to the successor of the cell phone.

- ◎ When you get a new au cell phone by changing the model, purchasing an extra cell phone, etc., the Secure cell phone support plus membership for the old au cell phone is automatically canceled.
- ◎ Service contents are subject to change without notice.

■ micro au IC-Card

The micro au IC-Card is lent to you by au. In case of loss or damage, the card will be replaced at your expense. When malfunction is suspected, or in case of theft or loss, contact an au shop or PiPi.

■ After-Sales Service

If you are unsure about anything regarding after-sales service, contact the following service counter.

Customer Service Center (for service canceling procedure or operation in case of loss or theft)

From a fixed-line phone, ☎ **0077-7-113** (toll free)

From an au cell phone, **113** without area code (toll free)

Secure cell phone support center (for loss, theft or damage)

From a fixed-line phone/an au cell phone,

☎ **0120-925-919** (toll free)

Business hours 9:00 to 21:00 (7 days a week)

■ au After-Sales Service Information

Service contents	Secure cell phone support plus member	Free member
Replacement cell phone delivery service (spontaneous failure: 1st year)	Free	N/A
Replacement cell phone delivery service (spontaneous failure: 2nd year and later)	Customer charge 1st: 5,250 yen 2nd: 8,400 yen	N/A

Service contents	Secure cell phone support plus member	Free member
Replacement cell phone delivery service (partial damage, water soak, irreparable damage, theft and loss)	Customer charge 1st: 5,250 yen 2nd: 8,400 yen	N/A
Holding over and repair (spontaneous failure: 1st year)	Free	Free
Holding over and repair (spontaneous failure: 2nd year and later)	Free (three-year warranty)	Actual cost
Holding over and repair (partial damage)	Customer charge Upper limit: 5,250 yen	Actual cost
Holding over and repair (water soak, irreparable damage, theft and loss)	N/A	N/A (model change)

* All the prices written above include tax.

memo

Replacement cell phone delivery service

- ⊙ When you have trouble with your au phone, you can have a cell phone for replacement (same model and color as your old one with new battery included) delivered to any destination that you specify. Please return your old au phone got out of order within 14 days after the cell phone for replacement is delivered to you.
- ⊙ You can use this service up to twice within one year starting from the day when you first use this service. If you have not used this service over the past one year at the time of your application for this service, the application will be regarded as your first time. If you have, the application will be regarded as your second time.

* For details, check on the au homepage.

Holding over and repair

- ⊙ Repairs due to water soak and irreparable damage are not covered by this service.
- ⊙ Damages and malfunctions intentionally caused by the customer as well as those due to modification (e.g. disassembly, change of parts, painting, etc.) by the customer are not covered by this service.

- ⊙ You cannot receive a refund for replacement of the outer casing due to stains, scratches, paint removal, etc. on the outer casing.

Available Data Formats

Formats of image, video and audio available on the product are as follows.

Image

Data format	Extension
JPEG image, decoration-emoji (JPG)	.jpg, .jpeg
GIF, GIF animation, decoration-emoji (GIF)	.gif
Image: PNG	.png
Image: BMP	.bmp
Image: WBMP	.wbmp
Image: WEBP	.webp

Video

Data format	Extension
Video: 3GPP (MPEG-4 SP)	.3gpp
Video: 3GP (MPEG-4 SP), Video: H.263, Video: H.264 AVC, videos recorded with the camera	.3gp
EZ movie (H.264), EZ movie (MEPG4)	.3g2
Video: 3GPP2	.3gpp2
Video: H.264 AVC	.mp4
Video: MP4	.m4v
Video: WMV	.wmv
Advanced Streaming Format	.asf
PlayReady movie: PYV	.pyv
PlayReady movie: ISMV	.ismv
Video: WEBM	.webm
Video: MKV	.mkv
Video: TS	.ts

Audio

Data format	Extension
Audio: AMR-Narrow band	.amr
Audio: 3GPP (AAC LC/LTP, HE-AACv1 (AAC+), HE-AACv2 (enhanced AAC+)), Chaku-Uta® (AAC, HE AAC), Voice (only AMR)	.3gp
Voice (AMR), Chaku-Uta® (AAC, HE AAC)	.3g2
Audio: MPEG4 (AAC LC/LTP, HE-AACv1 (AAC+), HE-AACv2 (enhanced AAC+))	.m4a, .mp4
Audio: MP3 (8 to 320 kbps CBR or VBR)	.mp3
Audio: WMA	.wma
PlayReady music: PYA	.pya
PlayReady music: ISMA	.isma
Audio: MIDI	.mid, .midi, .xmf, .rttl, .rtx, .ota
Audio: Adjustable audio file format developed by Xiph.Org	.ogg, .oga
Audio: iMelody (unique to Ericsson/SonyEricsson)	.imy
Audio: PCM/WAVE	.wav
Audio: SMF	.smf

Main Specifications

Display	Approx. 4.6 inches, approx. 16.77 million colors, highly transparent CGSilicon LCD, 1,280x720 (HD)
Weight	Approx. 136 g (including the battery pack)
Size (WxHxD)	Approx. 66 mmx126 mmx11.2 mm (thickest part 11.6 mm)
CPU	MSM8660A 1.5 GHz Dual-core
Memory (built-in (ROM))*1	Approx. 16 GB
Continuous talk time (in Japan)	Approx. 510 min
Continuous talk time (overseas (GSM))	Approx. 530 min

Continuous talk time (overseas (CDMA)) ²	Approx. 650 min (U.S./Mexico/Saipan/Chinese mainland/Hawaii/South Korea/Taiwan/Indonesia/Israel/India/Vietnam/New Zealand ³ /Thailand ⁴ /Macau/Bangladesh/Bermuda Islands/Bahamas/Venezuela/Hong Kong)
Continuous standby time (in Japan)	Approx. 360 hours (while 3G is used) Approx. 160 hours (while 3G and Wi-Fi® are used) Approx. 210 hours (while 3G and WiMAX are used)
Continuous standby time (overseas (GSM))	Approx. 430 hours
Continuous standby time (overseas (CDMA)) ²	Approx. 200 hours (U.S./Mexico/Saipan/Chinese mainland) Approx. 310 hours (Hawaii/South Korea/Taiwan/Indonesia/Israel/India/Vietnam/Bangladesh/Bahamas/Hong Kong) Approx. 430 hours (New Zealand ³ /Thailand ⁴ /Macau/Bermuda Islands/Venezuela)
Charging time	Desktop holder: Approx. 200 min Common AC adapter 03 (sold separately): Approx. 190 min Common DC adapter 03 (sold separately): Approx. 280 min
Camera device	Out camera CMOS image sensor In camera CMOS image sensor
Effective pixels	Out camera Approx. 12.11 million pixels In camera Approx. 0.31 million pixels
Picture size of still picture/ Magnification and its steps	Out camera VGA: 480x640/4.00-fold and 13 steps HD: 720x1,280/4.00-fold and 13 steps FULL HD: 1,080x1,920/4.00-fold and 13 steps 3M: 1,536x2,048/4.00-fold and 13 steps QFHD: 2,160x3,840/4.00-fold and 13 steps 12M: 3,000x4,000/4.00-fold and 13 steps In camera VGA: 640x480/No zoom

Picture size of video/ Magnification and its steps/ Recording time ⁵	Out camera QVGA: 320×240/4.00-fold and 13 steps/Max. approx 90 min VGA: 640×480/4.00-fold and 13 steps/Max. approx 90 min HD: 1,280×720/4.00-fold and 13 steps/Max. approx 44 min FULL HD: 1,920×1,080/4.00-fold and 13 steps/Max. approx 16 min In camera QVGA: 320×240/No zoom/Max. approx 90 min VGA: 640×480/No zoom/Max. approx 90 min
Bluetooth® Function	Communication method: Bluetooth® Standard Ver.3.0 Output: Bluetooth® Standard Power Class 2 Communication distance ⁶ : Within 10 m with no obstacles in the range Compatible Bluetooth® profile ⁷ : HSP (Headset Profile), HFP (Hands-Free Profile), A2DP (Advanced Audio Distribution Profile), AVRCP (Audio/Video Remote Control Profile) Ver.1.3, OPP (Object Push Profile), SPP (Serial Port Profile), PBAP (Phone Book Access Profile) ⁸ , DUN (Dial-up Networking Profile), HID (Human Interface Device Profile), HDP (Health Device Profile), PAN (Personal Area Networking Profile) Frequency bands: 2.4 GHz band (2.402 GHz to 2.480 GHz)
Mobile light source LED characteristics	a) Continuous illumination b) Wavelength White: 400-700 nm Red: 600-670 nm c) Maximum output White: 580 μW (inside cell phone 1.8 mW) Red: 103 μW (inside cell phone 240 μW)
Network environment	Wireless LAN (Wi-Fi®) function: IEEE802.11a/b/g/n (2.4 GHz/5 GHz) Standard WiMAX
Interface	microUSB jack, 3.5 φ (quadrupoles) earphone/microphone jack

¹ Since data and applications share the saving space, available memory capacity on the main unit decreases depending on how much space the applications in use are taking up.

² Information on the intended countries is valid as of May 2012.

³ The service provision will end on July 31, 2012.

⁴ The service provision will end on July 1, 2012.

⁵ The recording time is based on the case when a microSD memory card (2 GB to 32 GB) is attached. However, it varies depending on the capacity on the microSD memory card, recording condition, memory space of other saved data, etc. Also, the recording time decreases depending on the temperature at the location where the product is used and using condition.

⁶ Changes according to objects obstructing devices and signal reception.

⁷ Specifications provided in Bluetooth standards for making communication between Bluetooth-compatible devices in accordance with their intended use.

⁸ Some contents of address books data may not be properly displayed on the device of the other party.

memo

- The continuous talk time and continuous standby time may drop to less than half depending on the battery charging status, usage environment such as temperature, reception condition at the location where the product is used, and the function settings.

E-mail

Newly compose	Destination: 30 (including To/Cc/Bcc) Subject: 50 full-width/100 half-width characters Message: Approx 5,000 full-width/10,000 half-width characters Attached data: Up to 5 files can be attached. Max. 2 MB when all 5 files put together
Receive	Subject: 50 full-width/100 half-width characters Message: Approx 5,000 full-width/10,000 half-width characters Attached data: Up to 25 files can be received. Max. 2 MB per file. Max. 3 MB per e-mail
Server	Saving capacity: 12 MB or Max. 500 e-mails Saving duration: 30 days
Inbox	Number of savable e-mails: Max. 2,000 e-mails [*] Protected e-mails capacity: Max. 1,000 e-mails
Outbox	Number of savable e-mails: Max. 1,000 e-mails [*] Protected e-mails capacity: Max. 500 e-mails

^{*} The number of e-mails which can actually be saved may decrease depending on the free space on the main unit (system).

memo

- ◎ The number of e-mails which can be sent per day is up to 1,000 (including the number of carbon copies).

■ SMS (C-mail)

Newly compose	Message: 70 full-width/140 half-width characters
SMS (C-mail) center	Number of savable SMSs (C-mails): No limit Saving duration: Up to 72 hours after the SMS (C-mail) is stored to the SMS (C-mail) center
Mail Filters	Number of SMSs (C-mails) which you can specified: 10
Inbox	Number of savable SMSs (C-mails): Max. 1,000* Protected SMSs (C-mails) capacity: Max. 500
Outbox	Number of savable SMSs (C-mails): Max. 1,000* Protected SMSs (C-mails) capacity: Max. 500

* The number of SMSs (C-mails) which can actually be saved may decrease depending on the free space on the main unit (system).

■ 1Seg

Time you can watch continuously	Approx. 6 hours and 00 min
---------------------------------	----------------------------

* The time you can watch continuously varies depending on the using condition.

■ Tethering

Continuous tethering time	Approx. 360 min (WAN side WiMAX) Approx. 330 min (WAN side 3G (EVDO))
---------------------------	--

Specific Absorption Rate (SAR) of Cell Phones

This model [ISW16SH] mobile phone complies with Japanese technical regulations and international guidelines regarding exposure to radio waves. This mobile phone has been designed in observance of the Japanese technical regulations regarding exposure to radio waves (*1) and limits to exposure to radio waves recommended by equivalent international guidelines.

These international guidelines were set out by the International Commission on Non-Ionizing Radiation Protection (ICNIRP), which is in collaboration with the World Health Organization (WHO), and the permissible limits include a substantial safety margin designed to assure the safety of all persons, regardless of age and health condition. The Japanese technical regulations and international guidelines define the limits using a unit of measurement known as the Specific Absorption Rate (SAR), which represents the average amount of radio frequency energy absorbed by the human head. The SAR limit for mobile phones is 2.0 W/kg. The highest SAR value for this mobile phone when tested for use at the ear is 0.848 W/kg. There may be slight differences in SAR levels among individual products, but they all satisfy the limit. The actual SAR of this mobile phone while talking on the phone can be well below that indicated above. This is due to automatic changes in the power level of the mobile phone to ensure it only outputs the minimum power required to communicate with a base station. Therefore in general, the closer you are to a base station, the lower the power output of the mobile phone. This mobile phone can be used in positions other than against your ear. This mobile phone satisfies the international guidelines when used with au Carrying Case F Black (0105FCA) (sold separately) recommended by KDDI (*2).

In case you are not using the au Carrying Case F Black (0105FCA) (sold separately), use a product that contains no metal parts, and one that can hold the mobile phone at least 1.5 cm away from your body.

The World Health Organization has stated that “a large number of studies have been performed over the last two decades to assess whether mobile phones pose a potential health risk. To date, no adverse health effects have been established as being caused by mobile phone use.” If you would like to know more detailed information, please refer to the WHO website.

(http://www.who.int/docstore/peh-emf/publications/facts_press/fact_english.htm)

Please refer to the websites listed below if you would like to know more detailed information regarding SAR.

- Ministry of Internal Affairs and Communications website:
<http://www.tele.soumu.go.jp/e/sys/ele/index.htm>
- Association of Radio Industries and Businesses website:
<http://www.arib-emf.org/index02.html>
- au homepage:
<http://www.au.kddi.com/>
- SHARP homepage:
<http://www.sharp.co.jp/products/menu/phone/cellular/sar/index.html>

- *1 Technical regulations are defined by the Ministerial Ordinance Related to the Radio Law (Article 14-2 of Radio Equipment Regulations).
- *2 Regarding the method of measuring SAR when using mobile phones in positions other than against the ear, international standards (IEC62209-2) were set in March of 2010. On the other hand, technical regulation is currently being deliberated on by national council (As of October, 2011).

CE Declaration of Conformity



In some countries/regions, such as France, there are restrictions on the use of Wi-Fi®. If you intend to use Wi-Fi® on the handset abroad, check the local laws and regulations beforehand.

Hereby, Sharp Telecommunications of Europe Ltd, declares that this ISW16SH is in compliance with the essential requirements and other relevant provisions of Directive 1999/5/EC.

A copy of the original declaration of conformity can be found at the following Internet address:
<http://www.sharp.co.jp/k-tai/>

■ Mobile Light

Do not point the illuminated light directly at someone's eyes.

Be especially careful not to shoot small children from a very close distance.

Do not use Mobile light near people's faces. Eyesight may be temporarily affected leading to accidents.

EN60825-1:1994 A1:2002 & A2:2001

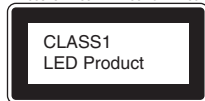

Mobile light

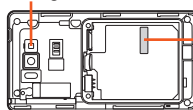

CAUTION-CLASS 1M
LED RADIATION WHEN OPEN
DO NOT VIEW DIRECTLY WITH
OPTICAL INSTRUMENTS

CAUTION:

Use of controls, adjustments or performance of procedure other than those specified herein may result in hazardous radiation exposure. As the emission level from Mobile light LED used in this product is harmful to the eyes, do not attempt to disassemble the cabinet. Servicing is limited to qualified servicing station only.

Mobile light source LED characteristics

- a) Continuous illumination
- b) Wavelength
 - White: 400-700 nm
 - Red: 600-670 nm
- c) Maximum output
 - White: 580 μ W (inside cell phone 1.8 mW)
 - Red: 103 μ W (inside cell phone 240 μ W)

■ AC Adapter

Any AC adapter used with this handset must be suitably approved with a 5Vdc SELV output which meets limited power source requirements as specified in EN/IEC 60950-1 clause 2.5.

■ Battery - CAUTION

Use specified battery or Charger only.

Non-specified equipment use may cause malfunctions, electric shock or fire due to battery leakage, overheating or bursting.

Do not dispose of an exhausted battery with ordinary refuse; always tape over battery terminals before disposal. Take battery to an au Shop, or follow the local disposal regulations.

Charge battery in ambient temperatures between 5°C and 35°C; outside this range, battery may leak/overheat and performance may deteriorate.

■ Loudness Warning

Excessive sound pressure from earphones and headphones can cause hearing loss.

■ Headphone Signal Level

The maximum output voltage for the music player function, measured in accordance with EN 50332-2, is 36 mV.

■ European RF Exposure Information

Your mobile device is a radio transmitter and receiver. It is designed not to exceed the limits for exposure to radio waves recommended by international guidelines. These guidelines were developed by the independent scientific organization ICNIRP and include safety margins designed to assure the protection of all persons, regardless of age and health.

The guidelines use a unit of measurement known as the Specific Absorption Rate, or SAR. The SAR limit for mobile devices is 2 W/kg and the highest SAR value for this device when tested at the ear was 0.462 W/kg*.

As SAR is measured utilizing the devices highest transmitting power the actual SAR of this device while operating is typically below that indicated above. This is due to automatic changes to the power level of the device to ensure it only uses the minimum level required to reach the network.

The World Health Organization has stated that present scientific information does not indicate the need for any special precautions for the use of mobile devices. They note that if you want to reduce your exposure then you can do so by limiting the length of calls or using a hands-free device to keep the mobile phone away from the head.

* The tests are carried out in accordance with international guidelines for testing.

FCC Notice

- This device complies with part 15 of the FCC Rules. Operation is subject to the following two conditions:
(1) This device may not cause harmful interference, and (2) this device must accept any interference received, including interference that may cause undesired operation.
- Changes or modifications not expressly approved by the manufacturer responsible for compliance could void the user's authority to operate the equipment.

Information to User

This equipment has been tested and found to comply with the limits of a Class B digital device, pursuant to Part 15 of the FCC Rules. These limits are designed to provide reasonable protection against harmful interference in a residential installation. This equipment generates, uses and can radiate radio frequency energy and, if not installed and used in accordance with the instructions, may cause harmful interference to radio communications.

However, there is no guarantee that interference will not occur in a particular installation; if this equipment does cause harmful interference to radio or television reception, which can be determined by turning the equipment off and on, the user is encouraged to try to correct the interference by one or more of the following measures:

1. Reorient/relocate the receiving antenna.
2. Increase the separation between the equipment and receiver.
3. Connect the equipment into an outlet on a circuit different from that to which the receiver is connected.
4. Consult the dealer or an experienced radio/TV technician for help.

FCC RF Exposure Information

Your handset is a radio transmitter and receiver. It is designed and manufactured not to exceed the emission limits for exposure to radio frequency (RF) energy set by the Federal Communications Commission of the U.S. Government.

The guidelines are based on standards that were developed by independent scientific organizations through periodic and thorough evaluation of scientific studies. The standards include a substantial safety margin designed to assure the safety of all persons, regardless of age and health.

The exposure standard for wireless handsets employs a unit of measurement known as the Specific Absorption Rate, or SAR. The SAR limit set by the FCC is 1.6 W/kg.

Highest SAR value:

Model	CDMA SHI16
FCC ID	APYHRO00172
At the Ear	0.521 W/kg
On the Body	0.327 W/kg

This device was tested for typical body-worn operations with the back of the handset kept 1.5 cm from the body. To maintain compliance with FCC RF exposure requirements, use accessories that maintain a 1.5 cm separation distance between the user's body and the back of the handset. The use of belt clips, holsters and similar accessories should not contain metallic components in its assembly.

The use of accessories that do not satisfy these requirements may not comply with FCC RF exposure requirements, and should be avoided.

The FCC has granted an Equipment Authorization for this model handset with all reported SAR levels evaluated as in compliance with the FCC RF emission guidelines. SAR information on this model handset is on file with the FCC and can be found at <http://www.fcc.gov/oet/fccid/> under the Display Grant section after searching on the corresponding FCC ID (see table above).

Additional information on Specific Absorption Rates (SAR) can be found on the Cellular Telecommunications & Internet Association (CTIA)

Website at <http://www.phonefacts.net>.

Export Administration Regulations

The product and its accessories may be subject to the Japan Export Administration Regulations ("Foreign Exchange and Foreign Trade Law" and its related laws). In addition, U.S. Re-export Regulations (Export Administration Regulations) may apply to the product and its accessories. To export and re-export the product and its accessories, take the required measures on your responsibility and at your expenses. For details on the procedures, contact the Ministry of Economy, Trade and Industry or the U.S. Department of Commerce.

Intellectual Property Rights

Trademarks

The company names and product names appearing in this manual are trademarks or registered trademarks of their respective holders.

- The microSD logo, microSDHC logo and microSDXC logo are trademarks of SD-3C and LLC.



- The Bluetooth® word mark and logo are registered trademarks owned by the Bluetooth SIG, Inc., and SHARP CORPORATION is licensed to use these trademarks.



- Wi-Fi® is a registered trademark of Wi-Fi Alliance®.



- Wi-Fi Protected Setup™ and Wi-Fi Protected Setup logo are trademarks of Wi-Fi Alliance®.

The Wi-Fi Protected Setup Mark is a mark of the Wi-Fi Alliance.



- Wi-Fi Direct™ is a trademark of Wi-Fi Alliance®.
- " A OSS™ " is a trademark of BUFFALO INC.



- WiMAX is a trademark or registered trademark of the WiMAX Forum.
- The official name for Microsoft® Windows® is Microsoft® Windows® Operating System.
- Microsoft® Windows®, Windows Vista®, Microsoft® Excel®, Microsoft® PowerPoint®, Windows Media® and Exchange® are trademarks or registered trademarks of Microsoft Corporation in the U.S.A. and other countries.
- Microsoft® Word and Microsoft® Office are product names of Microsoft Corporation in the U.S.A.

- Music recognition technology and related data are provided by Gracenote®. Gracenote is a business standard for music recognition technology and related contents delivery.

For details, refer to the following web page: www.gracenote.com

CD and music data provided by Gracenote: Copyright © 2000 - present Gracenote.

Gracenote Software: Copyright 2000 - present Gracenote.

This product and services may include one or several of the following US Patent. #5,987,525, #6,061,680, #6,154,773, #6,161,132, #6,230,192, #6,230,207, #6,240,459, #6,330,593, and other granted or applied patents. Part of services are provided by Open Globe, Inc. for US patent (#6,304,523) under license.

Gracenote and CDDB are registered trademarks of Gracenote, Inc.

Logo and logo type of Gracenote and "Powered by Gracenote" logo are trademarks of Gracenote, Inc.

For information on the use of Gracenote services, refer to the following web page: www.gracenote.com/corporate



- QR code is a registered trademark of DENSO WAVE INCORPORATED.
- Osaifu-Keitai is a registered trademark of NTT DOCOMO, INC.
- FeliCa is a contactless IC card technology developed by Sony Corporation. FeliCa is a registered trademark of Sony Corporation.
-  is a registered trademark of FeliCa Networks, Inc.
- Twitter and Twitter logo are trademarks or registered trademarks of Twitter, Inc.
- Facebook and Facebook logo are trademarks or registered trademarks of Facebook, Inc.
- "mixi" and "mymixi" are trademark and/or registered trademark of mixi, Inc.
- Google, Google logo, Android, Android logo, Google Play™, Google Play logo, Google+, Google+ logo, Gmail™, Gmail logo, Calendar logo, Google Maps™, Google Maps logo, Google Talk™, Google Talk logo, Google Voice Search™ logo, Picasa™, Picasa logo, YouTube and YouTube logo are trademarks or registered trademarks of Google Inc.
- The Skype name, associated trade marks and logos and the "S" logo are trademarks of Skype Limited.

- "jibe" is a trademark of Jibe Mobile.
- "GREE" is a registered trademark or trademark of Gree, Inc. in Japan.
- ロヴィ, Rovi, Gガイド, G-GUIDE, Gガイドモバイル, G-GUIDE MOBILE, and any other G-GUIDE-related logos are trademarks or registered trademarks of US-based Rovi Corporation and/or its affiliated companies in Japan.
- TRENDMICRO, VirusBuster are trademarks of Trend Micro Inc.
- Copyright (C) 2010 - Three Laws of Mobility. All Rights Reserved.



- The "RSA Secure" AND "Genuine RSA" logos are trademarks of RSA Data Security, Inc.



- DLNA®, the DLNA Logo and DLNA CERTIFIED™ are trademarks, service marks, or certification marks of the Digital Living Network Alliance. Sharp Corporation has acquired DLNA certification for the device.
- Oracle and Java are registered trademarks of Oracle and/or its affiliates. Other names may be trademarks of their respective owners.



- "Chaku-Uta®", "Chaku-Uta-Full®" and "Chaku-Uta-Full-Plus®" is a registered trademark of the Sony Music Entertainment (Japan) Inc.

- "VeilView", "Best select photo", "Chase focus", "Egao focus shutter", "Furimuki shutter", "AQUOS", "AQUOS PHONE", "SERIE", "ファミリンク", "FAMILINK", the "エゴ技" symbol and "エゴ技", "OneTouch Shutter", "GALAPAGOS", "SH SHOW", "CGSilicon", "LCフォント", "LCFONT" and the LC logo symbol are registered trademarks or trademarks of Sharp Corporation.



- Included Document Viewer is Documents To Go provided by DataViz, Inc. © 2011 DataViz, Inc. and its licensors. All rights reserved. DataViz, Documents To Go and InTact Technology are trademarks or registered trademarks of DataViz, Inc.
- PhotoScouter® and TrackSolid® are registered trademarks or trademarks of Morpho, Inc.
- MyScript® Stylus Mobile is a trademark of VISION OBJECTS.
- CP8 PATENT
- Content owners use Microsoft PlayReady™ content access technology to protect their intellectual property, including copyrighted content. This device uses PlayReady technology to access PlayReady-protected content and/or WMDRM-protected content. If the device fails to properly enforce restrictions on content usage, content owners may require Microsoft to revoke the device's ability to consume PlayReady-protected content. Revocation should not affect unprotected content or content protected by other content access technologies. Content owners may require you to upgrade PlayReady to access their content. If you decline an upgrade, you will not be able to access content that requires the upgrade.
- iWnn of OMRON SOFTWARE Co., Ltd. is used for conversion methods for Japanese language, and for phrase prediction methods for English. iWnn © OMRON SOFTWARE Co., Ltd. 2008-2012 All Rights Reserved. iWnn IME © OMRON SOFTWARE Co., Ltd. 2009-2012 All Rights Reserved.
- Shin Go M, the font type installed in this product, is provided by Morisawa & Company, Ltd. "Morisawa" and "Shin Go" are registered trademarks or trademarks of Morisawa & Company, Ltd.
- Portions Copyright ©2004 Intel Corporation

- The MHL logo, MHL and Mobile High-Definition Link are trademarks of MHL, LLC.



- aptX is a registered trademark of CSR plc.
- The product includes pictograms that SHARP CORPORATION is licensed by NTT DOCOMO, INC.

■ Open Source Software

- The product includes software based on GNU General Public License (GPL), GNU Lesser General Public License (LGPL) and other licenses. For details on licenses of related software, on the home screen, tap [APPS] → [Settings] → [Device info] → [Legal information] → [Open source licenses].
- Source codes of software based on GPL, LGPL and Mozilla Public License (MPL) can be referred to on the following site for free. For details, refer to the following site. <https://sh-dev.sharp.co.jp/android/modules/oss/>

■ OpenSSL License

[OpenSSL License]

Copyright © 1998-2009 The OpenSSL Project. All rights reserved.

This product includes software developed by the OpenSSL Project for use in the OpenSSL Toolkit. (<http://www.openssl.org/>)

THIS SOFTWARE IS PROVIDED BY THE OpenSSL PROJECT "AS IS" AND ANY EXPRESSED OR IMPLIED WARRANTIES, INCLUDING, BUT NOT LIMITED TO, THE IMPLIED WARRANTIES OF MERCHANTABILITY AND FITNESS FOR A PARTICULAR PURPOSE ARE DISCLAIMED. IN NO EVENT SHALL THE OpenSSL PROJECT OR ITS CONTRIBUTORS BE LIABLE FOR ANY DIRECT, INDIRECT, INCIDENTAL, SPECIAL, EXEMPLARY, OR CONSEQUENTIAL DAMAGES (INCLUDING, BUT NOT LIMITED TO, PROCUREMENT OF SUBSTITUTE GOODS OR SERVICES; LOSS OF USE, DATA, OR PROFITS; OR BUSINESS INTERRUPTION) HOWEVER CAUSED AND ON ANY THEORY OF LIABILITY, WHETHER IN CONTRACT, STRICT LIABILITY, OR TORT (INCLUDING NEGLIGENCE OR OTHERWISE) ARISING IN ANY WAY OUT OF THE USE OF THIS SOFTWARE, EVEN IF ADVISED OF THE POSSIBILITY OF SUCH DAMAGE.

【Original SSLeay License】

Copyright © 1995-1998 Eric Young (eay@cryptsoft.com) All rights reserved.

This product includes cryptographic software written by Eric Young

(eay@cryptsoft.com)

THIS SOFTWARE IS PROVIDED BY ERIC YOUNG "AS IS" AND ANY EXPRESS OR IMPLIED WARRANTIES, INCLUDING, BUT NOT LIMITED TO, THE IMPLIED WARRANTIES OF MERCHANTABILITY AND FITNESS FOR A PARTICULAR PURPOSE ARE DISCLAIMED. IN NO EVENT SHALL THE AUTHOR OR CONTRIBUTORS BE LIABLE FOR ANY DIRECT, INDIRECT, INCIDENTAL, SPECIAL, EXEMPLARY, OR CONSEQUENTIAL DAMAGES (INCLUDING, BUT NOT LIMITED TO, PROCUREMENT OF SUBSTITUTE GOODS OR SERVICES; LOSS OF USE, DATA, OR PROFITS; OR BUSINESS INTERRUPTION) HOWEVER CAUSED AND ON ANY THEORY OF LIABILITY, WHETHER IN CONTRACT, STRICT LIABILITY, OR TORT (INCLUDING NEGLIGENCE OR OTHERWISE) ARISING IN ANY WAY OUT OF THE USE OF THIS SOFTWARE, EVEN IF ADVISED OF THE POSSIBILITY OF SUCH DAMAGE.

■ Windows Notations

The names of operating systems (Japanese versions) used in this manual are as follows.

- Windows 7 is the abbreviation for Microsoft® Windows® 7 (Starter, Home Basic, Home Premium, Professional, Enterprise, Ultimate).

- Windows Vista is the abbreviation for Microsoft® Windows Vista® (Home Basic, Home Premium, Business, Enterprise, Ultimate).
- Windows XP is the abbreviation for Microsoft® Windows® XP Professional operating system and Microsoft® Windows® XP Home Edition operating system.

■ Gracenote® End User License Agreement

This application or device contains software from Gracenote, Inc. of Emeryville, California ("Gracenote"). The software from Gracenote (the "Gracenote Software") enables this application to perform disc and/or file identification and obtain music-related information, including name, artist, track, and title information ("Gracenote Data") from online servers or embedded databases (collectively, "Gracenote Servers") and to perform other functions. You may use Gracenote Data only by means of the intended End-User functions of this application or device.

You agree that you will use Gracenote Data, the Gracenote Software, and Gracenote Servers for your own personal non-commercial use only. You agree not to assign, copy, transfer or transmit the Gracenote Software or any Gracenote Data to any third party. **YOU AGREE NOT TO USE OR EXPLOIT GRACENOTE DATA, THE GRACENOTE SOFTWARE, OR GRACENOTE SERVERS, EXCEPT AS EXPRESSLY PERMITTED HEREIN.**

You agree that your non-exclusive license to use the Gracenote Data, the Gracenote Software, and Gracenote Servers will terminate if you violate these restrictions. If your license terminates, you agree to cease any and all use of the Gracenote Data, the Gracenote Software, and Gracenote Servers. Gracenote reserves all rights in Gracenote Data, the Gracenote Software, and the Gracenote Servers, including all ownership rights. Under no circumstances will Gracenote become liable for any payment to you for any information that you provide. You agree that Gracenote, Inc. may enforce its rights under this Agreement against you directly in its own name.

The Gracenote service uses a unique identifier to track queries for statistical purposes. The purpose of a randomly assigned numeric identifier is to allow the Gracenote service to count queries without knowing anything about who you are. For more information, see the web page for the Gracenote Privacy Policy for the Gracenote service.

The Gracenote Software and each item of Gracenote Data are licensed to you "AS IS." Gracenote makes no representations or warranties, express or implied, regarding the accuracy of any Gracenote Data from in the Gracenote Servers. Gracenote reserves the right to delete data from the Gracenote Servers or to change data categories for any cause that Gracenote deems sufficient. No warranty is made that the Gracenote Software or Gracenote Servers are error-free or that functioning of Gracenote Software or Gracenote Servers will be uninterrupted. Gracenote is not obligated to provide you with new enhanced or additional data types or categories that Gracenote may provide in the future and is free to discontinue its services at any time.

• GRACENOTE DISCLAIMS ALL WARRANTIES EXPRESS OR IMPLIED, INCLUDING, BUT NOT LIMITED TO, IMPLIED WARRANTIES OF MERCHANTABILITY, FITNESS FOR A PARTICULAR PURPOSE, TITLE, AND NON-INFRINGEMENT. GRACENOTE DOES NOT WARRANT THE RESULTS THAT WILL BE OBTAINED BY YOUR USE OF THE GRACENOTE SOFTWARE OR ANY GRACENOTE SERVER. IN NO CASE WILL GRACENOTE BE LIABLE FOR ANY CONSEQUENTIAL OR INCIDENTAL DAMAGES OR FOR ANY LOST PROFITS OR LOST REVENUES.

© Gracenote, Inc. 2000-present

More

The software installed on this product or part of it may not be altered, translated/adapted, reverse-engineered, decompiled or reverse-assembled and any such actions are prohibited.

Under the MPEG-4 Visual Patent Portfolio License, customers have licensed permission for the following use of this product to engage in non-profit personal use. Other uses are not permitted.

- Recording MPEG-4 Visual standard video (henceforth referred to as MPEG-4 Video)
- Playing back MPEG-4 Video that a customer engaged in personal and non-profit activities has recorded
- Playing back MPEG-4 Video obtained from a provider licensed by MPEG-LA

When using for promotion, in-house use, profit use, and other intended uses, contact MPEG LA, LLC.

- This product is licensed under the AVC patent portfolio license for the personal and noncommercial use of a consumer to (i) encode video in compliance with the AVC standard (henceforth referred to as AVC video) and/or (ii) decode AVC video that was encoded by a consumer engaged in a personal and noncommercial activity and/or was obtained from a video provider licensed to provide AVC video. No license is granted or shall be implied for any other use. Additional information may be obtained from MPEG LA, L.L.C.

See <http://www.mpegla.com>

- This product is licensed under the VC-1 Patent Portfolio License for the personal and noncommercial use of a consumer to (i) encode video in compliance with the VC-1 standard (henceforth referred to as VC-1 video) and/or (ii) decode VC-1 video that was encoded by a consumer engaged in a personal and noncommercial activity and/or was obtained from a video provider licensed to provide VC-1 video. No license is granted or shall be implied for any other use. Additional information may be obtained from MPEG LA, L.L.C.

See <http://www.mpegla.com>

This product is licensed under the MPEG-4 Visual Patent Portfolio License for the personal and non-commercial use of a consumer to (i) encode video in compliance with the MPEG-4 Video Standard ("MPEG-4 Video") and/or (ii) decode MPEG-4 Video that was encoded by a consumer engaged in a personal and non-commercial activity and/or was obtained from a licensed video provider. No license is granted or implied for any other use. Additional information may be obtained from MPEG LA. See <http://www.mpegla.com>.

This product is licensed under the MPEG-4 Systems Patent Portfolio License for encoding in compliance with the MPEG-4 Systems Standard, except that an additional license and payment of royalties are necessary for encoding in connection with (i) data stored or replicated in physical media which is paid for on a title by title basis and/or (ii) data which is paid for on a title by title basis and is transmitted to an end user for permanent storage and/or use. Such additional license may be obtained from MPEG LA, LLC. See <http://www.mpegla.com> for additional details.

Index

A

Absence Memo	59
Add Call	57
Add P	56
Add Prefix	57
Add shortcut	47
Add widget	46
Address Book	57
Answer	58
Answer Holding	58
au Disaster Countermeasure	2
au International Call Service	57
Auto Setup	65

B

Back to Welcome Sheet	47
Battery cover	32
Battery pack	32
Bluetooth OFF	57
Bluetooth ON	57

C

Change input mode	53
Charger terminal	30
Charging indicator	30
Check for updates	66
Confirm update	66
Create SMS	57

D

Delete	3
DIAL	57
Disaster Message Board	2
Disaster Voice Delivery Service	4
Display	30
Double tap	44

Drag	45
------	----

E

Early warning mail	3
Earphone	62
Earphone/Microphone	62
Earphone/Microphone jack	31
Earphone/Microphone with switch	62
Earpiece	30
Emoji	54
External connection jack	31
External connection jack cover	31

F

Facemark	54
FCC Notice	74
FeliCa mark	32
Flick	45
Forwarding	59

H

Home settings	46
---------------	----

I

Icons	48
In camera	30
Incoming indicator	30
Infrared port	31
Internal antennas area	31

L

Lens	30
In camera	30

Out camera	31
Light sensor	30
Long touch	44

M

Major Update	66
micro au IC-Card	34
Microphone	31
microSD memory card	36
microSD memory card slot	32
Mobile light	32
Mouthpiece	31
Mute	57
Mute OFF	57

O

Out camera	31
------------	----

P

Phone	55
PIN code	21
Pinch	45
Power key	30
Power off	42
Profile	59
Proximity sensor	30

Q

Quick reply	58
Quote from profile	57
Quote to Call log	57

R

Reboot	42
Receiver	30
Reject	59
Reminder	65
Reserve Time	65
Restrict Calls Setting	57

S

Search App.(Google Play)	46
Security codes	21
Set 12 keyboard	51
Set QWERTY keyboard	51
Settings	
Display setting menu	60
Early Warning Mail	3
Menu on the home screen	46
Menu on the phone number entry screen	57
Silent	59
Slide	44
Software update	64
Speaker	
Names and functions of parts	32
Operations on the call screen	57
Speaker OFF	57
Start update	66
Strap eyelet	30
Strap hook	32
Symbol	54

T

Tap	44
Touch panel	30
Tray	32
TV antenna	31

U

Update	65
--------	----

V

Voice Memo	57
Volume	57
Volume up/down key	30

For inquiries, call:

Customer Service Center

For general information and charges (toll free)

From fixed-line phones: | From au cell phones:

 0077-7-111 | 157 area code not required

TAPPING "DIAL" AND ZERO WILL CONNECT YOU TO AN OPERATOR
AFTER CALLING 157 ON YOUR au CELLPHONE.

For service canceling procedure or operation
in case of loss or theft (toll free)

From fixed-line phones: | From au cell phones:

 0077-7-113 | 113 area code not required

In case above numbers are not available,

 0120-977-033 (except Okinawa)

 0120-977-699 (Okinawa)

Secure cell phone support center

For loss, theft or damage (toll free)

From fixed-line phones/au cell phones:

 0120-925-919

Business hours: 9:00 to 21:00 (7 days a week)



Cell phone and PHS operators collect and recycle unused
telephones, batteries and battery chargers at stores
bearing the  logo regardless of brand and manufacturer
to protect the environment and reuse valuable resources.

June 2012 Edition

Sales: KDDI CORPORATION •
OKINAWA CELLULAR TELEPHONE COMPANY
Manufactured by: SHARP CORPORATION