

General Inquiries <docomo Information Center>

(Business hours: 9:00 a.m. to 8:00 p.m.)

 **0120-005-250** (toll free)

※ Service available in: English, Portuguese, Chinese, Spanish, Korean.
※ Unavailable from part of IP phones.

(Business hours: 9:00 a.m. to 8:00 p.m. (open all year round))

■ From DOCOMO mobile phones ■ From land-line phones
(In Japanese only) (In Japanese only)

 (No prefix) **151** (toll free)  **0120-800-000** (toll free)

※ Unavailable from land-line phones, etc. ※ Unavailable from part of IP phones.

● Please confirm the phone number before you dial.

● For Applications or Repairs and After-Sales Service, please contact the above-mentioned information center or the docomo Shop etc. near you on the NTT DOCOMO website.

NTT DOCOMO website <http://www.nttdocomo.co.jp/english/>

Loss or theft of handset or payment of cumulative cost overseas <docomo Information Center>

(available 24 hours a day)

From DOCOMO mobile phones

International call access code
for the country you stay **-81-3-6832-6600*** (toll free)

* You are charged a call fee to Japan when calling from a land-line phone, etc.
※ If you use SH-04E, you should dial the number +81-3-6832-6600
(to enter "+", touch "0" for a while).

From land-line phones

<Universal number>

Universal number
international prefix **-8000120-0151***

* You might be charged a domestic call fee according to the call rate for the country you stay.
※ For international call access codes for major countries and universal number international prefix, refer to DOCOMO International Services website.

- If you lose your handset or have it stolen, immediately take the steps necessary for suspending the use of the handset.
- If the handset you purchased is damaged, bring your handset to a repair counter specified by DOCOMO after returning to Japan.

Don't forget your mobile phone... or your manners!

When using your mobile phone in a public place, don't forget to show common courtesy and consideration for others around you.



Li-ion00

Repairs

(Business hours: 24 hours (open all year round))

■ From DOCOMO mobile phones ■ From land-line phones
(In Japanese only) (In Japanese only)

 (No prefix) **113** (toll free)  **0120-800-000** (toll free)

※ Unavailable from land-line phones, etc. ※ Unavailable from part of IP phones.

Failures encountered overseas <Network Support and Operation Center>

(available 24 hours a day)

From DOCOMO mobile phones

International call access code
for the country you stay **-81-3-6718-1414*** (toll free)

* You are charged a call fee to Japan when calling from a land-line phone, etc.
※ If you use SH-04E, you should dial the number +81-3-6718-1414
(to enter "+", touch "0" for a while).

From land-line phones

<Universal number>

Universal number
international prefix **-8005931-8600***

* You might be charged a domestic call fee according to the call rate for the country you stay.
※ For international call access codes for major countries and universal number international prefix, refer to DOCOMO International Services website.

NTT
docomo

AQUOS PHONE
SH-04E

INSTRUCTION MANUAL



docomo with series

Sales: NTT DOCOMO, INC.
Manufacturer: SHARP Corporation







Precautions (ALWAYS FOLLOW THESE DIRECTIONS)

- Before use, read these “Precautions” carefully and use your handset properly. Keep this manual in a safe place for future reference.
- These precautions contain information intended to prevent bodily injury to the user and to surrounding people, as well as damage to property, and must be observed at all times.

The following symbols indicate the different degrees of injury or damage that may occur if information provided is not observed and the handset is used improperly.

 Danger	This symbol indicates that “death or serious bodily injury may directly and immediately result from improper use”.
 Warning	This symbol indicates that “death or serious bodily injury may result from improper use”.
 Caution	This symbol indicates that “minor injury and/or property damage may result from improper use”.

The following symbols indicate specific directions.

 Don't	Indicates a prohibited action.
 No disassembly	Indicates not to disassemble the device.
 No liquids	Indicates not to use the device near water or get it wet.
 No wet hands	Indicates not to handle the device with wet hands.
 Instruction	Indicates that instructions specified are compulsory (must be followed).
 Unplug	Indicates that the power cord must be unplugged from the outlet.

Handling the handset, battery pack, adapters, docomo mini UIM card and 1Seg antenna cable (general)

Danger



Don't

Do not use, store or leave the equipment in locations subject to high temperatures (near a fire or heating unit, in a kotatsu, under direct sunlight, inside a vehicle on a hot day, etc.).

May cause fires, burns or bodily injury.



Don't

Do not place the equipment inside cooking appliances such as microwave ovens or pressure cookers.

May cause fires, burns, bodily injury or electric shock.



No disassembly

Do not attempt to disassemble or modify the equipment.

May cause fires, burns, bodily injury or electric shock.



No liquids

Do not get the equipment wet with water, drinking water, pet urine, etc.

May cause fires, burns, bodily injury or electric shock.

Refer to the following for details on waterproofness.

Warning



Don't

Do not subject the equipment to strong force or impacts or throw it.

May cause fires, burns, bodily injury or electric shock.



Don't

Do not allow conductive materials (such as metal objects and pencil lead) to come into contact with the charger terminal, external connector terminal or earphone/microphone terminal. In addition, do not insert such objects.

May cause fires, burns, bodily injury or electric shock.



Don't

Do not cover or wrap the equipment with bedding etc. when using or charging.

May cause fires or burns.



Instruction

Be sure to turn off the handset and not to charge the battery in locations such as gas stations where flammable gas is generated.

May cause a gas explosion or fire.
To use Osaifu-Keitai in locations such as gas stations, be sure to turn off the power in advance (If the Osaifu-Keitai lock setting is activated, disable the lock before turning off the power).



Instruction

If you notice anything unusual, such as an unusual odor, overheating, discoloration or deformation during use, charging or storage, immediately follow the instructions below.

- **Unplug the power cord from the outlet or cigarette lighter socket.**
- **Turn off the handset.**

May cause fires, burns, bodily injury or electric shock.

Caution



Don't

Do not leave the equipment on unstable surfaces, such as on a wobbly table or sloped surface.

May fall and cause injury.



Don't

Do not store the equipment in locations that are subject to humidity, dust or high temperatures.

May cause fires, burns or electric shock.



Instruction

If being used by a child, have a guardian teach him/her the proper handling procedures. In addition, check that the child is using the equipment as directed.

May result in bodily injury.



Instruction

Keep the equipment out of the reach of young children.

A young child may swallow the equipment or suffer other bodily injury.



Instruction

Be very careful when using the handset connected to adapters repeatedly or for long periods of time.

The handset, battery pack or adapters may become warm if 1Seg etc. is used for a long time while charging.

Touching high temperature areas for a prolonged period of time may cause skin irritations, itchiness or low-temperature burns in some people.

Handling the handset

Warning



Don't

Do not aim the infrared port towards the eyes.

May cause eye injury.



Don't

Do not aim the infrared port towards home electric appliances with an infrared device during infrared communication.

May interfere with the operation of infrared devices and cause an accident.



Don't

Do not point the illuminated light directly at someone's eyes. Especially when you shoot still pictures or moving pictures of young children, keep 1 m or more distance from them.

Do not use Mobile light near people's faces. Eyesight may be temporarily affected leading to accidents.



Don't

Do not allow water or other liquids, metal, flammable material or other foreign objects to enter the docomo mini UIM card or microSD Card slot on the handset.

May cause fires, burns, bodily injury or electric shock.



Don't

Do not shine the light at anyone driving a car or other vehicles.

May prevent a driver from driving safely and cause a traffic accident.



Instruction

Turn off the handset in areas where the use of mobile phones is prohibited, such as in aircraft or hospitals.

May interfere with the operation of electronic devices and electronic medical equipment.

Follow the instructions given by the respective medical facilities regarding the use of mobile phones on their premises. Actions such as using a mobile phone aboard aircraft are prohibited and punishable by law.

However, follow the instructions on use of the handset given by the airline if the handset can be used aboard aircraft by setting the handset such as setting it not to emit radio wave.



Instruction

Keep the handset away from the ears during a call in which hands-free is set or while the ring tone is ringing.

When you attach the earphone/ microphone, etc. to the handset to play games, music, etc., do not make the volume too loud.

Excessive high volume may damage your hearing.

Also, it may prevent you from hearing ambient sounds and cause an accident.

Earphone Signal Level

The maximum output voltage for the music player function, measured in accordance with EN 50332-2, is 14mV.



Instruction

If you have a weak heart, take extra precautions when setting functions such as the vibrator and ring tone volume for incoming calls.

May have harmful effects on your heart.



Instruction

If you are using electronic medical equipment, contact the respective manufacturer or dealer to check whether the operation of the equipment is affected by signals.

May interfere with the operation of electronic medical equipment etc.



Instruction

Turn off the handset near high-precision electronic devices or devices that use weak electronic signals.

May interfere with the operation of electronic devices.

Take particular care with the following devices

Hearing aids, implanted cardiac pacemakers, implanted cardioverter-defibrillators or other electronic medical equipment. Fire alarms, automatic doors, and other equipment controlled by electronic signals. If you use an implanted cardiac pacemaker, implanted cardioverter-defibrillator or other electronic medical equipment, contact the respective manufacturer or dealer to check whether the operation of the equipment is affected by signals.



Instruction

If the display part or camera lens is damaged, be careful of broken glass and the exposed inside of the handset.

The surface of the display is covered by a protective film while the surface of the camera lens is covered by a plastic panel so as to minimize the possibility of glass scattering. However, touching the broken or exposed parts may cause injury.



Caution



Don't

Do not swing the handset by its strap etc.

May hit you or others around you, resulting in bodily injury.



Don't

Do not use a damaged handset.

May cause fires, burns, bodily injury or electric shock.



Don't

For using a motion sensor and geomagnetic sensor, check the safety around, hold the handset and do not swing them more than necessary.

May cause injury etc.



Don't

If the display is broken and the liquid crystal then leaks, do not get the liquid on your skin (face, hands, etc.).

May result in loss of eyesight and harm to your skin.

If the liquid comes into contact with your eyes or mouth, immediately rinse your eyes or mouth with clean water and see a doctor.

If the liquid comes into contact with your skin or clothes, immediately wipe it off with alcohol, and wash with water and soap.



Don't

The surface of the display is covered with a protective film for ensuring the security against any damages caused by the handset being dropped or receiving a strong impact etc. Do not remove the film forcibly or damage it.

Using the equipment with the film removed may damage the display and cause bodily injury.



Instruction

If you use the handset in a vehicle, contact the vehicle manufacturer or dealer to check whether the operation of the vehicle is affected by signals.

May interfere with the operation of electronic equipment in some vehicle models. In such cases, stop using the handset.



Instruction

Use of the handset may cause skin irritations such as itchiness, rashes or eczema in some people. If this occurs, immediately stop using the handset and seek medical treatment.



Instruction

Look at the display in a well-lit place, keeping a certain distance from the screen.

Otherwise, eyesight may be weakened.



Instruction

If the battery fluid etc. leaks, do not get the liquid on your skin (face, hands, etc.).

May result in loss of eyesight and harm to your skin.

If the liquid comes into contact with your eyes, mouth, skin or clothes, immediately rinse them with clean water.

If the liquid etc. comes into contact with your eyes or mouth, see a doctor immediately after rinsing your eyes or mouth.

Handling adapters and desktop holder

Warning



Don't

Do not use if the cord of the adapter is damaged.

May cause fires, burns or electric shock.



Don't

Never use the AC adapter or the desktop holder in humid locations such as a bathroom.

May cause fires, burns or electric shock.



Don't

The DC adapter should only be used in negative grounded vehicles. Never use it in positive grounded vehicles.

May cause fires, burns or electric shock.



Don't

Do not touch adapters if you hear thunder.

May cause electric shock.



Don't

Take care not to short-circuit the charger terminal when connected to an outlet or cigarette lighter socket. Also, take care not to allow any part of your body (hands, fingers, etc.) to come into contact with the charger terminal.

May cause fires, burns or electric shock.



Don't

Do not place heavy objects on the cord of the adapter.

May cause fires, burns or electric shock.



Don't

When plugging/unplugging the AC adapter into/from the outlet, do not allow metallic straps or other metallic objects to come into contact with the prongs of the plug.

May cause fires, burns or electric shock.



No wet hands

Do not handle the cord of the adapters, the desktop holder or the outlet with wet hands.

May cause fires, burns or electric shock.



Instruction

Always use the specified power supply and voltage. When using overseas, use the AC adapter that is available overseas.

Using the incorrect voltage may cause fires, burns or electric shock.

AC adapter: 100V AC

DC adapter: 12/24V DC (for negative grounded vehicles only)

AC adapter available overseas: 100 to 240V AC (Connect only with a household AC outlet)



Instruction

If the fuse in the DC adapter blows, always replace it with a fuse of the specified type.

May cause fires, burns or electric shock.

Refer to the respective manuals for information on the correct fuse specifications.



Instruction

Wipe off any dust on the power plug.

May cause fires, burns or electric shock.



Instruction

Fully plug the AC adapter into the outlet.

May cause fires, burns or electric shock.



Instruction

Always grasp the adapters when unplugging the power plug from the outlet or cigarette lighter socket. Do not forcibly pull by the cord of the adapter.

May cause fires, burns or electric shock.



Unplug

Unplug the power plug from the outlet or cigarette lighter socket when not using for a long time.

May cause fires, burns or electric shock.



Unplug

Should water or other liquids enter the equipment, remove the power plug from the outlet or cigarette lighter socket immediately.

May cause fires, burns or electric shock.



Unplug

Always unplug the power plug from the outlet or cigarette lighter socket before cleaning the equipment.

May cause fires, burns or electric shock.

Handling docomo mini UIM card



Caution



Instruction

Be careful with the cutting surface when removing the docomo mini UIM card.

May cause bodily injury.

FeliCa reader/writer

- **The FeliCa reader/writer function in the handset uses weak radio waves in the handling of which does not require a license of radio station.**
- **The frequency in use is the 13.56 MHz band. When another reader/writer is being used nearby, keep enough distance from it. Make sure that there is no radio station using the same frequency band in the nearby area.**

Caution

- **Never use the handset that is modified. Using a modified device violates the Radio Law.**

The handset has acquired the certification of conformity with technical regulations for the specified radio station based on the Radio Law, and the “Technical Conformity Mark ” is printed on the model nameplate of the handset as a proof. If the screws of handset are removed and a modification is given to the inside, the certification of conformity with technical regulations will become invalid. Never use the handset without the valid certification. Doing so violates the Radio Law.
- **Be careful when using the handset while driving a motor vehicle.**

Using a mobile phone in hand while driving is regarded as a punishable act. However, the punishment has no application in some cases such as when rescuing sick and injured people or maintaining public safety.
- **Use the FeliCa reader/writer function only in Japan.**

The FeliCa reader/writer function in the handset conforms to the domestic radio wave standards. Using the function overseas may result in punishment.

- **Never change the basic software improperly.**

This may be regarded as a conversion of software and repairs may be refused.
- **Be careful not to connect the handset to a PC using Micro USB Cable 01 (sold separately) in areas where the use of mobile phones is prohibited.**

Power may turn on automatically.

■ AC adapter and DC adapter

- Refer to user's guide of AC Adapter 03 (sold separately) or DC Adapter 03 (sold separately).

- AC Adapter 03 covers from 100 to 240V AC.

- The shape of the plug for the AC adapter is for 100V AC (for domestic use). To use the AC adapter of 100 to 240V AC overseas, a conversion plug adapter that is compatible with the voltage of your country of stay is required. Do not use a voltage converter for overseas travel to charge the battery.

Charging with AC adapter/DC adapter

[Read the user's guides of AC Adapter 03 (sold separately), DC Adapter 03 (sold separately)]

- Following operations describe how to charge with AC Adapter 03 or DC Adapter 03.

1 Open the external connector terminal cover of the handset and insert the microUSB plug of a microUSB cable/DC adapter horizontally into the external connector terminal with the USB mark side turned up

- Check the direction (front or rear) of the microUSB plug and insert it horizontally.

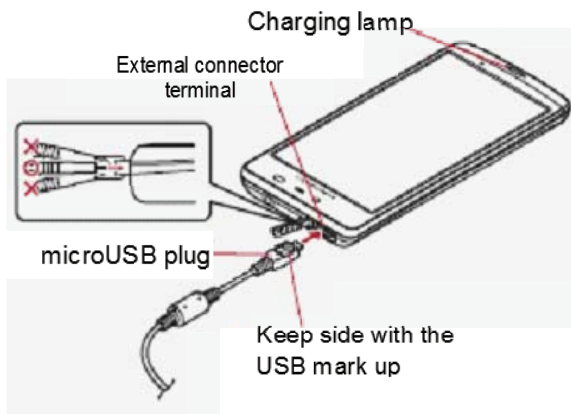

2 Insert the **USB plug** of the **microUSB cable** horizontally into the **USB connector** of an **AC adapter** with the **USB mark** side facing you **(1)**

- Check the direction (front or rear) of the USB plug of the microUSB cable and insert it horizontally into the AC adapter.

3 When inserting the **AC adapter power plug** into an outlet **(2)** or inserting the **DC adapter power plug** into a car cigarette lighter socket, the **charging lamp** illuminates and charging starts

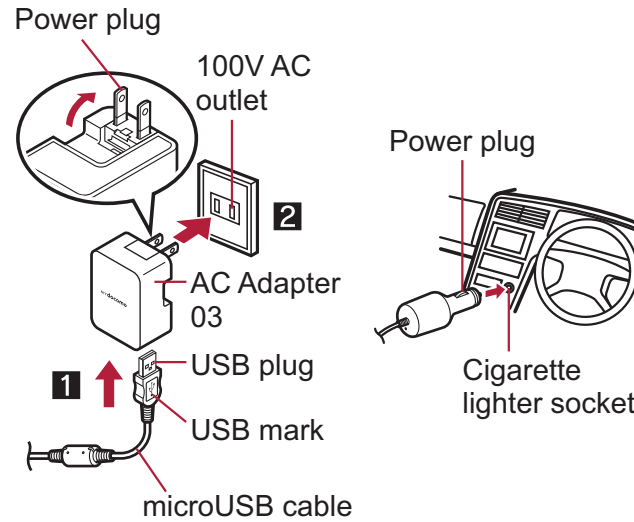

For AC adapter

For DC adapter

4 When charging is complete, the **charging lamp** turns off

- When charging is complete, remove the microUSB plug horizontally from the external connector terminal.

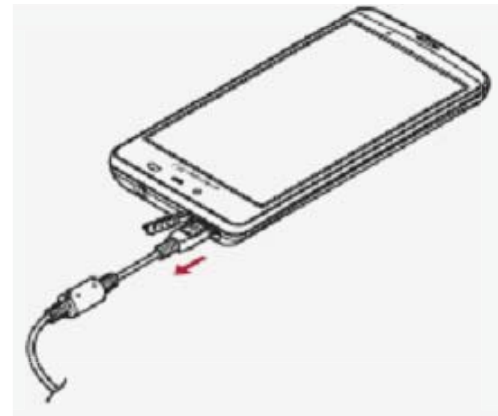

- Do not forcibly insert or remove. May cause damage to the external connector terminal, the microUSB plug and the USB plug.
- Pull the adapter out of the outlet or cigarette lighter socket if it will not be used for a long time.
- Do not forcibly pull the external connector terminal cover. May damage the cover.
- Do not place objects near the handset when charging. May damage the handset.

When using a DC adapter

- The DC adapter should only be used in negative grounded vehicles (12 and 24V DC).
- Do not use with the car engine shut off. May drain the car battery.
- The DC adapter fuse is a consumable product. For replacement, purchase a new fuse at a local vehicle supply shop.
- Refer to the user's guide of DC Adapter 03 for details.

Charging with Micro USB Cable 01

When the handset is turned on, you can charge the handset by connecting the handset to a PC with Micro USB Cable 01 (sold separately).

- Install the USB driver to the PC in advance. If the USB driver has not been installed on the PC, you cannot charge the battery by connecting the handset to the PC via Fast transfer mode.
 - For details on installing USB driver, refer to "Manual for USB Driver Installation" in PDF format in the following site.
<http://k-tai.sharp.co.jp/support/d/sh-04e/> (in Japanese only)

Turning power ON/OFF

Turning power ON

1 (for at least 2 seconds)

- When you turn the power on for the first time, the initial setting screen is displayed. Each setting item can also be set from menus
- If the initial setting screen for docomo service is displayed, operate by following the instructions on the screen.

Turning power OFF

1 (for at least 1 second) ▶ [Power off] ▶ [OK]

■ Sleep mode

The screen is off and the sleep mode is activated when  is pressed or the handset is not in use for a set length of time.

Press  in the sleep mode to deactivate the sleep mode.





■ Touch panel lock

When the power is turned on or the sleep mode is deactivated, the touch panel is locked.

Touch  to unlock.



Operations in touch panel unlock screen

- To set/disable the manner mode:  (for at least 1 second)
- To turn on the mobile light:  (for at least 1 second)
 - Press any of the keys or touch  to turn it off.
- To activate the camera: [

- The mobile light will automatically turn off approximately 30 seconds after it turns on.
- The status panel is displayed when Screen lock is set to [Slide or Touch].

Basic operation

Operation of touch panel

You can operate by touching the touch panel (display) directly with your finger.

- Operations differ depending on the function and screen in use.

Cautions when using the touch panel

- The touch panel is designed to be lightly touched with your finger. Do not forcefully press with your finger or press with a pointed object (fingernail, ballpoint pen, pin, etc.).
- In the following cases, the touch panel may not work even if you touch it. May cause a malfunction.
 - Operation with a gloved finger
 - Operation with a fingernail
 - Operation with foreign objects placed on the operation pad
 - Operation on the touch panel on which a protective sheet or a sticker is put
 - Operation while the touch panel is wet
 - Operation with fingers wet with sweat or water
- Operations may be interrupted if you touch other than a confirmation screen or the status bar while the confirmation screen etc. is displayed.

■ Touch

Touch a key or an item displayed on the screen to select or set it.

- 1 Put your finger on the touch panel and put it off

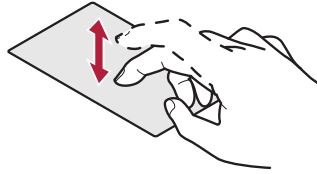

■ Flick

Flick your finger to the left/right in the home screen etc. to switch pages.

- 1 Move your finger like sweeping the touch panel

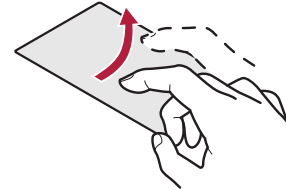

■ Touch for a while

When you touch the screen for a while, a menu may appear depending on the function and screen in use.

- 1 Keep your finger on the touch panel

■ Slide/Drag

Slide your finger up/down while a menu is displayed etc. to scroll the screen or slide (drag) an icon, widget, etc. to move it to the desired position while keeping touching it.

In addition, when you touch a menu or item by mistake, slide your finger away from the menu or item to cancel the selection.

- 1 Keep your finger on the touch panel and slide it

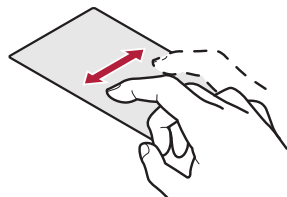

■ Pinch out/Pinch in

Pinch out/Pinch in while displaying an image etc. to zoom in/out.

- 1 Put two fingers on the touch panel and slide them with putting a distance between two fingers apart (pinch out)/closer (pinch in)

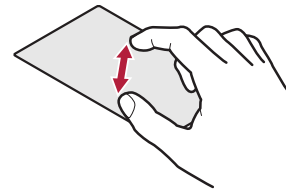

Notes on using Bluetooth function

- The handset supports the security function that meets the Bluetooth specification for security during communication using Bluetooth functions. However, the security may not be sufficient depending on the configuration. Take care of the security while making communication using Bluetooth function.
- Even if any leak of data or information occurs while making communication using Bluetooth function, DOCOMO shall not be liable for any loss of content.
- The handset can use headset, hands-free, audio, keyboard, object push, serial port and phone book access. Also, audio/video remote-control may be available depending on the audio (only with compatible Bluetooth devices).
- Radio frequencies
The radio frequencies the Bluetooth function of the handset uses are as follows.

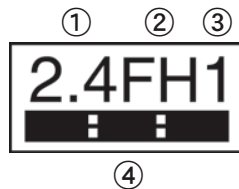

- ① 2.4: This radio equipment uses the 2.4 GHz band.
- ② FH: The modulation system is the FH-SS system.
- ③ 1: The estimated coverage distance is 10 m or less.

All radio frequencies between 2400 MHz and 2483.5 MHz are used and the frequencies for mobile object identifiers shall not be avoided.

- **Cautions on using Bluetooth devices**
Bluetooth operates at radio frequencies assigned to the in-house radio stations for a mobile object identifier that have to be licensed and is used in production lines of a factory, specific unlicensed low power radio stations, and amateur radio stations (hereafter, referred to “another radio station”) in addition to industrial, scientific, medical devices or home electric appliances such as microwave ovens.
 1. Before using the handset, make sure that “another radio station” is not operating nearby.
 2. If radio interference between the handset and “another radio station” occurs, avoid interference by moving immediately to another place or “turning off the power”.
 3. Contact the number listed in “General Inquiries” on the back of this manual for further details.

Notes about wireless LAN (WLAN)

- Wireless LAN (WLAN) uses radio waves to communicate information. Therefore, it has an advantage of freely connecting to the LAN within the service area. On the other hand, if security setting is not set, it is possible for a malicious third party to intercept the communication contents or hack. It is recommended to set security setting at your own risk and judgement.

Do not use wireless LAN near magnetic devices such as electric appliances or AV/OA devices or in radio waves.

- Magnetism or radio waves may increase noises or disable communications (especially when using a microwave oven).
- When used near TV, radio, etc., reception interference may occur or channels on the TV screen may be disturbed.
- If there are multiple wireless LAN access points nearby and the same channel is used, search may not work correctly.

● **Radio frequencies**

The radio frequencies the WLAN-installed devices use are indicated on the battery storage section of the main body of the handset. The following are the descriptions:

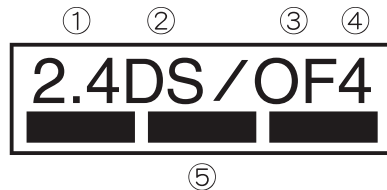

- ① 2.4: This radio equipment uses the 2400 MHz band.
- ② DS: The modulation system is the DS-SS system.
- ③ OF: The modulation system is the OFDM system.
- ④ 4: The estimated coverage distance is 40 m or less.
- ⑤ [blacked out] [blacked out] [blacked out]: All radio frequencies between 2400 MHz and 2483.5 MHz are used and the frequencies for mobile object identifiers shall not be avoided.

Available channels for the handset's wireless LAN are between 1 to 13. Note that other channel access points cannot be connected.

Available channels vary depending on the country. For use in an aircraft, contact the airline beforehand.

There are restrictions on the use of wireless LAN in some countries or regions such as France. If you intend to use wireless LAN overseas, check the local laws and regulations beforehand.

- **Cautions on using 2.4 GHz devices**
- WLAN-installed devices operate at radio frequencies assigned to the in-house radio stations for a mobile object identifier (radio stations requiring a license) used in production lines of a factory, specific unlicensed low power radio stations (radio stations requiring no license), and amateur radio stations (radio stations requiring a license) in addition to industrial, scientific, medical devices or home electric appliances such as microwave ovens.**
1. Before using this device, make sure that the in-house radio stations for a mobile object identifier, specific unlicensed low power radio stations and amateur radio stations are not operating nearby.
 2. If the device causes harmful radio interference to the in-house radio stations for a mobile object identifier, immediately change the radio frequency or stop use, and contact the number listed in "General Inquiries" on the back of this manual for crosstalk avoidance, etc. (e.g. partition setup).
 3. If the device causes radio interference to specific unlicensed low power radio stations for a mobile object identifier or amateur radio stations, contact the number listed in "General Inquiries" on the back of this manual for further details.

Call

Making a call

1 In the home screen, [] ▶
[Phone] ▶ [Dial]

2 Enter a phone number

- Always enter the city code, even when it is a local number.
- You can set to notify/not to notify the other party of your phone number for each call by adding “186”/“184” to the head of the phone number.

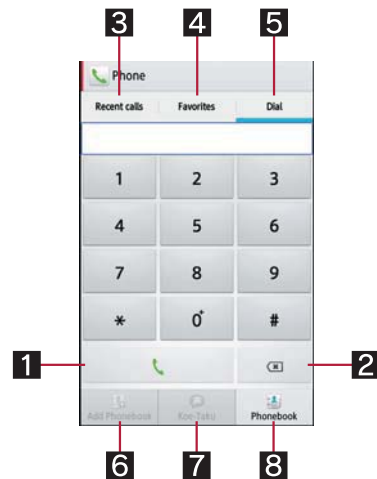

1 Call

- Make a call. Also, if there is an outgoing call history, touch to enter the latest outgoing call history when the phone number has not been entered.

2 Delete

- Delete an entered number.

3 Outgoing/Incoming call history

4 Favorites

- Display the contacts set to [Favorites] by groups.

5 Dial

- Display the dial screen.

6 Add to phonebook

7 Koe-no-Takuhaibin

- For details of Koe-no-Takuhaibin, refer to the DOCOMO website.

8 Phonebook

- Display the phonebook.

3 []

4 [End] to end the call

Entering touch-tone signals

1 In the home screen, [] ▶
[Phone] ▶ [Dial]

2 Enter a phone number ▶ [] ▶ [Add wait]

3 Enter a number to send ▶ []

4 [Yes] during the call

Emergency call

Emergency calls	Phone number
Police	110
Fire and ambulance	119
Marine emergency	118

- The handset supports “Location notification of emergency call”.

When dialing an emergency number such as 110, 119, and 118, the information of your location (location information) is automatically notified to the agency that received the emergency call (e.g. the police station). Depending on your location and the reception status of the signal, the agency that received the emergency call may not be able to confirm the exact location.

If you are not sending your caller ID by calling with “184” added or other means, your location information and phone number are not notified. However, if the agency that received the emergency call considers your location information and phone number necessary for important purposes, such as life saving, the agency can retrieve them regardless of your settings.

In addition, the area/timing to introduce “Location notification of emergency call” depends on the state of preparation in each agency that receives emergency calls.

- In Japan, you cannot make a call to the emergency number (110, 119 or 118) when a docomo mini UIM card is not inserted, from the PIN code entry screen, while the PIN code is locked or from the PUK (PIN Unlock Key) entry screen.
- When calling 110, 119, and 118 from your handset, the police or fire stations may return your call for verification purposes. State that you are calling from a mobile phone, and give your phone number and exact present location. Remain stationary to ensure that the call is not disconnected while you are on the line, and keep the handset turned on to receive calls for approximately 10 minutes afterwards.
- Depending on the region, calls to the police or fire station of the local area may not be made.

International call (WORLD CALL)

WORLD CALL is an international calling service available from DOCOMO handset in Japan.

WORLD CALL is registered when FOMA services are registered (excluding users who did not apply for WORLD CALL).

- You can call to approximately 240 countries and regions worldwide. Calling to a land-line phone and mobile phone overseas is available.
- For information on available countries and network operators, refer to “Mobile Phone User’s Guide [International Services]” or the DOCOMO International Services website.
- Commission and monthly usage fees are free.
- Contact “General Inquiries” on the back of this manual for details on WORLD CALL.
- To make an international call through a company other than DOCOMO, contact the respective companies for instructions.
- The caller ID may not be notified or displayed correctly depending on overseas network operators. In this case, making a call with incoming call history is not available.

[Calling Method]

- When calling to a land-line phone: 010 ▶ country code ▶ area code (city code) ▶ the other party’s phone number ▶ [📞]
- When calling to a mobile phone: 010 ▶ country code ▶ the other party’s phone number ▶ [📞]
- For the other parties’ phone numbers and area codes (city codes) that begin with “0”, omit the first “0” when entering (except some countries or regions such as Italy).
- Alternatively, enter “009130-010” as usual or “+” instead of “010”.

Receiving a call

1 When a call is received, the ring tone sounds and the incoming lamp flashes

- If you press  during an incoming call, you can stop the ring tone, vibrator or flash of the incoming lamp.



2 Receive the call

- Operate after touching [Activate].

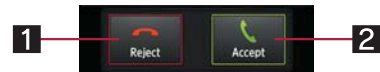

1 Reject

- You can reject the incoming call.

2 Accept

- You can receive the call.

3 [End] to end the call

Quick responses

1 When a call is received, the ring tone sounds and the incoming lamp flashes

2 [Quick responses]

3 Select a response

Placing a call on hold

1 When a call is received, the ring tone sounds and the incoming lamp flashes

2 [On hold]

Answering by answering memo

1 When a call is received, the ring tone sounds and the incoming lamp flashes

2 [Absence Memo]

Playing an answering memo

1 In the home screen, [Settings] [Call]

2 [Call/Ans Memo] [Answering Memo List] select an answering memo

Infrared communication

Using infrared communication

Use infrared communication to send and receive data to and from other handsets which also support infrared communication.

- Send and receive phonebooks, sp-mode mails, profiles, business cards, memos, schedules, bookmarks, ToruCa, data shot by camera, data in Gallery, data recorded with the voice recorder, etc.
- The handset infrared communication function complies with IrMC™ 1.1 standard. However, depending on the data, some data may not be sent or received even when the other party's handset complies with IrMC™ 1.1 standard.
- Infrared communication is not available in Airplane mode.
- To enter docomo application password or passcode and to enter authentication code are required for sending and receiving all data items. The authentication code is a password exclusive to infrared communication. Before starting data communication, the sender and receiver must enter the same user-specified four-digit code.

When using infrared communication

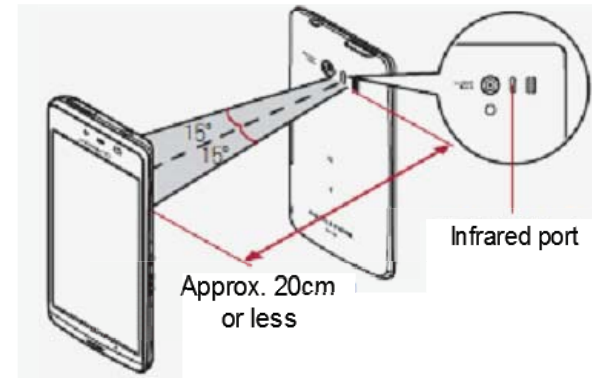

- Face the infrared ports of the receiver's and sender's handsets with each other and set the distance between them to approximately 20 cm or less as shown.
- While doing infrared communication, keep the infrared ports facing each other and do not move them.
- Infrared communication may not function properly in areas of direct sunlight, directly under fluorescent lights or near other equipment using infrared signals.
- If either of the infrared ports is dirty, infrared communication will become difficult. Take care not to scratch the ports, and wipe off any dirt with a soft cloth.

Sending and receiving by infrared

- When sending data, you can also operate from each function (menu).

1 In the home screen, [☰] ▶ [Send/receive by infrared]

2 Select an item

- **Single:** Receive single data.
- **Multiple:** Receive all data.
- **Single:** Select data and send.
- **Multiple:** Send all data by selecting an application.
- Perform the operation for receiving and sending at the same time.
- After the operation for receiving, the handset waits to receive data. Infrared communication automatically begins when data is sent from sender's handset within approximately 30 seconds.

- Note that if you select [Delete all before registration] when receiving all data, all data registered to the target function are deleted.
- Receiving all data is not available depending on the data type.
- When available space in the save destination becomes insufficient, the data being received to that point are saved and receiving ends.

iC communication

Using iC communication

You can send and receive data with other handsets equipped with iC communication function.

- Make initial setting of Osaifu-Keitai in advance
- In the following cases, you cannot perform iC communication.
 - During Airplane mode
 - During Osaifu-Keitai lock
- In the following cases, data may not be sent by iC communication.
 - During a call
 - During charging
 - During earphone/microphone connection
 - During USB connection
- sp-mode mails, business cards, memos, schedules and ToruCa cannot be sent by iC communication. For details on other data that can be sent and received, refer to "Infrared communication"

When using iC communication

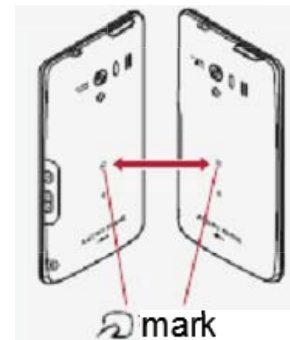

- Use while placing the mark of receiver's handset on that of sender's handset as shown.



- Do not move the handset until sending and receiving of data is completed.
- There may be some cases in which data are poorly sent and received or the screen is off by positioning the handset near depending on the other party's handset. In that case, put a distance between the  marks apart/closer or move them up/down or to the left/right.

Sending and receiving by iC

To enter authentication code is required for sending and receiving all data items. The authentication code is a password exclusive to iC communication. Before starting data communication, the sender and receiver must enter the same user-specified four-digit code. In addition, to enter passcode may be required for sending all data items.

Sending data

Example: Still picture

- 1** In the home screen, [] ▶
[Contents Manager]
- 2** Touch a still picture for a while ▶
[Share] ▶ [Send by IC]
- 3** [Ok]
- 4** Place the  mark on that of the other party's handset

Receiving data

- 1** Place the  mark on that of the other party's handset
- 2** [Accept]
- 3** Drag the status bar down ▶ select received data

Bluetooth function

You can connect the handset to Bluetooth devices wirelessly.

- Wireless communications with all the Bluetooth devices are not completely guaranteed.

Supported version and supported profiles

Supported version

Bluetooth Specification Ver.4.0+EDR^{*1}

Supported profiles^{*2} (Supported services)

HSP: Headset Profile^{*3}

HFP: Hands Free Profile^{*4}

A2DP: Advanced Audio Distribution Profile^{*5}

AVRCP: Audio/Video Remote Control Profile^{*5}

HID: Human Interface Device Profile^{*6}

DUN: Dial-up Networking Profile^{*7}

OPP: Object Push Profile^{*8}

SPP: Serial Port Profile^{*9}

PBAP: Phone Book Access Profile^{*10}

PAN: Personal Area Networking Profile^{*11}

HDP: Health Device Profile^{*12}

- *1 The handset and all Bluetooth function-installed devices have ensured that they conform to the Bluetooth specification according to the rules that the Bluetooth SIG defines, and are all authenticated. However, operating methods might differ or data might not be exchanged even when they are connected wirelessly, depending on the features or specifications of connected devices.
 - *2 Standardizes the communication procedures of Bluetooth device per feature of a device.
 - *3 Connect a commercially available Bluetooth compatible headset to the handset to talk wirelessly.
 - *4 Connect a commercially available Bluetooth compatible hands-free device such as a car navigation system to the handset to talk during hands-free operation using the car navigation system etc.
 - *5 Connect a commercially available Bluetooth compatible audio device to the handset to play music, audio of 1Seg, etc. wirelessly. Also, remote control operation may be available from Bluetooth devices. However, compatible devices are limited depending on the data type.
 - *6 Operate the handset from a commercially available input device compatible with Bluetooth such as a keyboard and mouse by connecting one to the handset via Bluetooth.
 - *7 Connect a Bluetooth compatible PC etc. to the handset via Bluetooth to use the handset as a modem and make data communications. Note that packet communication charges are incurred.
 - *8 Connect a Bluetooth device to the handset with the file transfer service to send and receive data between them.
 - *9 Set the virtual connection with a serial cable and interconnect between devices.
 - *10 Transfer phonebook data in the system memory to a Bluetooth device. Data is not displayed correctly on the other party's device depending on the contents of the transferred phonebook data.
 - *11 Join a PC network etc. and share the Internet connection.
 - *12 Communicate data with a commercially available health appliance compatible with Bluetooth such as a weighing machine.
- Refer to the manual for the Bluetooth device as well.
 - You may not hear sounds such as 1Seg with Bluetooth devices which are not compatible with SCMS-T.

Precautions for handling the Bluetooth device

Note the following when using the Bluetooth device.

- Note the following to make good connection.
 - Keep the distance between the handset and another Bluetooth device within approximately 10 m with no obstructions in sight. The distance that can make connection may be shorter when there are obstructions between them or depending on the conditions of the surroundings (such as walls or furniture) and the structure of a building. Especially when there is a wall or floor of reinforced concrete between them, they may be unable to connect with each other. Note the above mentioned distance is not guaranteed.
 - Move the handset and another Bluetooth device as far away as possible from home electric appliances, AV devices, OA devices, etc. before connection. The Bluetooth device is liable to be adversely affected by a microwave oven, so move it as far away as possible from the microwave oven while using it. Otherwise, normal connection cannot be performed when other electric devices are powered on or Bluetooth devices may cause noises or reception failure on a TV or radio set.
 - Move the Bluetooth device to a place where connection is possible when there is a broadcast station or radio near the Bluetooth device and the handset cannot be connected to the device. Strong radio waves may prevent connection between Bluetooth devices.

- Wireless connection is available with Bluetooth device put in a bag or pocket. However, lowering of communication speed or noise may result when you are in between the Bluetooth device and the handset.
- Electromagnetic signals from the Bluetooth device may affect the operation of electronic medical equipment etc. As some cases may result in accident, turn off the handset and other Bluetooth devices in the following place.
 - On trains
 - On airplanes
 - In hospitals
 - Nearby automatic doors or fire alarms
 - In places such as gas stations where flammable gas is generated

The radio interference with Wi-Fi compatible devices

- The Bluetooth devices use the same frequency band (2.4 GHz) as wireless LANs (IEEE 802.11b/g/n). Therefore, using the Bluetooth device near a wireless LAN device may cause the radio interference, lowering of communication speed, noise or connection failure. In this case, turn off the wireless LAN device or keep the handset and the Bluetooth device at least approximately 10 m away from the wireless LAN.

Bluetooth

- To register/connect a Bluetooth device, the Bluetooth passkey may need to be entered. Before starting the registration, decide one- to sixteen-digit number. Enter the same number on the handset and the other party's Bluetooth device.
- Set the other party's Bluetooth device to the registration stand-by status in advance.

1 In the home screen, [☰] ▶ [Settings] ▶ [Bluetooth]

2 Slide [OFF] to the right

3 Select a Bluetooth device ▶ [Pair]

- Entering the Bluetooth passkey may be necessary depending on the other party's Bluetooth device. Also, some Bluetooth devices may start connecting after completing registration.
- To display/hide the handset's name on the other party's Bluetooth device: [SH-04E]
 - The handset name is automatically hidden when the period of time set for Visibility timeout has passed.
- To search for Bluetooth devices: [SEARCH FOR DEVICES]
- Touch [🔗] of a paired Bluetooth device to change the name and the connection type of the other party's Bluetooth device.

- If you fail to connect, connection may become available after re-registration of Bluetooth devices.

- When the Bluetooth function is enabled, the handset is set to receive a registration request/connection request from other Bluetooth devices. Perform the setting for displaying the handset's information on the other party's Bluetooth device in advance to allow the handset to be searched for by other Bluetooth devices.
- While in connection stand-by, even if a connection request from a Bluetooth device is received, connection may not be made depending on the signal status etc.
- For details on the operations of the other party's Bluetooth device, refer to the manuals of the Bluetooth device to be used.

When receiving registration request from Bluetooth device or connection request from unregistered Bluetooth device

1 Registration request/Connection request from Bluetooth device

2 Drag the status bar down ▶ [Pairing request] ▶ [Pair]

- When the confirmation screen about the settings on pairing appears, select [Pair].
- Entering the Bluetooth passkey may be necessary depending on the other party's Bluetooth device.
- The confirmation screen for connection may be displayed.

Disabling registration of Bluetooth device

- 1 In the Bluetooth screen, [] of the Bluetooth device to unregister ▶ [Unpair]

Disabling connection of Bluetooth device

- 1 In the Bluetooth screen, select the Bluetooth device to disconnect ▶ [OK]

Setting Bluetooth

- Set after enabling Bluetooth function.

- 1 In the Bluetooth screen, []
- 2 Select an item
 - **Rename phone**: Change the handset's name.
 - **Visibility timeout**: Set the time to be displayed on the other party's Bluetooth device.
 - **aptX**: Set whether to use aptX®.
 - **Handsfree setting**: Set whether to always have voices emitted from the connected Bluetooth compatible hands-free device during a voice call.
 - **Show received files**: Display the history of data received via Bluetooth connection.

Sending and receiving by Bluetooth

Sending data

Example: Still picture

- 1 In the home screen, [] ▶ [Contents Manager]
- 2 Touch a still picture for a while ▶ [Share] ▶ [Bluetooth]
 - Set the receiver's Bluetooth device to receive data.
- 3 Select a Bluetooth device to connect to

Receiving data

- 1 Send data from the sender's Bluetooth device
- 2 Drag the status bar down ▶ select data to receive ▶ [Accept]
- 3 Drag the status bar down ▶ select the received data

- Note that if you select [Delete all before registration] at receiving all data, all data registered to the target function are deleted.
- Some data cannot be received all.
- When available space in the save destination becomes insufficient, the data being received to that point are saved and receiving ends.

External device connection

Connecting the handset and PC

- 1 Insert the microUSB plug of Micro USB Cable 01 (sold separately) horizontally into the external connector terminal on the handset (1)
- 2 Insert the USB plug of Micro USB Cable 01 horizontally into the USB connector on the PC (2)

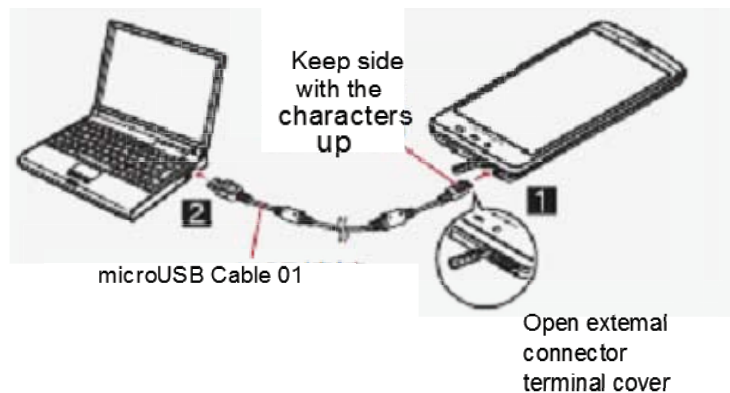

- Use a USB cable Micro USB Cable 01. USB cables for PC are not available, since the plug shape is different.
- Using a USB HUB may prevent the equipment from working normally.

- Do not remove Micro USB Cable 01 while exchanging data with PC. Data may be damaged.
- Windows XP, Windows Vista and Windows 7 all of which are Japanese version are available OS of PCs for the connection.

microSD reader/writer

You can use a microSD Card inserted into the handset as external memory for a PC.

- Insert a microSD Card and set the mode of USB connection to [Card reader mode] in advance
- When using a microSDXC Card, refer to Transferring data (P. 112). When a message indicating to format the microSDXC Card is displayed, do not format it.

- 1 Connect the handset to a PC via Micro USB Cable 01
 - The USB mass storage screen appears. If the screen does not appear, drag the status bar down and select [USB connected].
- 2 [Turn on USB storage]
 - When the confirmation screen is displayed, check the content and select [OK].
- 3 Use as a microSD reader/writer
- 4 Perform secure hardware removal on the PC after use
- 5 [Turn off USB storage]
- 6 Disconnect Micro USB Cable 01 from the handset

Osaifu-Keitai

Osaifu-Keitai is a function which has built-in IC card and allows you to pay, use as coupons or collect stamps by simply holding the handset over the scanning device at stores.

Moreover, you can access sites and web pages by holding the handset over the scanning device, and get the latest coupon, deposit electronic money and check your usage by using communication. In addition, for your secure use, you can lock functions of Osaifu-Keitai when you lost the handset.

For details on Osaifu-Keitai, refer to “ご利用ガイドブック (spモード編)” (Mobile Phone User’s Guide [sp-mode]) (in Japanese only).

※ To use Osaifu-Keitai compatible service, settings are necessary on a website or an application.

- The handset malfunctions may cause data (including electronic money, points, etc.) saved in the IC card to be lost or changed (Note that as a rule, you will be asked to delete data when leaving your handset for repairs etc., since we cannot keep your handset with such data still remaining in it). For the service such as a reissue, restoration, temporary keeping or transference of the data, contact your provider of Osaifu-Keitai compatible service. Be sure to use the Osaifu-Keitai compatible service including a backup service for important data.
- DOCOMO shall not be liable for any loss or change of data in the IC card or other damages of Osaifu-Keitai service caused by any reason such as malfunctions and model changes.
- When the handset is stolen or lost, immediately contact your provider of Osaifu-Keitai compatible service for handling methods.

iC transfer service

iC transfer service is a service that enables you to move the data saved in the IC card to new Osaifu-Keitai from the old one when changing Osaifu-Keitai such as by changing models or repairing the handset.

iC transfer service is available at a docomo Shop near you.

For details on iC transfer service, refer to “ご利用ガイドブック (spモード編)” (Mobile Phone User’s Guide [sp-mode]) (in Japanese only).

Using Osaifu-Keitai

- To use Osaifu-Keitai compatible services, download the Osaifu-Keitai compatible application from Osaifu-Keitai compatible sites and make the setting. Some services do not need to download the Osaifu-Keitai compatible application.

1 In the home screen, [] ▶ [Osaifu-Keitai]





- If the initial setting is not completed, the initial setting screen appears.

2 Select a service

- You cannot use Osaifu-Keitai in the following situations. However, you can pay by holding the handset over a scanning device.
 - In Airplane mode
 - When you are charging the handset, connecting Micro USB Cable 01 (sold separately) to it or connecting an earphone/microphone to it while the docomo mini UIM card is not inserted/When the handset has never received radio wave

Holding over scanning device

Hold the  mark of the handset over the scanning device to use as electronic money or railway tickets, to retrieve ToruCa, etc.

- Pay attention to the following points when holding the  mark over the scanning device.
 - Do not contact between the handset and the scanning device
 - Hold the  mark in parallel with the scanning device
 - Slowly hold the  mark over the center of the scanning device
 - If the scanning device does not recognize the built-in IC card, hold the  mark over the scanning device and move the handset around
 - Do not attach a metallic substance on the  mark side

1 Hold the mark over the scanning device

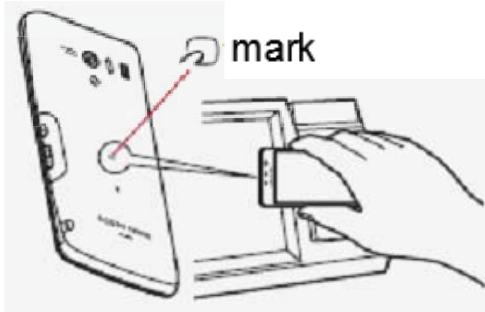

2 Confirm that the data is scanned

Osaifu-Keitai lock setting

Lock the function of Osaifu-Keitai.

- Perform the same operation to disable the lock.

1 In the home screen, [] ▶ [Osaifu-Keitai]

2 [Lock Settings] ▶ [Next] ▶ enter the passcode ▶ [OK] ▶ [OK]

International Roaming

Outline of international roaming (WORLD WING)

International roaming (WORLD WING) is a service that enables you to use the same phone number and mail address of the handset as you use in Japan in the service area of DOCOMO affiliated overseas network operators without changing your phone number and mail address. You can use calls and SMS without any changes in settings.

Available network

The handset is rated as Class 4. You can use it in the 3G network and GSM/GPRS network service area. In addition, this service is available in countries and regions supporting 3G 850 MHz/ GSM 850 MHz. Check the available area.

- For areas out of Xi area such as overseas, connect to 3G or GSM/GPRS network.

Refer to the following before using the handset overseas.

- "Mobile Phone User's Guide [International Services]"
- DOCOMO International Services website

- For country codes, international call access number, universal number international prefix and information on available countries, regions, and network operators, refer to "Mobile Phone User's Guide [International Services]" or the DOCOMO International Services website.

Available services overseas

Main communication service	3G	3G850	GSM (GPRS)
Call	○	○	○
SMS	○	○	○
Mail*	○	○	○
Browser*	○	○	○

* Enable Data roaming to use data communication when roaming

- Some services are not available depending on the network operator or network.

Before use overseas

Check before departure

Check followings in Japan before using the handset overseas.

Subscription

- Check the status of a subscription for WORLD WING. For details, contact "General Inquiries" on the back of this manual.

Charging battery

- Use FOMA AC Adapter 01 for Global use (sold separately), FOMA AC Adapter 02 (sold separately) or AC Adapter 03 (sold separately) as an AC adapter for charging while traveling overseas.

Charge

- Overseas charges (call charges, packet communication charges) differ from those in Japan.
- Since some applications automatically perform packet communication, the packet communication charges may be higher. Contact the application provider for the operation of each application.

Set before departure

Network service settings

If you subscribed to network services, network services such as Voice Mail Service, Call Forwarding Service and Caller ID Display Request Service are available from overseas. However, some network services are not available.

- To use network services overseas, setting Remote operations to “Activate” is required. Remote operations can be set in your country of stay.
- Some network services that can be set/disabled etc. may not be available depending on overseas network operators.

Check in your country of stay

The handset automatically connects to the available network operator when you turn the power on in your country of stay.

Connection

When Network operators (📶 P. 154) is set to [Select automatically], the suitable network is automatically selected.

Overseas packet communication is available with a fixed amount of charges as an upper limit per day by connecting to a compatible network operators. To use this service, subscription to flat-rate packet communication services in Japan is required. For details, refer to “Mobile Phone User’s Guide [International Services]” or the DOCOMO International Services website.

Viewing the display

- [📶] is displayed during international roaming.
- 3G/GSM/HSPA is available.
- Connected network operator can be checked in the status panel.

Date & time

If [Automatic date & time] and [Auto timezone] of Date & time are enabled, the handset receives information on time and time differences from overseas network operator, then time and time differences are corrected.

- Time and time differences may not be adjusted correctly depending on overseas network operator. In such a case, set time zone manually.
- The correction timing differs depending on the network operator.
- For details on Date & time

Inquiries

- When the handset or the docomo mini UIM card is lost or stolen overseas, promptly contact DOCOMO and conduct a procedure for canceling the use of service from your country of stay. Refer to the back of this manual for inquiries. Note that communication/call charges after the handset or the docomo mini UIM card is lost or stolen are incurred to the subscriber.
- For land-line phone etc., “International call access number” of your country of stay or “Universal number international prefix” is required.

Check after homecoming

The handset automatically connects to the DOCOMO network after returning to Japan. If it fails, perform the following settings.

- Set Network Mode to [LTE/3G/GSM (Auto)]
- Set Network operators to [Select automatically]

Settings to use overseas

At the time of purchase, the handset is set to automatically search for and switch to available networks. When you want to manually switch networks, set by performing following operations.

- 1 In the home screen, [☰] ▶
[Settings] ▶ [Network settings] ▶
[Mobile networks]

2 Select an item

- **Data enabled**: Enable data communication.
- **Data roaming**: For details
- **Access Point Names**: Set an access point.
- **Network Mode**: For details
- **Network operators**: For details

Data roaming

Set whether to use data communication when roaming.

- 1 In the home screen, [☰] ▶
[Settings] ▶ [Network settings] ▶
[Mobile networks] ▶ [Data roaming]

Network mode

Set a network to use.

- 1 In the home screen, [☰] ▶
[Settings] ▶ [Network settings] ▶
[Mobile networks] ▶ [Network Mode]

2 Select an item

- **LTE/3G/GSM (Auto)**: Switch to an available network automatically.
- **LTE/3G**: Use 3G network.
- **GSM**: Use GSM/GPRS network.

Network operators

Search for networks and set a network operator to use.

- 1 In the home screen, [⌵] ▶
[Settings] ▶ [Network settings] ▶
[Mobile networks] ▶ [Network
operators]

- If the confirmation screen for data communication is displayed, check the content and select [OK].
- Search for networks and a list of network operators is displayed.

- 2 **Select a network operator**

- To search for network operators again:
[Search networks]
- To select a network operator automatically:
[Select automatically]

- If you manually set network operators overseas, set to [Select automatically] after returning to Japan.

Making/Receiving a call in your country of stay

Making a call outside your country of stay (including Japan)

- 1 In the home screen, [⌵] ▶
[Phone] ▶ [Dial]
- 2 “+” (touch “0” for a while) ▶ enter
country code, area code (city code)
and the other party’s phone
number ▶ [↵]

- Alternatively, enter a phone number ▶ [☰] ▶
[International call] ▶ select a country code to
enter a country code.
 - The first “0” of the area code (city code) will
be omitted.
- When the area code (city code) begins with
“0”, omit the first “0” when dialing (Include the
“0” when making a call to some countries or
regions such as Italy).

- Even if you notify the caller ID, [Unknown],
[Private number], etc. appears depending on
the network operator, and the caller ID may not
be displayed correctly.

Making a call using International Dial Assist

When you make a call to other countries from your country of stay, you can make an international call with simple operation using International Dial Assist.

- Set International dial assist in advance.
- The first “0” of a phone number will be converted to the country code you set in Country code automatically.

- 1 In the home screen, [☰] ▶ [Phone] ▶ [Dial]
- 2 Enter a phone number ▶ [↵]
- 3 [Converted number]

Setting of International Dial Assist

- 1 In the home screen, [☰] ▶ [Settings] ▶ [Call] ▶ [Roaming settings] ▶ [International dial assist]
- 2 Select an item
 - **Automatic conversion function:** Set whether to make calls using International Dial Assist.
 - **Country code:** Set country code to use when using International Dial Assist.
 - **International prefix:** Set international prefix to use when using International Dial Assist.

Making a call in your country of stay

You can make a domestic call in your country of stay in the same way as you do in Japan.

- Always enter the area code (city code), even when the number is in the same area.

Making a call to a WORLD WING subscriber overseas

When you make a call to a “WORLD WING” subscriber overseas, the call is made as an international call to Japan regardless of your country of stay.

- 1 In the home screen, [☰] ▶ [Phone] ▶ [Dial]
- 2 “+” (touch “0” for a while) ▶ enter country code “81” (Japan), the other party’s mobile phone number excluding the first “0” ▶ [↵]

Receiving a call

You can receive a call overseas in the same way as you do in Japan.

- When a call is received during international roaming, the call is forwarded from Japan. Call charges to Japan are incurred by the caller and receiving charges by the receiver.

■ Having calls to your handset

When having calls made to your handset from Japan, have your phone number entered just as a domestic call in Japan.

When having calls made to your handset from countries other than Japan, have the international call access number and “81” (Japan) added to the beginning of your phone number with the first “0” excluded as an international call to Japan regardless of your country of stay.

International call access number of the country of the caller-81-90 (or 80)-XXXX-XXXX

Specific Absorption Rate (SAR) of Mobile Phone

This model SH-04E mobile phone complies with Japanese technical regulations and international guidelines regarding exposure to radio waves.

This mobile phone was designed in observance of Japanese technical regulations regarding exposure to radio waves (*1) and limits to exposure to radio waves recommended by a set of equivalent international guidelines. This set of international guidelines was set out by the International Commission on Non-Ionizing Radiation Protection (ICNIRP), which is in collaboration with the World Health Organization (WHO), and the permissible limits include a substantial safety margin designed to assure the safety of all persons, regardless of age and health condition.

The technical regulations and international guidelines set out limits for radio waves as the Specific Absorption Rate, or SAR, which is the value of absorbed energy in any 10 grams of tissue over a 6-minute period. The SAR limit for mobile phones is 2.0 W/kg. The highest SAR value for this mobile phone when tested for use at the ear is 0.387 W/kg. There may be slight differences between the SAR levels for each product, but they all satisfy the limit.

The actual SAR of this mobile phone while operating can be well below that indicated above. This is due to automatic changes to the power level of the device to ensure it only uses the minimum required to reach the network. Therefore in general, the closer you are to a base station, the lower the power output of the device.

This mobile phone can be used in positions other than against your ear. This mobile phone satisfies the international guidelines when used with a carrying case or a wearable accessory approved by NTT DOCOMO, INC. (*2). In case you are not using the approved accessory, please use a product that does not contain any metals, and one that positions the mobile phone at least 1.5 cm away from your body.

The World Health Organization has stated that “a large number of studies have been performed over the last two decades to assess whether mobile phones pose a potential health risk. To date, no adverse health effects have been established as being caused by mobile phone use.”

Please refer to the WHO website if you would like more detailed information.

http://www.who.int/docstore/peh-emf/publications/facts_press/fact_english.htm

Please refer to the websites listed below if you would like more detailed information regarding SAR.

Ministry of Internal Affairs and Communications
Website:

<http://www.tele.soumu.go.jp/e/sys/ele/index.htm>

Association of Radio Industries and Businesses
Website:

<http://www.arib-emf.org/index02.html> (in Japanese only)

NTT DOCOMO, INC. Website:

<http://www.nttdocomo.co.jp/english/product/sar/>

SHARP Corporation Website:

<http://www.sharp.co.jp/products/menu/phone/cellular/sar/index.html> (in Japanese only)

- *1 Technical regulations are defined by the Ministerial Ordinance Related to Radio Law (Article 14-2 of Radio Equipment Regulations).
- *2 Regarding the method of measuring SAR when using mobile phones in positions other than against the ear, international standards (IEC62209-2) were set in March of 2010. On the other hand, technical regulation is currently being deliberated on by national council (As of October, 2011).

European RF Exposure Information

Your mobile device is a radio transmitter and receiver. It is designed not to exceed the limits for exposure to radio waves recommended by international guidelines. These guidelines were developed by the independent scientific organization ICNIRP and include safety margins designed to assure the protection of all persons, regardless of age and health.

The guidelines use a unit of measurement known as the Specific Absorption Rate, or SAR. The SAR limit for mobile devices is 2 W/kg and the highest SAR value for this device when tested at the ear was 0.469 W/kg*.

As SAR is measured utilizing the devices highest transmitting power the actual SAR of this device while operating is typically below that indicated above. This is due to automatic changes to the power level of the device to ensure it only uses the minimum level required to reach the network.

The World Health Organization has stated that present scientific information does not indicate the need for any special precautions for the use of mobile devices. They note that if you want to reduce your exposure then you can do so by limiting the length of calls or using a hands-free device to keep the mobile phone away from the head.

-
- * The tests are carried out in accordance with international guidelines for testing.

Declaration of Conformity

CE 0168

Hereby, Sharp Telecommunications of Europe Ltd, declares that this SH-04E is in compliance with the essential requirements and other relevant provisions of Directive 1999/5/EC.
 A copy of the original declaration of conformity can be found at the following Internet address:
<http://www.sharp.co.jp/k-tai/> (in Japanese only)

FCC Notice

- This device complies with part 15 of the FCC Rules.
 Operation is subject to the following two conditions:
 (1) This device may not cause harmful interference, and (2) this device must accept any interference received, including interference that may cause undesired operation.
- Changes or modifications not expressly approved by the manufacturer responsible for compliance could void the user's authority to operate the equipment.

Information to User

This equipment has been tested and found to comply with the limits of a Class B digital device, pursuant to Part 15 of the FCC Rules. These limits are designed to provide reasonable protection against harmful interference in a residential installation. This equipment generates, uses and can radiate radio frequency energy and, if not installed and used in accordance with the instructions, may cause harmful interference to radio communications.

However, there is no guarantee that interference will not occur in a particular installation; if this equipment does cause harmful interference to radio or television reception, which can be determined by turning the equipment off and on, the user is encouraged to try to correct the interference by one or more of the following measures:

1. Reorient/relocate the receiving antenna.
2. Increase the separation between the equipment and receiver.
3. Connect the equipment into an outlet on a circuit different from that to which the receiver is connected.
4. Consult the dealer or an experienced radio/TV technician for help.

FCC RF Exposure Information

Your handset is a radio transmitter and receiver. It is designed and manufactured not to exceed the emission limits for exposure to radio frequency (RF) energy set by the Federal Communications Commission of the U.S. Government.

The guidelines are based on standards that were developed by independent scientific organizations through periodic and thorough evaluation of scientific studies. The standards include a substantial safety margin designed to assure the safety of all persons, regardless of age and health. The exposure standard for wireless handsets employs a unit of measurement known as the Specific Absorption Rate, or SAR. The SAR limit set by the FCC is 1.6 W/kg.

The tests are performed in positions and locations (e.g., at the ear and worn on the body) as required by the FCC for each model. The highest SAR value for this model handset when tested for use at the ear is 0.597 W/kg and when worn on the body, as described in this user guide, is 0.665 W/kg. For body worn operation, this phone has been tested and meets the FCC RF exposure guidelines. Please use an accessory designated for this product or an accessory which contains no metal and which positions the handset a minimum of 1.5 cm from the body.

The use of accessories that do not satisfy these requirements may not comply with FCC RF exposure requirements, and should be avoided. The FCC has granted an Equipment Authorization for this model handset with all reported SAR levels evaluated as in compliance with the FCC RF emission guidelines. SAR information on this model handset is on file with the FCC and can be found under the Display Grant section of <http://www.fcc.gov/oet/ea/fccid/> after searching on FCC ID APYHRO00184. Additional information on Specific Absorption Rates (SAR) can be found on the FCC website at <http://www.fcc.gov/>.

Export Administration Regulations

The Japan Export Administration Regulations (“Foreign Exchange and Foreign Trade Act” and its related laws) will be applied to this product and its accessories under certain conditions. The Export Administration Regulations are also applied. To export or reexport the handset and its accessories, conduct all legally required procedures at your own risk and expense. For details on the procedures, contact the Ministry of Economy, Trade and Industry or the US Department of Commerce.

Intellectual Property Right

Copyrights and rights of portrait

- Data with third party copyrights such as text, images, music and software that is downloaded via Internet web pages, acquired by TV, video, etc. or shot by the handset cannot be duplicated, altered or publicly transmitted without rightful party’s consent. Only duplicating, quoting, etc. for personal use is permitted under copyright laws. Even if for personal use, filming and recording may be prohibited for demonstrations, performances and exhibitions. Also, shooting another’s image or posting another’s image on Internet web pages without their consent may constitute a violation of one’s right to their image.

Registered trademarks and trademarks

- “FOMA”, “dメニュー”, “dマーケット”, “おサイフケータイ”, “ToruCa”, “mopera”, “mopera U”, “Deco-mail”, “i-αpli”, “i-mode”, “i チャンネル”, “iD”, “WORLD WING”, “WORLD CALL”, “エリアメール”, “i コンシェル”, “sp-mode”, “eトリセツ”, the “iD” logo and the “Xi” logo are trademarks or registered trademarks of NTT DOCOMO, INC.
- “Catch Phone (Call waiting service)” is a registered trademark of Nippon Telegraph and Telephone Corporation.
- Microsoft®, Windows®, Windows Media®, Windows Vista® and Exchange® are trademarks or registered trademarks of Microsoft Corporation in the United States and/or other countries.
- Oracle and Java are registered trademarks of Oracle and/or its affiliates. Other names may be trademarks of their respective owners.
- QR code is a registered trademark of Denso Wave Inc.
- microSD Logo, microSDHC Logo and microSDXC Logo are trademarks of SD-3C, LLC.



- Included Document Viewer is Documents To Go provided by DataViz, Inc.
©2010 DataViz, Inc. and its licensors. All rights reserved. DataViz, Documents To Go and InTact Technology are trademarks or registered trademarks of DataViz, Inc.

- The handset features LCFONT, developed by Sharp Corporation, to make the LCD easier to view and read. LCフォント/LCFONT and  are registered trademarks of Sharp Corporation.
- Rovi, G-GUIDE, G-GUIDE MOBILE and G-Guide related logos are trademarks or registered trademarks of Rovi Corporation and/or its subsidiaries in Japan.



- OBEX™ is a trademark of Infrared Data Association®.
-  is a registered trademark of FeliCa Networks, Inc.
- Manufactured under license from Dolby Laboratories. Dolby and the double-D symbol are registered trademarks of Dolby Laboratories.
- PhotoScouter® and TrackSolid® are registered trademarks of Morpho, Inc.
- A OSS™ and AOSS™ are the trademarks of BUFFALO INC.
- Wi-Fi® is a registered trademark of Wi-Fi Alliance®.
- Wi-Fi Direct™, Wi-Fi Protected Setup™ and Wi-Fi Protected Setup logo are trademarks of Wi-Fi Alliance®.
The Wi-Fi Protected Setup Mark is a mark of the Wi-Fi Alliance.
- “mixi” is a registered trademark of mixi, Inc.
- “Twitter” is a registered trademark of Twitter, Inc.

- DLNA[®], the DLNA Logo and DLNA CERTIFIED™ are trademarks, service marks, or certification marks of the Digital Living Network Alliance.
Sharp Corporation has acquired DLNA certification for the device.
- This product includes software developed by the OpenSSL Project for use in the OpenSSL Toolkit. (<http://www.openssl.org/>)
- This product includes cryptographic software written by Eric Young (eay@cryptsoft.com)
- Portions Copyright © 2004 Intel Corporation
This product partly uses the software of Intel Corporation.
- iWnn of OMRON SOFTWARE Co., Ltd. is used for conversion methods for Japanese language, and for phrase prediction methods for English.
iWnn© OMRON SOFTWARE Co., Ltd.
2008-2012 All Rights Reserved.
iWnn IME © OMRON SOFTWARE Co., Ltd.
2009-2012 All Rights Reserved.
- Shin Go M, the font type installed in this product, is provided by Morisawa & Company, Ltd.
* Shin Go is a registered trademark of Morisawa & Company, Ltd.
- MyScript[®] Stylus Mobile is a trademark of VISION OBJECTS.
- aptX is a registered trademark of CSR plc.
- “AQUOS”, “AQUOS PHONE”, “Feel UX”, “VeilView”, “FAMILINK”, “MediaJet”, “エコ技”, “Dock to play”, “AQUOS PHONE” logo and “エコ技” symbol are trademarks or registered trademarks of Sharp Corporation.
- All other company names and product names are trademarks or registered trademarks of the respective companies.

Others

- FeliCa is a contactless IC card technology developed by Sony Corporation. FeliCa is a registered trademark of Sony Corporation.
- Under the MPEG-4 Visual Patent Portfolio License, customers have licensed permission for the following use of this product to engage in non-profit personal use. Other uses are not permitted.
 - Encoding MPEG-4 standard video (henceforth referred to as MPEG-4 video).
 - Decoding an MPEG-4 video that a customer not engaged in personal commercial activities has encoded.
 - Decoding an MPEG-4 video obtained from a licensed provider.
 For details on other intended uses, contact MPEG LA, LLC.
- This product is licensed under the MPEG-4 Systems Patent Portfolio License for encoding in compliance with the MPEG-4 Systems Standard. An additional license and payment of royalties are necessary in the following cases.
 - Data stored or replicated in physical media which is paid for on a title by title basis.
 - Data which is paid for on a title by title basis and is transmitted to an end user for permanent storage and/or use.
 Such additional license may be obtained from MPEG LA, LLC. Contact MPEG LA, LLC for additional details.

- This product is licensed under the AVC patent portfolio license for the personal and noncommercial use of a consumer to (i) encode video in compliance with the AVC standard (henceforth referred to as AVC video) and/or (ii) decode AVC video that was encoded by a consumer engaged in a personal and noncommercial activity and/or was obtained from a video provider licensed to provide AVC video. No license is granted or shall be implied for any other use. Additional information may be obtained from MPEG LA, L.L.C. See <http://www.mpegla.com>
- This product is licensed under the VC-1 Patent Portfolio License for the personal and noncommercial use of a consumer to (i) encode video in compliance with the VC-1 standard (henceforth referred to as VC-1 video) and/or (ii) decode VC-1 video that was encoded by a consumer engaged in a personal and noncommercial activity and/or was obtained from a video provider licensed to provide VC-1 video. No license is granted or shall be implied for any other use. Additional information may be obtained from MPEG LA, L.L.C. See <http://www.mpegla.com>
- Content owners use Microsoft PlayReady™ content access technology to protect their intellectual property, including copyrighted content. This device uses PlayReady technology to access PlayReady-protected content and/or WMDRM-protected content. If the device fails to properly enforce restrictions on content usage, content owners may require Microsoft to revoke the device's ability to consume PlayReady-protected content. Revocation should not affect unprotected content or content protected by other content access technologies. Content owners may require you to upgrade PlayReady to access their content. If you decline an upgrade, you will not be able to access content that requires the upgrade.

- The abbreviations of operating systems (Japanese versions) below are used in this manual.
 - Windows 7 stands for Microsoft® Windows® 7 (Starter, Home Basic, Home Premium, Professional, Enterprise and Ultimate).
 - Windows Vista stands for Windows Vista® (Home Basic, Home Premium, Business, Enterprise and Ultimate).
 - Windows XP indicates the Microsoft® Windows® XP Professional operating system or Microsoft® Windows® XP Home Edition operating system.
- The Bluetooth word mark and logos are owned by the Bluetooth SIG, INC. and any use of such marks by NTT DOCOMO, INC. is under license. Other trademarks and trade names are those of their respective owners.
- Google, Google logo, Android, Android logo, Google Play, Google Play logo, Google+, Google+ logo, Gmail, Gmail logo, Calendar logo, Google Maps™, Google Maps logo, Google Talk, Google Talk logo, Google Chrome™, Google Chrome logo, Google Voice Search™ logo, Picasa™, Picasa logo, YouTube and YouTube logo are trademarks or registered trademarks of Google Inc.