

General Inquiries <docomo Information Center>

(Business hours: 9:00 a.m. to 8:00 p.m.)

 **0120-005-250 (toll free)**

※ Service available in: English, Portuguese, Chinese, Spanish.

※ Unavailable from part of IP phones.

(Business hours: 9:00 a.m. to 8:00 p.m. (open all year round))

■ **From DOCOMO mobile phones (In Japanese only)**

 **(No prefix) 151 (toll free)**

※ Unavailable from land-line phones, etc.

■ **From land-line phones (In Japanese only)**

 **0120-800-000 (toll free)**

※ Unavailable from part of IP phones.

● Please confirm the phone number before you dial.

● For Applications or Repairs and After-Sales Service, please contact the above-mentioned information center or the docomo Shop etc. near you on the NTT DOCOMO website.

NTT DOCOMO website <http://www.nttdocomo.co.jp/english/>

For loss, theft, malfunction, and inquiries while overseas (24-hour reception)

■ **From DOCOMO mobile phones**

International call access code for the country you stay -81-3-6832-6600* (toll free)

* You are charged a call fee to Japan when calling from a land-line phone, etc.

※ If you use SH-04F, you should dial the number +81-3-6832-6600 (to enter "+", touch and hold "0").

■ **From land-line phones <Universal number>**

Universal number international prefix -8000120-0151*

* You might be charged a domestic call fee according to the call rate for the country you stay.

※ For international call access codes for major countries and universal number international prefix, refer to DOCOMO International Services website.

● **If you lose your handset or have it stolen, immediately take the steps necessary for suspending the use of the handset.**

● **If the handset you purchased is damaged, bring your handset to a repair counter specified by DOCOMO after returning to Japan.**



Don't forget your mobile phone... or your manners!

When using your mobile phone in a public place, don't forget to show common courtesy and consideration for others around you.



危険です、
歩きスマホ。

Repairs

(Business hours: 24 hours (open all year round))

■ **From DOCOMO mobile phones**

(In Japanese only)

 **(No prefix) 113 (toll free)**

※ Unavailable from land-line phones, etc.

■ **From land-line phones (In Japanese only)**

 **0120-800-000 (toll free)**

※ Unavailable from part of IP phones.

NTT
docomo

AQUOS ZETA SH-04F

INSTRUCTION MANUAL '14.●

Sales: NTT DOCOMO, INC.
Manufacturer: SHARP Corporation



Li-Ion00

'14.● (1st Edition)
14● TU***①

Introduction

Thank you for purchasing “SH-04F”.

Be sure to read this manual before and during use to ensure proper operation.

Checking operation method

Quick Start Guide (Basic package) (in Japanese only)

This guide describes operations of basic functions.

User’s Manual (App of the handset) (in Japanese only)

This manual describes detailed guidance and operations of functions.

In the home screen, [] ▶ [Instruction Manual]

To display help: [] ▶ [本アプリの使いかた] (How to use this app)

User’s Manual (in PDF format)

This manual describes detailed guidance and operations of functions.

Download from the DOCOMO website

<http://www.nttdocomo.co.jp/english/support/trouble/manual/download/index.html>

※ The URL and contents are subject to change without prior notice.

- The screens and illustrations in this manual are shown as examples. The actual screens and illustrations may differ.
- The explanations in this manual are based on the case when the home app is docomo LIVE UX. If you change the home app, operation procedures etc. may be different from the explanations of this manual.
- Note that “SH-04F” is referred to as “handset” in this manual.
- This manual refers to microSD Card, microSDHC Card or microSDXC Card as “microSD Card” or “microSD”.
- Reproduction of this manual in part or in whole without prior permission is prohibited.
- The contents of this manual are subject to change without prior notice.

Basic package



SH-04F
(includes warranty)

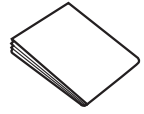

Quick Start Guide
(in Japanese only)

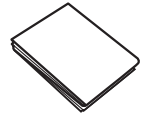



Notes on usage
(in Japanese only)

- For optional parts (sold separately) compatible with the handset, refer to the DOCOMO website.
<https://www.nttdocomo.co.jp/product/option/> (in Japanese only)







Precautions (ALWAYS FOLLOW THESE DIRECTIONS)

- Before use, read these “Precautions” carefully and use your handset properly.
Keep this manual in a safe place for future reference.
- These precautions contain information intended to prevent bodily injury to the user and to surrounding people, as well as damage to property, and must be observed at all times.

The following symbols indicate the different degrees of injury or damage that may occur if information provided is not observed and the handset is used improperly.

 Danger	This symbol indicates that “death or serious bodily injury may directly and immediately result from improper use”.
 Warning	This symbol indicates that “death or serious bodily injury may result from improper use”.
 Caution	This symbol indicates that “minor injury and/or property damage may result from improper use”.

The following symbols indicate specific directions.

 Indicates a prohibited action.	 Indicates not to handle the device with wet hands.
 Indicates not to disassemble the device.	 Indicates that instructions specified are compulsory (must be followed).
 Indicates not to use the device near water or get it wet.	 Indicates that the power cord must be unplugged from the outlet.

“Precautions” is explained in the following six sections.





- Handling the handset, adapters and docomo mini UIM card (general) P. 4
- Handling the handset P. 5
- Handling adapters P. 6
- Handling docomo mini UIM card P. 7
- Handling near electronic medical equipment P. 7
- Material list P. 7

Handling the handset, adapters and docomo mini UIM card (general)

Danger

-  **Do not use, store or leave the equipment in locations subject to high temperatures (near a fire or heating unit, in a kotatsu, under direct sunlight, inside a vehicle on a hot day, etc.).**
May cause fires, burns or bodily injury.
-  **Do not place the equipment inside cooking appliances such as microwave ovens or pressure cookers.**
May cause fires, burns, bodily injury or electric shock.
-  **Do not attempt to disassemble or modify the equipment.**
May cause fires, burns, bodily injury or electric shock.
-  **Do not get the equipment wet with water, drinking water, pet urine, sweat, etc.**
May cause fires, burns, bodily injury or electric shock.
Refer to the following for details on waterproofness.
☞ P. 10 “Waterproof”
-  **Do not allow liquids (water, drinking water, pet urine, sweat, etc.) to get inside the charger terminal or external connector terminal.**
May cause fires, burns, bodily injury or electric shock.
-  **Use only optional parts specified by NTT DOCOMO for use with the handset.**
May cause fires, burns, bodily injury or electric shock.

Warning

-  **Do not subject the equipment to strong force or impacts or throw it.**
May cause fires, burns, bodily injury or electric shock.
-  **Do not allow conductive materials (such as metal objects and pencil lead) to come into contact with the charger terminal, external connector terminal or earphone/microphone terminal. In addition, do not insert such objects.**
May cause fires, burns, bodily injury or electric shock.
-  **Do not cover or wrap the equipment with bedding etc. when using or charging.**
May cause fires or burns.
-  **Be sure to turn off the handset and not to charge the battery in locations such as gas stations where flammable gas is generated.**
May cause a gas explosion or fire.
To use Osaifu-Keitai in locations such as gas stations, be sure to turn off the power in advance (If NFC/Osaifu-Keitai lock is set, disable the lock before turning off the power).
-  **If you notice anything unusual, such as an unusual odor, overheating, discoloration or deformation during use, charging or storage, immediately follow the instructions below.**
 - Unplug the power plug from the outlet or cigarette lighter socket.
 - Turn off the handset.
 May cause fires, burns, bodily injury or electric shock.

Caution

 **Do not leave the equipment on unstable surfaces, such as on a wobbly table or sloped surface.**
Don't May fall and cause injury.

 **Do not store the equipment in locations that are subject to humidity, dust or high temperatures.**
Don't May cause fires, burns or electric shock.

 **If being used by a child, have a guardian teach him/her the proper handling procedures. In addition, check that the child is using the equipment as directed.**
Instruction May result in bodily injury etc.

 **Keep the equipment out of the reach of young children.**
Instruction A young child may swallow the equipment or suffer bodily injury etc.

 **Be very careful when using the handset connected to adapters repeatedly or for long periods of time.**
Instruction The handset or adapters may become warm if you watch TV etc. for a long time while charging. Touching high temperature areas for a prolonged period of time may cause skin irritations, itchiness or low-temperature burns in some people.

Handling the handset

The following is the type of the internal battery built into the handset.

Label	Battery type
Li-ion00	Lithium-ion

Danger

 **Do not throw the handset into a fire or heat it.**
Don't The internal battery may catch fire, explode, overheat or leak.

 **Do not apply excessive force on the handset such as by puncturing it, hitting it with a hammer or stepping on it.**
Don't The internal battery may catch fire, explode, overheat or leak.

 **If the battery fluid etc. comes into contact with your eyes, do not rub your eyes but immediately rinse your eyes with clean water. Then seek prompt medical treatment.**
Instruction May result in loss of eyesight.

Warning

 **Do not aim the infrared port towards the eyes.**
Don't May cause eye injury.

 **Do not aim the infrared port towards home electric appliances with an infrared device during infrared communication.**
Don't May interfere with the operation of infrared devices and cause an accident.

 **Do not point the illuminated light directly at someone's eyes. Especially when you shoot still pictures or videos of young children, keep 1 m or more distance from them.**
Don't Do not use Mobile light near people's faces. Eyesight may be temporarily affected leading to accidents.

 **Do not allow water or other liquids, metal, flammable material or other foreign objects to enter the docomo mini UIM card slot or microSD Card slot on the handset.**
Don't May cause fires, burns, bodily injury or electric shock.

 **Do not shine the light at anyone driving a car or other vehicles.**
Don't May prevent a driver from driving safely and cause a traffic accident.

 **Turn off the handset in areas where the use of mobile phones is prohibited, such as in aircraft or hospitals.**
Instruction May interfere with the operation of electronic devices and electronic medical equipment. Follow the instructions given by the respective medical facilities regarding the use of mobile phones on their premises. Actions such as using a mobile phone aboard aircraft are prohibited and punishable by law. However, follow the instructions on use of the handset given by the airline if the handset can be used aboard aircraft by setting the handset not to emit radio wave etc.

 **Keep the handset away from the ears during a call in which hands-free is set or while the ringtone is ringing.**
Instruction **When you attach the earphone/microphone etc. to the handset to play games, music, etc., do not make the volume too loud.**
Excessively high volume may damage your hearing. Also, it may prevent you from hearing ambient sounds and cause an accident.

 **If you have a weak heart, take extra precautions when setting functions such as the vibrator and ringtone volume for incoming calls.**
Instruction May have harmful effects on your heart.

 **If you are using electronic medical equipment, contact the respective manufacturer or dealer to check whether the operation of the equipment is affected by signals.**
Instruction May interfere with the operation of electronic medical equipment etc.

 **Turn off the handset near high-precision electronic devices or devices that use weak electronic signals.**
Instruction May interfere with the operation of electronic devices. **Take particular care with the following devices**
Hearing aids, implanted cardiac pacemakers, implanted cardioverter-defibrillators or other electronic medical equipment. Fire alarms, automatic doors, and other equipment controlled by electronic signals. If you use an implanted cardiac pacemaker, implanted cardioverter-defibrillator or other electronic medical equipment, contact the respective manufacturer or dealer to check whether the operation of the equipment is affected by signals.



Instruction

If the display part or camera lens is damaged, be careful of broken glass and the exposed inside of the handset.

Tape is pasted on the back of the display while the surface of the display is covered by a protective film so as to minimize the possibility of glass scattering. However, touching the broken or exposed parts may cause bodily injury.



Instruction

If the internal battery leaks or emits an unusual odor, immediately stop using the handset and move it away from any naked flames or fire.

The battery fluid is flammable and could ignite, causing a fire or explosion.

Caution



Don't

Do not swing the handset by its antenna, strap, etc.

May hit you or others around you, resulting in an accident such as bodily injury.



Don't

Do not use a damaged handset.

May cause fires, burns, bodily injury or electric shock.



Don't

For using a motion sensor and geomagnetic sensor, check the safety around, hold the handset and do not swing them more than necessary.

May cause injury etc.



Don't

If the display is broken and the liquid crystal then leaks, do not get the liquid on your skin (face, hands, etc.).

May result in loss of eyesight or harm to your skin. If the liquid comes into contact with your eyes or mouth, immediately rinse your eyes or mouth with clean water and see a doctor.

If the liquid comes into contact with your skin or clothes, immediately wipe it off with alcohol, and wash with water and soap.



Don't

The surface of the display is covered with a protective film for ensuring the security (shatterproof property of reinforced glass panel) against any damages caused by the handset being dropped or receiving a strong impact etc. Do not remove the film forcibly or damage it.

Using the handset with the film removed may cause bodily injury if the display gets damaged.



Don't

Do not dispose of the handset in ordinary garbage.

May cause fires or damage to the environment. Take the unnecessary handset to a sales outlet such as a docomo Shop or follow the instructions by a local institution that handles used handsets.



Instruction

If you use the handset in a vehicle, contact the vehicle manufacturer or dealer to check whether the operation of the vehicle is affected by signals.

May interfere with the operation of electronic equipment in some vehicle models. In this case, stop using the handset.



Instruction

Use of the handset may cause skin irritations such as itchiness, rashes or eczema in some people. If this occurs, immediately stop using the handset and seek medical treatment.

For details on materials of each part P. 7 "Material list"



Instruction

Look at the display in a well-lit place, keeping a certain distance from the screen.

Otherwise, eyesight may be weakened.



Instruction

If the battery fluid etc. leaks, do not get the liquid on your skin (face, hands, etc.).

May result in loss of eyesight or harm to your skin. If the liquid comes into contact with your eyes, mouth, skin or clothes, immediately rinse them with clean water. If the liquid etc. comes into contact with your eyes or mouth, see a doctor immediately after rinsing your eyes or mouth.

Handling adapters

Warning



Don't

Do not use if the cord of the adapter is damaged.

May cause fires, burns or electric shock.



Don't

Never use the AC adapter in humid locations such as a bathroom.

May cause fires, burns or electric shock.



Don't

The DC adapter should only be used in negative grounded vehicles. Never use it in positive grounded vehicles.

May cause fires, burns or electric shock.



Don't

Do not touch adapters if you hear thunder.

May cause electric shock.



Don't

Take care not to short-circuit the charger terminal when connected to an outlet or cigarette lighter socket. Also, take care not to allow any part of your body (hands, fingers, etc.) to come into contact with the charger terminal.

May cause fires, burns or electric shock.



Don't

Do not place heavy objects on the cord of the adapter.

May cause fires, burns or electric shock.



Don't

When plugging/unplugging an AC adapter into/from the outlet, do not allow metallic straps or other metallic objects to come into contact with the prongs of the plug.

May cause fires, burns or electric shock.



Don't

Do not apply excessive force on an adapter by moving it up/down or to the left/right with the adapter connected to the handset.

May cause fires, burns, bodily injury or electric shock.



Don't

Never try to connect the microUSB plug when the handset or AC adapter is wet.

Inserting the microUSB plug while the equipment is wet may cause short circuit when you charge the battery and lead to abnormal overheat, malfunction, fires or burns due to water, foreign objects, etc. adhering to the handset or microUSB plug though the handset provides waterproof performance.



No wet hands

Do not handle the cord or charger terminal of the adapters or outlet with wet hands.

May cause fires, burns or electric shock.



Always use the specified power supply and voltage.

Instruction

When using overseas, use the AC adapter that is available overseas.

Using the incorrect voltage may cause fires, burns or electric shock.

AC adapter: 100V AC

DC adapter: 12/24V DC (for negative grounded vehicles only)

AC adapter available overseas: 100 to 240V AC (Connect only with a household AC outlet)



If the fuse in the DC adapter blows, always replace it with a fuse of the specified type.

Instruction

May cause fires, burns or electric shock. Refer to the respective manuals for information on the correct fuse specifications.



Wipe off any dust on the power plug.

Instruction

May cause fires, burns or electric shock.



Fully plug the AC adapter into the outlet.

Instruction

May cause fires, burns or electric shock.



Always grasp the adapters when unplugging the power plug from the outlet or cigarette lighter socket. Do not forcibly pull by the cord of the adapter.

Instruction

May cause fires, burns or electric shock.



When plugging/unplugging an adapter into/from the handset, plug/unplug the adapter horizontally and straightly, not applying excessive force on it.

Instruction

May cause fires, burns, bodily injury or electric shock.



Unplug the power plug from the outlet or cigarette lighter socket when not using for a long time.

Unplug

May cause fires, burns or electric shock.



Should water or other liquids enter the equipment, remove the power plug from the outlet or cigarette lighter socket immediately.

Unplug

May cause fires, burns or electric shock.



Always unplug the power plug from the outlet or cigarette lighter socket before cleaning the equipment.

Unplug

May cause fires, burns or electric shock.

Handling docomo mini UIM card

Caution



Be careful with the cutting surface when removing the docomo mini UIM card.

Instruction

May cause bodily injury.

Handling near electronic medical equipment

Warning



If you have electronic medical equipment such as an implanted cardiac pacemaker or an implanted cardioverter-defibrillator, always carry or use your handset at least 15 cm away from your implant.

Instruction

Electromagnetic signals may have harmful effects on the operation of the electronic medical equipment.



Patients receiving medical treatment away from a hospital or medical facility (e.g. home treatment) who are using electronic medical equipment other than implanted cardiac pacemakers or implanted cardioverter-defibrillators should consult the respective manufacturers for information regarding the effects of signals on the equipment.

Instruction

Electromagnetic signals may have harmful effects on the operation of the electronic medical equipment.



If there is any chance that the distance between the handset and a person closest to you may get shorter than 15 cm such as when you cannot freely move around, set the handset not to emit radio wave in advance (by setting Airplane mode, turning the power off, etc.).

Instruction

Somebody nearby may be equipped with electronic medical equipment such as an implanted cardiac pacemaker or an implanted cardioverter-defibrillator. Electromagnetic signals may have harmful effects on the operation of the electronic medical equipment.



Follow the instructions given by the respective medical facilities regarding the use of the handset on their premises.

Instruction

Material list

Handset

Part	Material/Surface treatment
Display side	Reinforced glass/Shatterproof sheet of surface
Surrounding area of display side	PA resin/UV coating for surface
Back	PMMA + PC resin/Hard coating for surface
Surrounding area of back	PA resin/UV coating for surface
Sides	PC resin/UV coating for surface
Metal section of sides	SUS
Resin section of sides	PC resin/UV coating for surface
docomo mini UIM card slot	SUS/Ni plating
microSD Card slot	SUS/Ni plating
docomo mini UIM card/microSD Card slot cover	PC resin/UV coating for surface
Gasket of docomo mini UIM card/microSD Card slot cover	Silicon rubber
IMEI plate	PP resin
Surrounding area of earphone/microphone terminal	PC resin/UV coating for surface
Power key	PC resin/UV coating for surface
Side key	PC resin/UV coating for surface
Camera panel	Reinforced glass/Printing on the back
Decoration of camera	SUS
Mobile light	PC resin
Metal section of Mobacas/TV antenna	SUS/NiTi

Part	Material/Surface treatment
Mobacas/TV antenna	PA resin/UV coating for surface
External connector terminal	SUS/Sn plating, Copper alloy/ Gold plating

Handling precautions

General notes

- **SH-04F is waterproof, however, do not allow water to get inside the handset and do not allow optional parts to get wet.**
The adapter and docomo mini UIM card are not waterproof. Do not use in humid or steamy areas such as bathrooms and avoid exposing to rain and other forms of moisture. If they are carried close to the skin, perspiration may cause internal components to corrode and result in malfunction. Note that if a problem is found to be due to moisture, the handset and parts are not covered by warranty and in some cases may be irreparable. Even when repairs are possible, repair charges will be incurred, since the damage is not covered by warranty.
- **Clean only with a soft and dry cloth (such as the type used for eyeglasses).**
 - Forceful rubbing of the LCD with a dry cloth may scratch its surface.
 - Note also that LCD coating may stain if moisture or soiling is left on the surface for a long period.
 - Never use chemicals such as alcohol, thinners, benzene or detergents, as these agents may erase the printing or cause discoloration.
- **Occasionally clean terminals with a dry cotton swab etc.**
Dirty terminals may result in poor connections and loss of power or insufficient battery charge. Keep the terminals clean with a dry cotton swab etc.
Be careful with the terminals while cleaning them.
- **Do not place the equipment near an air conditioning vent.**
Condensation formed due to rapid changes in temperature may cause internal corrosion and lead to a malfunction.
- **Do not apply excessive force on the handset etc. when using it.**
Carrying the handset in a tightly packed bag or sitting on the handset in your pocket may cause damage to the display, internal components, etc. or result in a malfunction.
Keeping an external connector device plugged into the external connector terminal or earphone/microphone terminal may cause damage to the connector or result in a malfunction.
- **Do not rub or scratch the display with metal etc.**
May scratch it and cause malfunction or damage.
- **Read the respective manuals or user's guides supplied with the optional parts carefully.**

Notes about the handset

- **Do not forcefully press the surface of the touch panel or operate with a pointed object such as a fingernail, ballpoint pen or pin.**
May damage the touch panel.
- **Avoid using the handset in extremely high or low temperatures.**
Use the handset within the range of a temperature between 5°C and 35°C and a humidity between 45% and 85%.
- **Using the handset close to land-line phones, TVs, radios, etc. may have harmful effects on the operation of such equipment. Move as far away as possible from such items before use.**
- **Keep a separate memo noting information stored on the handset.**
DOCOMO shall not be liable for any loss of content.

- **Do not drop or otherwise subject the handset to severe impact.**
May damage the handset or cause a malfunction.
- **When connecting an external connector device to the external connector terminal or earphone/microphone terminal, do not put it in obliquely and do not pull it while it is plugged in.**
May damage the handset or cause a malfunction.
- **The handset becomes warm during use or charging but this is not a malfunction.**
- **Do not leave the camera in direct sunlight.**
May cause discoloration or burn-in of pixels.
- **Use the handset with the docomo mini UIM card/microSD Card slot cover closed.**
Dust, water, etc. may get inside and cause a malfunction.
- **While using a microSD Card, do not remove the card or turn off the handset.**
May cause data loss or a malfunction.
- **Never place a magnetic card near the handset.**
The stored magnetic data in cash cards, credit cards, telephone cards, floppy disks, etc. may be erased.
- **Never place magnetized items near the handset.**
Putting highly magnetized items closer may cause an error.
- **The handset has a function to judge whether a proper internal battery is used. Do not replace the internal battery by yourself.**
- **When an improper internal battery is used, you cannot charge the battery.**
- **DOCOMO shall not be liable for any accident or malfunction arising from using an improper internal battery.**
- **The internal battery is a consumable product.**
Though the battery life varies with use, change the battery if the battery life is extremely short even after being fully charged. For details on replacing the internal battery, contact the number listed in "Repairs" (in Japanese only) on the last page or a repair counter that DOCOMO specifies.
- **Charge battery in areas where ambient temperature is between 5°C and 35°C.**
- **The battery life depends on the usage and deterioration of the battery.**
- **Avoid the following situations when the handset is stored.**
 - Storage with the internal battery fully charged (immediately after charging is completed)
 - Storage with no battery level (cannot turn the main body on)
May lower the performance or shorten the usable life of the internal battery.
Approximately 40% is recommended as the proper battery level for storage.

Notes about adapters

- **Charge the battery in areas where the ambient temperature is between 5°C and 35°C.**
- **Do not charge the internal battery in the following locations.**
 - Areas with high humidity or dust, or in areas exposed to frequent vibrations
 - Close to land-line phones, TVs, radios, etc.
- **Adapters may become warm during charging but this is not a malfunction.**
- **Do not use the DC adapter to charge the battery when the car engine is not running.**
May cause the car battery to run down.
- **When using an outlet with a feature to prevent the plug from being removed accidentally, follow the instructions in the outlet user's guide.**
- **Do not subject to strong force or impacts. Also, do not deform the charger terminals.**
May cause a malfunction.

Notes about docomo mini UIM card

- Do not apply unnecessary force when inserting/removing the docomo mini UIM card.
- Customer is responsible for malfunctions arising from inserting docomo mini UIM card into a different IC card reader/writer etc.
- Always keep IC area clean.
- Clean only with a soft and dry cloth (such as the type used for eyeglasses).
- Keep a separate memo and note information stored on the docomo mini UIM card.
DOCOMO shall not be liable for any loss of content.
- To protect the environment, please take any unneeded docomo mini UIM cards to a sales outlet such as a docomo Shop.
- Do not damage, touch haphazardly or short-circuit the IC.
May cause data loss or a malfunction.
- Do not drop or otherwise subject the docomo mini UIM card to severe impact.
May cause a malfunction.
- Never bend the docomo mini UIM card or place heavy objects on it.
May cause a malfunction.
- Do not insert the docomo mini UIM card to the handset with a label or sticker attached on the card.
May cause a malfunction.

Notes on using Bluetooth function

- The handset supports the security function that meets the Bluetooth specification for security during communication using Bluetooth functions. However, the security may not be sufficient depending on the configuration etc. Take care of the security while making communication using Bluetooth function.
- Even if any leak of data or information occurs while making communication using Bluetooth function, DOCOMO shall not be liable for any loss of content.
- Radio frequencies
In the home screen, [] ▶ [Settings] ▶ [Device info] ▶ [Authentication] to confirm the radio frequencies the Bluetooth function of the handset uses. The followings are the descriptions:



- ① 2.4: This radio equipment uses the 2400 MHz band.
 - ② FH: The modulation system is the FH-SS system.
 - ③ 1: The estimated coverage distance is 10 m or less.
 - ④ XX: Another modulation system is used.
 - ⑤ 4: The estimated coverage distance is 40 m or less.
 - ⑥ ■■■■■: All radio frequencies between 2400 MHz and 2483.5 MHz are used and the frequencies for mobile object identifiers cannot be avoided.
- Cautions on using Bluetooth devices
Bluetooth operates at radio frequencies assigned to the in-house radio stations for a mobile object identifier that have to be licensed and is used in production lines of a factory, specific unlicensed low power radio stations, and amateur radio stations (hereafter, referred to as “another radio station”) in addition to industrial, scientific and medical devices or home electric appliances such as microwave ovens.
1. Before using the handset, make sure that “another radio station” is not operating nearby.

2. If radio interference between the handset and “another radio station” occurs, avoid interference by moving immediately to another place or “turning off the power”.
3. Contact the number listed in “General Inquiries” on the last page for further details.

Notes about wireless LAN (WLAN)

- Wireless LAN (WLAN) uses radio waves to communicate information. Therefore, it has an advantage of freely connecting to the LAN within the service area. On the other hand, if security setting is not set, it is possible for a malicious third party to intercept the communication contents or hack. It is recommended to set security setting at your own risk and judgement.
- Wireless LAN
Do not use wireless LAN near magnetic devices such as electric appliances or AV/OA devices or in radio waves.
 - Magnetism or radio waves may increase noises or disable communications (especially when using a microwave oven).
 - When used near TV, radio, etc., reception interference may occur or channels on the TV screen may be disturbed.
 - If there are multiple wireless LAN access points nearby and the same channel is used, search may not work correctly.
- Radio frequencies
In the home screen, [] ▶ [Settings] ▶ [Device info] ▶ [Authentication] to confirm the radio frequencies the WLAN-installed devices use. The followings are the descriptions:

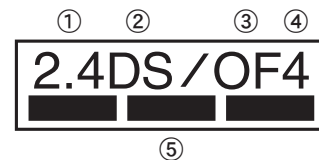

- ① 2.4: This radio equipment uses the 2400 MHz band.
 - ② DS: The modulation system is the DS-SS system.
 - ③ OF: The modulation system is the OFDM system.
 - ④ 4: The estimated coverage distance is 40 m or less.
 - ⑤ ■■■■■: All radio frequencies between 2400 MHz and 2483.5 MHz are used and the frequencies for mobile object identifiers can be avoided.
- Available channels for the handset's wireless LAN are between 1 and 13. Note that other channel access points cannot be connected. Available channels may vary depending on the country. For use in an aircraft, contact the airline beforehand.
- Cautions on using 2.4 GHz devices
WLAN-installed devices operate at radio frequencies assigned to the in-house radio stations for a mobile object identifier (radio stations requiring a license) used in production lines of a factory, specific unlicensed low power radio stations (radio stations requiring no license), and amateur radio stations (radio stations requiring a license) in addition to industrial, scientific and medical devices or home electric appliances such as microwave ovens.
1. Before using this device, make sure that the in-house radio stations for a mobile object identifier, specific unlicensed low power radio stations and amateur radio stations are not operating nearby.
 2. If the device causes harmful radio interference to the in-house radio stations for a mobile object identifier, immediately change the radio frequency or stop use, and contact the number listed in “General Inquiries” on the last page for crosstalk avoidance, etc. (e.g. partition setup)
 3. If the device causes radio interference to specific unlicensed low power radio stations for a mobile object identifier or amateur radio stations, contact the number listed in “General Inquiries” on the last page for further details.

- **Cautions on using 5 GHz devices**
In the 5 GHz frequency band, three bands of 5.2 GHz/5.3 GHz/5.6 GHz band (W52/W53/W56) are available.
 - W52 (5.2 GHz band/36, 40, 44, 48 ch)
 - W53 (5.3 GHz band/52, 56, 60, 64 ch)
 - W56 (5.6 GHz band/100, 104, 108, 112, 116, 120, 124, 128, 132, 136, 140 ch)
 Using 5.2 GHz/5.3 GHz band wireless LAN (W52/W53) outdoors is prohibited by the Radio Law.

FeliCa and NFC reader/writer

- **The FeliCa and NFC reader/writer, P2P function of the handset uses weak radio waves whose handling does not require a license of radio station.**
- **The frequency in use is the 13.56 MHz band. When another reader/writer, P2P function is being used nearby, keep enough distance from it. Make sure that there is no radio station using the same frequency band in the nearby area.**
- **For use in an aircraft, contact the airline beforehand. Use of FeliCa and NFC reader/writer, P2P function may be restricted in some countries. Check conditions such as regulations of the country/region to use the function.**

Caution

- **Never use the handset that is modified. Using a modified device violates the Radio Law and/or the Telecommunications Business Law.**
The handset follows the regulations regarding the certification of conformity with technical regulations for the specified radio station based on the Radio Law and authentication of conformity with technical regulations for the handset based on the Telecommunications Business Law, and the "Technical Conformity Mark" can be displayed on the electronic nameplate of the handset as a proof. You can see it by operating as follows.
In the home screen, [Settings] ▶ [Device info] ▶ [Authentication] If the screws of the handset are removed and a modification is given to the inside, the certification of conformity with technical regulations etc. will become invalid. Never use the handset without the valid certification etc. Doing so violates the Radio Law and/or the Telecommunications Business Law.
- **Be careful when using the handset while driving a motor vehicle.**
Using a mobile phone in hand while driving is regarded as a punishable act.
However, the punishment has no application in some cases such as when rescuing sick and injured people or maintaining public safety.
- **Use the FeliCa reader/writer function only in Japan.**
The FeliCa reader/writer function of the handset conforms to the domestic radio wave standards. Using the function overseas may result in punishment.
- **Never change the basic software improperly.**
This may be regarded as a conversion of software and repairs may be refused.

Waterproof

SH-04F is waterproof to IPX5*1 and IPX7*2 standards if the docomo mini UIM card/microSD Card slot cover is securely closed.

*1 IPX5 means that phone keeps functioning after being subjected to a jet flow (approximately 12.5 liters/min) discharged from a nozzle (inner diameter: 6.3 mm), from all directions (approximately 3 m from the handset) for 3 minutes or more.

*2 IPX7 means that SH-04F phone keeps functioning after it is slowly submerged to depth of 1 m in static tap water at room temperature, left there for approximately 30 minutes and then taken out.

What you can do with waterproof of SH-04F

- You can call without using an umbrella in the rain (for rainfall of approximately 20 mm per hour).
- You can rinse off dirt from the handset. Wash the handset with low-pressure water flow (6 liters/min or lower and tap water at room temperature (between 5°C and 35°C)), holding it approximately 10 cm below faucet or shower head. Wash by using only your hands, not a brush or sponge, with the docomo mini UIM card/microSD Card slot cover held in position. Drain the handset before use (P. 11 "Draining water when the handset gets wet").
- You can use the handset at a poolside. Do not throw water in a swimming pool on the handset or soak the handset in the water of a swimming pool.

Things to keep in mind

To maintain waterproof performance, check the followings.

- Securely close the docomo mini UIM card/microSD Card slot cover. Be careful not to apply excessive force on the rubber gasket when opening and closing.
- Make sure that the docomo mini UIM card/microSD Card slot cover is completely closed without floating.
- To maintain waterproof performance, the handset has the docomo mini UIM card/microSD Card slot cover that allows you to close securely. May cause injuries to your nails or fingers if you try to open it forcibly.
- For details on how to open/close the docomo mini UIM card/microSD Card slot cover (P. 13 "Inserting docomo mini UIM card")

- To maintain waterproof performance, replacement of parts is recommended every 2 years regardless of whether the handset appears normal or abnormal. DOCOMO replaces the parts as a chargeable service. Bring the handset to a repair counter that DOCOMO specifies.

Precautions

- When your hands or the handset is wet, do not open/close the docomo mini UIM card/microSD Card slot cover.
- Close the docomo mini UIM card/microSD Card slot cover securely. Even a fine obstacle (one hair, one grain of sand, tiny fiber, etc.) put between contact surfaces may allow water to get inside.
- If the handset gets wet with water or other liquids with the docomo mini UIM card/microSD Card slot cover opened, the liquid may get inside causing electric shocks or malfunction. Stop using the handset, turn off the power and contact a repair counter that DOCOMO specifies.
- The rubber gasket of the contact surface between the main body and docomo mini UIM card/microSD Card slot cover plays an important role in maintaining waterproof performance. Do not remove or scratch it. Also, prevent dust from adhering to it. If the rubber gasket is damaged or deformed, replace it at a repair counter that DOCOMO specifies.
- Do not insert a pointed object through the docomo mini UIM card/microSD Card slot cover gaps. It may cause damage to the rubber gasket and allow water to get inside.
- Do not use the handset underwater (including key operations). May cause malfunction.
- Do not apply water flow stronger than allowed (over 6 liters/min). May cause malfunction though SH-04F provides waterproof performance of IPX5.

Before Using the Handset

Part names and functions

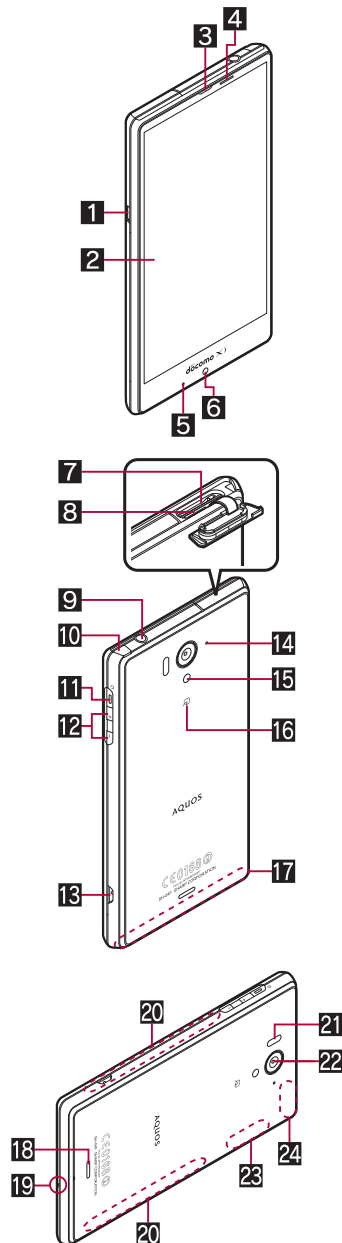

- 1 External connector terminal**
- 2 Display/Touch panel**
- 3 Earpiece**
- 4 Proximity sensor/Brightness sensor*1**
 - The proximity sensor detects the distance to the face and prevents inadvertent operation of touch panel during a call.
 - The brightness sensor detects the brightness of the surrounding area and adjusts the brightness of the backlight.
- 5 Incoming/Charging lamp**
- 6 In-camera**
- 7 microSD Card slot**
- 8 docomo mini UIM card slot**
- 9 Earphone/Microphone terminal**
- 10 Mobacas/TV antenna**
- 11 : Power key**
 - Use to turn the power on/off, etc.
 - Use to turn the display on/off.
- 12 : Volume UP/DOWN key**
 - Adjusts the volume in each function.
- 13 Strap hole**

- 14 Out-microphone**
 - Use as a sub microphone when recording videos.
 - Use to measure ambient noises for communicating by making your voices sound clear when using Noise suppression.
- 15 Mobile light**
- 16 mark**
 - IC card is contained (It cannot be removed).
- 17 FOMA/Xi antenna*2**
- 18 Speaker**
 - Ringtone, music, etc. can be heard from here.
 - The other party's voice can be heard from here during a hands-free call.
- 19 Mouthpiece/Microphone**
- 20 Grip sensor**
 - The metal section on both sides is the sensor.
- 21 Infrared port**
- 22 Out-camera**
- 23 Wi-Fi/Bluetooth antenna*2**
- 24 GPS antenna*2, FOMA/Xi sub antenna*2**

- *1 Do not cover the sensor area with your hand or paste a sticker etc. on the sensor area. The sensor may not work properly.
- *2 The antenna is built into the main body. Covering the antenna area with your hand may influence the quality.

Earphone/Microphone terminal

- For details on the corresponding earphone/microphone, refer to the following website.
http://k-tai.sharp.co.jp/support/d/sh-04f/peripherals.html#!/earphone_support (in Japanese only)

Out-microphone

- When using functions which support the out-microphone, do not cover the hole of the out-microphone.

docomo mini UIM card

A docomo mini UIM card is an IC card that records personal information, such as phone numbers.

- You cannot use functions such as the phone or packet communication without inserting a docomo mini UIM card.
- You cannot use the docomo mini UIM card with devices other than compatible ones and may not be able to use a part of the website and data when you change from the UIM.
- In Japan, you cannot call to the emergency number (110, 119 or 118) without inserting a docomo mini UIM card.
- A docomo mini UIM card has a security code called PIN code (P. 70 "PIN code").
- The handset supports only docomo mini UIM card. Change the UIM at a docomo Shop.
- Before inserting or removing the docomo mini UIM card, turn off the power. Hold the handset securely with your hand.

Inserting docomo mini UIM card

1 Open the docomo mini UIM card/microSD Card slot cover

- Hook the tip of a finger into the slot to open.

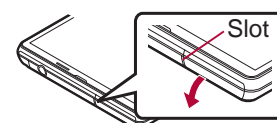

2 Hold the docomo mini UIM card with the IC (gold) side turned up and insert it slowly into the docomo mini UIM card slot

- Push it slowly towards inside until a click is heard.

■ Estimated battery life when fully charged

Continuous talk time	FOMA/3G Approx. \$\$ min GSM Approx. \$\$ min
Continuous stand-by time	FOMA/3G At rest: Approx. \$\$ hr (Preferred network type: LTE/3G/GSM (Auto)) GSM At rest: Approx. \$\$ hr (Preferred network type: LTE/3G/GSM (Auto)) LTE At rest: Approx. \$\$ hr (Preferred network type: LTE/3G/GSM (Auto))
Mobacas watching time	Approx. \$\$ min
TV watching time	Full-Seg: Approx. \$\$ min 1Seg: Approx. \$\$ min

- For details on the battery life see P. 92 "Main specifications"

■ Internal battery usable life

- Internal battery is a consumable product. Battery life per charge is gradually reduced every time the battery is charged.
- When battery life per charge is reduced to about half of the default time, this means that the internal battery is approaching the end of its usable life. In this case, it is recommended to replace the battery as soon as possible. For details on replacing the internal battery, contact the number listed in "Repairs" (in Japanese only) on the last page or a repair counter that DOCOMO specifies.
- If you watch TV etc. while charging for a long time, the usable life of the internal battery may become shorter than estimated.



■ AC adapter and DC adapter

- Refer to user's guide of AC Adapter 03/04 (sold separately) or DC Adapter 03/04 (sold separately).
- AC Adapter 03/04 covers from 100 to 240V AC.
- The shape of the plug for the AC adapter is for 100V AC (for domestic use). To use the AC adapter of 100 to 240V AC overseas, a conversion plug adapter applicable to your country of stay is required. Do not use a voltage converter for overseas travel to charge the battery.

Charging with AC adapter/DC adapter

[Read the user's guides of AC Adapter 03/04 (sold separately) and DC Adapter 03/04 (sold separately)]

- Following operations describe how to charge with AC Adapter 04 or DC Adapter 04.

1 Insert the microUSB plug of the AC adapter/DC adapter horizontally into the external connector terminal on the handset with the side marked with "B" turned down

- Check the direction (front or rear) of the microUSB plug and insert it horizontally.

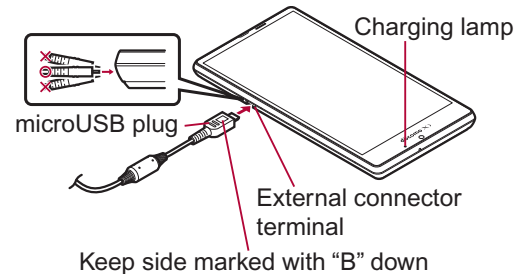

2 When you erect the AC adapter power plug and insert it into an outlet or insert the DC adapter power plug into a car cigarette lighter socket, the charging lamp illuminates and charging starts

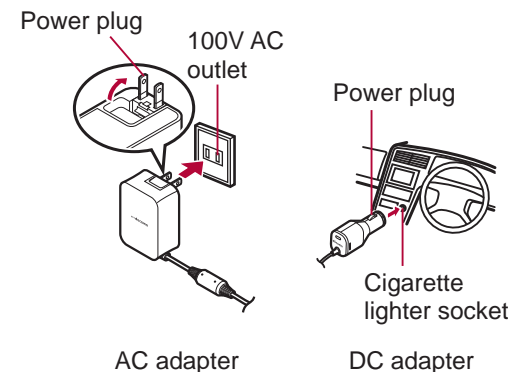

3 When charging is complete, the charging lamp turns off

4 Remove the AC adapter power plug from the outlet, or remove the DC adapter power plug from the car cigarette lighter socket

5 Remove the microUSB plug of the AC adapter/DC adapter horizontally from the external connector terminal

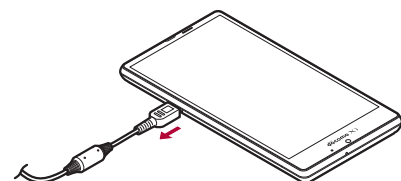

- Using unnecessary force when inserting or removing the equipment may cause damage to the external connector terminal and the microUSB plug or result in a malfunction.

When using a DC adapter

- The DC adapter should only be used in negative grounded vehicles (12 and 24V DC).

- Do not use with the car engine shut off. May drain the car battery.
- The DC adapter fuse is a consumable product. For replacement, purchase a new fuse at a nearest auto parts retailer etc.
- Refer to the user's guide of DC Adapter 03/04 for details.

Charging with Micro USB Cable 01

You can charge the handset by connecting the handset to a PC with Micro USB Cable 01 (sold separately).

- For details on connecting to a PC (P. 80 "Connecting the handset and PC")

Turning power on/off

Turning power on

1 (for at least 2 seconds)

- When you turn the power on for the first time, make the initial settings (P. 22 "Initial setting").

- Precautions about inserting and removing a microSD Card are displayed every time the handset power is turned on.

Turning power off

1 (for at least 1 second) ▶ [Power off completely] ▶ [OK]

Turning power off forcibly

You can forcibly turn the power off if the screen does not respond or the power cannot be turned off.

1 (for at least 8 seconds)

- Release your finger after the vibrator is activated to turn the power off.

Sleep mode

You can quickly activate the handset when turning the power on again by setting the sleep mode.

1 (for at least 1 second) ▶ [To sleep] ▶ [OK]

- Do not set the sleep mode but turn the power off when an airplane you are aboard is about to take off/land, the battery level is low, etc.
- Even if you set the sleep mode, the handset may not be quickly activated depending on its status such as when it has not been used for a long time.

Turning display on/off

The display is turned off when (power key) is pressed or the handset is not in use for a set length of time.

Press (power key) while the display is turned off to turn it on.

Touch panel lock

When the power or the display is turned on, the touch panel is locked.

Touch (power key) to unlock.

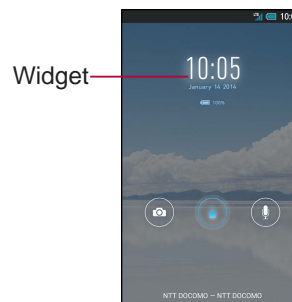

Operations in touch panel lock screen

- To set/disable the manner mode: (manner mode icon) (for at least 1 second)
- To turn on/off the mobile light: (mobile light icon) (for at least 1 second)
- To activate Camera/SH Camera: (camera icon) ▶ select an app ▶ select an activation method
- To activate シャベってコンシェル (Shabette-Concier)/Google: (voice search icon) ▶ select an app ▶ select an activation method
- To add a widget: Slide the left edge of the screen to the right ▶ touch and hold a widget ▶ drag it to the destination
- To move a widget: Slide the left edge of the screen to the right ▶ touch and hold a widget ▶ drag it to the destination
- To delete a widget: Slide the left edge of the screen to the right ▶ touch and hold a widget ▶ drag it to [Remove]

- The status panel can be displayed when Screen lock is set to [Slide or Touch].

Adding widgets

- Enable [Enable widgets] in advance (P. 68 "Lock & security").
- Unlock the touch panel after you touch [+] when Screen lock is set to an item other than [Slide or Touch].

Basic operation

Operation of touch panel

The followings describe the operations to use the display (touch panel).

- Operations may differ depending on the function and screen in use.

Cautions when using the touch panel

- The touch panel is designed to be lightly touched with your finger. Do not forcefully press with your finger or a pointed object (fingernail, ballpoint pen, pin, etc.).
- In the following cases, the touch panel may not work even if you touch it. May cause a malfunction.
 - Operation with a gloved finger
 - Operation with the tip of a fingernail
 - Operation with foreign objects placed on the operation pad
 - Operation on the touch panel on which a protective sheet or a sticker is put
 - Operation while the touch panel is wet
 - Operation with fingers wet with sweat or water

- Operations may be interrupted if you touch an area other than a confirmation screen or the status bar while the confirmation screen etc. is displayed.

■ Touch

Touch a key or an item displayed on the screen and then release your finger from it to select or set it.



■ Touch and hold

When you keep your finger on the touch panel, a menu may appear depending on the function and screen in use.

■ Slide/Drag

Move your finger while keeping it on the touch panel to scroll the screen or move an icon, widget, etc. to the desired position. In addition, when you touch a menu or item by mistake, move your finger away from it to cancel the selection.



■ Flick

Move your finger like sweeping the touch panel in the home screen etc. to switch pages.



■ Pinch out/Pinch in

You may be able to zoom the screen in/out etc. by putting two fingers on the touch panel and moving them with putting a distance between two fingers apart (pinch out)/closer (pinch in) depending on the function and screen in use.

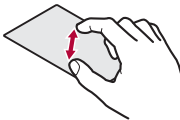

Operation while using function

■ Navigation keys

Use the navigation keys displayed at the bottom of the screen to perform the basic operations.



1 [Back]/[Close]: Back key/Close key

- Return to the previous screen.
- Close the keyboard.

2 [Home]: Home key

- Display the home screen.

3 [Menu]: Menu key

- Display available functions (menus).

4 [Recent Apps]: Recent Apps key

- Display Quick Launcher or Recent Apps (☞ P. 27 “Quick Launcher”, P. 28 “Recent Apps”).

■ Using user-aid function

You can quickly activate apps supporting the user-aid function.

1 Slide any of the navigation keys up ▶ slide it to [Search]

- If you have set the activation method of an app to [Always], the app is activated.

2 Select an app ▶ select an activation method

■ One hand operation mode

You can reduce the screen to operate the handset with one hand.

1 Slide any of the navigation keys up ▶ slide it to [Shrink]/[Expand]

- Repeat the same operation as that done when reducing the screen to return it to the original size.

- You may not be able to reduce the screen depending on the screen being displayed.

■ Retrieving menu

When you touch [Menu] or touch and hold the screen, functions (menus) available in that screen appear.

Example: Home screen

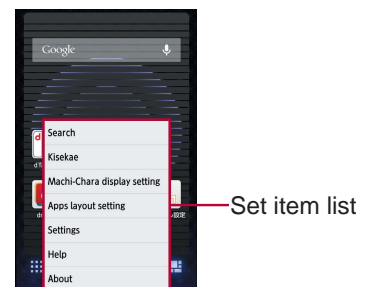

- If the settings of MCC and MNC are changed and the added access point disappears from the screen, reset the settings or set the access point manually.

Resetting an access point

Reset an access point to default setting.

- 1 In the home screen, [Settings] ▶ [More...] ▶ [Mobile networks] ▶ [Access Point Names] ▶ [Reset to default]

- When sp-mode is not subscribed or if you fail to make automatic setting of an access point due to signal status such as outside the service area, you are required to set the access point again manually.

sp-mode

sp-mode is an ISP owned by NTT DOCOMO for smartphones. In addition to the Internet connection, mail service with the same address you use on i-mode (@docomo.ne.jp) or other services are available. sp-mode is a paid service that requires subscription. For details on sp-mode, refer to the DOCOMO website.

Wi-Fi settings

If you use Wi-Fi function of the handset, you can use mail or Internet by connecting to access points of your home, corporate network or public wireless LAN service.

Radio interference with Bluetooth devices

- Wireless LANs (IEEE 802.11b/g/n) use the same frequency band (2.4 GHz) as Bluetooth devices. Therefore, using the wireless LAN device near a Bluetooth device may cause radio interference, lowering of communication speed, noise or connection failure. In this case, turn off the Bluetooth device or keep the handset and the wireless LAN device at least approximately 10 m away from the Bluetooth device.

- Packet communication is also available while Wi-Fi is set to [ON]. Wi-Fi connection is prioritized while Wi-Fi connection is set, but the connection is automatically switched to that of LTE/3G/GPRS network once Wi-Fi connection is terminated. Note that packet communication charges may be incurred in this case.
- Refer to the manual of your wireless LAN base unit when using the access point at home etc.
- Operate access point registration near the access point.
- If you use the docomo service/docomo cloud by using Wi-Fi function, set a docomo ID in advance. In the home screen, [Settings] ▶ [docomo service/cloud] ▶ [docomo ID設定] (Set docomo ID) to set it.

- 1 In the home screen, [Settings] ▶ [Wi-Fi]

- 2 Slide [OFF] to the right

- 3 Select an access point

- If you select an access point protected by security, enter the password (security key) and select [Connect].
- To register access points manually: [ADD NETWORK] ▶ enter the network SSID ▶ set security ▶ [Save]
- WPS compatible access points can be easily registered. In the home screen, [Settings] ▶ [Wi-Fi] ▶ [EASY SETTINGS] ▶ [WPS Push Button]/[WPS Pin Entry] to register an access point.

- Alternatively, in the home screen, [Settings] ▶ [Wi-Fi] ▶ [EASY SETTINGS] ▶ [AOSS] to connect to an access point. Follow the instructions on the screen and operate after this step.

- When you select an access point and connect to it with a wrong password (security key), [Avoided poor Internet connection], [Authentication problem] or [Connected (Limited)] is displayed. Confirm the password (security key). When [Avoided poor Internet connection] or [Connected (Limited)] is displayed after entering the correct password (security key), you may not have acquired the correct IP address. Connect to the access point again after confirming signal status.
- The registration process using WPS takes a few minutes. After completion of the registration of the access point, check that the proper connection to the access point is acquired.
- As for the manual registration of an access point, this function supports WEP, WPA/WPA2 PSK and 802.1x/EAP as the security setting.

Detailed settings

- 1 In the home screen, [Settings] ▶ [Wi-Fi] ▶ [Advanced]

- 2 Select an item

- **Network notification:** Set whether to display a notification icon when an open network is detected.
 - Set it after setting Wi-Fi to [ON].
- **Wi-Fi sleep policy:** Set when to switch the Wi-Fi function to the sleep mode.
- **Scanning always available:** Set whether to scan networks by the location information service and other apps even when Wi-Fi is set to [OFF].
- **Avoid poor connections:** Set whether to use the Wi-Fi function only when stable Internet connections are available.
- **Wi-Fi frequency band:** Set the frequency band to use.
- **Install certificates:** Install certificates.
- **MAC address:** Confirm the MAC address.
- **IP address:** Confirm the IP address.

Disconnecting

- 1 In the home screen, [Settings] ▶ [Wi-Fi]

- 2 Select the connected access point ▶ [Forget]

- Disconnect with the password retained.

Tethering

You can use the tethering function that connects a PC connected via Micro USB Cable 01 (sold separately), Wi-Fi compatible devices or a Bluetooth device to the Internet by using the handset as an access point.

- You can connect up to 12 devices in total at the same time: a PC connected via Micro USB Cable 01, ten Wi-Fi compatible devices and a Bluetooth device.

- 1 In the home screen, [Settings] ▶ [More...] ▶ [Tethering]

- 2 Select an item

- **USB tethering:** Set whether to use the USB tethering.
 - Check the details of the precautions before use.
- **Wi-Fi tethering:** Set whether to use the Wi-Fi tethering.
 - Check the details of the precautions before use.
- **Set up Wi-Fi hotspot:** Make settings for Wi-Fi tethering such as network SSID and security.

Making a call

1 In the home screen, [Phone] ▶ [Dial]

2 Enter a phone number

- Always enter the city code, even when it is a local number.
- You can set to notify/not to notify the other party of your phone number for each call by adding “186”/“184” to the head of the phone number.

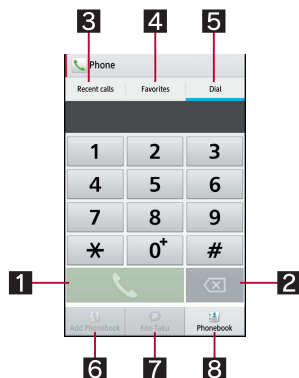

1 Call

- Make a call. Also, if there are outgoing call history items, touch to enter the latest one when the phone number has not been entered.

2 Menu

- Display available functions (menus).

3 Favorites

- Display the contacts set as favorites.

4 Delete

- Delete an entered number.
- Touch and hold it to delete all the entered numbers.

5 Register

6 Dial

- Display the dial screen.

7 Outgoing/Incoming call history

8 Phonebook

- Display the phonebook.

3 [Phone]

4 [End call] to end the call

• If you talk on the handset with your hair put between the earpiece and your ear, the proximity sensor may not work properly. The screen may be kept turned on and the call may be interrupted when the screen is touched accidentally.

Entering touch-tone signals

When using services in which you are required to enter numbers additionally during a call, such as inquiry about the balance in your bank account or ticket reservation, enter pause (,) / wait (;) after entering a phone number to make a call with an additional number added to the main phone number.

■ Adding 2 seconds pause

After making a call to a main phone number, the handset automatically pauses for 2 seconds and an additional number is sent.

1 In the home screen, [Phone] ▶ [Dial]

2 Enter a phone number ▶ [Menu] ▶ [Add 2-sec pause]

3 Enter a number to send ▶ [Phone]

■ Adding wait

After making a call to a main phone number, the handset automatically waits and then a screen asking whether to send an additional number is displayed. Touch [Yes] to send an additional number.

1 In the home screen, [Phone] ▶ [Dial]

2 Enter a phone number ▶ [Menu] ▶ [Add wait]

3 Enter a number to send ▶ [Phone]

4 [Yes] during the call

Emergency call

Emergency calls	Phone number
Police	110
Fire and ambulance	119
Marine emergency	118

- The handset supports “Emergency call location notification”. When you make a call to an emergency number such as 110, 119 and 118, the information of your location (location information) is automatically notified to the agency that has received the emergency call (e.g. the police station). Depending on your location and the reception status of the signal, the agency that has received the emergency call may not be able to confirm the exact location. If you are not sending your caller ID by calling with “184” added or other means, your location information and phone number are not notified. However, if the agency that has received the emergency call considers your location information and phone number necessary for important purposes, such as life saving, the agency may retrieve them regardless of your settings. In addition, the area/timing to introduce “Emergency call location notification” depends on the state of preparation in each agency that receives emergency calls.
- In Japan, you cannot make a call to the emergency number (110, 119 or 118) when a docomo mini UIM card is not inserted, while the PIN code is locked, from the PUK (PIN Unlock Key) entry screen or from the password entry screen for decrypting the storage.
- When calling 110, 119 and 118 from your handset, the police or fire stations may return your call for verification purposes. State that you are calling from a mobile phone, and give your phone number and exact present location. Remain stationary to ensure that the call is not disconnected while you are on the line, and keep the handset turned on to receive calls for approximately 10 minutes afterwards.
- Depending on the region, calls to the police or fire station of the local area may not be made.
- When you make a call to the emergency number (110, 119 or 118) while Reject call setting is set, items of Reject call setting are set to [OFF].

International call (WORLD CALL)

WORLD CALL is an international calling service available from DOCOMO devices in Japan.

- Contact the number listed in “General Inquiries” on the last page for details on WORLD CALL.
- To make an international call through a company other than DOCOMO, contact the respective companies for instructions.
- The caller ID may not be notified or displayed correctly depending on overseas network operators. In this case, making a call with incoming call history is not available.

[Calling Method]

- When calling to a land-line phone: 010 ▶ country code ▶ area code (city code) ▶ the other party's phone number ▶ [📞]
- When calling to a mobile phone: 010 ▶ country code ▶ the other party's mobile phone number ▶ [📞]
- As for the other parties' mobile phone numbers and area codes (city codes) that begin with "0", omit the first "0" when entering (except some countries or regions such as Italy).
- Alternatively, enter "009130-010" as usual or "+" instead of "010".

Receiving a call

1 When a call is received, the ringtone sounds and the incoming lamp flashes

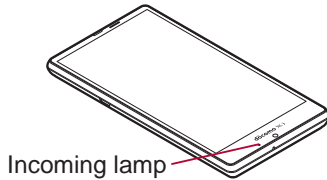

2 Receive the call

- Operate after touching [📞].

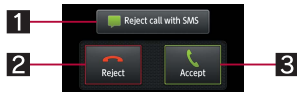

1 Reject call with SMS

- You can reject the incoming call and send a selected SMS message to the other party.

2 Reject

- You can reject the incoming call.

3 Accept

- You can answer the call.

3 [End call] to end the call

■ Placing a call on hold

1 When a call is received, the ringtone sounds and the incoming lamp flashes

2 [📞] ▶ [On hold]

■ Answering by answering memo

1 When a call is received, the ringtone sounds and the incoming lamp flashes

2 [📞] ▶ [Absence Memo]

Playing an answering memo

1 In the home screen, [📞] ▶ [📞] ▶ [Call settings]

2 [Call/Ans Memo] ▶ [Answering Memo List] ▶ select an answering memo

Operation during a call

You can carry out operations such as using a hands-free call and adjusting the in-call volume according to the usage condition during a call.

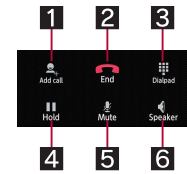

1 End

- End a call.

2 Dialpad

- You can enter touch-tone signals.

3 Mute

- Enable or disable mute setting on a current call.

4 Speaker

- You can talk with hands-free.
- When a Bluetooth device is connected, you can switch sound emitting parts.

5 Hold

- Hold/Unhold a current call.

- Note the followings to use hands-free.

- Speak approximately 20 to 40 cm away from the mouthpiece. When the surroundings are noisy, the sound may break up and the call may not be satisfactory.
- When calling outdoors, in a location where surroundings are noisy and where the sound echoes loudly, use an earphone/microphone.
- If the sound breaks up during a hands-free call, lower the in-call volume.

■ Adjusting the in-call volume

1 [🔊] during a call

2 [+]/[-]

- Alternatively, press [🔊] to adjust the volume.

3 [Close]

■ Using Noise suppression

When Noise suppression is set to [ON], you can measure ambient noises using the out-microphone and communicate by making your voices sound clear during a call.

1 [🔊] during a call

2 [OFF]/[ON] of Noise suppression

3 [Close]

- Noise suppression processes voices to make conversations sound clear. Sound quality may vary depending on the surrounding noises and the tone of the voice.
- When using Noise suppression, make sure not to cover the hole of the out-microphone and move the mouthpiece as close to your mouth as possible for speaking.

■ Using Slow Talk

When Slow talk is set to [ON], the speed of the other party's voice is slowed down during a call and you can hear the voice well.

1 [🔊] during a call

2 [OFF]/[ON] of Slow talk

3 [Close]

Using groups

- 1 In the home screen, [] ▶ [docomo phonebook] ▶ [Groups]
- 2 Use groups

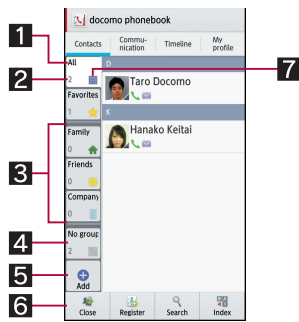

- 1 Account
- 2 Group icon
- 3 Group name
- 4 Add group
 - Add a group.
- 5 Group
- 6 Number of contacts registered in the group
- 7 Sort

- You cannot sort groups other than ones created with a docomo account.

■ Grouping/Ungrouping contacts

- 1 In the home screen, [] ▶ [docomo phonebook] ▶ [Groups]
- 2 Select a group ▶ [Delete member]/[Add member]
- 3 Select names ▶ [OK] ▶ [OK]

- The group function is available on contacts created with a docomo/Google account.

My profile

You can display your phone number registered on the docomo mini UIM card. You can also register your name, mail addresses, etc.

- 1 In the home screen, [] ▶ [docomo phonebook] ▶ [My profile]
- 2 Check/Use the profile

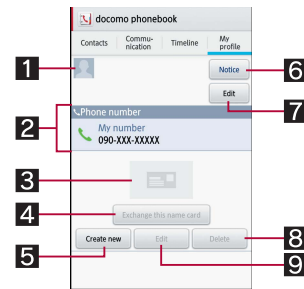

- 1 Image
- 2 Registered contents
- 3 Notice
 - Make settings for Friends notice.
 - Displayed only when you are using cloud computing.
- 4 Edit

■ Editing My profile

- 1 In the home screen, [] ▶ [docomo phonebook] ▶ [My profile] ▶ [Edit]
- 2 Set each item ▶ [Save]

Backing up/Restoring phonebook

You can back up/restore the phonebook by using docomo backup.

- For details on docomo backup (Backing up to/Restoring from a microSD Card) P. 62 "Backing up to/Restoring from a microSD Card"

docomo mail

You can send and receive mails using mail address of DOCOMO (@docomo.ne.jp). Pictograms and Deco-mail are available. Automatic reception is also supported. Also, mails can be easily transferred when you have lost the handset or changed models since sent and received mails are saved on the mail server of DOCOMO. Moreover, you can use the mailing function on any devices such as PCs and tablets if you use a docomo ID.

- For details on docomo mail, refer to the DOCOMO website.

1 In the home screen, [✉]

- Follow the instructions on the screen and operate after this step.

SMS

You can send and receive text messages that include up to 670 full-width characters (up to 1530 characters for half-width alphanumeric only) with mobile phone numbers serving as destinations.

- You can also exchange messages with users of overseas network operators. Refer to “Mobile Phone User’s Guide [International Services]” or the DOCOMO International Services website for information on countries where this service is available and available overseas network operators.

1 In the home screen, [☰] ▶ [Messaging]

2 [≡] ▶ enter the destination and message ▶ [➤]

- You can switch apps to send and receive SMSs with to Hangouts (☎ P. 68 “More”).
- If destinations are devices of overseas network operators, enter “+”, the country code and the recipient’s mobile phone number. If the phone number begins with “0”, omit the first “0”. Alternatively, enter “010”, the country code and the phone number.
- Half-width katakana and special symbols in SMS messages may not appear correctly for recipient.
- SMS cannot be sent when “186” or “184” is added.

Displaying message

1 In the home screen, [☰] ▶ [Messaging]

2 Select a thread

- Messages are grouped into a thread by destination/sender and displayed.

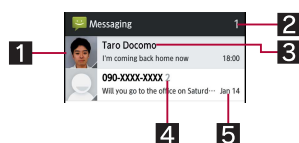

1 Image

- It is displayed if an image of the other party is registered in the phonebook. Touch to select and use an app supporting the registered contents of the phonebook. If the sender is not registered in the phonebook, you can register the person in the phonebook after touching it.

2 Number of unread messages

3 Destination/Sender

4 Number of messages in thread

5 Date and time of the message exchange

3 Check the message

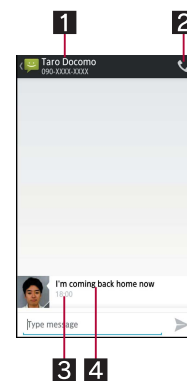

1 Destination/Sender

2 Phone call

3 Menu

- Display available functions (menus).

4 Date and time of the message exchange

5 Message

Replying message

1 In the home screen, [☰] ▶ [Messaging]

2 Select a thread

3 Enter the message ▶ [➤]

Forwarding message

1 In the home screen, [☰] ▶ [Messaging]

2 Select a thread

3 Touch and hold a message ▶ [Forward] ▶ enter the destination and message ▶ [➤]

Deleting message

1 In the home screen, [☰] ▶ [Messaging]

2 Select a thread

3 Touch and hold a message ▶ [Delete] ▶ [Delete]

Deleting thread

1 In the home screen, [☰] ▶ [Messaging]

- To delete all threads: [≡] ▶ [Delete all threads] ▶ [Delete]

2 Touch and hold a thread ▶ [Delete] ▶ [Delete]

Setting Messaging

1 In the home screen, [☰] ▶ [Messaging]

2 [≡] ▶ [Settings]

3 Select an item

- **SMS Enabled:** Set an app to send and receive SMSs with.
- **Delete old messages:** When the number of saved messages reaches its limit, messages are automatically deleted from the oldest one.
- **Text message limit:** Set the number of messages to be saved by thread.
- **Delivery reports:** Notify you that sent messages have been received every time a message is received.
- **Manage SIM card messages:** Manage messages saved on the docomo mini UIM card.

- **Notifications:** Notify you that messages have been received in the status bar.
- **Sound:** Set the ringtone to be rung when a message is received.
- **Vibrate:** Set the vibrator to be activated when a message is received.

[Delivery reports]

- When you send a message to mobile phones of other carriers, the notification for confirming that it has been received may not be sent to you.

Email

You can send and receive mails by setting up a mail account provided by a service provider.

- Set up an account in advance (☞ P. 24 “Setting up mail account”).

1 In the home screen, [App Icon] ▶ [Email]

2 [Compose]

3 Compose a mail

- To attach an image or a video: [Menu] ▶ [Attach file] ▶ select a file

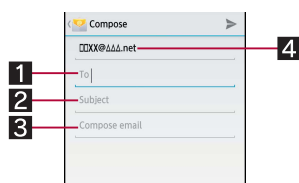

1 Destination

- When you enter part of a mail address or a name registered in the phonebook, destination candidates are displayed.

2 Subject

3 Message

4 Menu

- Display available functions (menus).

5 Account

- If you set multiple accounts, you can switch accounts.

4 [Back]

- Some receiving side models may not be able to receive the subject completely.
- Mails sent from a Gmail account are treated as ones from a PC. When receiving side models set PC-mail rejection, mails cannot be sent.
- Mails that could not be sent for any reason will be saved in the Outbox as unsent mails.
- Depending on the signal status etc., texts may not appear correctly on the screen of the other party's device.

Attaching file

- A mail can include 5 MB worth of file attachments together with the message. There are no limits to the number of files to be attached.
- Depending on the receiving side device, files may not be received or correctly displayed/played. Also, the quality of videos may deteriorate or videos may be converted to continuous still pictures.

Displaying mail

- The screen may appear different depending on the account to use.

1 In the home screen, [App Icon] ▶ [Email]

2 Select a mail

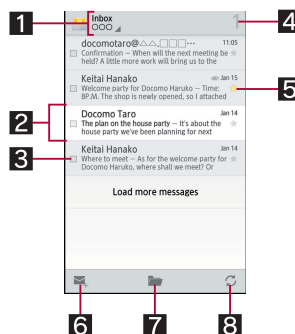

1 Folder name/Account name being displayed

- Touch to switch folders and accounts.

2 Mails

- The background color of a read mail turns gray.
- Touch images to checkmark the mails and you can set them to be deleted/unread/read etc. collectively.

3 Star icon

- Use it as a mark indicating that the mail is special or supposed to be dealt with later.
- You can check starred mails in the Starred folder.

4 Newly compose mail

5 Menu

- Display available functions (menus).

3 Check the mail

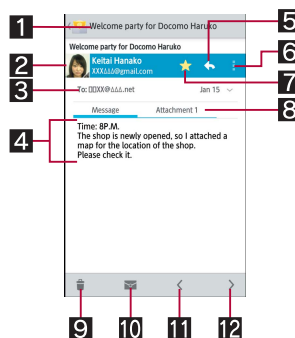

1 Subject

2 Sender/Date and time of reception

- Touch the image to display available apps supporting the registered contents of the phonebook. If the sender is not registered in the phonebook, you can register the person in the phonebook after touching the image.

3 Destination

- Touch to display the details.

4 Message

5 Attached file

6 Star icon

- Use it as a mark indicating that the mail is special or supposed to be dealt with later.
- You can check starred mails in the Starred folder.

7 Reply all/Forward

8 Reply

9 Delete

10 Unread

11 Menu

- Display available functions (menus).

Replying/Forwarding mail

1 In the home screen, [] ▶ [Email]

2 Select a mail

3 [↩]

- To reply to all: [] of the sender ▶ [Reply all]
- To forward: [] of the sender ▶ [Forward]

4 Compose a mail

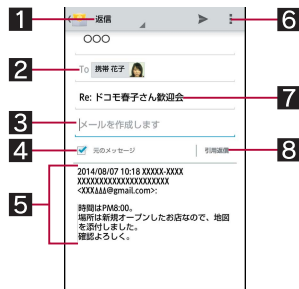

1 Reply type

- Touch to switch Reply/Reply all/Forward.

2 Destination

3 Message

4 Quote text

- Touch to display/hide messages of the sender.
- You cannot operate it when forwarding mails.

5 Mail of sender

6 Menus

- Display available functions (menus).

7 Subject

8 Respond inline

- Enter the mail of the sender in the message.

5 [➤]

Deleting mail

1 In the home screen, [] ▶ [Email]

- To delete selected mails: Touch the images of mails ▶ []

2 Select a mail

3 []

Setting Email

1 In the home screen, [] ▶ [Email] ▶ [] ▶ [Settings]

2 Select an item

- **General settings:** Make settings for the whole Email.
- Select an account to make settings for the details on each account such as Signature and Email notifications.
- Touch [ADD ACCOUNT] to add an account.

Gmail

Gmail is a mail service provided by Google.

- Set up a Google account in advance (P. 24 “Setting up Google account etc.”).

1 In the home screen, select “Google” folder ▶ [Gmail]

2 []

3 Compose a mail

- To attach a file: [] ▶ [Attach file] ▶ select a file

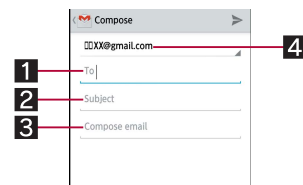

1 Destination

- When you enter part of a mail address or a name registered in the phonebook, destination candidates are displayed.

2 Subject

3 Message

4 Menu

- Display available functions (menus).

5 Account

- If you set multiple accounts, you can switch accounts.

4 [➤]

Displaying mail

1 In the home screen, select “Google” folder ▶ [Gmail]

2 Select a thread

- In Gmail, mails are grouped into threads by reply and displayed. If new mails are replied ones of an existing mail, they are grouped into the same thread. A new thread is created for newly composed mails or mails whose subjects have been changed.

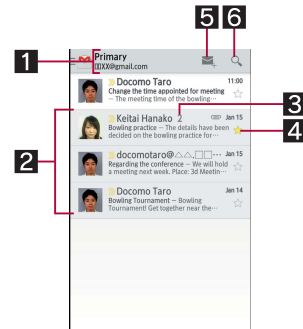

1 Label name/Account name being displayed

- Touch to switch displaying types and accounts.

2 Threads

- The background color of a thread turns gray when all mails in it are read.
- Touch images to checkmark the threads and you can set them to be archived/deleted/unread/read etc. collectively.

3 Number of mails in thread

4 Star icon

- Use it as a mark indicating that the mail is special or supposed to be dealt with later.
- You can check starred mails in the Starred folder.

5 Newly compose mail

6 Mail search

7 Menu

- Display available functions (menus).

Precautions about handling Bluetooth devices

Note the followings when using Bluetooth devices.

- Note the followings to make good connection.
 - Keep the distance between the handset and another Bluetooth device within approximately 10 m with no obstructions in sight. The distance within which you can make connection may be shorter when there are obstructions between them or depending on the conditions of the surroundings (such as walls or furniture) and the structure of a building. Especially when there is a wall or floor of reinforced concrete between them, they may be unable to connect with each other. Note the above mentioned distance is not guaranteed.
 - Move the handset and another Bluetooth device as far away as possible from home electric appliances, AV devices, OA devices, etc. before connection. Bluetooth devices are liable to be adversely affected by a microwave oven, so move them as far away as possible from the microwave oven while using them. Otherwise, normal connection cannot be performed when other electric devices are powered on or Bluetooth devices may cause noises or reception failure on a TV or radio set.
 - Move the Bluetooth device to a place where connection is possible when there is a broadcast station or radio near the Bluetooth device and the handset cannot be connected to the device. Strong radio waves may prevent connection between Bluetooth devices.
 - Wireless connection is available with Bluetooth devices put in a bag or pocket. However, lowering of communication speed or noise may result when you are in between the Bluetooth device and the handset.
- Electromagnetic signals from Bluetooth devices may affect the operation of electronic medical equipment etc. As some cases may result in accident, turn off the handset and other Bluetooth devices in the following place.
 - On trains ■ On airplanes ■ In hospitals
 - Near automatic doors or fire alarms
 - In places such as gas stations where flammable gas is generated

Radio interference with Wi-Fi compatible devices

- The Bluetooth devices use the same frequency band (2.4 GHz) as wireless LANs (IEEE 802.11b/g/n). Therefore, using a Bluetooth device near a wireless LAN device may cause the radio interference, lowering of communication speed, noise or connection failure. In this case, turn off the wireless LAN device or keep the handset and the Bluetooth device at least approximately 10 m away from the wireless LAN.

Using Bluetooth function

- To register/connect a Bluetooth device, the Bluetooth passkey may need to be entered. Before starting the registration, decide one- to sixteen-digit number. Enter the same number on the handset and the other party's Bluetooth device.
- Set the other party's Bluetooth device to the registration stand-by status in advance.

1 In the home screen, [Settings] ▶ [Bluetooth]

2 Slide [OFF] to the right

3 Select a Bluetooth device ▶ [Pair]

- The confirmation screen for connection may be displayed.
- Entering the Bluetooth passkey may be necessary depending on the other party's Bluetooth device. Also, some Bluetooth devices may start connecting after completing registration.

- To display/hide the handset's information on other Bluetooth devices: [SL050]
 - The handset's information is automatically hidden when the period of time set for Visibility timeout has passed.
- To search for Bluetooth devices: [SEARCH FOR DEVICES]
- Touch [↗] of a paired Bluetooth device to change the name and the connection type of the other party's Bluetooth device.

- You can connect up to seven Bluetooth devices at the same time. Bluetooth devices may not work properly or the number of Bluetooth devices which can be connected at the same time may differ depending on the profile.
- If you fail to connect, connection may become available after re-registration of Bluetooth devices.
- When the Bluetooth function is set to [ON], the handset is set to receive registration requests/connection requests from other Bluetooth devices. Make the setting for displaying the handset's information on other Bluetooth devices in advance to allow the handset to be searched for by other Bluetooth devices.
- While in connection stand-by, even if a connection request from a Bluetooth device is received, connection may not be made depending on the signal status etc.
- For details on the operations of the other party's Bluetooth device, refer to the manuals of the Bluetooth device to be used.

When receiving registration request from Bluetooth device or connection request from unregistered Bluetooth device

1 Registration request/Connection request from Bluetooth device

2 Drag the status bar down ▶ [Pairing request] ▶ [Pair]

- When the confirmation screen about the settings on pairing appears, select [Pair].
- Entering the Bluetooth passkey may be necessary depending on the other party's Bluetooth device.
- The confirmation screen for connection may be displayed.

Unregistering Bluetooth device

1 In the Bluetooth screen, [↗] of the Bluetooth device to unregister ▶ [Unpair]

Disconnecting Bluetooth device

1 In the Bluetooth screen, select the Bluetooth device to disconnect ▶ [OK]

Setting Bluetooth

- Set after setting the Bluetooth function to [ON].

1 In the Bluetooth screen, [≡]

2 Select an item

- **Rename phone:** Change the handset's name.
- **Visibility timeout:** Set how long the handset's information will be displayed on the other party's Bluetooth device.
- **aptX:** Set whether to use aptX®.
- **Handsfree setting:** Set whether to always have voices emitted from the connected Bluetooth compatible hands-free device during a voice call.
- **BT Smart setting:** Enable/Disable the BT Smart settings.
- **Show received files:** Display the history of data received via Bluetooth connection.

[aptX]

- When you enable [aptX], sounds may not be emitted depending on the Bluetooth device. In this case, disable [aptX].

Sending and receiving by Bluetooth

■ Sending data

Example: Still picture

- 1 In the home screen, [⋮] ▶ [Contents Manager] ▶ [Photo]
- 2 Touch and hold a still picture ▶ [Share] ▶ [Bluetooth]
 - Set the receiver's Bluetooth device to the reception stand-by status.
- 3 Select a Bluetooth device to connect to

■ Receiving data

- 1 Data is sent from the sender's Bluetooth device
- 2 Drag the status bar down ▶ select the incoming notification ▶ [Accept]
- 3 Drag the status bar down ▶ select the received data

- Note that if you select [Delete and register] when receiving all data, all data registered to the target function are deleted.
- Receiving all data may not be available depending on the data type.
- When available space in the save destination becomes insufficient while receiving data, the data being received to that point are saved and receiving ends.

Bluetooth Smart device connection

You can make a Bluetooth Smart device respond to the handset operations or notify you of incoming calls or new mails by operating the handset if you connect the handset to the Bluetooth Smart device.

■ Notifying this device

If you have connected the handset to a Bluetooth Smart device, you can make the Bluetooth Smart device ring or vibrate by operating the handset.

- 1 In the Bluetooth screen, [🔗] of a connected Bluetooth Smart device ▶ [Notify this device]
- 2 Select a notification method

- This is available only on Bluetooth Smart devices supporting FMP (Find Me Profile).

■ Advanced settings

You can make settings for operations available when the handset is connected to a Bluetooth Smart device.

- 1 In the Bluetooth screen, [🔗] of a connected Bluetooth Smart device ▶ [Advanced settings]
- 2 Select an item
 - **Incoming call notification:** Set whether to notify you through the Bluetooth Smart device when receiving a call.
 - **Mail reception notification:** Set whether to notify you through the Bluetooth Smart device when receiving a mail.

- **Alarm notification:** Set whether to notify you through the Bluetooth Smart device when an alarm rings.
- **Schedule notification:** Set whether to notify you of schedule notifications from the calendar through the Bluetooth Smart device.
- **Time change notification:** Set whether to synchronize clocks between the Bluetooth Smart device and the handset.
- **Link loss notification:** Set how to notify you when the Bluetooth connection is temporarily disabled.

NFC communication

NFC stands for Near Field Communication and is a near field wireless communication system which conforms to the international standards set by ISO (International Organization for Standardization). You can use the contactless IC card function, reader/writer function (R/W), Peer to Peer function (P2P), etc. on the handset.

Android beam

You can send and receive data to and from devices which support Reader/Writer, P2P function.

- Enable [Reader/Writer, P2P] and set Android beam to [ON] in advance (☞ P. 46 "NFC/Osaifu-Keitai settings").
- Android beam is not available when NFC/Osaifu-Keitai lock is set.
- Android beam may not be available depending on the app.
- Communication with all devices which support Reader/Writer, P2P function is not completely guaranteed.
- The precautions about using Android beam are the same as those about iC communication (☞ P. 76 "When using iC communication").
- Other precautions are the same as those for when you hold the handset over the other device (☞ P. 46 "Precautions about holding over the other device").

■ Sending data

Example: Phonebook

- 1 In the home screen, [⋮] ▶ [docomo phonebook] ▶ [Contacts] ▶ select a name
- 2 Place the  mark over that of the other party's device
 - [Touch to beam] appears.
 - If "License Agreement" is displayed, check the content, follow the instructions on the screen and operate.
- 3 Touch the screen

■ Receiving data

- 1 Place the  mark over that of the other party's device

Specific Absorption Rate (SAR) of Mobile Phones

This model SH-04F mobile phone complies with Japanese technical regulations and international guidelines regarding exposure to radio waves.

This mobile phone was designed in observance of Japanese technical regulations regarding exposure to radio waves* and limits to exposure to radio waves recommended by a set of equivalent international guidelines. This set of international guidelines was set out by the International Commission on Non-Ionizing Radiation Protection (ICNIRP), which is in collaboration with the World Health Organization (WHO), and the permissible limits include a substantial safety margin designed to assure the safety of all persons, regardless of age and health condition.

The technical regulations and international guidelines set out limits for radio waves as the Specific Absorption Rate, or SAR, which is the value of absorbed energy in any 10 grams of tissue over a 6-minute period. The SAR limit for mobile phones is 2.0 W/kg. The highest SAR value for this mobile phone when tested for use at the ear is 0.366 W/kg and when worn on the body is 0.495 W/kg. There may be slight differences between the SAR levels for each product, but they all satisfy the limit.

The actual SAR of this mobile phone while operating can be well below that indicated above. This is due to automatic changes to the power level of the device to ensure it only uses the minimum required to reach the network. Therefore in general, the closer you are to a base station, the lower the power output of the device.

This mobile phone can be used in positions other than against your ear. Please keep the mobile phone farther than 1.5 cm away from your body by using such as a carrying case or a wearable accessory without including any metals. This mobile phone satisfies the technical regulations and international guidelines.

The World Health Organization has stated that "a large number of studies have been performed over the last two decades to assess whether mobile phones pose a potential health risk. To date, no adverse health effects have been established as being caused by mobile phone use."

Please refer to the WHO website if you would like more detailed information.

http://www.who.int/docstore/peh-emf/publications/facts_press/fact_english.htm

Please refer to the websites listed below if you would like more detailed information regarding SAR.

Ministry of Internal Affairs and Communications Website:

<http://www.tele.soumu.go.jp/e/sys/ele/index.htm>

Association of Radio Industries and Businesses Website:

<http://www.arib-emf.org/index02.html> (in Japanese only)

NTT DOCOMO, INC. Website:

<https://www.nttdocomo.co.jp/english/product/sar/>

SHARP Corporation Website:

<http://www.sharp.co.jp/products/menu/phone/cellular/sar/index.html> (in Japanese only)

* Technical regulations are defined by the Ministerial Ordinance Related to Radio Law (Article 14-2 of Radio Equipment Regulations).

European RF Exposure Information

Your mobile device is a radio transmitter and receiver. It is designed not to exceed the limits for exposure to radio waves recommended by international guidelines. These guidelines were developed by the independent scientific organization ICNIRP and include safety margins designed to assure the protection of all persons, regardless of age and health.

The guidelines use a unit of measurement known as the Specific Absorption Rate, or SAR. The SAR limit for mobile devices is 2 W/kg and the highest SAR value for this device when tested at the ear is 0.381 W/kg* and when worn on the body is 0.354 W/kg*. For body-worn operation, this mobile device has been tested and meets the RF exposure guidelines when used with an accessory containing no metal and positioning the handset a minimum of 1.5 cm from the body. Use of other accessories may not ensure compliance with RF exposure guidelines.

As SAR is measured utilizing the devices highest transmitting power the actual SAR of this device while operating is typically below that indicated above. This is due to automatic changes to the power level of the device to ensure it only uses the minimum level required to reach the network.

* The tests are carried out in accordance with international guidelines for testing.

Declaration of Conformity

CE0168

In some countries/regions including Europe, there are restrictions on the use of 5GHz WLAN that may limit the use to indoors only. If you intend to use 5GHz WLAN on the device, check the local laws and regulations beforehand.

Hereby, Sharp Telecommunications of Europe Ltd, declares that this SH-04F is in compliance with the essential requirements and other relevant provisions of Directive 1999/5/EC. A copy of the original declaration of conformity can be found at the following Internet address: <http://www.sharp.co.jp/k-tai/> (in Japanese only)

FCC Notice

- This device complies with part 15 of the FCC Rules. Operation is subject to the following two conditions:
(1) This device may not cause harmful interference, and (2) this device must accept any interference received, including interference that may cause undesired operation.
- Changes or modifications not expressly approved by the manufacturer responsible for compliance could void the user's authority to operate the equipment.

Information to User

This equipment has been tested and found to comply with the limits of a Class B digital device, pursuant to Part 15 of the FCC Rules. These limits are designed to provide reasonable protection against harmful interference in a residential installation. This equipment generates, uses and can radiate radio frequency energy and, if not installed and used in accordance with the instructions, may cause harmful interference to radio communications.

However, there is no guarantee that interference will not occur in a particular installation; if this equipment does cause harmful interference to radio or television reception, which can be determined by turning the equipment off and on, the user is encouraged to try to correct the interference by one or more of the following measures:

1. Reorient/relocate the receiving antenna.
2. Increase the separation between the equipment and receiver.
3. Connect the equipment into an outlet on a circuit different from that to which the receiver is connected.

4. Consult the dealer or an experienced radio/TV technician for help.

5 GHz WLAN Operation in USA

Within the 5.15-5.25 GHz band, UNII devices are restricted to indoor operations to reduce any potential for harmful interference to co-channel Mobile Satellite Services (MSS) operations.

FCC RF Exposure Information

Your handset is a radio transmitter and receiver.

It is designed and manufactured not to exceed the emission limits for exposure to radio frequency (RF) energy set by the Federal Communications Commission of the U.S. Government.

The guidelines are based on standards that were developed by independent scientific organizations through periodic and thorough evaluation of scientific studies. The standards include a substantial safety margin designed to assure the safety of all persons, regardless of age and health.

The exposure standard for wireless handsets employs a unit of measurement known as the Specific Absorption Rate, or SAR. The SAR limit set by the FCC is 1.6 W/kg.

The tests are performed in positions and locations (e.g., at the ear and worn on the body) as required by the FCC for each model. The highest SAR value for this model handset when tested for use at the ear is 0.56 W/kg and when worn on the body, as described in this user guide, is 0.71 W/kg.

For body worn operation, this phone has been tested and meets the FCC RF exposure guidelines. Please use an accessory designated for this product or an accessory which contains no metal and which positions the handset a minimum of 1.5 cm from the body.

The use of accessories that do not satisfy these requirements may not comply with FCC RF exposure requirements, and should be avoided.

The FCC has granted an Equipment Authorization for this model handset with all reported SAR levels evaluated as in compliance with the FCC RF emission guidelines. SAR information on this model handset is on file with the FCC and can be found under the Display Grant section of <http://transition.fcc.gov/oet/ea/fccid/> after searching on FCC ID APYHRO00207.

Additional information on Specific Absorption Rates (SAR) can be found on the FCC website at <http://www.fcc.gov/encyclopedia/radio-frequency-safety>.

Export Administration Regulations

The Japan Export Administration Regulations (“Foreign Exchange and Foreign Trade Act” and its related laws) will be applied to this product and its accessories under certain conditions. The Export Administration Regulations are also applied. To export or reexport the handset and its accessories, conduct all legally required procedures at your own risk and expense. For details on the procedures, contact the Ministry of Economy, Trade and Industry or the US Department of Commerce.

Intellectual Property Right

Copyrights and rights of portrait

- Data with third party copyrights such as text, images, music and software that is downloaded via Internet websites, acquired by TV, video, etc. or shot by the handset cannot be duplicated, altered or publicly transmitted without rightful party’s consent. Only duplicating, quoting, etc. for personal use are permitted under the Copyright Act. Even if for personal use, filming and recording may be prohibited for stage performances, shows, exhibitions, etc. Also, shooting another’s image or posting another’s image on Internet websites without his/her consent may constitute a violation of one’s right to his/her image.

Registered trademarks and trademarks

- “FOMA”, “dmenu”, “dmarket”, “おサイフケータイ”, “ToruCa”, “mopera U”, “Deco-mail”, “i-appli”, “i-mode”, “i チャネル”, “iD”, “WORLD WING”, “WORLD CALL”, “i コンシェル”, “sp-mode”, “Xi”, “eトリセツ”, the “iD” logo and the “Xi” logo are trademarks or registered trademarks of NTT DOCOMO, INC.
- “Catch Phone (Call waiting service)” is a registered trademark of Nippon Telegraph and Telephone Corporation.
- Microsoft®, Windows®, Windows Media®, Windows Vista® and Exchange® are trademarks or registered trademarks of Microsoft Corporation in the United States and/or other countries.
- Oracle and Java are registered trademarks of Oracle and/or its affiliates. Other names may be trademarks of their respective owners.
- QR code is a registered trademark of Denso Wave Inc.
- microSD Logo, microSDHC Logo and microSDXC Logo are trademarks of SD-3C, LLC.



- The handset features LCFONT, developed by Sharp Corporation, to make the LCD easier to view and read. LCフォン /LCFONT and  are registered trademarks of Sharp Corporation.
- OBEX™ is a trademark of Infrared Data Association®.
-  is a registered trademark of FeliCa Networks, Inc.

- The abbreviations of operating systems (Japanese versions) below are used in this manual.
 - Windows 8.1 stands for Microsoft® Windows® 8.1, Microsoft® Windows® 8.1 Pro and Microsoft® Windows® 8.1 Enterprise.
 - Windows 8 stands for Microsoft® Windows® 8, Microsoft® Windows® 8 Pro and Microsoft® Windows® 8 Enterprise.
 - Windows 7 stands for Microsoft® Windows® 7 (Starter, Home Basic, Home Premium, Professional, Enterprise and Ultimate).
 - Windows Vista stands for Windows Vista® (Home Basic, Home Premium, Business, Enterprise and Ultimate).
- The Bluetooth word mark and logos are owned by the Bluetooth SIG, INC. and any use of such marks by NTT DOCOMO, INC. is under license. Other trademarks and trade names are those of their respective owners.
- Google, Google logo, Android, Android logo, Google Play, Google Play logo, Google+, Google+ logo, Gmail, Gmail logo, Calendar logo, Google Maps™, Google Maps logo, Google Talk™, Google Talk logo, Google Chrome™, Google Chrome logo, Google Voice Search™ logo, Picasa™, Picasa logo, YouTube and YouTube logo are trademarks of Google Inc.

Open source software

- This product includes software based on GNU General Public License (GPL), GNU Lesser General Public License (LGPL) and other licenses.
For details on licenses of related software, in the home screen, [⋮] ▶ [Settings] ▶ [Device info] ▶ [Legal information] ▶ [Open source licenses].
- Source codes of software based on GPL, LGPL and Mozilla Public License (MPL) can be referred to on the following website for free. For details, refer to the following website.
<https://sh-dev.sharp.co.jp/android/modules/oss/> (in Japanese only)

Unlocking SIM lock

- The handset can unlock the SIM lock. Unlock the SIM lock to use non-DOCOMO SIM cards.
- SIM lock can be unlocked at a docomo Shop.
- Commission is incurred separately for unlocking SIM lock.
- When using non-DOCOMO SIM card, it cannot be used in LTE. Also, some services and functions may be unavailable. DOCOMO shall not guarantee any operation of the handset.
- For details on unlocking SIM lock, refer to the DOCOMO website.

Check/Change the subscription, apply for various services, and request various information materials online.

From sp-mode dmenu ▶ お客様サポート (Support) ▶ ドコモオンライン手続きの一覧をみる (View lists of the docomo online procedure) (free of packet communication charges) (in Japanese only)

From a PC My docomo (<http://www.mydocomo.com/>) ▶ ドコモオンライン手続き一覧 (Lists of the docomo online procedure) (in Japanese only)

- ※ Use "network security code" to access from sp-mode.
- ※ Some services may be charged when you access the website from sp-mode.
- ※ Use "docomo ID/Password" to access from a PC.
- ※ If you do not have or you have forgotten your "network security code" or "docomo ID/Password", contact the number listed in "General Inquiries" on the last page.
- ※ The websites may not be available depending upon the content of your subscription.
- ※ You may not be able to access some website services due to system maintenance etc.

Using mobile phone with your manners!

Please be considerate of those around you when using the handset.

Turn off your handset in the following places

■ When in an area where use is prohibited

When you are on an airplane or in a hospital, follow the instructions given by the respective airlines or medical facilities. Turn off the handset in areas where the use of mobile phones is prohibited.

Set Public Mode in the following places

■ While driving

Using a mobile phone in hand while driving is regarded as a punishable act.

However, some cases such as when rescuing sick and injured people or maintaining public safety are exempted.

■ When in public places such as theaters, movie theaters or museums

Using the handset in public places where you should be quiet results in disturbing others.

Be aware of the place to use a mobile phone and the volume of your voice and ringtone

■ Be aware of the volume of your voice when using the handset in quiet places such as restaurant and hotel lobby.

■ Use in places where you do not block a passage in the town.

Be considerate of the privacy of the individuals around you

Please be considerate of the privacy of individuals around you when taking and sending photos using camera-equipped mobile phones.

Do not use your smartphone while walking

■ Using your smartphone while walking on a platform of a train station, street, etc. may narrow your vision and cause a collision.

■ Use your smartphone in a safe place after you stop walking.

These functions ensure manners in public

The handset has convenient functions such as setting not to answer a call and setting to mute sound of the handset.

- **Manner mode (☎ P. 64 "Mode settings")**
Mutes sound of the handset.
※ However, the manner mode cannot mute camera shutter sound.
- **Public Mode (Phone OFF) (☎ P. 36 "Network service")**
When a call is received, a message stating that you are in a place that does not allow the use of mobile phone is played and the call is automatically disconnected.
- **Phone vibration (☎ P. 64 "Sound")**
Notifies you of incoming call with vibration.
- **Answering memo (☎ P. 35 "Voice/Answering memo")**
Records callers' messages when you cannot answer the call.
※ Additionally, optional services such as Voice Mail Service (☎ P. 36 "Network service") and Call Forwarding Service (☎ P. 36 "Network service") are available.



We collect your unnecessary mobile phones and other devices irrespective of carrier. Bring them to a docomo Shop near you.

※ Intended devices: Mobile phone, PHS, battery pack, charger and desktop holder (irrespective of carrier)