

SHARP®

LC-26P50E LC-32P50E LC-37P50E

LCD COLOUR TELEVISION
LCD-FARBFERNSEHGERÄT
TÉLÉVISION COULEUR À ÉCRAN
À CRISTAUX LIQUIDES (LCD)
TELEVISORE A COLORI LCD
LCD-KLEURENTELEVISIE
TELEVISIÓN EN COLOR LCD

OPERATION MANUAL
BEDIENUNGSANLEITUNG
MODE D'EMPLOI
MANUALE DI ISTRUZIONI
GEBRUIKSAANWIJZING
MANUAL DE MANEJO

AQUOS

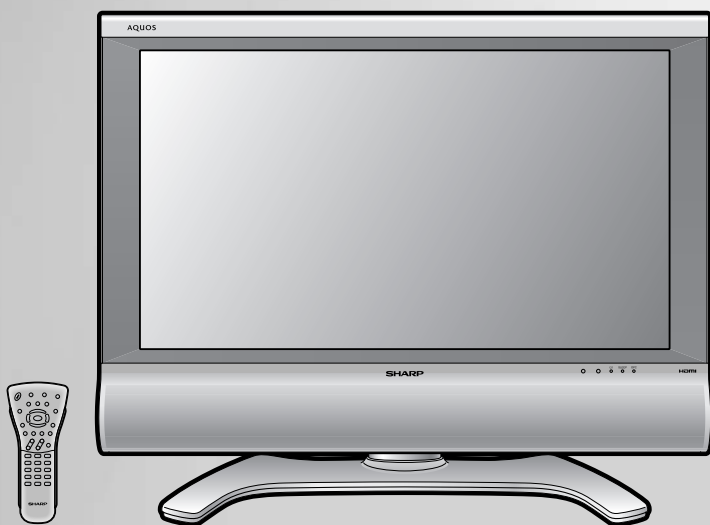

HDMI™
HIGH-DEFINITION MULTIMEDIA INTERFACE

ENGLISH

DEUTSCH

FRANÇAIS

ITALIANO

NEDERLANDS

ESPAÑOL

This apparatus complies with the requirements of Council Directives 89/336/EEC and 73/23/EEC as amended by Council Directive 93/68/EEC.

Dieses Gerät entspricht den Anforderungen der EG-Richtlinien 89/336/EWG und 73/23/EWG mit Änderung 93/68/EWG.

Ce matériel répond aux exigences contenues dans les directives 89/336/CEE et 73/23/CEE modifiées par la directive 93/68/CEE.

Dit apparaat voldoet aan de eisen van de richtlijnen 89/336/EEG en 73/23/EEG, gewijzigd door 93/68/EEG.

Dette udstyr overholder kravene i direktiv nr. 89/336/EEC og 73/23/EEC med tillæg nr. 93/68/EEC.

Quest' apparecchio è conforme ai requisiti delle direttive 89/336/EEC e 73/23/EEC, come emendata dalla direttiva 93/68/EEC.

Αυτή η συσκευή συμμορφώνεται με τις απαιτήσεις των οδηγιών του Συμβουλίου 89/336/ΕΟΚ και 73/23/ΕΟΚ όπως τροποποιήθηκαν από την οδηγία του Συμβουλίου 93/68/ΕΟΚ.

Este equipamento obedece às exigências das directivas 89/336/CEE e 73/23/CEE, na sua versão corrigida pela directiva 93/68/CEE.

Este aparato satisface las exigencias de las Directivas 89/336/CEE y 73/23/CEE, modificadas por medio de la 93/68/CEE.

Denna utrustning uppfyller kraven enligt riktlinjerna 89/336/EEC och 73/23/EEC så som kompletteras av 93/68/EEC.

Dette produktet oppfyller betingelsene i direktivene 89/336/EEC og 73/23/EEC i endringen 93/68/EEC.

Tämä laite täyttää direktiivien 89/336/EEC ja 73/23/EEC vaatimukset, joita on muutettu direktiivillä 93/68/EEC.

Bu cihaz Konsey Direktifi 93/68/EEC tarafından düzeltilen 89/336/EEC ve 73/23/EEC Konsey Direktiflerinin gerekliliklerine uygundur.

Tento přístroj je v souladu s požadavky směrníc rady 89/336/EEC a 73/23/EEC, tak jak byly upraveny směrnící rady 93/68/EEC.

See seade on vastavuses Nõukogu Direktiivis nr 89/336/EEC ja 73/23/EEC esitatud nõuetega, vastavalt Nõukogu Direktiivis nr 93/68/EEC esitatud parandustele

Ez a készülék megfelel a Tanács által kiadott, 89/336/EGK és 73/23/EGK Irányelveknek és az utóbbi módosító 93/68/EGK Irányelvnek

Ši ierice atbilst tehniskam prasibam pec 89/336/EEC un 73/23/EEC direktivam papildinats ar direktivu 93/68/EEC.



Šis prietaisas atitinka ES Tarybos direktyvu 89/336/EEC ir 73/23/EEC patikslintos direktyvos 93/68/EEC reikalavimus.

To urządzenie spełnia wymagania dyrektyw 89/336/EEC i 73/23/EEC wraz z poprawkami dyrektywy 93/68/EEC.

Tento prístroj je v súlade s požiadavkami smerníc rady 89/336/EEC a 73/23/EEC tak ako boli upravené smernicou rady 93/68/EEC.

Ta aparat je v skladu z zahtevami Direktiv Sveta 89/336/EEC in 73/23/EEC kot je navedeno v dopolnilu k Direktivi Sveta 93/68/EEC.

SPECIAL NOTE FOR USERS IN THE U.K.

The mains lead of this product is fitted with a non-rewireable (moulded) plug incorporating a 13A fuse. Should the fuse need to be replaced, a BSI or ASTA approved BS 1362 fuse marked  or  and of the same rating as above, which is also indicated on the pin face of the plug, must be used.

Always refit the fuse cover after replacing the fuse. Never use the plug without the fuse cover fitted.

In the unlikely event of the socket outlet in your home not being compatible with the plug supplied, cut off the mains plug and fit an appropriate type.

DANGER:

The fuse from the cut-off plug should be removed and the cut-off plug destroyed immediately and disposed of in a safe manner.

Under no circumstances should the cut-off plug be inserted elsewhere into a 13A socket outlet, as a serious electric shock may occur.

To fit an appropriate plug to the mains lead, follow the instructions below:

IMPORTANT:

The wires in the mains lead are coloured in accordance with the following code:

Blue: Neutral

Brown: Live

As the colours of the wires in the mains lead of this product may not correspond with the coloured markings identifying the terminals in your plug, proceed as follows:

- The wire which is coloured blue must be connected to the plug terminal which is marked N or coloured black.
- The wire which is coloured brown must be connected to the plug terminal which is marked L or coloured red.

Ensure that neither the brown nor the blue wire is connected to the earth terminal in your three-pin plug.

Before replacing the plug cover make sure that:

- If the new fitted plug contains a fuse, its value is the same as that removed from the cut-off plug.
- The cord grip is clamped over the sheath of the mains lead, and not simply over the lead wires.

IF YOU HAVE ANY DOUBT, CONSULT A QUALIFIED ELECTRICIAN.

- The illustrations and on-screen displays in this operation manual are for explanation purposes and may vary slightly from the actual operations.
- The examples used throughout this manual are based on the LC-32P50E model.

Contents

Contents	1	Power Control menu	12
Dear SHARP customer	2	No Signal Off	12
Important Safety Precautions	2	No Operation Off	12
Supplied accessories	2	Setup menu	12
Preparation	3	Auto Installation	12
Setting the TV	3	Programme Setup	12
Inserting the batteries	4	Auto Search	12
Using the remote control unit	4	Manual Adjust	13
Cautions regarding the remote control unit	4	Fine	13
Part names	5	Colour sys.	13
Remote control unit	5	Sound sys. (Broadcasting system)	13
TV (Front view)	6	Label	13
TV (Rear view)	6	Skip	13
Using external equipment	7	Decoder	13
Connecting a VCR	7	Lock	13
Connecting a DVD player	7	Sort	13
Connecting a game console or camcorder	7	Erase Programme	13
Connecting a decoder	7	Child Lock	14
Using AV Link function	8	Input Label	14
Watching TV	8	Position	14
Turning on the power	8	WSS (Wide Screen Signalling)	14
Standby mode	8	4:3 Mode	15
Turning off the power	8	Rotate	15
Initial auto installation	8	Language	15
Menu operations	9	Option menu	15
Menu operation buttons	9	Audio Only	15
On-Screen Display	9	DNR (Digital Noise Reduction)	15
Common operations	9	HDMI Setup	15
Picture menu	10	Input Select	16
AV Mode	10	Quick Shoot	16
OPC	10	Colour System	16
Picture adjustments	10	Demo	16
Advanced	10	Useful features	16
Colour Temp.	10	WIDE MODE	16
Black	11	Still image	17
3D-Y/C	11	Teletext function	17
Monochrome	11	Appendix	18
Film Mode	11	Troubleshooting	18
I/P Setting	11	HOW TO SET THE FACTORY PRESETS	18
Audio menu	11	About RESET and SYSTEM RESET	18
AV Mode	11	Specifications	19
Audio adjustments	11	End of life disposal	20
Surround	11		

• "HDMI, the HDMI logo and High-Definition Multimedia Interface are trademarks or registered trademarks of HDMI Licensing LLC."

Dear SHARP customer

Thank you for your purchase of the SHARP LCD colour TV product. To ensure safety and many years of trouble-free operation of your product, please read the Important Safety Precautions carefully before using this product.

Important Safety Precautions

- **Cleaning**—Unplug the AC cord from the AC outlet before cleaning the product. Use a damp cloth to clean the product. Do not use liquid cleaners or aerosol cleaners.
- **Water and moisture**—Do not use the product near water, such as bathtub, washbasin, kitchen sink, laundry tub, swimming pool and in a wet basement.
- Do not place vases or any other water-filled containers on this product. The water may spill onto the product causing fire or electric shock.
- **Stand**—Do not place the product on an unstable cart, stand, tripod or table. Doing so can cause the product to fall, resulting in serious personal injuries as well as damage to the product. Use only a cart, stand, tripod, bracket or table recommended by the manufacturer or sold with the product. When mounting the product on a wall, be sure to follow the manufacturer's instructions. Use only the mounting hardware recommended by the manufacturer.
- When relocating the product placed on a cart, it must be moved with utmost care. Sudden stops, excessive force and uneven floor surface can cause the product to fall from the cart.
- **Ventilation**—The vents and other openings in the cabinet are designed for ventilation. Do not cover or block these vents and openings since insufficient ventilation can cause overheating and/or shorten the life of the product. Do not place the product on a bed, sofa, rug or other similar surface, since they can block ventilation openings. This product is not designed for built-in installation; do not place the product in an enclosed place such as a bookcase or rack, unless proper ventilation is provided or the manufacturer's instructions are followed.
- The LCD panel used in this product is made of glass. Therefore, it can break when the product is dropped or impact applied. If the LCD panel is broken, be careful not to be injured by broken glass.
- **Heat sources**—Keep the product away from heat sources such as radiators, heaters, stoves and other heat-generating products (including amplifiers).
- To prevent fire, never place any type of candle or naked flames on the top or near the TV set.
- To prevent fire or shock hazard, do not place the AC cord under the TV set or other heavy items.
- Do not display a still picture for a long time, as this could cause an afterimage to remain.
- There is power consumption always if main plug is connected.

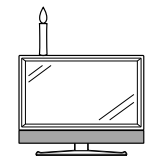
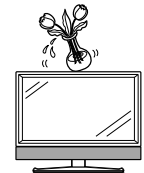

The LCD panel is a very high technology product, giving you fine picture details. Due to the very large number of pixels, occasionally a few non-active pixels may appear on the screen as a fixed point of blue, green or red. This is within product specifications and does not constitute a fault.

Precautions when transporting the TV

When transporting the TV, never carry it by holding onto the speaker. Be sure to always carry the TV by two people holding it with two hands—one hand on each side of the display.

Supplied accessories

Remote control unit (×1)



Page 4 and 5

AC cord (×1)

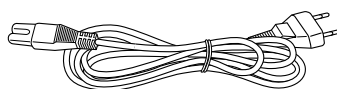

Product shape varies in some countries.

Page 3

Cable tie (×1)

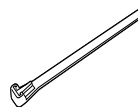

Page 3

Cable clamp (×1)



Page 3

- “AAA” size battery (×2) Page 4
- Operation manual

Preparation

Setting the TV

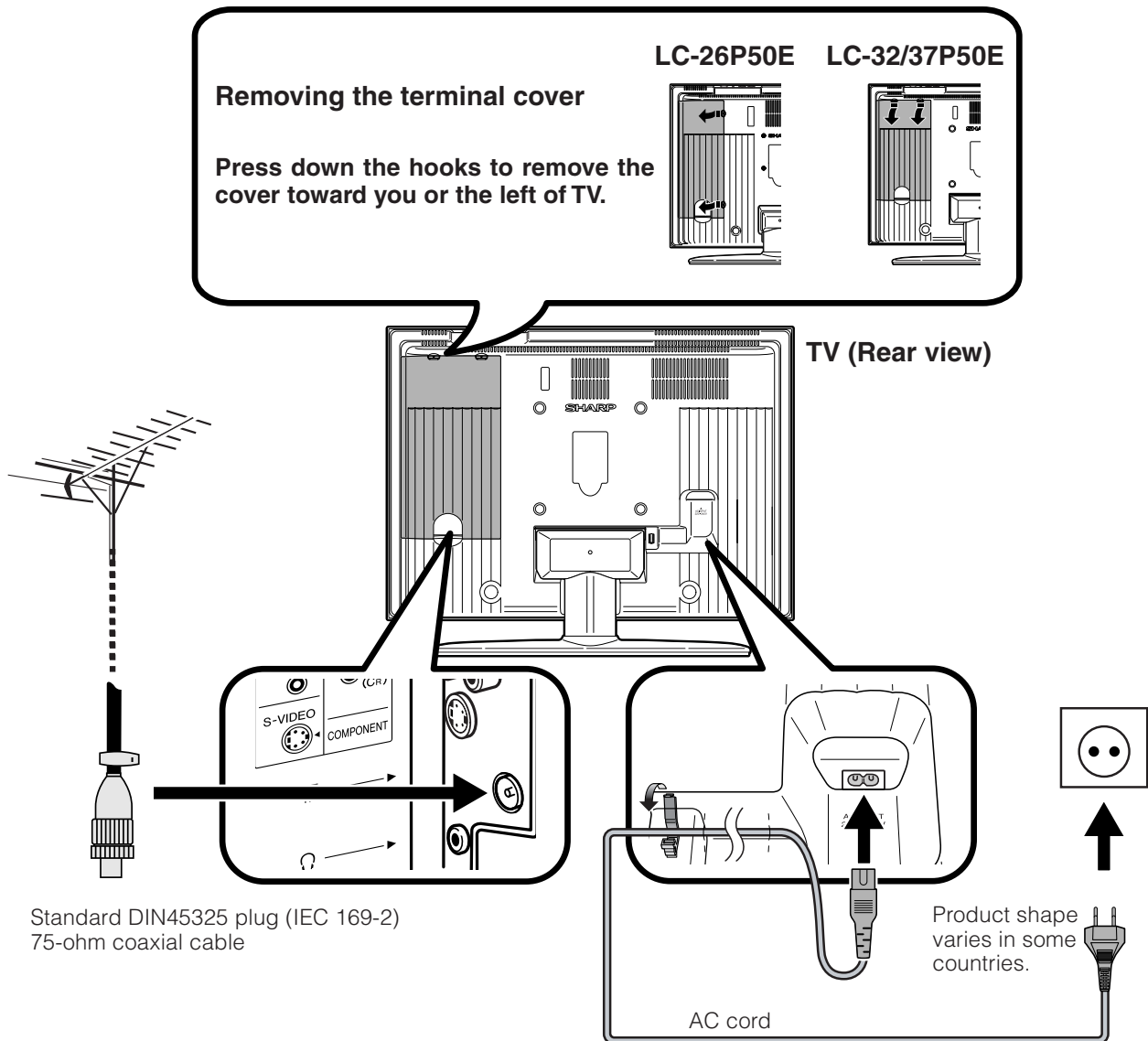

Bundling the cables

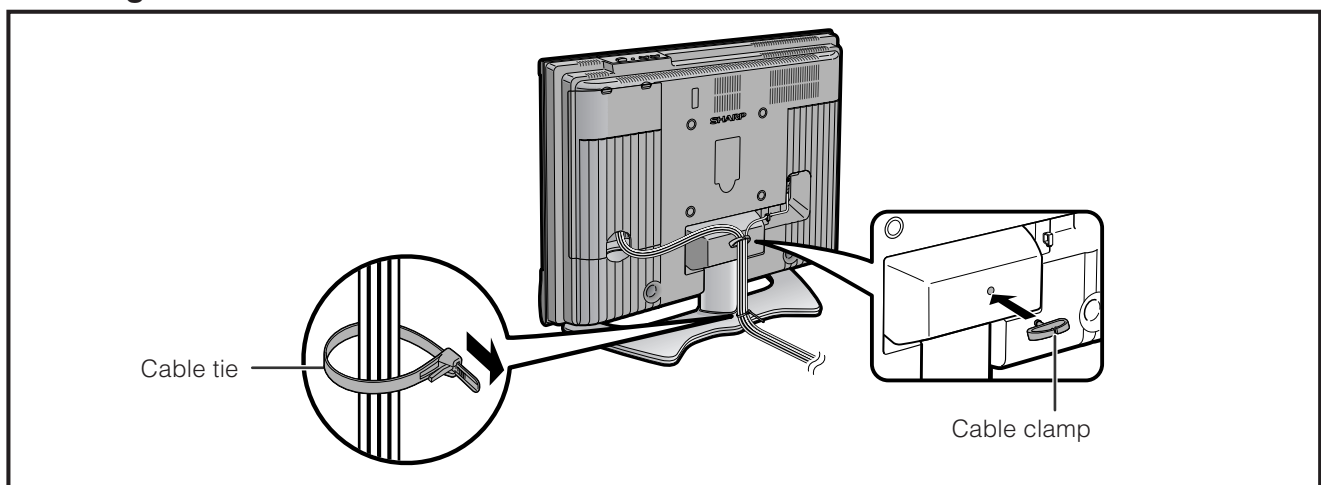

Setting the TV on the wall

- Installing the LCD Colour TV requires special skill that should only be performed by qualified service personnel. Customers should not attempt to do the work themselves. SHARP bears no responsibility for improper mounting or mounting that results in accident or injury.
- You can ask a qualified service personnel about using an optional bracket to mount the TV to the wall.

Preparation

Inserting the batteries

Before using the TV for the first time, insert two “AAA” size batteries (supplied). When the batteries become depleted and the remote control unit fails to operate, replace the batteries with new “AAA” size batteries.

- 1 Press and slide the battery cover to open it.
- 2 Insert two supplied “AAA” size batteries.
 - Place batteries with their terminals corresponding to the (+) and (–) indications in the battery compartment.
- 3 Close the battery cover.

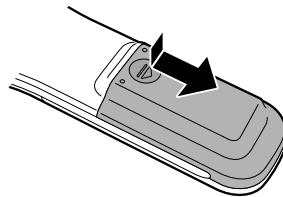

CAUTION

Improper use of batteries can result in chemical leakage or explosion. Be sure to follow the instructions below.

- Do not mix batteries of different types. Different types of batteries have different characteristics.
- Do not mix old and new batteries. Mixing old and new batteries can shorten the life of new batteries or cause chemical leakage in old batteries.
- Remove batteries as soon as they have worn out. Chemicals that leak from batteries can cause a rash. If you find any chemical leakage, wipe thoroughly with a cloth.
- The batteries supplied with this product may have a shorter life expectancy due to storage conditions.
- If you will not be using the remote control unit for an extended period of time, remove the batteries from it.

Using the remote control unit

Use the remote control unit by pointing it towards the remote control sensor. Objects between the remote control unit and sensor may prevent proper operation.

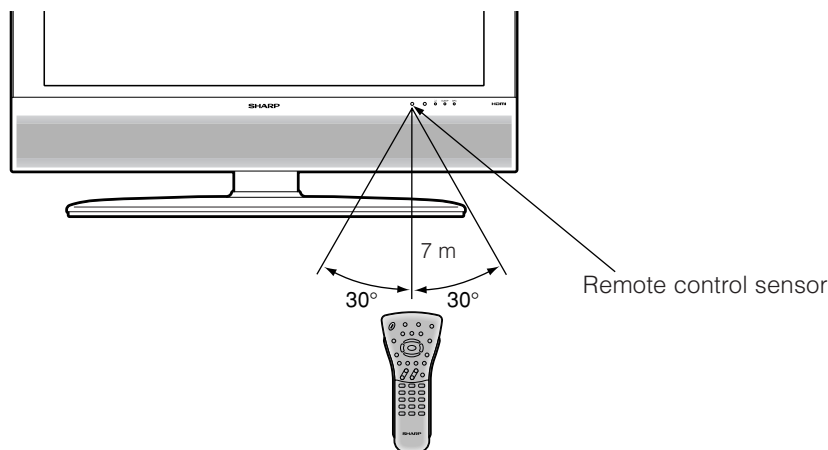

Cautions regarding the remote control unit

- Do not expose the remote control unit to shock. In addition, do not expose the remote control unit to liquids, and do not place in an area with high humidity.
- Do not install or place the remote control unit under direct sunlight. The heat may cause deformation of the unit.
- The remote control unit may not work properly if the remote control sensor of the TV is under direct sunlight or strong lighting. In such case, change the angle of the lighting or TV, or operate the remote control unit closer to the remote control sensor.

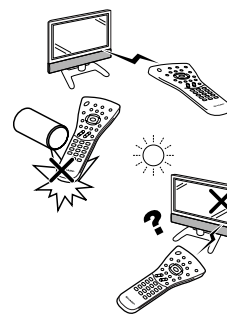

Part names

Remote control unit

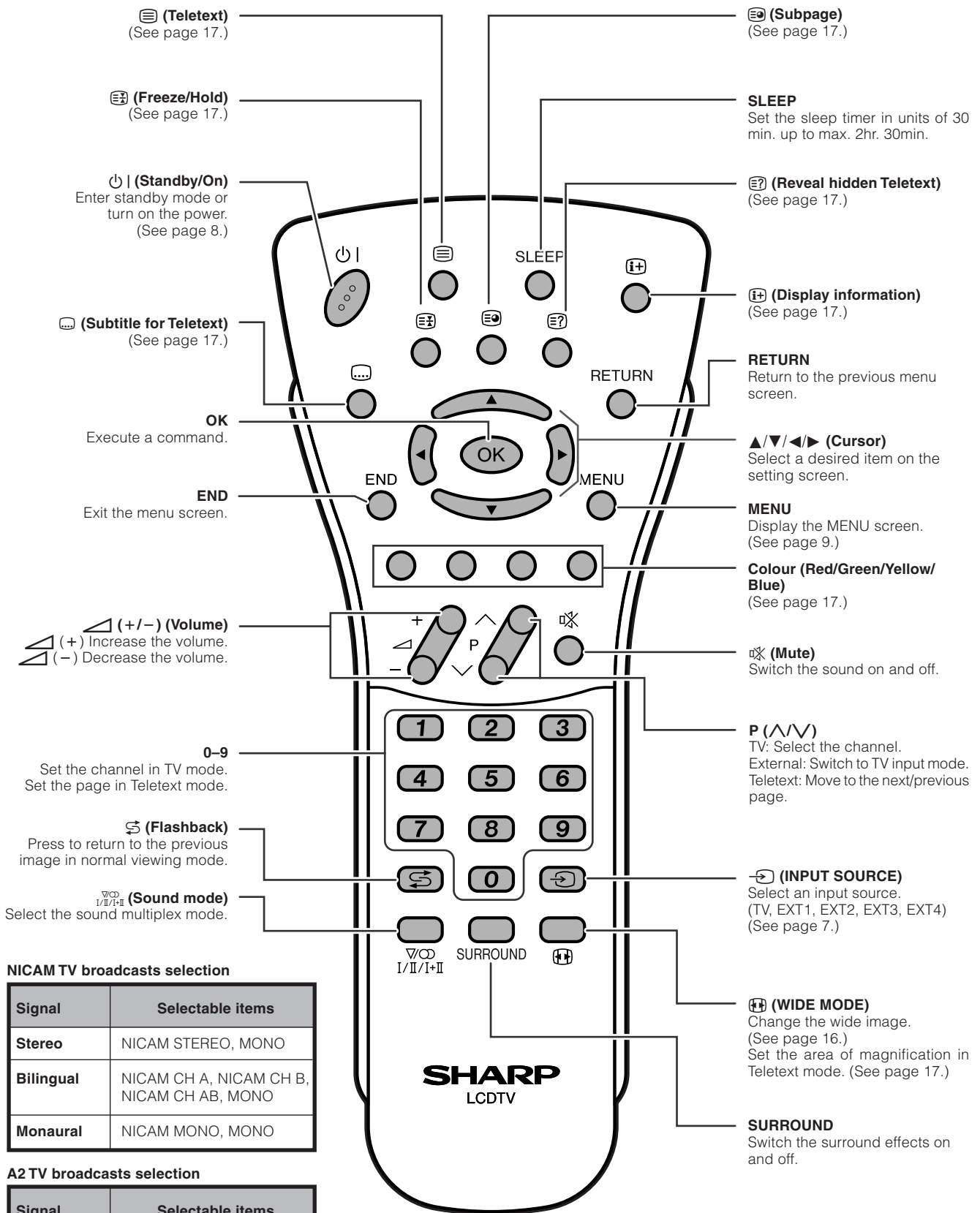

NOTE

- When no signal is input, the sound mode will display "MONO".

Part names

TV (Front view)

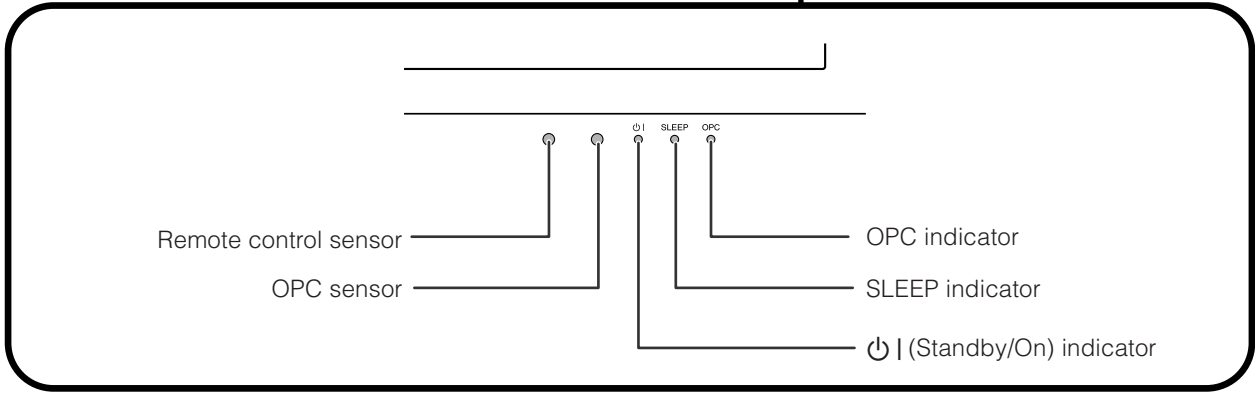
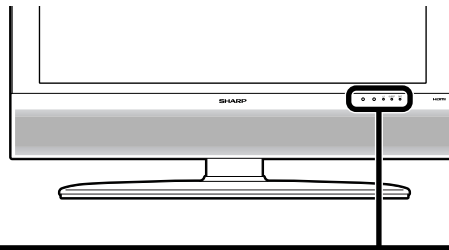

TV (Rear view)

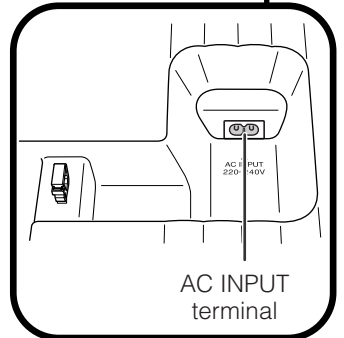
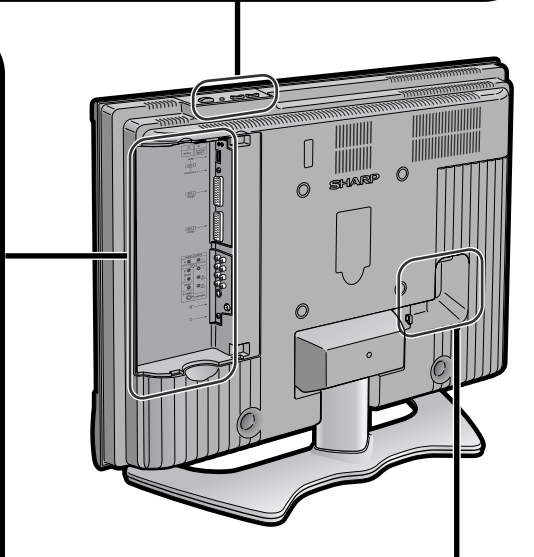
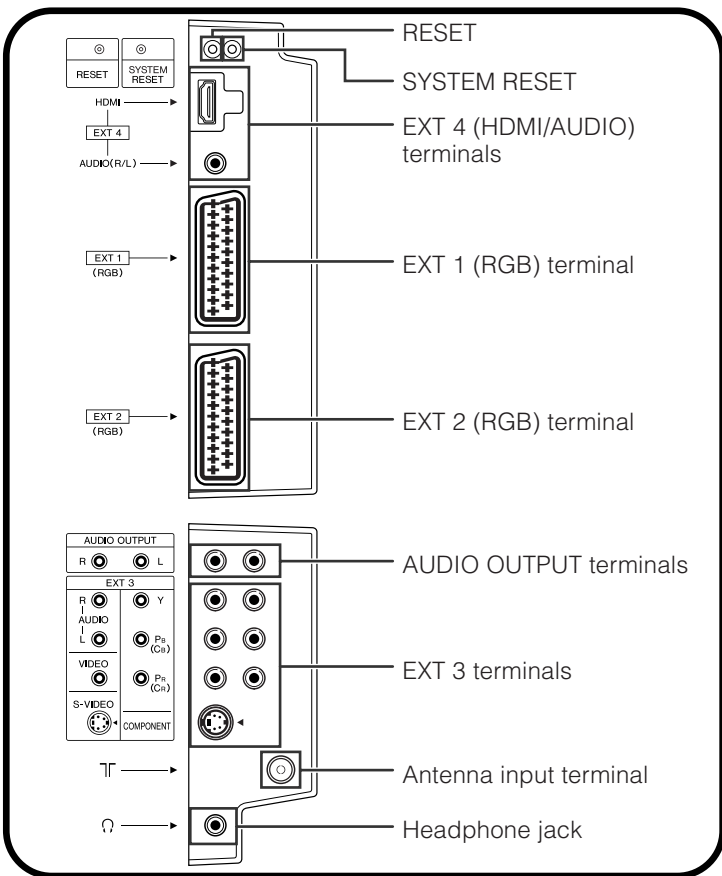
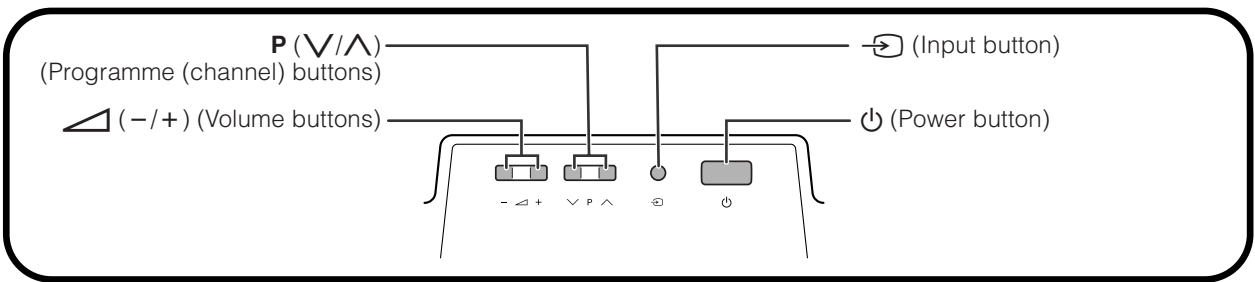

Using external equipment

Setting the input source

To view external source images, select the input source using on the remote control unit or on the TV.

NOTE

- The cables marked with * are commercial items.

Connecting a VCR

You can use the EXT 2 terminal when connecting a VCR and other audiovisual equipment.

If your VCR supports TV-VCR advanced AV Link systems, you can connect the VCR to the EXT 2 terminal of the TV using the fully-wired SCART cable.

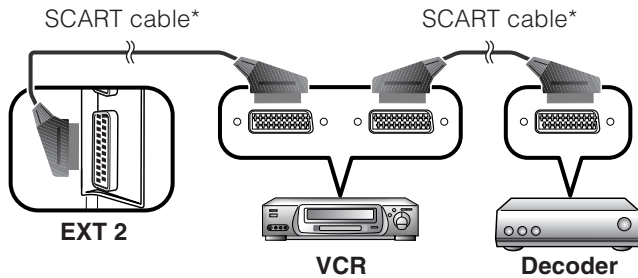

NOTE

- TV-VCR advanced AV Link systems may not be compatible with some external sources.
- It is recommended to connect to the EXT 2 terminal when using a decoder for ground wave signal input with a VCR. If EXT 2 signals preset in Auto Installation or Programme Setup, make sure to set "Decoder" to "EXT2" in the Programme Setup "Manual Adjust" menu. (See page 13.)

Connecting a game console or camcorder

A game console, camcorder and some other audiovisual equipment are conveniently connected using the EXT 3 terminals.

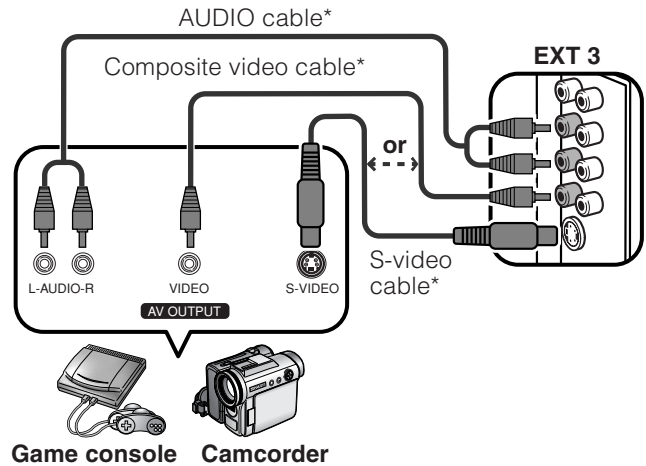

NOTE

- The priority of the S-VIDEO and VIDEO terminal depends on the Input Select setting. (See page 16.)
- You can connect the game console to EXT 1 or 3 terminals to enjoy clearer picture.

Connecting a DVD player

You can use the EXT 3 or 4 (HDMI) terminals when connecting to a DVD player and other audiovisual equipment.

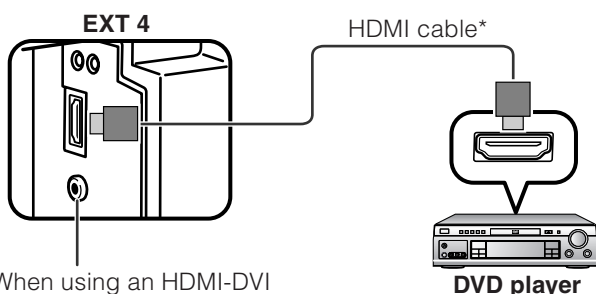
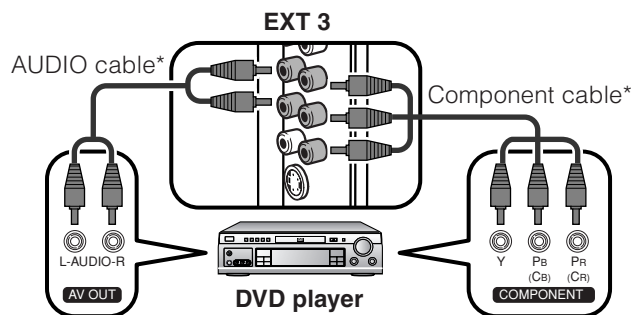

When using an HDMI-DVI conversion adapter, input the Audio signal to AUDIO terminal of EXT4.

Connecting a decoder

You can use the EXT 1 terminal when connecting a decoder and other audiovisual equipment.

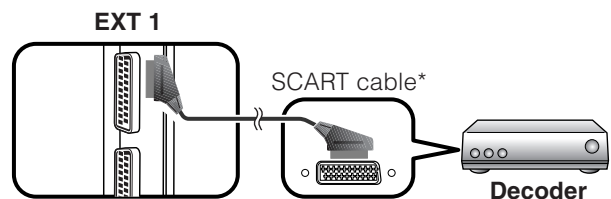

NOTE

- In cases when the decoder needs to receive signal from the TV, make sure to set "Decoder" to "EXT1" in the Programme Setup "Manual Adjust" menu. (See page 13.)

Using external equipment

Using AV Link function

This TV incorporates four typical AV Link functions for smooth connections between the TV and other audiovisual equipment.

One Touch Play

While the TV is in standby mode, it automatically turns on and plays back the image from the audiovisual source (e.g. VCR, DVD).

TV Standby

When the connected audiovisual equipment (e.g. VCR, DVD) enters standby mode, so does the TV.

WYSIWYR (What You See Is What You Record)

When the remote control unit of the connected VCR has the WYSIWYR button, you can automatically start recording by pressing the WYSIWYR button.

Preset Download

Automatically transfers the channel preset information from the tuner on the TV to the one on the connected audiovisual equipment (e.g. VCR) via the EXT 2 terminal.

NOTE

- Refer to operation manuals of each external equipment for the details.
- Only works when the audiovisual equipment is connected to the EXT 2 terminal on the TV with AV Link via a fully wired SCART.
- The use of the AV Link function is only possible if the TV-set has enforced a complete auto-installation with the connected audiovisual equipment (page 8, Initial auto installation).
The availability of the AV Link function depends on the audiovisual equipment used. Depending on the manufacturer and type of equipment used, it is possible that the described functions may be completely or partially unusable.

Watching TV

Turning on the power

Press  on the TV.

- The  indicator on the TV changes from red to green.



Standby mode

Press  on the remote control unit.

- The TV enters standby mode and the image on the screen disappears.
- The  indicator on the TV changes from green to red.

Turning off the power

Press  on the TV.

- The  indicator on the TV gradually turns off.
- When the TV is turned off by , you cannot turn on the power by pressing  on the remote control unit.

Display status indicator

Off	Power off
Red	The TV is in standby mode.
Green	The TV is on.

NOTE

- If you are not going to use this TV for a long period of time, be sure to remove the AC cord from the power outlet.
- Weak electric power is still consumed even when  is turned off.

Initial auto installation

When the TV powers on for the first time after purchase, the initial auto installation is invoked. You can automatically set language, country and channels in successive operations.

NOTE

- The initial auto installation functions only once. If the initial auto installation is not completed, (ex: When menu screen disappeared by not operating for a few minutes, when the power shut down, etc.), try Auto Installation from the Setup menu. (See page 12.)
- The initial auto installation stops by pressing **RETURN**.

1 Setting the on-screen display language

- ① Press  to select the desired language listed on the screen.
- ② Press **OK** to enter the setting.

2 Setting the country or area

- ① Press  to select your country or area listed on the screen.
 - ② Press **OK** to enter the setting.
- The programme auto search starts at the same time.

After this setting, auto search starts with the following order.

- ① Programme auto search
- ② Auto labelling
- ③ Auto sorting
- ④ Preset download

You do not need to do anything during the auto search.



The setup menu disappears and you can watch the programme on channel 1.

Menu operations

Menu operation buttons

Use the following buttons on the remote control unit to operate the menu.

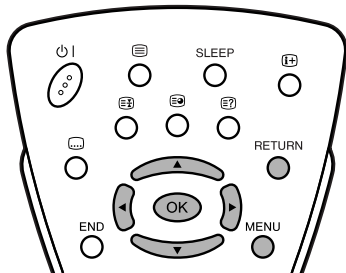

- MENU:** Press to open or close the menu screen.
- ▲/▼/◀/▶:** Press to select a desired item on the screen or adjust a selected item.
- OK:** Press to go to the next step or complete the setting.
- RETURN:** Press to return to the previous step.

On-Screen Display

Example

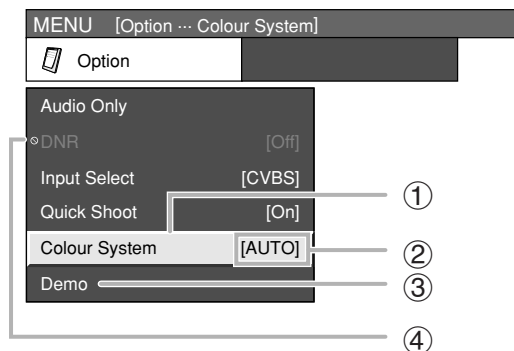

- ① Item displayed in yellow
 - This indicates the item currently selected.
- ② Item in brackets
 - This indicates the current setting for the item.
- ③ Item displayed in white
 - This indicates an item can be selected.
- ④ Item with displayed in grey
 - This indicates the item cannot be selected for various reasons.

NOTE

- Menu options differ in the selected input modes, but the operating procedures are the same.
- The screens in the operation manual are for explanation purposes (some are enlarged, others cropped) and may vary slightly from the actual screens.

Common operations

Menu Operation: A

- ① Press **MENU** and the MENU screen displays.
- ② Press **◀/▶** to select the desired menu.
- ③ Press **▲/▼** to select the desired menu item, and then press **OK** (Example: AV Mode, OPC, etc).
 - Select "Reset" to reset all adjustment items to the factory preset values.

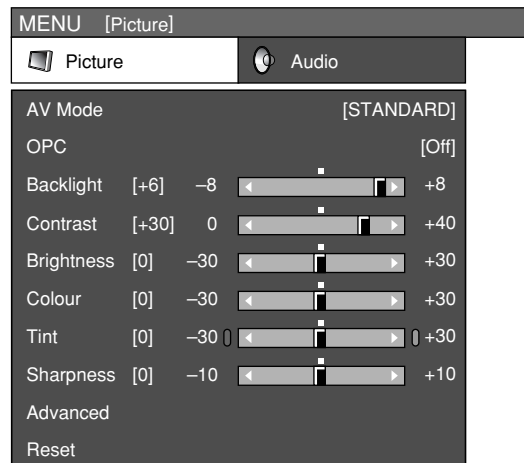

- ④ Press **▲/▼/◀/▶** to select the desired item, and then press **OK**.

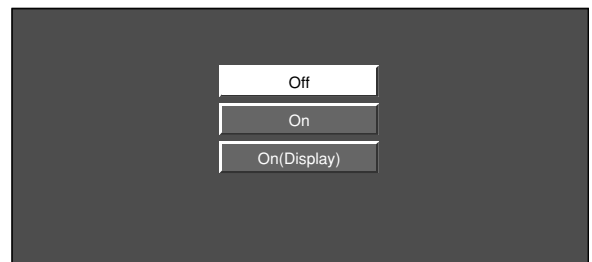

Menu Operation: B

- ① Press **MENU** and the MENU screen displays.
- ② Press **◀/▶** to select the desired menu.
- ③ Press **▲/▼** to select the desired menu item (Example: Backlight, Contrast, etc).
- ④ Press **◀/▶** to adjust the item to your desired position.
 - Select "Reset" to reset all adjustment items to the factory preset values.

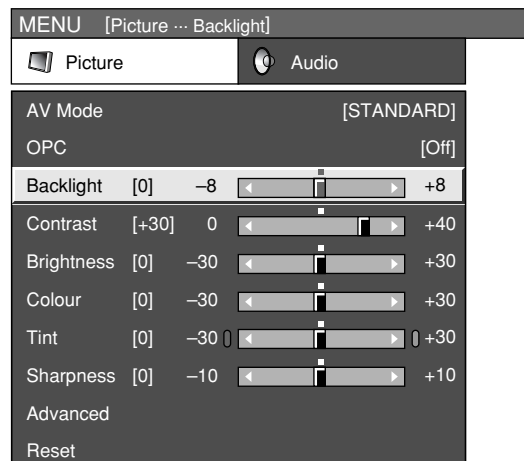

Menu operations

Picture menu

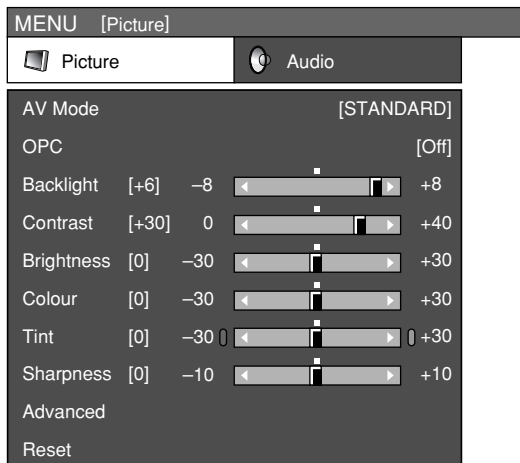

AV Mode

Menu Operation: A (page 9)

AV Mode gives you five viewing options to choose from to best match the system environment, which can vary due to factors like room-brightness, type of programme watched or the type of image input from external equipment.

Item

STANDARD: For a highly defined image in a normally bright room

MOVIE: For a movie

GAME: Lowers image brightness for easier viewing.

USER: Allows the user to customise settings as desired. You can set the mode for each input source.

DYNAMIC: For a clear-cut image emphasising high contrast for sports viewing

NOTE

- You can select a different AV Mode item for each input source. (For example, select "STANDARD" for TV input and "DYNAMIC" for VIDEO input.)

OPC

Menu Operation: A (page 9)

Automatically adjust the brightness of the screen.

Item

Off: The brightness is fixed at the value set in Backlight.

On: Automatically adjusts

On(Display): Displays the OPC effect on the screen while adjusting the brightness of the screen.

NOTE

- When set to "On", the TV senses the surrounding light and automatically adjusts the backlight brightness. Make sure no object obstructs the OPC sensor, which could affect its ability to sense surrounding light.

Picture adjustments

Menu Operation: B (page 9)

Adjust the picture to your preference with the following picture settings.

Selectable items	◀ button	▶ button
Backlight	The screen dims	The screen brightens
Contrast	For less contrast	For more contrast
Brightness	For less brightness	For more brightness
Colour	For less colour intensity	For more colour intensity
Tint	Skin tones become purplish	Skin tones become greenish
Sharpness	For less sharpness	For more sharpness

Advanced



- Press **MENU** and the MENU screen displays.
- Press ◀/▶ to select "Picture".
- Press ▲/▼ to select "Advanced", and then press **OK**.
- Press ▲/▼ to select the desired menu item, and then press **OK** (Example: Colour Temp., Black, etc).
- Press ▲/▼/◀/▶ to select the desired item, and then press **OK**.

Colour Temp.

Adjust the colour temperature to give the best white image.

Item

High: White with bluish tone

Mid-High: Intermediate tone between High and Middle

Middle: Natural tone

Mid-Low: Intermediate tone between Middle and Low

Low: White with reddish tone

Menu operations

Black

For easier viewing, change the viewing depth by selecting a level for automatically adjusting the dark portion of an image.

3D-Y/C

Provide high quality images with minimal dot crawl and cross colour noise by detecting changes in the image.

Item

Off: No detecting

Standard: Normal adjustment

Fast: Set the optimum image quality for fast-moving images.

Slow: Set the optimum image quality for slow-moving images.

NOTE

- 3D-Y/C may not operate depending on the input signal type or noisy input signal.
- 3D-Y/C has even more effect on composite video signals (CVBS).

Monochrome

For viewing a video in monochrome.

Film Mode

Automatically detect a film-based source (originally encoded at 24/25 frames/second, depending on the vertical frequency), analyses it then recreates each still film frame for high-definition picture quality.

I/P Setting

Adjust the image and input signal can give you a more beautiful picture.

Item

Interlace: Display finely detailed images for TV or video etc.

Progressive: Display smooth images for still images or graphics etc.

Audio menu

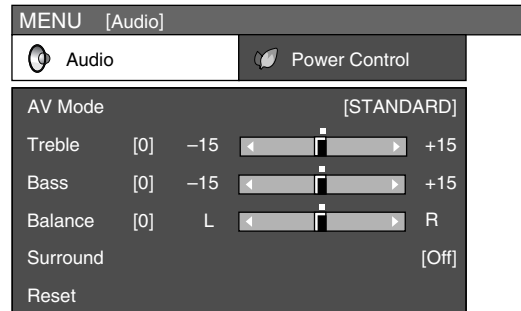

AV Mode

This option links to AV Mode in the Picture menu. (See page 10.)

Audio adjustments

Menu Operation: B (page 9)

You can adjust the sound quality to your preference with the following settings.

Selectable items	◀ button	▶ button
Treble	For weaker treble	For stronger treble
Bass	For weaker bass	For stronger bass
Balance	Decrease audio from the right speaker	Decrease audio from the left speaker

Surround

Menu Operation: A (page 9)

Surround function allows you to enjoy realistic “live” sound.

NOTE

- You can also choose surround effects by pressing **SURROUND** on the remote control unit.

Menu operations

Power Control menu

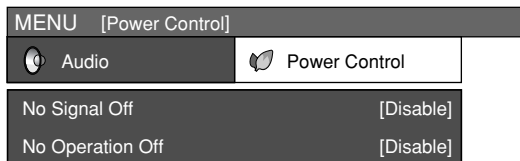

No Signal Off

Menu Operation: A (page 9)

When set to "Enable", the power will automatically shut down if no signal inputs for 15 minutes.

- Five minutes before the power shuts down, remaining time displays every minute.

NOTE

- When a TV programme finishes, this function may not operate.

No Operation Off

Menu Operation: A (page 9)

When set to "Enable", the power will automatically shut down if there is no operation for 3 hours.

- Five minutes before the power shuts down, remaining time displays every minute.

Setup menu

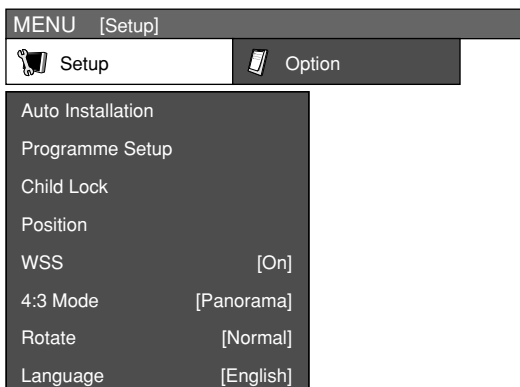

Auto Installation

You can run Auto Installation again, even after setting up the preset channels.

- 1 Press **MENU** and the MENU screen displays.
- 2 Press ◀▶ to select "Setup".
- 3 Press ▲/▼ to select "Auto Installation", and then press **OK**.
If you already set the PIN, enter it here.
 - See page 14 for setting PIN.
- 4 Press ◀▶ to select "Yes", and then press **OK**.

- 5 You can set language and country the same as in the initial auto installation. Follow steps 1 and 2 on page 8. After this setting, auto search starts with the following order.

- ① Programme auto search
- ② Auto labelling
- ③ Auto sorting
- ④ Preset download

You do not need to do anything during the auto search.

Programme Setup

You can run the Auto Installation procedure again at any time, by accessing the Setup menu, then Programme Setup. Channels can be tuned automatically or manually.

- 1 Press **MENU** and the MENU screen displays.
- 2 Press ◀▶ to select "Setup".
- 3 Press ▲/▼ to select "Programme Setup", and then press **OK**.
If you already set the PIN, enter it here.
 - See page 14 for setting PIN.
- 4 Press ▲/▼ to select "Auto Search", "Manual Adjust", "Sort" or "Erase Programme", and then press **OK**.

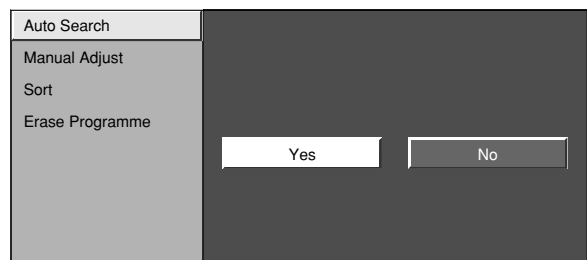

Auto Search

You can automatically search for and download TV channels by performing the procedure below. This is the same function as from programme auto search to preset download in Auto Installation.

- 1 Repeat steps 1 to 4 in **Programme Setup**.
- 2 Press ◀▶ to select "Yes", and then press **OK**.
 - ① Programme auto search
 - ② Auto labelling
 - ③ Auto sorting
 - ④ Preset download

NOTE

- See page 8 for details.

Menu operations

Manual Adjust

You can set some channel items manually.

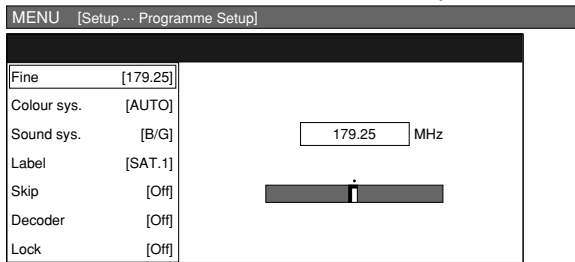

- 1 Press **MENU** and the MENU screen displays.
- 2 Press **◀/▶** to select "Setup".
- 3 Press **▲/▼** to select "Programme Setup", and then press **OK**.
If you already set the PIN, enter it here.
 - See page 14 for setting PIN.
- 4 Press **▲/▼** to select "Manual Adjust" and then press **OK**.
- 5 Press **◀/▶** to select "Yes", and then press **OK**.
- 6 Press **▲/▼/◀/▶** to select the channel you want to edit, and then press **OK**.
 - The selected channel information displays.
- 7 Press **▲/▼** to select the desired menu item, and then press **OK**.
- 8 Press **▲/▼/◀/▶** to select or adjust.

NOTE

- When you exit Programme Setup "Manual Adjust" menu, preset download automatically runs if you change information on that menu.

Fine

You can adjust the frequency to your desired position.

NOTE

- Adjust while checking the background picture as a reference.
- Instead of pressing **◀/▶** to adjust the frequency in step 8 above, you can set by directly entering the frequency number of the channel with **0-9**.

EXAMPLE

- 179.25 MHz: Press **1** → **7** → **9** → **2** → **5**.
- 49.25 MHz: Press **4** → **9** → **2** → **5** → **OK**.

Colour sys.

Select the optimum colour systems to receive. (AUTO, PAL, SECAM, NTSC 4.43, PAL-60)

Sound sys. (Broadcasting system)

Select the optimum sound systems (Broadcasting systems) to receive. (B/G, D/K, I, L, L')

Label

When a TV channel sends its Network Name, the Auto Installation detects the information and assigns a name to it. However, you can change individual channel names.

- 1 Repeat steps 1 to 7 in **Manual Adjust**.

- 2 Press **▲/▼/◀/▶** to select each character of the new name for the channel, and then press **OK**.

- 3 Repeat step 2 above until the name is fully spelt out.

- The name can be 5 characters or less.
- If a channel name is less than 5 characters, select "END", then press **OK**.

Skip

Channels with "Skip" set to "On" are passed over when using **P▲/P▼** even if selected while watching the image from the TV.

Decoder

When connecting a decoder to the unit, you need to assign the terminal input.

NOTE

- "Off" is factory preset value.
- "EXT1" is the recommended selection.

Lock

You can block the viewing of any channel.

NOTE

- See page 14 for setting PIN.
- When Lock is set to "On" for a channel, "Child lock has been activated." displays, and the image and sound of the channel are blocked.
- When pressing **OK** while "Child lock has been activated." displays, PIN input menu will display. Inputting the correct PIN lifts the child lock temporarily until the power is turned off.

Sort

Channel positions can be sorted freely.

- 1 Repeat steps 1 to 4 in **Programme Setup**.
- 2 Press **◀/▶** to select "Yes", and then press **OK**.
- 3 Press **▲/▼/◀/▶** to select the channel you want to move, and then press **OK**.
- 4 Press **▲/▼/◀/▶** to move it to the desired position, and then press **OK**.
- 5 Repeat steps 3 and 4 until all desired channels are sorted.

Erase Programme

An individual programme can be erased.

- 1 Repeat steps 1 to 4 in **Programme Setup**.
- 2 Press **◀/▶** to select "Yes", and then press **OK**.
- 3 Press **▲/▼/◀/▶** to select the channel you want to erase, and then press **OK**.
 - A message screen pops up.
- 4 Press **◀/▶** to select "Yes", and then press **OK** to erase the selected programme. All the subsequent programmes move up.
- 5 Repeat steps 3 and 4 until all desired channels are erased.

Menu operations

Child Lock

Allow you to use a PIN to protect certain settings from being accidentally changed.

Setting the PIN

- 1 Press **MENU** and the MENU screen displays.
- 2 Press **◀/▶** to select "Setup".
- 3 Press **▲/▼** to select "Child Lock", and then press **OK**.
- 4 If you already set the PIN, enter it here.
- 5 Press **▲/▼** to select "Change PIN", and then press **OK**.

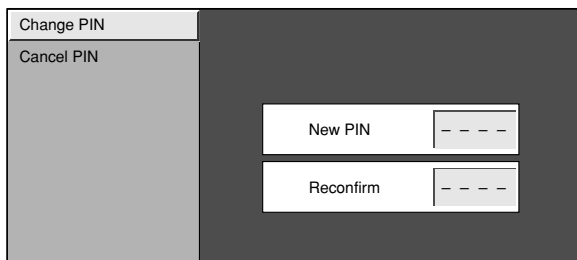

- 6 Enter the 4-digit number as a PIN using **0 – 9**.
- 7 Enter the same 4-digit number as in step 6 to confirm.
 - "The system PIN has been changed successfully" displays.

NOTE

- To view a locked channel (Lock setting in Programme Setup "Manual Adjust" is set to "On"), you must enter a PIN. (See page 13.) When you select a locked channel, a PIN prompt message pops up. Press **OK** to display the PIN input window.

Canceling the PIN

Allow you to reset your PIN.

- 1 Repeat steps 1 to 3 in **Setting the PIN**.
- 2 Enter the PIN.
- 3 Press **▲/▼** to select "Cancel PIN", and then press **OK**.
- 4 Press **◀/▶** to select "Yes", and then press **OK**.

NOTE

- **As a precautionary measure, make a note of your PIN on the back of this operation manual, cut it out and keep it in a safe place that children cannot reach. If you lose or forget your PIN, initialise the TV to return all settings except for the TV channel settings to factory preset values. (See page 18.)**

Input Label

You can assign each input source a label you like.

- 1 Press **↵** to select the desired input source.
- 2 Press **MENU** and the MENU screen displays.
- 3 Press **◀/▶** to select "Setup".
- 4 Press **▲/▼** to select "Input Label", and then press **OK**.
- 5 Press **▲/▼/◀/▶** to select each character of the new name for the input source, and then press **OK**.
- 6 Repeat step 5 above until the name is fully spelt out, and then press **OK**.
 - The name can be 6 characters or less.
 - If a label name is less than 6 characters, select "END", then press **OK**.

NOTE

- You cannot change the label if the input source is TV.

Position

For adjusting a picture's horizontal and vertical position.

- 1 Press **MENU** and the MENU screen displays.
- 2 Press **◀/▶** to select "Setup".
- 3 Press **▲/▼** to select "Position", and then press **OK**.
- 4 Press **▲/▼** to select "H-Pos." or "V-Pos.".
- 5 Press **◀/▶** to adjust the item to your desired position.

Item

H-Pos.: Centres the image by moving it to the left or right.
V-Pos.: Centres the image by moving it up or down.

NOTE

- **Adjustments are stored separately according to input source.**

WSS (Wide Screen Signalling)

Menu Operation: A (Page 9)

WSS allows a television to switch automatically among the different screen formats.

NOTE

- Try to set WIDE MODE if an image does not switch to the correct screen format. When the broadcast signal contains no WSS information, the function will not work even if enabled. (See page 16.)

Menu operations

4:3 Mode

Menu Operation: A (page 9)

The WSS signal has 4:3 auto-switching that allows you to select between Normal and Panorama.

Item

Normal: Normal range keeping 4:3 or 16:9 aspect ratio
Panorama: Wide image without side bars

WSS signal 4:3 screen

4:3 mode "Normal"



4:3 mode "Panorama"



Rotate

Menu Operation: A (page 9)

You can set the orientation of the picture.

[Normal] [Mirror] [Upside Down] [Rotate]

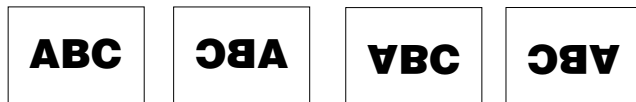

Language

Menu Operation: A (page 9)

You can select a language from the Setup menu. Select from among 13 languages. (Dutch, English, Finnish, French, German, Greek, Italian, Polish, Portuguese, Russian, Spanish, Swedish, Turkish)

Option menu

MENU [Option]

Option

Audio Only
 DNR [Off]
 Input Select [CVBS]
 Quick Shoot [On]
 Colour System [AUTO]
 Demo

NOTE

- The HDMI Setup menu is displayed only when "EXT4" is selected from the INPUT SOURCE menu.

Audio Only

Menu Operation: A (page 9)

When listening to music from a music programme, you can set the TV off and enjoy audio only.

Item

On: Audio is output without screen image.
Off: Both screen images and audio are output.

DNR (Digital Noise Reduction)

Menu Operation: A (page 9)

Produce a clear image. (Off, High, Low)

HDMI Setup

HDMI (High-Definition Multimedia Interface) terminal selection.

- To watch an HDMI equipment image, select "EXT4" from "INPUT SOURCE" menu using on the remote control unit or on the TV.
- Press **MENU** and the MENU screen displays.
- Press to select "Option".
- Press to select "HDMI Setup", and then press **OK**.

- The HDMI Setup menu is displayed only when "EXT4" is selected from the INPUT SOURCE menu.

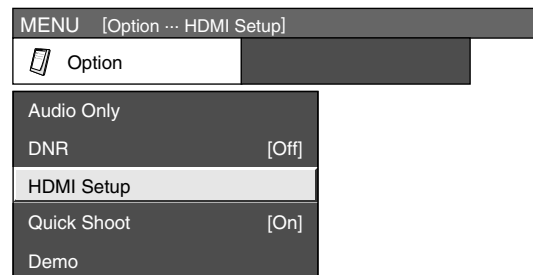

- Press to select the desired item or setting, and then press **OK**.

HDMI Setup items	Selectable items	Description
Signal Type*	RGB/YCbCr 4:4:4/ YCbCr 4:2:2	Select the video signal type from the HDMI terminal.
Colour Matrix*	ITU601/ITU709	Select the internal colour space conversion method when an RGB signal is input.
Dynamic Range*	Normal/ Enhanced	Select the signal amplitude range. Usually, select "Normal".
Auto View	Enable/Disable	Set whether or not to use WIDE MODE based on signal recognition, including an HDMI signal.
Audio Select	Digital/Analogue	Select "Digital" for audio signal via the HDMI terminal. Select "Analogue" for audio signal via the AUDIO jack.

NOTE

- Refer to your external equipment operation manual for the signal type.
- Items with * are greyed out (with) for HDMI connection.
- Items with * are selectable for DVI connection.

Menu operations

Input Select

Menu Operation: A (page 9)

For setting the signal type of external equipment.

Input source	Signal type
EXT 1	Y/C, CVBS, RGB
EXT 2	Y/C, CVBS, RGB
EXT 3	AUTO, COMPONENT (Y, P _B , P _R), S-Video (Y/C), Video (CVBS)

NOTE

- If no (colour) image displays, try to change the other signal type.
- Check the operation manual of the external equipment for the signal type.
- EXT4 is not displayed in Input Select.

Quick Shoot

Menu Operation: A (page 9)

Improve LCD response when viewing fast-moving images. The effect is greater at low room temperatures (at or below 15°C).

NOTE

- Quick Shoot may cause image noise. If this occurs, turn the function "Off".

Colour System

Menu Operation: A (page 9)

You can change the colour system to one that is compatible with the image on the screen. (AUTO, PAL, SECAM, NTSC 3.58, NTSC 4.43, PAL-60)

NOTE

- Factory preset value is "AUTO".
- If "AUTO" is selected, colour system for each channel is automatically set. If an image does not display clearly, select another colour system (e.g. PAL, NTSC 4.43).
- "NTSC 3.58" cannot be selected in TV tuner mode.

Demo

Demo shows some of the functions of the TV on the screen.

The demonstration items are as follows.

- Setting Demo to "On" or "Off".
- Selecting Input Source to use for Demo. (Demo, Skip [TV, EXT1, EXT2, EXT3, EXT4])
- Selecting Freeze setting for Demo. (On/Off)
- Selecting Menu setting for Demo. (On/Off)
- Selecting Teletext setting for Demo. (On/Off)
- Selecting Interval setting for Demo. (10 Sec., 15 Sec., 30 Sec.)
- The demo show can be activated from the option menu. After switching on this demo function, it takes 70 seconds approximately, before the TV-set starts the demo show. The selected functions are shown in a self-repeating sequence. Return to normal television-mode is possible only by deactivating the demo-function.

Useful features

WIDE MODE

You can select the picture size. Selectable picture size varies with the type of signal received.



Item (for SD (Standard) signal)

- Normal:** For 4:3 "standard" pictures. A side bar appears on each side.
- Zoom 14:9:** For 14:9 letterbox pictures. A thin side bar appears on each side, and you may see bars on the top and bottom with some programmes.
- Panorama:** In this mode the picture is progressively stretched toward each side of the screen.
- Full:** For 16:9 squeeze pictures.
- Cinema 16:9:** For 16:9 letterbox pictures. Bars may appear on the top and bottom with some programmes.
- Cinema 14:9:** For 14:9 letterbox pictures. Bars may appear on the top and bottom with some programmes.

Item (for HD (High-Definition) signal)

- Full:** Display with the Overscan image. Crop all sides of screen.
- Underscan 1:** Display with the Underscan image. Bars appear on the top and bottom of screen.
- Underscan 2:** Display with the Underscan image. No bars appear on all sides of screen.

Manual Selection

- 1 Press .
 - The WIDE MODE menu displays.
 - The menu lists the wide mode options selectable for the type of video signal currently received.
- 2 Press  or  while the WIDE MODE menu displays on the screen.
 - As you toggle down the options, each is immediately reflected on the screen. No need to press **OK**.

Auto Selection

If you set WSS and 4:3 Mode in the Setup menu on pages 14 and 15, the optimum WIDE MODE is automatically chosen for every broadcast, VCR or DVD containing the WSS information.

WSS menu

To enable Auto Selection, set WSS in the Setup menu to "On". (See page 14.)

4:3 Mode menu

To set the type of the wide screen, select "Normal" or "Panorama" in the 4:3 Mode menu. (See page 15.)

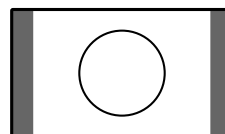

4:3 Mode set to "Normal"

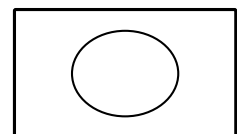

4:3 Mode set to "Panorama"



NOTE

- If the signal contains no WSS information, Auto Selection will not function even when the WSS option is enabled.

Useful features

Still image

You can freeze a motion picture on the screen.

- 1 Press .
- 2 Press  again to exit still image.

NOTE



- When this function is not available, "No still image display available." will display.
- The still image automatically goes out after 30 minutes.

Teletext function

What is Teletext?

Teletext broadcasts pages of information and entertainment to specially equipped television sets. Your TV receives Teletext signals broadcast by a TV network, and decodes them into graphical format for viewing. News, weather and sports information, stock exchange prices and programme previews are among the many services available.

Turning on and off Teletext



- 1 Select a TV channel or external input source providing the Teletext programme.
- 2 Press  to display the Teletext.
- 3 Press  again to display the Teletext on the right screen and normal image on the left screen.
 - Each time you press , the screen switches as shown below.



- If you select a programme with no Teletext signal, "No Teletext available." displays.
- The same message displays during other modes if no Teletext signal is available.

Time display





You can display the time information included in the Teletext broadcasts.

- 1 Select a TV channel providing Teletext information. (The time information is automatically captured.)
- 2 Press . The channel display will appear on the TV.
- 3 Press  again within the three-second interval the channel display is on the screen. Time information will display on the lower left of the screen for about three seconds.
- 4 Even when you change the TV channel, you can display the time information with steps 2 and 3 above.

NOTE

- The time display cannot be stored once the power is turned off. When you turn on the power, perform steps 1 to 4 again.
- If acquired successfully, the time information will appear in the upper-right corner of the screen by pressing **MENU**.

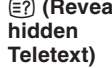
Button functions

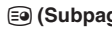
Buttons	Description
P ()	Increase or decrease the page number.
Colour (Red/Green/Yellow/Blue)	Select a group or block of pages displayed in the coloured brackets at the bottom of the screen by pressing the corresponding Colour (Red/Green/Yellow/Blue) on the remote control unit.
0-9	Directly select any page from 100 to 899 by using 0-9.
 (WIDE MODE)	Switch the Teletext image to Full, Upper half or Lower half.
 (Reveal hidden Teletext)	Reveal or hide hidden information such as an answer to a quiz.
 (Freeze/ Hold)	Stop updating Teletext pages automatically or release the hold mode.
 (Subtitle for Teletext)	Display the subtitle or exit the subtitle screen. <ul style="list-style-type: none"> • Subtitle will not be displayed when the service does not contain the subtitle information.
 (Subpage)	Reveal or hide subpages. <ul style="list-style-type: none"> • Red button: Move to the previous subpage. • Green button: Move to the following subpage. • These two buttons are shown on the screen by the signs - and +.

Appendix

Troubleshooting

Problem	Possible Solution
<ul style="list-style-type: none"> No power. 	<ul style="list-style-type: none"> Check if you pressed ⏻ on the remote control unit. (See page 8.) If the indicator on the TV lights up red, press ⏻ . Is the AC cord disconnected? (See page 3.) Has the power been turned on? (See page 8.)
<ul style="list-style-type: none"> Unit cannot be operated. 	<ul style="list-style-type: none"> External influences such as lightning, static electricity, etc., may cause improper operation. In this case, operate the unit after first turning the power off, or unplugging the AC cord and re-plugging it in after 1 or 2 minutes.
<ul style="list-style-type: none"> Remote control unit does not operate. 	<ul style="list-style-type: none"> Are batteries inserted with polarity (+, -) aligned? (See page 4.) Are batteries worn out? (Replace with new batteries.) Are you using it under strong or fluorescent lighting? Is a fluorescent light illuminated to remote control sensor?
<ul style="list-style-type: none"> Picture is cut off. 	<ul style="list-style-type: none"> Is the image position correct? (See page 14.) Are screen mode adjustments (4:3 Mode/WSS) such as picture size made correctly? (See pages 14 to 16.)
<ul style="list-style-type: none"> Strange colour, light colour, or dark, or colour misalignment. 	<ul style="list-style-type: none"> Adjust the picture tone. (See pages 10 and 11.) Is the room too bright? The picture may look dark in a room that is too bright. Check the colour system setting. (See pages 13 and 16.) Check the input signal setting or HDMI setting. (See pages 15 and 16.)
<ul style="list-style-type: none"> Power is suddenly turned off. 	<ul style="list-style-type: none"> The unit's internal temperature has increased. Remove any objects blocking vent or clean. Check the power control setting. (See page 12.) Is sleep timer set? Press SLEEP on the remote control unit until it sets to Off.
<ul style="list-style-type: none"> No picture. 	<ul style="list-style-type: none"> Is connection to other components correct? (See page 7.) Is input signal type selected correctly after connection? (See page 16.) Is the correct input source selected? (See page 7.) Is picture adjustment correct? (See pages 10 and 11.) Is the antenna connected properly? (See page 3.) Is "On" selected in "Audio Only"? (See page 15.)
<ul style="list-style-type: none"> No sound. 	<ul style="list-style-type: none"> Is the volume too low? (See page 5 and 6.) Make sure that headphones are not connected. (See page 6.)

HOW TO SET THE FACTORY PRESETS

Turn off the TV by pressing **⏻**. Press and hold down **RESET** and press **⏻** on the TV to turn it on. All setting items (except TV channel) return to the factory presetting.

You can run the Auto Installation again by using the following steps.

- 1 Turn on the power of the TV.
- 2 Press **MENU**. (Make sure the menu screen displays.)
- 3 Press **◀/▶** to select "Setup".
- 4 Press **▲/▼** to select "Auto Installation", and then press **OK**.
- 5 Press **◀/▶** to select "Yes", and then press **OK**.

About RESET and SYSTEM RESET

Press **RESET** if the TV cannot return to its original state after performing various operations.

- AV Mode resets to USER.
- Analogue TV channel resets to channel 1.
- Audio setting initialises.
- Surround resets to Off.
- Image position initialises.

NOTE

- Pressing **RESET** will not work if the TV is in standby mode (indicator lights red).
- Pressing **RESET** will not delete channel preset and PIN. See page 14 for resetting the PIN when you know it. See above for initialising to the factory preset values when you forget your PIN.

Press **SYSTEM RESET** if the TV does not operate after starting up.

Specifications

Item		26" LCD COLOUR TV, Model: LC-26P50E	32" LCD COLOUR TV, Model: LC-32P50E	37" LCD COLOUR TV, Model: LC-37P50E
LCD panel		26" Advanced Super View & BLACK TFT LCD	32" Advanced Super View & BLACK TFT LCD	37" Advanced Super View & BLACK TFT LCD
Number of dots		1,555,200 dots (960 × 540 × 3 dots)		
Video Colour System		PAL/SECAM/NTSC 3.58/NTSC 4.43/PAL 60		
TV Function	TV-Standard (CCIR)	B/G, I, D/K, L, L'		
	Receiving Channel	VHF/UHF	E2-E69ch, F2-F10ch, I21-I69ch, IR A-IR Jch	
		CATV	Hyper-band, S1-S41ch	
	TV-Tuning System	Auto Preset 99 ch, Auto Label, Auto Sort		
STEREO/BILINGUAL		NICAM/A2		
Brightness		450 cd/m ²		
Backlight life		60,000 hours (at Backlight Standard position)		
Viewing angles		H : 170° V : 170°		
Audio amplifier		10W × 2		
Speaker		Ø 8 cm 2pcs		
Terminals	Rear	Antenna input	UHF/VHF 75Ω Din type	
		EXT 1	SCART (AV input, Y/C input, RGB input, TV output)	
		EXT 2	SCART (AV input/output, Y/C input, RGB input, AV Link)	
		EXT 3	RCA pin (Component input), S-VIDEO (Y/C input), RCA pin (AV input)	
		EXT 4	HDMI, Ø 3.5 mm jack (Audio input)	
		AUDIO OUTPUT	RCA pin	
		Headphones	Ø 3.5mm jack (Audio output)	
OSD language		English/German/French/Italian/Spanish/Dutch/Swedish/Portuguese/Finnish/Turkish/Greek/Russian/Polish		
Power Requirement		AC 220-240 V, 50 Hz		
Power Consumption		110 W (0.8 W Standby) (Method IEC60107)	142 W (0.8 W Standby) (Method IEC60107)	163 W (0.8 W Standby) (Method IEC60107)
Weight		12 kg (Display only), 15.5 kg (Display with stand)	16 kg (Display only), 20 kg (Display with stand)	19.5 kg (Display only), 25 kg (Display with stand)

- As a part of policy of continuous improvement, SHARP reserves the right to make design and specification changes for product improvement without prior notice. The performance specification figures indicated are nominal values of production units. There may be some deviations from these values in individual units.

NOTE

- Refer to inside back cover for dimensional drawings.

Cautions regarding use in high and low temperature environments

- When the unit is used in a low temperature space (e.g. room, office), the picture may leave trails or appear slightly delayed. This is not a malfunction, and the unit will recover when the temperature returns to normal.
 - Do not leave the unit in a hot or cold location. Also, do not leave the unit in a location exposed to direct sunlight or near a heater, as this may cause the cabinet to deform and the LCD panel to malfunction.
- Storage temperature: -20°C to +60°C.

The Consumer Electronics Industry has initiated a commitment to improve the energy efficiency of TVs. SHARP has signed this commitment and as a result this TV may have a label on the front of the product informing the customer of the energy consumption in various operating modes.

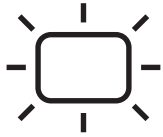

“ON” - The energy consumption (W) of the set when operating with picture and sound (measured according to IEC 62087:2002)



“Standby” The energy consumption (W) of the set when in standby, no picture or sound (measured according to IEC 62087:2002)



An estimated annual energy consumption (kWh) based on a duty cycle of 4 hours “on” and 20 hours in “standby” for 365 days

Note: The IEC 62087:2002 measurement standard sets brightness and sound levels that may not be the same as the TV in “shipped” condition. Therefore the power consumption as measured at “on” is purely indicative and may not be the same value as in the “shipped” condition.

A. Information on Disposal for Users (private households)



Attention: Your product is marked with this symbol. It means that used electrical and electronic products should not be mixed with general household waste. There is a separate collection system for these products.

1. In the European Union

Attention: If you want to dispose of this equipment, please do not use the ordinary dust bin!

Used electrical and electronic equipment must be treated separately and in accordance with legislation that requires proper treatment, recovery and recycling of used electrical and electronic equipment. Following the implementation by member states, private households within the EU states may return their used electrical and electronic equipment to designated collection facilities free of charge*. In some countries* your local retailer may also take back your old product free of charge if you purchase a similar new one.
*) Please contact your local authority for further details.

If your used electrical or electronic equipment has batteries or accumulators, please dispose of these separately beforehand according to local requirements.

By disposing of this product correctly you will help ensure that the waste undergoes the necessary treatment, recovery and recycling and thus prevent potential negative effects on the environment and human health which could otherwise arise due to inappropriate waste handling.

2. In other Countries outside the EU

If you wish to discard this product, please contact your local authorities and ask for the correct method of disposal.

For Switzerland: Used electrical or electronic equipment can be returned free of charge to the dealer, even if you don't purchase a new product. Further collection facilities are listed on the homepage of www.swico.ch or www.sens.ch.

B. Information on Disposal for Business Users

1. In the European Union

If the product is used for business purposes and you want to discard it:

Please contact your SHARP dealer who will inform you about the take-back of the product. You might be charged for the costs arising from take-back and recycling. Small products (and small amounts) might be taken back by your local collection facilities.

For Spain: Please contact the established collection system or your local authority for take-back of your used products.

2. In other Countries outside the EU

If you wish to discard of this product, please contact your local authorities and ask for the correct method of disposal.

LC-26/32/37P50E

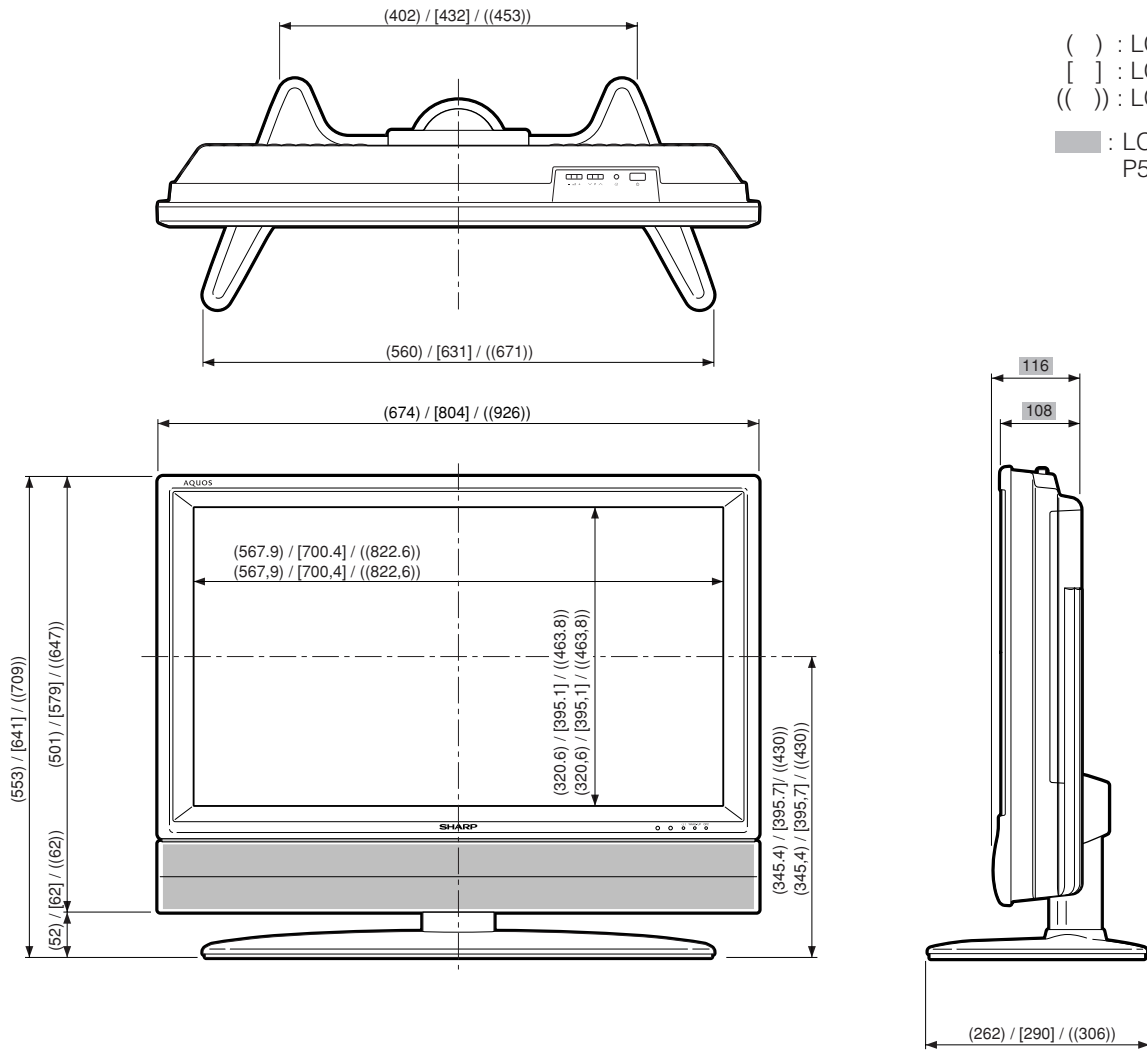

() : LC-26P50E
 [] : LC-32P50E
 (()) : LC-37P50E
 ■ : LC-26/32/37 P50E

LC-26P50E

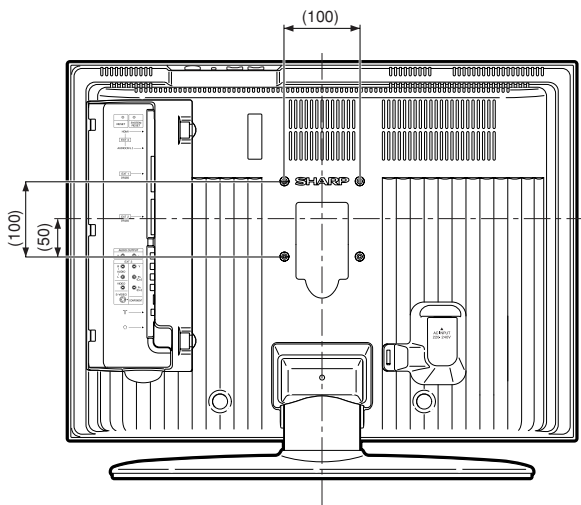

LC-32/37P50E

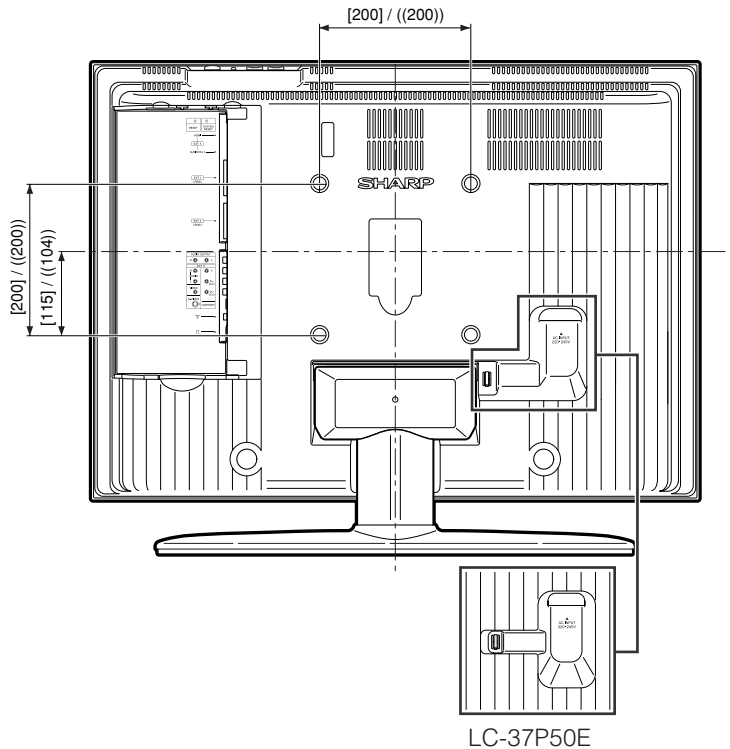

LC-37P50E

SHARP®

SHARP CORPORATION

Printed on environmentally friendly paper
Auf ökologischem Papier gedruckt
Imprimé sur papier écologique
Stampato su carta ecologica
Afgedrukt op ecologisch papier
Impreso en papel ecológico



Printed in Spain
Gedruckt in Spanien
Imprimé en Espagne
Stampato in Spagna
Gedruckt in Spanje
Impreso en España

TINS-B845WJZZ
05P06-SP-NG

PIN

--	--	--	--