

# LC-26DV20U

## COMBINATION LIQUID CRYSTAL TELEVISION AND DVD/CD PLAYER

### OPERATION MANUAL

- The illustrations and on-screen displays in this operation manual are for explanation purposes and may vary slightly from the actual operations.
- Menu items that are not selectable are grayed out.

#### IMPORTANT:

To aid reporting in case of loss or theft, please record the TV/DVD's model and serial numbers in the space provided. The numbers are located at the rear of the TV/DVD.

Model No.:

Serial No.:

## IMPORTANT INFORMATION

**WARNING:** TO REDUCE THE RISK OF FIRE OR ELECTRIC SHOCK, DO NOT EXPOSE THIS PRODUCT TO RAIN OR MOISTURE.



#### CAUTION

RISK OF ELECTRIC SHOCK  
DO NOT OPEN



CAUTION: TO REDUCE THE RISK OF ELECTRIC SHOCK,  
DO NOT REMOVE COVER (OR BACK).  
NO USER-SERVICEABLE PARTS INSIDE.  
REFER SERVICING TO QUALIFIED SERVICE  
PERSONNEL.



The lightning flash with arrow-head symbol, within an equilateral triangle, is intended to alert the user to the presence of uninsulated "dangerous voltage" within the product's enclosure that may be of sufficient magnitude to constitute a risk of electric shock to persons.



The exclamation point within a triangle is intended to alert the user to the presence of important operating and maintenance (servicing) instructions in the literature accompanying the product.

# IMPORTANT INFORMATION

**CAUTION:** TO PREVENT ELECTRIC SHOCK, MATCH WIDE BLADE OF PLUG TO WIDE SLOT, FULLY INSERT.

**CAUTION:**

DO NOT PLACE THIS PRODUCT ON AN UNSTABLE CART, STAND, TRIPOD, BRACKET, OR TABLE. THE PRODUCT MAY FALL CAUSING SERIOUS PERSONAL INJURY AND SERIOUS DAMAGE TO THE PRODUCT. USE ONLY WITH A CART, STAND, TRIPOD, BRACKET, OR TABLE RECOMMENDED BY THE MANUFACTURER OR SOLD WITH THE PRODUCT. FOLLOW THE MANUFACTURER'S INSTRUCTIONS WHEN INSTALLING THE PRODUCT AND USE MOUNTING ACCESSORIES RECOMMENDED BY THE MANUFACTURER. A PRODUCT AND CART COMBINATION SHOULD BE MOVED WITH CARE. QUICK STOPS, EXCESSIVE FORCE, AND UNEVEN SURFACES MAY CAUSE THE PRODUCT AND CART COMBINATION TO OVERTURN.



**WARNING:** FCC Regulations state that any unauthorized changes or modifications to this equipment not expressly approved by the manufacturer could void the user's authority to operate this equipment.

**CAUTION:**

This product satisfies FCC regulations when shielded cables and connectors are used to connect the unit to other equipment. To prevent electromagnetic interference with electric appliances such as radios and televisions, use shielded cables and connectors for connections.

"Note to CATV system installer: This reminder is provided to call the CATV system installer's attention to Article 820-40 of the National Electrical Code that provides guidelines for proper grounding and, in particular, specifies that the cable ground shall be connected to the grounding system of the building, as close to the point of cable entry as practical."

This product utilizes tin-lead solder, and fluorescent lamp containing a small amount of mercury. Disposal of these materials may be regulated due to environmental considerations. For disposal or recycling information, please contact your local authorities or the Electronic Industries Alliance: [www.eia.org](http://www.eia.org)

**CAUTION:**

THIS DIGITAL VIDEO PLAYER EMPLOYS A LASER SYSTEM.  
TO ENSURE PROPER USE OF THIS PRODUCT, PLEASE READ THIS USER'S GUIDE CAREFULLY AND RETAIN FOR FUTURE REFERENCE. SHOULD THE UNIT REQUIRE MAINTENANCE, CONTACT AN AUTHORIZED SERVICE LOCATION SEE SERVICE PROCEDURE.  
USE OF CONTROLS, ADJUSTMENTS OR THE PERFORMANCE OF PROCEDURES OTHER THAN THOSE SPECIFIED HEREIN MAY RESULT IN HAZARDOUS RADIATION EXPOSURE.  
TO PREVENT DIRECT EXPOSURE TO LASER BEAM, DO NOT TRY TO OPEN THE ENCLOSURE. VISIBLE LASER RADIATION MAY BE PRESENT WHEN THE ENCLOSURE IS OPENED. DO NOT STARE INTO BEAM.

## Trademarks

• Manufactured under license from Dolby Laboratories. "Dolby" and the double-D symbol are trademarks of Dolby Laboratories.

• "HDMI, the HDMI logo and High-Definition Multimedia Interface are trademarks or registered trademarks of HDMI Licensing LLC."

• WOW, SRS and (●) symbol are trademarks of SRS Labs, Inc.  
WOW technology is incorporated under license from SRS Labs, Inc.

• "DTS" and "DTS Digital Out" are trademarks of Digital Theater Systems, Inc.

# DEAR SHARP CUSTOMER

Thank you for your purchase of the Sharp Combination Liquid Crystal Television and DVD/CD Player. To ensure safety and many years of trouble-free operation of your product, please read the Important Safety Instructions carefully before using this product.

## IMPORTANT SAFETY INSTRUCTIONS

Electricity is used to perform many useful functions, but it can also cause personal injuries and property damage if improperly handled. This product has been engineered and manufactured with the highest priority on safety. However, improper use can result in electric shock and/or fire. In order to prevent potential danger, please observe the following instructions when installing, operating and cleaning the product. To ensure your safety and prolong the service life of your Combination Liquid Crystal Television and DVD/CD Player, please read the following precautions carefully before using the product.

- 1) Read these instructions.
- 2) Keep these instructions.
- 3) Heed all warnings.
- 4) Follow all instructions.
- 5) Do not use this apparatus near water.
- 6) Clean only with dry cloth.
- 7) Do not block any ventilation openings. Install in accordance with the manufacturer's instructions.
- 8) Do not install near any heat sources such as radiators, heat registers, stoves, or other apparatus (including amplifiers) that produce heat.
- 9) Do not defeat the safety purpose of the polarized or grounding-type plug. A polarized plug has two blades with one wider than the other. A grounding type plug has two blades and a third grounding prong. The wide blade or the third prong are provided for your safety. If the provided plug does not fit into your outlet, consult an electrician for replacement of the obsolete outlet.
- 10) Protect the power cord from being walked on or pinched particularly at plugs, convenience receptacles, and the point where they exit from the apparatus.
- 11) Only use attachments/accessories specified by the manufacturer.
- 12) Use only with the cart, stand, tripod, bracket, or table specified by the manufacturer, or sold with the apparatus. When a cart is used, use caution when moving the cart/apparatus combination to avoid injury from tip-over.
- 13) Unplug this apparatus during lightning storms or when unused for long periods of time.
- 14) Refer all servicing to qualified service personnel. Servicing is required when the apparatus has been damaged in any way, such as power-supply cord or plug is damaged, liquid has been spilled or objects have fallen into the apparatus, the apparatus has been exposed to rain or moisture, does not operate normally, or has been dropped.



### Additional Safety Information

- 15) Power Sources—This product should be operated only from the type of power source indicated on the marking label. If you are not sure of the type of power supply to your home, consult your product dealer or local power company. For products intended to operate from battery power, or other sources, refer to the operating instructions.
- 16) Overloading—Do not overload wall outlets, extension cords, or integral convenience receptacles as this can result in a risk of fire or electric shock.
- 17) Object and Liquid Entry—Never push objects of any kind into this product through openings as they may touch dangerous voltage points or short-out parts that could result in a fire or electric shock. Never spill liquid of any kind on the product.
- 18) Damage Requiring Service—Unplug this product from the wall outlet and refer servicing to qualified service personnel under the following conditions:
  - a) When the AC cord or plug is damaged,
  - b) If liquid has been spilled, or objects have fallen into the product,
  - c) If the product has been exposed to rain or water,
  - d) If the product does not operate normally by following the operating instructions.  
Adjust only those controls that are covered by the operating instructions as an improper adjustment of other controls may result in damage and will often require extensive work by a qualified technician to restore the product to its normal operation,
  - e) If the product has been dropped or damaged in any way, and
  - f) When the product exhibits a distinct change in performance - this indicates a need for service.
- 19) Replacement Parts—When replacement parts are required, be sure the service technician has used replacement parts specified by the manufacturer or have the same characteristics as the original part. Unauthorized substitutions may result in fire, electric shock, or other hazards.
- 20) Safety Check—Upon completion of any service or repairs to this product, ask the service technician to perform safety checks to determine that the product is in proper operating condition.
- 21) Wall or ceiling mounting—When mounting the product on a wall or ceiling, be sure to install the product according to the method recommended by the manufacturer.

# IMPORTANT SAFETY INSTRUCTIONS

- **Water and Moisture** — Do not use this product near water - for example, near a bath tub, wash bowl, kitchen sink, or laundry tub; in a wet basement; or near a swimming pool; and the like.

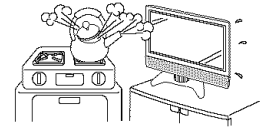

- **Stand** — Do not place the product on an unstable cart, stand, tripod or table. Placing the product on an unstable base can cause the product to fall, resulting in serious personal injuries as well as damage to the product. Use only a cart, stand, tripod, bracket or table recommended by the manufacturer or sold with the product. When mounting the product on a wall, be sure to follow the manufacturer's instructions. Use only the mounting hardware recommended by the manufacturer.



- **Selecting the location** — Select a place with no direct sunlight and good ventilation.

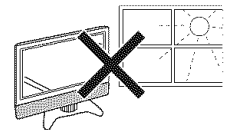

- **Ventilation** — The vents and other openings in the cabinet are designed for ventilation. Do not cover or block these vents and openings since insufficient ventilation can cause overheating and/or shorten the life of the product. Do not place the product on a bed, sofa, rug or other similar surface, since they can block ventilation openings. This product is not designed for built-in installation; do not place the product in an enclosed place such as a bookcase or rack, unless proper ventilation is provided or the manufacturer's instructions are followed.

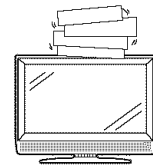

- **The Liquid Crystal panel** used in this product is made of glass. Therefore, it can break when the product is dropped or applied with impact. Be careful not to be injured by broken glass pieces in case the panel breaks.

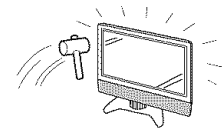

- **Heat** — The product should be situated away from heat sources such as radiators, heat registers, stoves, or other products (including amplifiers) that produce heat.

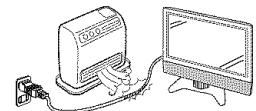

- The Liquid Crystal panel is a very high technology product with 3,147,264 thin film transistors, giving you fine picture details. Occasionally, a few non-active pixels may appear on the screen as a fixed point of blue, green or red. Please note that this does not affect the performance of your product.

## Precautions when transporting the product

- When transporting the product, never carry it by holding onto the speaker. Be sure to always carry the product by two people holding it with two hands — one hand on each side of the product.

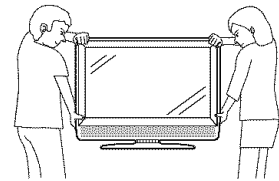

- **Lightning** — For added protection for this television equipment during a lightning storm, or when it is left unattended and unused for long periods of time, unplug it from the wall outlet and disconnect the antenna. This will prevent damage to the equipment due to lightning and power-line surges.

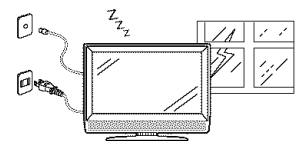

- **Power Lines** — An outside antenna system should not be located in the vicinity of overhead power lines or other electric light or power circuits, or where it can fall into such power lines or circuits. When installing an outside antenna system, extreme care should be taken to keep from touching such power lines or circuits as contact with them might be fatal.

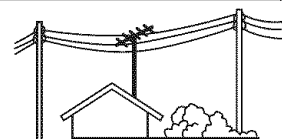



# IMPORTANT SAFETY INSTRUCTIONS

- **Outdoor Antenna Grounding** — If an outside antenna is connected to the television equipment, be sure the antenna system is grounded so as to provide some protection against voltage surges and built-up static charges. Article 810 of the National Electrical Code, ANSI/NFPA 70, provides information with regard to proper grounding of the mast and supporting structure, grounding of the lead-in wire to an antenna discharge unit, size of grounding conductors, location of antenna-discharge unit, connection to grounding electrodes, and requirements for the grounding electrode.

EXAMPLE OF ANTENNA GROUNDING AS PER NATIONAL ELECTRICAL CODE, ANSI/NFPA 70

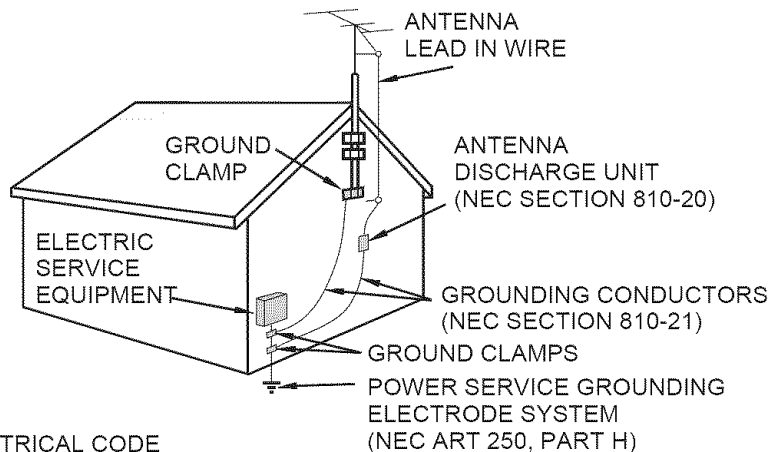

NEC — NATIONAL ELECTRICAL CODE

- To prevent fire, never place any type of candle or flames on the top or near the product.

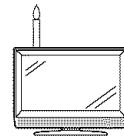

- To prevent fire or shock hazard, do not expose this product to dripping or splashing. No objects filled with liquids, such as vases, should be placed on the product.

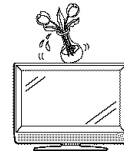

- To prevent fire or shock hazard, do not place the AC cord under the product or other heavy items.

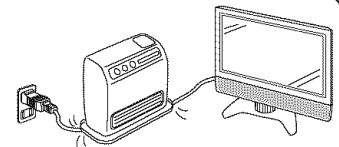

- Turn off the main power and unplug the AC cord from the wall outlet before handling.
- Use a soft cloth and gently wipe the surface of the display panel. Using a hard cloth may scratch the panel surface.
- Use a soft damp cloth to gently wipe the panel when it is really dirty. (It may scratch the panel surface when wiped strongly.)
- If the panel is dusty, use an anti-static brush, which is commercially available, to clean it.
- To protect the panel, do not use a dirty cloth, liquid cleaners or chemical cloth to clean it, such materials may damage the panel surface.

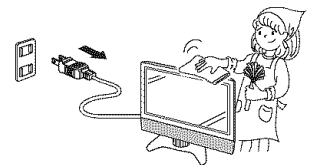

- Do not display a still picture for a long time, as this could cause an afterimage to remain.

- **CONDENSATION:** Moisture will form in the operating section of the player if the player is brought from cool surroundings into a warm room or if the temperature of the room rises suddenly. When this happens, player's performance will be impaired. To prevent this, let the player stand in its new surroundings for about an hour before switching it on, or make sure that the room temperature rises gradually. Condensation may also form during the summer if the player is exposed to the breeze from an air conditioner. In such cases, change the location of the player.
- **DISC SLOT:** Keep your fingers well clear of the disc slot as it is closing. Failure to do so may cause serious personal injury.
- **LASER BEAM:** Do not look into the opening of the disc slot or ventilation opening of the product to see the source of the laser beam. Doing so may cause sight damage.
- **DISC:** Do not use a cracked, deformed, or repaired disc. These discs are easily broken and may cause serious personal injury and product malfunction.

# Disc

## Discs which can be played back

In this unit, use only discs that meet the standard, such as those bearing the below logo marks on the disc label surface. If you use a non-standard disc, we cannot guarantee playback. Even if such a disc can be played back, we cannot guarantee the image or sound quality. The DVD logo is a registered trademark.

Media type	Logo mark
DVD-Video	
DVD-R/RW (Video format only)	
Audio CD*	
CD-R/CD-RW (CD-DA, MP3, WMA or JPEG format)	

- This unit is designed to playback music Compact Discs (CD) that conform to the CD standard. CDs that contain (copy-restriction) signals to protect copyrights cannot be played back.
- Some CD-R/RWs and DVD-R/RW can not be played back depending on the recording conditions.
- 8 cm discs can be played without an adapter.

### Region management information

This unit is designed and manufactured to support the region management information that is recorded on a DVD disc. If the region number written on the DVD disc does not correspond to the region number of this unit, this unit cannot play that disc.

- The region number of this unit is "1".
- The unit will play DVD-Video discs marked with labels containing "1" or "ALL".

Example:



### Operating DVD-Video

- Some operations of DVD-Video may be prohibited by the manufacturer, or some operation methods or functions of the DVD-Video may be different from the description in this manual.
- If you attempt an operation that is prohibited by either the disc or the unit, a "⏸" mark will appear on the TV screen. For operations prohibited by the disc, see the information that came with the disc.
- When the menu screen or the operation guide appears during disc playback, follow the displayed information.

## Discs which cannot be played back

The discs listed below cannot be played back in general. Even if one of these can be played back, it may not be played back correctly. If a disc is played back by mistake, extensively loud sounds may blow the speakers or may damage the hearing of those in hearing range. Do not playback the discs listed below.

CDG, Photo-CD, CD-ROM, CD-TEXT, CD-EXTRA, SACD, PD, DVD-ROM, SVCD, CVD, VCD, DVD-RAM, DVD+R/RW, DVD audio, etc.

The following DVD-Video discs may not be played back on this unit:

- DVD-Video that do not have the region number "1" or "ALL".
- PAL or SECAM DVD-Video.
- Prohibited or business-use DVD-Video.

CD-R/CD-RWs cannot be played back for the following reasons.

- Compatibility of the disc and this unit.
- Compatibility of the disc and the recorder used.
- Unfinalised discs.

Never use the following discs or accessories. It may cause serious damage to the TV/DVD.

- Irregular shaped discs such as card shaped, heart shaped
- The ring protector or other disc accessories
- The 8cm disc adapter
- Stickered or papered discs
- Discs with scotch tape, glue or other remains of labels

## Title/Chapter/Track

A DVD-Video has large partitions called "Titles", and smaller partitions within them called "Chapters".

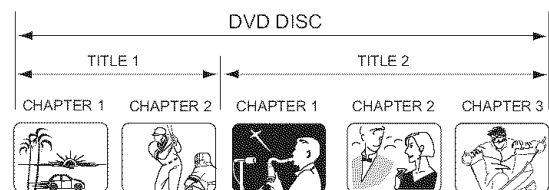

An audio CD has other partitions called "Tracks". A number is allotted to each partition and these numbers are called "title numbers", "chapter numbers" or "track numbers".



## Disc

### Handling discs

#### Removing the Disc from its case

Be sure to hold the edge of disc. Do not touch the surface of the disc.

Pick up the disc gently from the case.

- Do not scratch the disc.
- Do not get dirt on the surface of the disc.
- Do not stick a label or adhesive tape on the disc.
- Do not drop or bend the disc.



#### Storing discs

- Store the disc in the case to avoid any risk of scratches, dirt or damage.
- Do not leave the disc exposed to direct sunlight or in hot or humid places.

#### Cleaning discs

Wipe the disc with a clean, dry cloth from the center outward toward the edges.

- Do not wipe the disc in a circular motion around the center.
- Do not use liquid or aerosol cleaners.

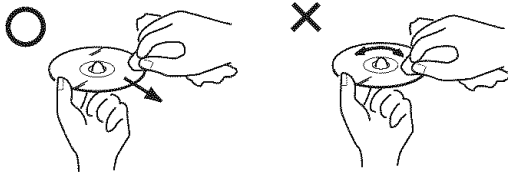





#### Notes on copyright

- This product incorporates copyright protection technology that is protected by U.S. patents and other intellectual property rights. Use of this copyright protection technology must be authorized by Macrovision, and is intended for home and other limited viewing uses only unless otherwise authorized by Macrovision. Reverse engineering or disassembly is prohibited.
- Unauthorized recording of copyrighted television programs, films, video cassettes and other materials may infringe the rights of copyright owners and be contrary to copyright laws.

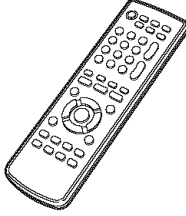
# Supplied accessories

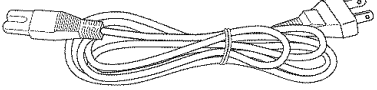
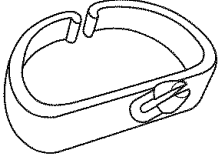
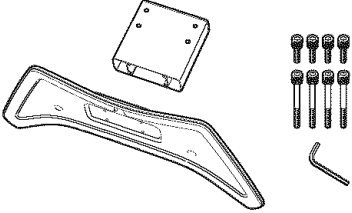
Make sure the following accessories are provided with the product.

Remote control unit (X1)	"AA" size battery (X2)	AC cord (X1)
 Page 10	 Page 10	 Page 9
Cable Clamp (X1)	Stand unit (X1)	Operation manual (X1)
 Page 9	 Page 8	

## NOTE

- Always use the AC cord supplied with the TV/DVD.

# QUICK REFERENCE

## Attaching the stand

- Before attaching (or detaching) stand, unplug the AC cord from the AC input terminal.
- Before performing work spread cushioning over the base area to lay the TV/DVD on. This will prevent it from being damaged.

## CAUTION

- Attach the stand in the correct direction.
- The "REAR" label should be visible from the back of the TV/DVD.
- Incorrect installation of the stand may result in the TV/DVD falling over.
- Be sure to follow the instructions.

1. Confirm the 8 screws supplied with the TV/DVD.

**Short screws (X4)**  
(used in step 2)



**Long screws (X4)**  
(used in step 3)

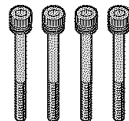

2. Attach the two parts of the stand unit to each other using the 4 short screws and the hex key (supplied with the product) as shown.

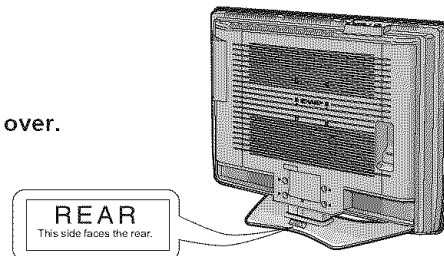
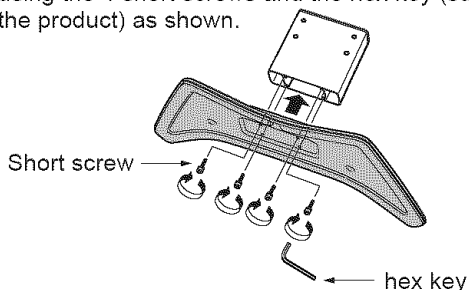

3.

- ① Insert the stand into the opening on the bottom of the TV/DVD.
- ② Insert and tighten the 4 long screws into the 4 holes on the rear of the TV/DVD.

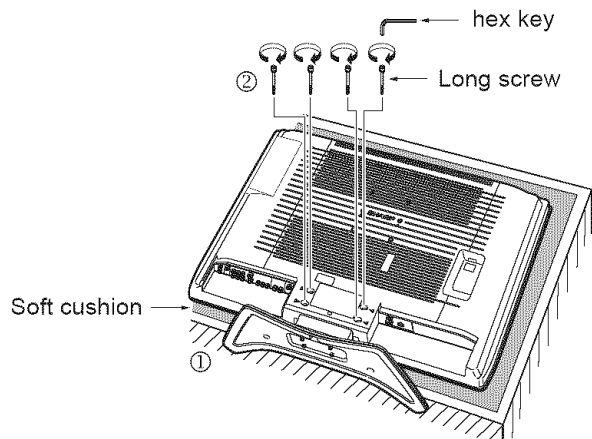

## NOTE

## QUICK REFERENCE

### STOP! To safely remove the TV/DVD from the box

It's best to use 2 people to remove the television for stability.

1. Use the cardboard holders on either side of the television to remove it from the box.
2. Remove the cardboard; however, keep the wrapping on the television to protect it while moving.
3. Lift onto installation location as the diagram illustrates.

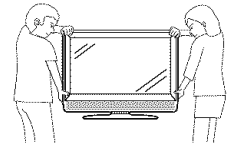

### Ventilation & Cleaning Tips

Keep your TV/DVD in a well ventilated area and make sure not to place it by a heat source or use near water. The TV/DVD is designed for AC use only and should be used with supplied AC cord.

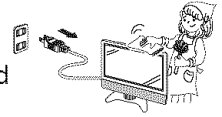

Clean the screen by spraying a soft lint free cloth with water to lightly moisten. Gently wipe and avoid pressing on the screen. To clean the outer cabinet, use the same method. Do not use liquid or aerosol cleaners.

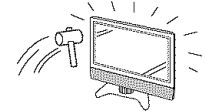

The screen is glass and can be scratched or broken when dropped or impacted.

### QUICK INSTALLATION TIPS

1. Attach your antenna to the back of the TV/DVD.  
(See page 15.)

2. Connect the AC plug for the TV/DVD into the wall outlet.

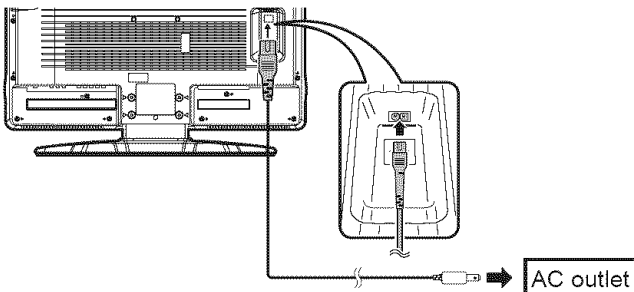

- Place the TV/DVD close to the AC outlet, and keep the power plug within reach.

#### NOTE

- TO PREVENT RISK OF ELECTRIC SHOCK, DO NOT TOUCH UN-INSULATED PARTS OF ANY CABLES WITH THE AC CORD CONNECTED.

3. Bundle the cords properly with a cable clamp.

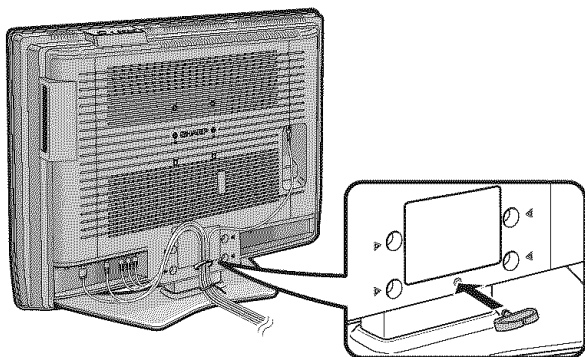

4. How to turn on the TV/DVD for the first time.  
A) Press **POWER** on TV/DVD.

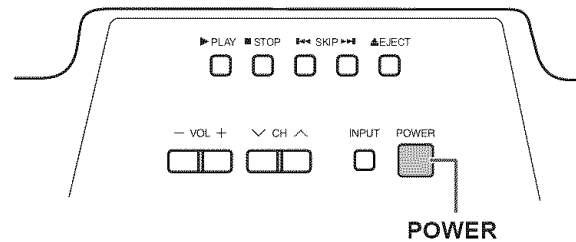

- B) POWER indicator on the front of the TV/DVD lights GREEN.

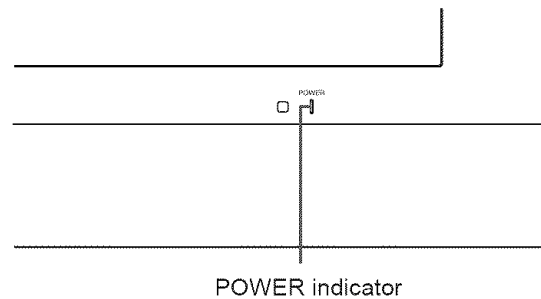

#### NOTE

- Speaker cannot be detached from the TV/DVD.
- TV/DVD angle cannot be adjusted.

## QUICK REFERENCE

If the remote control fails to operate TV/DVD functions, replace the batteries in the remote control unit.

1 Open the battery cover.

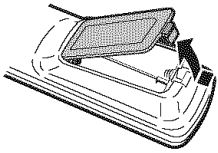

2 Insert two "AA" size batteries (supplied with the product).

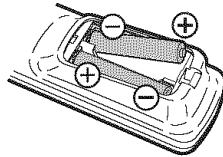

3 Close the battery cover.

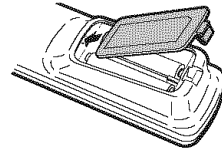

- Place the batteries with their terminals corresponding to the (+) and (-) indications in the battery compartment.

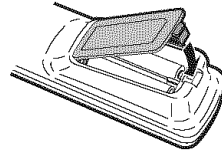

### NOTE

Improper use of batteries can result in chemical leakage or explosion. Be sure to follow the instructions below.

- Do not mix batteries of different types. Different types of batteries have different characteristics.
- Do not mix old and new batteries. Mixing old and new batteries can shorten the life of new batteries or cause chemical leakage in old batteries.
- Remove batteries as soon as they are worn out. Chemicals that leak from batteries that come in contact with skin can cause a rash. If you find any chemical leakage, wipe thoroughly with a cloth.
- The batteries supplied with this product may have a shorter life expectancy due to storage conditions.
- If you will not be using the remote control unit for an extended period of time, remove batteries from it.

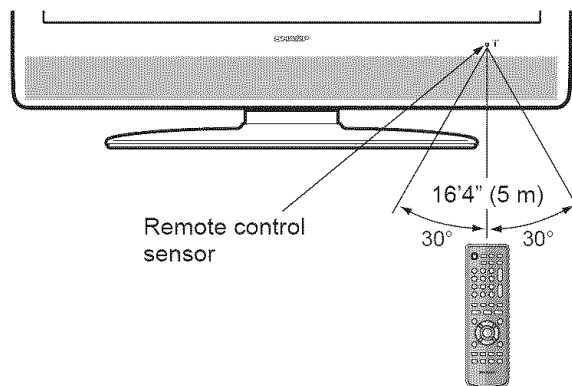

### IMPORTANT:

The POWER indicator on the television should light GREEN indicating you have power to the TV/DVD.

If the POWER indicator on the television still does not light up, press **POWER** on the remote control to turn the power on.

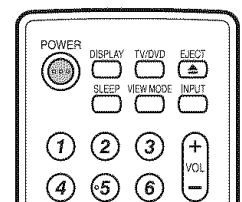

### IMPORTANT:

IF THE UNIT DOES NOT POWER ON - UNPLUG THE TELEVISION FROM THE OUTLET AND REPEAT THE INSTALLATION STEPS.

IF YOU STILL ENCOUNTER NO POWER, PLEASE CONTACT US AT 1-800-BE-SHARP.

Please refer to the BASIC ADJUSTMENT SETTINGS SECTION and basic Initial setup functions and USING EXTERNAL EQUIPMENT SECTION for other device connections (DVD, VCR, AUDIO, etc) in your operation manual.

# Contents

<b>IMPORTANT INFORMATION</b> .....	<b>1</b>	Setting WOW™ surround sound.....	31
<b>Trademarks</b> .....	<b>2</b>	Closed captions and digital closed captions.....	32
<b>DEAR SHARP CUSTOMER</b> .....	<b>3</b>	Caption setup .....	33
<b>IMPORTANT SAFETY INSTRUCTIONS</b> .....	<b>3</b>	Password setting for parental control .....	34
<b>DISC</b> .....	<b>6</b>	Parental control (V-CHIP).....	35
Discs which can be played back .....	6	TV Parental Guidelines (TV Guidelines) .....	36
Discs which cannot be played back .....	6	Voluntary movie rating system (MPAA).....	36
Title/Chapter/Track .....	6	Canadian rating systems.....	37
Handling discs .....	7	Canadian English ratings .....	38
<b>Supplied accessories</b> .....	<b>8</b>	Canadian French ratings .....	38
<b>QUICK REFERENCE</b> .....	<b>8</b>	How to temporarily release the V-CHIP block ...	38
Attaching the stand.....	8	Reactivating the temporarily released V-CHIP block.....	38
<b>Contents</b> .....	<b>11</b>	<b>Other viewing options</b> .....	<b>39</b>
<b>Part names</b> .....	<b>12</b>	Signal meter .....	39
TV/DVD (Front) .....	12	<b>Watching the DVD</b> .....	<b>40</b>
TV/DVD (Right) .....	12	Preparation.....	40
TV/DVD (Rear).....	13	Turning on the power .....	40
Remote control unit .....	14	Select the DVD mode.....	40
<b>Preparation</b> .....	<b>15</b>	Turning off the power .....	40
Using the remote control unit .....	15	Playback procedure.....	41
Cautions regarding remote control unit .....	15	Status display of disc.....	41
Antennas .....	15	Special playback .....	42
<b>Watching TV</b> .....	<b>16</b>	Zooming .....	42
Preparation.....	16	Locating desired scene .....	42
Turning on the power .....	16	Repeat playback.....	43
Select the TV mode.....	16	A-B Repeat playback.....	43
Turning off the power .....	16	Marking desired scenes .....	43
Initial setup .....	17	Program playback (only CD) .....	44
Simple button operations for changing channels .....	18	Random playback (only CD) .....	44
Simple button operations for changing volume/sound .....	19	Changing angles .....	44
Display the channel information .....	19	Title selection .....	44
Sleep timer .....	20	DVD menu.....	44
Setting MTS/SAP stereo mode .....	20	Changing soundtrack language.....	45
<b>Basic adjustment settings</b> .....	<b>21</b>	Subtitles.....	45
Menu operation buttons.....	21	<b>MP3/WMA/JPEG CD playback</b> .....	<b>46</b>
Menu items.....	21	MP3/WMA/JPEG CD information.....	46
Labeling channels .....	22	MP3/WMA CD playback.....	47
Input label.....	22	JPEG CD playback.....	47
Picture adjustments.....	23	About file menu .....	47
Color temperature .....	23	Setting the JPEG interval .....	48
Cinema mode .....	23	Setting the select files .....	48
Back lighting .....	23	<b>Function setup</b> .....	<b>49</b>
Sound adjustment .....	24	Basic operation buttons.....	49
Digital audio output.....	24	Menu items.....	49
<b>Using external equipment</b> .....	<b>25</b>	Setting the language .....	50
Displaying an external equipment image .....	25	Setting the aspect ratio of TV screen .....	50
Connecting a digital TV STB (Air or Cable).....	26	Setting on screen display .....	51
Connecting a VCR, game console or camcorder .....	26	Setting the picture mode .....	51
Using digital audio output.....	26	Dynamic Range Control .....	51
Connecting HDMI equipment .....	27	Parental control setting.....	52
Displaying an image from HDMI equipment.....	27	To change the parental level .....	52
Selecting HDMI audio input source.....	27	Temporary disabling of rating level by DVD disc .....	53
<b>Useful adjustment settings</b> .....	<b>28</b>	<b>Appendix</b> .....	<b>54</b>
Reset .....	28	Language code list .....	54
AV mode.....	29	Removing the stand .....	55
Selecting the digital audio language.....	29	Setting the TV/DVD on the wall.....	55
View mode for 4:3 programs .....	30	Troubleshooting.....	56
View mode for HD programs .....	30	Troubleshooting-Digital broadcasting.....	56
Picture scroll.....	30	Troubleshooting-DVD.....	57
Aspect .....	30	Specifications .....	58
Audio output select.....	31	Optional accessories .....	58
		<b>Dimensional drawings</b> .....	<b>59</b>

# Part names

## TV/DVD (Front)

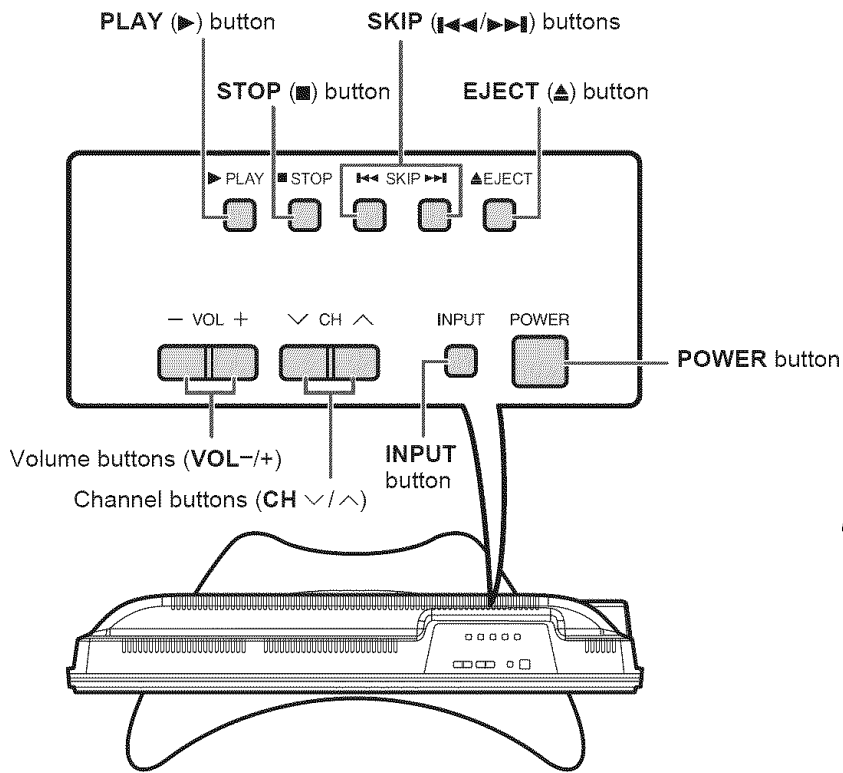

## TV/DVD (Right)

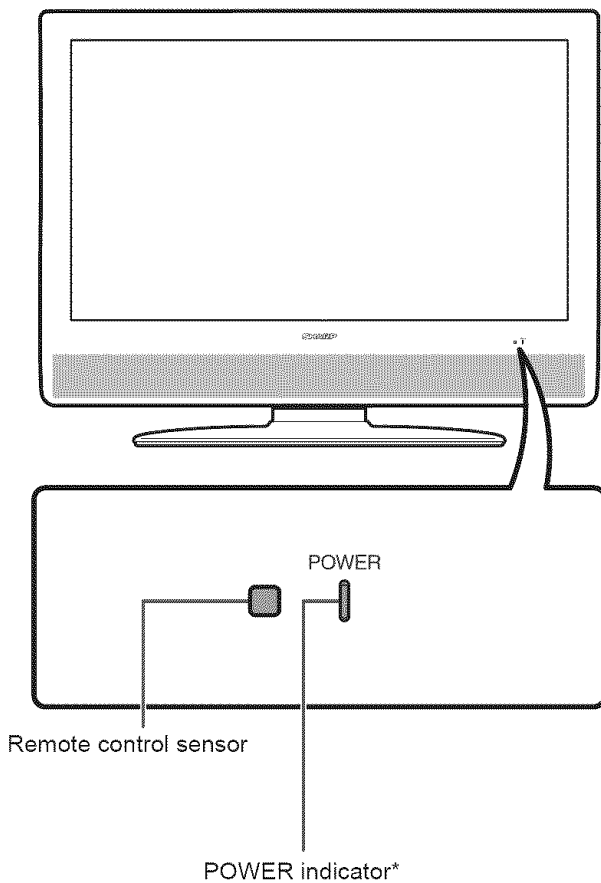
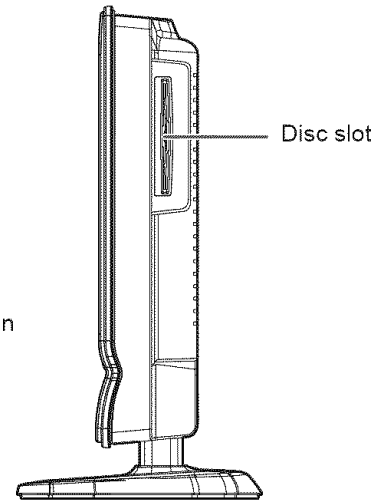

### NOTE

\*See page 16 for TV/DVD status indicator.



Part names

TV/DVD (Rear)

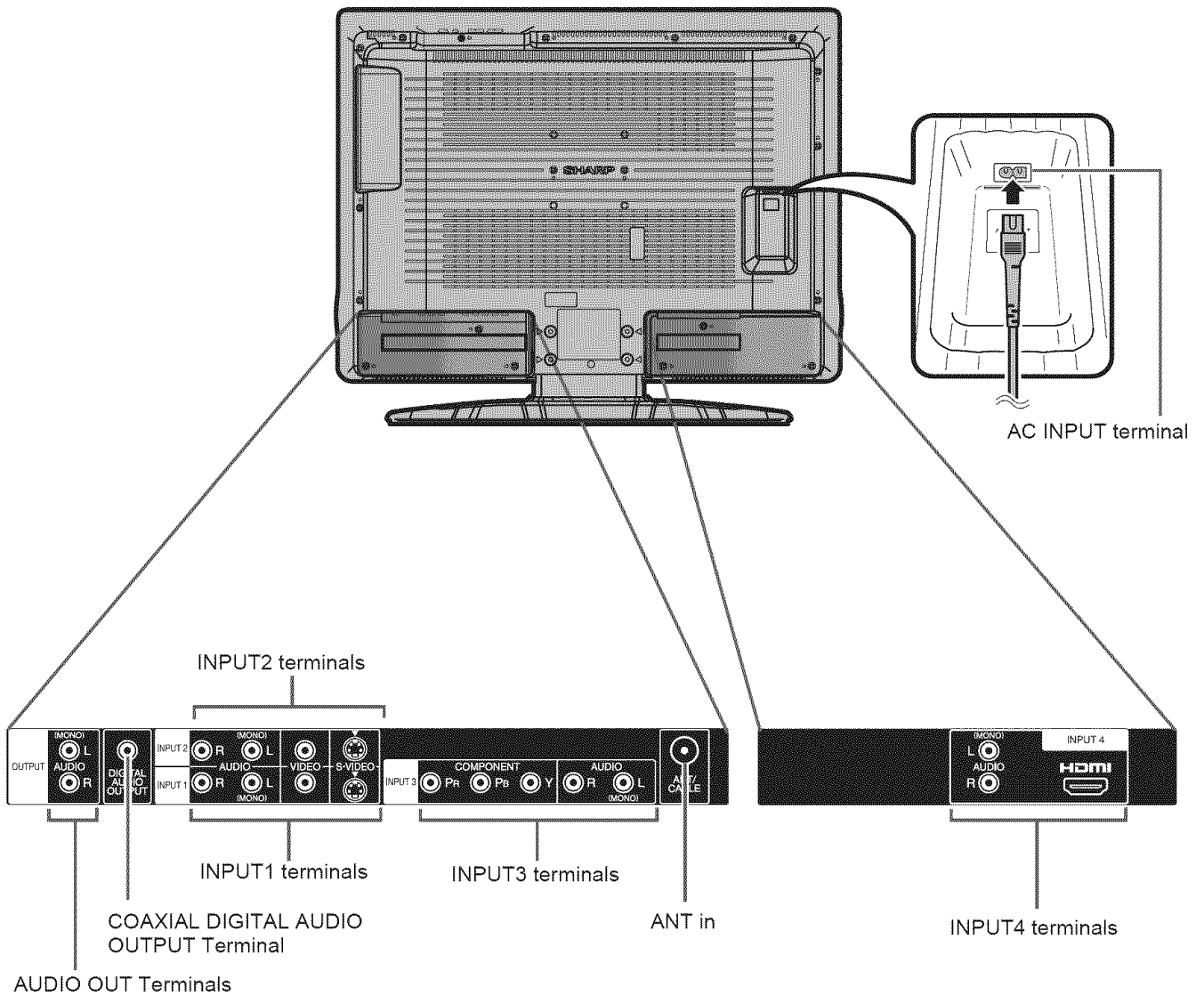

Remote control unit

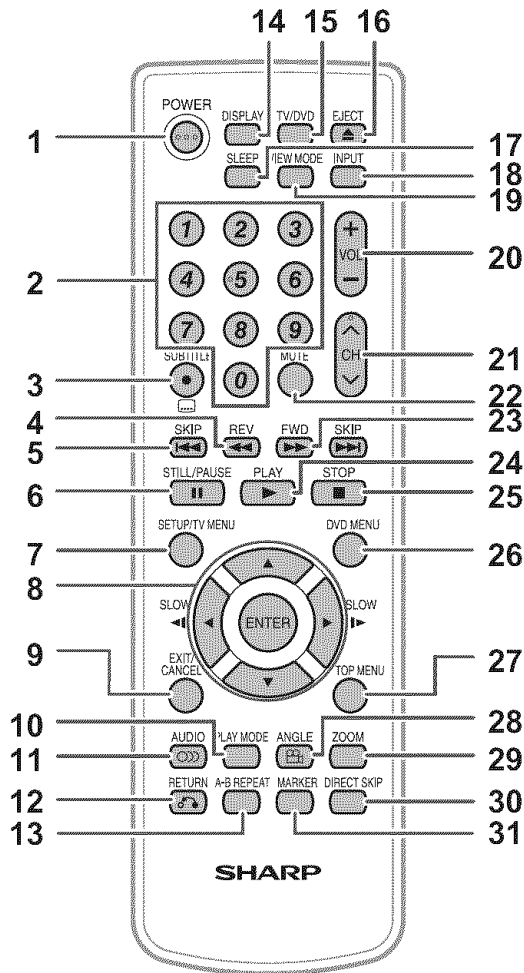

- 1 **POWER**: Switch the power on or enters standby mode. (See page 16.)
- 2 **0 – 9**: Set the channel. (See page 18.)
- 3 **• (DOT) / SUBTITLE**: To select 4-digit channel number. (See page 18.) / Set subtitle. (See page 45.)
- 4 **REV** : Review playback. (See page 42.)
- 5 **SKIP** : Skip chapter to reverse or forward direction. (See page 42.)
- 6 **STILL/PAUSE**: Still picture of DVD / Pause CD sound. (See page 42.)
- 7 **SETUP/TV MENU**: TV mode - Display menu of TV / DVD mode - Call up initial setup mode. (See pages 21, 49.)
- 8 **▲/▼/◀/▶/ENTER**: Select a desired item on the screen.  
**SLOW** : Reverse/Forward -slow motion. (See page 42.)
- 9 **EXIT/CANCEL**: Turn off the menu screen / Reset information in the menu.
- 10 **PLAY MODE**: Select playback mode. (See page 44.)
- 11 **AUDIO**: Switch the sound of TV / Change sound track language. (See page 45.)
- 12 **RETURN**: Turn off the DVD setup menu screen.
- 13 **A-B REPEAT**: Repeat playback between A and B. (See page 43.)
- 14 **DISPLAY**: Display the information. (See pages 19, 41)
- 15 **TV/DVD**: Switch between TV/AV and DVD. (See pages 16, 40.)
- 16 **EJECT**: Eject the disc. (See page 41.)
- 17 **SLEEP**: Set the sleep timer. (See page 20.)
- 18 **INPUT**: Select input source. (TV, INPUT1~4)
- 19 **VIEW MODE**: Select the screen size. (See page 30.)
- 20 **VOL +/-**: Set the volume. (See page 19.)
- 21 **CH ^/∨** : Select the channel. (See page 18.)
- 22 **MUTE**: Mute the sound. (See page 19.)
- 23 **FWD**: Fast forward playback. (See page 42.)
- 24 **PLAY**: Playback. (See page 41.)
- 25 **STOP**: Stop. (See page 41.)
- 26 **DVD MENU**: Display DVD menu. (See page 44.)
- 27 **TOP MENU**: Select title. (See page 44.)
- 28 **ANGLE**: Change playback channel. (See page 44.)
- 29 **ZOOM**: Zoom. (See page 42.)
- 30 **DIRECT SKIP**: Locating desired scene of DVD. (See page 42.)
- 31 **MARKER**: Index (DVD). (See page 43.)

NOTE

• When using the remote control unit, point it at the TV/DVD. (See page 10.)

# Preparation

## Using the remote control unit

Use the remote control unit by pointing it towards the remote control sensor on the TV/DVD. Objects between the remote control unit and the remote control sensor may prevent proper operation.

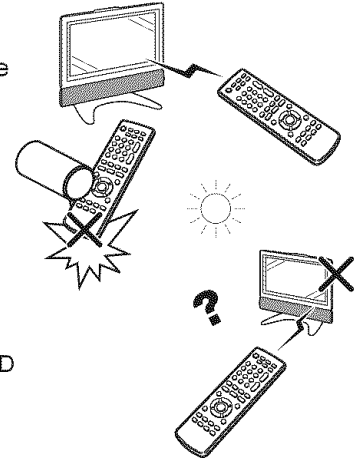

## Cautions regarding remote control unit

- Do not expose the remote control unit to shock. In addition, do not expose the remote control unit to liquids, and do not place in an area with high humidity.
- Do not install or place the remote control unit under direct sunlight. The heat may cause deformation of the remote control unit.
- The remote control unit may not work properly if the remote control sensor on the TV/DVD is under direct sunlight or strong lighting. In such cases, change the angle of the lighting or the TV/DVD, or operate the remote control unit closer to the remote control sensor.

## Antennas

To enjoy a clearer picture, use an outdoor antenna. The following is a brief explanation of the types of connections that are used for a coaxial cable. If your outdoor antenna uses a 75-ohm coaxial cable with an F-type connector, plug it into the antenna terminal at the rear of the TV/DVD.

1. A 75-ohm system is generally a round cable with F-type connector that can easily be attached to a terminal without tools (Commercially available).
2. A 300-ohm system is a flat "twin-lead" cable that can be attached to a 75-ohm terminal through a 300/75-ohm adapter (Commercially available).

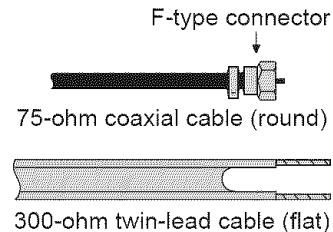

## NOTICE

F-type connector

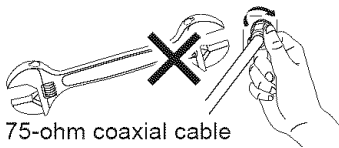

75-ohm coaxial cable

**F-type connector should be finger-tightened only.**

When connecting the RF cable to the TV/DVD, do not tighten F-type connector with tools. If tools are used, it may cause damage to your TV/DVD. (The breaking of internal circuit, etc.)

## Connecting Antenna Cable

Cable without a CATV converter  
Combination VHF/UHF antenna

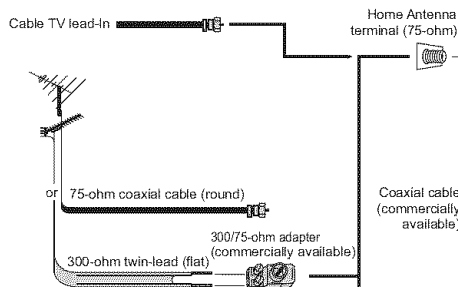

Separate VHF/UHF antenna

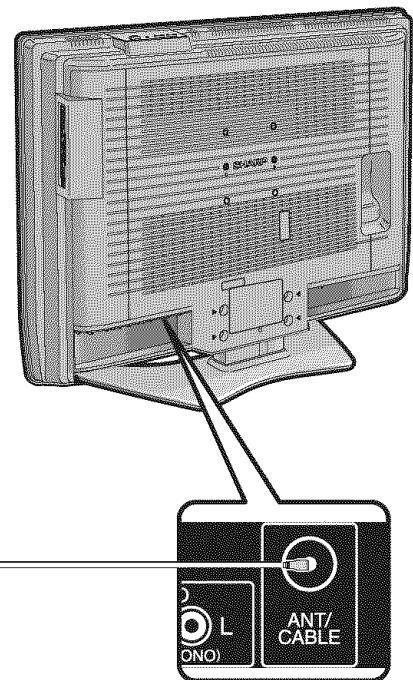
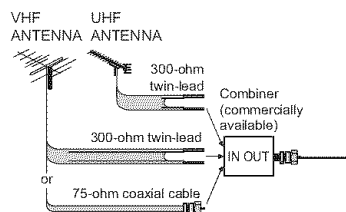

# Watching TV

Simple operations for watching a TV program.

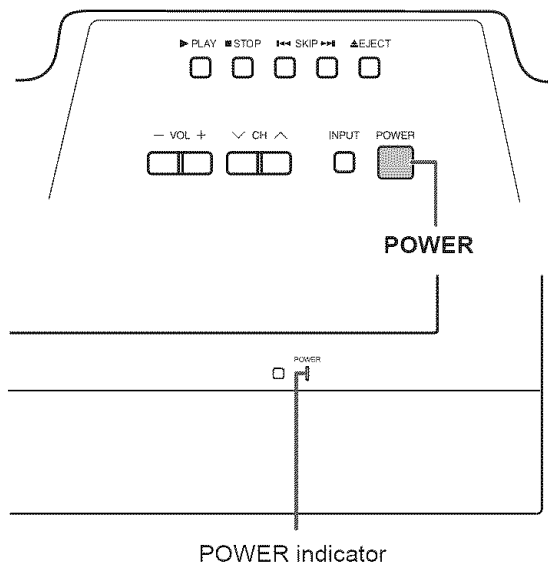

TV/DVD status indicator (POWER)

ON	Lighting (Green)
OFF/Standby	Lighting (Red)

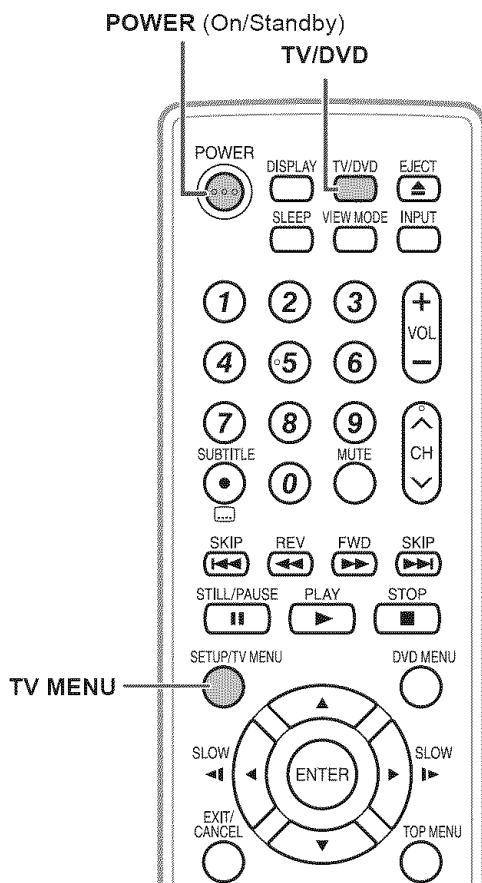

## Preparation

Perform the following steps before you press **POWER** on the remote control unit.

1. Insert the batteries into the remote control unit. (See page 10.)
2. Connect the antenna cable to the TV/DVD. (See page 15.)
3. Plug in the AC cord to the AC outlet. (See page 9.)

## Turning on the power

Press **POWER** on the TV/DVD, or **POWER** on the remote control.

- **POWER** indicator (Green): The TV/DVD is on. ("PLEASE WAIT" will appear for a few seconds on the screen.)

## Select the TV mode

Press **TV/DVD** to select the TV mode.

### NOTE

- The LANGUAGE setup menu will appear automatically when **TV MENU** is pressed on for the first time. (See page 17.)

## Turning off the power

Press **POWER** on the TV/DVD, or **POWER** on the remote control.

- The TV/DVD enters standby mode and the image on the screen disappears.
- The **POWER** indicator on the TV/DVD changes to Red.

### NOTE

- If you are not going to use this TV/DVD for a long period of time, be sure to remove the AC cord from the power outlet.
- Weak electric power is still consumed even when **POWER** is turned off.
- If a station being viewed stops broadcasting, the TV/DVD will automatically shut itself off after 15 minutes. (TV mode only.)

## Watching TV

### Initial setup

#### Language setting

When you press TV MENU for the first time, the LANGUAGE setup menu will appear automatically.

Select from among 3 languages: English, French and Spanish.

1

Press ◀/▶ to select the desired language from the list.

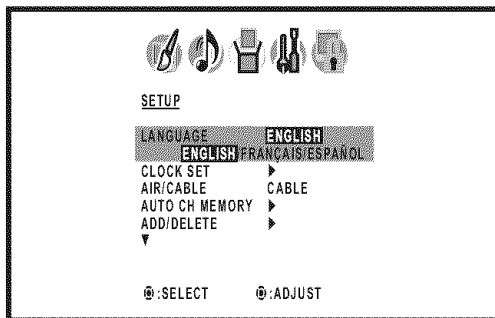

#### Clock setting

Please set correct date and time manually.

2

Press ▲/▼ to select "CLOCK SET", then press ◀/▶. The CLOCK SET menu screen displays.

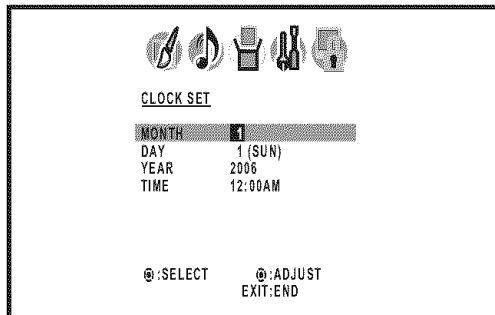

Press ◀/▶ to set the MONTH, then press ▼ to move to the next.

Set the DAY, YEAR and TIME (hour and minute) as above step.

After setting the date and time correctly, press ENTER.

#### Antenna setting

Make sure what kind of connection is made with your TV/DVD when selecting "AIR" or "CABLE".

3

Press ▲/▼ to select "AIR/CABLE", then press ◀/▶ to select "AIR" or "CABLE".

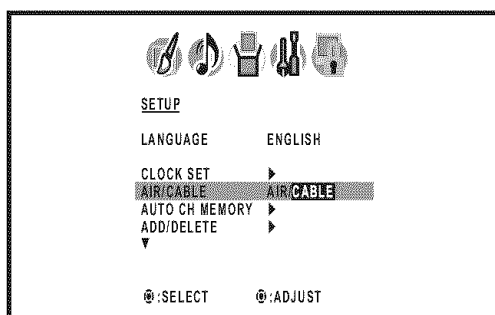

### Channel search

AUTO CHANNEL MEMORY makes the TV/DVD look for all channels viewable in the set area.

4

Press ▲/▼ to select "AUTO CH MEMORY"

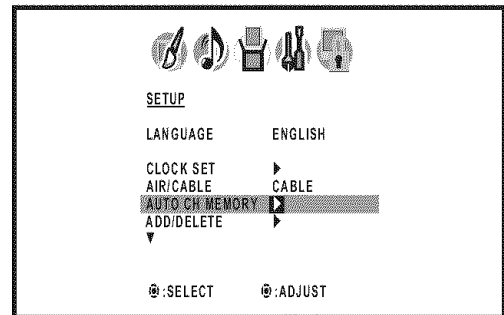

Press ◀/▶. The TV/DVD will begin memorizing all the channels available in your area.

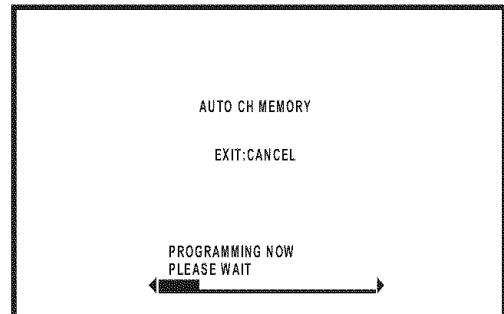

- Depending on the reception condition, it may take approximately 10 minutes to complete memorizing digital cable channels, please be patient.

### Skipping stored channel

You can set channel selection disabled using CH ^/∨.

1

Press TV MENU and the MENU screen displays.

2

Press ◀/▶ to select  (SETUP).

3

Press ▲/▼ to select "ADD/DELETE", and then press ◀/▶.

4

Press ▲/▼ to select "ADD/DELETE", and then press ◀/▶. Now, the channel list becomes selectable.

5

Press ▲/▼ to select the channel which you want to skip.

6

Press ◀/▶ to select "DELETE" for selected channel.

7

Press EXIT to return to the normal screen. Now, skipping channel is applied.

- **To add a digital channel you are watching:**  
Select a channel you want to add. Then select "ADDING CHANNEL" in step 4, press ◀/▶.
- **To release the skipping channel:**  
Select "ADD" in step 6.
- **To remove all the channels from channel memory:**  
Select "CLEAR ALL" after step 3, and the press ◀/▶.

## Simple button operations for changing channels

You can change channels in several ways.

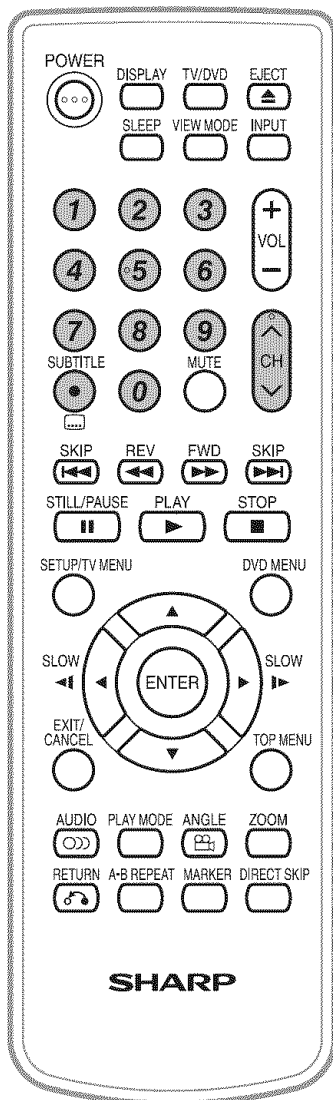

### Method 1

Using CH  $\wedge/\vee$  on the remote control unit or on the TV/DVD.

### Method 2

Using remote control buttons 0-9, • (DOT) to select channels for VHF/UHF/CATV/DIGITAL.

To select a 1 or 2-digit channel number (e. g., Channel 5):

Press 5

#### NOTE

- When selecting a 1-digit channel number, it is not necessary to press 0 before the number.
- When you enter 0-9, channel selection will be made if there is no operation within a few seconds.

To select a 3-digit channel number (e. g., Channel 115):

Press 1→1→5

To select a 4-digit channel number (e. g., Channel 22.1):

Press 2→2→• (DOT) →1

#### NOTE

- When you enter 0-9, channel selection will be made if there is no operation within a few seconds.
- If you push "0" by itself, nothing will happen.
- Complete the above steps within a few seconds.
- When you enter 0-9 and • (DOT), channel selection will be made if there is no operation within a few seconds.

### Simple button operations for changing volume/sound

#### Changing the volume

You can change the volume on the TV/DVD or on the remote control unit.

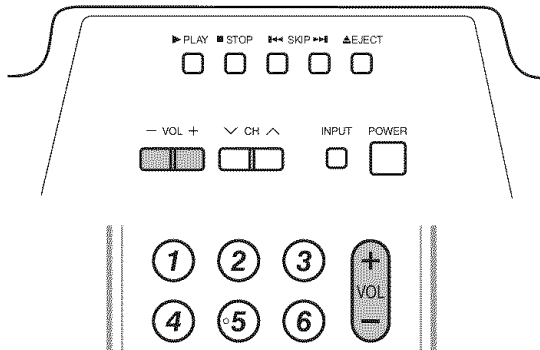

#### Using VOL +/-

- To increase the volume, press **VOL+**.
- To decrease the volume, press **VOL-**.



#### NOTE

- **VOL+/-** on the TV/DVD operates the same as **VOL+/-** on the remote control unit.

#### Using MUTE on the remote control unit

Mutes the current sound output.

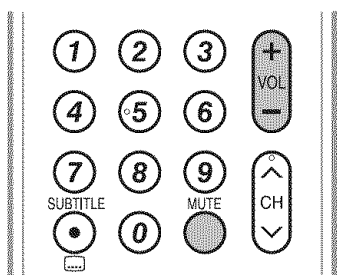

1

Press **MUTE**.

- "MUTE" will be displayed on the screen, and the sound is silenced.



#### NOTE

- Mute can be canceled if you press **VOL+/-** or **MUTE**.

### Display the channel information

Press **DISPLAY** to display the current channel (or input source) information on the screen.

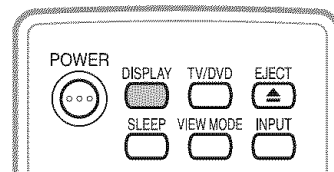

When the TV/DVD receives a digital signal, press once, the digital information will appear.

- Broadcast program name
- Station name
- Audio language
- V-CHIP RATING
- Closed Caption mark
- Remaining time
- Program name
- HD or SD mark
- V-Chip mark

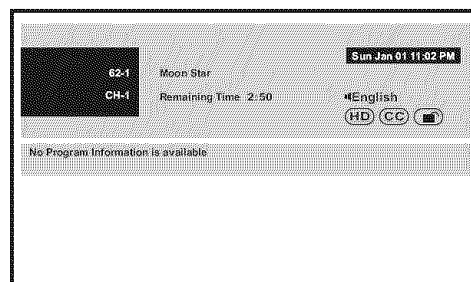

Press **DISPLAY** again, the analog information will appear.

- Clock
- Channel number or VIDEO mode selected
- Channel label (if preset)
- Stereo or SAP (second audio program) audio status
- Content rating
- View mode

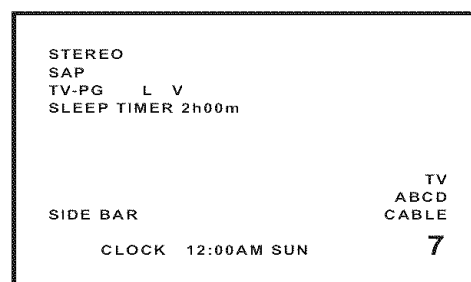

Press **DISPLAY** again to clear the display.

#### NOTE

- Analog channel status will display on the screen for approx. 4 seconds. Digital channel status will display for approx. 10 seconds.

## Sleep timer

Allows you to set a time when the TV/DVD automatically switches to standby.

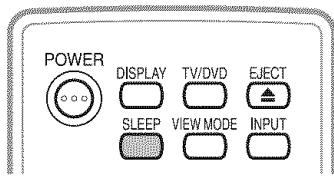

1

Each time you press **SLEEP**, the remaining time setting switches as shown below.

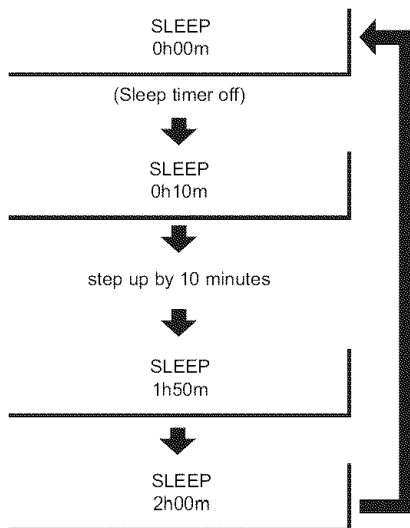

This display will disappear after a few seconds, the sleep timer automatically starts counting down.

- If you want to adjust the sleep timer again, you can press **SLEEP** repeatedly then change the time setting.

2

Press **SLEEP**.

- The remaining time displays when the sleep timer has been set.

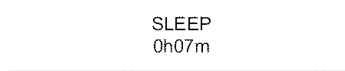

### NOTE

- Select "0h00m" by pressing **SLEEP** repeatedly to cancel the sleep timer.
- The TV/DVD will enter the standby mode when the remaining time reaches zero.

## Setting MTS/SAP stereo mode

The TV/DVD has a feature that allows reception of sound other than the main audio for the program. This feature is called Multi-channel Television Sound (MTS). The TV/DVD with MTS can receive mono sound, stereo sound and Secondary Audio Programs (SAP). The SAP feature allows a TV/DVD station to broadcast other information, which could be audio in another language or something completely different like weather information.

**You can enjoy Hi-Fi stereo sound or SAP broadcasts where available.**

### • Stereo broadcasts

View programs like live sporting events, shows and concerts in dynamic stereo sound.

### • SAP broadcasts

Receive TV broadcasts in either MAIN or SAP sound. MAIN sound: The normal program soundtrack (either in mono or stereo).

SAP sound: Listen to a second language, supplementary commentary or other information. (SAP is mono sound.)

**If stereo sound is difficult to hear.**

- Obtain a clearer sound by manually switching to fixed mono-sound mode.

### NOTE

- MTS only operates while in TV mode.
- When the TV receives a stereo or SAP broadcast, the word "STEREO" or "SAP" displays on-screen every time you turn the TV/DVD on, change the channel, or press **DISPLAY**.

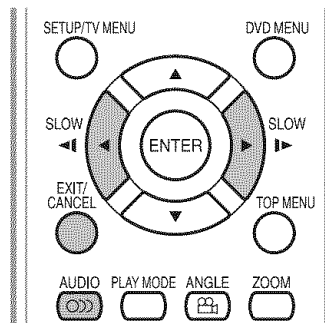

## Changing MTS

You can change MTS as shown below to match the television broadcast signal.

1

Press **AUDIO** and the (AUDIO) menu screen displays. "MTS" will be highlighted.

2

Press **AUDIO** again or to select "STR (STEREO)", "SAP" or "MONO".

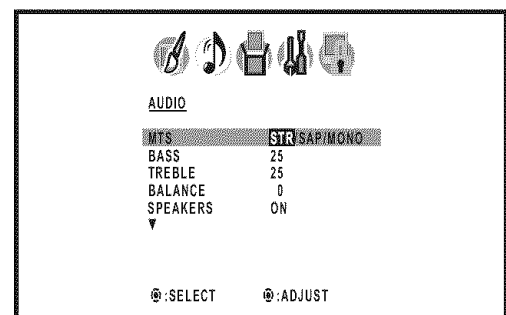

3

Press **EXIT** to return to the normal screen.



# Basic adjustment settings

## Menu operation buttons

Use the following buttons on the remote control to operate the menu.

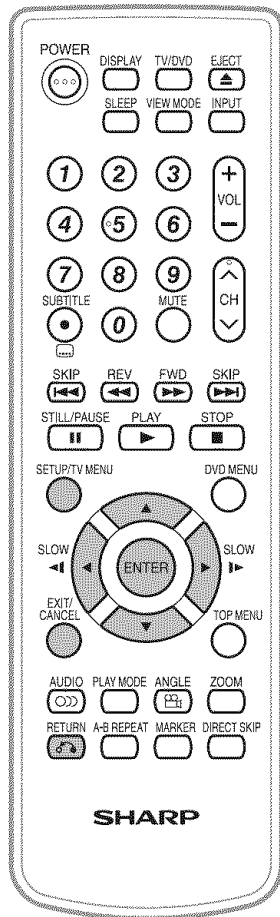

**TV MENU:** Press to open the menu screen.

**▲/▼/◀/▶:** Press to select a desired item on the screen or adjust a selected item.

**ENTER:** Press to go to the next step or complete the setting.

**RETURN:** Press to return to the previous step.

**EXIT:** Press to exit from the menu screen. All changed settings will be saved.

⊙: SELECT  
ENTER: SET

⊙: ADJUST  
EXIT: END

The lower part of the menu screen is an operational guide for the remote control. It will change in accordance with each menu setting screen.

## Menu items

List of menu items to help you with operations

### PICTURE

AV MODE .....	Page 29
BRIGHTNESS .....	Page 23
CONTRAST .....	Page 23
COLOR .....	Page 23
TINT .....	Page 23
SHARPNESS .....	Page 23
COLOR TEMPERATURE .....	Page 23
RESET (Picture adjustments) .....	Page 28

### AUDIO

MTS .....	Page 20
BASS .....	Page 24
TREBLE .....	Page 24
BALANCE .....	Page 24
SPEAKERS .....	Page 31
WOW	
SRS 3D .....	Page 31
FOCUS .....	Page 31
TruBass .....	Page 31
HDMI .....	Page 27
AUDIO LANGUAGE .....	Page 29
DIGITAL OUTPUT .....	Page 24
RESET (Sound adjustments) .....	Page 28

### SETUP

LANGUAGE .....	Page 17
CLOCK SET .....	Page 17
AIR/CABLE .....	Page 17
AUTO CH MEMORY .....	Page 17
ADD/DELETE .....	Page 17
CLOSED CAPTION .....	Page 32
CC ADVANCED .....	Page 33
VIEW MODE .....	Page 30
PICTURE SCROLL .....	Page 30
CINEMA MODE .....	Page 23
ASPECT .....	Page 30
SIGNAL METER .....	Page 39
BACK LIGHTING .....	Page 23

### OPTION

CH LABEL .....	Page 22
VIDEO LABEL .....	Page 22

### LOCKS

V-CHIP SET .....	Page 36
NEW PASSWORD .....	Page 34

## Labeling channels

### To create channel labels

- 1 Select a channel you want to label.
- 2 Press **TV MENU**, then press ◀/▶ to select  (OPTION).  
Press ▲/▼ to select "CH LABEL", then press ◀/▶. The CH LABEL menu will appear.
- 3 Press ▲/▼ to select "SET/CLEAR". Press ◀/▶ to select "SET" then press **ENTER**.
- 4 Press ◀/▶ to enter a character in the first space. Press the button repeatedly until the character you want appears on the screen.

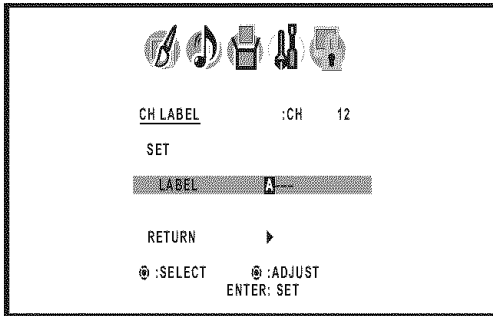

The characters rotation as follows:

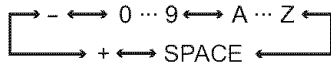

If the character which you desire appears, press **ENTER**. Repeat this step to enter the rest of the characters.

When you finish inputting the label name, press **ENTER**.

- 5 Press **EXIT** to return to the normal screen.
- 6 Repeat steps 1-5 for other channels. You can assign a label to each channel.

### To erase channel labels

- 1 Select a channel with a label which you want to remove.
- 2 Press **TV MENU**, then press ◀/▶ to select  (OPTION).  
Press ▲/▼ to select "CH LABEL", then press ◀/▶ to display the CH LABEL menu.
- 3 Press ▲/▼ to select "SET/CLEAR". Press ◀/▶ to select "CLEAR", then press **ENTER**.
- 4 Press **EXIT** to return to the normal screen.
- 5 Repeat steps 1-4 to erase other channel labels.

## Input label

Let you set the input terminal displayed when using the "SOURCE SELECTION" menu or channel display.

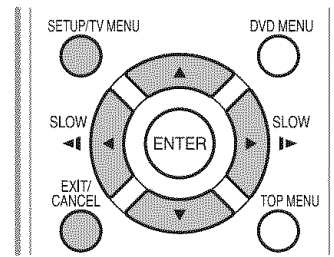

- 1 Press **TV MENU** and the MENU screen displays.
- 2 Press ◀/▶ to select  (OPTION).
- 3 Press ▲/▼ to select "VIDEO LABEL", and then press ◀/▶.
- 4 The VIDEO LABEL menu screen displays. Press ▲/▼ to select the specific input source which you want to change.
- 5 Press ◀/▶ to select the new label for the selected input source.

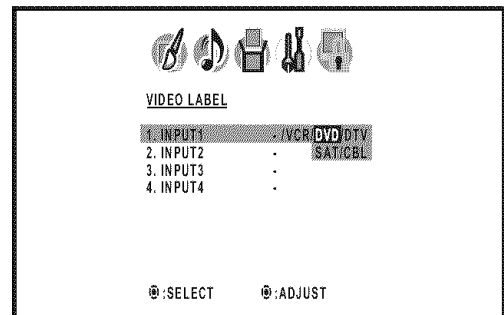

-	Uses the default label name
VCR	Video cassette recorder
DVD	DVD video
DTV	Digital TV set-top box
SAT	Satellite box
CBL	Cable box
HD	HDMI equipment

- 6 Press **EXIT** to return to the normal screen.

### NOTE

- You cannot change label for "TV" input.

## Basic adjustment settings

### Picture adjustments

Adjusts the picture to your preference with the following picture settings.

- 1 Press **TV MENU** and the MENU screen displays.
- 2 Press ◀/▶ to select  (PICTURE).
- 3 Press ▲/▼ to select a specific adjustment item (BRIGHTNESS, CONTRAST, COLOR, TINT, SHARPNESS).
- 4 Press ◀/▶ to adjust the item to the desired level.

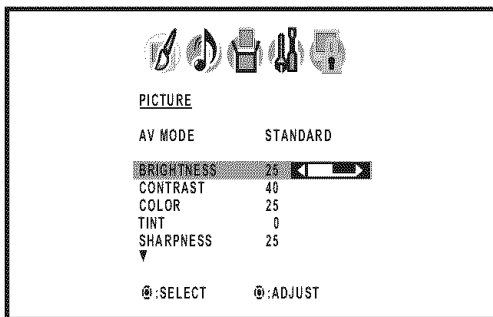

Selected item	◀ button	▶ button
<b>BRIGHTNESS</b>	For less brightness	For more brightness
<b>CONTRAST</b>	For less contrast	For more contrast
<b>COLOR</b>	For less color intensity	For more color intensity
<b>TINT</b>	Skin tones become purplish	Skin tones become greenish
<b>SHARPNESS</b>	For less sharpness	For more sharpness

- 5 Press **EXIT** to return to the normal screen.

#### NOTE

- For resetting all Picture adjustment items to the factory preset values, press ▲/▼ to select "RESET", and then press ◀/▶ (see page 28 for further information).

### Color temperature

For a better white balance, use color temperature correction.

- 1 Press **TV MENU** and the MENU screen displays.
- 2 Press ◀/▶ to select  (PICTURE).
- 3 Press ▲/▼ to select "COLOR TEMPERATURE".
- 4 Press ◀/▶ to select the mode you prefer.

Selected item	Description
<b>COOL</b>	White with Blueish tone
<b>MEDIUM</b>	Neutral
<b>WARM</b>	White with Reddish tone

- 5 Press **EXIT** to return to the normal screen.

### Cinema mode

A smoother motion may be obtained by setting the CINEMA MODE to FILM when you view a DVD from the DVD player connected with the component input.

- 1 Press **TV MENU** and the MENU screen displays.
- 2 Press ◀/▶ to select  (SETUP).
- 3 Press ▲/▼ to select "CINEMA MODE".
- 4 Press ◀/▶ to select "FILM" or "VIDEO".

Selected item	Description
<b>FILM</b>	Film content viewing mode
<b>VIDEO</b>	Video content viewing mode

### Back lighting

BACK LIGHTING adjusts the screen brightness for improved picture clarity.

- 1 Press **TV MENU** and the MENU screen displays.
- 2 Press ◀/▶ to select  (SETUP).
- 3 Press ▲/▼ to select "BACK LIGHTING".
- 4 Press ◀/▶ to adjust the screen brightness.
- 5 Press **EXIT** to return to the normal screen.

## Basic adjustment settings

### Sound adjustment

You can adjust the sound quality to your preference with the following settings.

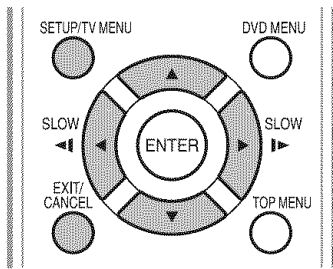

**1** Press **TV MENU** and the MENU screen displays.

**2** Press **◀/▶** to select (AUDIO).

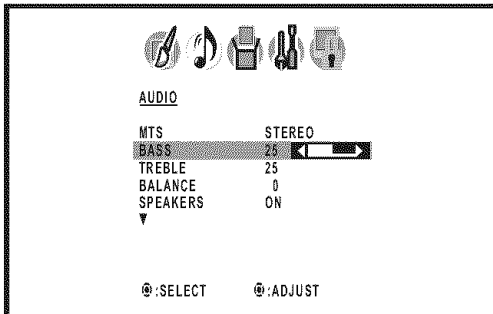

**3** Press **▲/▼** to select a specific adjustment item (BASS, TREBLE, BALANCE).

**4** Press **◀/▶** to adjust the item to the desired level.

Selected item	◀ button	▶ button
<b>BASS</b>	For weaker bass	For stronger bass
<b>TREBLE</b>	For weaker treble	For stronger treble
<b>BALANCE</b>	Decrease audio from the right speaker	Decrease audio from the left speaker

**5** Press **EXIT** to return to the normal screen.

#### NOTE

- For resetting all Audio adjustment items to the factory preset values, press **▲/▼** to select "RESET", and then press **◀/▶** (see page 28 for further information).

### Digital audio output

You can output digital audio to an AV amplifier or similar device whose DIGITAL AUDIO INPUT terminal is connected to the COAXIAL DIGITAL AUDIO OUTPUT terminal on the TV/DVD. Please select an audio output format compatible with the audio format of the program you are watching and the equipment connected.

**1** Press **TV MENU** and the MENU screen displays.

**2** Press **◀/▶** to select (AUDIO).

**3** Press **▲/▼** to select "DIGITAL OUTPUT".

**4** Press **◀/▶** to select "PCM" or "DOLBY DIGITAL".

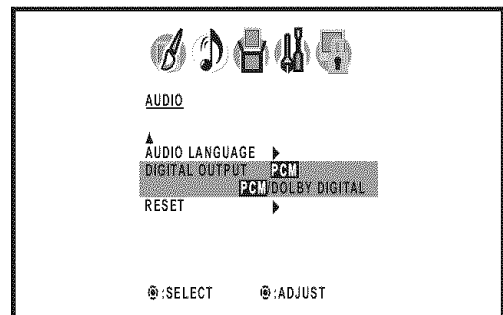

Selected item	Description
<b>PCM</b>	The coaxial digital audio output terminal outputs audio signal in PCM form. If your digital audio system does not support Dolby Digital, select "PCM".
<b>DOLBY DIGITAL</b>	The coaxial digital audio output terminal outputs audio signal in Dolby Digital form. It reproduces sound from surround program of digital.

**5** Press **EXIT** to return to the normal screen.

# Using external equipment

You can connect many types of external equipment to your TV/DVD like a VCR, Digital TV tuner, HDMI equipment, game console or camcorder. To view external source images, select the input source from **INPUT** on the remote control unit or on the TV/DVD.

## Displaying an external equipment image

This explanation is for the setting when connecting a VCR to the INPUT1 terminal.

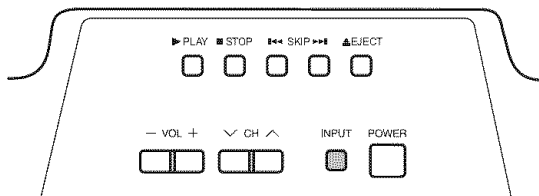
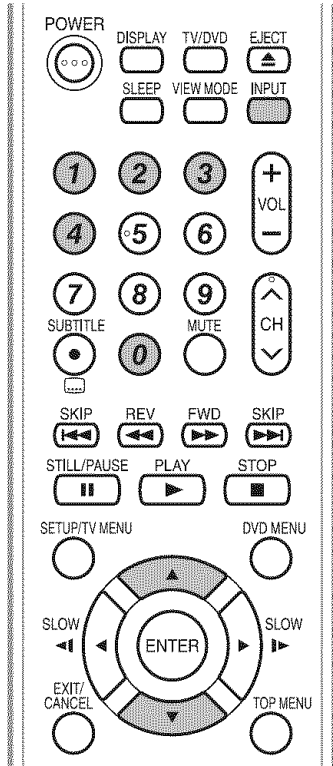

To watch VCR, select "INPUT1" from "SOURCE SELECTION" menu using **0-4** on the remote control.

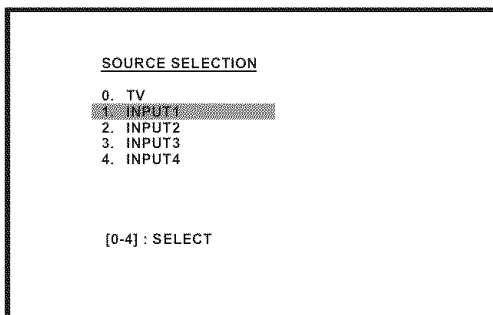

### CAUTION

- To protect equipment, always turn off the TV/DVD before connecting a VCR, Digital TV tuner, HDMI equipment, game console, camcorder or other external equipment.

### NOTE

- See pages 26 and 27 for external equipment connection.
- Please read the relevant operation manual (VCR, etc.) carefully before making connections.
- Refer to your external equipment operation manual for the signal type.

- Each time **INPUT** is pressed, "SOURCE SELECTION" item toggles.
- You can also select "SOURCE SELECTION" item by pressing **▲/▼**.

## Using external equipment

### Connecting a Digital TV STB (Air or Cable)

You can use the INPUT1, INPUT2 or INPUT3 terminals when connecting to a Digital TV STB (Air or Cable) and other audiovisual equipment.

When using component cable.  
(INPUT3)

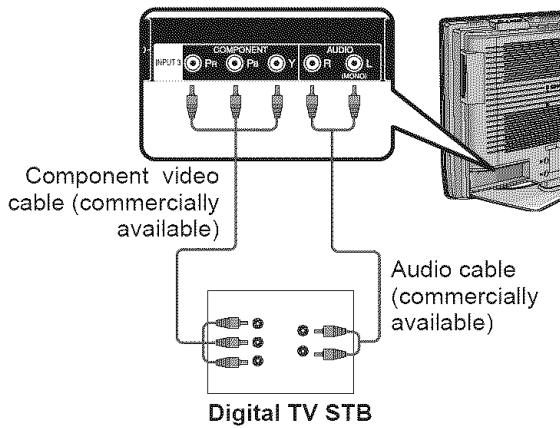

When using composite cable. (INPUT1 or 2)

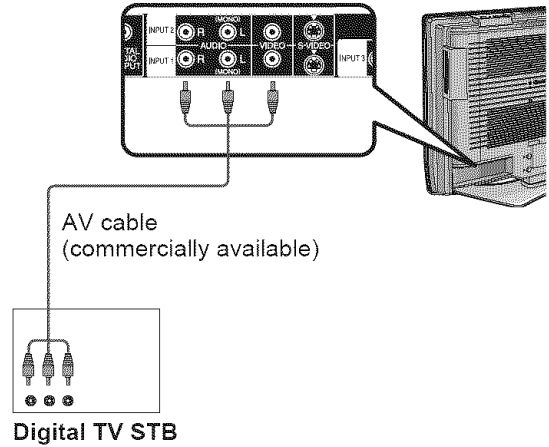

#### NOTE

- See page 27 for connecting a Digital TV STB to the HDMI terminal.

### Connecting a VCR, game console or camcorder

A VCR, game console, camcorder and other audiovisual equipment can be conveniently connected using the INPUT1 or 2 terminals.

#### NOTE

- The S-video terminal takes priority over the video terminals.

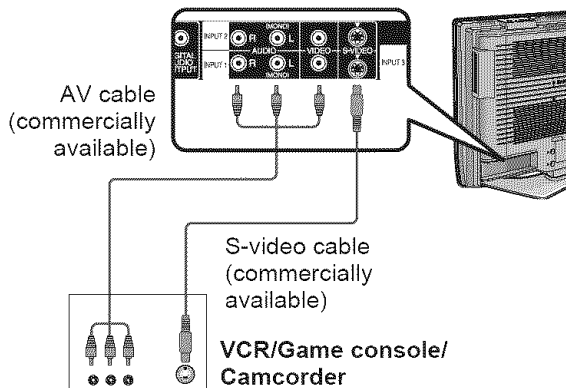

### Using digital audio output

It is possible to output audio through the COXIAL DIGITAL AUDIO OUTPUT terminal. (See page 24 for details.) PCM audio outputs from the terminal.

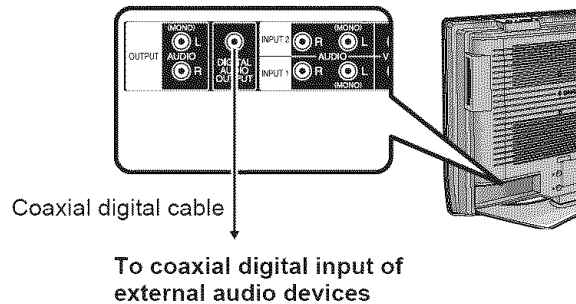

## Using external equipment

### Connecting HDMI equipment

You can use the INPUT4 terminal when connecting HDMI equipment.

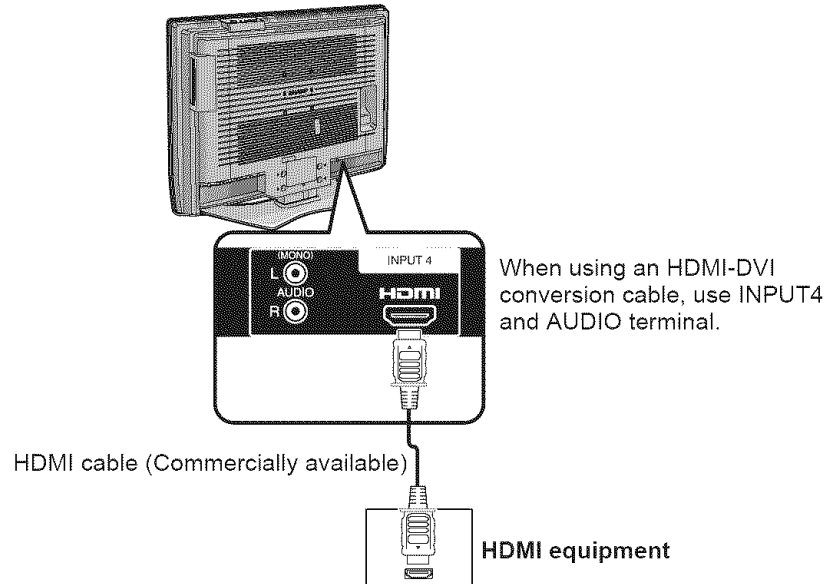

### Displaying an image from HDMI equipment

- 1 To watch an HDMI equipment image, select "INPUT4" from "SOURCE SELECTION" menu using **INPUT** on the remote control unit or on the TV/DVD. (See page 25.)

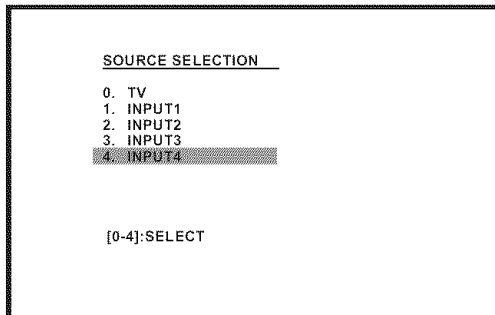

#### NOTE

- Refer to your external equipment operation manual for the signal type.

### Selecting HDMI audio input source

- 1 Press **TV MENU** and the MENU screen displays.

- 2 Press **◀/▶** to select (AUDIO).

- 3 Press **▲/▼** to select "HDMI".

- 4 Press **◀/▶** to select "HDMI" or "DVI".

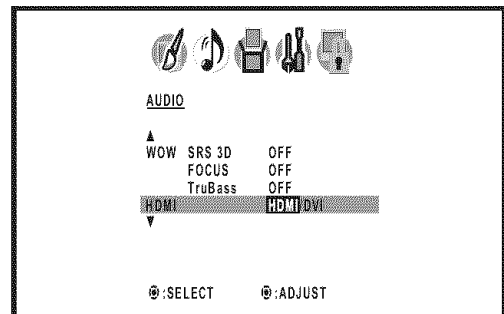

**HDMI:** When you connect the HDMI device to the TV/DVD, select this setting.

**DVI:** When you connect the DVI device to the TV/DVD with analog audio cords, select this setting.

- 5 Press **EXIT** to return to the normal screen.

# Useful adjustment settings

## Reset

If complex adjustments are made and the settings cannot be restored to normal, you can reset the settings to the factory preset values.

### Resetting picture adjustments

Each picture adjustments return to the following factory settings:

AV MODE ..... STANDARD  
BRIGHTNESS / COLOR / SHARPNESS ..... center (25)  
CONTRAST ..... (40)  
TINT ..... center (0)  
COLOR TEMPERATURE ..... MEDIUM

**1** Press **TV MENU** and the MENU screen displays.

**2** Press **◀/▶** to select  (PICTURE).

**3** Press **▲/▼** to select "RESET", and then press **◀/▶**.

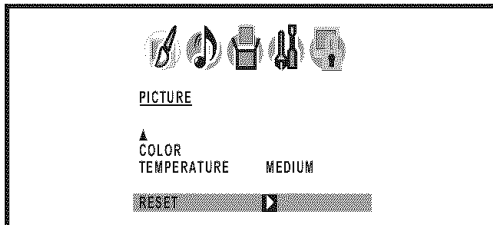

**4** The TV screen return to the normal screen, and "RESET" will be displayed a few seconds.

### Resetting audio adjustments

Each audio adjustments return to the following factory settings:

BASS .....center (25)      BALANCE ..... center (0)  
TREBLE.....center (25)

**1** Press **TV MENU** and the MENU screen displays.

**2** Press **◀/▶** to select  (AUDIO).

**3** Press **▲/▼** to select "RESET", and then press **◀/▶**.

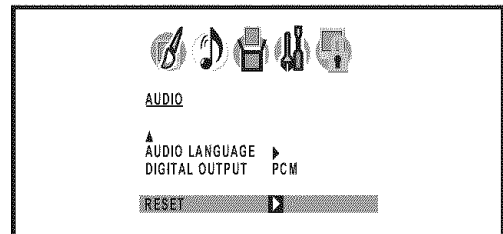

**4** The TV screen return to the normal screen, and "RESET" will be displayed a few seconds.

## NOTE

- The channel setup settings will not be changed.
- The language settings will not be changed.
- The password number setting will not be changed.



## Useful adjustment settings

### AV mode

AV mode gives you four viewing options to choose from to best match the surrounding environment of the TV/DVD, which can vary due to factors like room brightness, type of program watched or the type of image input from external equipment.

- 1 Press **TV MENU** and the MENU screen displays.
- 2 Press **◀/▶** to select  (PICTURE).
- 3 Press **▲/▼** to select "AV MODE".
- 4 Press **◀/▶** to select the mode you prefer.
  - The mode can be chosen from list below.

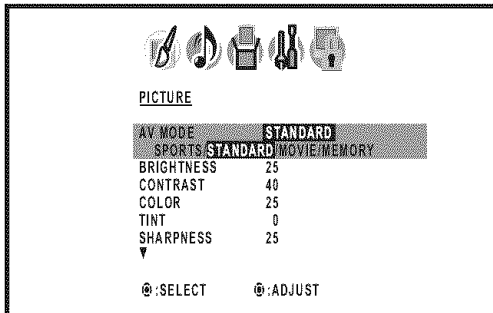

Selected item	Description
<b>SPORTS</b>	For a clear-cut image emphasizing high contrast, useful for sports viewing
<b>STANDARD</b>	For a highly defined image in a normal lighting
<b>MOVIE</b>	For a movie
<b>MEMORY</b>	Allows the user to customize settings as desired. You can set the mode for each input source.

- 5 Press **EXIT** to return to the normal screen.

### NOTE

- You can select a different AV MODE item for each input mode. (For example, select STANDARD for TV input and SPORTS for VIDEO input.)

### Selecting the digital audio language

When two or more audio languages are included in a digital signal, you can select one of the audio languages.

- 1 Press **TV MENU** and the MENU screen displays.
- 2 Press **◀/▶** to select  (AUDIO).
- 3 Press **▲/▼** to select "AUDIO LANGUAGE", and then press **◀/▶**.

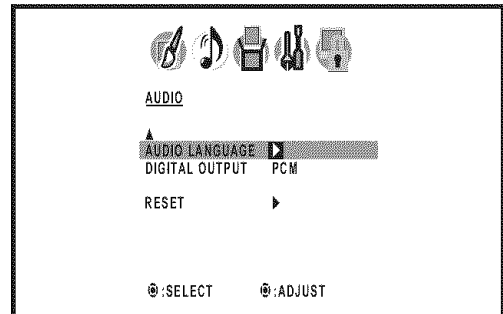

- 4 Press **▲/▼** to select your desired language, then press **ENTER**.

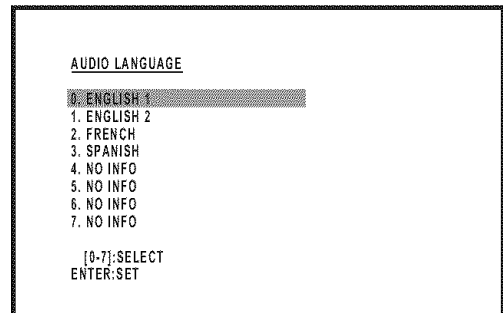

- 5 Press **EXIT** to return to the normal screen.

### View mode for 4:3 programs

- 1 Press **VIEW MODE**.
  - The View mode menu displays.
  - The menu lists the view mode options selectable for the type of video signal currently being received.
- 2 Press **0-3** to select each view mode directly while the View mode menu is still on the screen.
  - Each time **VIEW MODE** is pressed, **VIEW MODE** item toggles.
  - You can also select **VIEW MODE** item by pressing **▲/▼**.
  - You can sequentially select a view mode that has its own aspect ratio.

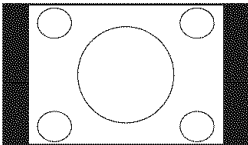
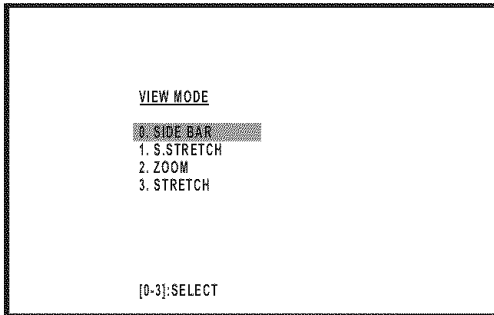

**SIDE BAR:**  
Suitable for viewing conventional 4:3 programs in their normal format.

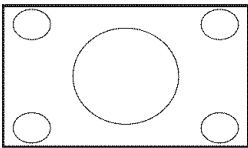

**S. STRETCH (Smart stretch):**  
Suitable for stretching 4:3 programs to fill the screen.

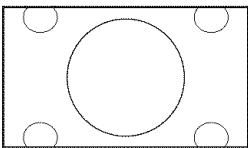

**ZOOM:**  
Suitable for viewing wide-screen 2.35:1 anamorphic DVDs in full screen.

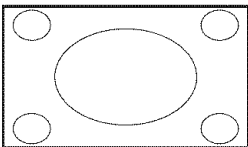

**STRETCH:**  
This mode is useful for 1.78:1 DVDs. When viewing 1.85:1 DVDs, stretch mode will still show very thin black bands at the top and bottom of the screen.

**NOTE**

- You can enter to the same menu screen from **(SETUP)** menu.
- In **ZOOM** mode, some of the on-screen display items may be positioned off the visible portion of the screen. You can use Picture Scroll, as explained on the right, to view off screen items.
- When this function is not available, "NOT AVAILABLE" will display.

### View mode for HD programs

Stretch mode is available for HD programs. Suitable for viewing wide-screen 1.78:1 aspect-ratio programs. When viewing 1.85:1 programs, the stretch mode will still show very thin black bands at the top and bottom of the screen.

### Picture scroll

For adjusting a picture's vertical position in **ZOOM** mode.

- 1 Press **TV MENU** and the MENU screen displays.
- 2 Press **◀/▶** to select **(SETUP)**.
- 3 Press **▲/▼** to select "PICTURE SCROLL", and then press **◀/▶**.
- 4 **SCROLL ADJUSTMENT** screen displays. To raise the picture, press **▲**. To lower the picture, press **▼**.



The scroll amounts are as follows:

- 480i/480p signal source:  
ZOOM: -10 to +20

- 5 Press **EXIT** to return to the normal screen.

**NOTE**

- In **SIDE BAR**, **S. STRETCH** and **STRETCH** mode, **PICTURE SCROLL** will not work.

### Aspect

When the **ASPECT** is set to **ON** and the TV receives a 480i signal, the picture size is automatically selected (as described in the following table).

- 1 Press **TV MENU** and the MENU screen displays.
- 2 Press **◀/▶** to select **(SETUP)**.
- 3 Press **▲/▼** to select "ASPECT", and then press **◀/▶** to select "ON" or "OFF".
- 4 Press **EXIT** to return to the normal screen.

Aspect ratio of signal source	Automatic aspect size (when ASPECT is ON)
4:3 Normal	SIDE BAR
16:9 Full	STRETCH
4:3 Letter box	ZOOM
Not defined	User-set mode

## Useful adjustment settings

### Audio output select

Allows you to select what controls the audio output.

- 1 Press **TV MENU** and the MENU screen displays.
- 2 Press **◀/▶** to select  (AUDIO).
- 3 Press **▲/▼** to select "SPEAKERS".
- 4 Press **◀/▶** to select "ON" or "OFF".

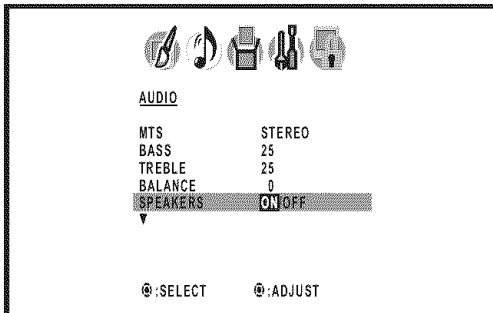

Selected item	Description
ON	<ul style="list-style-type: none"> <li>• Sound via speaker is adjusted with <b>VOL +/-</b> on the remote control unit or <b>VOL +/-</b> on the TV/DVD.</li> <li>• Sound via the AUDIO OUTPUT terminal is not adjustable and outputs at a consistent level.</li> </ul>
OFF	<ul style="list-style-type: none"> <li>• Sound via the AUDIO OUTPUT terminal is adjusted with <b>VOL +/-</b> on the remote control unit or <b>VOL +/-</b> on the TV/DVD.</li> <li>• Sound via speaker is muted.</li> </ul>

- 5 Press **EXIT** to return to the normal screen.

### Setting WOW™ surround sound

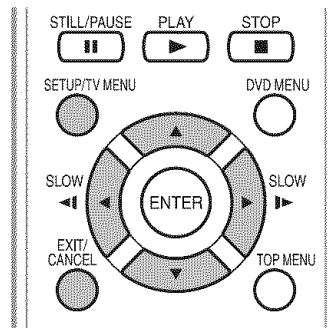

### SRS WOW

SRS WOW is a special combination of SRS Labs audio technologies that creates a thrilling surround sound experience with deep, rich bass from stereo sound sources. Your TV/DVD's audio will sound fuller, richer, and wider. SRS WOW consists of three features; SRS 3D, FOCUS, and TruBass.

- 1 Select STEREO mode (see "Setting MTS/SAP stereo mode" on page 20).
- 2 Press **TV MENU** and the MENU screen displays.
- 3 Press **◀/▶** to select  (AUDIO).
- 4 Press **▲/▼** to select the desired WOW feature you want to adjust.

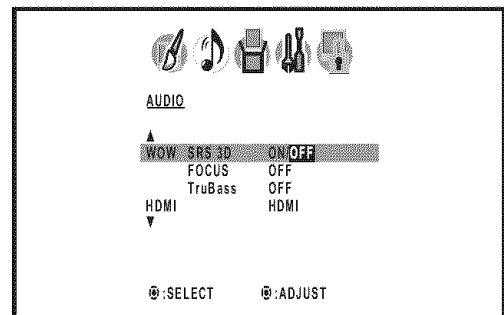

- SRS 3D:** Press **◀/▶** to turn on or off the surround sound effect.
- FOCUS:** Press **◀/▶** to turn on or off the vocal emphasis effect.
- TruBass:** Press **◀/▶** to select the bass expansion effect high, low or off.

- 5 After your desired setting, press **EXIT** to return to the normal screen.

## Useful adjustment settings

### Closed captions and digital closed captions

Your TV/DVD is equipped with an internal Closed Caption decoder. It allows you to view conversations, narration and sound effects as subtitles on your TV/DVD. Closed Captions are available on some TV programs and on some VHS home video tapes at the discretion of the program provider.

Digital Closed Caption service is a new caption service available only on digital TV programs (also at the discretion of the service provider). It is a more flexible system than the original Closed Caption system, because it allows a variety of caption sizes and font styles. When the Digital Closed Caption service is in use, it will be indicated by the appearance of a 3-letter abbreviation that also indicates the language of the Digital Closed Captions: ENG (English), SPA (Spanish), FRA (French) or other language codes.

Not all programs and VHS videotapes offer closed captions. Please look for the "CC" symbol to ensure that captions will be shown.

In the Closed Caption system, there can be more than one caption service provided. Each is identified by its own number. The "C1" and "C2" services display subtitles of TV programs superimposed over the program's picture. Generally, Closed Captions in English are transmitted on C1 and Closed Captions in other languages are transmitted on C2.

In the Closed Caption system, the "Text1" or "Text2" services display text that is unrelated to the program being viewed (e.g., weather or news). These services are also superimposed over the program currently being viewed.

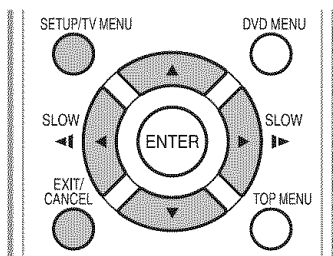

1

Tune the TV to the desired program.

2

Press **TV MENU** and the MENU screen displays.

3

Press ◀/▶ to select  (SETUP).

4

Press ▲/▼ to select "CLOSED CAPTION".

5

Press ◀/▶ to select your desired Closed Caption mode.

- When an Analog signal is received, you can choose C1, C2, T1, T2 and OFF.

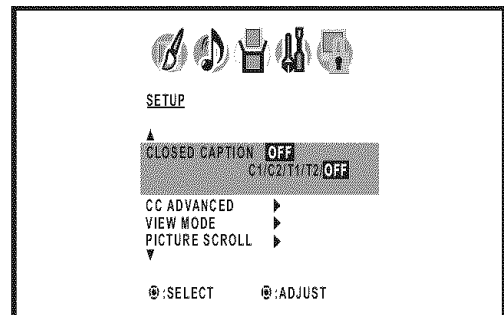

- When a Digital signal is received, you can choose from CS1, CS2, CS3, CS4, CS5, CS6, C1, C2, C3, C4, T1, T2, T3, T4 and OFF.

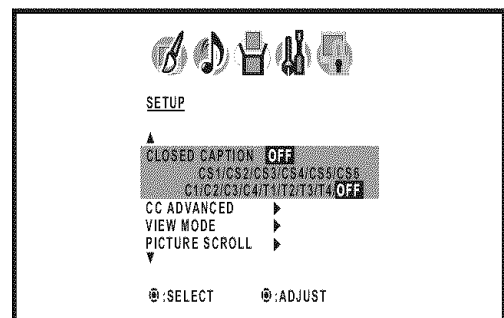

- Depending on the broadcast signal, some Analog Captions will function with a Digital broadcast signal.

6

Press **EXIT** to return to the normal screen.

#### NOTE

- To turn the Closed Caption feature off, select "OFF".

#### NOTE

- If the program or video you selected is not closed-captioned, no captions will display on-screen.
- If text is not available in your viewing area, a black rectangle may appear on-screen. If this happens, set the Closed Caption feature to "OFF".
- When selecting Closed Captions, the captioning will be delayed approx. 10 seconds.
- If no caption signal is received, no captions will appear, but the television will remain in the Caption Mode.
- Misspellings or unusual characters may occasionally appear during Closed Captioning. This is normal with Closed Captioning, especially with live programs. This is because during live programs, captions are also entered live. These transmissions do not allow time for editing.
- When Captions are being displayed, on-screen displays, such as volume and mute may be seen but may interfere with Closed Captions.
- Some Cable TV systems and copy protection systems may interfere with the Closed Captioned signal.
- If using an indoor antenna or if TV reception is very poor, the Closed Caption Decoder may not appear or may appear with strange characters or misspelled words. In this case, adjust the antenna for better reception or use an outdoor antenna.

## Useful adjustment settings

### Caption setup

This function allows you to adjust the closed caption screen appearance to suit your preference.

1 Press **TV MENU** and the MENU screen displays.

2 Press ◀/▶ to select  (SETUP).

3 Press ▲/▼ to select "CC ADVANCED", and then press ◀/▶. The CC ADVANCED menu displayed.

- You can adjust 5 items here.

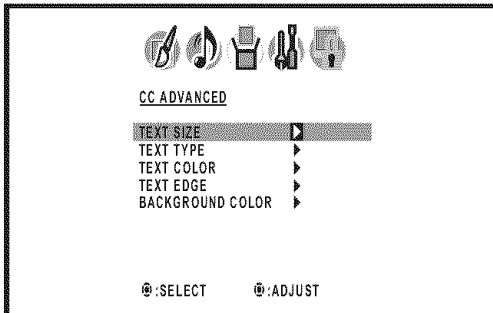

4 Press ▲/▼ to select a specific adjustment item, then press ◀/▶. The selectable parameter of each item will appear.

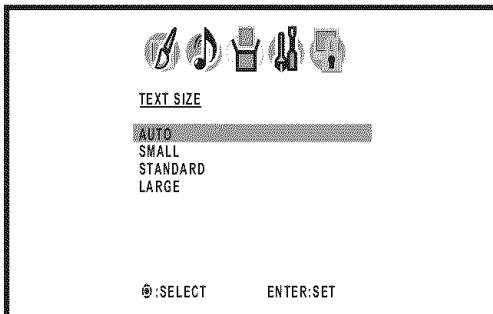

5 Press ▲/▼ to select the desired parameter.

6 Press **EXIT** to return to the normal screen.

Selectable parameters available in each adjustment item.

Item	Selectable parameter
<b>TEXT SIZE:</b>	AUTO, SMALL, STANDARD, LARGE
<b>TEXT TYPE:</b>	AUTO, DEFAULT, MONO W. SERIF, PROP. W. SERIF, MONO W/O SERIF, PROP. W/O SERIF, CASUAL, CURSIVE, SMALL CAPITALS
<b>TEXT COLOR:</b>	AUTO, BLACK, WHITE, RED, GREEN, BLUE, YELLOW, MAGENTA, CYAN
<b>TEXT EDGE:</b>	AUTO, NONE, RAISED, DEPRESSED, UNIFORM, LEFT DROP SHADOW, RIGHT DROP SHADOW
<b>BACKGROUND COLOR:</b>	AUTO, BLACK, WHITE, RED, GREEN, BLUE, YELLOW, MAGENTA, CYAN

#### NOTE

- This feature is designed to customize Digital Captions only.
- The "AUTO" value depends on the broadcasting station.

## Password setting for parental control

Allows you to use a password to protect certain settings from being accidentally changed.

### IMPORTANT:

Three conditions must be met to enable the V-Chip

- ① Password is registered.
- ② V-CHIP settings have been made.
- ③ "V-CHIP" is set to "ON".

### Setting a password

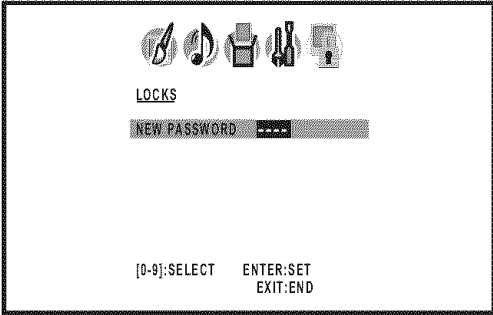
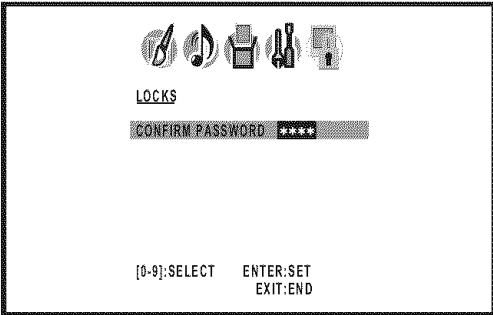
- 1 Press **TV MENU** and the MENU screen displays.
- 2 Press **◀/▶** to select  (LOCKS).
- 3 Press **▲/▼**. The password entering menu displays.
- 4 Select and enter a password (4 digits) using the **number buttons (0–9)**, then press **ENTER**.  

- 5 Enter the same password again to confirm, then press **ENTER**, the password is now registered and the LOCKS menu will appear on the screen.  

"\*" appears instead of the number.

## Changing the password

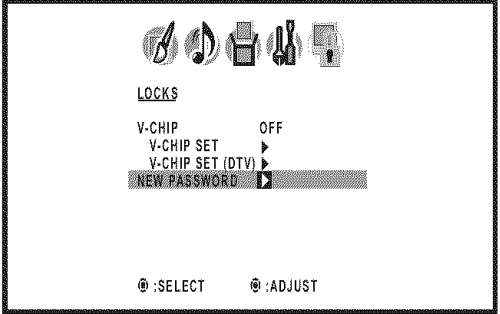
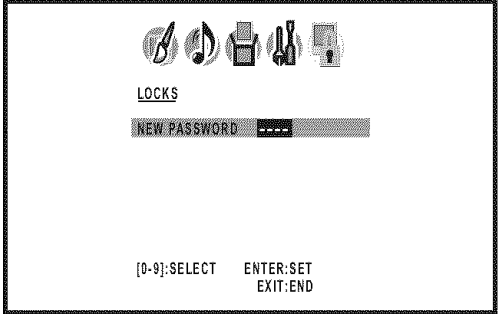
Allows you to change your current password.

- 1 Repeat steps 1 to 3 in **setting a password**.
  - The password entering menu displays.
- 2 Input the 4-digit password by using **0–9**, then press **ENTER**.
- 3 Press **▲/▼** to select "NEW PASSWORD", then press **◀/▶**.  

- 4 Enter a new password using **0–9**, then press **ENTER**.  

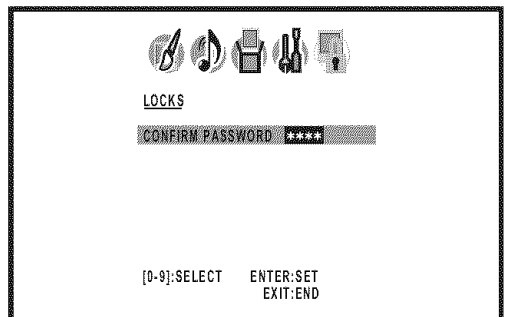
- 5 Enter the same password again to confirm, then press **ENTER**.



- 6 The screen returns to LOCKS menu. Your new password has been set.

### NOTE

- As a precautionary measure, make a note of your password and keep it in a familiar place.
- The "V-CHIP SET (DTV)" will only be selectable when a new rating system can be downloaded via digital broadcasting in the U.S.

## Useful adjustment settings

### Parental control (V-CHIP)

V-CHIP is an electronic filtering device built into your TV. This tool gives parents a great degree of control over broadcasts accessed by their children. It allows parents to select programs judged suitable for child viewing while blocking ones judged not suitable. It does so automatically once you activate the V-CHIP feature in your TV.

**V-CHIP SET menu will not be selectable from the menu if you do not first configure your password.**  
(See page 34 for password setting for parental control.)

- The U.S. has two rating systems for viewing content: movie ratings and TV Parental Guidelines.
- The TV Parental Guidelines work in conjunction with the V-CHIP to help parents screen out inappropriate television shows from their children.
- Movie ratings are used for original movies rated by the Motion Picture Association of America (MPAA) as watched on cable TV and not edited for television. The V-CHIP can also be set to block MPAA-rated movies.

### TV Parental Guidelines

TV RATING		Content				
		FANTASY VIOLENCE	VIOLENCE	SEXUAL SITUATIONS	ADULT LANGUAGE	SEXUAL DIALOG
Suggested age	TV-Y (All children)					
	TV-Y7 (Directed to older children)	X				
	TV-G (General audience)					
	TV-PG (Parental Guidance suggested)		X	X	X	X
	TV-14 (Parents strongly cautioned)		X	X	X	X
	TV-MA (Mature audience only)		X	X	X	

X: Content rating can be set.

### Voluntary movie rating system (MPAA)

MOVIE RATING	Description
G	General audiences. All ages admitted.
PG	Parental guidance suggested. Some material may not be suitable for children.
PG-13	Parents strongly cautioned. Some material may be inappropriate for children under 13.
R	Restricted. Under 17 requires accompanying parent or adult guardian (age varies in some jurisdictions).
NC-17	No one 17 and under admitted.
X	X is an older rating that is unified with NC-17 but may be encoded in the data of older movies.

#### EXAMPLE

- If you select "PG-13", this will automatically block the higher ratings "R", "NC-17" and "X".

#### NOTE

- Voluntary movie rating system only uses an age-based rating.

### TV Parental Guidelines (TV Guidelines)

- 1 Press **TV MENU** and the MENU screen displays.
- 2 Press **◀/▶** to select  (LOCKS).
- 3 Press **▲/▼**. The password entering menu displays.
- 4 Input the 4-digit password by using **0–9**, then press **ENTER**. The LOCKS menu displays.
- 5 Press **▲/▼** to select "V-CHIP SET", then press **◀/▶**. The V-CHIP SET menu displays.
- 6 Press **▲/▼** to select "TV RATING". Then press **◀/▶** to select the desired rating.

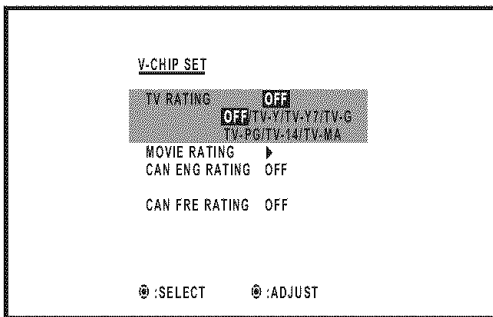

- When you select TV-Y7, TV-PG, TV-14 or TV-MA, "DISPLAY TO SET CONTENTS" will appear on the screen. Press **DISPLAY** to explain the rating. Press **▲/▼** to select the desired rating you want. Press **◀/▶** to select the setting "ON" or "OFF". Then press **RETURN**.
- See page 35 for setting details.

- 7 Press **RETURN**. The LOCKS menu displays.

- 8 Press **▲/▼** to select "V-CHIP", then press **◀/▶** to select "ON".

Your setting are now set into memory.

- If "V-CHIP" is not set to "ON", the V-CHIP setting will not work.

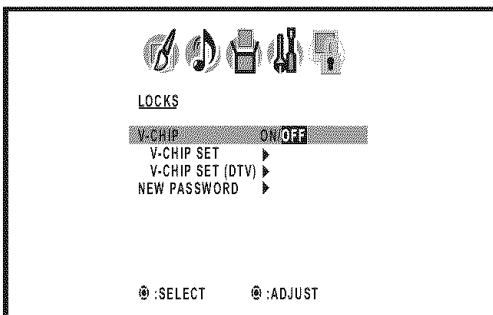

- 9 Press **EXIT** to return to the normal screen.

### Voluntary movie rating system (MPAA)

- 1 Repeat steps 1 to 5 in **TV Parental Guidelines (TV Guidelines)**.
- 2 Press **▲/▼** to select "MOVIE RATING". Then press **◀/▶**. The RATING SET menu displays.  
Press **▲/▼** to select desired setting, then press **◀/▶** to select the settings "ON" or "OFF".

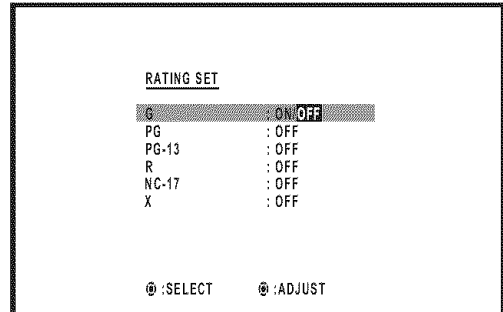

- See page 35 for setting details.

- 3 Press **EXIT** to return to the normal screen.



## Useful adjustment settings

### Canadian rating systems

- The TV rating systems in Canada are based on the Canadian Radio-Television and Telecommunications Commission (CRTC) policy on violence in television programming.
- While violence is the most important content element to be rated, the structure developed takes into consideration other program content like language, nudity, sexuality and mature themes.
- When setting the V-CHIP on the Canadian system you can choose either the Canadian English ratings or the Canadian French ratings.

#### Canadian English ratings

Rating		Description
Age	E	Exempt: Includes news, sports, documentaries and other information programming; talk shows, music videos, and variety programming.
	C	Children: Intended for younger children under the age of 8 years. Pays careful attention to themes that could threaten their sense of security and well-being.
	C8+	Children over 8 years old: Contains no portrayal of violence as the preferred, acceptable, or only way to resolve conflict; nor encourage children to imitate dangerous acts which they may see on the screen.
	G	General: Considered acceptable for all age groups. Appropriate viewing for the entire family, contains very little violence, physical, verbal or emotional.
	PG	Parental Guidance: Intended for a general audience, but may not be suitable for younger children (under the age of 8) because it could contain controversial themes or issues.
	14+	Over 14 Years: Could contain themes where violence is one of the dominant elements of the storyline, but it must be integral to the development of plot or character. Language usage could be profane and nudity present within the context of the theme.
	18+	Adults: Intended for viewers 18 years and older and might contain depictions of violence, which while related to the development of plot, character or themes, are intended for adult viewing. Could contain graphic language and portrayals of sex and nudity.

#### Canadian French ratings

Rating		Description
Age	E	Exempt programming.
	G	General: All ages and children, contains minimal direct violence, but may be integrated into the plot in a humorous or unrealistic manner.
	8ans+	General but inadvisable for young children: May be viewed by a wide public audience, but could contain scenes disturbing to children under 8 who cannot distinguish between imaginary and real situations. Recommended for viewing with parent.
	13ans+	Over 13 years: Could contain scenes of frequent violent scenes and therefore recommended for viewing with parent.
	16ans+	Over 16 years: Could contain frequent violent scenes and intense violence.
	18ans+	Over 18 years: Only for adult viewing. Could contain frequent violent scenes and extreme violence.

## Useful adjustment settings

### Canadian English ratings

- 1 Press **TV MENU** and the MENU screen displays.
- 2 Press **◀/▶** to select **🔒 (LOCKS)**.
- 3 Press **▲/▼**. The password entering menu displays.
- 4 Input the 4-digit password by using **0–9**, then press **ENTER**.  
The LOCKS menu displays.
- 5 Press **▲/▼** to select “V-CHIP SET”, then press **◀/▶**. The V-CHIP SET menu displays.
- 6 Press **▲/▼** to select “CAN ENG RATING”. Then press **◀/▶** to select the desired rating.

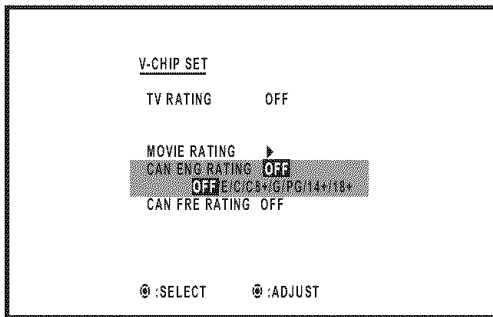

- See page 37 for setting details.

- 7 Press **RETURN**. The LOCKS menu displays.
- 8 Press **▲/▼** to select “V-CHIP”, then press **◀/▶** to select “ON”.  
Your settings are now set into memory.
  - If “V-CHIP” is not set to “ON”, the V-CHIP setting will not work.

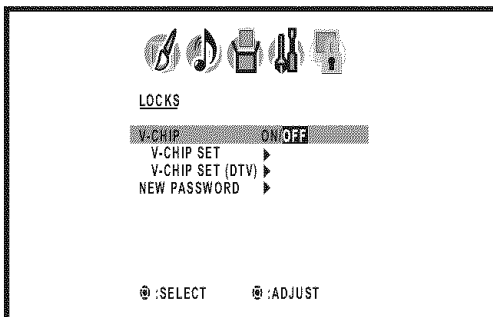

- 9 Press **EXIT** to return to the normal screen.

### Canadian French ratings

- 1 Repeat steps 1 to 5 in **Canadian English ratings**.
- 2 Press **▲/▼** to select “CAN FRE RATING”. Then press **◀/▶** to select the desired rating.

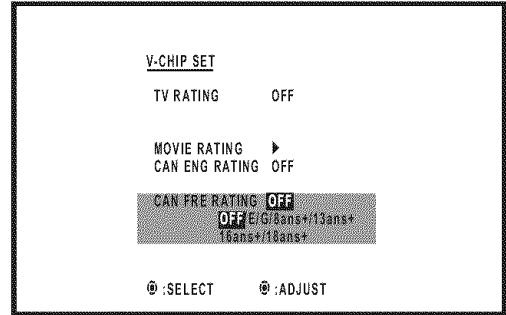

- See page 37 for setting details.

- 3 Press **EXIT** to return to the normal screen.

### How to temporarily release the V-CHIP block

The V-CHIP block is working and censors a broadcast, “THIS PROGRAM HAS BEEN BLOCKED!” displays.

- 1 Press **MUTE** while the V-CHIP is working and then the password entering menu displays.
- 2 Enter your 4-digit password with **0–9**. At this time V-CHIP block temporarily releases.

### Reactivating the temporarily released V-CHIP block

You can reactivate the temporarily released V-CHIP block as shown below.

#### Method 1:

Change to the other channel.

#### Method 2:

Switch off the TV/DVD power.

#### NOTE

- Performing any of the two above will activate the V-CHIP block.

# Other viewing options

---

## Signal meter

In order to receive digital air broadcasts, you need a digital broadcast antenna. You can confirm the antenna configuration through the "SIGNAL METER" menu.

If necessary, adjust the direction of the antenna to obtain the maximum signal strength.

### Signal strength

1

Press **TV MENU** and the MENU screen displays.

2

Press ◀/▶ to select  (SETUP).

3

Press ▲/▼ to select "SIGNAL METER".

4

Press ◀/▶.

- The strength of the digital signal is displayed. The signal information is based on the current channel.

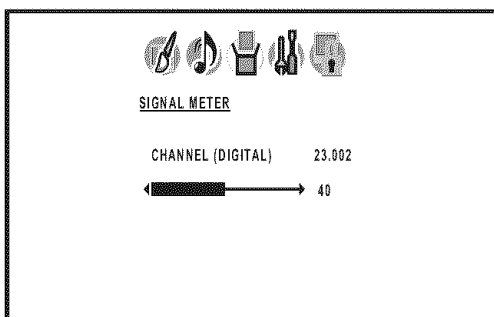

5

Press **EXIT** to return to the normal screen.

# Watching the DVD

Simple operations for watching a DVD.

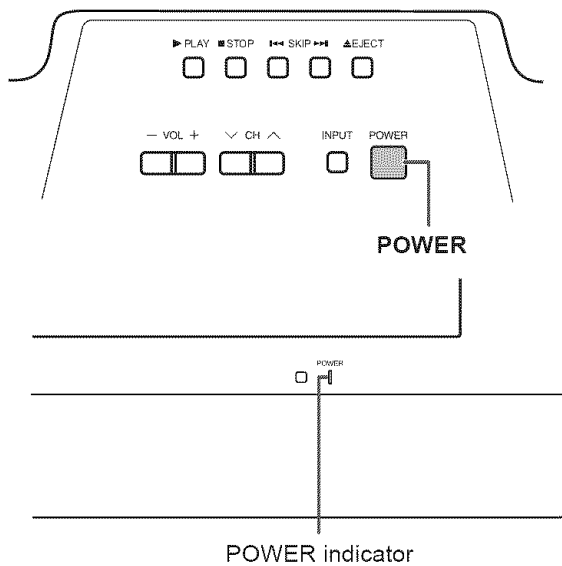

TV/DVD status indicator (POWER)

ON	Lighting (Green)
OFF/Standby	Lighting (Red)

POWER (On/Standby)  
TV/DVD

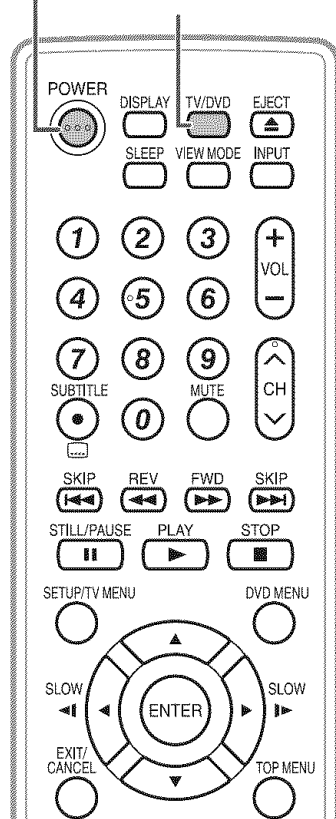

## Preparation

Perform the following steps before you press **POWER** on the remote control unit.

1. Insert the batteries into the remote control unit. (See page 10.)
2. Connect the antenna cable to the TV/DVD. (See page 15.)
3. Plug in the AC cord to the AC outlet. (See page 9.)

## Turning on the power

Press **POWER** on the TV/DVD, or **POWER** on the remote control.

- POWER indicator (Green): The TV/DVD is on. ("PLEASE WAIT" will appear for a few seconds on the screen.)

## Select the DVD mode

Press **TV/DVD** to select the DVD mode.

## Turning off the power

Press **POWER** on the TV/DVD, or **POWER** on the remote control.

- The TV/DVD enters standby mode and the image on the screen disappears.
- The POWER indicator on the TV/DVD changes to Red.

## NOTE

- If you are not going to use this TV/DVD for a long period of time, be sure to remove the AC cord from the power outlet.
- Weak electric power is still consumed even when **POWER** is turned off.
- If a station being viewed stops broadcasting, the TV/DVD will automatically shut itself off after 15 minutes. (TV mode only.)

## Watching the DVD

### Playback procedure

1

Place the disc in the disc slot with the label side facing forward. (If the disc has a label.) Hold the disc without touching its surface, align it with the guides, and place it in position.

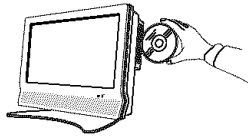

2

On the screen, "▲" changes to "Reading" and then playback will commence.

- A menu screen appear on the TV screen, if the disc has a menu feature. In this case, press ▲/▼/◀/▶ or ENTER to operate a menu feature.



3

Press **STOP** to end playback.

- The unit memorizes the stopped point, depending on the disc. "■" appears on the screen. Press **PLAY** to resume playback (from the scene point).
- If you press **STOP** again ("■" appears on the screen) or unload the disc, the TV/DVD will clear the stopped point.

4

Press **EJECT**.

Remove the disc and then press **POWER**. The TV/DVD turns off.

When you eject the disc, you may hear mechanism noise, but it is not malfunction.

### Status display of disc

Press **DISPLAY**. The status display of the disc will appear on the screen in order like the figure below.

#### DVD

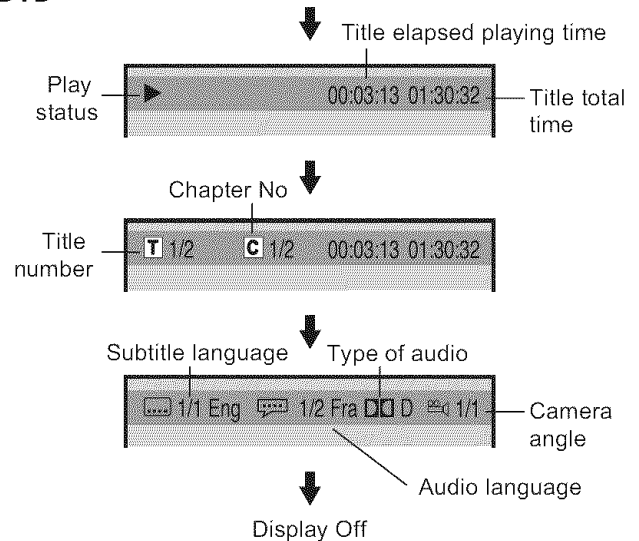

#### Audio CD

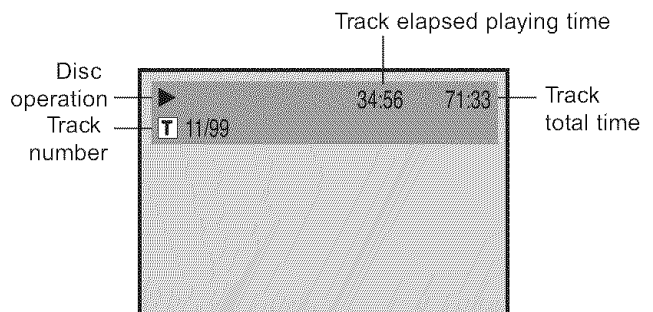

- When you play a CD disc, the status display will appear and remain on the screen.

#### NOTE

**If the TV/DVD does not operate properly:**

Static electricity, etc., may affect the player's operation. Disconnect the AC power cord once, then connect it again.

#### NOTE

- If a non-compatible disc is loaded, "Incorrect Disc", "Region Code Error" or "Parental Error" will appear on the TV screen according to the type of loaded disc. If these appear, check your disc again (see pages 6 and 52).
- Some discs may take a minute or so to start playback.
- When an 8 cm disc is placed into the disc slot, and the playback picture or menu display does not appear, press **PLAY**.
- A "Prohibition" symbol (⊞) may appear at the upper left of the screen. This symbol means either the feature you tried is not available on the disc, or the TV/DVD cannot access the feature at this time. This does not indicate a problem with the TV/DVD.
- When you set a single-faced disc label downwards (i.e. the wrong way up) "Reading" will appear on the display and then "Incorrect Disc" will be displayed.
- Some playback operations of DVDs may be intentionally fixed by software producers. Since this TV/DVD plays DVDs according to the disc content recorded, some playback features may not be available. Also refer to the instructions supplied with the DVDs.

## Special playback

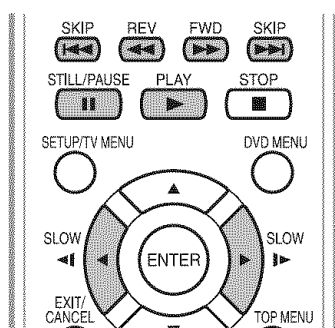

### Fast Forward Playback

Press **FWD** during normal playback.

Each press of **FWD** will increase the speed of the search

▶▶ (x 2), ▶▶▶▶ (x 4), ▶▶▶▶▶▶ (x 8), ▶▶▶▶▶▶▶▶ (x 15).  
 (CD: ▶▶ (x 2), ▶▶▶▶ (x 4), ▶▶▶▶▶▶ (x 8), ▶▶▶▶▶▶▶▶ (x 20))

- To resume normal playback, press **PLAY**.
- The above figure shown in parentheses indicates the average speed multiplier.

### Review Playback

Press **REV** during normal playback.

Each press of **REV** will increase the speed of the search

◀◀ (x 2), ◀◀◀◀ (x 4), ◀◀◀◀◀◀ (x 8), ◀◀◀◀◀◀◀◀ (x 15).

(CD: ◀◀ (x 2), ◀◀◀◀ (x 4), ◀◀◀◀◀◀ (x 8), ◀◀◀◀◀◀◀◀ (x 20))

- To resume normal playback, press **PLAY**.
- The above figure shown in parentheses indicates the average speed multiplier.

### Still Playback

Press **STILL/PAUSE** during normal playback to pause playback.

- To resume normal playback, press **PLAY**.



### Frame Advance

Press **STILL/PAUSE** during still playback.

One frame is advanced each time you press **STILL/PAUSE**.

- To resume normal playback, press **PLAY**.

### Slow-motion Playback

Press **SLOW** (▶) or **SLOW** (◀) during normal playback or still playback.

Each press of **SLOW** will change the speed of the slow x1/2, x1/4, x1/6, x1/7.

- To resume normal playback, press **PLAY**.
- To resume the still playback, press **PAUSE/STILL**.

### Locating a chapter or track

Press **SKIP** (▶▶) Forward or **SKIP** (◀◀) Reverse during playback to locate a chapter that you want to watch.

Each time you press the button, a chapter or track is skipped.

### NOTE

The TV/DVD is capable of holding a still video image or On screen display image on your television screen indefinitely. If you leave the still video image or On screen display image displayed on your TV for an extended period of time, you risk permanent damage to your television screen.

## Zooming

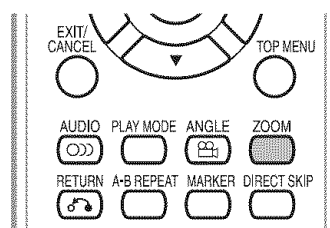

This TV/DVD will allow you to zoom in on the frame image. You can then make selections by switching the position of the frame.

1

Press **ZOOM** during playback.

The center part of the image will be zoomed in.

Each press of **ZOOM** will change the ZOOM magnification Q1 (x 1.3), Q2 (x 1.5) and Q3 (x 2.0).

2

Press ▲/▼/◀/▶ to view a different part of the frame.

You may move the frame from the center position UP, DOWN, LEFT or RIGHT.

3

In the zoom mode press **ZOOM** repeatedly to return to a 1:1 view (QOff).

### NOTE

- You can select the Still Playback or Fast Forward (Review) Playback in the zoom mode.
- Some discs may not respond to zoom feature.

## Locating desired scene

Use the title, chapter and time recorded on the disc to locate the desired point to play back.

1

Press **DIRECT SKIP** during playback.

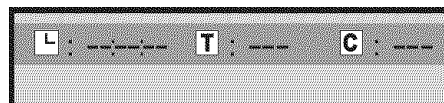

2

Press ◀/▶ to select the "□" (Time), "T" (Title) or "C" (Chapter).

3

Press **Number buttons (0-9)** to input the number.

- If you input a wrong number, press **CANCEL**.
- Refer to the package supplied with the disc to check the numbers.

4

Press **ENTER**.

- Playback starts.
- When you change the title, playback starts from Chapter 1 of the selected title.
- Some discs may not work in the above operation.

### Repeat playback

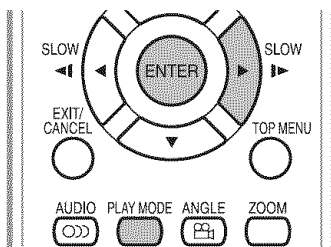

**1** Press **PLAY MODE** during playback or stop mode.

**2** Press **ENTER** to select "Chapter" or "Title".  
 • In case of Audio-CD, first press **▶** to select "Repeat" and then press **ENTER** to select "Track" or "All".

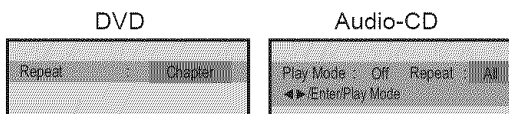

Press **PLAY MODE** again to make the screen disappear.  
 • Press **PLAY** to start Repeat playback.  
 • To resume normal playback, select Repeat "Off".

#### NOTE

- Some discs may not be compatible with the repeat operation.

### A-B Repeat playback

A-B repeat playback allows you to repeat material between two selected points.

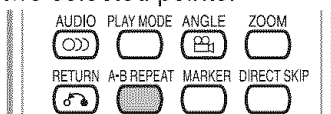

**1** Press **A-B REPEAT** during playback. The start point is selected.

**2** Press **A-B REPEAT** again. The end point is selected. Playback starts at the point that you selected. Playback stops at the end point, returns to Point A automatically, then starts again.

- To resume normal playback press **A-B REPEAT** again.  
 "Off" appears on the screen.

#### NOTE

- In A-B Repeat mode, subtitles near the A or B locations may not be displayed.
- You cannot set the A-B Repeat for the scenes that include multiple angles.
- You may not be able to set A-B Repeat during certain scenes of the DVD.
- A-B Repeat does not work with an interactive DVD, MP3/WMA/JPEG-CD.

### Marking desired scenes

The TV/DVD stores the points that you want to watch again up to 3 points. You can resume playback from each scene.

#### Marking the scenes

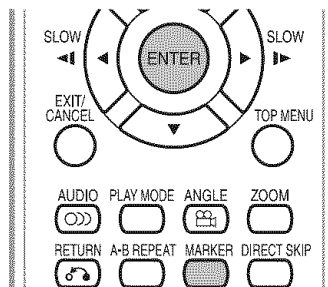

**1** Press **MARKER** during playback.

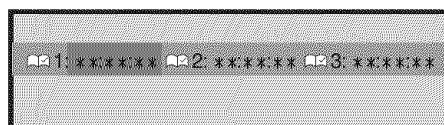

**2** Select the blank Marker using **◀/▶**, then press **ENTER** at the desired scene.  
 • Up to 3 scenes can be selected.  
 • Repeat this procedure to set the other 2 scenes.

**3** Press **MARKER** to return to the normal screen.

#### Returning to the scenes

**1** Press **MARKER** during playback or stop mode.

**2** Press **◀/▶** to select the Marker 1-3.

**3** Press **ENTER**. Playback starts from the marked scene.

#### To cancel the Marker

Follow the above steps 1~2, then press **CANCEL**.

#### NOTE

- Some discs may not work with the marking operation.
- The marking is cancelled when you eject the disc or turn the power off.
- Some subtitles recorded around the marker may fail to appear.

### Program playback (only CD)

You can arrange the order of tracks on the disc.

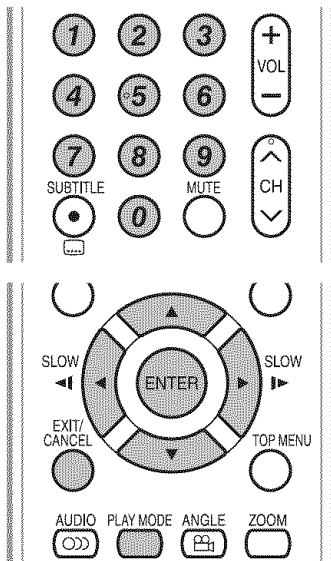

1 Press **PLAY MODE** in the stop mode.

2 Press **◀▶** to select "Play Mode", then press **ENTER** to select "Program".

3 **Example:** In case you wish to program in order of 7, 3, 11:  
Enter as 7 ▼, 3 ▼, 11.  
• If you input a wrong number, press **CANCEL**.

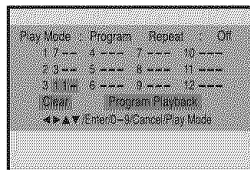

4 Press **▲/▼/◀▶** to select "Program Playback" and press **ENTER**. "Program Playback" will appear on the screen. The program you selected will begin to playback in the order set.  
To return to normal playback, select "Play Mode: Off" at step 2 above.

#### NOTE

- To cancel program play, select "Clear" at step 4 and press **ENTER**.
- The program is cancelled when you eject the disc or turn the power off.

### Random playback (only CD)

1 Press **PLAY MODE** during playback or stop mode.

2 Press **◀▶** to select "Play Mode", then press **ENTER** to select "Random".

3 Press **PLAY**.  
"Random Play" will appear on the screen and Random playback will start.  
To return to normal playback, select "Play Mode : Off" at step 2 above.

#### NOTE

- Random playback cannot be combined with Repeat playback.

### Changing angles

When playing back a disc recorded with multi-angle facility, you can change the view angle.

1 Press **ANGLE** during playback. The current angle will appear.

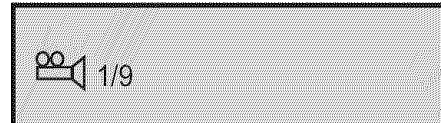

2 Press **ANGLE** repeatedly until the desired angle is selected.

#### NOTE

- In case of JPEG-playback, the JPEG-image is rotated 90 degrees to the right.
- Depending on the DVD, you may not be able to change the angles even if multi-angles are recorded on the DVD.

### Title selection

Two or more titles are recorded on some discs. If the title menu is recorded on the disc, you can select the desired title.

1 Press **TOP MENU** during playback. Title menu appears on the screen.

2 Press **▲/▼/◀▶** to select the desired title.

3 Press **ENTER** or **PLAY**.  
The playback of the selected title will start.

### DVD menu

Some DVDs allow you to select the disc contents using the menu.

When you play back these DVDs, you can select the subtitle language and soundtrack language, etc. using the DVD menu.

1 Press **DVD MENU** during playback. The DVD menu appears on the screen.  
• Press **DVD MENU** again to resume playback at the scene when you pressed **DVD MENU**.

2 Press **▲/▼/◀▶** to select the desired item.

3 Press **ENTER**.  
The menu continues to another screen. Repeat steps 2 and 3 to set additional items if any.

#### NOTE

- Depending on the DVD, you may not be able to select the title. Depending on the DVD, a "title menu" may simply be called a "menu" or "title" in the instructions supplied with the disc.



## Changing soundtrack language

You can select the language when you play a multilingual disc.

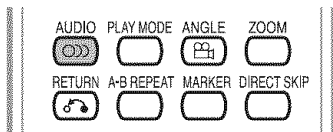

1

Press **AUDIO** during playback. The current soundtrack language will appear.

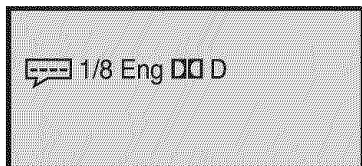

2

Press **AUDIO** repeatedly until the desired language is selected. The on-screen display will disappear after a few seconds.

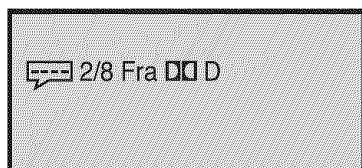

### NOTE

- If the desired language is not heard after pressing **AUDIO** several times, the language is not recorded on the disc.
- Changing soundtrack language is cancelled when you eject the disc. The initial default language or available language will be heard if the disc is played back again.

## Subtitles

### Changing the subtitle language

You can select the language when playing back a disc recorded with multi-lingual subtitles.

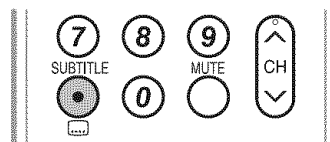

1

Press **SUBTITLE** repeatedly during playback until your desired language appears.

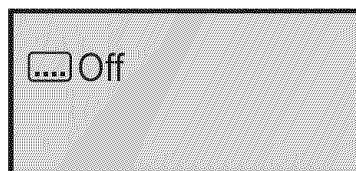

2

The on-screen display will disappear after a few seconds.

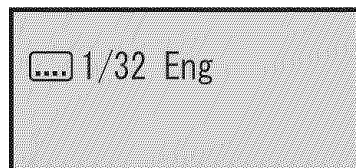

### Turning the subtitles on and off

Press **SUBTITLE** during playback until "Off" appears.

### NOTE

- Changing subtitle language is cancelled when you eject the disc.
- Some functions may not work on some DVDs. You may not be able to turn subtitles on or off or change subtitles. While playing the DVD, the subtitle may change when:
  - you eject or insert the disc.
  - you change the title.
- In some cases, the subtitle language is not changed to the selected one immediately.

# MP3/WMA/JPEG CD playback

This TV/DVD can playback the MP3/WMA/JPEG-data which has been recorded on CD-R or CD-RW. To produce the MP3/WMA/JPEG-data, you need a Windows-PC with CD-R/RW drive and a MP3/WMA/JPEG-encoding Software (not supplied).

The Apple-HFS-System cannot be played.

## NOTE

This TV/DVD requires discs/recordings to meet certain technical standards in order to achieve optimal playback quality. Pre-recorded DVDs are automatically set to these standards. There are many different types of recordable disc formats (including CD-R containing MP3/WMA files). Given the fact that technology in this area is still maturing, This unit cannot guarantee that all genre of recordable discs will produce optimal playback quality. The technical criteria set out in this owner's manual are meant as a guide only.

Please be advised that you must obtain permission from the applicable copyright owners to download copyrighted content, including music files, in any format, including the MP3 and WMA formats, prior to the downloading thereof.

## MP3/WMA CD/JPEG CD information

### Limitations on MP3/WMA/JPEG CD playback

- MP3/WMA/JPEG CD is the disc that is standardized by ISO9660, its file name must include 3-digits extension letters, "mp3", "wma", "jpg".
- MP3/WMA/JPEG CD must be correspond to the ISO standardized files.
- This TV/DVD can read 600 files per disc. If one directory has more than 600 files, it reads up to 600 files, the remaining files will be omitted.
- The unit is able to recognize up to a maximum of 50 directories per disc.
- MP3/WMA/JPEG CDs cannot be used for the purpose of recording.
- If the CD has both audio tracks and MP3/WMA/JPEG files, only audio tracks are played.
- It may take more than one minute for this unit to read MP3/WMA/JPEG files depending on its structure.
- Music recorded by "Joliet Recording Specification" can be played back, the file name is displayed (within 16 letters) on the screen. Long file names will be condensed.
- The music files recorded by "Hierarchical File System" (HFS) cannot be played.

### Limitations on display

- The maximum number for display is 16 letters.  
Available letters for display are the following: capital or small alphabets of A through Z, numbers of 0 through 9, and \_ (under score).
- Other letters than those above are replaced in hyphen.

### Notes on MP3/WMA/JPEG files

To playback MP3/WMA/JPEG CD in the recorded order,

1. Use MP3/WMA/JPEG software that records data alphabetically or numerically.
2. Name each file including two-digit or three-digit number (ex. "01" "02" or "001" "002").
3. Refrain from making too many sub-folders.

### CAUTION:

- Some MP3/WMA/JPEG CDs cannot be played back depending on the recording conditions.
- The CD-R/RW that has no music data or non MP3/WMA/JPEG files cannot be played back.

### Standard, sampling frequency, and the bit rate:

#### MP3 CD

MPEG-1 Audio

32kHz, 44.1kHz, 48kHz

32kbps ~ 320kbps (constant bit rate or variable bit rate)

The recommend recording setting for a high-quality sound is 44.1kHz of sampling frequency and 128kbps of constant bit rate.

#### WMA CD

WMA version 7, and 8

32kHz, 48kbps

44.1kHz, 48kbps ~ 192kbps

48kHz, 128kbps ~ 192kbps

The file recorded by mono, 48kHz, 48 kbps is not available to this unit.

Microsoft, Windows Media, and the Windows Logo are either registered trademarks or trademarks of Microsoft Corporation in the United States and/or other countries.

**MP3/WMA CD playback**

- 1 Load a disc on which MP3 or WMA files have been recorded in the disc slot.
- 2 "Reading" will appear on the TV screen. Reading time will depend on the number of files on the disc.
- 3 A file menu screen will appear on the TV screen. Press ◀▶ to select a folder.
- 4 Press ▲/▼/◀▶ or a Number button (0-9) to select the desired file.
  - In case the folder includes more than 15 files, press ◀▶ to display next file list.
  - When **PLAY** has been pressed after displaying the file menu, playback begins automatically starting from the first file. In this case, if the first file is an MP3/WMA file, only MP3/WMA files are played back in order. If the first file is a JPEG file, the first JPEG file is played back.
- 5 Press **ENTER**. The selected file starts playing back.
- 6 Press **STOP** to end playback.
  - The TV/DVD records the stopped point. "⏸" appears on the screen. Press **PLAY** to resume playback (from the scene point).
  - If you press **STOP** again or unload the disc, the unit will clear the stopped point.



**NOTE**

- During MP3/WMA/JPEG-Playback, you cannot use SEARCH, or A-B Repeat functions.
- You can use Repeat (Track or All), Random functions and Program playback for MP3/WMA/JPEG CD Playback (see page 44).

**JPEG CD playback**

- 1 Insert a disc to play same method as step 1-2 left column.
- 2 A file menu screen will appear on the TV screen. Press ◀▶ to select a folder.
- 3 Press ▲/▼/◀▶ or **Number buttons (0-9)** to select the desired file.
  - When **PLAY** has been pressed after displaying the file menu, playback begins automatically starting from the first file. In this case, if the first file is a JPEG file, the first JPEG file is played back. If the first file is an MP3/WMA file, only MP3/WMA files are played back in order.
- 4 Press **ENTER**. The selected picture appears on the screen.
- 5 Press **STOP** to end playback. The file menu appears on the screen. If you want to watch the other file, repeat steps 3-4.

**NOTE**

- MP3 or WMA files on the KODAK Picture CD are not recognized on this unit.
- In case of JPEG-playback, the JPEG-image is rotated 90 degrees to the right.

**About file menu**

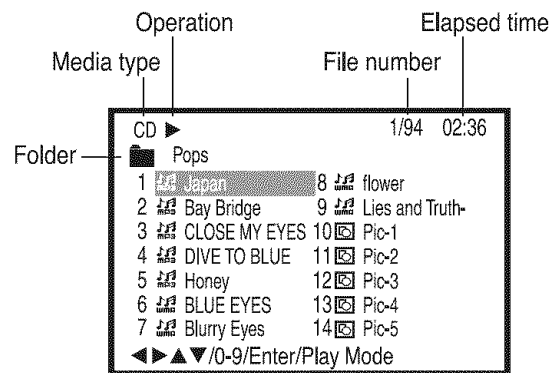

- : Indicates MP3 file
- : Indicates WMA file
- : Indicates JPEG file

### Setting the JPEG interval

You can continuously playback all JPEG files automatically.

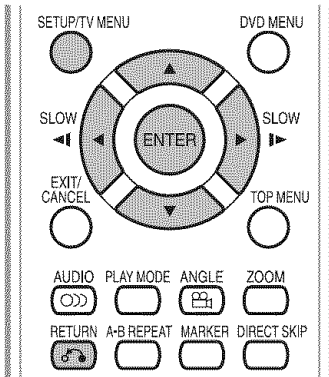

- 1 Press **SETUP** and the SETUP screen displays.
- 2 Press **◀/▶** to select (PICTURE), then press **▼** or **ENTER**.
- 3 Press **▲/▼** to select "JPEG Interval".
- 4 Press **◀/▶** to select your desired time.

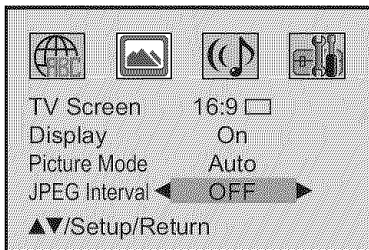

Selected item	Description
Off	Plays back one file at a time.
5 seconds	Displays images in the form of a slide show. Every 5 seconds the image changes.
10 seconds	Displays images in the form of a slide show. Every 10 seconds the image changes.
15 seconds	Displays images in the form of a slide show. Every 15 seconds

- 5 Press **RETURN** to return to the normal screen.

**NOTE**

• You cannot display DVD SETUP screen when disc is playback.

### Setting the select files

When playing back a CD containing a mixture of MP3, WMA and JPEG files, only MP3/WMA or JPEG files can be displayed on the file menu.

- 1 Press **SETUP** and the SETUP screen displays.
- 2 Press **◀/▶** to select (SETUP), then press **▼** or **ENTER**.
- 3 Press **▲/▼** to select "Select Files".
- 4 Press **◀/▶** to select your desired file type.

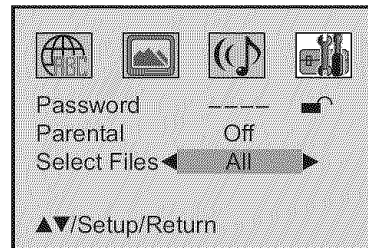

Selected item	Description
All	Displays all files.
Music Only	Displays only MP3/WMA files.
Pictures Only	Displays only JPEG files.

- 5 Press **RETURN** to return to the normal screen.

**NOTE**

• You cannot display DVD SETUP screen when disc is playback.

# Function setup

## Basic operation buttons

Use the following buttons on the remote control to operate the menu.

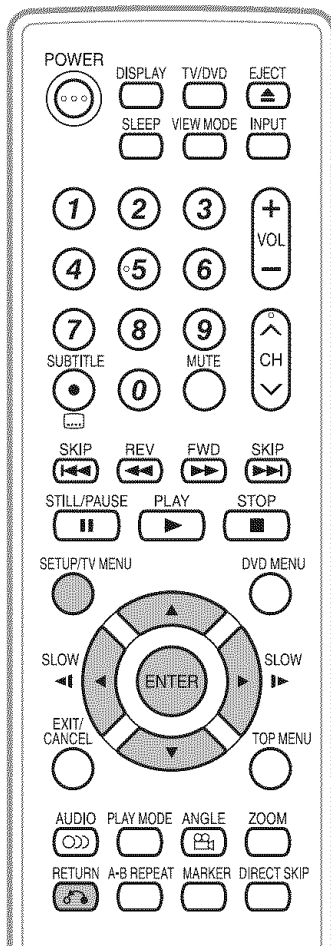

- SETUP:** Press to open the menu screen.
- ▲/▼/◀/▶:** Press to select a desired item on the screen or adjust a selected item.
- ENTER:** Press to go to the next step or complete the setting.
- RETURN:** Press to exit from the menu screen. All changed settings will be saved.

▲▼/Setup/Return

The lower part of the menu screen is an operational guide for the remote control. It will change in accordance with each menu setting screen.

## Menu items

List of menu items to help you with operations

### LANGUAGE

Menu .....	Page 50
Subtitle .....	Page 50
Audio .....	Page 50

### PICTURE

TV Screen .....	Page 50
Display .....	Page 51
Picture Mode .....	Page 51
JPEG Interval .....	Page 48

### AUDIO

DRC .....	Page 51
-----------	---------

### SETUP

Password .....	Page 52
Parental .....	Page 52
Select Files .....	Page 48

### NOTE

- You cannot display DVD SETUP screen when disc is playback.

## Function setup

### Setting the language

You can select the language of the disc menu messages of DVDs.

The same language can always be selected even if you replace the disc or turn the power off.

**1** Press **SETUP** and the SETUP screen displays.

**2** Press **◀/▶** to select  (LANGUAGE), then press **▼** or **ENTER**.

**3** Press **▲/▼** to select desired option.

**4** Press **◀/▶** to select your desired language (e.g. English).

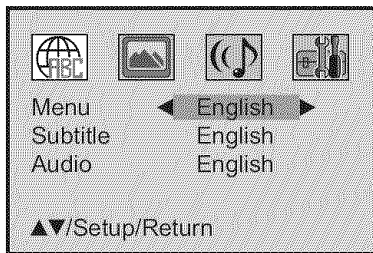

Selected item	Description
English, Francais, Espanol:	The selected language will be heard or seen.
Other	Other language can be selected (see the "Language code list" on page 54).
Off (Subtitle)	Subtitles do not appear.
Original (Audio)	The unit will select the first priority language of each disc.

**5** Press **RETURN** to return to the normal screen.

#### NOTE

- If the selected language is not recorded on the disc, the first priority language is selected.

### Setting the aspect ratio of TV screen



**1** Press **SETUP** and the SETUP screen displays.

**2** Press **◀/▶** to select  (PICTURE), then press **▼** or **ENTER**.

**3** Press **▲/▼** to select "TV Screen".

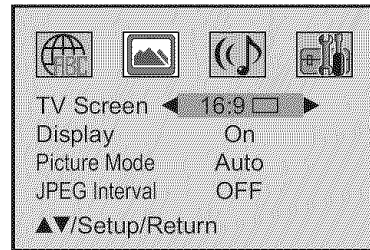
**4** Press **◀/▶** to select your desired screen type.



Selected item	Description
4:3 (Letter box) 	Select this mode when connecting to a conventional TV. When playing back a wide screen-DVD disc, it displays the wide picture with black bands at the top and bottom of screen.
4:3 (Pan Scan) 	It displays the wide picture on the whole screen with left and right edges automatically cut off.
16:9 (Wide) 	Select this mode when connecting to a wide-screen TV. A wide screen picture is displayed full size.

**5** Press **RETURN** to return to the normal screen.

#### NOTE

- If the DVD disc is not formatted in the pan & scan style, it displays 4:3 style.

## Function setup

### Setting on screen display

On screen display can be switched on or off when you press the **DISPLAY** button.

- 1 Press **SETUP** and the SETUP screen displays.
- 2 Press ◀/▶ to select  (PICTURE), then press ▼ or **ENTER**.
- 3 Press ▲/▼ to select "Display".
- 4 Press ◀/▶ to select "On" or "Off".
  - If "TV Screen" is not set to "On" on screen displays do not appear when you press any buttons except **SUBTITLE**, **PLAY MODE**, **MARKER**, **DIRECT SKIP** and **DISPLAY**.
- 5 Press **RETURN** to return to the normal screen.

### Setting the picture mode

There are two types of source content in pictures recorded in DVD video discs: film content (pictures recorded from films at 24 frames per second) and video content (video signals recorded at 30 frames per second). Make this selection according to the type of content being viewed.

- 1 Press **SETUP** and the SETUP screen displays.
- 2 Press ◀/▶ to select  (PICTURE), then press ▼ or **ENTER**.
- 3 Press ▲/▼ to select "Picture Mode".
- 4 Press ◀/▶ to select your desired picture mode.

Selected item	Description
<b>Auto</b>	Select this position normally. The DVD player automatically detects source content, film or video, of playback source.
<b>Film</b>	Suitable for playback of film content pictures.
<b>Video</b>	Suitable for playback of video content pictures.

- 5 Press **RETURN** to return to the normal screen.

### Dynamic Range Control

DRC (Dynamic Range Control) enables you to control the dynamic range so as to achieve a suitable sound for your equipment.

- 1 Press **SETUP** and the SETUP screen displays.
- 2 Press ◀/▶ to select  (AUDIO), then press ▼ or **ENTER**.
- 3 Press ▲/▼ to select "DRC".
- 4 Press ◀/▶ to select "On" or "Off".

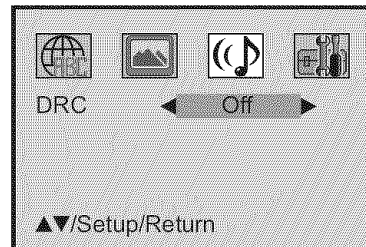

Selected item	Description
<b>On</b>	Loud sound such as explosion or similar is toned down slightly when played back. This makes it suitable for when it is connected to a stereo.
<b>Off</b>	It plays back at the recording level on the disc.

- 5 Press **RETURN** to return to the normal screen.

#### NOTE

- This function works only during playback of Dolby Digital recorded discs.
- The level of Dynamic Range Reduction may differ depending on DVD video disc.



## Function setup

### Parental control setting

Some discs are specified as not suitable for children. Playback of such discs can be restricted with this TV/DVD.

- 1 Press **SETUP** and the SETUP screen displays.
- 2 Press ◀/▶ to select  (SETUP), then press ▼ or **ENTER**.
- 3 Press ▲/▼ to select "Parental".
- 4 Press ◀/▶ until the level you require appears.

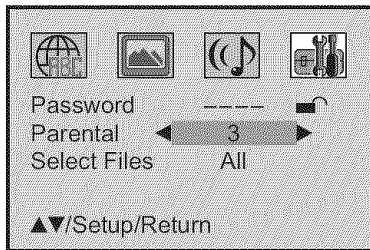

Selected item	Description
Level Off	The parental control setting does not function.
Level 8	Virtually all DVD software can be played back.
Level 1	DVD software for adults cannot be played back.

- Select from level 1 to level 8. The limitation will be more severe as the level number decreases.

- 5 Press ▲ to select "Password". Press **Number buttons (0-9)** to input a 4-digit password. Be sure to remember this number!
  - If you input a wrong number, press **CANCEL**.
- 6 Press **ENTER** to store the password.
 

**NOTE**

 After the rating is locked, the setting cannot be changed unless you enter the correct password.
- 7 Press **RETURN** to return to the normal screen.

#### NOTE

- Depending on the discs, the TV/DVD may not be able to limit playback.
- Some discs may not be encoded with specific rating level information though its disc jacket says "adult." For those discs, the parental control feature will not work.

### To change the parental level

- 1 Press **SETUP** and the SETUP screen displays.
- 2 Press ◀/▶ to select  (SETUP), then press ▼ or **ENTER**.
- 3 Press ▲/▼ to select "Password".
- 4 Press **Number buttons (0-9)** to enter the password you have stored.
  - If you input a wrong number, press **CANCEL**.

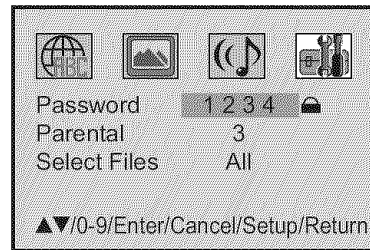

- 5 Press **ENTER**. The rating is now unlocked.
- 6 Press ▼ to select "Parental", then press ◀ or ▶ to change the parental level.
- 7 Press ▲ to select "Password", then press **Number buttons (0-9)** to enter the password.

#### NOTE

You can change the password at this time if you want.

- 8 Press **ENTER**. The parental level is changed and locked.

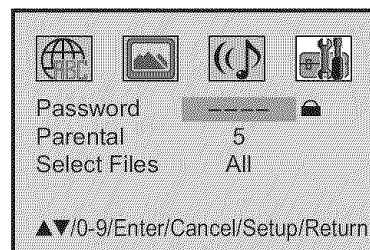

- 9 Press **RETURN** to return to the normal screen.

#### NOTE

**If you forget the password...**

1. Press **EJECT** to remove the disc.
2. While holding **STOP** down on the front panel, press **7** on the remote control. "PASSWORD CLEAR" appears on the screen.
3. Enter a new password again.



## Temporary disabling of rating level by DVD disc

Depending on the DVD disc, the disc may try to temporarily cancel the rating level that you have set. It is up to you to decide whether to cancel the rating level or not.

1

Load a DVD disc. (See page 41.)

2

If the DVD disc has been designed to temporarily cancel the rating level, the screen which follows the "Reading" screen will change, depending on which disc is played. If you select "YES" with pressing **ENTER**, "Your disc exceeds the parental control level 1." (e.g.) screen will then appear.

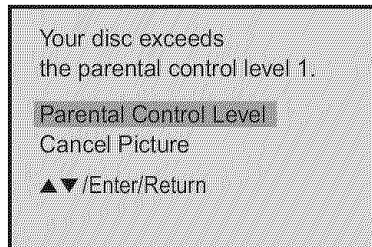

3

If you wish to cancel the set rating level temporarily, select "Parental Control Level" with ▲/▼, then press **ENTER**. If the 4-digits password at step 5 on page 52 has been set, the password entering screen will appear as shown in step 4 below. Alternatively, if the password has not been set, playback will commence. If you don't know (or have forgotten) the password, select "Cancel Picture". The setting screen will disappear. Press **EJECT** to remove the disc.

4

Enter the password with **Number buttons (0-9)**.

Then press **ENTER**.

- If you interrupt the entering, press **RETURN**.

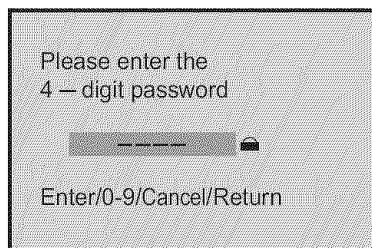

5

Playback will commence if the entered password was correct.

### NOTE

- This temporary cancellation of the rating level will be kept until the disc is ejected. When the disc is ejected, the original rating level will be set again automatically.

# Appendix

## Language code list

Enter the appropriate code number for the initial settings “Menu”, “Subtitle” and/or “Audio” (see page 50).

Language Name	Code	Language Name	Code	Language Name	Code	Language Name	Code
Abkhazian	1112	Fiji	1620	Lingala	2224	Singhalese	2919
Afar	1111	Finnish	1619	Lithuanian	2230	Slovak	2921
Afrikaans	1116	French	1628	Macedonian	2321	Slovenian	2922
Albanian	2927	Frisian	1635	Malagasy	2317	Somali	2925
Amharic	1123	Galician	1722	Malay	2329	Spanish	1529
Arabic	1128	Georgian	2111	Malayalam	2322	Sundanese	2931
Armenian	1835	German	1415	Maltese	2330	Swahili	2933
Assamese	1129	Greek	1522	Maori	2319	Swedish	2932
Aymara	1135	Greenlandic	2122	Marathi	2328	Tagalog	3022
Azerbaijani	1136	Guarani	1724	Moldavian	2325	Tajik	3017
Bashkir	1211	Gujarati	1731	Mongolian	2324	Tamil	3011
Basque	1531	Hausa	1811	Nauru	2411	Tatar	3030
Bengali; Bangla	1224	Hebrew	1933	Nepali	2415	Telugu	3015
Bhutani	1436	Hindi	1819	Norwegian	2425	Thai	3018
Bihari	1218	Hungarian	1831	Oriya	2528	Tibetan	1225
Breton	1228	Icelandic	1929	Panjabi	2611	Tigrinya	3019
Bulgarian	1217	Indonesian	1924	Pashto, Pushto	2629	Tonga	3025
Burmese	2335	Interlingua	1911	Persian	1611	Turkish	3028
Byelorussian	1215	Irish	1711	Polish	2622	Turkmen	3021
Cambodian	2123	Italian	1930	Portuguese	2630	Twi	3033
Catalan	1311	Japanese	2011	Quechua	2731	Ukrainian	3121
Chinese	3618	Javanese	2033	Rhaeto-Romance	2823	Urdu	3128
Corsican	1325	Kannada	2124	Romanian	2825	Uzbek	3136
Croatian	1828	Kashmiri	2129	Russian	2831	Vietnamese	3219
Czech	1329	Kazakh	2121	Samoan	2923	Volapük	3225
Danish	1411	Kirghiz	2135	Sanskrit	2911	Welsh	1335
Dutch	2422	Korean	2125	Scots Gaelic	1714	Wolof	3325
English	1524	Kurdish	2131	Serbian	2928	Xhosa	3418
Esperanto	1525	Laothian	2225	Serbo-Croatian	2918	Yiddish	2019
Estonian	1530	Latin	2211	Shona	2924	Yoruba	3525
Faroese	1625	Latvian, Lettish	2232	Sindhi	2914	Zulu	3631

## Appendix

### Removing the stand

Before detaching (or attaching) stand, unplug the AC cord from the AC INPUT terminal.

#### CAUTION

- Do not remove the stand from the TV/DVD unless using an optional wall mount bracket to mount it.

#### Before attaching/detaching stand

- Before performing work make sure to turn off the TV/DVD.
- Before performing work spread cushioning over the base area to lay the TV/DVD on. This will prevent it from being damaged.

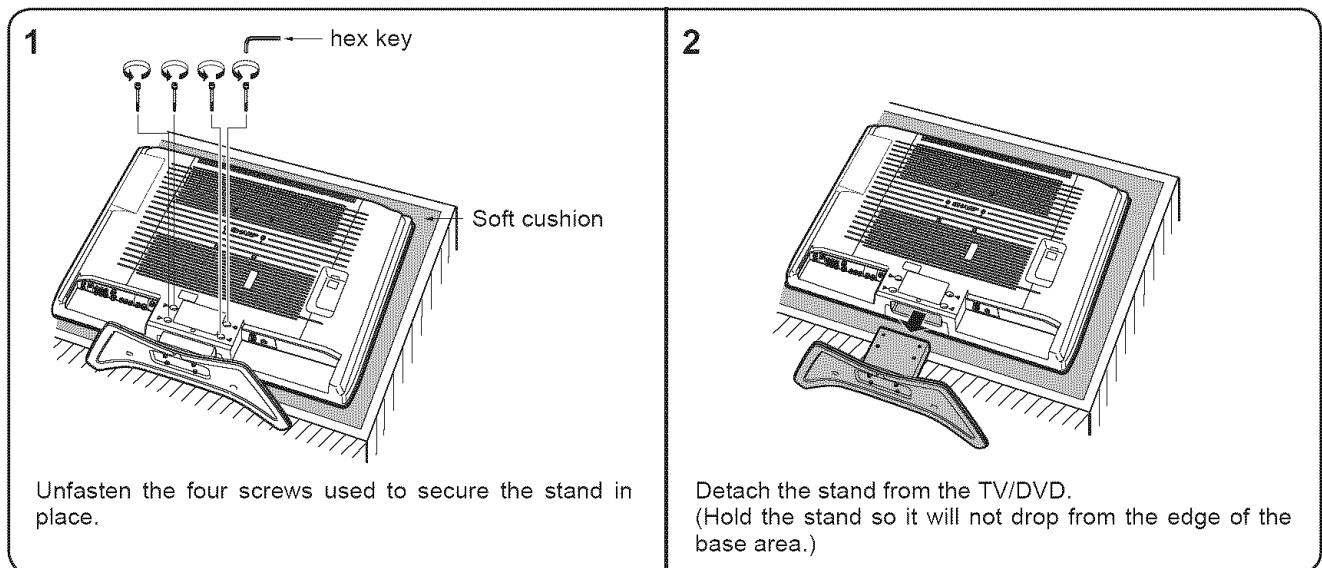

#### NOTE

- To attach the stand, perform the above steps in reverse order.

### Setting the TV/DVD on the wall

#### CAUTION

- Installing the TV/DVD requires special skill that should only be performed by qualified service personnel. Customers should not attempt to do the work themselves. SHARP bears no responsibility for improper mounting or mounting that results in accident or injury.

#### Using an optional bracket to mount the TV/DVD

- You can ask a qualified service professional about using an optional AN-26AG1 bracket to mount the TV/DVD to the wall.
- Carefully read the instructions that come with the bracket before beginning work.

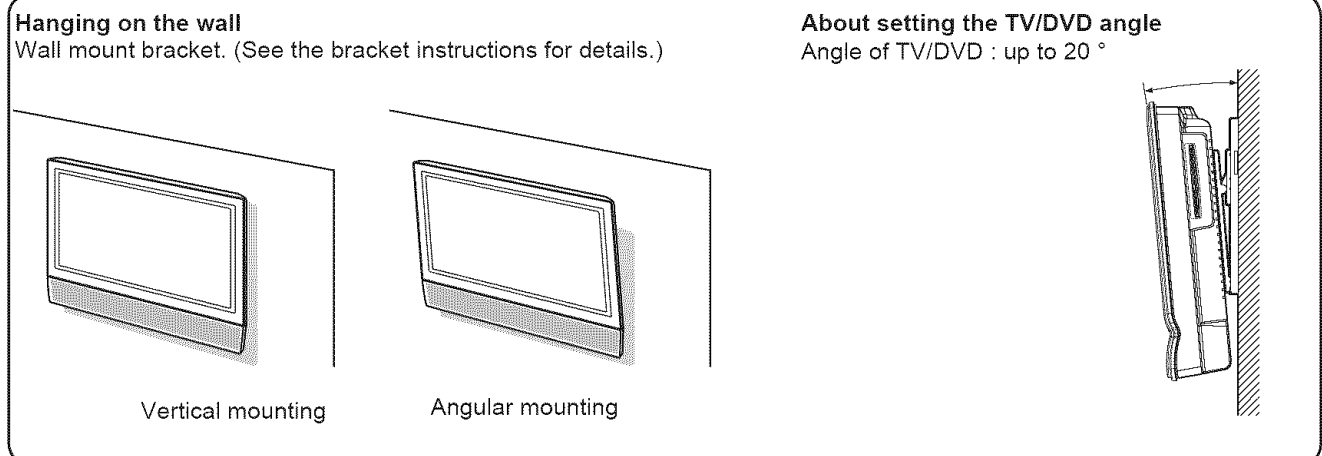

#### NOTE

- DETACH THE CABLE CLAMP ON THE REAR OF THE TV/DVD WHEN USING THE OPTIONAL MOUNT BRACKET.

## Troubleshooting

Problem	Possible Solution
<ul style="list-style-type: none"> <li>No power</li> </ul>	<ul style="list-style-type: none"> <li>Check if you pressed <b>POWER</b> on the remote control unit. (See page 16.) If the indicator on the TV/DVD does not light up, press <b>POWER</b> on the TV/DVD.</li> <li>Is the AC cord disconnected? (See page 9.)</li> <li>Has the power been turned on? (See page 16.)</li> </ul>
<ul style="list-style-type: none"> <li>Unit cannot be operated.</li> </ul>	<ul style="list-style-type: none"> <li>External influences such as lightning, static electricity, may cause improper operation. In this case, operate the unit after first turning on the power of the TV/DVD or unplugging the AC cord and replugging it in after 1 or 2 minutes.</li> </ul>
<ul style="list-style-type: none"> <li>Remote control unit does not operate.</li> </ul>	<ul style="list-style-type: none"> <li>Are batteries inserted with polarity (+, -) aligned? (See page 10.)</li> <li>Are batteries worn out? (Replace with new batteries.)</li> <li>Are you using it under strong or fluorescent lighting?</li> <li>Is a fluorescent light illuminated near the remote control sensor?</li> </ul>
<ul style="list-style-type: none"> <li>Picture is cut off screen.</li> </ul>	<ul style="list-style-type: none"> <li>Are screen mode adjustments such as view mode choose made correctly? (See page 30.)</li> </ul>
<ul style="list-style-type: none"> <li>Strange color, light color, or color misalignment</li> </ul>	<ul style="list-style-type: none"> <li>Adjust the picture tone. (See page 23.)</li> <li>Is the room too bright? The picture may look dark in a room that is too bright.</li> </ul>
<ul style="list-style-type: none"> <li>Power is suddenly turned off.</li> </ul>	<ul style="list-style-type: none"> <li>Is the sleep timer set? (See page 20.)</li> <li>Check the power control settings. (See page 16.)</li> <li>The TV/DVD's internal temperature has increased. Remove any objects blocking vent or clean.</li> </ul>
<ul style="list-style-type: none"> <li>No picture</li> </ul>	<ul style="list-style-type: none"> <li>Is connection to other components correct? (See pages 26 to 27.)</li> <li>Is correct input signal source selected after connection? (See page 25.)</li> <li>Is the correct input selected? (See page 25.)</li> <li>Is picture adjustment correct? (See page 23.)</li> </ul>
<ul style="list-style-type: none"> <li>No sound</li> </ul>	<ul style="list-style-type: none"> <li>Is the volume too low? (See page 19.)</li> <li>Is "OFF" selected in "SPEAKERS"? (See page 31.)</li> </ul>

## Troubleshooting-Digital broadcasting

The example of an error message displayed on a screen	Possible Solution
<ul style="list-style-type: none"> <li>DIGITAL CHANNEL SIGNAL STRENGTH IS LOW</li> </ul>	<ul style="list-style-type: none"> <li>Check the antenna cable. Check that the antenna is correctly setup.</li> </ul>
<ul style="list-style-type: none"> <li>DIGITAL CHANNEL IS SCRAMBLED</li> </ul>	<ul style="list-style-type: none"> <li>It is subscription channel. Contact the service provider.</li> </ul>
<ul style="list-style-type: none"> <li>AUDIO ONLY</li> </ul>	<ul style="list-style-type: none"> <li>The channel has audio contents only.</li> </ul>

### Cautions regarding use in high and low temperature environments

- When the TV/DVD is used in a low temperature space (e.g. room, office), the picture may leave trails or appear slightly delayed. This is not a malfunction, and the TV/DVD will recover when the temperature returns to normal.
- Do not leave the TV/DVD in a hot or cold location. Also, do not leave the TV/DVD in a location exposed to direct sunlight or near a heater, as this may cause the cabinet to deform and the Liquid Crystal panel to malfunction.  
Storage temperature: -4°F to +140°F (-20°C to +60°C)

**Troubleshooting-DVD**

Problem	Possible Solution
<ul style="list-style-type: none"> <li>Playback doesn't start.</li> </ul>	<ul style="list-style-type: none"> <li>No disc is inserted. (See page 41.)</li> <li>The disc may be dirty. Clean up the disc. (See page 7.)</li> <li>The TV/DVD cannot play CD-ROMs, etc. (See page 6.)</li> </ul>
<ul style="list-style-type: none"> <li>No picture.</li> </ul>	<ul style="list-style-type: none"> <li>TV/DVD selector is not set correctly. (See page 40.)</li> </ul>
<ul style="list-style-type: none"> <li>No sound.</li> </ul>	<ul style="list-style-type: none"> <li>Check the input selector of the amplifier is set properly.</li> <li>The TV/DVD is in the special playback mode. (See page 42.)</li> <li>Select the correct Audio Output position on AV amplifier.</li> </ul>
<ul style="list-style-type: none"> <li>Picture is distorted during fast reverse/forward playback.</li> </ul>	<ul style="list-style-type: none"> <li>The picture will be distorted occasionally.</li> </ul>
<ul style="list-style-type: none"> <li>Stopping playback, search, slowmotion play, repeat play, or program play, etc. cannot be performed.</li> </ul>	<ul style="list-style-type: none"> <li>Some discs may not do some of the functions.</li> </ul>
<ul style="list-style-type: none"> <li>No on-screen display.</li> </ul>	<ul style="list-style-type: none"> <li>Select Display to On. (See page 51.)</li> </ul>
<ul style="list-style-type: none"> <li>No surround sound.</li> </ul>	<ul style="list-style-type: none"> <li>The setup does not match your stereo system.</li> </ul>
<ul style="list-style-type: none"> <li>The TV/DVD or remote operation key is not functioning.</li> </ul>	<ul style="list-style-type: none"> <li>Turn off the TV/DVD and unplug the AC power cord for several minutes, then replug it.</li> </ul>
<ul style="list-style-type: none"> <li>Playback does not start when the title is selected.</li> </ul>	<ul style="list-style-type: none"> <li>Check the Parental setup. (See page 52.)</li> </ul>
<ul style="list-style-type: none"> <li>Audio soundtrack and/or subtitle language is not changed when you playback a DVD.</li> </ul>	<ul style="list-style-type: none"> <li>Multilingual language is not recorded on the DVD disc. (See page 50.)</li> </ul>
<ul style="list-style-type: none"> <li>No subtitle.</li> </ul>	<ul style="list-style-type: none"> <li>Some discs have no subtitles. (See page 45.)</li> <li>Subtitles are cleared. Press <b>SUBTITLE</b>. (See page 45.)</li> </ul>
<ul style="list-style-type: none"> <li>Angle cannot be changed.</li> </ul>	<ul style="list-style-type: none"> <li>Multi-angles are not recorded on the DVD disc. (See page 44.)</li> </ul>
<ul style="list-style-type: none"> <li>" " appears on the screen.</li> </ul>	<ul style="list-style-type: none"> <li>The function is prohibited with the TV/DVD or the disc. (See page 41.)</li> </ul>

## Specifications

Item		Model: LC-26DV20U	
LCD panel		26" Advanced Super View & BLACK TFT LCD	
Number of dots		3,147,264 dots (1366 x 768 x 3 dots)	
TV Function	TV-standard (CCIR)		American TV Standard ATSC/NTSC System
	Receiving Channel	VHF/UHF	VHF 2-13ch, UHF 14-69ch
		CATV	1-125ch (non-scrambled channel only.)
		Digital Terrestrial Broadcast (8VSB)	2-69ch
		Digital Cable* (64/256 QAM)	1-125ch (non-scrambled channel only.)
Audio multiplex		BTSC System	
Backlight		60,000 hours (at Backlight Standard position)	
Audio out		10W x 2	
Terminals	Rear	INPUT 1	AV in, S-VIDEO in
		INPUT 2	AV in, S-VIDEO in
		INPUT 3	COMPONENT in, Audio in
		INPUT 4	HDMI in with HDCP, Audio in
		ANT/CABLE	75 Ω Unbalance, F Type x 1 for Analog (VHF/UHF/CATV) and Digital (AIR/CABLE)
		DIGITAL AUDIO OUTPUT	Coaxial Digital audio output x 1 (PCM/Dolby Digital)
		OUTPUT	Audio out
OSD language		English/French/Spanish	
Power Requirement		AC 120 V, 60 Hz	
Power Consumption		155 W (Standby 1W)	
Weight	w/o stand	26.7 lbs./12.1 kg	
	with stand	30.5 lbs./13.8 kg	
Dimension (W x H x D)	w/o stand	26 <sup>15</sup> / <sub>16</sub> x 19 <sup>59</sup> / <sub>64</sub> x 4 <sup>39</sup> / <sub>64</sub> inch	
	with stand	26 <sup>15</sup> / <sub>16</sub> x 22 <sup>1</sup> / <sub>4</sub> x 11 <sup>9</sup> / <sub>64</sub> inch	
DVD section	Signal system		NTSC
	Applicable disc		DVD (12 cm, 8 cm), CD (12 cm, 8 cm)
	Frequency response		DVD: 4Hz - 22KHz/CD: 4Hz - 20KHz
	Wow and flutter		Below Measurable Level
	Pickup		CD : Wavelength: 780 - 790 nm Maximum output power: 7 mW DVD : Wavelength: 652 - 662 nm Maximum output power: 5 mW
Accessories		Remote control unit (x1), AC cord (x1), "AA" size battery (x2), Cable clamp (x1), Stand unit (x1), Operation manual (x1)	
Operating temperature		+41°F to +104°F (+5°C to +40°C)	

\* Emergency alert messages via Cable are unreceivable.

- As part of policy of continuous improvement, SHARP reserves the right to make design and specification changes for product improvement without prior notice. The performance specification figures indicated are nominal values of production units. There may be some deviations from these values in individual units.

## Optional accessories

The listed optional accessories are available for the LCD colour TV. Please purchase them at your nearest shop.

- Additional optional accessories may be available in near future. When purchasing, please read the newest catalogue for compatibility and check the availability.

Part name	Part number
Wall mount bracket	AN-26AG1

# Dimensional drawings

Unit: inch/(mm)

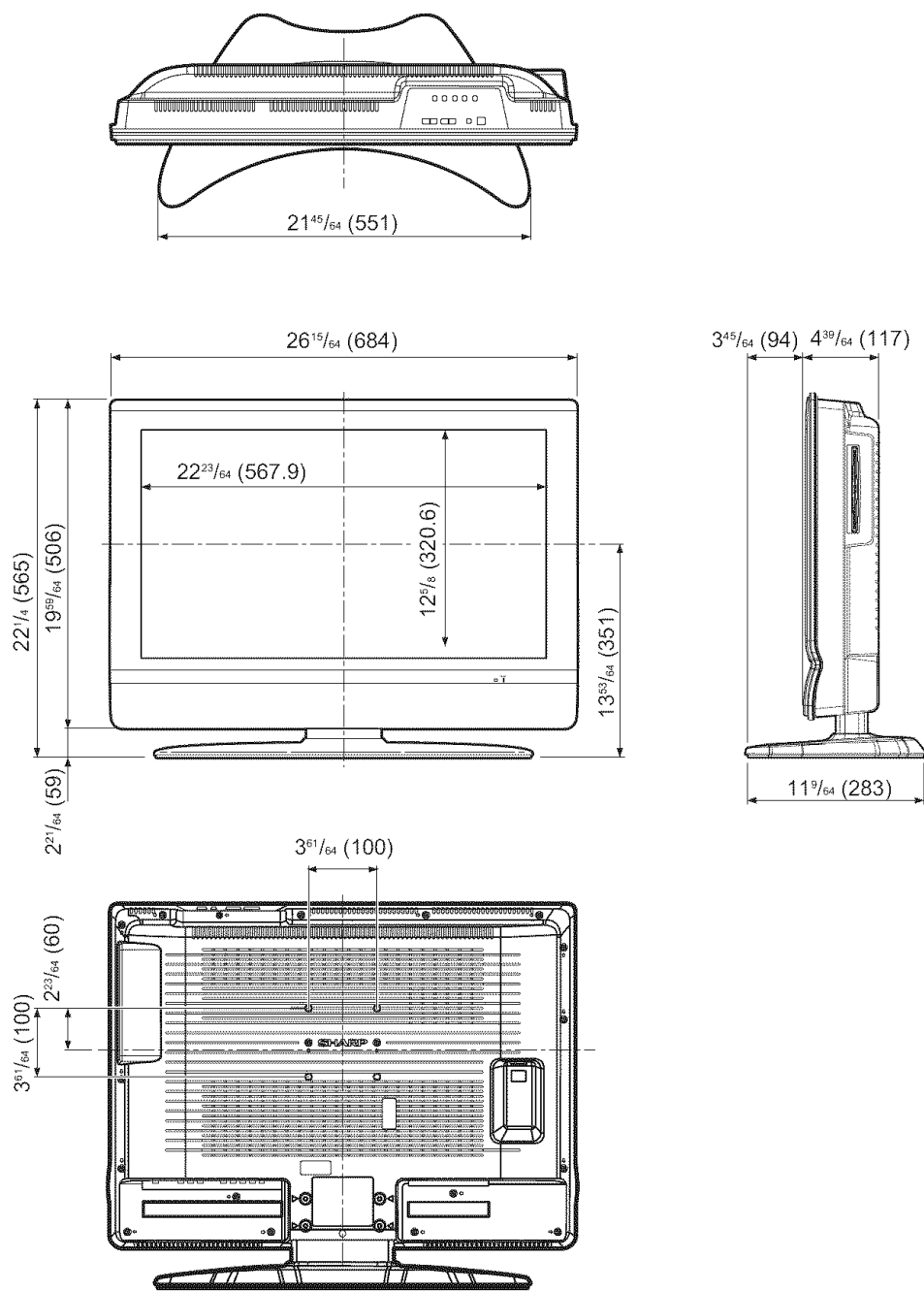

## CLEARING THE PASSWORD

If you forget the password, clear the password using the following procedure.

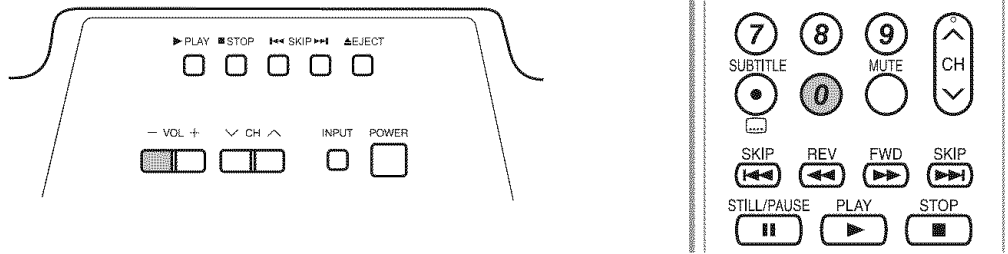

1

Press and hold both **VOL -** on the TV/DVD and press **0** on the remote control simultaneously for a few seconds until  (LOCKS) menu appears on the screen.

2

Now the old password was cleared. You can set the new password.

The password is

--	--	--	--

### NOTE

- As a precautionary measure, make a note of your password above, cut it from this manual, and keep it in a safe place.



# Calling for Service

For location of the nearest Sharp Authorized Service, or to obtain product literature, accessories, supplies, or customer assistance, please call 1-800-BE-SHARP.

## LIMITED WARRANTY

### CONSUMER LIMITED WARRANTY

SHARP ELECTRONICS CORPORATION warrants to the first consumer purchaser that this Sharp brand product (the "Product"), when shipped in its original container, will be free from defective workmanship and materials, and agrees that it will, at its option, either repair the defect or replace the defective Product or part thereof with a new or remanufactured equivalent at no charge to the purchaser for parts or labor for the period(s) set forth below.

This warranty does not apply to any appearance items of the Product nor to the additional excluded item(s) set forth below nor to any Product the exterior of which has been damaged or defaced, which has been subjected to improper voltage or other misuse, abnormal service or handling, or which has been altered or modified in design or construction.

In order to enforce the rights under this limited warranty, the purchaser should follow the steps set forth below and provide proof of purchase to the servicer.

The limited warranty described herein is in addition to whatever implied warranties may be granted to purchasers by law. ALL IMPLIED WARRANTIES INCLUDING THE WARRANTIES OF MERCHANTABILITY AND FITNESS FOR USE ARE LIMITED TO THE PERIOD(S) FROM THE DATE OF PURCHASE SET FORTH BELOW. Some states do not allow limitations on how long an implied warranty lasts, so the above limitation may not apply to you.

Neither the sales personnel of the seller nor any other person is authorized to make any warranties other than those described herein, or to extend the duration of any warranties beyond the time period described herein on behalf of Sharp.

The warranties described herein shall be the sole and exclusive warranties granted by Sharp and shall be the sole and exclusive remedy available to the purchaser. Correction of defects, in the manner and for the period of time described herein, shall constitute complete fulfillment of all liabilities and responsibilities of Sharp to the purchaser with respect to the Product, and shall constitute full satisfaction of all claims, whether based on contract, negligence, strict liability or otherwise. In no event shall Sharp be liable, or in any way responsible, for any damages or defects in the Product which were caused by repairs or attempted repairs performed by anyone other than an authorized servicer. Nor shall Sharp be liable or in any way responsible for any incidental or consequential economic or property damage. Some states do not allow the exclusion of incidental or consequential damages, so the above exclusion may not apply to you.

THIS WARRANTY GIVES YOU SPECIFIC LEGAL RIGHTS. YOU MAY ALSO HAVE OTHER RIGHTS WHICH VARY FROM STATE TO STATE.

### Model Specific Section

**Your Product Model Number & Description:**

LC-26DV20U Combination Liquid Crystal Television And DVD/CD Player  
(Be sure to have this information available when you need service for your Product.)

**Warranty Period for this Product:**

One (1) year parts and ninety (90) days labor from the date of purchase.

**Additional Item(s) Excluded from Warranty Coverage (if any):**

Non-rechargeable batteries.

**Where to Obtain Service:**

From a Sharp Authorized Servicer located in the United States. To find the location of the nearest Sharp Authorized Servicer, call Sharp toll free at 1-800-BE-SHARP.

**What to do to Obtain Service:**

Ship prepaid or carry in your Product to a Sharp Authorized Servicer. Be sure to have **Proof of Purchase** available. If you ship the Product, be sure it is insured and packaged securely. Please use two persons to carry the Product, transport it in its original packaging, and ensure that the Product is covered to avoid scratches and damage.

TO OBTAIN PRODUCT INFORMATION, CALL 1-800-BE-SHARP OR VISIT [www.sharpusa.com](http://www.sharpusa.com)

# SHARP®

SHARP ELECTRONICS CORPORATION

Sharp Plaza, Mahwah, New Jersey 07430-2135

SHARP CORPORATION

# SHARP®

## LIMITED WARRANTY

### *Consumer Electronics Products*

## **Congratulations on your purchase!**

Sharp Electronics of Canada Ltd. (hereinafter called "Sharp") gives the following express warranty to the first consumer purchaser for this Sharp brand product, when shipped in its original container and sold or distributed in Canada by Sharp or by an Authorized Sharp Dealer:

Sharp warrants that this product is free, under normal use and maintenance, from any defects in material and workmanship. If any such defects should be found in this product within the applicable warranty period, Sharp shall, at its option, repair or replace the product as specified herein.

This warranty shall not apply to:

- (a) Any defects caused or repairs required as a result of abusive operation, negligence, accident, improper installation or inappropriate use as outlined in the owner's manual.
- (b) Any Sharp product tampered with, modified, adjusted or repaired by any party other than Sharp, Sharp's Authorized Service Centres or Sharp's Authorized Servicing Dealers.
- (c) Damage caused or repairs required as a result of the use with items not specified or approved by Sharp, including but not limited to head cleaning tapes and chemical cleaning agents.
- (d) Any replacement of accessories, glassware, consumable or peripheral items required through normal use of the product including but not limited to earphones, remote controls, AC adapters, batteries, temperature probe, stylus, trays, filters, belts, ribbons, cables and paper.
- (e) Any cosmetic damage to the surface or exterior that has been defaced or caused by normal wear and tear.
- (f) Any damage caused by external or environmental conditions, including but not limited to transmission line/power line voltage or liquid spillage.
- (g) Any product received without appropriate model, serial number and CSA/cUL markings.
- (h) Any products used for rental or commercial purposes.
- (i) Any installation, setup and/or programming charges.

Should this Sharp product fail to operate during the warranty period, warranty service may be obtained upon delivery of the Sharp product together with proof of purchase and a copy of this LIMITED WARRANTY statement to an Authorized Sharp Service Centre or an Authorized Sharp Servicing Dealer. In home warranty service may be provided at Sharp's discretion on any Sharp television with the screen size of 27" or larger and on any Sharp Over-the-Range Microwave Oven.

This warranty constitutes the entire express warranty granted by Sharp and no other dealer, service centre or their agent or employee is authorized to extend, enlarge or transfer this warranty on behalf of Sharp. To the extent the law permits, Sharp disclaims any and all liability for direct or indirect damages or losses or for any incidental, special or consequential damages or loss of profits resulting from a defect in material or workmanship relating to the product, including damages for the loss of time or use of this Sharp product or the loss of information. The purchaser will be responsible for any removal, reinstallation, transportation and insurance costs incurred. Correction of defects, in the manner and period of time described herein, constitute complete fulfillment of all obligations and responsibilities of Sharp to the purchaser with respect to the product and shall constitute full satisfaction of all claims, whether based on contract, negligence, strict liability or otherwise.

**WARRANTY PERIODS:**

	Parts & Labour (exceptions noted)
Audio Products	1 year
Camcorder	1 year
DVD Products	1 year
Projector	1 year (lamp 90 days)
LCD & Plasma Display TV	1 year
Microwave Oven	1 year (magnetron component-4 additional years)
Television Products	1 year (picture tube component-1 additional year)
VCR Products	1 year
Vacuum Cleaner	1 year

To obtain the name and address of the nearest Authorized Sharp Service Centre or Dealer, please contact:  
SHARP ELECTRONICS OF CANADA LTD. 335 Britannia Road East, Mississauga, Ontario L4Z 1W9

For more information on this Warranty, Sharp Extended Warranty Offers, Sharp Canada Products, Accessory Sales, Dealer or Service Locations, please call (905) 568-7140  
Visit our Web site: [www.sharp.ca](http://www.sharp.ca)

