



DIGITAL MULTIFUNCTIONAL SYSTEM

OPERATION MANUAL
(for general information and copier operation)

	Page
PART 1: GENERAL INFORMATION	
• BEFORE USING	
THE PRODUCT	1-1
• MANAGING THE MACHINE	2-1
• PERIPHERAL DEVICES	3-1
PART 2: COPIER OPERATION	
• MAKING COPIES	4-1
• CONVENIENT COPY FUNCTIONS	5-1
• MACHINE MAINTENANCE (FOR COPYING)	6-1
• DOCUMENT FILING FUNCTION	7-1
• SPECIFICATIONS	8-1

Be sure to become thoroughly familiar with this manual to gain the maximum benefit from the product.

Before installing this product, be sure to read the installation requirements and cautions sections.

Be sure to keep all operation manuals handy for reference including this manual, the "Operation manual (for general information and copier operation)" and operation manuals for any optional equipment which has been installed.

Each instruction also covers the optional units used with these products.

In some areas, the "POWER" switch positions are marked "I" and "⏻" on the copier instead of "ON" and "OFF".

The symbol "⏻" denotes the copier is not completely de-energized but in a stand-by condition at this "POWER" switch position.

If your copier is so marked, please read "I" for "ON" and "⏻" for "OFF".

Caution!

For a complete electrical disconnection, pull out the main plug.

The socket-outlet shall be installed near the equipment and shall be easily accessible.

Shielded interface cables must be used with this equipment to maintain compliance with EMC regulations.

Trademark acknowledgments

The following trademarks and registered trademarks are used in conjunction with the machine and its peripheral devices and accessories.

- Microsoft®, Windows®, Windows® 98, Windows® Me, Windows NT® 4.0, Windows® 2000, Windows® XP, Windows® Server 2003 and Internet Explorer® are registered trademarks or trademarks of Microsoft Corporation in the U.S.A. and other countries.
- PostScript is a registered trademark of Adobe Systems Incorporated.
- Macintosh, Mac OS, AppleTalk, EtherTalk, LaserWriter, and Safari are registered trademarks or trademarks of Apple Computer, Inc.
- Netscape Navigator is a trademark of Netscape Communications Corporation.
- Adobe, the Adobe logo, Acrobat, the Adobe PDF logo, and Reader are registered trademarks or trademarks of Adobe Systems Incorporated in the United States and other countries.
- PCL is a registered trademark of the Hewlett-Packard Company.
- IBM, PC/AT, and PowerPC are trademarks of International Business Machines Corporation.
- Sharpdesk is a trademark of Sharp Corporation.
- All other trademarks and copyrights are the property of their respective owners.

Candid and Taffy are trademarks of Monotype Imaging, Inc. registered in the United States Patent and Trademark Office and may be registered in certain jurisdictions. CG Omega, CG Times, Garamond Antiqua, Garamond Halbfett, Garamond Kursiv, Garamond and Halbfett Kursiv are trademarks of Monotype Imaging, Inc. and may be registered in certain jurisdictions. Albertus, Arial, Coronet, Gill Sans, Joanna and Times New Roman are trademarks of The Monotype Corporation registered in the United States Patent and Trademark Office and may be registered in certain jurisdictions. Avant Garde, ITC Bookman, Lubalin Graph, Mona Lisa, Zapf Chancery and Zapf Dingbats are trademarks of International Typeface Corporation registered in the United States Patent and Trademark Office and may be registered in certain jurisdictions. Clarendon, Eurostile, Helvetica, Optima, Palatino, Stempel Garamond, Times and Univers are trademarks of Heidelberger Druckmaschinen AG, which may be registered in certain jurisdictions, exclusively licensed through Linotype Library GmbH, a wholly owned subsidiary of Heidelberger Druckmaschinen AG. Apple Chancery, Chicago, Geneva, Monaco and New York are trademarks of Apple Computer Inc. and may be registered in certain jurisdictions. HGGothicB, HGMinchoL, HGPGothicB and HGPMInchoL are trademarks of Ricoh Company, Ltd. and may be registered in some jurisdictions. Wingdings is a registered trademark of Microsoft Corporation in the United States and other countries. Marigold and Oxford are trademarks of Arthur Baker and may be registered in some jurisdictions. Antique Olive is a trademark of Marcel Olive and may be registered in certain jurisdictions. Hoefler Text is a trademark of Johnathan Hoefler and may be registered in some jurisdictions. ITC is a trademark of International Typeface Corporation registered in the United States Patent and Trademark Office and may be registered in certain jurisdictions. Agfa is a trademark of the Agfa-Gevaert Group and may be registered in certain jurisdictions. Intellifont, MicroType and UFST are trademarks of Monotype Imaging, Inc. registered in the United States Patent and Trademark Office and may be registered in certain jurisdictions. Macintosh and TrueType are trademarks of Apple Computer Inc. registered in the United States Patent and Trademark Office and other countries. PostScript is a trademark of Adobe Systems Incorporated and may be registered in some jurisdictions. HP, PCL, FontSmart and LaserJet are trademarks of Hewlett-Packard Company and may be registered in some jurisdictions. The Type 1 processor resident in Monotype Imaging's UFST product is under license from Electronics For Imaging, Inc. All other trademarks are the property of their respective owners.

Part 1: General Information

NOTES

- Considerable care has been taken in preparing this manual. If you have any comments or concerns about the manual, please contact your nearest authorised service representative.
- This product has undergone strict quality control and inspection procedures. In the unlikely event that a defect or other problem is discovered, please contact your dealer or nearest authorised service representative.
- Aside from instances provided for by law, SHARP is not responsible for failures occurring during use of the product or its options, or failures due to incorrect operation of the product and its options, or other failures, or for any damage that occurs due to use of the product.

Warranty

While every effort has been made to make this document as accurate and helpful as possible, SHARP Corporation makes no warranty of any kind with regard to its content. All information included herein is subject to change without notice. SHARP is not responsible for any loss or damages, direct or indirect, arising from or related to the use of this operation manual.

© Copyright SHARP Corporation 2007. All rights reserved. Reproduction, adaptation or translation without prior written permission is prohibited, except as allowed under copyright laws.

The display screens, messages, and key names shown in the manual may differ from those on the actual machine due to product improvements and modifications.

OPERATION MANUALS

The following operation manuals are provided for the machine. Please read the appropriate manuals as needed for the features you wish to learn about.

- Operation manual (for general information and copier operation) (this manual)

The first half of this manual provides general information about the machine, including safety information, loading paper, removing misfeeds, and regular maintenance.

The second half of the manual explains how to use the copy and document filing functions.

- Administrator settings guide

The administrator settings are used by the administrator of the machine to configure functions to meet the needs of your workplace.

This guide explains administrator settings for machine management, copying, and document filing. Administrator settings for the fax, printer, network scanner and Internet fax functions are explained in the manuals for those functions.

- Software setup guide

This manual mainly explains how to install and configure the software that allows the machine to be used as a printer.

- Operation manual (for printer)*1

This manual explains the procedures for using the machine as a printer.

- Operation manual (for image send)*1

This manual explains the procedures for using the image send feature of the machine, including the network scanner and Internet fax functions.

To use the network scanner function, the network function of the machine must be in a useable state*2 and the network scanner expansion kit must be installed.

To use the Internet fax function, the network function of the machine must be in a useable state*2 and the network scanner expansion kit and the Internet fax expansion kit must be installed.

*1 The Operation manual (for printer) and the Operation manual (for image send) are provided as PDF files in the CD-ROM.

These manuals are not provided as printed manuals.

*2 On the MX-M550U/M620U/M700U, the network expansion kit is required.

INSTALLATION REQUIREMENTS

Improper installation may damage this product. Please note the following during initial installation and whenever the machine is moved.

1. The machine should be installed near an accessible power outlet for easy connection.

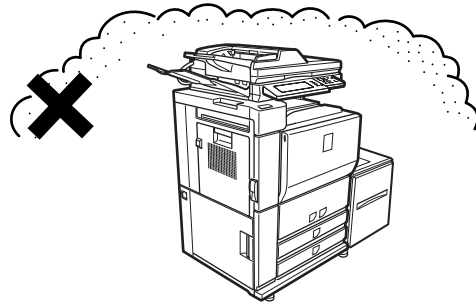

2. Be sure to connect the power cord only to a power outlet that meets the specified voltage and current requirements. Also make certain the outlet is properly grounded.

● For the power supply requirements, see the name plate on the back of the main unit.

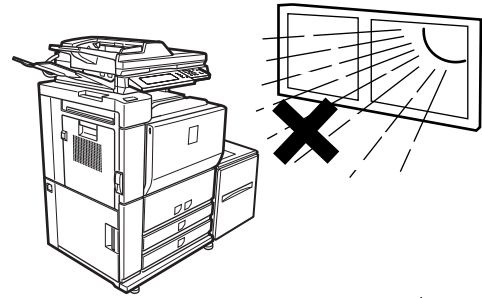

3. Do not install your machine in areas that are:

- damp, humid, or very dusty
- exposed to direct sunlight
- poorly ventilated
- subject to extreme temperature or humidity changes, e.g., near an air conditioner or heater.

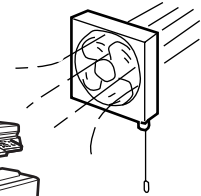

4. Be sure to allow the required space around the machine for servicing and proper ventilation.

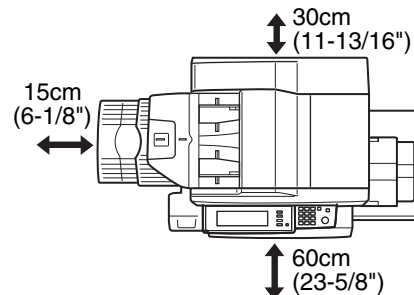
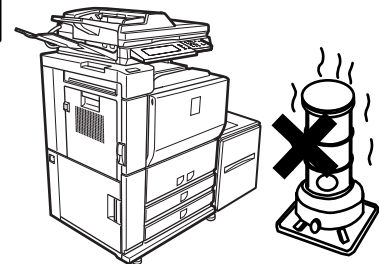
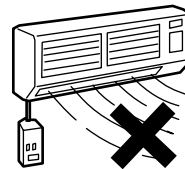

A small amount of ozone is produced within the printer during operation. The emission level is insufficient to cause any health hazard.

NOTE:

The present recommended long term exposure limit for ozone is 0.1 ppm (0.2 mg/m³) calculated as an 8 hr. time-weighted average concentration.

However, since the small amount that is emitted may have an objectionable odor, it is advisable to place the copier in a ventilated area.

CAUTIONS

1. Do not touch the photoconductive drum. Scratches or smudges on the drum will cause dirty prints.
2. The fusing unit is extremely hot. Exercise care in this area.
3. Do not look directly at the light source. Doing so may damage your eyes.
4. Four adjusters are provided on all optional stand/paper drawer units. These adjusters should be lowered until they contact the floor. When moving the machine with the optional stand/paper drawer, be sure to raise the adjusters. Also, unlock the two casters at the front of the optional stand/paper drawer. After moving the machine, lower the four adjusters until they reach the floor and lock the two casters.
5. Do not make any modifications to this machine. Doing so may result in personal injury or damage to the machine.
6. Since this machine is heavy, it is recommended that it be moved by more than one person to prevent injury.
7. When connecting this machine to a computer, be sure to first turn both the computer and the machine off.
8. Do not make copies of anything which is prohibited from copying by law. The following items are normally prohibited from printing by national law. Other items may be prohibited by local law.
 - Money • Stamps • Bonds • Stocks
 - Bank drafts • Checks • Passports • Driver's licences

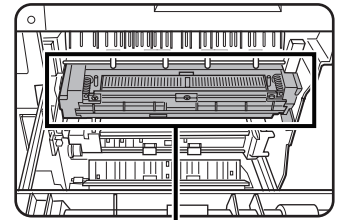

Fusing unit

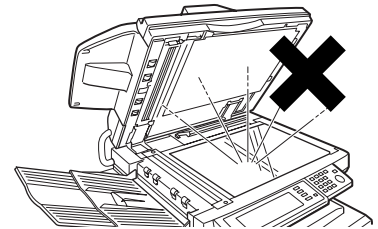

Adjuster

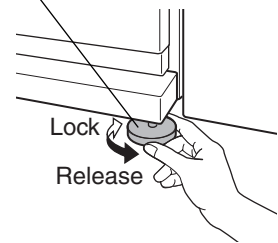

Lock

Release

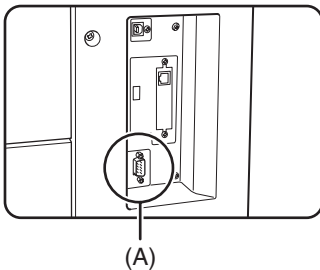

Caution:

This connector (A) is only intended for service purposes. Any connection to this terminal may cause malfunctions of the machine.

Instruction for service technician:

The cable length for the service terminal has to be less than 3m (118").

The machine includes the document filing function, which stores document image data on the machine's hard disk. Stored documents can be called up and printed or transmitted as needed. If a hard disk failure occurs, it will no longer be possible to call up the stored document data. To prevent the loss of important documents in the unlikely event of a hard disk failure, keep the originals of important documents or store the original data elsewhere. With the exception of instances provided for by law, Sharp Corporation bears no responsibility for any damages or loss due to the loss of stored document data.

"BATTERY DISPOSAL"

THIS PRODUCT CONTAINS A LITHIUM PRIMARY MEMORY BACK-UP BATTERY THAT MUST BE DISPOSED OF PROPERLY. PLEASE CONTACT YOUR LOCAL SHARP DEALER OR AUTHORIZED SERVICE REPRESENTATIVE FOR ASSISTANCE IN DISPOSING OF THIS BATTERY.

This product utilizes tin-lead solder, and a fluorescent lamp containing a small amount of mercury.

Disposal of these materials may be regulated due to environmental considerations.

For disposal or recycling information, please contact your local authorities or the Electronics Industries Alliance: www.eia.org

Laser Information

Wave length	785 nm +10 nm -15 nm
Pulse times	North America: 55 cpm / 62 cpm model: (3.1 μs ± 3.1 ns)/7 mm 70 cpm model: (2.7 μs ± 2.7 ns)/7 mm Europe: 55 cpm / 62 cpm model: (3.7 μs ± 3.7 ns)/7 mm 70 cpm model: (3.2 μs ± 3.2 ns)/7 mm
Output power	Max 0.8 mW

At the production line, the output power of the scanner unit is adjusted to 0.8 MILLIWATT PLUS 10 % and is maintained constant by the operation of the Automatic Power Control (APC).

Caution

Use of controls or adjustments or performance of procedures other than those specified herein may result in hazardous radiation exposure.

For North America:

SAFETY PRECAUTIONS

This Digital Equipment is rated Class 1 and complies with 21 CFR 1040.10 and 1040.11 of the CDRH standards. This means that the equipment does not produce hazardous laser radiation. For your safety, observe the precautions below.

- Do not remove the cabinet, operation panel or any other covers.
- The equipment's exterior covers contain several safety interlock switches. Do not bypass any safety interlock by inserting wedges or other items into switch slots.

For Europe:

CLASS 1 LASER PRODUCT

LASER KLASSE 1

LUOKAN 1 LASERLAITE

KLASS 1 LASERAPPARAT

<p>CAUTION INVISIBLE LASER RADIATION WHEN OPEN INTERLOCKS DEFEATED. AVOID EXPOSURE TO BEAM.</p> <p>VORSICHT UNSICHTBARE LASERSTRAHLUNG WENN ABDECKUNG GEÖFFNET UND SICHERHEITSVERRIEGELUNG ÜBERBRÜCKT. NICHT DEM STRAHL AUSSETZEN.</p> <p>ADVARSEL USYNLIG LASERSTRÅLNING VED ÅBNING, NÅR SIKKERHEDSBRYDERE ER UDE AF FUNKTION. UNDGÅ UDSAETTELSE FOR STRÅLNING.</p>	<p>VAROITUS! LAITTEEN KÄYTTÄMINEN MUULLA KUIN TÄSSÄ KÄYTTÖOHJEESSA MAINITULLA TAVALLA SAATTAÄ ALTISTAA KÄYTTÄJÄN TURVALLISUUSLUOKAN 1 YLITTÄVÄLLE NÄKYMÄTTÖMÄLLE LASERSÄTEILYLLE.</p> <p>VARNING OM APPARATEN ANVÄNDS PÅ ANNAT SÄTT ÄN I DENNA BRUKSANVISNING SPECIFICERATS, KAN ANVÄNDAREN UTSÄTTAS FÖR OSYNLIG LASERSTRÅLNING, SOM ÖVERSKRIDER GRÄNSEN FÖR LASERKLASS 1.</p>
---	--

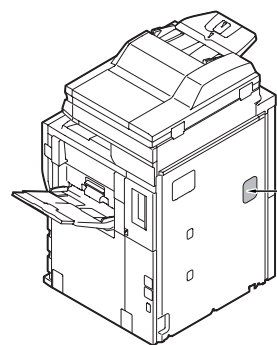

CLASS 1 LASER PRODUCT
LASER KLASSE 1

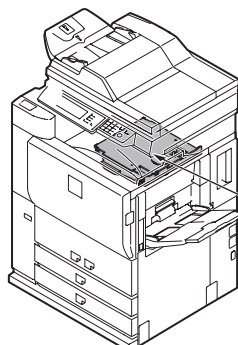

 <p>CAUTION VORSICHT ADVARSEL ADVERSEL VARNING VARO!</p>	<p>INVISIBLE LASER RADIATION WHEN OPEN AND INTERLOCKS DEFEATED. AVOID EXPOSURE TO BEAM. UNSICHTBARE LASERSTRAHLUNG WENN ABDECKUNG GEÖFFNET UND SICHERHEITSVERRIEGELUNG ÜBERBRÜCKT. NICHT DEM STRAHL AUSSETZEN. USYNLIG LASERSTRÅLNING VED ÅBNING, NÅR SIKKERHEDSBRYDERE ER UDE AF FUNKTION. UNDGÅ UDSAETTELSE FOR STRÅLNING. OSYNLIG LASERSTRÅLNING NÅR SKOVEN ER ÅPNET OCH SPÄRRINGAR ÄR ÖVERBRÜCKADE. STRÅLEN ÄR FARLIG. BETRÄKTA EJ STRÅLEN. AVTÄRRETTA JA SUOJALUKUTUS OHITETTÄESSÄ OLET ALTITINA NÄKYMÄTTÖMÄLLE LASERSÄTEILYLLE. ÄLÄ KÄSÄ, NÄTTEESÄ.</p>
<p>△ 注意 (サービスマン用)</p> <p>カバーを開けてかつインターロックを無効にした場合にはレーザー光にさらされないようにしてください。</p>	

CONTENTS

	Page
OPERATION MANUALS	0-1
INSTALLATION REQUIREMENTS.....	0-2
CAUTIONS.....	0-3
● Laser Information	0-4
CONTENTS	0-5

CHAPTER 1 BEFORE USING THE PRODUCT

INTRODUCTION.....	1-2
MAIN FEATURES	1-3
PART NAMES AND FUNCTIONS.....	1-10
● Exterior.....	1-10
● Interior	1-11
● Operation panel.....	1-13
● Touch panel.....	1-14
TURNING THE POWER ON AND OFF	1-17
AUDITING MODE	1-18
● Using the machine when the auditing mode is enabled.....	1-18

CHAPTER 2 MANAGING THE MACHINE

LOADING PAPER	2-2
● Identifying the trays	2-2
● Loading paper in paper tray 1 - tray 2	2-2
● Changing the paper size in paper tray 1 - tray 2 ..	2-3
● Loading paper in paper tray 3	2-5
● Changing the paper size in paper tray 3	2-5
● Changing the paper size in paper tray 4	2-6
● Loading paper in paper tray 5 (optional large capacity tray AR-LC6)	2-7
● Loading paper in paper tray 5 (optional large capacity tray AR-LC7)	2-8
● Loading paper in the bypass tray	2-10
● Specifications of paper trays (Types and sizes of paper that can be used in the trays).....	2-12
● Setting the paper type and paper size.....	2-14
● Setting the paper size when a special size is loaded	2-17
SYSTEM SETTINGS	2-18
● General procedure for system settings	2-18
● About the settings	2-20
REPLACING THE TONER CARTRIDGES	2-21
STORAGE OF SUPPLIES	2-22
MISFEED REMOVAL	2-23
● Misfeed removal guidance.....	2-23
● Misfeed in the transport area, fusing area, and exit area.....	2-24
● Misfeed in the duplex unit.....	2-25
● Misfeed in the paper feed area.....	2-26
REMOVING AN ORIGINAL MISFEED.....	2-31
● Removing a misfed original from the automatic document feeder	2-31
TROUBLESHOOTING	2-32

CHAPTER 3 PERIPHERAL DEVICES

FINISHER AND SADDLE STITCH FINISHER	3-2
● Part names	3-2
● Specifications	3-2
● Finishing methods	3-4
● Finishing modes and finisher functions	3-6
● Staple cartridge replacement and staple jam removal.....	3-7
● Removing a misfeed.....	3-11
● Troubleshooting finisher/saddle stitch finisher problems.....	3-13
INSERTER	3-14
● Part names	3-14
● Specifications	3-14
● Loading paper.....	3-15
● Manual operation of the inserter.....	3-15
● Misfeed removal	3-17
● Troubleshooting inserter problems	3-18
SHARP OSA.....	3-19
APPLICATION COMMUNICATION MODULE (MX- AMX2).....	3-19
● Standard application setup	3-19
● Selecting a standard application.....	3-19
● Operation in OSA mode	3-20
EXTERNAL ACCOUNT MODULE (MX-AMX3).....	3-21
● External account application setup.....	3-21
● Operation in external account mode.....	3-21

CHAPTER 4 MAKING COPIES

AUTOMATIC DOCUMENT FEEDER.....	4-2
● Acceptable originals	4-2
PLACING ORIGINALS	4-3
CHECKING THE SIZE OF A PLACED ORIGINAL.....	4-5
● Manually setting the scanning size	4-5
STORING, DELETING, AND USING ORIGINAL SIZES	4-6
● Storing or deleting an original size	4-6
NORMAL COPYING.....	4-7
● Making copies with the automatic document feeding function	4-7
● Automatic two-sided copying using the automatic document feeding function.....	4-10
● Copying from the document glass	4-11
● Automatic two-sided copying from the document glass	4-13
ADJUSTING THE EXPOSURE	4-14
REDUCTION/ENLARGEMENT/ZOOM	4-15
● Automatic selection (auto image)	4-15
● Manual selection (preset copy ratios/zoom)	4-16
● XY ZOOM	4-18
SPECIAL PAPERS	4-20

CHAPTER 5 CONVENIENT COPY FUNCTIONS

SPECIAL MODES	5-2
● General procedure for using special functions	5-2
● Margin shift	5-3
● Erase	5-4
● Dual page copy	5-5
● Pamphlet copy	5-6
● Job build	5-8
● Tandem copy	5-10
● Covers/inserts	5-12
● Transparency film with insert sheets	5-23
● Multi shot	5-24
● Book copy	5-26
● Tab copy	5-27
● Card shot	5-29
● Mirror image	5-31
● B/W reverse	5-31
● Print menu	5-32
STORING, USING AND DELETING JOB PROGRAMS	5-44
● Storing a job program	5-44
● Calling up a job program	5-45
● Deleting a stored job program	5-45
INTERRUPTING A COPY RUN	5-46

CHAPTER 6 MACHINE MAINTENANCE (FOR COPYING)

USER MAINTENANCE	6-2
● Cleaning the document glass and the automatic document feeder	6-2
TROUBLESHOOTING	6-3

CHAPTER 7 DOCUMENT FILING FUNCTION

OVERVIEW	7-2
● Document filing function	7-2
TO USE THE DOCUMENT FILING FUNCTION	7-4
● A look at the operation panel	7-4
● Saving files	7-4
● Main screen of document filing	7-5
● Document filing icons	7-5
SAVING A DOCUMENT IMAGE FILE	7-6
● Quick File	7-6
● Filing	7-7
● Print jobs	7-9
● Scan Save	7-10
CALLING UP AND USING A FILE	7-13
● Searching for and calling up a saved file	7-13
● Calling up and using a saved file	7-15
SYSTEM SETTINGS	7-24
● Creating, editing, and deleting user names and folders	7-24
ENTERING CHARACTERS	7-29
TROUBLESHOOTING	7-31

CHAPTER 8 SPECIFICATIONS

SPECIFICATIONS	8-2
INDEX	8-4



CHAPTER 1

BEFORE USING THE PRODUCT

This chapter contains basic information that should be read before using the product.

	Page
INTRODUCTION.....	1-2
MAIN FEATURES	1-3
PART NAMES AND FUNCTIONS.....	1-10
• Exterior.....	1-10
• Interior.....	1-11
• Operation panel.....	1-13
• Touch panel.....	1-14
TURNING THE POWER ON AND OFF.....	1-17
AUDITING MODE	1-18
• Using the machine when the auditing mode is enabled.....	1-18

INTRODUCTION

Thank you for purchasing a SHARP digital multifunction copier.

Please read this manual before using the machine. In particular, be sure to read "INSTALLATION REQUIREMENTS" before using the machine.

Please keep this manual close at hand for reference whenever necessary.

This manual provides general information on using the machine, such as routine maintenance and how to load paper and remove misfeeds. It also explains how to use the copier and document filing functions.

Separate manuals have been provided for the fax function, printer function, and network scanner function.

■ Original and paper sizes

This machine allows use of standard sizes in both the AB and inch systems.

These are shown in the tables below.

Sizes in the AB system
A3
B4
A4
B5
A5

Sizes in the inch system
11" x 17" (LEDGER)
8-1/2" x 14" (LEGAL)
8-1/2" x 13" (FOOLSCAP)
8-1/2" x 11" (LETTER)
7-1/4" x 10-1/2" (EXECUTIVE)
5-1/2" x 8-1/2" (INVOICE)

■ The meaning of "R" in original and paper size indications

Some original and paper sizes can be placed in either the portrait or landscape orientations. To differentiate between landscape and portrait, the landscape orientation size indication will contain an "R". These are indicated as A4R, B5R, 8-1/2" x 11"R, 5-1/2" x 8-1/2"R, etc. Sizes that can be placed only in the landscape orientation (A3, B4, 11" x 17", 8-1/2" x 14", 8-1/2" x 13") do not contain the "R" in their size indication.

Size indication with "R"



Landscape orientation

Size indication without "R"

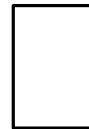

Portrait orientation

MAIN FEATURES

The digital multifunction copier is capable of performing a variety of functions. This page shows features related to the copy function.

- Sort mode → See page 1-3
- Group mode → See page 1-3
- 2-sided Copy → See page 1-3
- Exposure Adjustments → See page 1-3
- Reduction/Enlargement → See page 1-4
- XY Zoom → See page 1-4
- Margin Shift → See page 1-4
- Erase → See page 1-4
- Dual Page Copy → See page 1-4
- Pamphlet Copy → See page 1-4
- Job Build → See page 1-5
- Tandem Copy → See page 1-5
(When using the MX-M550U, MX-M620U, or MX-M700U, the network expansion kit is required.)
- Covers/inserts → See page 1-5
- Transparency Insert → See page 1-5
- Multi Shot → See page 1-5
- Book Copy → See page 1-5
- Tab Copy → See page 1-6
- Card Shot → See page 1-6
- Job programs → See page 1-6
- Mirror Image → See page 1-6
- B/W Reverse → See page 1-6
- Date print → See page 1-6
- Stamp → See page 1-7
- Page numbering → See page 1-7
- Text → See page 1-7
- Interrupting a copy run → See page 1-7
- Offset mode → See page 1-7
(When the Finisher or Saddle stitch finisher is installed.)
- Staple sort mode → See page 1-7
(When the Finisher or Saddle stitch finisher is installed.)
- Saddle stitch → See page 1-8
(When the Saddle stitch finisher is installed.)
- Hole punching → See page 1-8
(When the Punch Module is installed.)
- Inserter mode → See page 1-8
(When the Inserter is installed.)
- Document filing function → See page 1-8

Sort → See page 4-9

Copies can be collated.

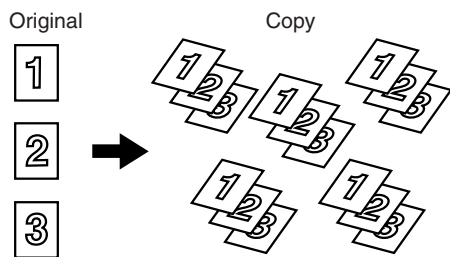

2-sided Copy → See pages 4-10, 4-13

Copy onto both sides of the paper using the document glass or the automatic document feeder.

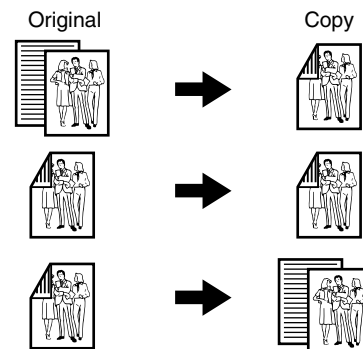

Group → See page 4-9

Copies can be grouped by page.

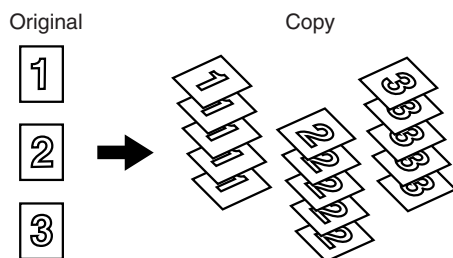

Exposure Adjustments → See page 4-14

The desired image type for the original can be selected.

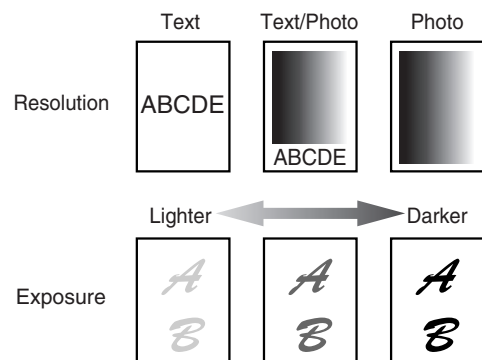

Reduction / Enlargement → See page 4-15

Copies can be enlarged or reduced to the desired size.

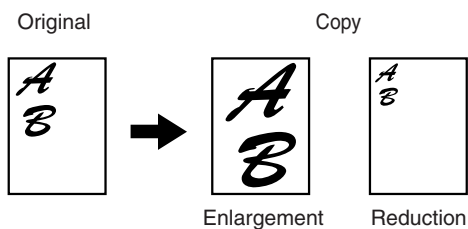

Erase → See page 5-4

Shadows that appear around the edges of copies of books or thick originals can be erased.

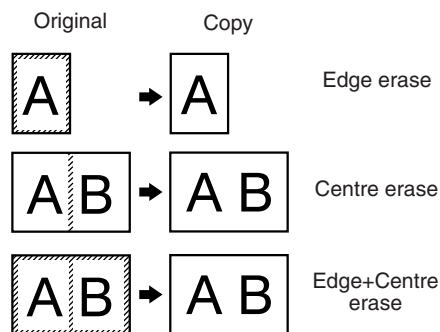

XY Zoom → See page 4-18

Separate ratio settings can be selected for the length and width of a copy.

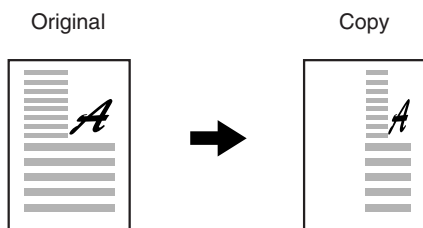

Dual Page Copy → See page 5-5

The left and right pages of a book can be successively copied onto separate sheets.

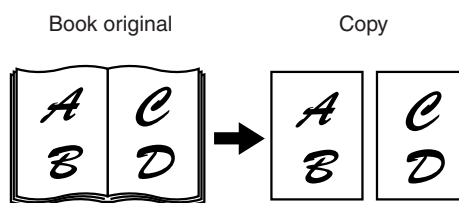

Margin Shift → See page 5-3

Margins can be added to copies.

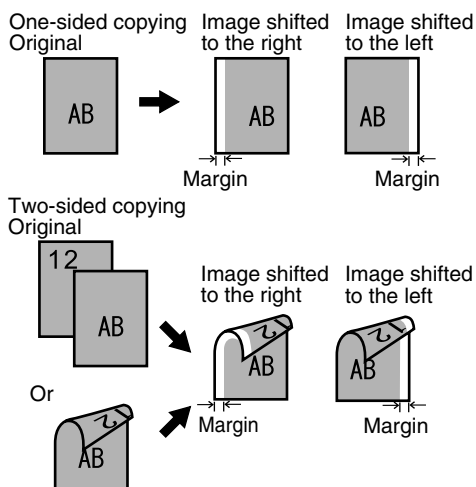

Pamphlet Copy → See page 5-6

One-sided or two-sided pamphlet style copies can be made.

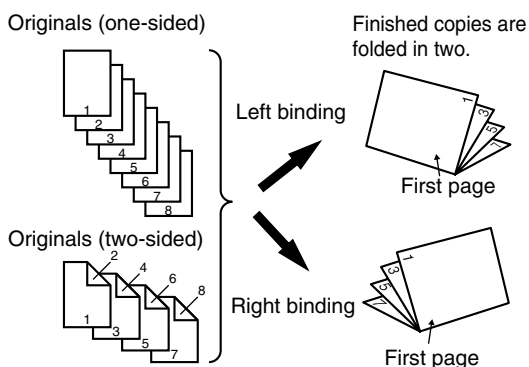

Job Build → See page 5-8

When you have a very large number of originals, the pages can be scanned in sets.

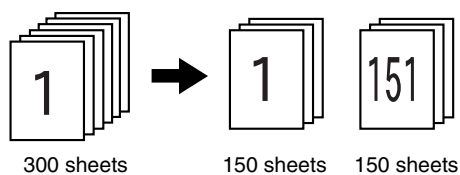

Transparency Insert → See page 5-23

Inserts can be automatically inserted between transparencies.

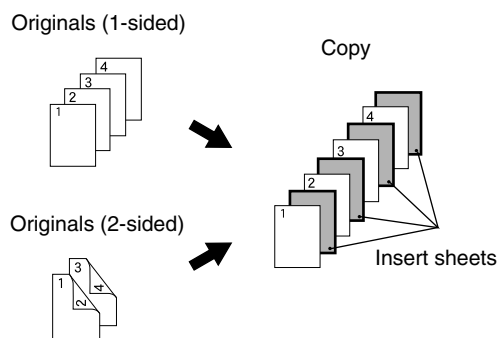

Tandem Copy → See page 5-10

Two machines can be used to run a large copy job in parallel.

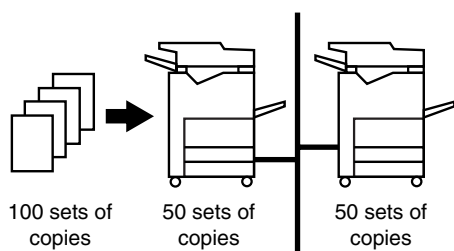

Multi Shot → See page 5-24

Multiple original pages can be copied onto a single sheet of paper in a uniform layout.

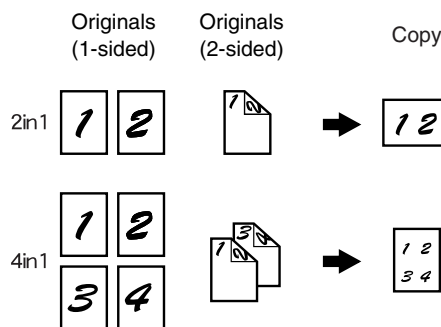

*When using the MX-M550U, MX-M620U, or MX-M700U, the network expansion kit is required.

Covers/inserts → See page 5-12

Front covers, back covers, and inserts can be added. These can also be copied on.

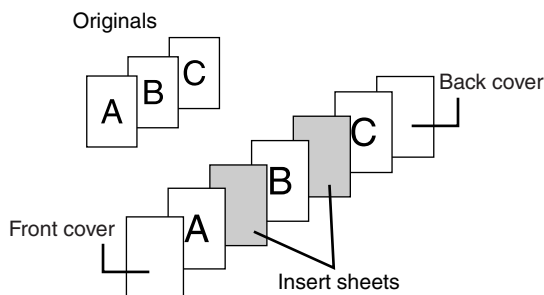

Book Copy → See page 5-26

Books and other bound originals can be copied pamphlet style.

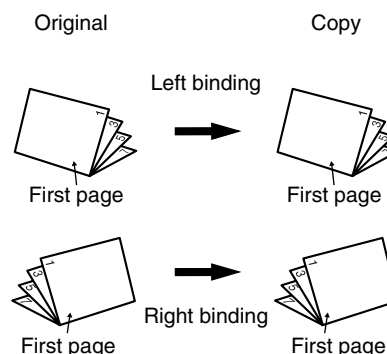

Tab Copy → See page 5-27

Copying is possible on the tabs of tabbed paper.

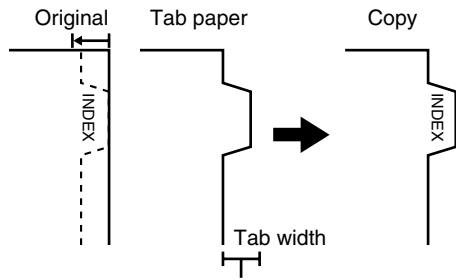

A4 : Maximum of 20mm (51/64")
 8-1/2" x 11" : Maximum of 17mm (5/8")

Mirror Image → See page 5-31

A mirror image copy can be made.

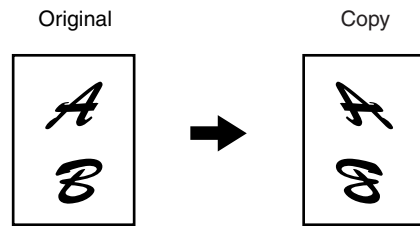

Card Shot → See page 5-29

The front and back of a card can be copied onto one sheet of paper.

This function is convenient for making copies for certification purposes and helps save paper.

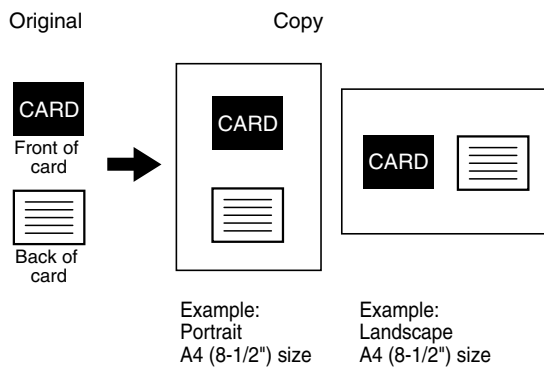

B/W Reverse → See page 5-31

White and black can be inverted on a copy to produce a negative image.

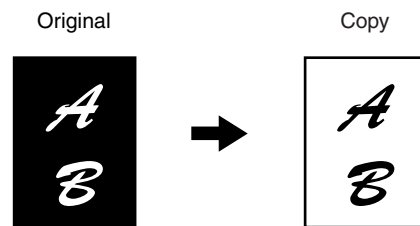

Job programs → See page 5-44

Various steps of a copy operation can be stored as a program, and up to 10 programs can be stored. Saving frequently used sets of settings in a program saves you the trouble of selecting those settings each time you wish to use them.

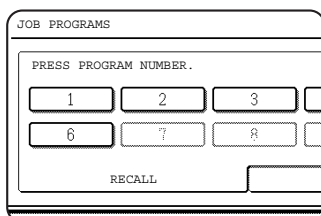

Date → See page 5-35

The date can be added to copies.

2010/APR/4

Stamp → See page 5-36

Reverse text can be added to copies ("stamp").



Interrupting a copy run → See page 5-46

A copy job in progress can be interrupted for a rush job.

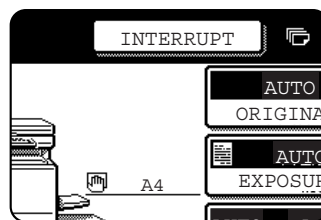

Page numbering → See page 5-37

Page numbers can be added to copies.

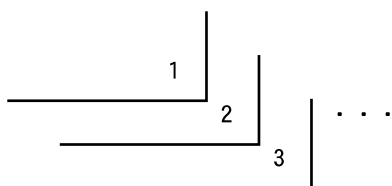

Offset mode → See page 3-4

Each set of output can be offset slightly from other sets for easy separation.

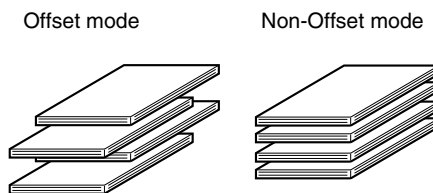

*When the Finisher or Saddle stitch finisher is installed.

Text → See page 5-41

Entered text can be added to copies.

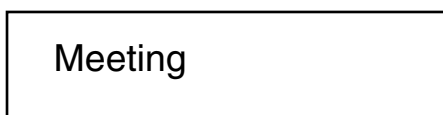

Staple sort mode → See page 3-4

Sets of copies can be automatically stapled.

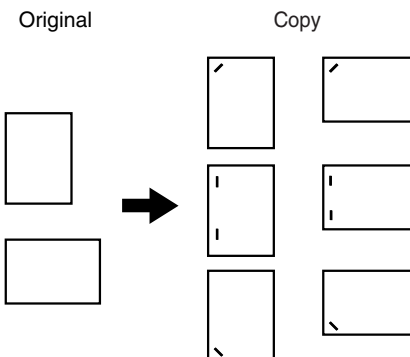

*When the Finisher or Saddle stitch finisher is installed.

Saddle stitch → See page 3-5

When a saddle stitch finisher is installed, copies can be automatically folded in half and stapled at the fold. (Use with the pamphlet function (see page 5-6) or book copy function (see page 5-26).)

Saddle stitch binding

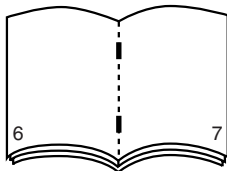

*When the Saddle stitch finisher is installed.

Document filing function → See chap. 7

A document image can be stored on the hard disk. A stored file can easily be called up and printed or transmitted.

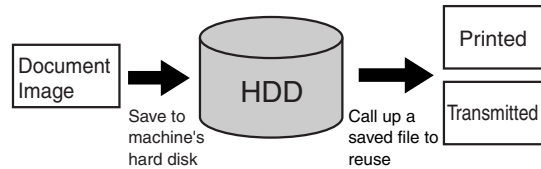

Hole punching → See page 3-5

Copies can be punched to add holes.

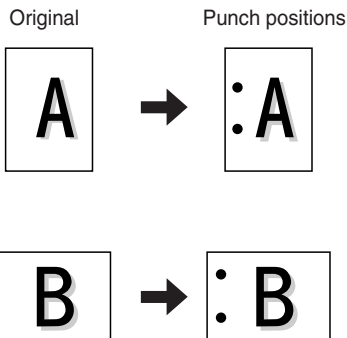

*When the Punch module is installed.

Inserter mode → See page 3-14

Blank or already printed-on sheets of paper can be added as a cover or an insert without being printed on. The inserter can be used to feed heavy sheets of paper that cannot be fed from other trays.

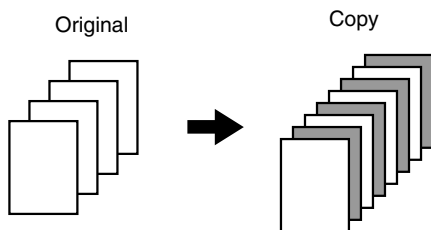

*When the Inserter is installed.

Energy saving features

This product has the following two power reducing modes that conform to the Energy Star guidelines to help conserve natural resources and reduce environmental pollution.

Preheat mode

The preheat mode is the first level of power reduction. The power is reduced to the fuser unit a preset time after the machine has completed a job and no further machine operations have been performed. The machine can recover to the ready condition within a short period of time. The preset time to enter the mode can be set by a administrator settings.

Auto power shut-off mode

The auto power shut-off mode is the second level of power reduction. In this mode power is shut off to the fusing unit and the touch panel. In this state more energy is saved than in the preheat mode but the time to recover to the ready condition will be longer. The preset time to enter this mode can be set by a administrator settings.

When this product is used as a printer, and either of the above modes is active, the mode will be deactivated automatically by an incoming job and the machine will automatically warm up and start to print when it has reached the ready temperature.

When this product is configured for multi-function operation, and either of the above modes is active, the mode will be deactivated as above by an incoming print job. Either mode will also be deactivated by operation of DOCUMENT FILING, IMAGE SEND or COPY mode key.



Products that have earned the ENERGY STAR® are designed to protect the environment through superior energy efficiency.

PART NAMES AND FUNCTIONS

Exterior

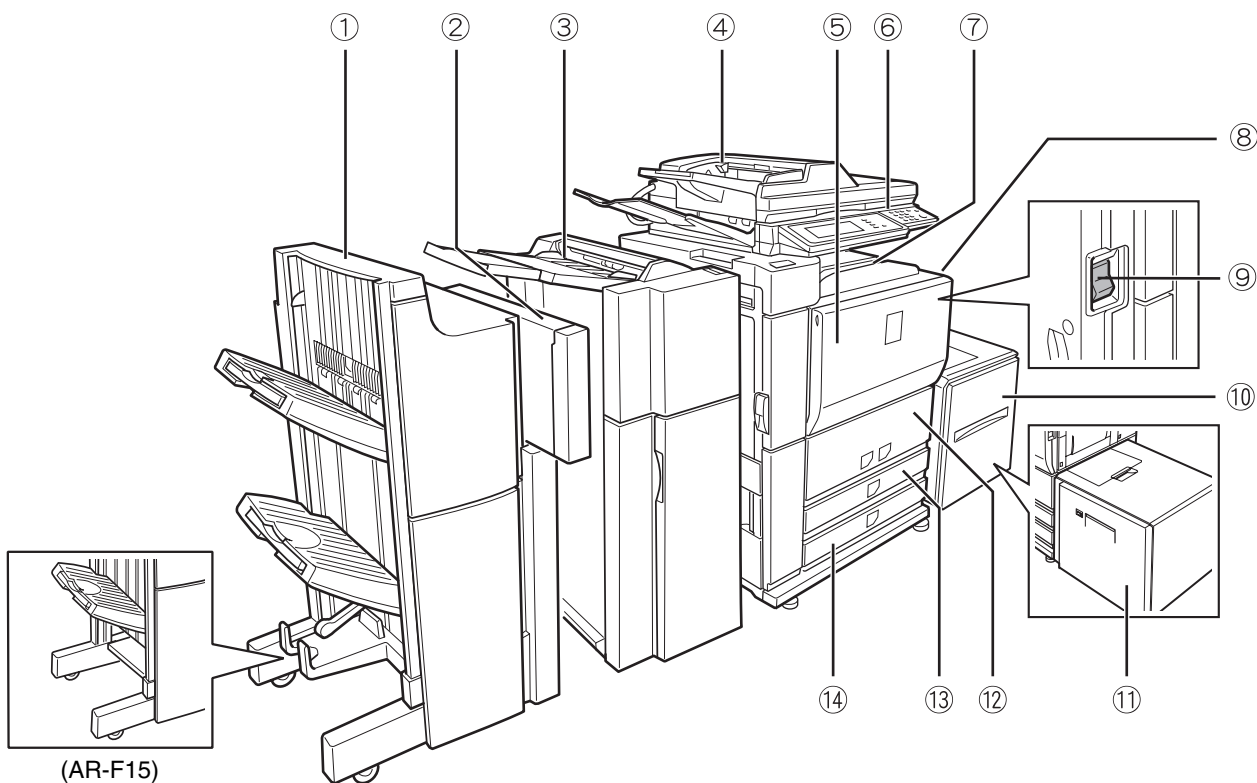

- ① **Saddle stitch finisher (AR-F16)*¹ / Finisher (AR-F15)*¹** (See page 3-2)
- ② **Punch module (AR-PN4A)*¹** (See page 3-2)
- ③ **Inserter (AR-CF2)*¹** (See page 3-14)
- ④ **Automatic document feeder** (See page 4-2)
This automatically feeds and scans multiple sheet originals. Both sides of two-sided originals can be scanned at once.
- ⑤ **Front cover**
Open to replace toner cartridge.
- ⑥ **Operation panel**
- ⑦ **Centre tray** (See page 4-9)
Finished sheets are deposited here
- ⑧ **Bypass tray**
Special papers (including transparency film) and copy paper can be fed from the bypass tray.
- ⑨ **Power switch** (See page 1-17)
Turns the power on and off.
If the power does not come on when the power switch is turned on, check the main power switch to see if it is turned on.
- ⑩ **Tray 5 (Large capacity tray(AR-LC6))*¹** (See page 2-7)
- ⑪ **Tray 5 (Large capacity tray(AR-LC7))*¹** (See page 2-8)
- ⑫ **Tray 1-Tray 2**
The trays hold paper. Approximately 800 sheets of standard A4 or 8-1/2" x 11" size paper (80 g/m² (20 lbs.)) can be loaded in tray 1, and approximately 1200 sheets of standard A4 or 8-1/2" x 11" size paper (80 g/m² (20 lbs.)) can be loaded in tray 2.
- ⑬ **Tray 3**
Tray 3 holds paper. Approximately 500 sheets of standard (80 g/m² (20 lbs.)) paper can be loaded in this tray. Tabbed paper and transparencies can also be loaded.
- ⑭ **Tray 4**
Tray 4 holds paper. Approximately 500 sheets of standard (80 g/m² (20 lbs.)) paper can be loaded in this tray.

*1 ①, ②, ③, ⑩ and ⑪ are peripheral devices. For information on these devices, see the explanations of the devices in the manual.

Interior

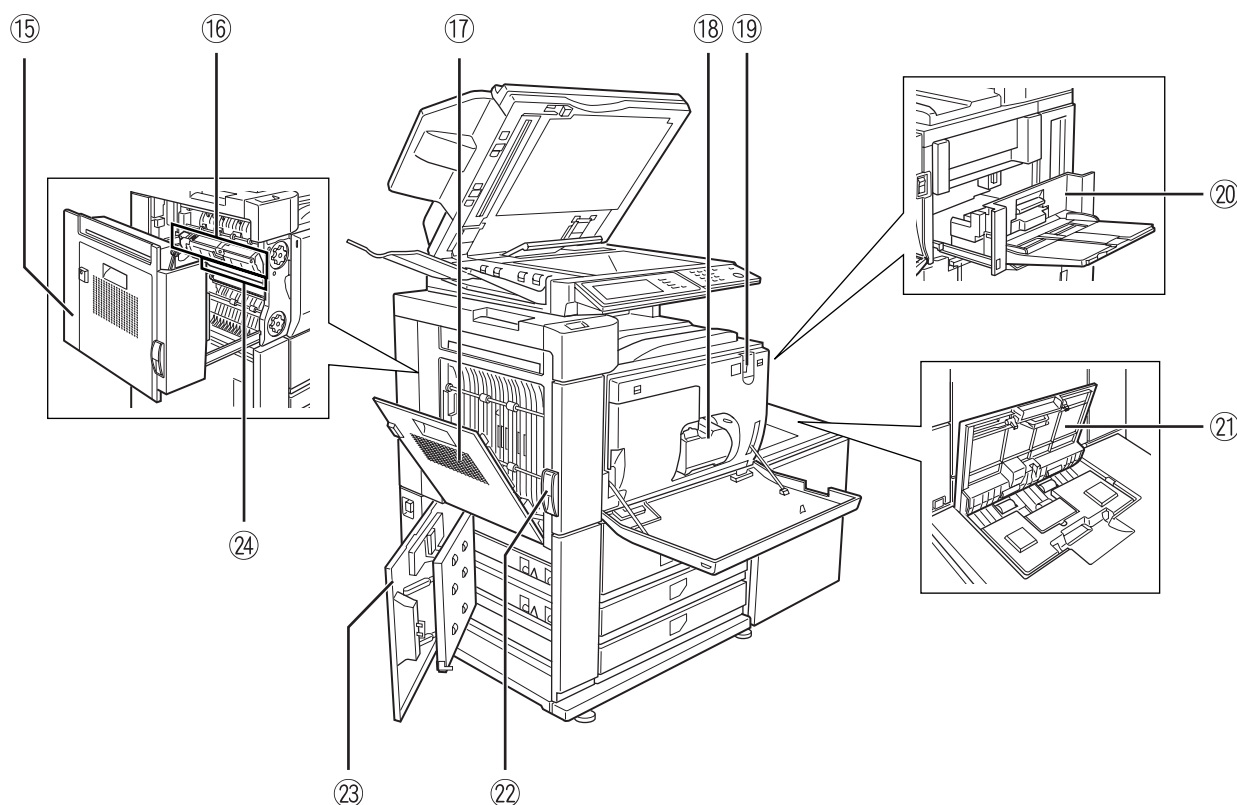

15 Duplex unit

Open this cover to remove a misfeed from the fusing unit area.

16 Fusing unit

Toner images are fused here.

CAUTION

The fusing unit is hot. Take care in removing misfed paper.

17 Cover of the duplex unit

Open when a misfeed has occurred in duplex unit.

18 Toner cartridge*2

This holds toner for printing. The toner cartridge must be replaced when indicated on the operation panel.

19 Main power switch (See page 1-17)

Keep this switch turned on when the fax option or Internet fax option is installed.

20 Right side cover

Open when a misfeed has occurred in the bypass tray or large capacity tray.

21 Upper cover of large capacity tray

Open when a misfeed has occurred in the large capacity tray.

22 Left side cover release

Push this knob up to open the left side cover.

23 Left cover of paper drawer

Open this cover to remove paper misfed in tray 3 or tray 4.

24 Photoconductive drum

Images are formed on the photoconductive drum.

NOTE

Do not touch or damage the photoconductive drum.

*2 See page 2-21 for the procedure for installing and replacing the toner cartridge.

■ Other optional equipment

● Network expansion kit (MX-NBX1)

This kit is required to add on the network function. When this expansion kit is installed, the machine can be used as a network printer.

● Barcode font kit (AR-PF1)

This kit adds bar code fonts to the machine.

● Data security kit (MX-FRX5)

This kit is used to erase electronic data from the hard disk and memory immediately after a document is printed or transmitted.

● PS3 expansion kit (MX-PKX1)

This kit provides compatibility of PostScript level 3 to the printer.

● Facsimile expansion kit (AR-FX8)

This kit is required to add fax function.

● Additional fax memory (8 MB) (AR-MM9)

● 256MB expansion memory board (AR-SM5)

This extends the memory of the machine.

● Network scanner expansion kit (MX-NSX1)

This kit is required to add the network scanning feature.

To add the network scanner function to the MX-M550U, MX-M620U, or MX-M700U, the network expansion kit is required.

● Internet fax expansion kit (MX-FWX1)

This kit is required to use the Internet fax function. To add the Internet fax function, the network scanner expansion kit is required.

● Application integration module (MX-AMX1)

The application integration module can be combined with the network scanner function to append a metadata file to a scanned image file.

● Application communication module (MX-AMX2)

This allows the machine to be linked over a network to an external software application.

● External account module (MX-AMX3)

This is required to use an external account application on the machine.

Peripheral devices are basically optional, but are incorporated in some models as standard equipment.

Operation panel

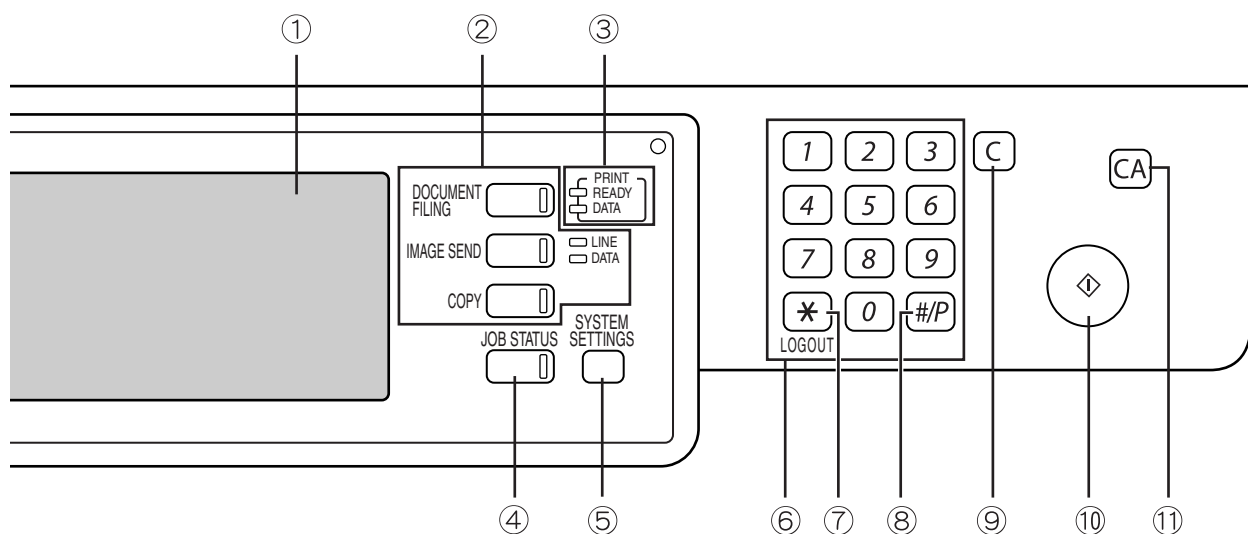

① Touch panel

The machine status, messages and touch keys are displayed on the panel. The document filing, copy, network scanner*¹, and fax*², Internet fax*³ functions are used by switching to the screen for the desired function. See the following page.

② Mode select keys and indicators

Use to change modes and the corresponding display on the touch panel.

[DOCUMENT FILING] key

Press to select the document filing mode. (See page 7-5.)

[IMAGE SEND] key/LINE indicator/DATA indicator

Press to change the display to network scanner mode*¹, fax mode*² or Internet fax mode*³. (See the "Operation manual (for image send)") and "Operation manual (for facsimile)".)

[COPY] key

Press to select the copy mode.

③ PRINT mode indicators

READY indicator

Print data can be received when this indicator is lit.

DATA indicator

Lights up or blinks when print data is being received. Also lights up or blinks when printing is being performed.

④ [JOB STATUS] key

Press to display the current job status. (See page 1-15.)

⑤ [SYSTEM SETTINGS] key

This is used to store, edit, and delete user names and folder names for the document filing function, and to configure the administrator settings and printer configuration settings. (See page 7-24)

⑥ Numeric keys

Use to enter numeric values for various settings.

⑦ [*] key ([LOGOUT] key)

This key is used in copy mode, document filing mode, network scanner mode*¹, fax mode*², and Internet fax mode*³.

⑧ [#/P] key

This is used as a program key when using the copy function, and to dial when using the fax function*².

⑨ [C] key (Clear key)

This key is used in copy mode, document filing mode, network scanner mode*¹, fax mode*², and Internet fax mode*³.

⑩ [START] key

Use this key to start copying in copy mode, scan a document in network scanner mode*¹, or scan a document for transmission in fax mode*² or Internet fax mode*³.

⑪ [CA] key (Clear all key)

This key is used in copy mode, document filing mode, network scanner mode*¹, fax mode*², and Internet fax mode*³. Use the key to cancel settings and perform an operation from the initial machine state.

*1 When the network scanner option is installed.

*2 When the fax option is installed.

*3 When the Internet fax option is installed.

Touch panel

The touch panel screens shown in this manual are printed images, and may appear different from the actual screens.

■ Using the touch panel

[Example 1]

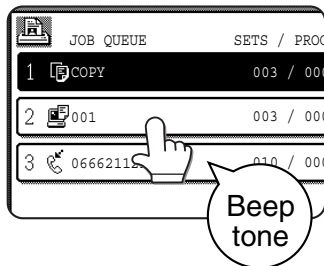

Items on the touch panel are easily selectable by touching the key associated with the item with a finger. Selection of an item will be accompanied with a beep tone* to confirm the item was selected.

Also, the key area for the item will be highlighted for visual confirmation.

* If a greyed out key is touched, a double beep will sound.

[Example 2]

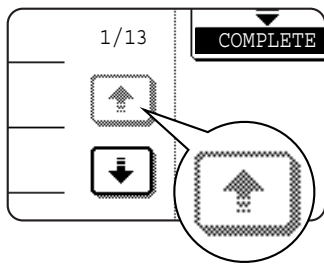

Keys which are greyed out on any screen are not selectable.

The confirmation beeps can be disabled using "Keys touch sound" in the administrator settings. (See page 10 of the administrator settings guide.)

■ Selecting a function

[Example 1]

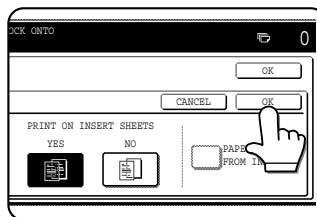

If a key is highlighted in a setting screen at the time the screen appears, the [OK] key can be pressed to store the selection without further operation.

[Example 2]

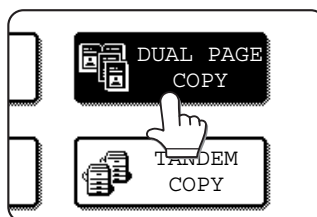

A function in the special functions screen is selected by touching the key so that it is highlighted. To cancel the selection, touch the highlighted key once again.

Copier feature
● Dual page copy
● Job build
● Tandem copy
● Mirror image
● B/W Reverse

[Example 3]

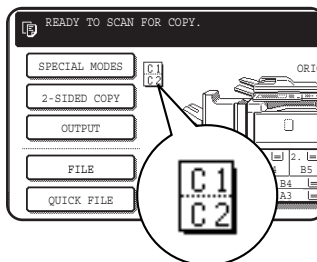

A corresponding icon representing the feature will appear on the touch key and on the main screen of the mode selected. If this icon is touched, the setting screen of the function (or a menu screen) will appear, allowing the settings to be checked or adjusted and the function to be cancelled easily.

■ Job status screen (common to print, scan, fax and Internet fax)

This screen is displayed when the [JOB STATUS] key on the operation panel is pressed.

This screen can be used to display the "JOB QUEUE" (showing stored jobs and the current job) or the "COMPLETE" job list (showing finished jobs). This screen is used to check jobs, move a job to the top of the JOB QUEUE, or delete a job.

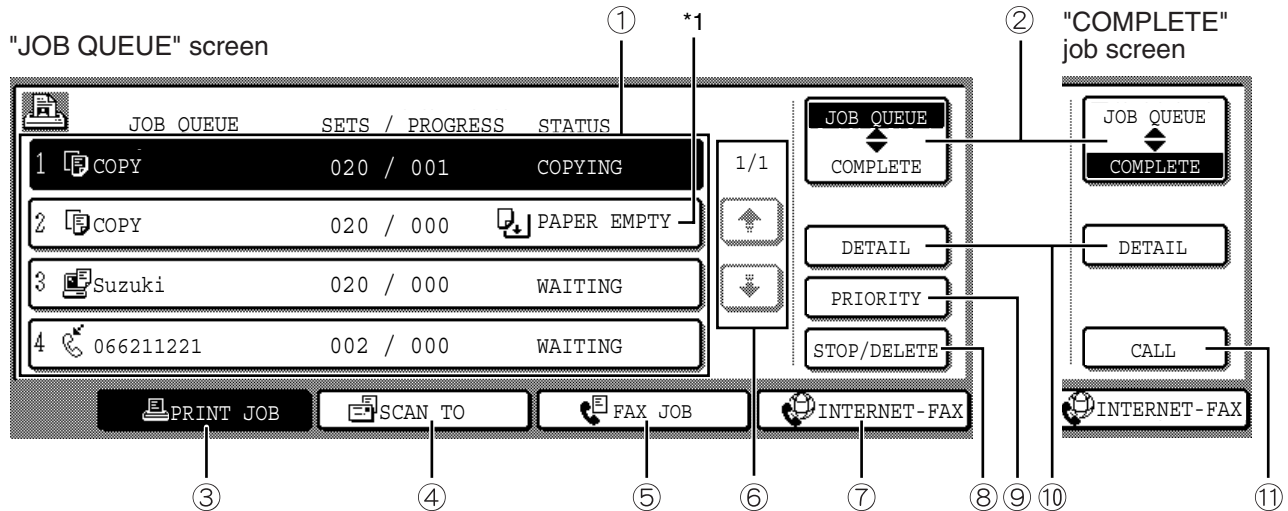

① Job list

The displayed jobs in the job list are themselves operation keys. To cancel printing or to give a job the highest print priority, touch the relevant job key to select the job and execute the desired operation using the keys described in ⑧ and ⑨.

This shows the current job and the jobs waiting to be run. The icons to the left of the jobs in the queue show the job mode. The document filing reprint job icon is highlighted.

Note that the icon does not become highlighted during retransmission of a fax/image transmission job.

Print mode Copy mode

SCAN mode

Scan to e-mail job Scan to FTP job

Scan to Desktop job

Scan to Network folder job

Fax mode

Fax send job Fax reception job

PC-Fax send job

Internet Fax mode

i-Fax send job i-Fax reception job

PC-Internet Fax send job

*1 "PAPER EMPTY" in the job status display

When a job status display indicates "PAPER EMPTY", the specified paper size for the job is not loaded in any of the trays.

In this case, the job will be suspended until the required paper is loaded. Other stored jobs will be printed (if possible) until the required paper is loaded. (Other jobs will not be printed if the paper runs out during printing.) If you need to change the paper size because the specified paper size is not available, touch the current job key to select it and then touch the [DETAIL] key described in ⑩.

② Mode select key

This switches the job list display between "JOB QUEUE" and "COMPLETE".

"JOB QUEUE": Shows stored jobs and the job in progress.

"COMPLETE": Shows finished jobs.

Files saved using the "FILE" and "QUICK FILE" functions and finished broadcast transmission jobs appear as keys in the finished job screen. The "FILE" or "QUICK FILE" job keys in the finished job screen can be touched, followed by the [CALL] key, to call up a finished job and print or transmit it. A finished broadcast transmission job key can be touched followed by the [DETAIL] key to check the result of the transmission.

③ **[PRINT JOB] key**

This displays the print job list of print mode (copying, printing, fax reception, Internet fax reception, and self printing).

④ **[SCAN TO] key**

This displays the transmission status and finished jobs of scan mode (Scan to e-mail, Scan to FTP, Scan to Desktop, and Scan to Network Folder) when the network scanner option is installed.

⑤ **[FAX JOB] key**

This displays the transmission/reception status and finished jobs of fax mode (fax and PC-Fax) when the fax option is installed.

⑥ **Display switching keys**

Use to switch the page of the displayed job list.

⑦ **[INTERNET-FAX] key**

This displays the transmission/reception status and finished jobs of Internet fax mode and PC Internet fax mode when the Internet fax option is installed.

⑧ **[STOP/DELETE] key**

Use to cancel or delete the current job or delete the selected reserved job. Note that printing of received faxes and received Internet faxes cannot be cancelled or deleted.

⑨ **[PRIORITY] key**

A stored job in the "JOB QUEUE" job list can be printed ahead of all other stored jobs by selecting the job and then touching this key.

⑩ **[DETAIL] key**

This shows detailed information on the selected job. Files saved using the "FILE" and "QUICK FILE" functions and finished broadcast transmission jobs appear as keys in the finished job screen. A Quick File in the finished job screen or the [Filing] key can be touched, followed by the [CALL] key, to call up a finished job and print or transmit it. A finished broadcast transmission job key can be touched followed by the [DETAIL] key to check the result of the transmission.

⑪ **[CALL] key**

When this key is touched after selecting a job in the COMPLETE job status screen (a job stored using the FILE or QUICK FILE keys of the document filing function), the "JOB SETTINGS" menu screen appears to let you resend or reprint the finished job. (See "Document filing function" on page 7-2.)

TURNING THE POWER ON AND OFF

The machine has two power switches. The main power switch can be found at the upper right after the front cover is opened. The power switch is located at the upper left of the right side of the machine.

The two switches are normally used as follows:

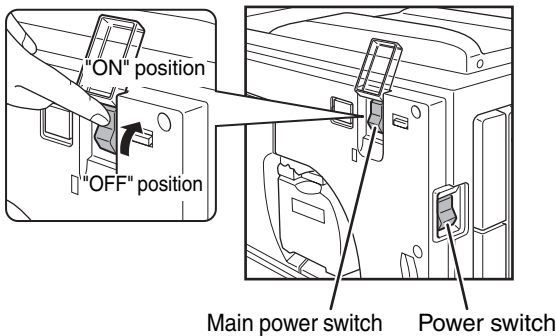

Main power switch: Normally kept in the ON position. (Be sure to keep ON when using the fax function.)

Power switch : Turn to ON position before using the machine.
Turn OFF at night when the machine is not used.

Main power switch ON, Power switch ON

The copy, printer, fax*, Internet fax*, network scanner*, and document filing functions can be used. If the machine is not used for a certain interval after turning on the power switch, the machine will automatically enter a reduced power consumption state (preheat mode or auto power shut-off mode (see page 1-9)).

*The required options must be installed to use these functions.

Main power switch OFF, Power switch ON

The copy, printer, fax, Internet fax, network scanner, and document filing functions cannot be used.

CAUTION

Before turning off the main power switch, make sure that the communication and data lights are not blinking on the operation panel. Turning off the main power switch or unplugging the power cord while the lights are blinking may damage the hard disk and cause the data being stored or received to be lost.

Main power switch ON, Power switch OFF

Set the switches in this way at night or at other times when the machine is not being used. The touch panel cannot be used, however, the following functions will remain operational:

When the fax option is installed:

Automatic fax reception, timer transmission (automatic transmission at a specified time), and transmission when a polling request is received from another machine (remote transmission, relay broadcast transmission)

When the Internet fax option is installed:

Automatic Internet fax reception

Main power switch OFF, Power switch OFF

The copy, printer, fax, Internet fax, network scanner, and document filing functions cannot be used. Turn both switches off and unplug the power cord if you suspect a machine failure, if there is a bad thunderstorm nearby, or when you are moving the machine.

AUDITING MODE

Auditing mode can be enabled to keep track of the number of pages printed and transmitted (scanned) by each account (up to 500 accounts can be established). The page counts can be viewed and totaled as needed. <This mode is enabled in the administrator settings separately for the copy, printer, fax, Internet fax, network scanner, and document filing functions (page 7 of the administrator settings guide)>

Using the machine when the auditing mode is enabled

The procedure for making copies when auditing mode has been enabled for the copy function is explained below.

NOTES

- When auditing mode is enabled for document filing and fax/image transmission, a message will appear asking you to enter your account number each time you switch to the main screen of one of those functions in the touch panel. Enter your account number in the same way as for copy mode, and then begin the scanning procedure.
- When the account counter is turned on for the printer function, you must enter your account number in the setting screen of the printer driver on your computer in order to print.

When the account counter is turned on, the right message appears on the touch panel.

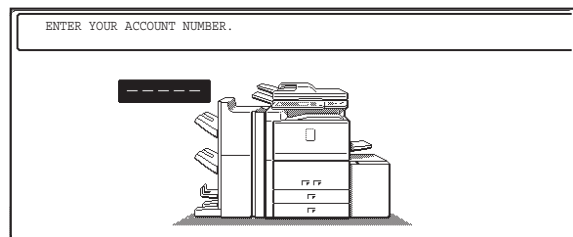

When the above screen appears, enter your 5-digit account number and then begin the copying procedure.

1 Enter your account number (5 digits) with the numeric keys.

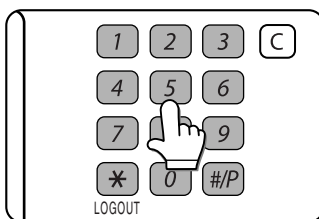

As you enter your account number, the hyphens (-) change to asterisks (*). If you enter an incorrect digit, press the [C] key and re-enter the correct digit.

When a correct account number is entered, the following message will appear.

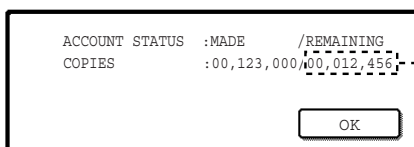

If a limit has been set in the administrator settings for the number of copies that can be made by the account, the remaining number that can be made is displayed.

Check the number in the display and touch the [OK] key.

NOTE

If "ACCOUNT NUMBER SECURITY" is enabled in the administrator settings and an incorrect account number is entered three times in a row, "PLEASE SEE YOUR ADMINISTRATOR FOR ASSISTANCE." will appear (page 8 of the administrator settings guide). Operation is not possible while this message appears (about one minute).

2 Follow the appropriate steps to perform the copy job.

When copying is begun, the following message will appear.

READY TO SCAN FOR COPY.
PRESS [LOGOUT] WHEN FINISHED.

To perform an interrupt copy job (page 5-46), touch the [INTERRUPT] key and then enter your account number as explained in step 1. The following message will appear.

COPY INTERRUPT MODE.
READY TO SCAN FOR COPY.

3 When the copy job is finished, press the [*] key ([LOGOUT] key)

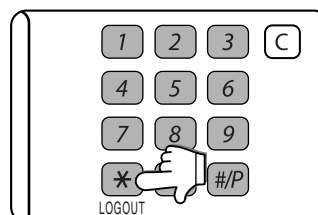

CHAPTER 2

MANAGING THE MACHINE

This chapter explains how to load paper, replace the toner cartridge, and remove paper misfeeds. It also contains information about supplies.

	Page
LOADING PAPER	2-2
• Identifying the trays	2-2
• Loading paper in paper tray 1 - tray 2	2-2
• Changing the paper size in paper tray 1 - tray 2	2-3
• Loading paper in paper tray 3	2-5
• Changing the paper size in paper tray 3	2-5
• Changing the paper size in paper tray 4	2-6
• Loading paper in paper tray 5 (optional large capacity tray AR-LC6) ...	2-7
• Loading paper in paper tray 5 (optional large capacity tray AR-LC7) ...	2-8
• Loading paper in the bypass tray	2-10
• Specifications of paper trays (Types and sizes of paper that can be used in the trays).....	2-12
• Setting the paper type and paper size	2-14
• Setting the paper size when a special size is loaded.....	2-17
SYSTEM SETTINGS	2-18
• General procedure for system settings	2-18
• About the settings	2-20
REPLACING THE TONER CARTRIDGES	2-21
STORAGE OF SUPPLIES	2-22
MISFEED REMOVAL	2-23
• Misfeed removal guidance	2-23
• Misfeed in the transport area, fusing area, and exit area.....	2-24
• Misfeed in the duplex unit.....	2-25
• Misfeed in the paper feed area.....	2-26
REMOVING AN ORIGINAL MISFEED	2-31
• Removing a misfed original from the automatic document feeder ..	2-31
TROUBLESHOOTING	2-32

LOADING PAPER

If the paper runs out during printing, a message will appear in the display. Follow the procedure below to load paper.

Identifying the trays

The trays are identified using numbers as shown below.

For the types and sizes of paper that can be used in each tray, see page 2-12.

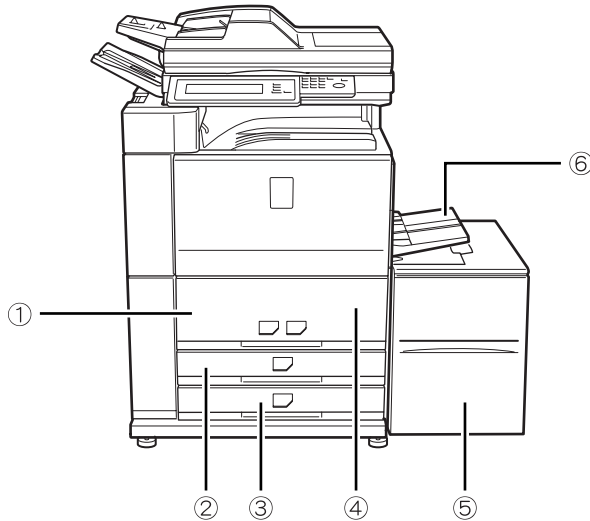

- ① **Tray 1**
This is the left large capacity tray.
- ② **Tray 3**
- ③ **Tray 4**
- ④ **Tray 2**
This is the right large capacity tray.
- ⑤ **Tray 5**
This is an optional large capacity tray.
- ⑥ **Bypass tray**

NOTES

- Do not use curled or folded paper. Doing so may cause a misfeed.
- Do not place heavy objects or press hard on any tray which is pulled out.
- Do not place objects on the large-capacity tray. This may damage the tray or interfere with operation.
- Load paper with the print side face up. However, when the paper type is set to "PRE-PRINTED" or "LETTER HEAD", load the paper face down*.

* If the two-sided function is disabled using "DISABLING OF DUPLEX" in the administrator settings (page 11 of the administrator settings guide), load the paper face up.

Loading paper in paper tray 1 - tray 2

A4 or 8-1/2" x 11" size paper can be loaded in tray 1. A4 or 8-1/2" x 11" size paper can be loaded in tray 2. These are parallel large-capacity trays that allow a total of approximately 2000 sheets of SHARP standard paper (80 g/m² (20 lbs.)) to be loaded. If you wish to change the paper size of tray 1 or tray 2, see "Changing the paper size in paper tray 1 - tray 2" on the next page.

1 Pull out paper tray 1-tray 2.

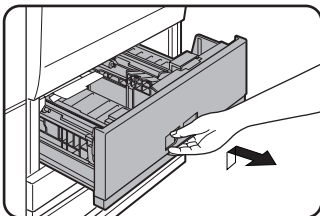

Gently pull the tray out until it stops.

2 Load paper in the left and right trays.

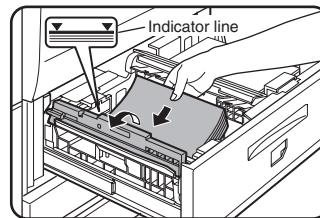

Lift the paper guide and load paper in tray 1.*
Approximately 800 sheets of SHARP standard paper (80 g/m² (20 lbs.)) can be loaded.

Be sure to return the paper guide to its original position after loading the paper.

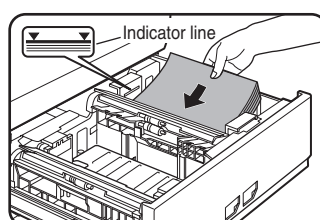

Load paper in tray 2.*
Approximately 1200 sheets of SHARP standard paper (80 g/m² (20 lbs.)) can be loaded.

*1 The paper stack must not be higher than the indicator line.

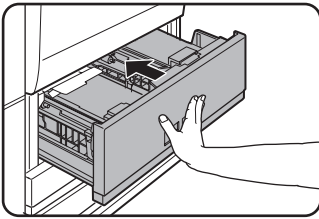
3 Gently push tray 1-tray 2 into the machine.

Push the tray firmly all the way into the machine.

4 Set the paper type.

If the paper size was changed from an AB size to an inch size, or from an inch size to an AB size, or if the paper type was changed, be sure to change the appropriate settings as explained in "Setting the paper type and paper size" (See page 2-14).

5 Loading paper in paper tray 1/tray 2 is now complete.

2

Changing the paper size in paper tray 1 - tray 2

To change the paper size of tray 1 - tray 2, follow the steps below.

This section only explains how to change the paper size. For the procedures for opening/closing the tray and loading paper, see "Loading paper in paper tray 1 - tray 2" (page 2-2).

To have the paper size of tray 1 changed to B5, or to have the paper size of tray 1 changed from B5 to another size, consult your dealer or nearest authorised service representative. (Only a service technician can change the paper size in this case.)

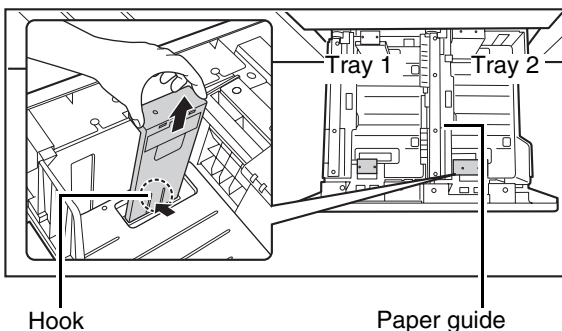
1 Remove the paper size guide.

With the base of the tray pressed all the way down, hold down the hook at the bottom on the paper size guide and pull the paper size guide up slightly.

NOTES

- Do not place heavy objects on the tray or press down on the tray.
- Before changing the paper size of tray 1, raise the paper guide.

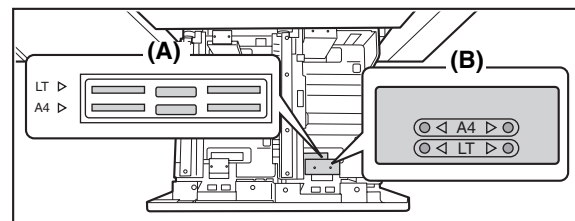
2 Adjust the paper size guide to the paper size to be used.

Paper sizes are inscribed at the slot (A) on the bottom of the tray and at the hole (B) at the top of the paper size guide. ("LT" indicates 8-1/2" x 11" size.)

Align the bottom of the paper size guide with the slot, and align the hole at the top with the locking tab.

NOTES

- When attaching the paper size guide, make sure that the top and bottom of the guide are aligned to the same paper size.
- If the top and bottom of the paper size guide are not aligned to the same paper size, skewed feeding and misfeeds will result.

3 Push in the paper guide so that it locks into place.

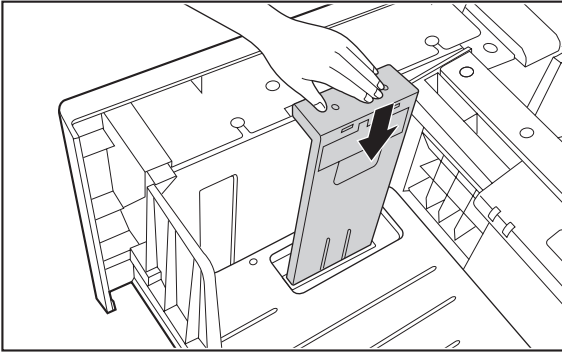

Push the paper size guide in until the hook at the bottom locks into place. (You will hear a "click" when the hook locks.) Move the paper size guide slightly to verify that it has locked into place.

4 Repeat steps 1 to 3 to adjust the far paper guide to the paper size to be used.

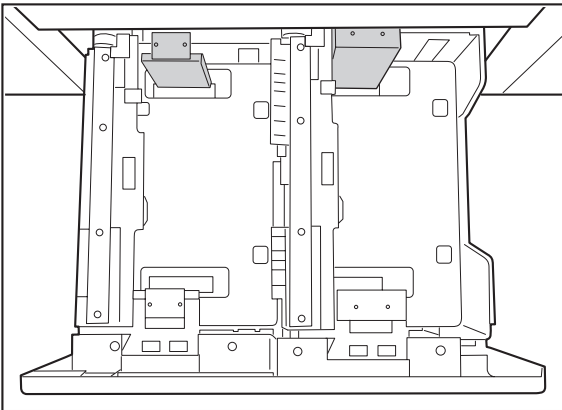

Be sure to adjust the far paper guide to the same size as the near paper guide.

5 Set the paper type and paper size.

For the procedure for configuring these settings, see "Setting the paper type and paper size" (page 2-14).

An incorrect paper type or paper size setting may cause automatic selection of the wrong type or size of paper, and result in a misfeed or otherwise prevent printing.

NOTES

- When removing and attaching the far paper size guide, take care not to hit the front cover of the machine.
- Adjust both the front and back guides. If only one guide is adjusted, skewed feeding and misfeeds may result.

Loading paper in paper tray 3

Approximately 500 sheets of standard paper (80 g/m² (20 lbs.)) from A3 to A5R size (11" x 17" to 5-1/2" x 8-1/2"R) can be loaded in tray 3. Special papers such as tabbed paper and transparency film can also be loaded. For information on what special papers can be used, see "Specifications of paper trays (Types and sizes of paper that can be used in the trays)" on page 2-12. To load tabbed paper or transparency film, see "Loading tabbed paper" or "Loading transparency film" on the next page.

1 Pull out paper tray 3.

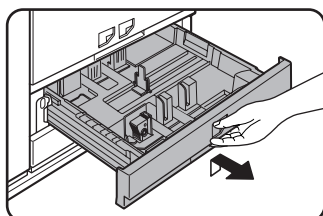

Gently pull the tray out until it stops.

3 Gently push tray 3 into the machine.

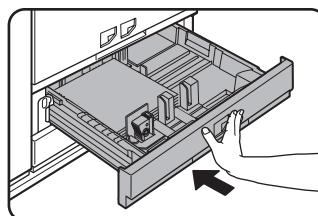

Push the tray firmly all the way into the machine.

2 Load paper into the tray.

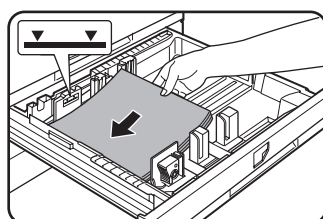

The paper stack must not be higher than the indicator line (no more than 500 sheets of SHARP standard paper (80 g/m² (20 lbs.))).

To change the paper size, see "Changing the paper size in paper tray 3" below.

4 Set the paper type.

If the paper size was changed from an AB size to an inch size, or from an inch size to an AB size, or if the paper type was changed, be sure to change the appropriate settings as explained in "Setting the paper type and paper size" (see page 2-14).

5 Loading paper in paper tray 3 is now complete.

Changing the paper size in paper tray 3

1 Pull out paper tray 3.

If paper remains in the tray, remove it.

2 Adjust the guide plates A and B by squeezing their lock levers and sliding them to the paper size to be loaded.

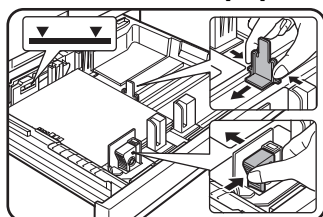

The guide plates A and B are slidable. Adjust them to the paper size to be loaded while squeezing their lock levers.

3 Load paper into the tray.

4 Gently push tray 3 into the machine.

Push the tray firmly all the way into the machine.

5 Set the paper type of the paper that was loaded in tray 3.

Be sure to change the appropriate settings as explained in "Setting the paper type and paper size" (see page 2-14).

If you changed the paper size, be sure to change the paper size setting. An incorrect paper size setting will cause the wrong paper to be automatically selected and may prevent printing or cause misfeeds.

6 Changing the paper size in paper tray 3 is now complete.

■ Loading tabbed paper

When using tabbed paper, follow the steps below to attach the special guide to the divider plate at the bottom edge of the tabbed paper. (Tabbed paper cannot be used in tray 4.)

1 Take out the tabbed paper guide.

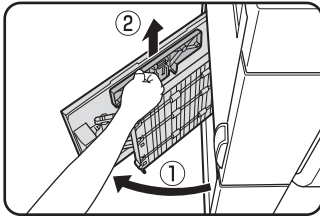

The guide is stored inside the left side of the machine as shown. Be sure to replace the guide when you have finished using it.

2 Pull out the tray and attach the guide.

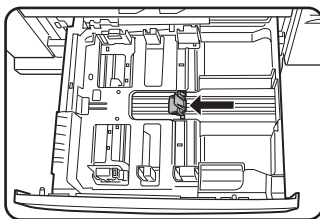

Slide the divider plate to the position of the bottom edge of the tabbed paper and attach the guide so that it covers the divider plate.

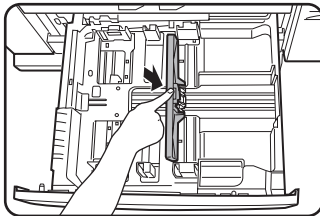
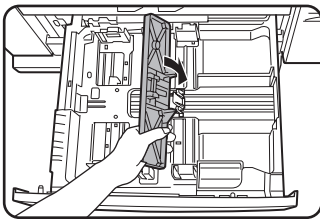

3 Place the tabbed paper in the tray.

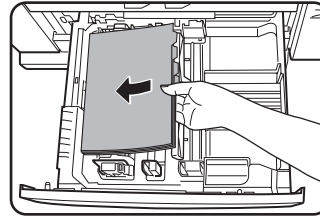

Place the tabbed paper with the print side face up.

[Example]

Make sure that the positions of the tabs correspond with the originals as shown below.

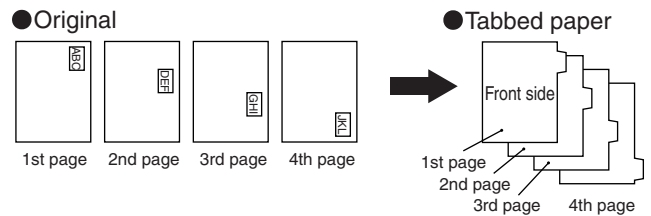

4 Gently push the tray in and set the paper type to tabbed paper.

(See "Setting the paper type and paper size" on page 2-14)

■ Loading transparency film

Be sure to load transparency film with the label facing down and the film oriented vertically. Smudging and a dirty image may result if the film is loaded with the label facing up. (Transparency film cannot be used in tray 4.)

Changing the paper size in paper tray 4

Plain paper from A3 to B5 size (11" x 17" to 7-1/4" x 10-1/2"R) can be loaded in tray 4. For paper that can be used, see "Specifications of paper trays (Types and sizes of paper that can be used in the trays)" on page 2-12.

The procedures for loading paper in tray 4 and changing the paper size are the same as for tray 3 (see page 2-5).

NOTE

When referring to the explanations of tray 3, keep in mind that special papers such as tabbed paper and transparency film cannot be used in tray 4. Use tray 3 for special paper.

Loading paper in paper tray 5 (optional large capacity tray AR-LC6)

The large capacity tray can hold up to 3,500 sheets of A4 size (8-1/2" x 11") SHARP standard paper (80 g/m² (20 lbs.)). If you wish to change the paper size, please consult your dealer (the paper size must be changed by a service technician).

1 Pull the tray out until it stops.

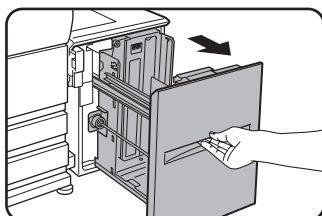

When the tray is in operation, do not use excessive force to pull the tray out. This may damage the tray.

3 Push the tray firmly all the way into the machine.

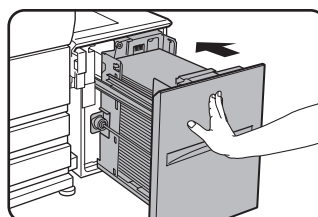

The paper table will automatically rise to the paper feed position.

2 Place the paper in the centre of the paper table.

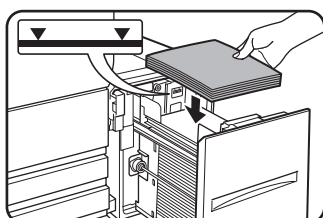

The paper stack must not be higher than the indicator line (up to 3,500 sheets of SHARP standard paper (80 g/m² (20 lbs.))

If the paper type was changed, be sure to change the appropriate settings as explained in "Setting the paper type and paper size" (See page 2-14).

2

■ Specifications

Name	Large capacity tray (AR-LC6)
Paper size	A4 (8-1/2" x 11")
Paper weight	60 to 105 g/m ² (16 to 28 lbs.)
Paper capacity (plain)	3500 sheets (80 g/m ² (20 lbs.))
Dimensions	376 mm (W) x 546 mm (D) x 518 mm (H) (14-23/32" (W) x 21-1/2" (D) x 20-13/32" (H))
Power supply	Supplied from the main unit
Weight	Approximately 28.5 kg (62.9 lbs.)
Overall dimensions when attached to machine	1347 mm (W) x 679 mm (D) (53-3/64" (W) x 26-47/64" (D))

Specifications are subject to change for improvement without notice.

Loading paper in paper tray 5 (optional large capacity tray AR-LC7)

An optional large capacity tray (AR-LC7) is available for the machine. The AR-LC7 can hold up to 3000 sheets of 80 g/m² (20 lbs.) paper. (See the following "Specifications" for the types of paper that can be used in the large capacity tray.)

When installed, the AR-LC7 operates as "Tray 5". The AR-LC7 cannot be used together with the AR-LC6 described on page 2-7.

Part names

Operation button / Indicator

To load paper in the tray, press this button, wait until the indicator turns off, and then pull the tray out.

Top cover

Open this cover to remove a misfeed.

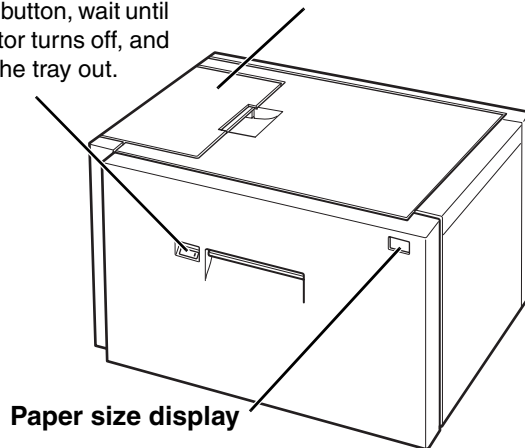

- Load paper in the tray with the print side face up. However, if the paper type is "PRE-PRINTED" or "LETTER HEAD", load the paper with the print side face down*.

* If the two-sided function is disabled using "DISABLING OF DUPLEX" in the administrator settings (page 11 of the administrator settings guide), load the paper face up.

Specifications

Name	Large capacity tray (AR-LC7)
Paper sizes*	A3 (11" x 17"), B4 (8-1/2" x 14"), A4 (8-1/2" x 11"), A4R (8-1/2" x 11"R) Paper weight 60 to 105 g/m ² (16 to 28 lbs.)
Number of paper trays / Paper capacity	One tray 3000 sheets (80 g/m ² or 20 lbs.)
Power supply	Supplied from the machine
Dimensions	690mm (W) x 587mm (D) x 521.5mm (H) (27-5/32" (W) x 23-7/64" (D) x 20-17/32" (H))
Weight	Approx. 50 kg (Approx. 110 lbs.)

* The indicated sizes of plain paper can be used. When using the AR-LC7, refer also to "More information on plain paper" on page 2-13.

Specifications are subject to change for improvement without notice.

NOTES

- If you wish to change the paper size, please consult your dealer (the paper size must be changed by a service technician).
- Do not use curled or folded paper. This may cause misfeeds.
- When the tray has been pulled out, do not place heavy objects on the tray or press down on the tray.
- Do not place any objects on the large capacity tray or use it instead of a chair or step. This may damage the tray and interfere with the use of the bypass tray.

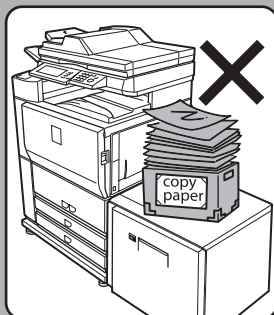

■ Loading paper in the AR-LC7

If the paper runs out during printing, a message will appear in the display. Follow the procedure below to load paper.

1 Pull the tray out until it stops.

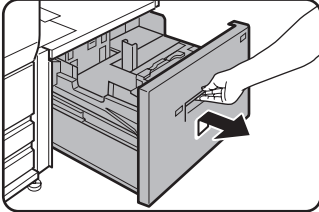

Pull the finger grip up and pull the tray out until it stops.

NOTE

To add or change paper, press the operation button.

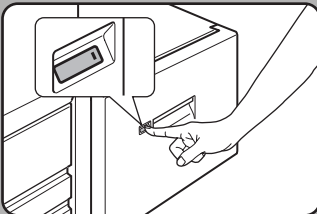

When the button is pressed, the indicator will blink until the paper table stops descending. Do not pull the tray out until the indicator turns off. Attempting to pull

the tray out when the indicator is blinking or solidly lit may damage the tray.

2 Place the paper on the paper table.

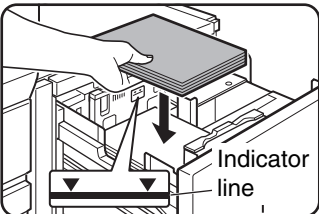

The paper stack must not be higher than the indicator line.

When the paper tray is pulled out, the paper table will have descended to a position where

approximately 500 sheets of A4 size (8-1/2" x 11") 80 g/m² (20 lbs.) paper can be placed. After the paper is placed, the paper table will descend to a position where an additional approximately 500 sheets can be placed. When the paper table has descended all the way, approximately 3000 sheets can be held.

If a different type of paper is loaded that was used previously, the paper settings for tray 5 must be changed on the machine. Be sure to change to the appropriate settings as explained in "Setting the paper type and paper size" on page 2-14.

CAUTION

When loading paper, take care not to insert your hands into holes on paper table.

Do not insert your hands here.

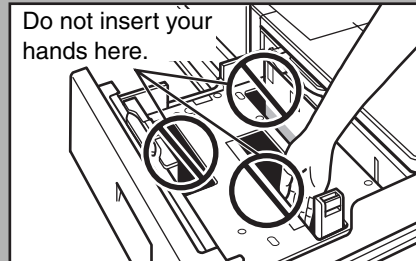

2

NOTES

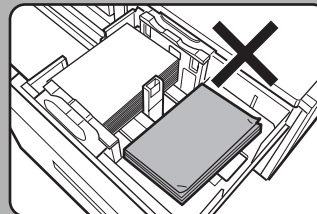

Do not insert objects in the tray or attempt to place spare paper in the tray. This may damage the tray.

- Use SHARP-recommended paper (page 2-22). Special paper cannot be used.

3 Push the tray firmly all the way into the machine.

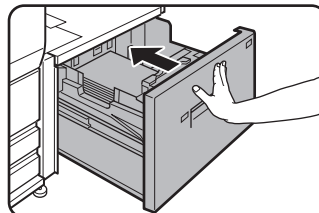

After the tray is pushed in, the indicator will blink until the paper table finishes ascending and then light solidly.

Loading paper in the bypass tray

The bypass tray can be used to print on plain paper, postcards, label sheets, tabbed paper, and other special papers. When using SHARP standard paper, up to 100 sheets can be loaded (up to 20 postcards) for continuous printing similar to the other trays. For the paper types that can be used in the bypass tray, see "Specifications of paper trays (Types and sizes of paper that can be used in the trays)" on page 2-12.

NOTE

After loading the paper in the bypass tray, be sure to set the paper type and size (step 4) if these were changed.

1 Open the bypass tray.

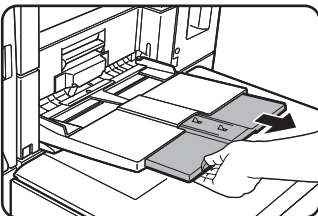
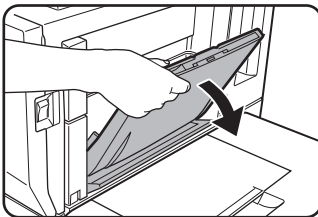

When loading A3, B4, A4R, 11" x 17", 8-1/2" x 14", 8-1/2" x 13" or 8-1/2" x 11"R size paper, be sure to pull the auxiliary tray all the way out. If the auxiliary tray is not pulled all the way out, the size of the loaded paper will not be correctly displayed.

2 Set the bypass tray guides to the width of the copy paper.

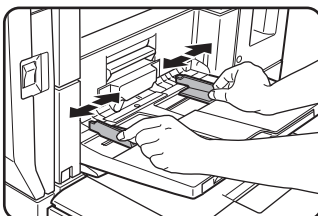

3 Insert the copy paper all the way into the bypass tray. (Do not force the paper in.)

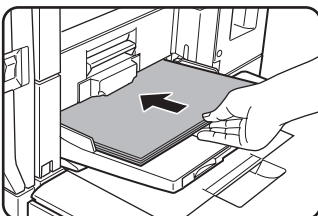

Place the copy paper face up. If the bypass tray guides are set wider than the copy paper, the inside of the machine may become soiled, resulting in smudges on succeeding copies. A gap may cause skewing or wrinkling.

4 Set the type and size of the paper loaded in the bypass tray.

If the paper size was changed from an AB size to an inch size, or from an inch size to an AB size, or if the paper type was changed, be sure to change the appropriate settings as explained in "Setting the paper type and paper size" (see page 2-14).

5 This completes the procedure for loading paper in the bypass tray.

■ Loading tabbed paper in the bypass tray

[Example]

Make sure that the positions of the tabs correspond with the originals as shown below.

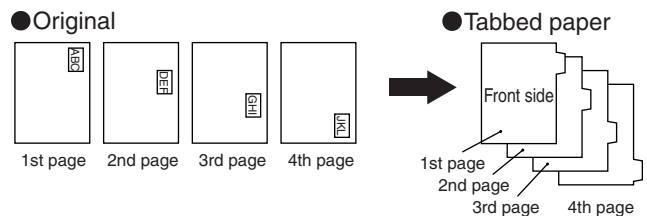

Place the tabbed paper face up.

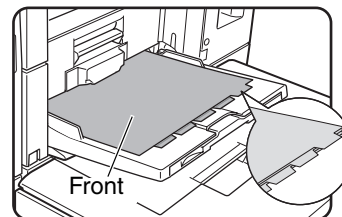

■ Important points when using the bypass tray

- Be sure to load A5 paper, 5-1/2" x 8-1/2" paper, and postcards as shown (1) horizontal loading in the diagram below.

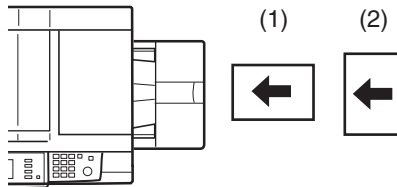

(1):Horizontal loading

(2):Vertical loading

- When loading plain paper other than SHARP standard paper, special media other than postcards, SHARP-recommended transparency film, or paper to be printed on the back, the paper must be loaded one sheet at a time. Loading more than one sheet at a time will cause misfeeds.
- Before loading heavy paper, straighten any curling in the paper.
- When adding paper, remove any paper remaining in the tray, combine it with the paper to be added, and reload as a single stack.
- Do not use paper that has already been printed on by a plain paper fax machine or a laser printer. This may cause printed images to become dirty.
- When printing on transparency film, be sure to remove each sheet as it exits the machine. Allowing sheets to stack in the output tray may cause curling.
- Use only Sharp-recommended transparency film. Transparency film should be loaded in the bypass tray with the label facing down and the film oriented vertically. Smudging and a dirty image may result if the film is placed with the label facing up.

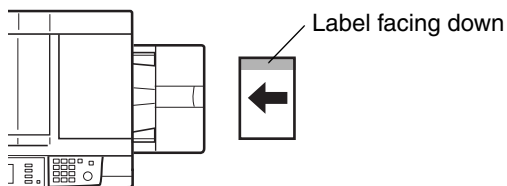

- When loading multiple sheets of transparency film in the bypass tray, be sure to fan the sheets several times before loading.
- Use only tabbed sheets that are made of paper. Tabbed sheets made of film or other material cannot be used.

Specifications of paper trays (Types and sizes of paper that can be used in the trays)

The specifications for the types and sizes of paper that can be loaded in the paper trays are shown below.

Tray No. (tray name)	Applicable paper types	Applicable paper sizes	Paper weight
Tray 1	Plain paper (Refer to the next page "More information on plain paper".)	A4, 8-1/2" x 11"	60 to 105 g/m ² (16 to 28 lbs.)
Tray 2		A4, 8-1/2" x 11"	
Tray 3	Plain paper (Refer to the next page "More information on plain paper".)	<ul style="list-style-type: none"> When "AUTO-AB" is selected in "Setting the paper type and paper size" (page 2-14), the following paper sizes can be automatically detected: A3, B4, A4, A4R, B5, B5R, A5R, 8-1/2" x 13" When "AUTO-INCH" is selected in "Setting the paper type and paper size" (page 2-14), the following paper sizes can be automatically detected: 11" x 17", 8-1/2" x 14", 8-1/2" x 11", 8-1/2" x 11"R, 7-1/4" x 10-1/2"R, 5-1/2" x 8-1/2"R Non-standard sizes 	60 to 128 g/m ² (16 to 34 lbs.)
	Special paper (Refer to the next page "More information on special media that can be used".)	<ul style="list-style-type: none"> Heavy paper Transparency film Labels Tabbed paper 	<ul style="list-style-type: none"> When "AUTO-AB" is selected in "Setting the paper type and paper size" (page 2-14), the following paper sizes can be automatically detected: A4, A4R, B5, B5R (only A4 for tabbed paper) When "AUTO-INCH" is selected in "Setting the paper type and paper size" (page 2-14), the following paper sizes can be automatically detected: 8-1/2" x 11", 8-1/2" x 11"R (only 8-1/2" x 11" for tabbed paper) Non-standard sizes smaller than A4 or 8-1/2" x 11" 40 sheets of transparency film can be loaded Tabbed paper can be used
Tray 4	Plain paper (Refer to the next page "More information on plain paper".)	<ul style="list-style-type: none"> When "AUTO-AB" is selected in "Setting the paper type and paper size" (page 2-14), the following paper sizes can be automatically detected: A3, B4, A4, A4R, B5, B5R, 8-1/2" x 13" When "AUTO-INCH" is selected in "Setting the paper type and paper size" (page 2-14), the following paper sizes can be automatically detected: 11" x 17", 8-1/2" x 14", 8-1/2" x 11", 8-1/2" x 11"R, 7-1/4" x 10-1/2"R Non-standard sizes 	60 to 128 g/m ² (16 to 34 lbs.)
Bypass tray	Same as tray 3. Postcards can also be used. However, <ul style="list-style-type: none"> Up to 100 sheets of plain paper can be loaded. Up to 20 sheets of transparency film can be loaded. Up to 20 postcards can be loaded. 		The same paper as tray 3, and also 52 to 59 g/m ² (14 lbs. to 15 lbs.) thin paper can be used.
Tray 5 (AR-LC6)	Same as tray 2.		
Tray 5 (AR-LC7)	Plain paper (Refer to the next page "More information on plain paper".)	A3, B4, A4, A4R, 11" x 17", 8-1/2" x 14", 8-1/2" x 11", 8-1/2" x 11"R	60 to 105 g/m ² (16 to 28 lbs.)

■ More information on plain paper

Incorrect feeding may result in poor toner fusing (the toner does not adhere to the paper well and can be rubbed off), skewed feeding, misfeeds, or other failures.

		Paper in AB system	Paper in inch system
		A5 to A3	5-1/2" x 8-1/2" to 11" x 17"
Plain paper	SHARP standard paper (See page 2-22)	64 g/m ² (17 lbs.)	_____
	Restrictions on paper other than SHARP standard paper	60 to 105 g/m ² or 16 to 28 lbs.	
Recycled, coloured, pre-punched, pre-printed and letterhead papers must conform to the same conditions as above.			

2

■ More information on special media that can be used

Incorrect feeding may result in poor toner fusing (the toner does not adhere to the paper well and can be rubbed off), skewed feeding, misfeeds, or other failures.

	Type	Remarks
Special paper	Heavy paper	<ul style="list-style-type: none"> For A5 to A4 or 5-1/2" x 8-1/2" to 8-1/2" x 11" sizes, heavy paper ranging from 106 to 128 g/m² or 16 to 34 lbs. can be used. Other heavy papers 176 g/m² (65 lbs.) can be used. 200 to 205 g/m² (110 lbs.) can be used but only for A4, 8-1/2" x 11" paper in the portrait orientation. For A5 or 5-1/2" x 8-1/2" paper, the orientation must be landscape.
	Transparency film, Tabbed paper	<ul style="list-style-type: none"> Use SHARP recommended paper. Use only tabbed sheets that are made of paper. (Tabbed sheets made of film or other material cannot be used.)
	Postcards	<ul style="list-style-type: none"> Japanese official postcards can be used.

■ Paper that can be used for automatic two-sided printing

Paper used for automatic two-sided printing (paper that can be fed through the duplex module) must meet the following conditions:

Paper type : Plain paper as specified on page above.

Paper size : Must be one of the following standard sizes: A3, B4, A4, A4R, B5, B5R or A5R (11" x 17", 8-1/2" x 14", 8-1/2" x 13", 8-1/2" x 11", 8-1/2" x 11"R, 7-1/4" x 10-1/2" or 5-1/2" x 8-1/2"R)

Paper weight : 64 to 128 g/m² (16 to 34 lbs.) (special heavy papers indicated in the table above)

NOTES

- Special papers (explained above) cannot be used for automatic two-sided printing. However, certain special heavy papers (index paper, cover paper) can be used.
- Various types of plain paper and special paper are sold. Some of these cannot be used in the machine. Please consult your retailer or your dealer when buying paper.
- The image quality and toner fusibility of special papers may change due to ambient conditions, operating conditions, and paper characteristics, resulting in image quality inferior to that of SHARP standard paper.

Setting the paper type and paper size

Follow these steps to change the paper type setting when the paper type has been changed in a paper tray. For the paper types that can be used in each tray, see page 2-12.

1 Press the [SYSTEM SETTINGS] key.

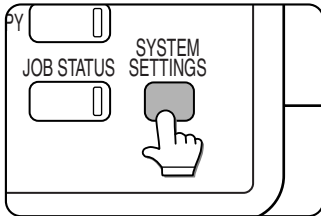

The system setting menu screen will appear.

2 Touch the [PAPER TRAY SETTINGS] key.

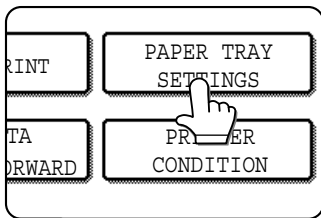

The paper tray selection screen will appear.

3 Touch the [TRAY SETTINGS] key.

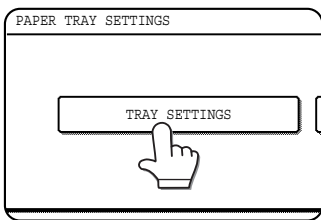

4 Display the setting screen of the desired paper tray.

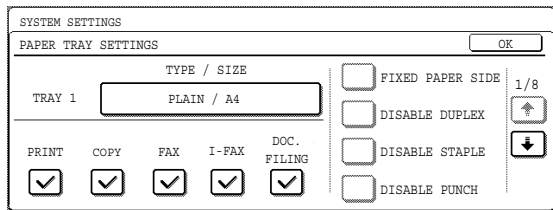

Touch the key or key to display the setting screen of the desired paper tray.

NOTE

To automatically switch to a tray with the same size and type of paper (if there is one) in the event that the paper tray runs out of paper, display the last screen with the key and select [AUTO TRAY SWITCHING].

5 Touch the [TYPE / SIZE] key.

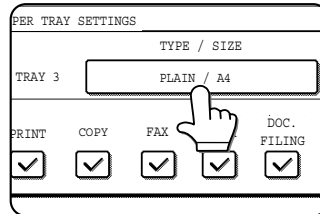

6 Select the type of paper that was loaded in the tray.

Example: The paper type of tray 3 is selected

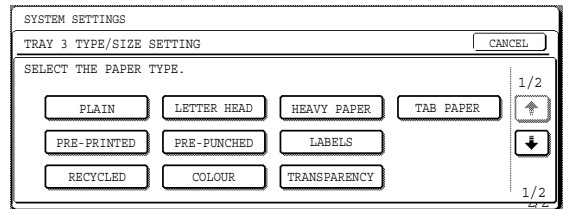

Touch the desired paper type to select it. The paper size setting screen will appear.

NOTES

- Tabbed paper can only be used in tray 3, bypass tray and the inserter.
- Heavy paper, label sheets, and transparency film cannot be loaded in trays 1, 2, 4, and 5.

7 Select the size of paper that was loaded in the tray.

Touch the appropriate keys (checkboxes).

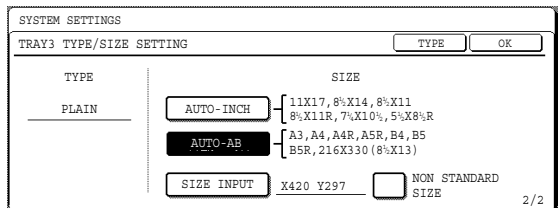

[AUTO-INCH] key : Select when you have loaded an inch-based size of paper.

[AUTO-AB] key : Select when you have loaded an AB size of paper.

[SIZE INPUT] key : Select to directly enter a paper size (see page 2-17).

[NON STANDARD SIZE] checkbox :

Select when you have loaded a non-standard size of paper (see page 2-17).

NOTE

Sizes that can be selected vary depending on the selected paper type.

8 Touch the [OK] key in the size setting screen.

You will return to the tray setting screen of step 4.

9 Select output functions that can be used with the selected tray.

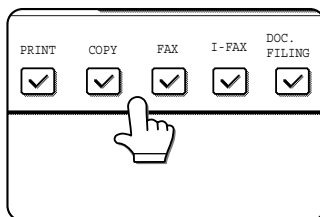

Touch the checkboxes under the desired items to select them.

NOTE

When the inserter (option) is selected, printing of faxes and Internet faxes is not possible.

■ User type

Select a "User type" when the name of the paper type does not appear in the selections or when you wish to select the tray attributes yourself.

Touch the  key in step 5 on the previous page to display the user type selection screen and then select a user type.

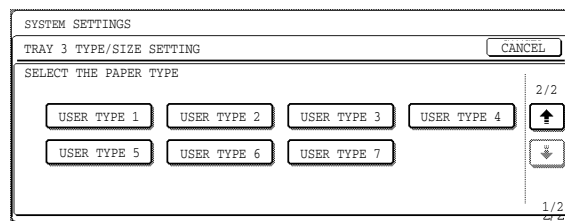

10 Configure paper settings for each tray and then touch the [OK] key to exit.

NOTE

The size and type of paper loaded in the bypass tray can also be set from the paper setting screen. Touch the [PAPER SELECT] key in the main screen to display the paper selection screen, and then touch the [PAPER SELECT] key of the bypass tray and go to step 5.

■ Programming and editing paper types

To program or edit the name of a paper type or set paper attributes, follow the steps below.

1 Touch the [PAPER TYPE REGISTRATION] key.

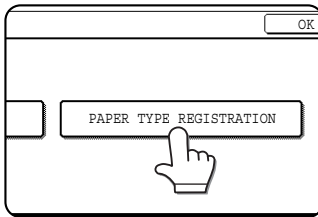

2 Select the paper type that you wish to program or edit.

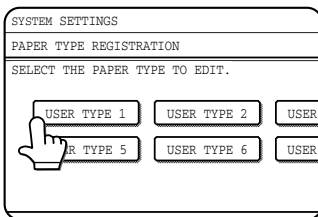

3 Touch the [TYPE NAME] key.

A character entry screen appears. Enter up to 14 characters. Refer to page 7-29 for the procedure for entering characters.

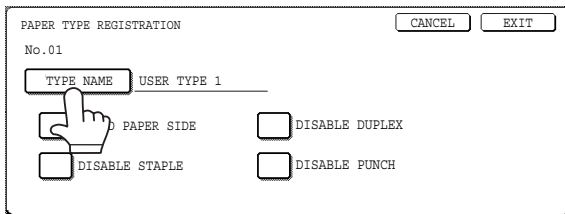

4 Set the paper attributes.

Touch the checkboxes to the left of the items to select them.

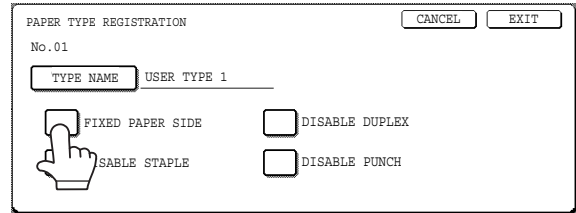

FIXED PAPER SIDE:

Select this checkbox when paper is to be loaded print side down in the tray. Make sure a checkmark does not appear when paper is to be loaded print side up.

- If the two-sided function is disabled using "DISABLING OF DUPLEX" in the administrator settings (page 11 of the administrator settings guide), load the paper face up.

DISABLE DUPLEX:

Prohibits two-sided printing. Enable when the backside of the paper cannot be printed on.

DISABLE STAPLE:

Prohibits stapling. Enable when using special papers such as transparency film and label sheets.

DISABLE PUNCH:

Prohibits punching. Enable when using special papers such as transparency film and label sheets.

NOTES

- Tray attributes depend on the selected paper.
- "FIXED PAPER SIDE" and "DISABLE DUPLEX" cannot be simultaneously enabled.

5 Touch the [EXIT] key to exit the programming/editing procedure.

Setting the paper size when a special size is loaded

NOTE

Special sizes of paper cannot be loaded in trays 1, 2, 4 and 5.

Trays 3 and the bypass tray

- 1 Perform steps 1 through 5 of "Setting the paper type and paper size" (see page 2-14).
- 2 Touch the [SIZE INPUT] key and then touch the [AB] tab.

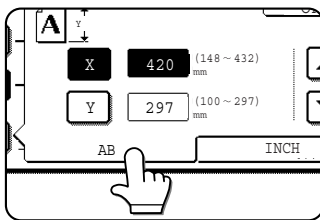

The size entry palette appears.

- 3 Touch the key or the key to enter the X (width) and Y (length) dimensions of the paper.

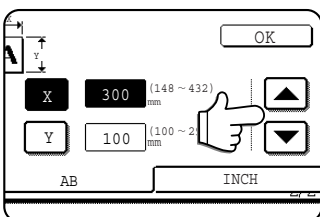

X (width) is initially selected. To enter Y (length), touch the [Y] key and then enter the length.

- 4 Touch the [OK] key.

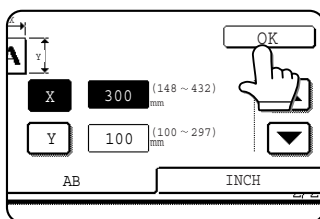

You will return to the size setting screen of step 2.

- 5 If the paper is a non-standard size, select the [NON STANDARD SIZE] checkbox.

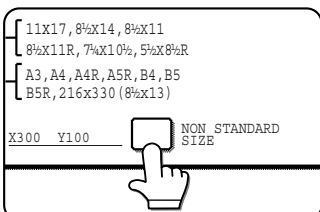

- 6 Perform steps 8 through 10 of "Setting the paper type and paper size" (pages 2-15).

Inserters (option)

- 1 Perform steps 1 through 5 of "Setting the paper type and paper size" (see page 2-14).
- 2 Touch the [SIZE SELECT] key.

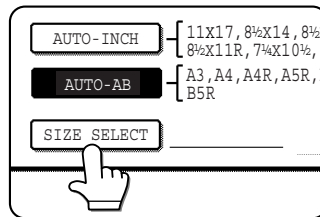

The size selection screen appears.

- 3 Select the desired paper size.

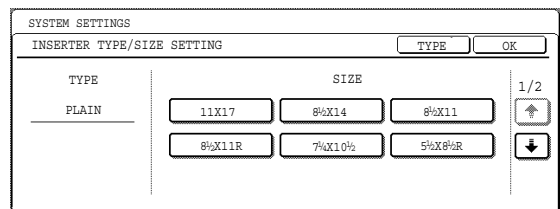

There are separate screens for inch-based paper selection and AB paper selection. Touch the key or the key to switch between the screens.

- 4 Touch the [OK] key.

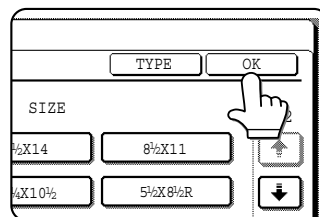

You will return to the size setting screen of step 2.

- 5 Perform steps 8 through 10 of "Setting the paper type and paper size" (pages 2-15).

SYSTEM SETTINGS

The system settings can be used as needed to meet the needs of your workplace. The items that can be set with the system settings are shown below.

- Total count The number of pages processed by the machine and optional equipment can be displayed. (See page 2-20)
- Default settings Used to configure the screen contrast, date and time, and keyboard selection*¹ settings. (See page 2-20)
- List print Used to print lists of settings and fonts. (See page 2-20)
- Paper tray settings The paper type, paper size and automatic tray switching can be set for each tray. Automatic tray switching allows feeding to switch between trays loaded with the same type and size of paper. If one tray runs out of paper during printing, printing will continue from the other tray. (See page 2-20)

For the detailed descriptions and use of the settings listed below, see the fax, image send, and printer manuals.

- Address control*¹ Used to store information for various functions.
- Sender control*² Used to store the sender's information that appears on your Scan to E-mail transmissions at the destination.
- Fax data receive/forward*¹ Faxes received to memory and received Internet faxes can be forwarded to another destination.
- Printer condition Used to configure default settings for the printer function (see the Operation manual (for printer)).

- Document filing control*² Used to configure default settings for the document filing function. (pages 7-25 to 7-28)
- Administrator settings These are items that are used by the administrator of the machine to configure machine settings. A key appears for these settings in the system settings menu screen. For information on these settings, see the administrator settings guide.

*¹ These settings can be configured in a system where the facsimile, network scanner and Internet fax function is available.

*² These settings can be configured in a system where the network scanner function is available.

General procedure for system settings

1 Press the [SYSTEM SETTINGS] key.

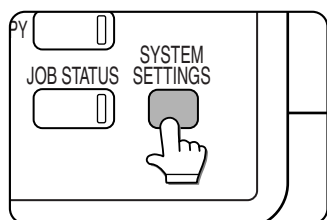

The system setting menu screen will appear.

Touch the [CLOCK] key and then the following screen appears.

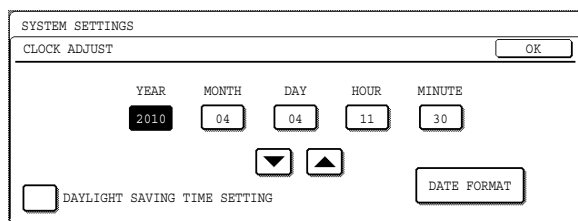

2 Touch the key of the desired item to display its setting screen.

The example of selecting the [DEFAULT SETTINGS] key and then the [CLOCK] key is explained below.

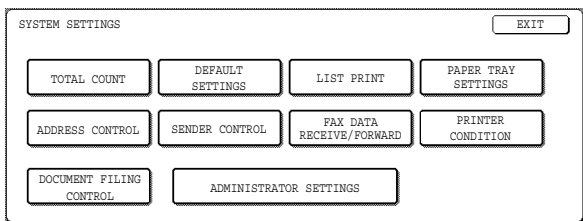

The system settings are described in detail on the following pages.

4 Touch the year, month, day, hour or minute key, and then use the ▲ or ▼ key to adjust the setting.

- If you select a non-existent date (for example, Feb. 30), the [OK] key will grey out to prevent entry of the date.
- Select [DAYLIGHT SAVING TIME SETTING] checkbox to have the time automatically change at the beginning and end of daylight saving time.

3 Touch the [CLOCK] key.

5 Touch the [DATE FORMAT] key.

The following screen appears.

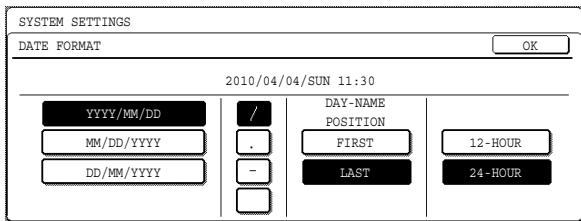

6 If you wish to change the format of the date and time, touch the desired format keys.

Touched keys are highlighted.
The selected format is applied to lists printed out in "LIST PRINT".

7 Touch the [OK] key.

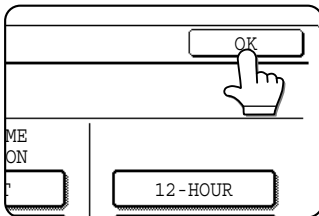

You will return to the date and time setting screen.

8 Touch the [OK] key.

9 To exit the settings, touch the [EXIT] key.

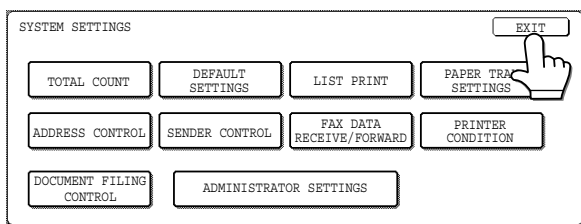

More information on setting procedures

In the following type of screen, a setting is selected by touching the key so that a checkmark (☑) appears. The settings below are configured to allow use of tray 1 in print, copy, and fax modes. To display the next screen, touch the or keys.

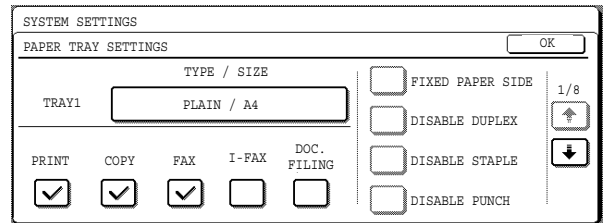

About the settings

■ Total count

This displays the following sheet counts (the counts that can be displayed vary depending on the options installed):

- ① Number of pages output by the machine.
- ② Number of original pages transmitted by the machine.
- ③ Number of times the automatic document feeder was used to feed original pages and number of times the stapler was used (if installed).
- ④ Number of pages stored by document filing.

In the case of ① only,

- A3 (11" x 17") size paper is counted as two sheets.
- Each sheet of paper used for automatic two-sided copying is counted as two sheets (A3 (11" x 17") paper is counted as four sheets).
- Paper with an entered size of 384 mm (15-1/8") or larger is counted as two sheets (four sheets during automatic two-sided copying).

■ Default settings

The following settings can be configured:

- Display contrast
Screen contrast adjustment is used to make the LCD touch panel easier to view under various lighting conditions. Touch the [LIGHTER] key to make the screen lighter, or the [DARKER] key to make the screen darker.
- Clock
Use this to set the date and time in the machine's built-in clock. This clock is used by functions that require date and time information.
- Keyboard select
The layout of the keyboard that appears in letter entry screens can be changed.
Select the arrangement of the letter keys that you find easiest to use.

The following three alphabet keyboard configurations are available:

- Keyboard 1 (QWERTY... configuration)*
- Keyboard 2 (AZERTY... configuration)
- Keyboard 3 (ABCDEF... configuration)

* The default setting is "Keyboard 1".

(Example: Character entry screen when Keyboard 3 is selected)

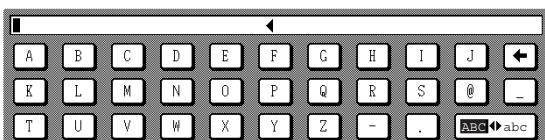

■ List print

This is used to print lists of machine settings and a test page to check resident fonts.

The following lists and pages are available:

- All custom setting list
Shows the hardware status, software status, printer configuration settings, tray settings, and counts.
- Printer test page
Shows the PCL symbol set list, fonts, network interface (NIC interface) settings, and settings used for the NIC card.
- Sending address list
One touch destination list, group list, program list, and memory box list.
- Document filing user / folder list
Shows the user names and folder names for document filing.
- Sender control list
Shows the senders that have been stored.

NOTE

A test page cannot be printed if "PROHIBIT TEST PAGE PRINTING" (See the "Operation manual (for printer)".) has been set to "prohibited" in the administrator settings.

■ Paper tray settings

The paper type, paper size, enabled modes and automatic tray switching can be set for each tray. See page 2-14 for details on setting the paper type and paper size. Automatic switching to another paper tray is used to automatically switch to another tray with the same size and type of paper in the event that the paper runs out during continuous printing. This requires that the trays be loaded with the same size of paper. The paper tray settings can be enabled or disabled for each tray, and for printer mode, copy mode, fax mode, Internet fax mode, and document filing mode. To enable any function, touch the check box key so that a checkmark (☑) appears.

REPLACING THE TONER CARTRIDGES

When toner runs low, a message will appear to inform you that the toner cartridge must be replaced.

NOTE

To view the approximate amount of toner remaining, hold down the [COPY] key during printing or when the machine is on standby. The percentage of toner remaining will appear in the display while you hold down the key. When the percentage falls to "20-0%", obtain a new toner cartridge and keep it ready for replacement.

Follow the steps below to replace the toner cartridge.

1 Open the front cover.

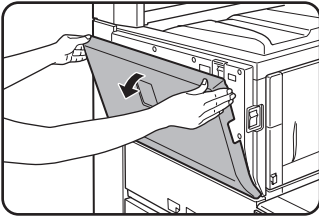

2 Remove the toner cartridge gently.

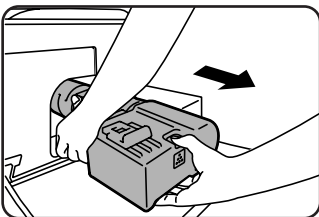
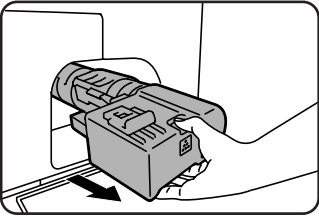

Hold the toner cartridge with both hands as shown in the illustration, and pull it out of the machine.

3 Remove the new toner cartridge from the box and shake it five or six times horizontally.

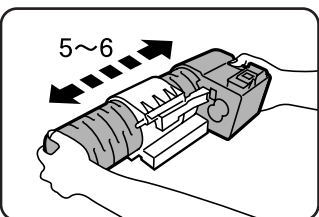

NOTE

Shake the toner cartridge well to ensure that the toner flows well and will not stick to the inside of the cartridge.

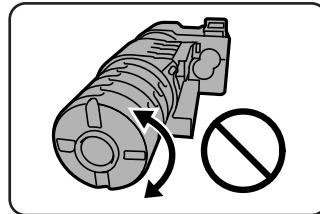

Shake the toner cartridge horizontally. Do not rotate it as shown at left.

4 Insert the new toner cartridge.

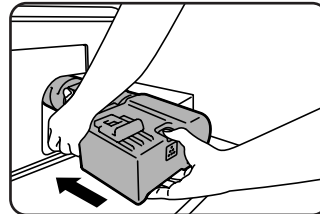

Align the toner cartridge with the insert hole and push it in as shown. Do not rotate the cartridge.

5 Push the cartridge in until it locks securely in place.

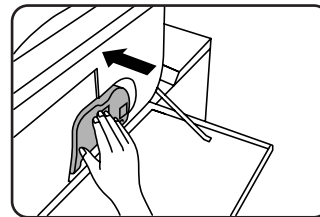

6 Close the front cover.

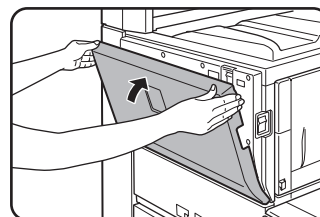

CAUTION

- Do not throw the toner cartridge into a fire. Toner may fly and cause burns.
- Store toner cartridges out of the reach of small children.

NOTE

Place the used toner cartridge in the plastic bag and store it. When placing the toner cartridge in the bag, insert it horizontally, not vertically. If the cartridge is stood on end, the collected used toner may spill out and soil the floor or your clothes.

STORAGE OF SUPPLIES

Standard supplies for this product that can be replaced by the user include paper, toner cartridges, and staple cartridges for the finisher.

SHARP

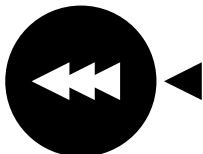

For best copying results, be sure to use only Sharp Genuine Supplies which are designed, engineered, and tested to maximize the life and performance of Sharp products. Look for the Genuine Supplies label on the toner package.

GENUINE SUPPLIES

■ Proper storage

1. Store the supplies in a location that is:
 - clean and dry,
 - at a stable temperature,
 - not exposed to direct sunlight.
2. Store paper in the wrapper and lying flat.
3. Paper stored in packages standing up or out of the wrapper may curl or become damp, resulting in paper misfeeds.
4. Store a new toner cartridge box horizontally. Do not store it standing on end. If stored standing on end, the toner may not distribute well even after shaking the cartridge vigorously, and will remain inside the cartridge without flowing out.

Supply and Consumables

The supply of spare parts for a repair of the appliance is guaranteed for at least 7 years following the termination of production. Spare parts are those parts of the apparatus which may break down within the scope of the ordinary use of the product - whereas those parts which normally exceed the life of the product are not to be considered as spare parts. Consumables too, are available for 7 years following the termination of production.

MISFEED REMOVAL

When a misfeed has occurred during printing, the message "A MISFEED HAS OCCURRED". will appear in the touch panel display of the operation panel and printing including copying and facsimile output will stop. The approximate misfeed locations are indicated with "▼" shown in the illustration below. The page numbers for detailed information on misfeed removal are also shown.

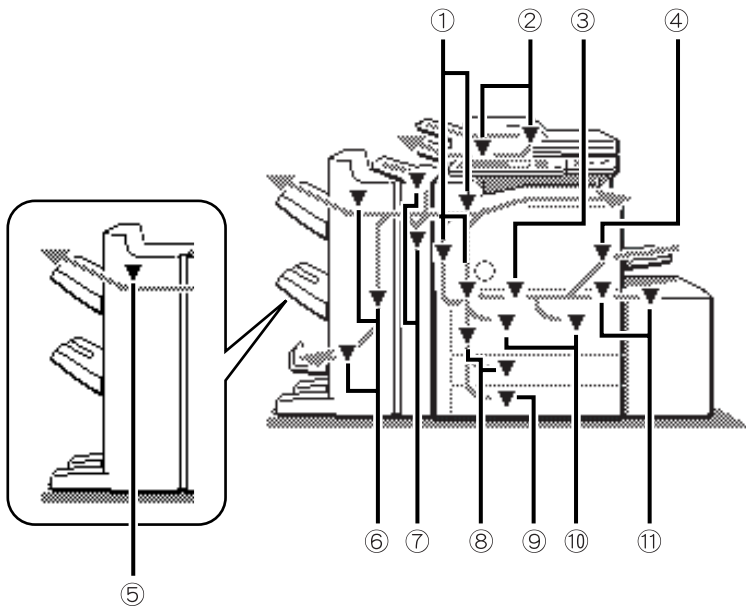

- ① Misfeed in the transport area, fusing area, and exit area (See page 2-24)
- ② Misfeed in the automatic document feeder (See page 2-31)
- ③ When feeding paper from tray 2, the bypass tray, or tray 5, this mark may blink. When the mark blinks, check the following diagrams:
 - Fourth diagram in step 3 on page 2-26
 - Diagram in step 6 on page 2-27
 - Diagram in step 8 on page 2-29, 2-30
- ④ Misfeed in the bypass tray (See page 2-28)
- ⑤ Misfeed in the finisher (See page 3-11)
- ⑥ Misfeed in the saddle stitch finisher (See page 3-11)
- ⑦ Misfeed in the inserter (See page 3-17)
- ⑧ Misfeed in the tray 3 (See page 2-27)
- ⑨ Misfeed in the tray 4 (See page 2-27)
- ⑩ Misfeed in tray 1 - tray 2 (See page 2-26)
- ⑪ Misfeed in the tray 5 (See page 2-29, 2-30)

NOTE

Printing is not possible when a misfeed occurs, and thus any faxes or Internet faxes received at this time will be temporarily held in memory. The faxes will print out automatically as soon as the misfeed is cleared.

NOTES

- Do not damage or touch the photoconductive drum. (See page 2-24.)
- Be careful not to tear the misfed paper during removal.
- If paper is accidentally torn during removal, be sure to remove all pieces.

CAUTION

The fusing unit is hot. Take care in removing paper.

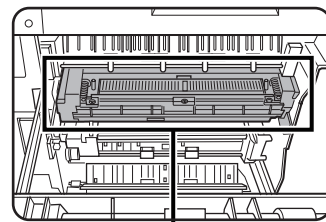

Fusing unit

Misfeed removal guidance

Misfeed removal guidance can be displayed by touching the [INFORMATION] key on the touch panel after a misfeed has occurred.

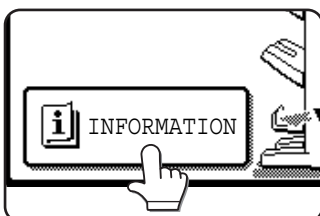

Misfeed in the transport area, fusing area, and exit area

CAUTION

The fusing unit is hot. Take care in removing paper. (Do not touch the metal parts.)

1 Remove the duplex unit.

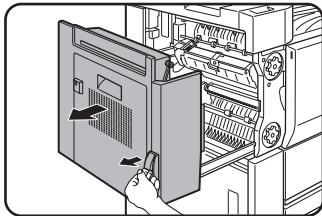

Grasp the finger hold and gently open the unit.

2 Remove the misfed paper as shown in the illustrations below.

Misfed in the transport area

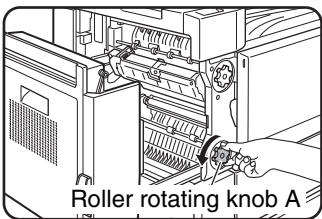

Turn roller rotating knob A in the direction of the arrow to remove the misfed paper.

Misfed in the fusing area

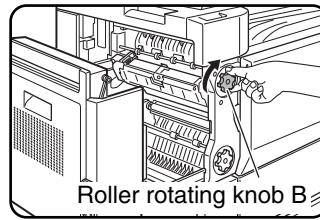

Turn roller rotating knob B in the direction of the arrow to remove the misfed paper.

CAUTION

The fusing unit is hot. Take care in removing paper. (Do not touch any metal parts.)

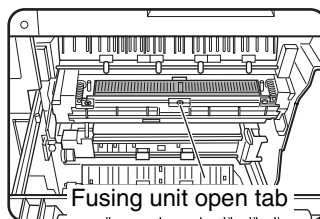

If the misfed paper is inside the fusing area, turn down the fusing unit open tab to open the fusing unit and remove the misfed paper.

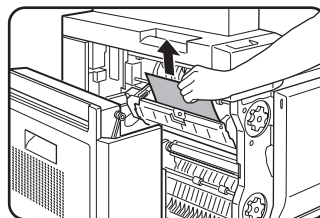

NOTES

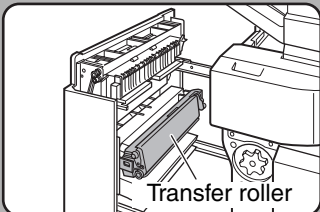

Do not touch or damage the transfer roller.

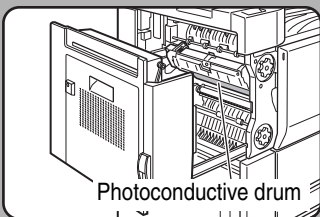

Do not touch or damage the photoconductive drum.

After clearing the misfeed, promptly close the duplex unit. Leaving the unit open may adversely affect the photo-sensitive drum and cause poor copy quality.

Misfed in the exit area

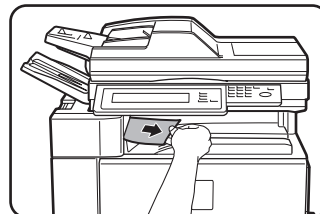

Be careful not to tear the misfed paper during removal.

3 Gently close the duplex unit.

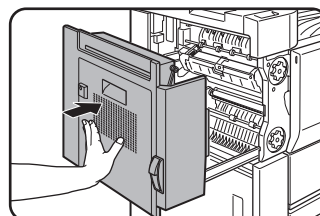

After closing, confirm that the misfeed message has been cleared and the normal display appears.

Misfeed in the duplex unit

1 Remove the duplex unit.

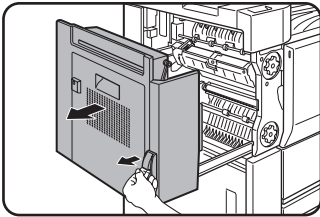

Grasp the finger hold and gently open the unit.

2 Open the cover of the duplex unit.

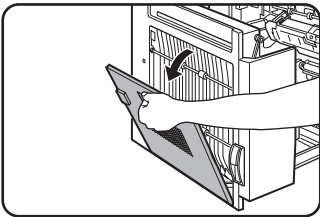

3 Remove the misfed paper.

Misfeed in upper part of unit

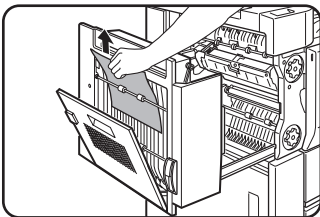

Be careful not to tear the misfed paper during removal.

Misfeed in lower part of unit

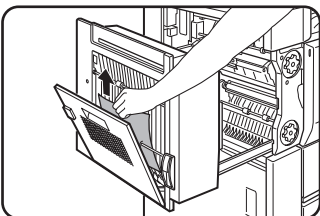

Be careful not to tear the misfed paper during removal.

4 Close the cover of the duplex unit.

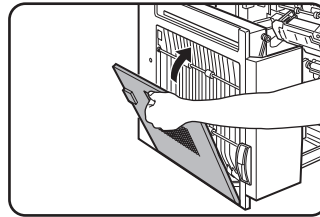

5 Gently close the duplex unit.

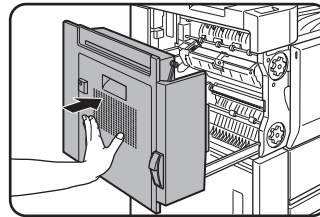

After closing the duplex unit, confirm that the misfeed message has been cleared and the normal display appears.

2

Misfeed in the paper feed area

NOTE

Be sure to follow the misfeed removal sequence. Do not pull the tray out immediately as the misfeed may have occurred with paper partially fed out of the tray. Open the left cover and see if there is misfed paper first (steps 1 and 2). If you open the tray without checking, the partially fed paper may tear and leave torn pieces in the machine, increasing the difficulty of removal.

■ Misfeed in paper tray 1 - tray 2

1 Remove the duplex unit.

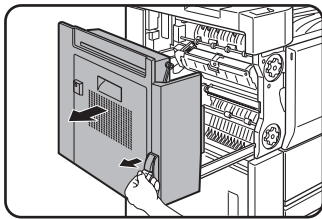

Grasp the finger hold and gently open the unit.

2 Remove the misfed paper.

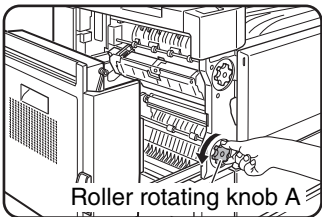

Turn roller rotating knob A in the direction of the arrow to remove the misfed paper.

Roller rotating knob A

NOTE

A misfeed may occur inside the compartment, so please check the entire compartment carefully.

3 If misfed paper is not found in step 2, pull out paper tray 1 - tray 2 and remove the misfed paper.

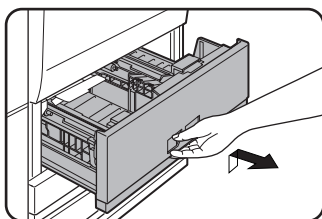

Grasp the finger hold and gently open the unit. Pull the tray all the way out until it stops.

●If paper is misfed in tray 1 (left-side tray)...

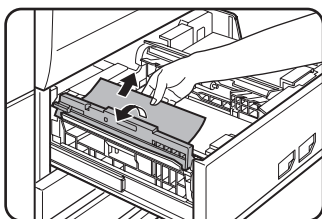

Lift the paper guide and remove the misfed paper.

Be sure to replace the paper guide in its original position after removing the paper.

●If paper is misfed in tray 2 (right-side tray)...

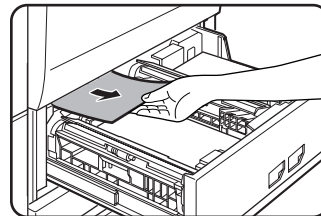
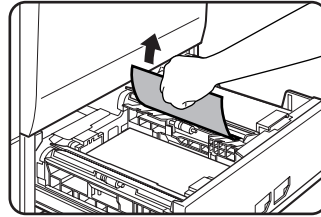

When using tray 2, check the paper transfer unit inside the tray and remove any misfed paper.

4 Gently close paper tray 1 - tray 2.

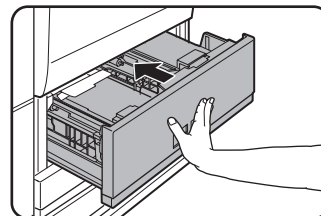

Push the tray all the way back in.

5 Gently close the duplex unit.

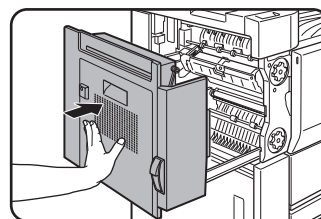

After closing, confirm that the misfeed message has been cleared and the normal display appears.

■ Misfeed in paper tray 3

1 Remove the duplex unit.

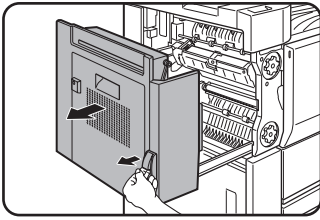

Grasp the finger hold and gently open the unit.

2 Remove the misfed paper.

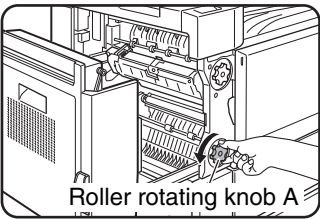

Turn roller rotating knob A in the direction of the arrow to remove the misfed paper.

Roller rotating knob A

3 Open the lower cover on the left side of the machine.

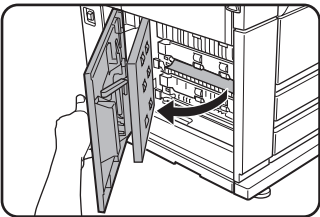

Grasp the finger hold and gently open the unit.

4 Remove the misfed paper.



Be careful not to tear the misfed paper during removal.

5 Close the lower cover on the left side of the machine.

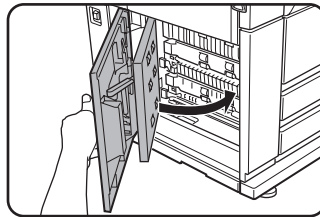

6 If misfed paper is not found in step 3, pull out paper tray 3 and remove the misfed paper.

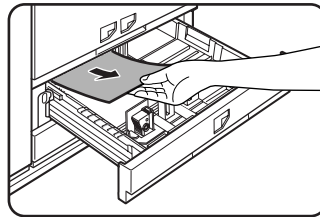

Pull the tray all the way out until it stops. Check the paper transfer unit inside the tray. Be careful not to tear the misfed paper during removal.

7 Gently close paper tray 3.

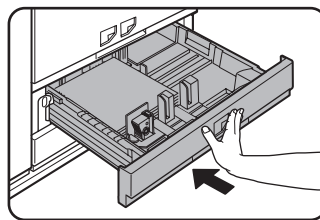

Push the tray all the way back in.

8 Gently close the duplex unit.

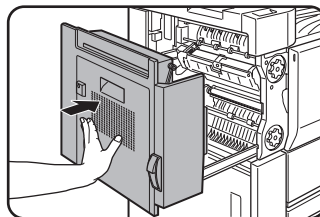

After closing, confirm that the misfeed message has been cleared and the normal display appears.

NOTE

A misfeed may occur inside the compartment, so please check the entire compartment carefully.

■ Misfeed in the tray 4

To remove a misfeed in tray 4, follow the same steps as in "Misfeed in paper tray 3".

■ Misfeed in the bypass tray

1 Remove the misfed paper from the bypass tray.

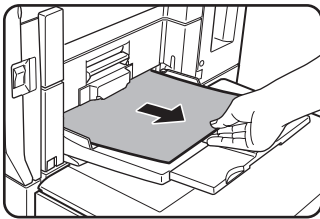

Be careful not to tear the misfed paper during removal.

2 If you did not find a misfeed in step 1, open the side cover and remove the misfeed.

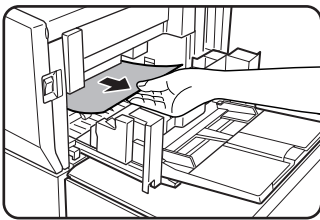

3 Gently close the side cover.

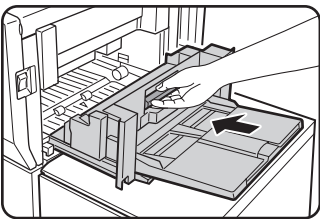

4 Remove tray 1 - tray 2.

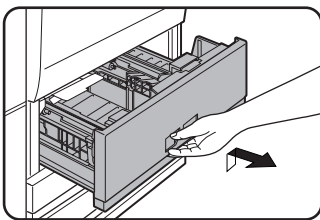

Grasp the finger hold and gently open the unit. Pull the tray all the way out until it stops.

5 Remove the misfed paper.

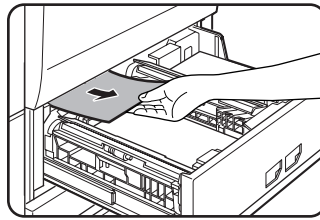

Check the paper transfer unit inside the tray and remove any misfed paper.

6 Gently close paper tray 1 - tray 2.

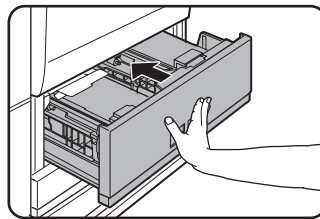

Push the tray all the way back in. Make sure that the misfeed message no longer appears (the normal message display should appear).

NOTE

If a misfeed occurs during printing from the bypass tray while paper is being loaded in tray 1 - tray 2, push tray 1 - tray 2 back in to close it, and then pull the tray out again.

■ Misfeed in the tray 5 (AR-LC6)

1 Open the side cover.

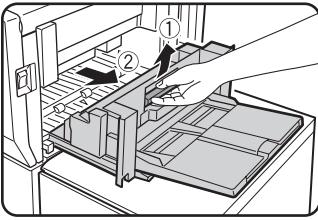

2 Remove the misfed paper.

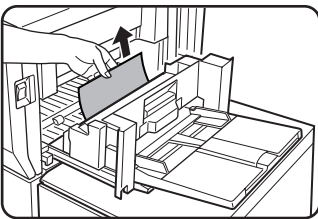

Be careful not to tear the misfed paper during removal.

3 Gently close the side cover.

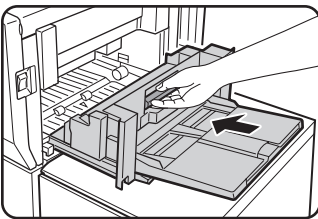

4 Close the bypass tray.

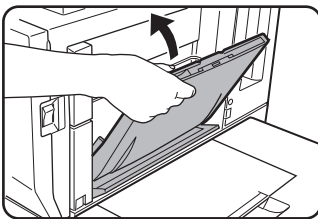

5 Open the top cover of tray 5.

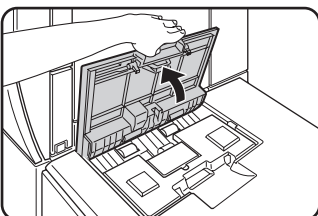

6 Open the top cover and remove the misfed paper.

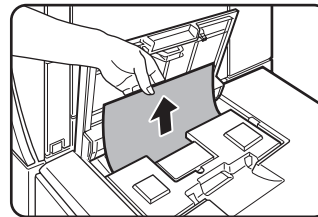

After removing the misfed paper, close the top cover.

7 Remove tray 1 - tray 2.

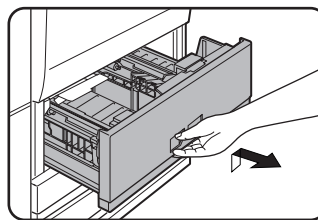

Grasp the finger hold and gently open the unit. Pull the tray all the way out until it stops.

NOTE

If a misfeed occurs in the following situation, push tray 1 - tray 2 back in to close it and then pull the tray out again:

- A misfeed occurs during printing from tray 5 while paper is being loaded in tray 1 or tray 2.

8 Remove the misfed paper.

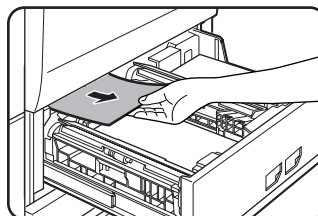

Check the paper transfer unit inside the tray and remove any misfed paper.

9 Gently close paper tray 1 - tray 2.

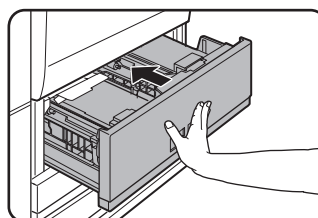

Push the tray all the way back in. Make sure that the misfeed message no longer appears (the normal message display should appear).

■ Misfeed in the tray 5 (AR-LC7)

If a paper misfeed occurs, follow the steps below to remove the misfeed.

1 Open the side cover.

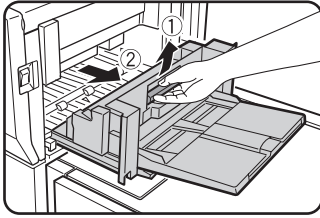

2 Remove the misfed paper.

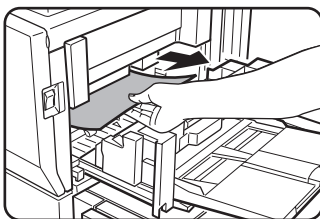

Be careful not to tear the misfed paper during removal.

3 Gently close the side cover.

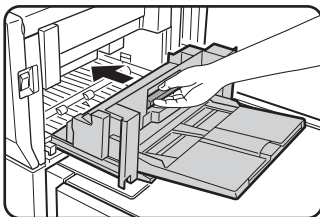

4 Close the bypass tray.

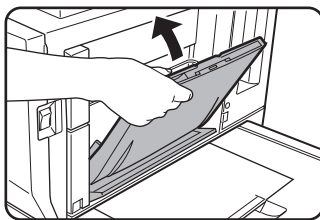

5 Open the top cover of the AR-LC7 (tray 5).

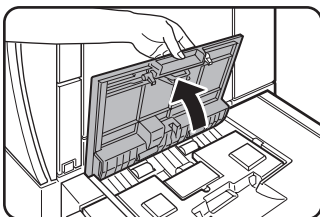

Hold the top cover open.

6 Remove the misfed paper.

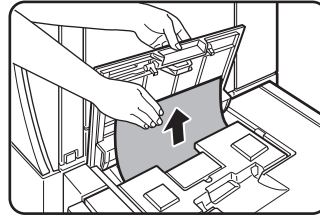

Be careful not to tear the misfed paper during removal.

After removing the misfed paper, close the top cover.

7 Pull out tray 1 - tray 2.

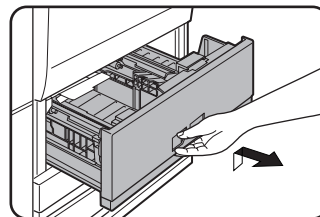

Grasp the finger hold and gently open the tray.

Pull the tray all the way out until it stops.

NOTE

If a misfeed occurs in the following situation, push tray 1 - tray 2 back in and then pull the tray out again:

- A misfeed occurs during printing from tray 5 (AR-LC7) while paper is being loaded in tray 1 - tray 2.

8 Remove the misfed paper.

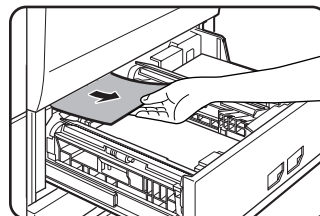

Check the paper transfer unit inside the tray. If there is a misfeed in the paper transfer unit, remove the misfeed.

9 Gently push tray 1-tray 2 into the machine.

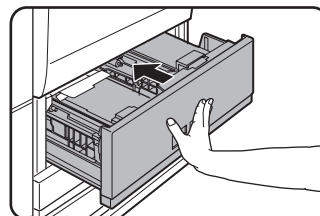

Push the tray firmly all the way into the machine.

Make sure that the misfeed message no longer appears (the normal message display should appear).

REMOVING AN ORIGINAL MISFEED

Removing a misfed original from the automatic document feeder

If an original misfeed occurs in the automatic document feeder, follow the steps below to remove the misfed original.

NOTES

- For misfeed removal in the main unit and other peripheral devices, see page 2-23
- When a misfeed occurs, touch the [INFORMATION] key to display detailed information for misfeed removal.

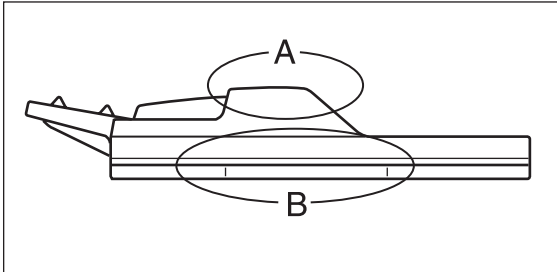

Check locations A and B in the diagram at left to remove the original.

2

1 Removing misfeeds from each location.

● Check location A

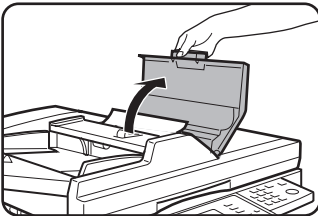

Open the document feeder cover and gently remove the misfed original without tearing it. Close the document feeder cover.

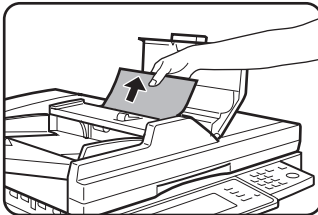

● Check location B

● Misfeed in the transfer unit

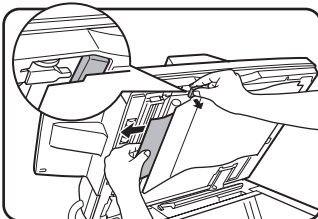

Open the document transfer cover, hold the paper guide open, and remove the misfed original.

● Misfeed in the document exit unit

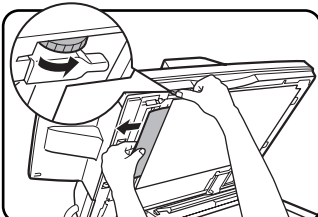

Open the document transfer cover. Rotate the transfer roller in the direction of the arrow and gently remove the original without tearing it.

2 Open and close the document feeder cover.

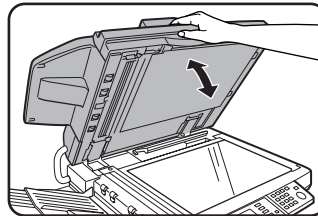

Opening and closing the cover clears the misfeed display. Copying cannot be resumed until this step is performed.

However, this step is not necessary after a misfeed is removed from location B.

A message may appear indicating the number of originals which must be returned to the document feeder tray. Return the originals to the document feeder tray and press the [START] key.

TROUBLESHOOTING

Check the following troubleshooting list before requesting service as many problems can be fixed by the user. If you are unable to solve the problem by checking the list, turn off the main power switch and the power switch, unplug the power cord.

Problems related to general use of the machine are described below. For problems related to the copy function, see page 6-3. For problems related to document filing, see page 7-31. For fax, printer, and network scanner/Internet fax problems, see the manuals for those functions. For peripheral device problems, see the explanation of the device.

If the message "CALL FOR SERVICE. CODE:**-***"^(Note) appears in the touch panel, turn off the main power switch and the power switch, wait about 10 seconds, and then turn the main power switch and the power switch back on. If the message still appears after turning the main power switch and the power switch off and on several times, it is likely that a failure has occurred that requires service. In this event, stop using the machine, unplug the power cord, and contact your Sharp dealer.

Note: Letters and numbers appear in "***-***". When you contact your Sharp dealer, please tell your dealer what letters and numbers appear.

Problem	Check	Solution or cause
The machine does not operate.	Machine plugged in?	Plug the machine into a grounded outlet.
	The main power switch and power switch are not turned on?	Turn on the main power switch and the power switch. (Page 1-17)
	READY indicator off?	The printer is warming up. (Warm-up time is approximately 120 seconds.) Wait until the READY indicator lights up.
	Message indicating need to load paper displayed?	Load paper. (Page 2-2)
	Message indicating need to replace the toner cartridge displayed?	Replace the toner cartridge. (Page 2-21)
	Message indicating a paper misfeed displayed?	Remove misfed paper. (Page 2-23)
Copying/printing is not possible.	A message appears saying that this type of paper cannot be used for two-sided copying.	Two-sided printing is not possible on special paper. Use paper that can be used for automatic two-sided printing. (Page 2-13)
Incorrect bypass tray paper size.	Incorrect display of paper sizes, A3, B4, A4R, 11" x 17", 8-1/2" x 14", 8-1/2" x 13" or 8-1/2" x 11"R only.	When loading sizes A3, B4, A4R, 11" x 17", 8-1/2" x 14", 8-1/2" x 13" or 8-1/2" x 11"R, be sure to open the tray extension.
Copying/printing on paper from the bypass tray is skewed.	The number of sheets placed on the bypass tray exceeds the maximum number.	Do not place more than the maximum number of sheets.
	The bypass guide is not adjusted to the size of the loaded paper.	Adjust the bypass guide to the size of the loaded paper.

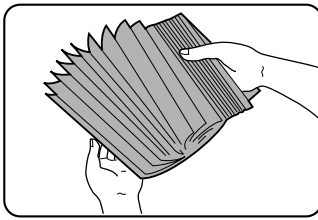
Problem	Check	Solution or cause
Paper from the bypass tray misfeeds.	The paper size and paper type have not been set.	Be sure to set the paper size and paper type when using special size or special type papers. (Page 2-14)
	The number of sheets placed on the bypass tray exceeds the maximum number.	Do not place more than the maximum number of sheets.
	The bypass guide is not adjusted to the size of the loaded paper.	Adjust the bypass guide to the size of the loaded paper.
Printing stops before the job is finished.	If too many pages collect on the output tray, the tray full sensor activates and stops printing.	Remove the paper from the output tray.
	The paper tray is out of paper.	Load paper. (Page 2-2)
Smudges on printed sheets	Does a message appear indicating the need for maintenance?	Please contact the your dealer as soon as possible.
The displayed paper size or paper type does not match the loaded paper size or paper type.	The correct paper size or paper type is not set in the paper tray settings of the system settings.	When loading paper, if you change the paper size from an AB size to an inch size, or from an inch size to an AB size, or change the paper type, be sure to set the new paper type as explained in "Setting the paper type and paper size" (see page 2-14).
When printing on a special size of paper, part of the printed image is missing.	The paper size setting is not set correctly in the paper tray settings of the system settings.	When using a special size of paper, set the correct paper size as explained in "Setting the paper type and paper size" on page 2-14. If the paper size setting is not correct, part of the image may be cut off or the image may not be printed.
When printing on a special size of paper using the bypass tray, part of the printed image is missing.	The paper size is not set correctly in the special size settings for the bypass tray.	When using a special size of paper, set the correct paper size as explained in "Setting the paper type and paper size" on page 2-14. If the paper size setting is not correct, part of the image may be cut off or the image may not be printed.
Paper misfeeds frequently.	Is paper other than SHARP-recommended paper being used?	Use SHARP-recommended paper. (Page 2-22)
	Paper curled or damp?	Do not use curled or crimped paper. If you will not use the paper for a long time, remove the paper from the tray and store it in the wrapper in a cool and dark location so that it will not absorb moisture.
	Is the paper curled and does it frequently misfeed in the finisher or saddle stitch finisher?	Paper may be curled when output depending on the paper type and quality. In some cases turning the paper over in the tray will reduce misfeeding due to curling.
	Multiple sheets of paper fed simultaneously?	 <p>Remove the paper from the paper tray or the bypass tray, fan the paper as shown in the illustration, and then load it again.</p>
	The paper in the tray is not stacked evenly.	Make sure that the paper in the paper tray is stacked evenly. If the stack is not even, paper misfeeds will occur.

Problem	Check	Solution or cause
Printed paper is wrinkled or the image rubs off easily.	Is paper other than SHARP-recommended paper being used?	Use SHARP-recommended paper. (Page 2-22)
	Is the paper size or weight outside the specifications?	Use paper within the specifications.
	Paper damp?	Be sure to store paper in the wrapper in a dry location and do not store paper in a location that is <ul style="list-style-type: none"> ● humid ● at a high temperature or an extremely low temperature ● exposed to direct sunlight ● dusty.
The contrast on the touch panel is too high or too low.	Is LCD contrast properly adjusted?	Adjust the screen contrast using "DISPLAY CONTRAST" in "DEFAULT SETTINGS" of the system settings. (Page 2-20)
Printing takes place on the wrong side of the paper.	The paper is loaded in the tray with the print side face down*. <ul style="list-style-type: none"> * Face up if the paper type is "PRE-PRINTED" or "LETTER HEAD". 	Load paper in the tray with the print side face up. However, if the paper type is "PRE-PRINTED" or "LETTER HEAD", load the paper with the print side face down*. <ul style="list-style-type: none"> * If the two-sided function has been prohibited using "DISABLING OF DUPLEX" in the administrator settings (page 11 of the administrator settings guide), load the paper face up.
Marks appear at regular intervals on printed pages.	Paper with punch holes is being used.	If the original image overlaps the punch holes, marks will appear at the position of the holes on the back of the paper after one-sided printing, or on the front and back of the paper after two-sided printing. Make sure that the original image does not overlap the punch holes.

CHAPTER 3

PERIPHERAL DEVICES

This chapter explains the procedures for using the optional finisher, saddle stitch finisher, and inserter, as well as Sharp OSA (application communication module and external account module).

	Page
FINISHER AND SADDLE STITCH FINISHER.....	3-2
• Part names.....	3-2
• Specifications.....	3-2
• Finishing methods.....	3-4
• Finishing modes and finisher functions.....	3-6
• Staple cartridge replacement and staple jam removal.....	3-7
• Removing a misfeed.....	3-11
• Troubleshooting finisher/saddle stitch finisher problems.....	3-13
INSERTER.....	3-14
• Part names.....	3-14
• Specifications.....	3-14
• Loading paper.....	3-15
• Manual operation of the inserter.....	3-15
• Misfeed removal.....	3-17
• Troubleshooting inserter problems.....	3-18
SHARP OSA.....	3-19
APPLICATION COMMUNICATION MODULE (MX-AMX2).....	3-19
• Standard application setup.....	3-19
• Selecting a standard application.....	3-19
• Operation in OSA mode.....	3-20
EXTERNAL ACCOUNT MODULE (MX-AMX3).....	3-21
• External account application setup.....	3-21
• Operation in external account mode.....	3-21

FINISHER AND SADDLE STITCH FINISHER

The finisher and the saddle stitch finisher include the offset function, which offsets each set of copies from the preceding set for easy separation. Each set of sorted copies can also be stapled. The saddle stitch finisher can automatically staple a set of copies at the centre line and fold the pages to create a pamphlet.

A punch module unit can be installed to add punch holes to copies, and an inserter can be installed to insert blank pages at specified pages.

In the following explanations, the finisher and saddle stitch finisher are referred to simply as "finisher".

Part names

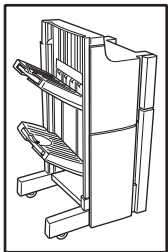

Finisher (AR-F15)

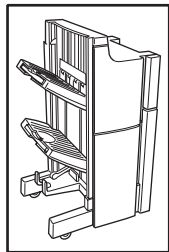

Saddle stitch finisher (AR-F16)

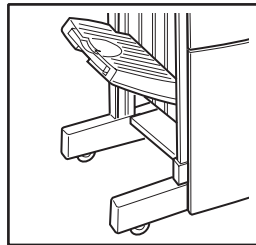

Finisher (AR-F15)

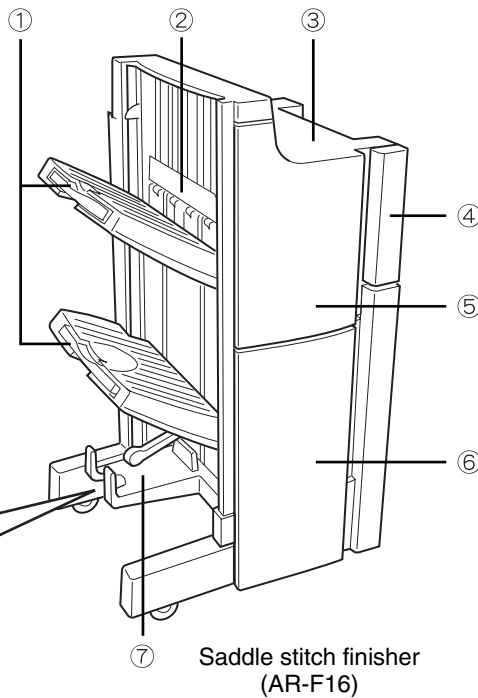

Saddle stitch finisher (AR-F16)

- ① **Tray**
Offset pages and stapled pages are delivered here.
- ② **Stapler compiler**
Paper to be stapled is stacked temporarily.
- ③ **Top cover**
Open for misfeed removal.
- ④ **Punch module (Option)**
Adds punch holes to printed pages.
- ⑤ **Front cover**
Open to replace the staple case in the staple unit or clear jammed staples.
- ⑥ **Lower cover**
Open to clear misfed paper or replace the staple cartridge in the pamphlet unit. (AR-F16 only)
- ⑦ **Saddle stitch tray**
Saddle stitched output is delivered here. (AR-F16 only)

* The illustrations on the following pages (to page 3-18) show the AR-F16; however, the operation of the AR-F15 is the same as the AR-F16.

NOTES

- Do not press on the finisher.
- Use caution when near the offset tray during printing as the tray moves up and down.

Specifications

Name	Finisher (AR-F15)	Saddle stitch finisher (AR-F16)
Number of trays	2	3
Paper output	Face down output	
Paper capacity	Upper paper tray/Middle paper tray: Non-stapling: 2000 sheets of paper or total aggregate thickness is within 250mm (9-53/64"): A4, B5, A5R, 8-1/2" x 11" or 5-1/2" x 8-1/2"R (80 g/m ² (20 lbs.)) 1000 sheets of paper or total aggregate thickness is within 140mm (5-1/2"): Sizes other than the above Stapling: 100 sets or 750 pages of A4, B5 or 8-1/2" x 11" paper. 100 sets or 500 pages of other sizes of paper	Upper paper tray/Middle paper tray: Non-stapling: 2000 sheets of paper or total aggregate thickness is within 250mm (9-53/64"): A4, B5, A5R, 8-1/2" x 11" or 5-1/2" x 8-1/2"R, (80 g/m ² (20 lbs.)) 1000 sheets of paper or total aggregate thickness is within 140mm (5-1/2"): Sizes other than the above Stapling: 100 sets or 750 pages or total aggregate thickness is within 110mm (4-5/16") of A4, B5 or 8-1/2" x 11" paper. 100 sets or 500 pages or total aggregate thickness is within 74mm (2-29/32") of other sizes of paper Lower tray: Stapled print capacity is (11 - 15) sheets x 10 sets, (6 - 10) sheets x 20 sets, (1 - 5) sheets x 25 sets.

(Continued on next page)

Paper size	Upper paper tray/Middle paper tray: A3, B4, A4, A4R, B5, B5R, A5R, 11" x 17", 8-1/2" x 14", 8-1/2" x 13", 8-1/2" x 11", 8- 1/2" x 11"R, 7-1/4" x 10-1/2"R, 5-1/2" x 8- 1/2"R	Upper paper tray/Middle paper tray: A3, B4, A4, A4R, B5, B5R, A5R, 11" x 17", 8-1/2" x 14", 8-1/2" x 13", 8-1/2" x 11", 8-1/2" x 11"R, 7-1/4" x 10-1/2"R, 5-1/2" x 8-1/2"R Lower tray: A3, B4, A4R, 11" x 17", 8-1/2" x 11"R
Paper weight	Upper paper tray/Middle paper tray: 60 to 256 g/m ² (16 to 68* lbs.)	Upper paper tray/Middle paper tray/Lower tray: 60 to 256 g/m ² (16 to 68* lbs.)
Paper full detection	Both upper and lower tray	Upper, middle and lower tray
Paper sizes for which offset is possible	A3, B4, A4, A4R, B5, 11" x 17", 8-1/2" x 14", 8-1/2" x 13", 8-1/2" x 11", 8-1/2" x 11"R	
Allowed paper sizes for stapling	Upper paper tray/Middle paper tray: A3, B4, A4, A4R, B5, 11" x 17", 8-1/2" x 14", 8-1/2" x 13", 8-1/2" x 11", 8-1/2" x 11"R	Upper paper tray/Middle paper tray: A3, B4, A4, A4R, B5, 11" x 17", 8-1/2" x 14", 8-1/2" x 13", 8-1/2" x 11", 8-1/2" x 11"R Lower tray: A3, B4, A4R, 11" x 17", 8-1/2" x 11"R
Maximum number of sheets for stapling	See "Staple sort mode" on 3-4 page	
Stapling positions	1 place at back, 1 place at back (diagonal), one place at front (diagonal), 2 places	
Paper conveying	Centre reference	
Power supply	Supplied from machine	
Dimensions	When tray is folded up: 648 mm (W) x 630 mm (D) x 1150 mm(H) (25-33/64" (W) x 24-13/16" (D) x 45-9/32" (H)) When tray is extended: 773 mm (W) x 630 mm (D) x 1150 mm(H) (30-7/16" (W) x 24-13/16" (D) x 45-9/32" (H)) Not including stopper (40 mm (1-37/64")) when attached to machine	
Weight	Approx. 51 kg (Approx. 113 lbs.)	Approx. 71 kg (Approx. 157 lbs.)
Overall dimensions when attached to machine	773 mm (W) x 630 mm (D) (Separation from machine 400 mm) (30-7/16" (W) x 24-13/16" (D) (Separation from machine 15-3/4"))	

*For index paper, equivalent to 140-lbs.

Name	Punch module			
Model*1	AR-PN4A	AR-PN4B*2	AR-PN4C*3	AR-PN4D*3
Number of holes	2	3 or 2	4	4
Paper sizes for hole punching	A3, B4, A4, A4R, B5, B5R, 11"x17", 8-1/2"x14", 8-1/2"x13", 8-1/2"x11", 8-1/2"x11"R	3 holes: A3, A4, 11" x 17", 8-1/2" x 11" 2 holes: 8-1/2"x14", 8-1/2"x13", 8-1/2" x 11"R	A3, A4	A3, B4, A4, A4R, B5, B5R, 11"x17", 8-1/2"x14", 8-1/2"x13", 8-1/2"x11", 8-1/2"x11"R
Paper weight	60 to 256 g/m ² (16 to 68 lbs.)			
Power supply	Supplied from finisher / saddle stitch finisher			
Dimensions	95 mm (W) x 560 mm (D) x 170 mm (H) (3-3/4" (W) x 22-1/16" (D) x 6-45/64" (H))			
Weight	Approx. 3.5 kg (Approx. 7.8 lbs.)			

*1 Multiple punch modules cannot be installed together. Some models may not be available in some regions.

*2 With AR-PN4B, two or three holes can be punched depending on the paper size.

*3 With AR-PN4C and AR-PN4D, the number of holes is the same. The hole interval, however, is not the same. Specifications are subject to change for improvement without notice.

NOTES

- The following papers cannot be stapled and punched:
Special papers such as transparency film and label sheets
- If mixed paper sizes are selected for stapling jobs, stapling will be automatically cancelled.

Supplies

The finisher and saddle stitch finisher require the following staple cartridge:

- Staple cartridge for finisher (approx. 5,000 per cartridge X 3 cartridges)
SF-SC11

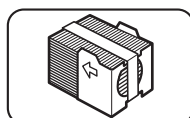

- Staple cartridge for saddle stitch finisher (approx. 2000 per cartridge X 3 cartridges)
AR-SC3

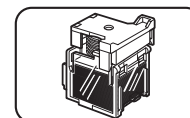

Finishing methods

Sort mode

Sorted sets will be delivered.

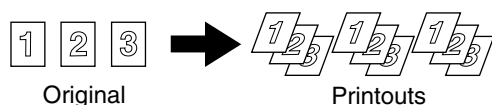

Group mode

Groups of copies of the same page will be delivered.

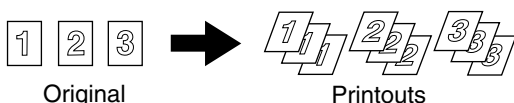

Offset mode

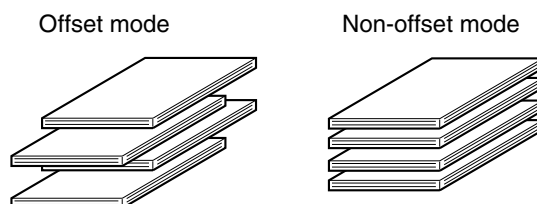

Each set of copies is offset from the preceding set to allow easy separation.

(The offset function operates in the finisher / saddle stitch finisher tray.)

The offset function cannot be selected when the staple sort function is selected.

Offset width : Approx. 30 mm (Approx. 1-3/16")

Staple sort mode

Output pages are sorted into sets by the sort function, and each set is stapled and delivered to the tray. The centre of the paper can also be stapled and delivered to the lower saddle tray (only when using the saddle stitch finisher). The relations between possible stapling positions, the paper feed direction, paper sizes that can be used, and number of pages that can be stapled are shown below.

Two sheets (one sheet when using the saddle stitch function) of 256 g/m² (68 lbs.) paper can be included as covers in the page stapling limit in the table below.

Stapling positions	Portrait orientation		Landscape orientation	
Top left corner of printouts		Available paper sizes: A4, B5 and 8-1/2" x 11" Stapling capacity: For each size, up to 50 sheets can be stapled		Available paper sizes: A3, B4, 11" x 17" Stapling capacity: For each size, up to 30 sheets can be stapled
Lower left corner of printouts		Same as above		Available paper sizes: A4R, 8-1/2" x 14", 8-1/2" x 13", 8-1/2" x 11"R Stapling capacity: For each size, up to 30 sheets can be stapled
Centre left two positions of printouts		Same as above		Same as above
Saddle stitch on centrefold line. (only when using the saddle stitch finisher)		Paper in the portrait direction cannot be saddle stitched.		Available paper sizes: A3, B4, A4R, 11" x 17", 8-1/2" x 11"R, Stapling capacity: For each size, up to 15 sheets can be stapled

■ **Original orientation when using the staple sort or punch function**

When using the staple sort or punch function, the original must be placed in the following orientations to enable stapling or punching in the desired position on the paper.

Staple sort		Punch	
Document feeder	Document glass	Document feeder	Document glass

3

■ **Saddle stitch function (only saddle stitch finisher)**

The saddle stitch finisher can automatically place two staples for centreline binding of prints or copies and fold them along the centreline.

<Example>

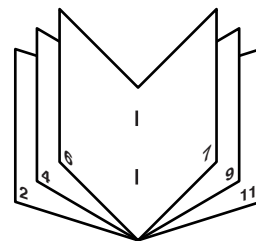

■ **Hole punching (only if a punch module is installed)**

When the optional punch module is installed, holes can be punched in printed pages. (When using the saddle stitch finisher, pamphlet style stapling and the punch function cannot be used together.) When using the punch function, automatic rotation of the original image does not operate.

For the allowed paper sizes for punching, see the specifications on page 3-3.

When using the punch function in copy mode, place the original with the top toward the inside of the machine. If the original is not placed in this orientation, punching will not take place at the correct positions. (See "Standard original placement orientations" on page 4-4.)

<Example>

{Original 1}

{Punch positions}

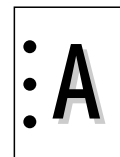
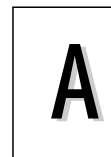

{Original 2}

{Punch positions}

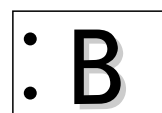

Finishing modes and finisher functions

Touch the [OUTPUT] key on the main screen of copy mode to display the screen that allows selection of sort, staple sort, group function, centreline stapling, and the output tray.

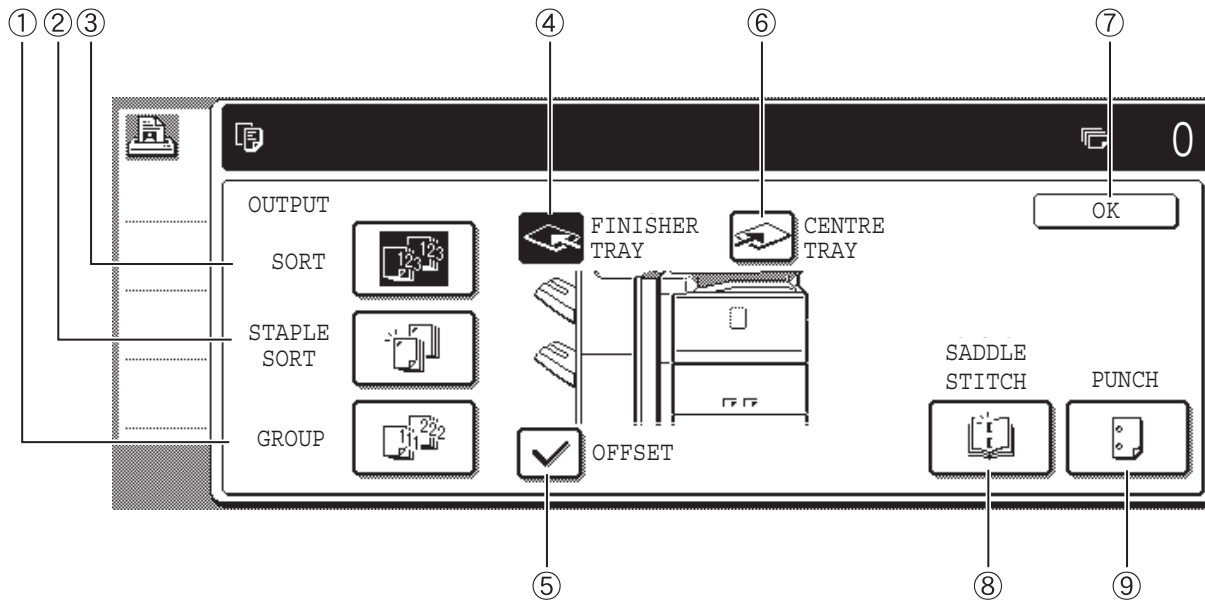

① **[GROUP] key (See page 3-4.)**

When Group is selected, copies will be grouped by page.

② **[STAPLE SORT] key (See page 3-4.)**

When Staple Sort is selected, sorted sets will be stapled and delivered to the offset tray. (They will not be offset stacked.) Select from three stapling positions.

③ **[SORT] key (See page 3-4.)**

When Sort is selected, sets of copies will be collated.

④ **[FINISHER TRAY] key (See page 3-2.)**

When the offset function is selected, output is delivered offset to the finisher tray. (The finisher tray is automatically selected when the staple sort function is turned on.)

⑤ **[OFFSET] key (See page 3-4.)**

The offset function operates when a checkmark appears in this key. (The offset checkmark is automatically cleared when the staple sort function is enabled.)

⑥ **[CENTRE TRAY] key**

If the centre tray is selected, output paper will be delivered to the exit tray located above the main unit.

⑦ **[OK] key**

Touch to close the [OUTPUT] screen and return to the main screen.

⑧ **[SADDLE STITCH] key (See page 3-5.)**

This is displayed when the saddle stitch finisher is installed, and is used to staple pages at the centre and fold them in half to create a pamphlet.

Touch this key to display the pamphlet copy setting screen (page 5-6). (This is only possible when the [AUTOMATIC SADDLE STITCH] checkbox is selected in the administrator settings (see page 12 of the administrator settings guide).)

⑨ **[PUNCH] key (See page 3-5.)**

This is used to punch holes in printed pages when an optional punch module is installed.

NOTE

When a functions is selected, it is highlighted.

Staple cartridge replacement and staple jam removal

When a finisher is installed, a message will appear when the staple cartridge runs out of staples or a staple jam occurs.

Follow the procedure below to replace the staple cartridge or remove jammed staples.

■ Replacing the cartridge in the finisher

- 1** Open the front cover of the finisher.

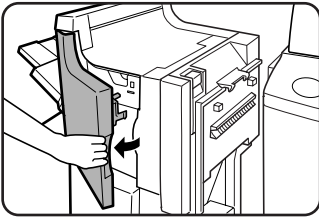

- 2** Lower the blue lever in the stapler and slide out the staple cartridge.

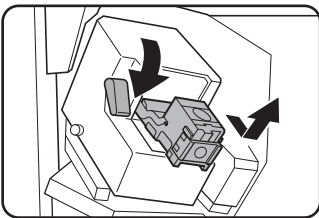

- 3** Pull the empty staple case straight up and out of the cartridge.

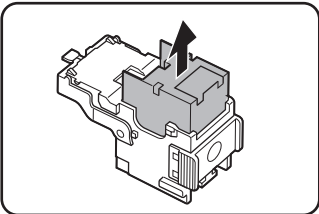

- 4** Insert a new staple case into the cartridge. Push the staple case all the way in until it clicks into place.

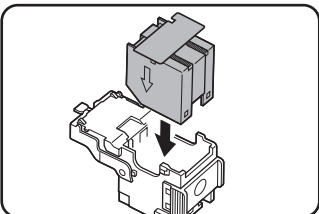

Do not remove the seal holding the staples until the staple case is set in the cartridge.

- 5** Pull the seal that holds the staples straight out.

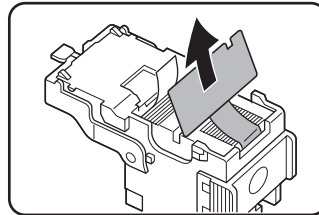

- 6** Insert the cartridge all the way in until it clicks into place.



Insert the cartridge all the way in until it clicks into place.

- 7** Close the front cover of the finisher.

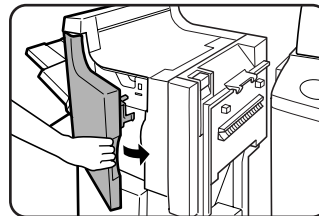

NOTE

Make a test print or copy in the staple sort mode to verify that stapling is performed properly.

■ Replacing the cartridge in the saddle stitch finisher

Only when the saddle stitch finisher (AR-F16) is installed.

- 1** Open the lower cover of the saddle stitch finisher.

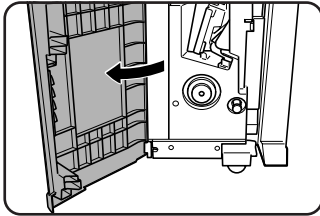

When an optional inserter is installed, open the front cover of the inserter before opening the lower cover of the finisher.

- 2** Slide out the saddle stitch unit carefully toward the front.

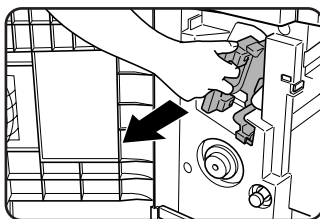

- 3** (1) Grasp the grip of the saddle staple holder and pull it out.
 (2) While still grasping the grip, rotate the saddle staple holder 90° in the direction of the arrow (rotate to the right).

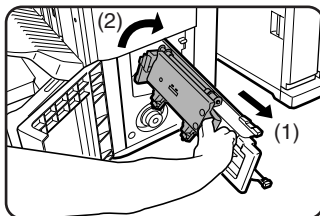

- 4** Remove the empty staple case and set a new one.

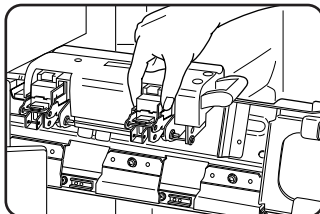

Replace both staple cases with new ones. Remove the cover from the staple cartridge and then install the cartridge.

- 5** Return the saddle stitch holder and the saddle stitch unit to their respective original positions.

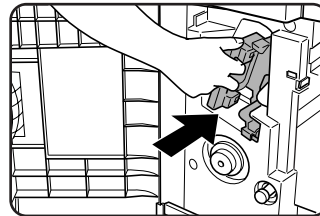

- 6** Make sure that the finisher is firmly attached to the machine and that A3, A4R, or B4 (11" x 17", 8-1/2" x 11"R, or 8-1/2" x 14") size paper is loaded.

If one of the above paper sizes is not set, test stapling cannot be performed.

- 7** Close the lower cover of the finisher.

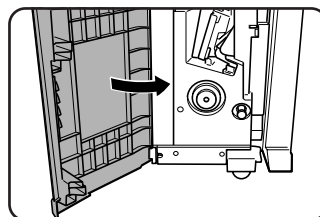

Test stapling is automatically performed on a blank sheet. This operation is carried out to avoid blank stapling.

NOTE

If test stapling fails to take place, repeat steps 1 to 7.

■ Removing a staple jam in the finisher

1 Perform steps 1 to 2 of the procedure for "Replacing the cartridge in the finisher" on page 3-7.

2 Holding the knob, lower part (A).

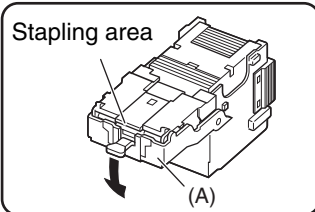

NOTE

Do not touch the stapling area.
The stapler could injure you.

3 Remove any jammed staples.

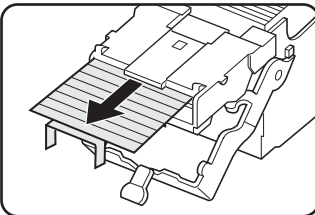

4 Holding the knob, return part (A) to its original position.

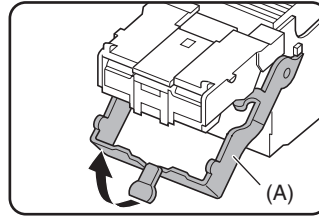

5 Return the staple case to its original position.

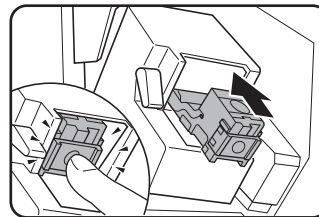

Insert the cartridge all the way in until it clicks into place.

3

6 Close the front cover of the finisher.

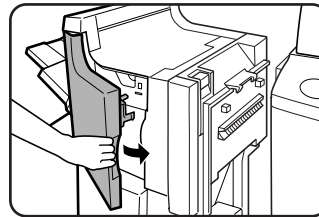

■ Removing a staple jam in the saddle stitch finisher

1 Perform steps 1 to 3 of the procedure for "Replacing the cartridge in the saddle stitch finisher" on page 3-8.

2 Remove the empty staple case.

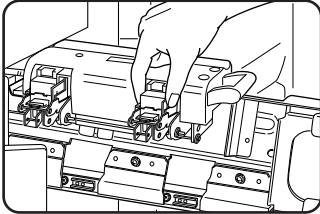

3 While pushing down on lever (A), pull up knob (B).

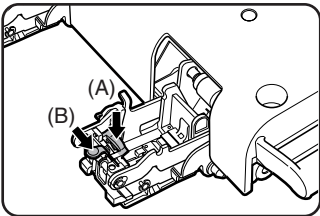

4 Remove any jammed staples, and then return knob (B) to its original position.

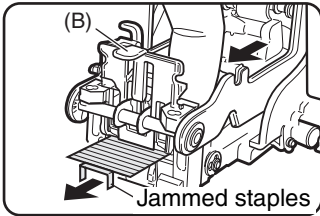

Be sure to remove any strips of staples.

5 Return the staple case to its original position.

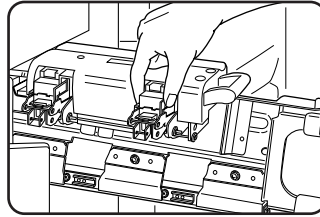

6 Return the saddle stitch holder and the saddle stitch unit to their respective original positions.

7 Make sure that the finisher is firmly attached to the machine and that A3, A4R, or B4 (11" x 17", 8-1/2" x 11"R, or 8-1/2" x 14") size paper is loaded.

If one of the above paper sizes is not set, test stapling cannot be performed.

8 Close the lower cover of the finisher.

Test stapling is automatically performed on a blank sheet.

This operation is carried out to avoid blank stapling.

NOTE

If test stapling fails to take place, repeat steps 1 to 7.

NOTE

Do not touch the stapling area.
The stapler could injure you.

■ Disposal of hole punch scrap (when the punch module is installed)

1 Open the cover of the hole punch module.

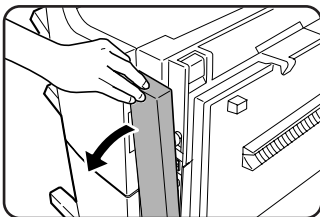

2 Holding the black handle, slide out the case containing the paper bits, and dispose of them properly.

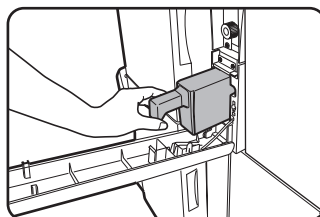

3 Return the waste case to its original position.

4 Close the cover of the hole punch module.

Removing a misfeed

When a misfeed occurs, remove the misfed paper as explained below.

■ General procedure for the finisher and saddle stitch finisher

- 1** Gently move the finisher/saddle stitch finisher away from the machine while pressing the button.

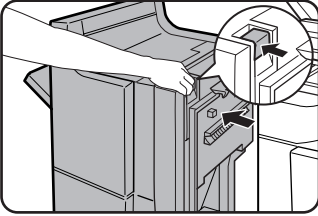

When an inserter is installed, separate the inserter from the machine while pressing on the inserter button.

- 2** Remove the misfed paper from the main unit.

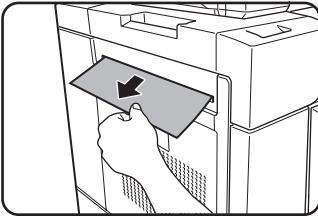

After removing the misfed paper, perform steps 1 and 3 on page 2-24 to reset the machine.

- 3** Open the upper cover of the finisher/saddle stitch finisher.

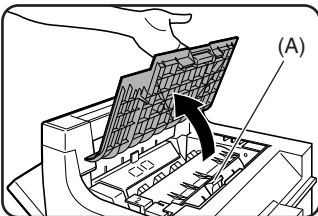

When an inserter is installed, lift the tray of the inserter.

- 4** Lift knob (A) (See the step 3 figure), then remove any misfed paper.

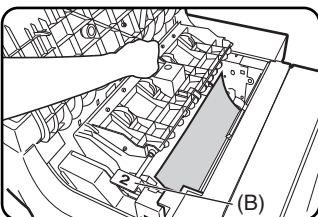

Be careful not to tear the misfed paper during removal.

- 5** Lift knob (B) (see the illustration in step 4) and remove any misfed paper.

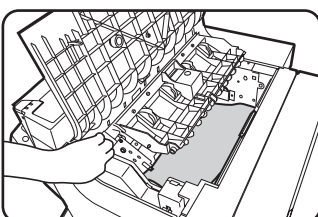

Be careful not to tear the misfed paper during removal.

- 6** Remove any misfed paper from the paper exit area.

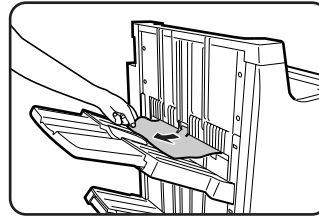

Be careful not to tear the misfed paper during removal.

- 7** Close the upper cover of the finisher/saddle stitch finisher.

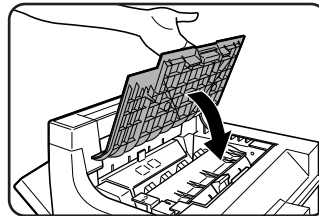

■ When a saddle stitch finisher is installed

- 8** Open the front cover of the inserter (only when an inserter is installed).

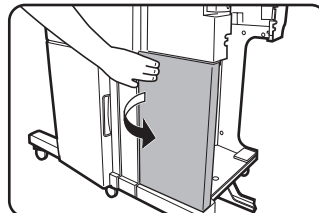

- 9** Open the lower cover of the saddle stitch finisher.

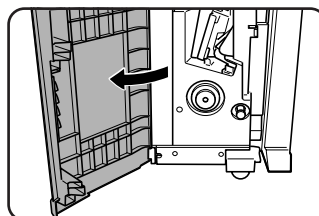

- 10** Open the entrance cover of the saddle stitch unit.

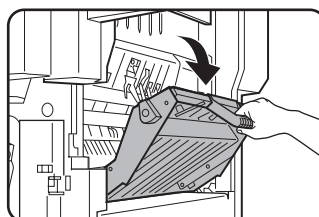

11 Remove the misfed paper.

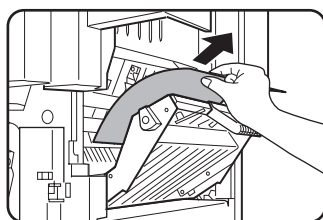

Be careful not to tear the misfed paper during removal.

12 Close the entrance cover of the saddle stitch unit.

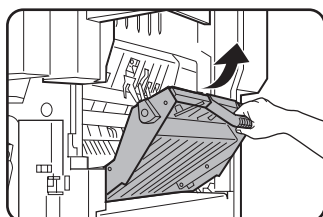

13 Turn the right-hand knob ① counter clockwise. Then, push the left-hand knob ② and turn it clockwise.

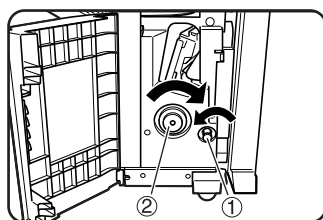

14 Remove any paper misfed on the exit side of the saddle stitch unit.

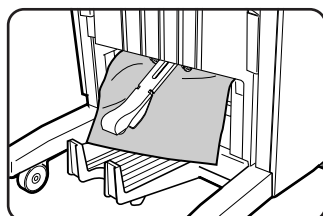

Be careful not to tear the misfed paper during removal.

15 Open the exit cover of the saddle stitch unit and remove any misfed paper.

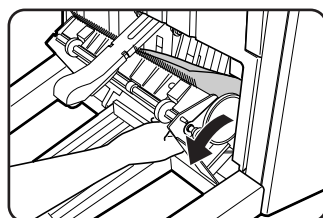

Be careful not to tear the misfed paper during removal.

16 Close the exit cover of the saddle stitch unit.

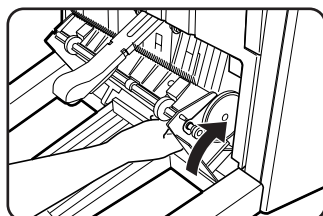

17 Close the lower cover of the saddle stitch finisher.

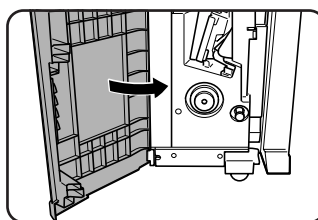

18 Close the front cover of the inserter (only when an inserter is installed).

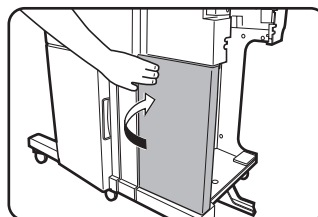

■ When a punch module is installed
19 Open the cover of the hole punch module.

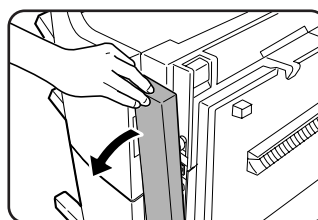

20 Rotate the green knob until the arrow is within the range (A) on the label, and remove the misfed paper.

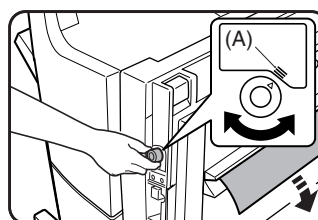

Be careful not to tear the misfed paper during removal.

21 Close the cover of the hole punch module.

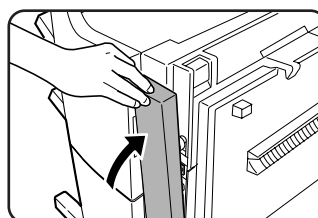

22 Push the finisher back against the main unit.

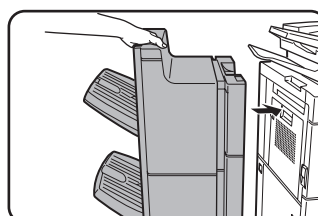

Troubleshooting finisher/saddle stitch finisher problems

Check the list below before calling for service.

Problem	Check	Solution or cause
Stapling position is not correct (including saddle stitch).	Stapling position not set properly?	Check the stapling position setting. (See page 3-4.)
The finisher/saddle stitch finisher does not operate.	Are any finisher/saddle stitch finisher covers open?	Close all covers. (See step 7 on page 3-7 and step 7 on page 3-11.)
	Message indicating need to remove paper from the stapler compiler displayed?	Remove all remaining paper from the stapler compiler. (For the stapler compiler, see "Part names" on page 3-2.)
Stapling cannot be performed (including saddle stitch).	Message to check the staple unit displayed?	Remove jammed staples. (See pages 3-9 and 3-10.)
	Message to add staples displayed?	Replace the staple cartridge. (See pages 3-7 and 3-8.) Check that a staple cartridge has been installed. (See pages 3-7 and 3-8.)
	Different sizes of paper mixed together?	Stapling cannot be performed on mixed paper sizes.
	The paper is badly curled.	The quality and type of some papers may cause bad curling that prevents stapling. Take the paper out of the tray or bypass tray, turn the stack over, and reload it.
Saddle stitch cannot be selected.	The paper type of the selected paper tray is set to heavy paper.	Saddle stitch is not possible on heavy paper. However, when cover insertion is selected, saddle stitch is possible on a single sheet of heavy paper inserted for use as a cover.
The punch hole positions are not correct.*	The punch function is not set to the correct punch positions.	Check the allowed hole punch positions. (See page 3-5.)
Cannot be punched.*	Message to check the punch module displayed?	Dispose of punch scraps. (See page 3-10.)
	Mixed paper sizes.	Punching is not possible when different paper sizes are mixed together.
	The paper is badly curled.	The quality and type of some papers may cause bad curling that prevents punching. Take the paper out of the tray or bypass tray, turn the stack over, and reload it.

* When a hole punch module is installed

INSERTER

The inserter enables blank sheets or printed sheets to be added to copy and print output as covers or inserts without printing. The inserter also allows feeding of heavy paper that cannot be fed from the other trays.

Printed output can also be fed one set at a time from the inserter for stapling or punching without performing stapling or staple sorting finishing (see "Manual operation of the inserter" (page 3-15)).

When feeding from the inserter for pamphlet copying (page 5-6), cover or insert copying (page 5-12), or transparency insert copying (page 5-23), select "INSERTER" in step 4 of "Setting the paper type and paper size" (page 2-14), and be sure to perform steps 5 through 8. In step 9, make sure that the checkboxes below "PRINT", "COPY", and "DOC. FILING" are selected. If any of these checkboxes are not selected, touch them so that a checkmark appears.

When feeding from the inserter for pamphlet copying (page 5-6), cover or insert copying (page 5-12), or transparency insert copying (page 5-23), select the inserter in the tray settings. The inserter attributes can also be selected in the system settings (see page 2-18).

Part names

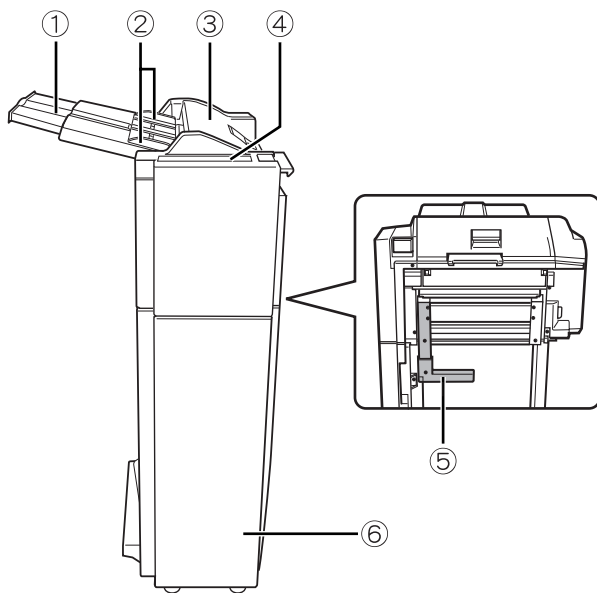

- ① **Paper tray**
Place blank or printed paper here to be inserted.
- ② **Paper guide**
When loading paper, adjust this guide to the width of the paper.
- ③ **Top cover**
Open for misfeed removal.
- ④ **Inserter operation panel**
Stapling and punching can be performed directly from the inserter operation panel without using the machine operation panel.
- ⑤ **Paper guide lever**
Release the paper guide lock to remove misfed paper.
- ⑥ **Front cover**
Open this cover to remove misfed paper from the finisher or saddle stitch finisher.

NOTE

To install the inserter...

An optional finisher or saddle stitch finisher must be installed (page 3-2).

Specifications

Name	Inserter (AR-CF2)
Paper weight	60 to 256 g/m ² (16 lbs. to 68* lbs.) *For index paper, equivalent to 140-lbs.
Paper types	Plain paper, special paper (transparency film, coloured paper, paper with punch holes, tabbed paper, etc.) (Consult your retailer for more information on special papers that can be used.)
Paper size	A3, B4, A4, A4R, B5, B5R, A5R, 11" x 17", 8-1/2" x 14", 8-1/2" x 13", 8-1/2" x 11", 8-1/2" x 11"R, 7-1/4" x 10-1/2"R, 5-1/2" x 8-1/2"R
Paper capacity	Max. 100 (80 g/m ² (20 lbs.))
Paper conveying	Centre reference
Power supply	Supplied from machine
Dimensions	When paper tray is folded up: 285 (565*) mm (W) x 585 mm (D) x 1120 mm (H) (11-15/64" (22-1/4**) (W) x 23-3/64" (D) x 44-7/64" (H)) Not including stopper (40 mm (1-37/64")) when attached to machine * Including paper tray
Weight	Approx. 24 kg (Approx. 53 lbs.)

Specifications are subject to change for improvement without notice.

Loading paper

When loading paper in the inserter, load the paper face up. If the paper has a top edge and bottom edge, load in the same top-bottom orientation as the original. Adjust the paper guide on the paper tray to the width of the paper. When using tabbed paper, place the paper as follows:

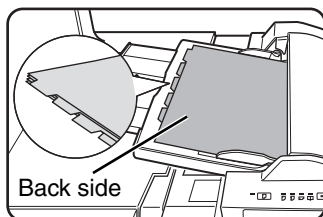

Load the paper back side up. The top side is inserted first.

The relation of copies and tabbed sheets is shown below.

Load tabbed paper

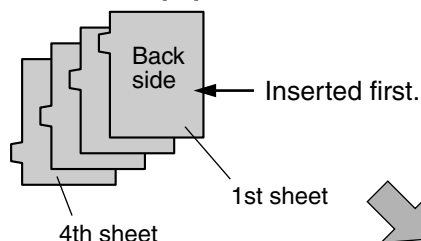

Copy

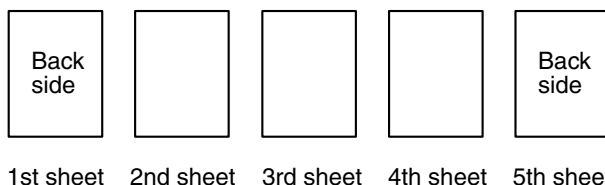

Copy result

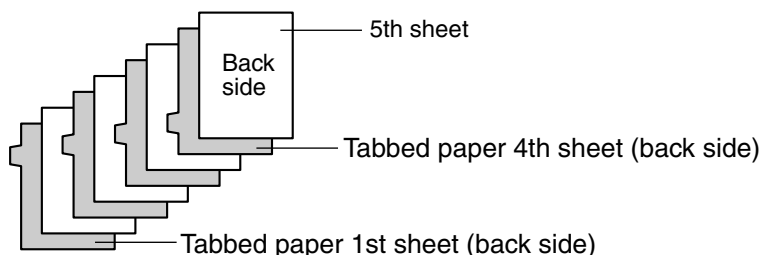

Manual operation of the inserter

The inserter can be used for stapling or punching without performing a copy operation. These functions are selected at the operation panel of the inserter.

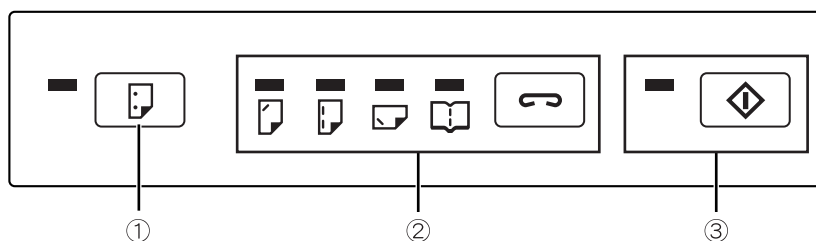

① [PUNCH] key

When a punch module is installed on the finisher or saddle stitch finisher, punch holes can be added to blank paper or printed paper. The indicator lights when this function is selected.

② [STAPLE] key/indicator

When this function is selected, each set of output is stapled and delivered to the finisher or saddle stitch finisher tray. (Note that the sets are not offset.) Press this key until the icon light of the desired staple position lights up. ("Pamphlet" stapling can only be selected when a saddle stitch finisher is installed)

③ [START] key/indicator

After selecting punch or staple settings with key ① or key ②, place the paper to be punched or stapled on the inserter tray and press this key.

NOTES

- Do not use tabbed paper when operating the inserter manually.
 - The punching and stapling functions cannot be used when the finisher or saddle stitch finisher has failed, or when the functions are prohibited* in the administrator settings (page 11 of the administrator settings guide).
- * Disabling of stapler/Disabling of punch/Disabling of finisher/Disabling of inserter

■ Alarm display

If the [START] key indicator on the inserter operation panel is blinking and the [PUNCH] key or [STAPLE] key indicator is also blinking or solidly lit, operation will not start when the [START] key is pressed. Resolve the problem as indicated below, depending how the indicators are lit or blinking.

[PUNCH] indicator	[STAPLE] indicator				[START] indicator	Cause	Solution
Any one of the indicators is solidly lit.					Blinks red	A paper size that cannot be fed has been loaded.	Use paper that is a suitable size for punching, stapling, or saddle stitching (page 3-3).
-	-	-	-	Solidly lit	Blinks red	The paper type of the inserter is set to heavy paper.	Heavy paper cannot be used.
Blinking	-	-	-	-	Blinks red	The finisher or saddle stitch finisher tray is full.	Remove the paper from the tray.
						The hole punch scrap container in the punch module on the finisher or saddle stitch finisher is full.	Discard the hole punch scrap (page 3-10).
-	Any one of the indicators is blinking.			-	Blinks red	The finisher or saddle stitch finisher tray is full.	Remove the paper from the tray.
						The finisher or saddle stitch finisher is out of staples.	Replace the staple cartridge (page 3-7).
-	-	-	-	Blinking	Blinks red	The saddle stitch tray on the saddle stitch finisher is full.	Remove the paper from the saddle stitch tray.
						The saddle stitch finisher is out of saddle stitch staples.	Replace the saddle stitch staple cartridge (page 3-8).

■ Using the inserter

For paper sizes that can be stapled or punched, see the finisher and saddle stitch finisher specifications on page 3-2.

Some paper types cannot be stapled or punched (see "NOTES" on page 3-3). Do not use these paper types.

1 Load paper in the inserter.

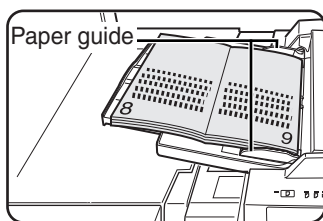

Load the paper face up. When performing pamphlet stapling, place the paper so that the opened pages are face up as shown. Adjust the paper guide to the size of the paper.

2 Press the desired mode key.

Press key ② on page 3-15 for stapling or pamphlet stapling. Press key ① on page 3-15 for punching. The selected mode lights up.

NOTE

Pamphlet stapling can only be used when the saddle stitch finisher (AR-F16) is installed. When using pamphlet stapling, stapling and punching cannot be used in combination.

3 Press the [START] key.

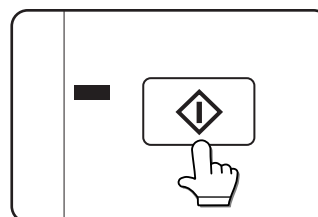

Make sure that the [START] key light is illuminated green and then press the [START] key.

Misfeed removal

When a misfeed occurs in the inserter, remove the misfed paper following the procedure below.

■ Misfeed in the inserter

1 Gently move the inserter away from the machine while pressing the button.

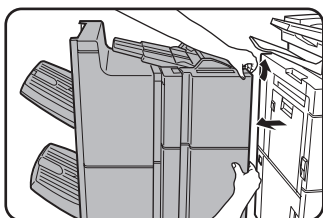

2 Remove the misfed paper from the main unit.

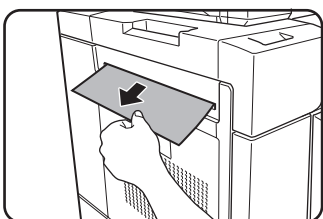

Be careful not to tear the misfed paper during removal.

After removing the misfed paper, perform steps 1 and 3 on page 2-24 to reset the machine.

3 If misfed paper is not found in step 2, open the top cover.

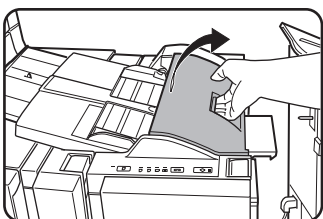

4 Remove the misfed paper.

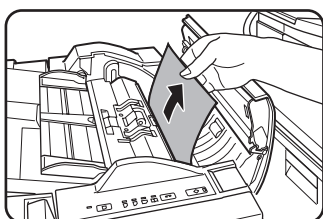

Be careful not to tear the misfed paper during removal.

5 If a misfeed was not found in step 4, raise the paper guide lever.

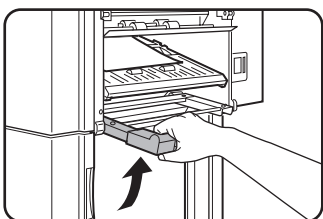

6 Remove the misfed paper.

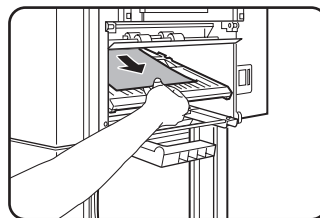

Be careful not to tear the misfed paper during removal.

7 If a misfeed was not found in step 6, remove the misfed paper from under the paper guide.

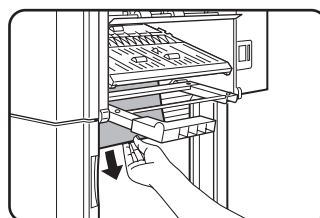

Be careful not to tear the misfed paper during removal.

8 Return the paper guide lever to its original position.

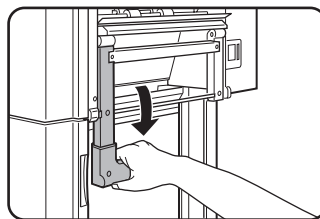

9 Push the finisher to close the gap between the machine and the inserter.

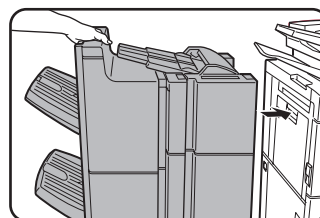

After attaching the inserter on the machine, make sure that the paper misfeed message has been cleared and the normal message display appears.

3

Troubleshooting inserter problems

Check the list below before calling for service.

Problem	Check	Solution or cause
Stapling position is not correct (including saddle stitch).	The desired staple mode is not selected.	Select the desired staple mode at the operation panel of the inserter (page 3-15).
	The paper is not loaded in the correct position.	Load the paper correctly (page 3-16).
	The paper is not loaded face up.	Paper must be loaded face up in the inserter tray (page 3-16).
The inserter does not operate.	Are any inserter covers open?	Close all covers.
	"Disabling of inserter" is enabled in the administrator settings.	Check the administrator settings and disable "Disabling of inserter".
	A paper misfeed message appears.	Remove the misfed paper (page 3-17).
	The [START] key light is not illuminated.	Make sure that the punch or staple key has been selected on the operation panel of the inserter (page 3-15).
Paper misfeed occurs	The paper is curled or damp.	Do not use curled or folded paper. When the inserter is not going to be used for a long time, remove the paper from the inserter, place it in a bag so that it does not absorb moisture, and store it in a cool and dark place.
A paper misfeed occurs when paper is fed from the inserter.	Do the size and orientation of the loaded paper match the paper size and orientation set in "Setting the paper type and paper size"?	Make sure paper size and orientation set in "Setting the paper type and paper size" match the size and orientation of the loaded paper.
A message appears each time paper is placed in the paper tray of the inserter.	Was the [SIZE SELECT] key touched and the size and orientation of the paper for the inserter set as explained in "Setting the paper type and paper size"?	To ensure that the correct paper (size and orientation) is loaded in the inserter, the machine indicates the current paper size setting each time paper is placed in the paper tray.

SHARP OSA

Sharp OSA (Open Systems Architecture) is an architecture that enables external applications to be directly connected to a digital multifunction machine over a network.

When a digital multifunction machine that supports Sharp OSA is used, the operation panel controls and functions of the machine such as scan send can be linked to an external application.

There are two types of external applications: "standard application" and "external account application". An "external account application" is used for centralized account management of a multifunction machine on a network. A "standard application" refers to all other applications.

APPLICATION COMMUNICATION MODULE (MX-AMX2)

The application communication module is required to use a "standard application" on the machine.

When a previously registered standard application is selected in the Web pages of the machine, the machine retrieves the operation screen from the registered URL. Control of the operation screen is performed by the standard application, and Scan to FTP can be executed.

3

Standard application setup

To register a standard application in the machine's Web pages, click [External Applications] in the administrator menu frame and then click [Standard Applications]. Configure settings for the standard application in the screen that appears.

Selecting a standard application

There are two methods for selecting a standard application that has been registered in the machine's Web pages.

■ Selecting a standard application from the job status screen

The Sharp OSA icon will appear in the lower left-hand corner of the job status screen. Follow the steps below to select a standard application.

1 Touch the Sharp OSA icon.

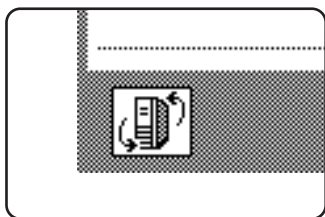

If no standard applications have been stored in the Web pages, the key cannot be touched.

2 Select the standard application.

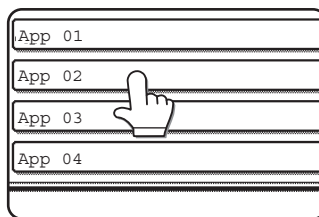

If two or more standard applications have been stored in the Web pages, the screen to select the standard application will appear. Touch the standard application that you wish to use.

If only one standard application has been stored in the Web pages, connection to the standard application will begin.

3 The machine connects to the standard application.

The message "Connecting to the external application." appears while the machine communicates with the standard application.

■ Selecting the standard application from document filing mode

The [Sharp OSA] key appears in the upper right-hand corner of the document filing screen. Follow the steps below to select a standard application.

1 Touch the [Sharp OSA] key.

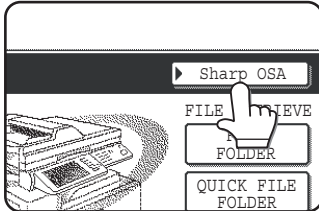

If no standard applications have been stored in the Web pages, the key cannot be touched.

2 Select the standard application.

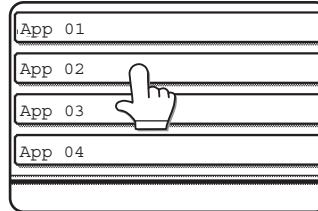

If one or more standard applications have been stored in the Web pages, the screen to select the standard application will appear. Touch the standard application that you wish to use.

If only one standard application has been stored in the Web pages, connection to the standard application will begin.

3 The machine connects to the standard application.

The message "Connecting to the external application." appears while the machine communicates with the standard application.

Operation in OSA mode

When the application communication module is installed, it is possible to check the job log of OSA scan mode in the job status screen. The procedure for displaying the job log is the same as for regular Scan to FTP.

To display the job log of OSA scan mode, touch the [SCAN] key once again while the job log of scan mode appears in the job status screen. (When this is done, the name of the key will change to [OSA SCAN].) To return to the scan screen from the OSA scan screen, touch the [OSA SCAN] key.

EXTERNAL ACCOUNT MODULE (MX-AMX3)

The external account module is required to use a "external account application" on the machine.

An external account application can be used in "external authentication mode" or "external count mode". When external authentication mode is used, the login screen is retrieved from the application when the machine is started. When a job ends, a job notification screen is sent to the application to enable counts to be kept for each authenticated user.

When "external count mode" is used, the login screen is not displayed when the machine is started. Only a job result notification is sent to the application. User authentication by the external account application cannot be used, however, the external account application can be used in combination with the internal account function.

External account application setup

To register an external account application in the machine's Web pages, click [External Applications] in the administrator menu frame and then click [External Accounting]. Configure settings for the external account application in the screen that appears. To make the settings in the Web page take effect, restart the machine.

Operation in external account mode

The two modes for using an external account application operate as explained below.

■ External authentication mode

When the [ENABLE AUTHENTICATION BY EXTERNAL SERVER] checkbox is selected in "External account setting" of "Sharp OSA settings" in the administrator settings, the machine enters external authentication mode. When the machine is powered on in external authentication mode, the machine accesses the external account application and displays the login screen. The login screen also appears when the [CALL] key is touched to run a job in the job status complete screen. (The login screen does not appear if the user has already logged in by the normal method.)

The [JOB STATUS] key can be pressed while the login screen appears to show the job status screen. To return to the previous state, press the mode select key.

NOTES

- The user control function of the machine cannot be used in external authentication mode.
- The [SYSTEM SETTINGS] key can be pressed while the login screen appears to show the system settings screen. To return to the initial state, touch the [EXIT] key.

If login fails

If the login screen fails to appear or the application does not operate correctly, the machine may also stop operating correctly. In this event, it is recommended that you quit external account mode from the Web pages of the machine. For more information, see [Help] in the Web pages.

If it is necessary to forcibly terminate external account mode using the operation panel of the machine, follow the steps below.

Press the [SYSTEM SETTINGS] key and change "External account setting" in the administrator settings (see page 14 of the administrator settings guide). After changing the setting, restart the machine.

■ External count mode

When only the [ENABLE EXTERNAL ACCOUNT CONTROL] setting is enabled in "External account setting" of "Sharp OSA settings" in the administrator settings, the machine enters external count mode.

Unlike external authentication mode, when the machine is started in "external count mode", the login screen of the external account application is not displayed. Only the job result is sent to the external account application. External count mode can be used together with the user control function of the machine. (External count mode can also be used when the user control function is disabled.)

Part 2: Copier Operation



CHAPTER 4

MAKING COPIES

This chapter explains the basic procedures for making copies, including selection of the copy ratio and other copy settings.

	Page
AUTOMATIC DOCUMENT FEEDER	4-2
• Acceptable originals	4-2
PLACING ORIGINALS	4-3
CHECKING THE SIZE OF A PLACED ORIGINAL	4-5
• Manually setting the scanning size	4-5
STORING, DELETING, AND USING ORIGINAL SIZES	4-6
• Storing or deleting an original size	4-6
NORMAL COPYING	4-7
• Making copies with the automatic document feeding function	4-7
• Automatic two-sided copying using the automatic document feeding function.....	4-10
• Copying from the document glass.....	4-11
• Automatic two-sided copying from the document glass	4-13
ADJUSTING THE EXPOSURE	4-14
REDUCTION/ENLARGEMENT/ZOOM.....	4-15
• Automatic selection (auto image).....	4-15
• Manual selection (preset copy ratios/zoom).....	4-16
• XY ZOOM.....	4-18
SPECIAL PAPERS.....	4-20

AUTOMATIC DOCUMENT FEEDER

The automatic document feeding function automatically feeds originals into the machine, making continuous copying possible. In addition, both sides of two-sided sheet originals can be simultaneously scanned. This function is convenient when you have a large number of original pages to scan.

Acceptable originals

Up to 150 originals (80 g/m² (20 lbs.)) of the same size, or an overall stack height of no more than 19.5 mm (49/64"), can be loaded. Originals of mixed length can also be loaded together as long as they are the same width; however, some special functions may not operate correctly.

■ Size and weight of acceptable originals

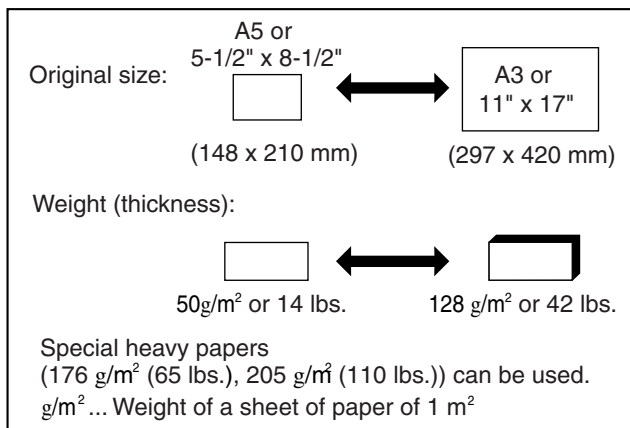

■ Total number of originals that can be set in the document feeder tray

- Maximum of 150 sheets (80 g/m² (20 lbs.)) or total stack height of 19.5 mm (49/64") or less.

■ Notes on use of the automatic document feeder

- Use originals within the specified size and weight ranges. Use of originals out of the specified range may cause an original misfeed.
- Before loading originals into the document feeder tray, be sure to remove any staples or paper clips.
- If originals have damp spots from correction fluid, ink or glue from pasteups, be sure they are dried before they are fed. If not, the interior of the document feeder or the document glass may be soiled.
- Do not use the following originals. These originals may cause incorrect original size detection, original misfeeds, and smudges on copies.
 - Transparency film, tracing paper, carbon paper, thermal paper or originals printed with thermal transfer ink ribbon should not be fed through the document feeder. Originals to be fed through the feeder should not be damaged, crumpled or folded or have loosely pasted paper on them or cutouts in them. Originals with multiple punched holes other than two-hole or three-hole punched paper may not feed correctly.
- When using originals with two or three holes, place them so that the punched edge is at a position other than the feed slot.

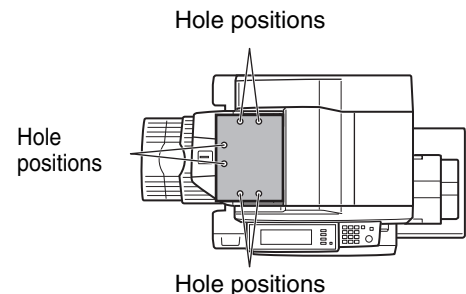

PLACING ORIGINALS

■ Using the automatic document feeder

1 Open the document cover, make sure that an original has not been left on the document glass, and then gently close the document cover.

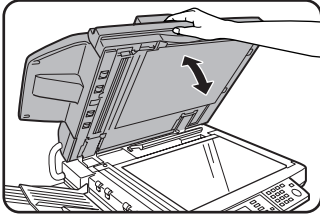

2 Adjust the original guides to the size of the originals.

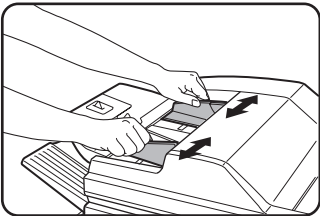

3 Place the originals face up in the document feeder tray.

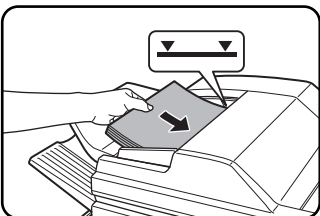

Place the originals face up.

Insert the originals all the way into the document feeder. The stack height must not be higher than the indicator line (maximum of 150 pages).

■ Using the document glass

Open the document cover, place the original face down on the document glass, and then gently close the document cover.

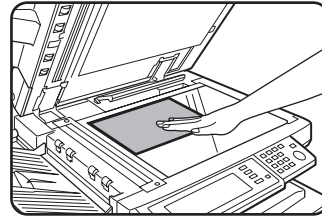

NOTES

- After placing the original, be sure to close the document cover. If left open, parts outside of the original will be copied black, causing excessive use of toner.
- Do not place any objects under the original size detector, because they may damage it or the original size may not be detected properly.

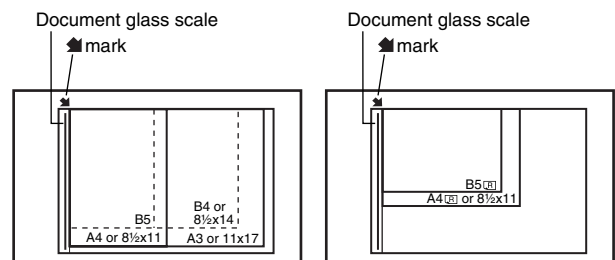

- Align the corner of the original with the tip of the arrow mark  on the document glass scale.
- Place the original in the appropriate position for its size as shown above.

NOTE

Original size detection function

One of the four groups of standard original sizes shown below can be selected for detection by the original size detection function. The factory default setting is "AB-2". The setting can be changed using "ORIGINAL SIZE DETECTOR SETTING" in the administrator settings.

	Group	Detectable original sizes	
		Document feeder tray (for reversing automatic document feeding)	Document glass
1	AB-1	A3, A4, A4R, A5, B4, B5, B5R	Document glass + 8-1/2" x 11", 216x330
2	AB-2	A3, A4, A4R, A5, B5, B5R, 216x330	Document glass + 8-1/2" x 11", B4
3	INCH-1	11" x 17", 8-1/2" x 14", 8-1/2" x 11", 8-1/2" x 11"R, 5-1/2" x 8-1/2"	Document glass + A4
4	INCH-2	11" x 17", 8-1/2" x 13", 8-1/2" x 11", 8-1/2" x 11"R, 5-1/2" x 8-1/2"	Document glass + A4

■ Standard original placement orientations

[Example 1]

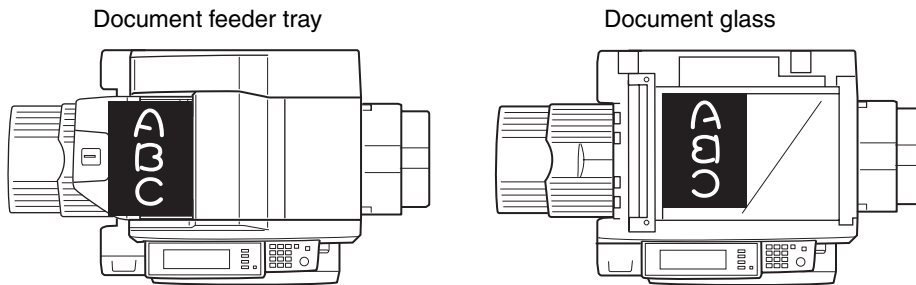

Place originals in the document feeder tray or on the document glass so that the top and bottom of the original is positioned as shown in the illustration. If not, staples will be incorrectly positioned and some special features may not give the expected result.

[Example 2]

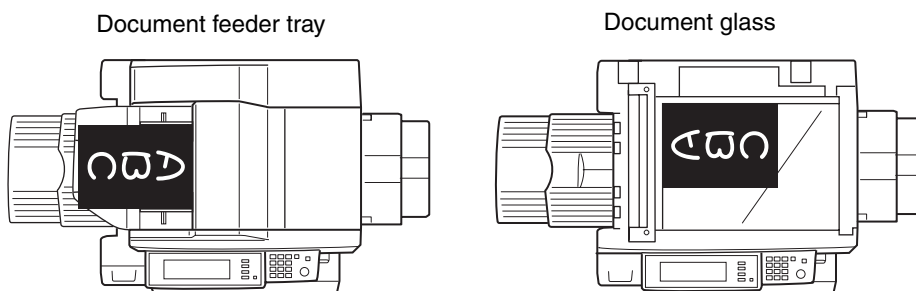

■ Automatic copy image rotation - rotation copying

If the orientation of the originals and copy paper are different, the original image will be automatically rotated 90° and copied. (When an image is rotated, a message will be displayed.) If a function is selected that is not suitable for rotation, such as enlarging the copy to greater than A4 (8-1/2" x 11") size or staple sorting with the saddle stitch finisher, rotation will not be possible.

[Example]

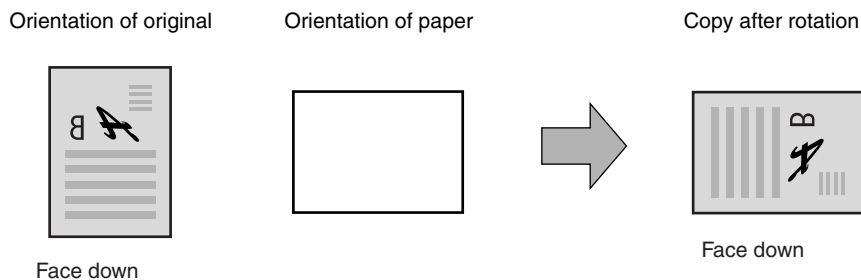

● This function operates in both the auto paper select or auto image mode. ("Rotation copy setting" can be disabled in the administrator settings. See page 16 of the administrator settings guide.)

CHECKING THE SIZE OF A PLACED ORIGINAL

If the placed original is a standard size, the size will be automatically detected (automatic original detection function) and displayed in the touch panel. Make sure that the correct size has been detected.

(A) : The original size is displayed.

(B) : [AUTO] appears when the automatic original detection function is operating.

If you have loaded a non-standard size original or wish to change the scanning size, you can follow the steps below to manually set the original scanning size. (For the standard sizes, see "Original size detection function" on page 4-3.)

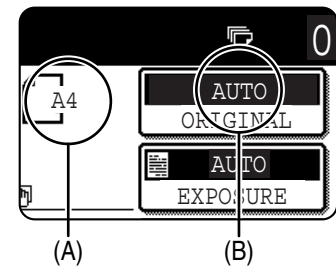

NOTE

If a non-standard size original is loaded (including special sizes), the closest standard size may be displayed, or the original size may not appear at all.

If "CANCEL DETECTION AT DOCUMENT GLASS" is enabled in the administrator settings (see page 11 of the administrator settings guide), automatic original detection at the document glass will not operate. In this case, follow the steps below to manually set the original scanning size.

Manually setting the scanning size

If you load an original that is not a standard size (such as an INCH size), or if the size is not detected correctly, you must touch the [ORIGINAL] key and set the original size manually. Perform the following steps after placing the document in the automatic document feeder or on the document glass.

1 Touch the [ORIGINAL] key.



2 Touch the desired original size key.

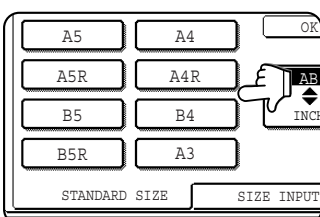

[AUTO] is no longer highlighted. [MANUAL] and the original size key you touched are highlighted.

If you wish to select an INCH size, touch the [AB/INCH] key and then touch the desired original size key.

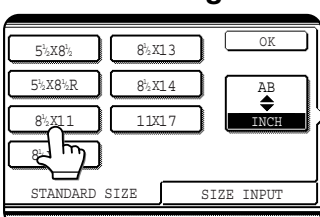

[INCH] is highlighted and INCH size keys are displayed. To return to the AB palette, touch the [AB/INCH] key once again.

If a non-standard size original is placed in the document feeder or on the document glass, touch the [SIZE INPUT] tab and then enter the X (width) and Y (length) dimensions of the original.

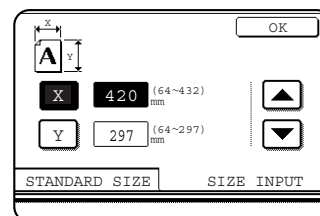

X is initially selected. Enter the X dimension (width) and then touch the Y key and enter the Y dimension (length). X can be from 64 to 432 mm, and Y can be from 64 to 297 mm.

If you frequently use originals that are the same non-standard size, you can store the size as explained in "STORING, DELETING, AND USING ORIGINAL SIZES" on the following page. This will save you the trouble of manually entering the size each time you use that original size.

3 Touch the [OK] key.

You will return to the initial screen.

4 The selected original size appears in the top half of the [ORIGINAL] key.

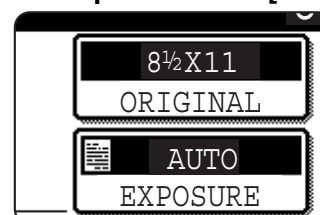

STORING, DELETING, AND USING ORIGINAL SIZES

Up to 9 special original sizes can be stored. Stored sizes can be easily called up and are not erased if the power is turned off. Storing a frequently used original size saves you the trouble of manually setting the size each time you copy that size of document.

- To cancel an original size storing, using, or deleting operation, touch the [ORIGINAL] key on the screen.

Storing or deleting an original size

- 1 Touch the [ORIGINAL] key.

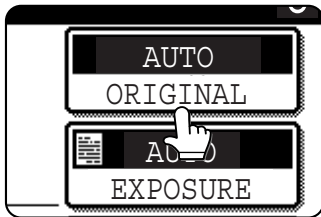

- 2 Touch the [CUSTOM SIZE] key.

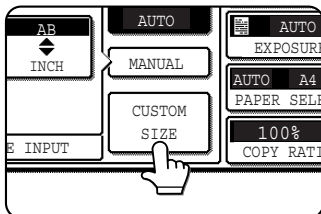

- 3 Touch the [STORE/DELETE] key.

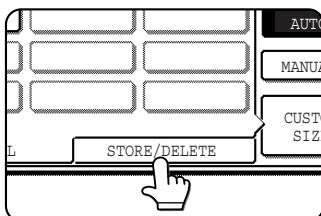

- 4 Touch the original size key () that you wish to store or delete.

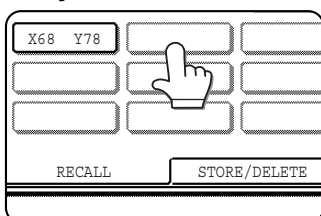

To store an original size, touch a key that does not show a size ().

Keys that already have an original size stored will show the stored size (X68 Y78).

To delete or change a stored size, touch the key that shows the size that you wish to delete or change.

- If you are storing an original size, go to step 5.
- To delete or change an original size, go to step 7.

- 5 Enter the X (width) and Y (length) dimensions of the original with the \uparrow \downarrow keys.

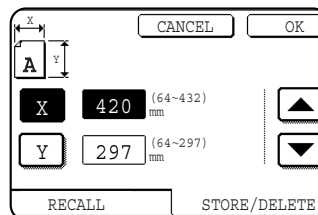

X (width) is initially selected.

Enter X and then touch the (Y) key to enter Y. A width of 64 to 432 mm can be entered in X, and a length of 64 to 297 mm

can be entered in Y.

- 6 Touch the [OK] key.

The original size entered in step 5 is stored in the key selected in step 4.

To exit, touch the [ORIGINAL] key.

- 7 When you touch a key that shows an original size in step 4, a message screen appears that contains the keys [CANCEL], [DELETE], and [STORE].

- To cancel the procedure, touch the [CANCEL] key.
- To delete the selected original size, touch the [DELETE] key.
- To change the original size stored in the key, touch the [STORE] key. The screen of step 5 will appear to let you change the size.

- 8 To exit, touch the [ORIGINAL] key.

■ USING A STORED ORIGINAL SIZE

- 1 Follow steps 1 to 2 of "STORING OR DELETING AN ORIGINAL SIZE".

- 2 Touch the original size key that you wish to use.

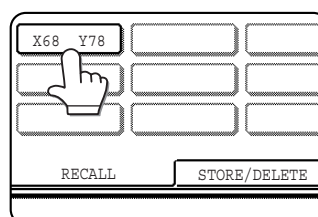

- 3 Touch the [OK] key.

The stored original size is called up.

NORMAL COPYING

This section describes the normal copying procedure.

Making copies with the automatic document feeding function

■ 1-sided copies of 1-sided originals

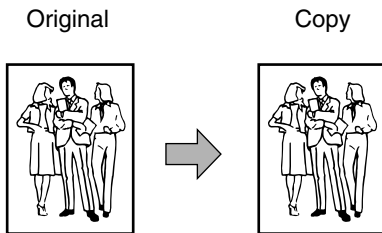

1 Place the originals in the document feeder tray. (pages 4-3 to 4-6)

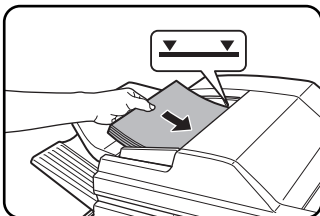

2 Ensure that the 1-sided to 1-sided copy mode is selected.

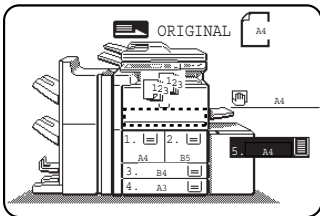

The one-sided to one-sided mode is selected when no icon for a two-sided mode appears in the dashed area on the display. If the 1-sided to 1-sided copy mode is already selected, steps 3 to 5 are not needed.

3 Touch the [2-SIDED COPY] key.

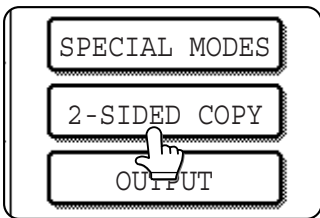

4 Touch the [1-sided to 1-sided copy] key.

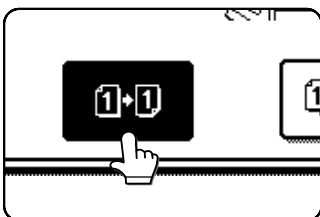

Touch the [1-sided to 1-sided copy] key.

5 Touch the [OK] key.

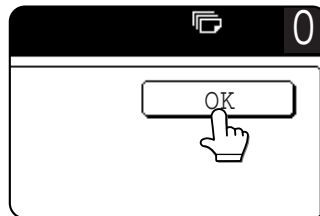

6 Ensure that paper of the same size as the originals is automatically selected*.

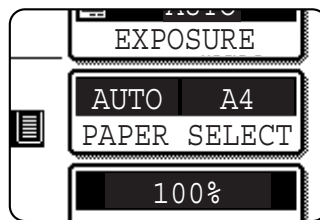

The selected tray will be highlighted or the message "LOAD xxxxxx PAPER." will appear. If the message appears, load paper in a paper tray with paper of the required size.

Even if the message above appears, copying can be performed onto the currently selected paper.

*The following requirements must be satisfied.

Originals of a standard size (A3, B4, A4, A4R, B5, B5R or A5 (11" x 17", 8-1/2" x 14", 8-1/2" x 11", 8-1/2" x 11"R or 5-1/2" x 8-1/2R")) are set and the auto paper select function is enabled.

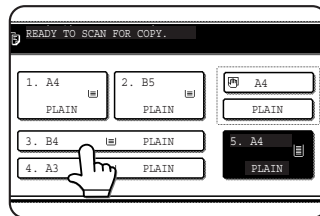

If originals of a size other than the sizes above are to be copied, manually select the desired paper size by touching the [PAPER SELECT] key and then touching the desired paper size selection key.

The selected key will be highlighted and the paper selection screen will close.

To close the paper selection screen without making a selection, touch the [PAPER SELECT] key.

7 Select the desired output mode (page 4-9).

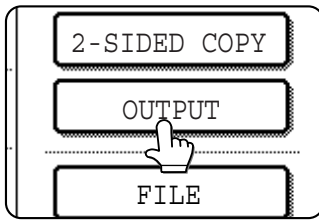

The sort mode is the default mode.

To select the group mode, touch the [OUTPUT] key, then touch the [GROUP] key on the output setting screen, and then touch the [OK] key on the setting screen.

8 Use the numeric keys to set the desired number of copies.

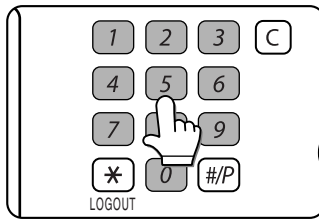

Up to 999 can be set.

If you are only making a single copy, the copy can be made with the copy number display showing "0". Use the [C] (clear) key to cancel an entry if

a mistake has been made.

9 Press the [START] key.

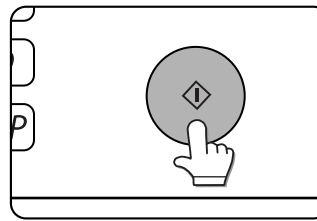

If the [C] key is pressed while originals are being scanned, scanning will stop. If copying had already started, copying and scanning will stop after the original in

progress is output to the original exit area. In these cases the copy quantity will be reset to "0".

NOTES

- The 1-sided to 1-sided copying mode is set as the default in the initial settings. If the default setting has not been changed using the "Initial status settings" (administrator settings), steps 3 to 5 on page 4-7 can be omitted.

To cancel copying...

To cancel a copy job in progress, press the [CA] key. A confirmation message will appear. Touch the [YES] key to cancel copying.

■ Copy output (sort and group)

Example: Making five sets or five copies each of three originals

● Sorting copies into sets

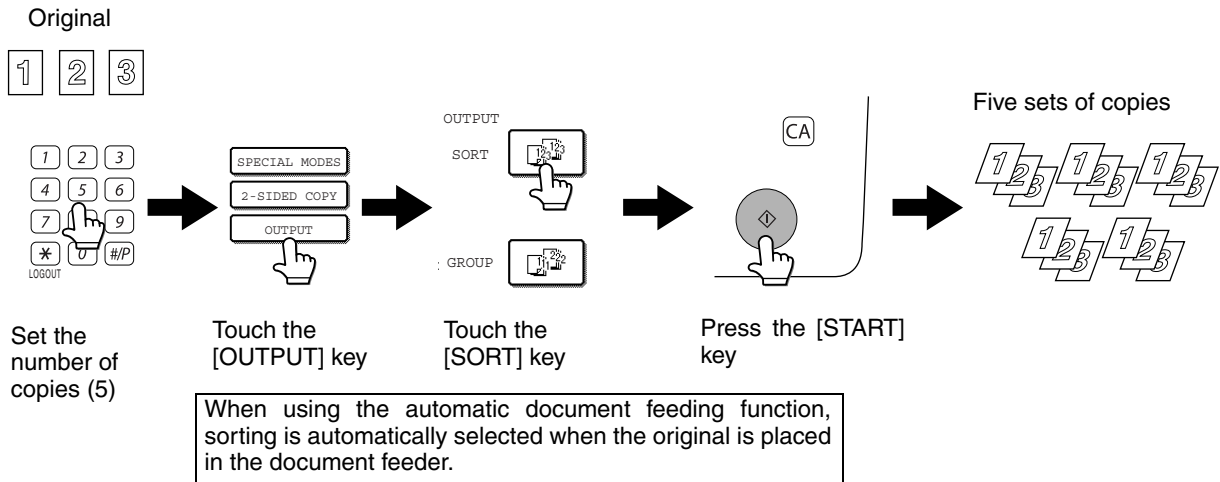

● Grouping copies by page

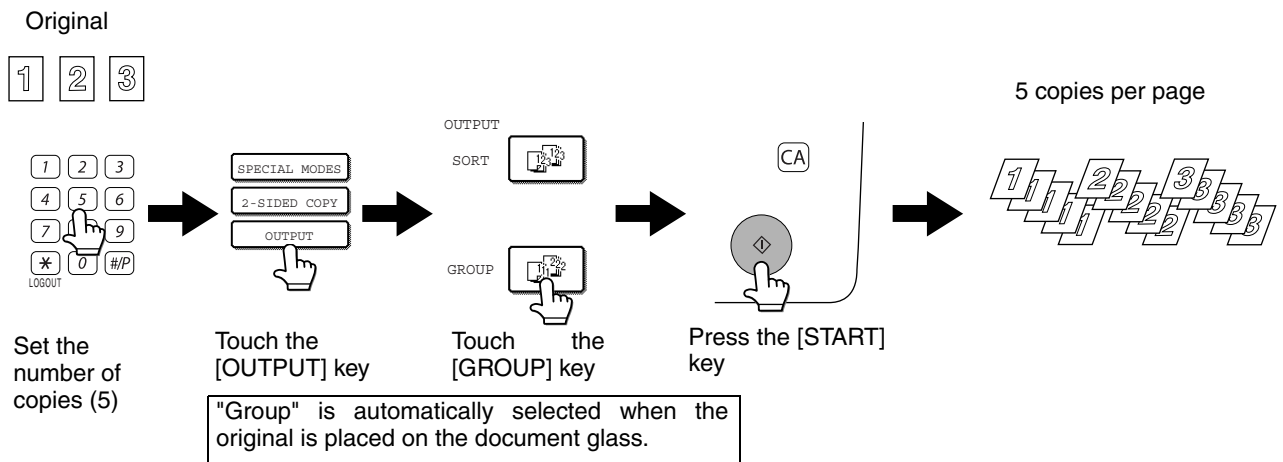

4

■ Selecting the output tray (when an optional finisher or saddle stitch finisher is installed)

When the [FINISHER TRAY] key is highlighted, output pages are delivered to the finisher tray of the finisher or saddle stitch finisher. When the "CENTRE TRAY" key is highlighted, output pages are delivered to the centre tray. Touch the appropriate key to select the desired output tray.

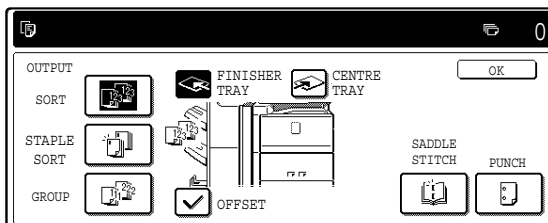

This screen appears when a saddle stitch finisher is installed. The screen that appears when a finisher is installed is slightly different.

Automatic two-sided copying using the automatic document feeding function

The machine can automatically copy two-sided originals, saving you the trouble of manually turning over each original page.

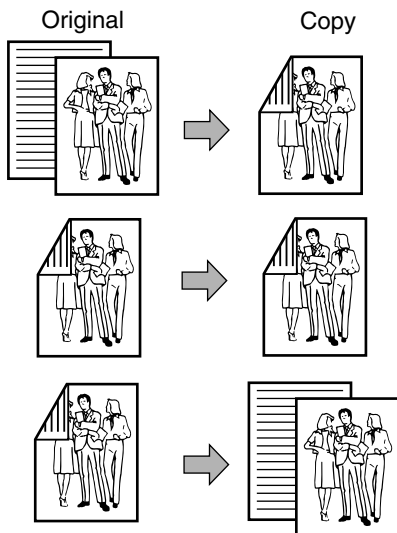

1. Automatic two-sided copying from one-sided originals
2. Automatic two-sided copying from two-sided originals
3. Automatic one-sided copying from two-sided originals

1 Place the originals in the document feeder tray. (pages 4-3 to 4-6)

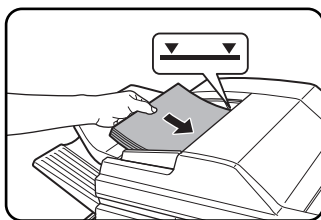

2 Touch the [2-SIDED COPY] key.

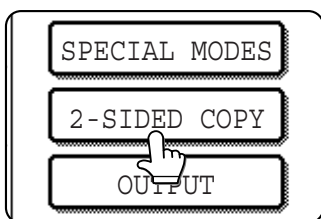

3 Select the desired copy mode.

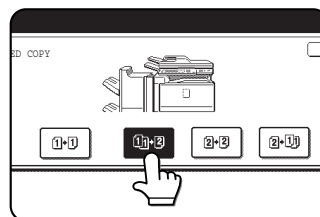

The display will vary depending on the equipment installed.

If a copy key is touched for a mode that cannot be selected, a double beep will sound.

Example of a portrait-oriented original

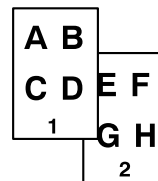

Example of a landscape-oriented original

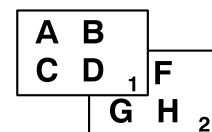

When making automatic two-sided copies of a one-sided A3 (11" x 17") or B4 (8-1/2" x 14") size portrait original, or when you wish to invert the top and bottom of the back side of a two-sided original, touch the [BINDING CHANGE] key.

4 Touch the [OK] key.



Perform steps 6 through 9 on pages 4-7 and 4-8.

Copying from the document glass

When copying originals which cannot be fed from the automatic document feeder such as thick originals, open the document cover and copy the originals from the document glass.

1-sided copies of 1-sided originals

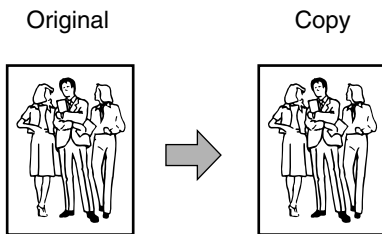

1 Place the original on the document glass. (pages 4-3 to 4-6)

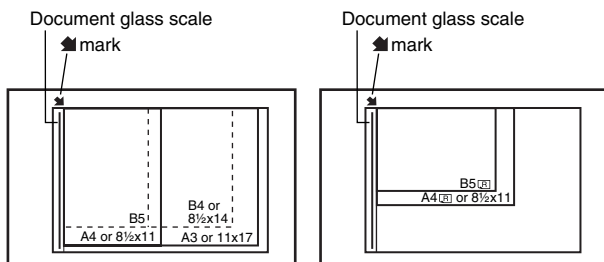
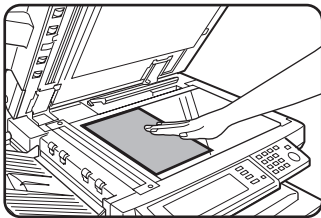

- Align the corner of the original with the tip of the arrow mark ▲ on the document glass scale.
- Place the original in the appropriate position for its size as shown above.

2 Ensure that the 1-sided to 1-sided copy mode is selected.

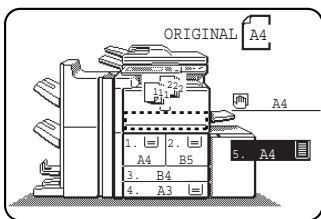

The one-sided to one-sided mode is selected when no icon for a two-sided mode appears in the dashed area on the display. If an icon appears, perform steps 3 to 5 on page 4-7 and then go to step 3.

3 Ensure that paper of the same size as the original is automatically selected*.

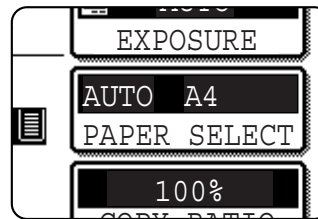

The selected tray will be highlighted or the message "LOAD xxxxxx PAPER." will appear. If the message appears, load paper in a paper tray with paper of the

required size.

Even if the message above is displayed, copying can be performed onto the currently selected paper.

* The following requirements must be satisfied.

Originals of a standard size (A3, B4, A4, A4R, B5, B5R or A5 (11" x 17", 8-1/2" x 14", 8-1/2" x 11", 8-1/2" x 11"R or 5-1/2" x 8-1/2"R)) are set and the auto paper select function is enabled.

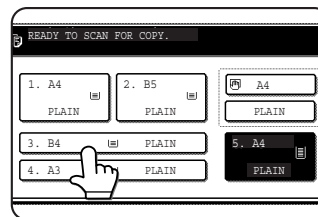

If originals of a size other than the sizes above are to be copied, manually select the desired paper size by touching the [PAPER SELECT] key and then touching the

desired paper size selection key.

The selected key will be highlighted and the paper selection screen will close. To close the paper selection screen without making a selection, touch the [PAPER SELECT] key.

4

4 Select the desired output mode. (page 4-9.)

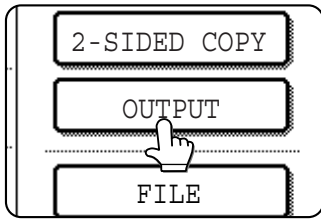

Group mode is the default mode.

To select sort mode, touch the [OUTPUT] key, touch the [SORT] key in the screen that appears, and then touch the [OK] key.

5 Use the numeric keys to set the desired number of copies.

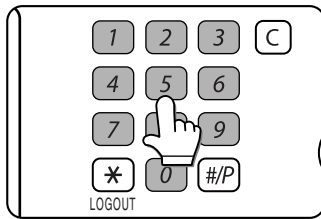

Up to 999 can be set. If you are only making a single copy, the copy can be made with the copy number display showing "0".

Use the [C] (clear) key to cancel an entry if a mistake has been made.

6 Press the [START] key.

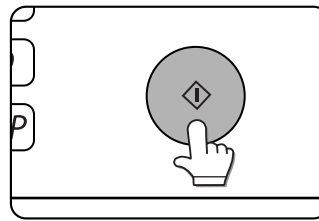

Replace the original with the next original and press the [START] key. Repeat this operation until all originals have been scanned.

If you selected "Sort" for the output mode in step 4 and pressed the [START] key, it is necessary to touch the [READ-END] key.

7 Touch the [READ-END] key.

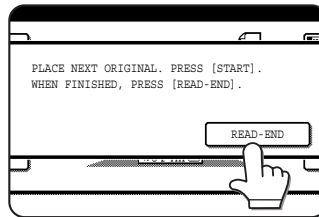

To cancel copying...

To cancel a copy job in progress, press the [CA] key. A confirmation message will appear. Touch the [YES] key to cancel copying.

Automatic two-sided copying from the document glass

The following two-sided copying function is possible. The copy paper is turned over automatically, allowing easy two-sided copying.

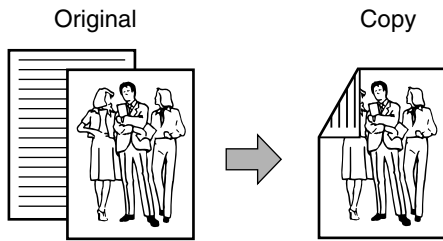

1 Place an original on the document glass. (pages 4-3 to 4-6)

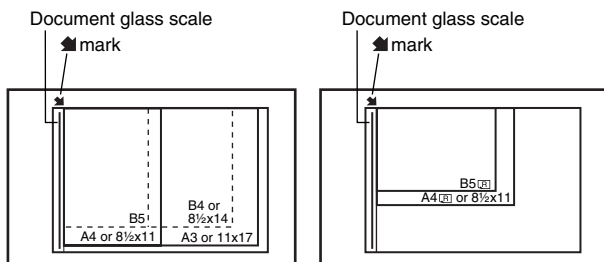
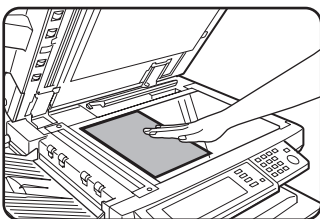

- Align the corner of the original with the tip of the arrow mark  on the document glass scale.
- Place the original in the appropriate position for its size as shown above.

2 Touch the [2-SIDED COPY] key.

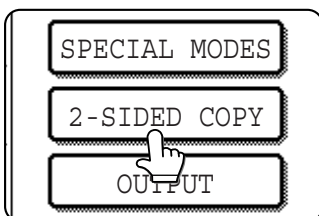

3 Touch the [1-sided to 2-sided copy] key.

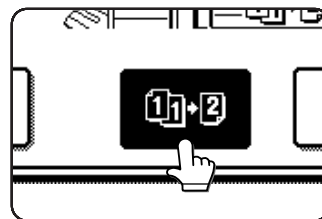

Example of a portrait-oriented original

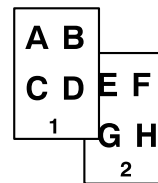

Example of a landscape-oriented original

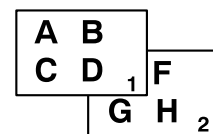

When making automatic two-sided copies of a one-sided A3 (11" x 17") or B4 (8-1/2" x 14") size portrait original, or when you wish to invert the top and bottom of the back side of a two-sided original, touch the [BINDING CHANGE] key.

4 Touch the [OK] key.

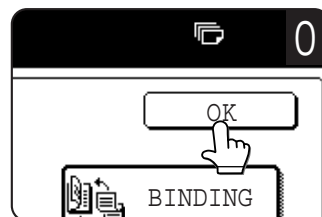

Perform steps 3 to 7 on pages 4-11 and 4-12.

ADJUSTING THE EXPOSURE

Select an appropriate exposure mode for the original to be copied. The selections are AUTO, TEXT, TEXT/PHOTO and PHOTO.

■ Automatic exposure adjustment

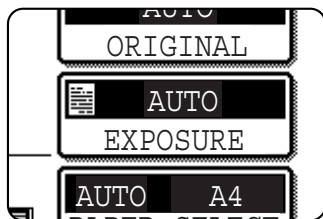

The default exposure setting is "AUTO", which automatically adjusts the exposure for the original. To select the exposure mode, or to manually adjust the exposure level, follow the steps below.

exposure level, follow the steps below.

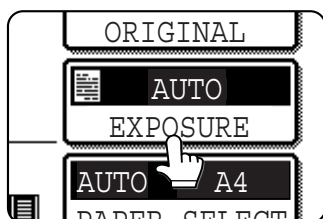

■ Selecting the exposure mode and manually adjusting the exposure level

1 Touch the [EXPOSURE] key.

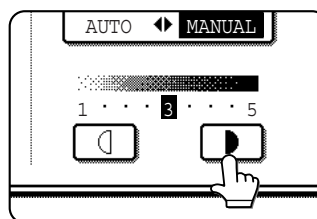

3 Adjust the exposure level.



Touch the  key to make darker copies. Touch the  key to make lighter copies.

2 Select [TEXT], [TEXT/PHOTO] or [PHOTO] as appropriate for the original to be copied.

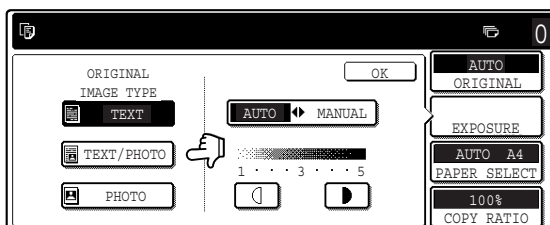

To select [TEXT], touch the [AUTO / MANUAL] key so that [MANUAL] is selected.

NOTE

Exposure levels in TEXT mode

- 1 to 2: Dark originals such as newspaper
- 3: Normal density originals
- 4 to 5: Originals written with pencils or light colour characters

Exposure modes selection

- TEXT:** This mode is useful for producing dark text copies with minimum background.
- TEXT/PHOTO:** This provides the best balance for copying an original which contains both text and photos. This mode is also useful for copying printed photographs.
- PHOTO:** This mode provides the best copies of photographs with fine details.

About the steps that follow

If an automatic document feeder is being used, see pages 4-7 through 4-10. If the document glass is being used, see pages 4-11 through 4-13.

NOTES

- To return to the automatic exposure mode, touch the [AUTO / MANUAL] key to highlight [AUTO], and then touch the [OK] key.
- The exposure level used in automatic exposure mode can be adjusted in the administrator settings. See "Exposure adjustment" on page 16 of the administrator settings guide.

REDUCTION/ENLARGEMENT/ZOOM

Reduction and enlargement ratios can be selected automatically or manually.

- Automatic selection: Auto image (see below)
- Manual selection: Preset copy ratios/zoom (see page 4-16)

Automatic selection (auto image)

The reduction or enlargement ratio will be selected automatically based on the original size and the selected paper size.

1 Place the original in the document feeder tray or on the document glass. (pages 4-3 to 4-6)

The detected original size will be displayed.

NOTE

Automatic ratio adjustment can only be used for the following original and paper sizes. It cannot be used for other sizes. However, in the case of non-standard original and paper sizes, the sizes can be entered to make automatic ratio adjustment possible for those sizes.

Original sizes: Standard sizes (see "Original size detection function" on page 4-3.)

Paper size: A3, B4, A4, A4R, B5, B5R, or A5R (11" x 17", 8-1/2" x 14", 8-1/2" x 11", 8-1/2" x 11"R, or 5-1/2" x 8-1/2"R)

2 Touch the [PAPER SELECT] key and then select the desired paper size.

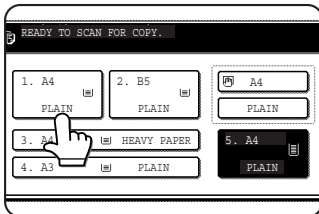

The selected paper size key is highlighted and the paper selection screen closes.

NOTE

If paper of the desired size is not loaded in any tray, load paper of the required size in a paper tray or the bypass tray. (See "Setting the paper type and paper size" on page 2-14.)

3 Touch the [AUTO IMAGE] key.

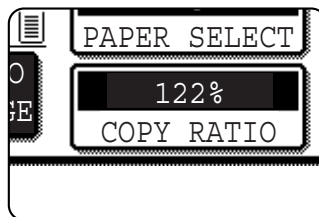
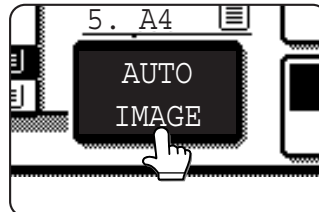

The [AUTO IMAGE] key will be highlighted and the best reduction or enlargement ratio for the original size and the selected paper size will be selected and

displayed in the copy ratio display.

NOTE

If the message "ROTATE ORIGINAL FROM [Landscape] TO [Portrait]" is displayed, change the orientation of the original as indicated in the message. When the message above is displayed, copying can be done without changing the orientation, but the image will not fit the paper correctly.

4 Use the numeric keys to set the desired number of copies.

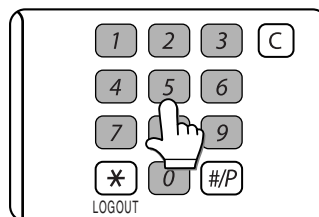

Up to 999 can be set. If you are only making a single copy, the copy can be made with the copy number display showing "0".

Use the [C] (clear) key to cancel an entry if a mistake has been made.

5 Press the [START] key.

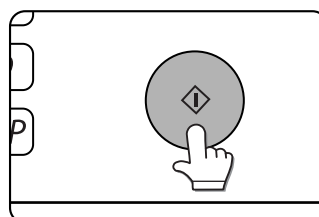

If you placed the original on the document glass, set the output mode to "Sort", and pressed the [START] key, you must touch the [READ-END] key after all pages of the original have been scanned. (Step 7 on page 4-12)

To cancel the auto image mode, touch the [CA] key.

Manual selection (preset copy ratios/zoom)

Five preset enlargement and five preset reduction copy ratios (max. 400%, min. 25%) can be selected. In addition, the zoom keys can be used to select any ratio from 25% to 400% in increments of 1%.

<The administrator settings on page 16 of the administrator settings guide can be used to set two additional enlargement ratios and two additional reduction ratios.>

1 Place the original in the document feeder tray or on the document glass. (pages 4-3 to 4-6)

NOTE

When the original is placed in the document feeder, the ratio can be set from 25% to 200%.

2 Touch the [COPY RATIO] key.

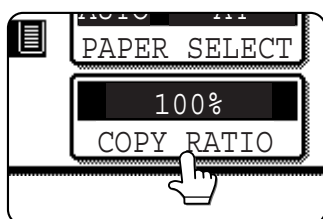

3 Use the [MENU] key to select menu "1" or menu "2" for copy ratio selection.

Menu 1

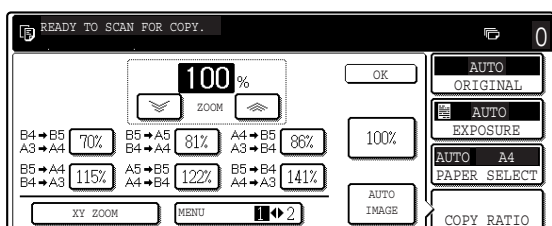

- A. Preset reduction copy ratios are:
70%, 81% and 86% (for the AB system).
77% and 64% (for the inch system).
- B. Preset enlargement copy ratios are:
115%, 122% and 141% (for the AB system).
121% and 129% (for the inch system).

Menu 2

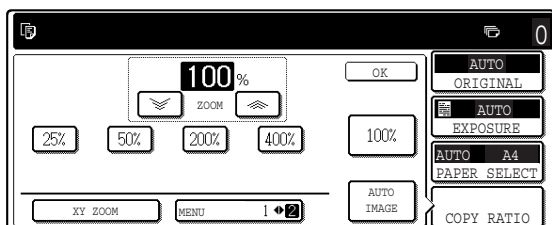

- A. Preset reduction copy ratios are:
50% and 25%.
- B. Preset enlargement copy ratios are:
200% and 400%.

(The custom ratios set by the administrator appear in ratio menu 2.)

4 Use the reduction, enlargement, and [ZOOM] keys on the touch panel to set the desired copy ratio.

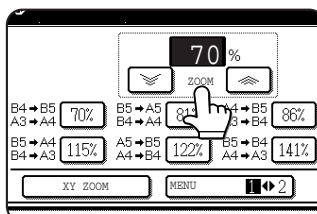
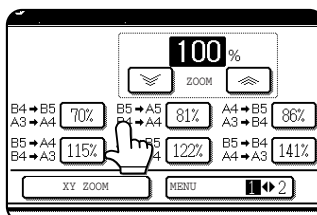

Zoom ratios: Any ratio from 25% to 400% can be set in 1% increments. Touch the [ZOOM] key to increase the ratio, or the [ZOOM] key to decrease the ratio. (If you continue to touch the [ZOOM]/[ZOOM] key, the ratio will change automatically. After 3 seconds, the ratio will change rapidly.)

NOTES

- Touch a reduction or enlargement key to set the approximate ratio, then touch the [ZOOM] key to increase the ratio or the [ZOOM] key to decrease the ratio.
- Automatic changing of the ratio when a zoom key is continuously touched can be disabled in the administrator settings (see "Key operation setting (prohibit key repeat)" on page 10 of the administrator settings guide).
- If the message "IMAGE IS LARGER THAN COPY PAPER." appears when a ratio is selected, the image may not fit on the copy paper.
- To set the horizontal and vertical copy ratios separately, use the XY ZOOM feature. See page 4-18.

5 Touch the [OK] key.

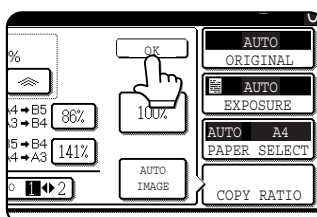

6 Make sure that an appropriate paper size has been selected based on the selected ratio.

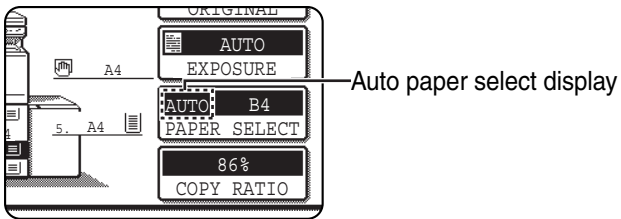

NOTE

If the auto paper select display does not appear, a tray with the correct size of paper for the selected ratio will not be automatically selected.

7 Use the numeric keys to set the desired number of copies.

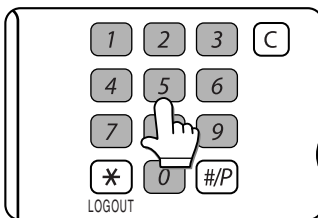

Up to 999 can be set. If you are only making a single copy, the copy can be made with the copy number display showing "0".

Use the [C] (clear) key to cancel an entry if a mistake has been made.

8 Press the [START] key.

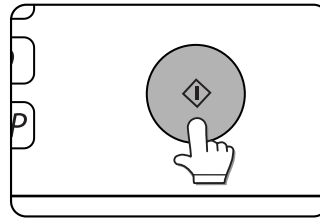

If you placed the original on the document glass, set the output to "Sort", and pressed the [START] key, you must touch the [READ-END] key after all pages of the original have been scanned. (Step 7 on page 4-12)

To return the ratio to 100%

To return the ratio setting to 100%, touch the [COPY RATIO] key to display the ratio menu and then touch the [100%] key. (Steps 2 and 3 on page 4-16.)

XY ZOOM

The XY ZOOM feature allows the horizontal and vertical copy ratios to be changed separately. The ratios can be set from 25% to 400% in increments of 1%.

Example: Selecting 100% for the length and 50% for the width

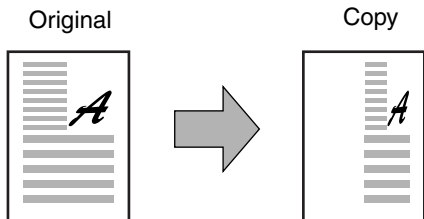

- 1 Place the original in the document feeder tray or on the document glass. (pages 4-3 to 4-6)

NOTE

When the original is placed in the document feeder, the ratio can be set from 25% to 200%.

- 2 Touch the [COPY RATIO] key.

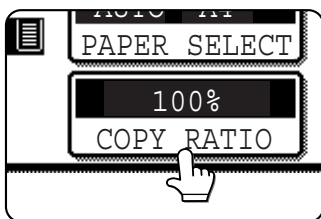

- 3 Touch the [XY ZOOM] key.

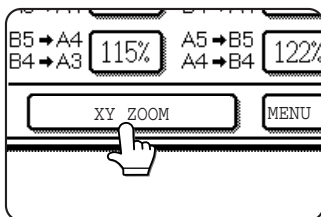

- 4 Touch the [X] key.

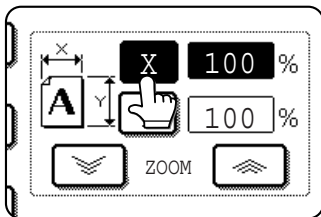

The initial state of the [X] key is selected (highlighted), so this step normally is not necessary. Touch the [X] key only if it is not highlighted yet.

- 5 Use the reduction, enlargement, and ZOOM ([⏏], [⏏]) keys to change the copy ratio in the horizontal (X) direction.

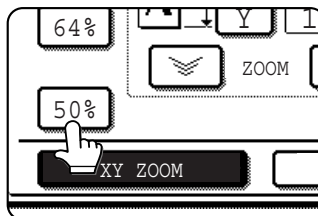

A fixed ratio key will not become highlighted when touched.

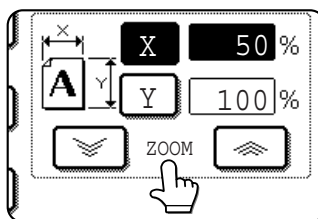

Zoom ratios: Any ratio from 25% to 400% can be set in 1% increments.

Touch the [⏏] key to increase the ratio, or the [⏏] key to decrease the ratio. (If you continue



to touch the [⏏]/[⏏] key, the ratio will change automatically. After 3 seconds, the ratio will change rapidly.)

NOTES

- Touch a reduction or enlargement key to set the approximate ratio, then touch the [⏏] key to increase the ratio or the [⏏] key to decrease the ratio.
- Automatic changing of the ratio when a zoom key is continuously touched can be disabled in the administrator settings (see "Key operation setting (prohibit key repeat)" on page 10 of the administrator settings guide).

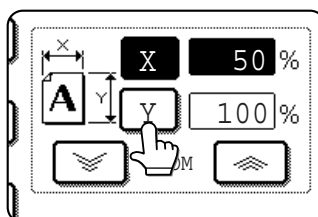
- 6 Touch the [Y] key.



7 Use the reduction, enlargement, and ZOOM ([, [) keys to change the copy ratio in the vertical (Y) direction.

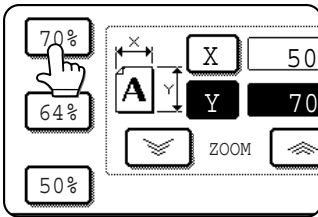

A fixed ratio key will not become highlighted when touched.

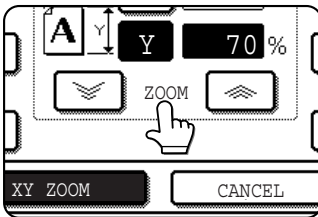

The zoom keys can be used to change the ratio from 25% to 400% in increments of 1%. If needed, you can touch the [X] key once again to readjust the X zoom.

8 Touch the [OK] key.

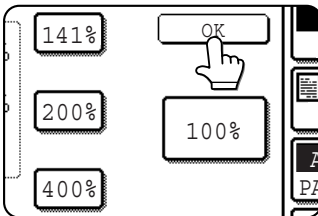

9 If needed, touch the [PAPER SELECT] key and select the paper size.

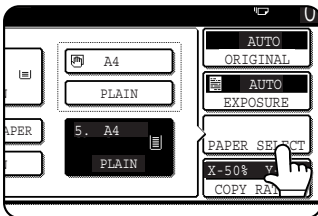

If the AUTO PAPER SELECT mode is on, the appropriate copy paper size will have been automatically selected based on the original size and selected copy ratios.

10 Select any desired copy settings such as the exposure or number of copies, and then press the [START] key.

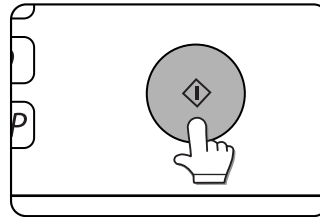

To cancel an X or Y zoom setting...
Touch the [XY ZOOM] key or the [CANCEL] key in the ratio selection screen (step 3 or 5 on page 4-18).

SPECIAL PAPERS

Special papers including transparency film, postcards and tabbed paper must be fed through the bypass tray.

- 1 Place the original in the document feeder tray or on the document glass. (pages 4-3 to 4-6)

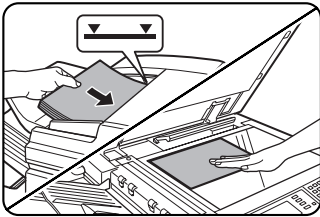

- 2 Load the special paper in the bypass tray.

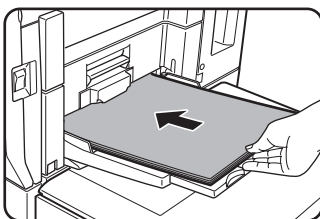

See page 2-12 for the specifications of paper that can be used in the bypass tray. For the paper loading instructions, see "Loading paper in the bypass tray" (page 2-10).

- 3 Touch the [PAPER SELECT] key.

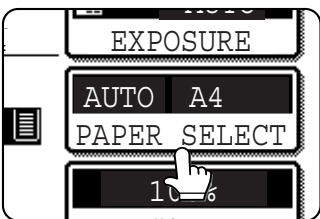

- 4 Set the type and size of paper loaded in the bypass tray.

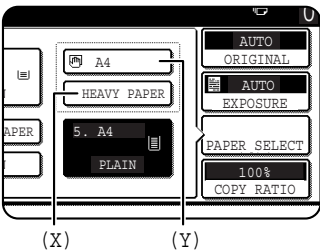

- ① The (X) key shows the currently selected paper type.
- ② The (Y) key shows the size of paper loaded in the bypass tray.

- ③ To change the displayed paper type, touch the (X) key before touching the (Y) key. When loading paper, if you changed the paper size from an AB size to an inch size (or from an inch size to an AB size), or if you changed the paper type, be sure to change the paper type and size settings as explained in steps 5 to 7 on page 2-14, and steps 8 to 10 on page 2-15.

- 5 Select the bypass tray.

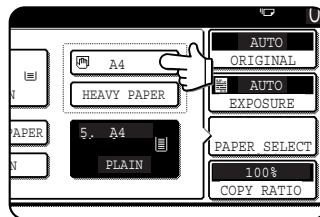

- 6 Select any desired copy settings such as the exposure or number of copies, and then press the [START] key.

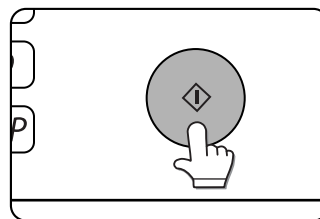

When copying from the document glass in the sort mode using the [START] key, touch the [READ-END] key after all originals have been scanned (step 7 on page 4-12).



CHAPTER 5

CONVENIENT COPY FUNCTIONS

This chapter explains special-purpose functions, storing of copy settings, and other convenient functions. Please select and read sections of this chapter as needed.

	Page
SPECIAL MODES.....	5-2
• General procedure for using special functions	5-2
• Margin shift.....	5-3
• Erase.....	5-4
• Dual page copy	5-5
• Pamphlet copy.....	5-6
• Job build.....	5-8
• Tandem copy	5-10
• Covers/inserts	5-12
• Transparency film with insert sheets	5-23
• Multi shot.....	5-24
• Book copy	5-26
• Tab copy	5-27
• Card shot.....	5-29
• Mirror image.....	5-31
• B/W reverse.....	5-31
• Print menu.....	5-32
STORING, USING AND DELETING JOB PROGRAMS	5-44
• Storing a job program.....	5-44
• Calling up a job program	5-45
• Deleting a stored job program.....	5-45
INTERRUPTING A COPY RUN	5-46

SPECIAL MODES

Touch the [SPECIAL MODES] key in the main screen of copy mode to open the special modes screen. The following functions can be selected in the special modes screen.

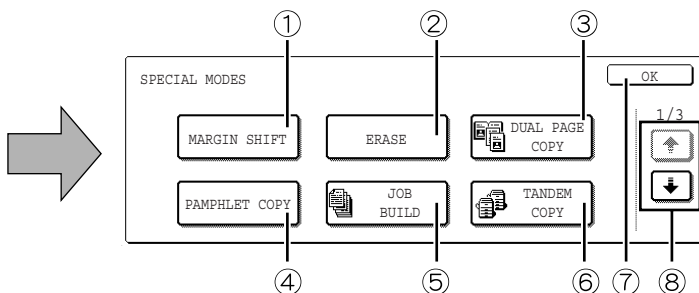
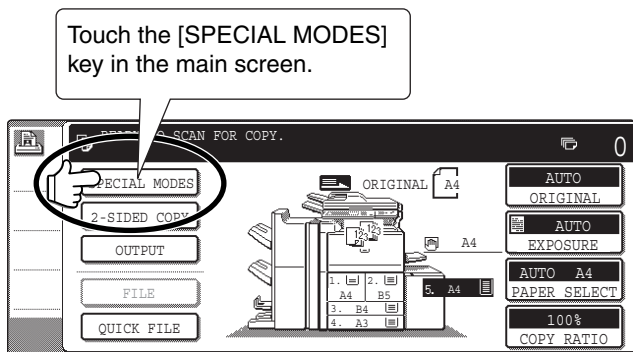

- ① **Margin shift (page 5-3)**
- ② **Erase (page 5-4)**
- ③ **Dual page copy (page 5-5)**
- ④ **Pamphlet copy (page 5-6)**
- ⑤ **Job build (page 5-8)**
- ⑥ **Tandem copy (page 5-10)**
- ⑦ **[OK] key on the special modes screen**
Touch the [OK] key to return to the main screen of copy mode.
- ⑧ **↑ / ↓ key**
Touch these keys to change the special modes screen.

There are three special modes screens.
Touch the key to change to the other two screens.

- The following special functions can be selected in the 2nd screen (2/3).
 - Covers/inserts (page 5-12)**
 - Transparency inserts (page 5-23)**
 - Multi shot (page 5-24)**
 - Book copy (page 5-26)**
 - Tab copy (page 5-27)**
 - Card shot (page 5-29)**
- The following special functions can be selected in the 3rd screen (3/3).
 - Mirror image (page 5-31)**
 - Print menu (page 5-32)**
 - B/W reverse (page 5-31)**

General procedure for using special functions

1 Touch the [SPECIAL MODES] key.

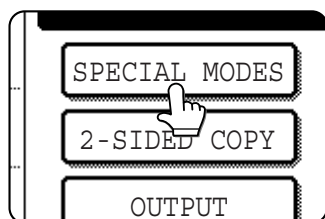

2 Touch the key for the desired special mode.

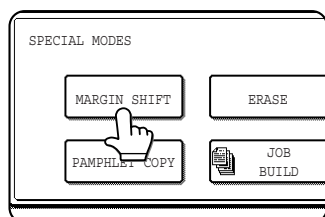

Example:
Selecting the margin shift function

To select a special function in one of the other two screens, use the / keys to change the screen.

Setting procedures for modes requiring setting screens start on the next page.
The dual page copy, job build, tandem copy, mirror image and B/W reverse functions do not require setting screens.

Margin shift

The margin shift function will automatically shift the text or image on the copy paper approximately 10 mm (1/2") in its initial setting.

This function is convenient when stapling or binding copies with a string.

NOTE

The initial setting for the margin width can be changed in the administrator settings to any value from 0 to 20 mm (0" to 1") (page 16 of the administrator settings guide).

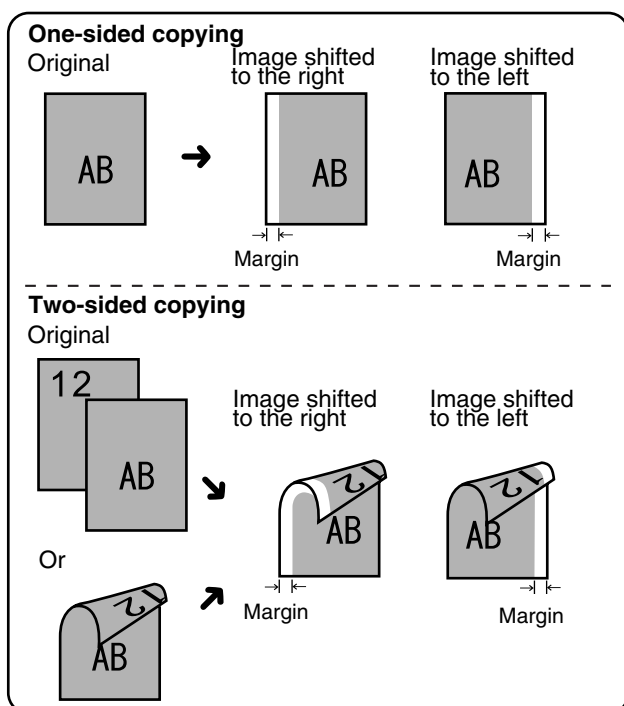

- The shift direction can be selected from right or left shift as shown in the illustration.

5

To display the special modes screen...

See "General procedure for using special functions" on page 5-2.

1 Touch the [MARGIN SHIFT] key on the special modes screen.

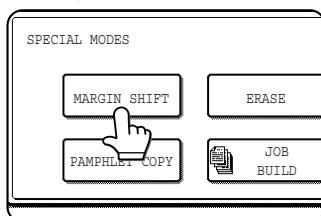

The margin shift setting screen will appear.

The margin shift icon () will also appear in the upper left of the screen to indicate that the function is turned on.

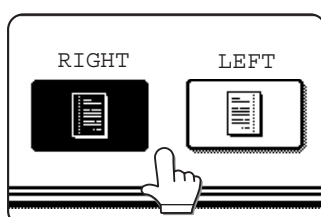

2 Select the shift direction.

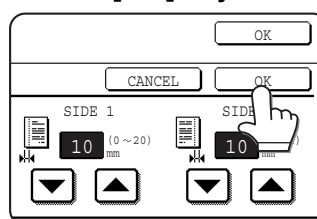

Touch a shift direction key to select right or left. The selected key will be highlighted.

3 Set the shift amount as needed and touch the [OK] key.



Use the  and the  keys to set the shift amount. The shift amount can be set from 0 to 20 mm in 1 mm (0" to 1" in 1/8") increments.

4 Touch the [OK] key on the special modes screen.

You will return to the main screen of copy mode.

About the steps that follow

If an automatic document feeder is being used, see pages 4-7 through 4-10. If the document glass is being used, see pages 4-11 through 4-13.

To cancel the margin shift function, touch the [CANCEL] key on the margin shift setting screen (step 3).

Erase

The erase function is used to erase the shadow lines on copies produced when copying thick originals or books. The erase modes that can be selected are shown below. The erase width is approximately 10 mm (1/2") in its initial setting.

NOTE

The initial setting for the erasure width can be changed in the administrator settings to any value from 0 to 20 mm (0" to 1") (page 16 of the administrator settings guide).

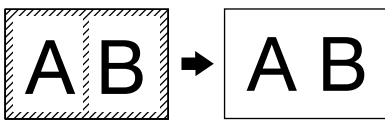
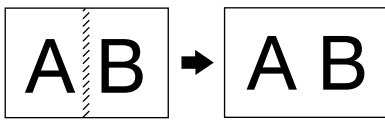
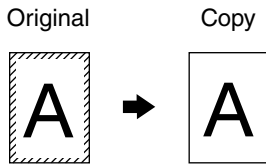

EDGE ERASE

Eliminates shadow lines around the edges of copies caused when heavy paper or a book is used as an original.

CENTRE ERASE

Eliminates shadow lines produced by the bindings of bound documents.

EDGE + CENTRE ERASE

Eliminates shadow lines around the edges of copies and eliminates the shadow at the centre of copies.

To display the special modes screen...
See "General procedure for using special functions" on page 5-2.

1 Touch the [ERASE] key on the special modes screen.

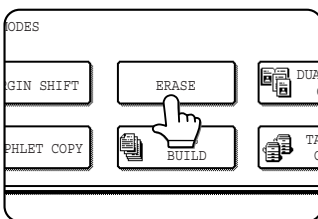

The erase setting screen will appear. The erase icon (🗑️) will also appear in the upper left of the screen to indicate that the function is turned on.

2 Select the desired erase mode.

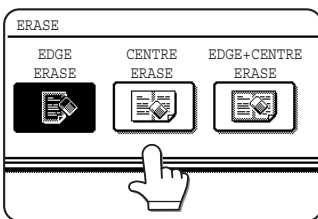

Select one of the three erase modes. The selected key will be highlighted.

3 Adjust the amount of erase and touch the [OK] key.

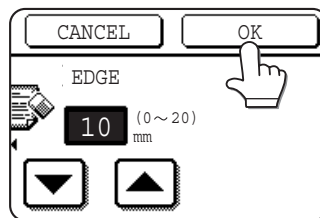

Use the ▼ and ▲ keys to set the erase width to any value from 0 to 10 mm in increments of 1 mm (0" to 1" in 1/8").

4 Touch the [OK] key on the special modes screen.

You will return to the main screen of copy mode.

About the steps that follow

If an automatic document feeder is being used, see pages 4-7 through 4-10. If the document glass is being used, see pages 4-11 through 4-13.

NOTE

When erase is used, edge erase takes place at the edges of the original image. If you also use a ratio setting, the edge erase width will change according to the set ratio.

To cancel the erase function, touch the [CANCEL] key on the erase setting screen (step 3).

Dual page copy

The dual page copy function produces separate copies of two documents placed side by side on the document glass. This function is especially useful when copying books and other bound documents.

[Example] Copying right and left pages of a book

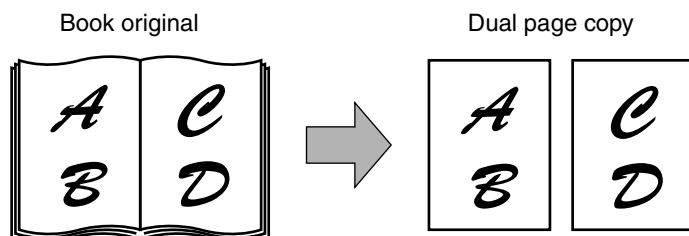

- The dual page copy function can be used only when copying from the document glass. The automatic document feeder cannot be used with this function.
- Only 8-1/2" x 11" (A4) paper can be used.

To display the special modes screen...

See "General procedure for using special functions" on page 5-2.

1 Touch the [DUAL PAGE COPY] key on the special modes screen.

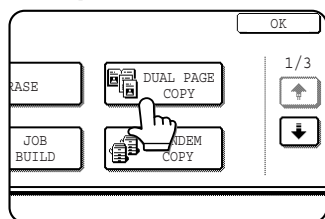

The [DUAL PAGE COPY] key will be highlighted to indicate that the function is turned on, and the dual page copy icon (📄📄) will appear in the upper left of the screen.

2 Touch the [OK] key on the special modes screen.

You will return to the main screen of copy mode.

3 Place the originals on the document glass.

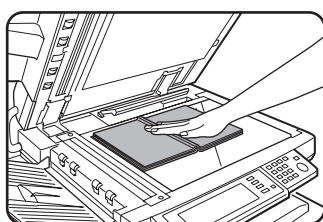

When copying a thick book, press down lightly on the book to flatten it against the document glass.

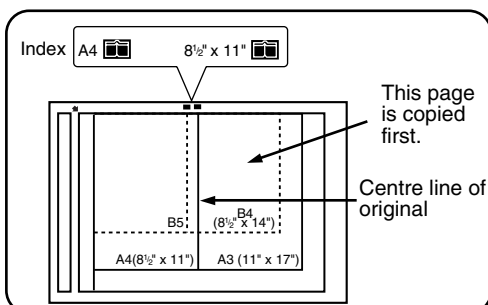

Place the opened original on the document glass so that the first page you wish to copy is on the right and the centre of the original is aligned with the size mark.

4 Ensure that A4 (8-1/2" x 11") size paper is selected.

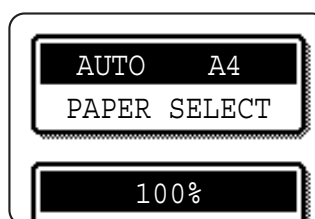

If A4 (8-1/2" x 11") size paper is not selected, touch the [PAPER SELECT] key to select A4 (8-1/2" x 11") size paper.

About the steps that follow

For two-sided copying, follow steps 2 through 4 on page 4-13 and then follow steps 4 through 6 on page 4-12.

For one-sided copying, follow steps 4 through 6 on page 4-12.

NOTE

To erase shadows caused by document binding, use the edge erase function (page 5-4). (Centre Erase and Edge + Centre Erase cannot be used in combination.)

To cancel the dual page copy function, touch the [DUAL PAGE COPY] key on the special modes screen (screen of step 1).

Pamphlet copy

The pamphlet copy function is used to arrange copies in proper order for eventual centre-stapling and folding into a booklet. Two original pages are copied onto each side of copy paper. Four pages are, therefore, copied onto one sheet. This function is convenient for arranging copies into an attractive booklet or pamphlet.

NOTE

To make pamphlet copies of a book or other bound original, use the book copy function (page 5-26). The book copy function scans the opened original in two-page units. (Two pages are scanned at each scan, reducing the number of repetitions of the scanning operation by a half.)

[Example] Copying eight originals in the pamphlet copy mode

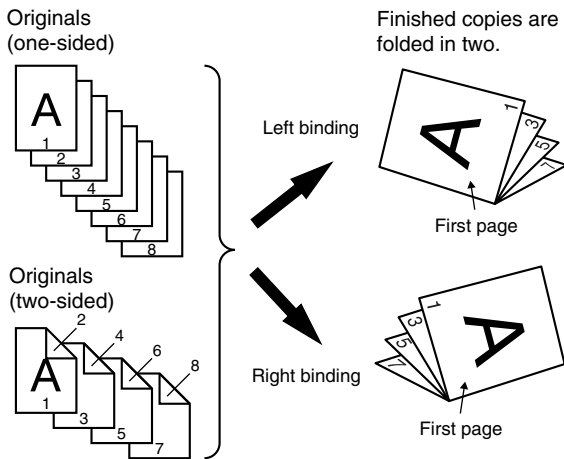

- Scan the originals from the first page to the last page. The order of copying will be automatically adjusted by the machine.
- Either left binding (right to left turning) or right binding (left to right turning) can be selected.
- Four originals will be copied onto one sheet. Blank pages may be automatically produced at the end depending on the number of the originals.
- If a saddle stitch finisher is installed, copies can be stapled in two positions along the centre of copies and folded at the centre.

To display the special modes screen...
See "General procedure for using special functions" on page 5-2.

1 Touch the [PAMPHLET COPY] key on the special modes screen.

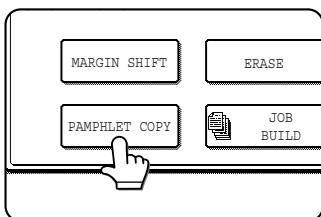

The PAMPHLET COPY setting screen will appear. The pamphlet copy icon (📄), etc.) will also appear in the upper left corner of the screen to indicate that the function is turned on.

2 Designate the type of originals to be copied: 1-sided or 2-sided.

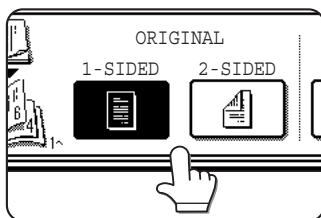

Select the [2-SIDED] key if you wish to scan a two-sided original using the automatic document feeding function.

3 Select the binding position (left binding or right binding).

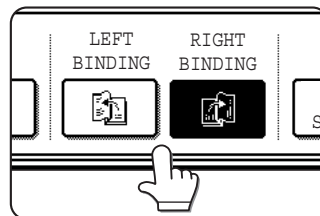

If you wish to insert a different type of paper for use as a cover, follow steps 4 through 12 below.

If you do not wish to insert paper for a cover, continue from step 8 on the next page.

4 Touch the [COVER SETTING] key.

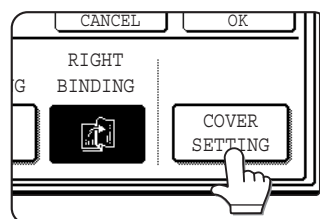

5 Select whether or not you wish to copy on the cover ("YES" or "NO").

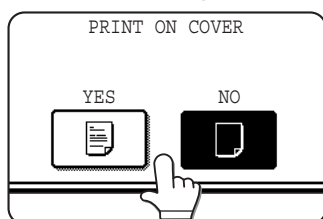

6 Select the paper tray for the cover.

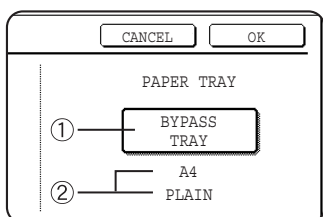

① The currently selected paper tray for the cover is displayed.

② The size and type of paper in the currently selected tray is displayed.

In the example screen above, A4 (8-1/2" x 11") size plain paper is loaded.

To change the paper tray for the cover, touch the tray selection key. (In the screen example, the "BYPASS TRAY" display is the tray selection key.)

The tray selection screen appears when the tray selection key is touched. Select the desired tray in this screen.

NOTES

- When the cover paper is fed from the inserter, the cover cannot be copied on.
- Two-sided copying is not possible on label sheets, transparency film, and tabbed paper. When copying on a cover, do not select a tray that has one of these types of paper.

7 Touch the [OK] key.

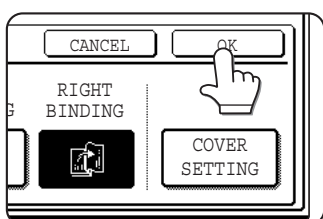

8 Touch the [OK] key.

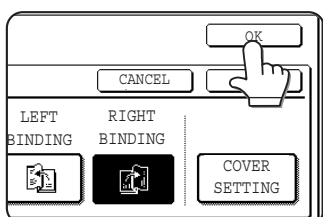

Return to the main screen of copy mode.

9 Place the original in the document feeder or on the document glass. (page 4-3)

10 Ensure that the desired paper size has been automatically selected based on the original size.

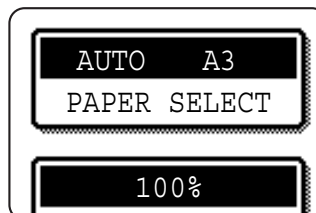

To select another size paper, select the desired size and touch the [AUTO IMAGE] key. The appropriate copy ratio will be selected automatically based on

the original size and the paper size. (See steps 2 and 3 on page 4-15.)

11 Select any desired copy settings such as the exposure or number of copies, and then press the [START] key.

12 [When using the automatic document feeder:]

Copying will start after all originals have been scanned. (The next step is not needed.)

[When using the document glass:]

Replace the original with the next original and press the [START] key. Repeat this operation until all originals have been scanned and then touch the [READ-END] key.

NOTES

- When the pamphlet copy function is set, the two-sided copying mode will be automatically selected.
- If this function is used in combination with the pamphlet copy function (pamphlet stapling) and the number of original pages exceeds the number of pages that can be stapled, a message asking you to select "CANCEL", "CONTINUE", or "DIVIDE" will appear.

To cancel the job, select "CANCEL". To make pamphlet copies without stapling, select "CONTINUE". To divide the pages into sets that can be stapled, select "DIVIDE".

If you performed steps 4 to 6 to insert cover paper, divided stapling is not possible. You can either continue pamphlet copying without stapling, or cancel the job.

To cancel the pamphlet copy function, touch the [CANCEL] key on the pamphlet copy setting screen (step 2).

Job build

Use job build mode when you need to copy more original pages than can be loaded at once in the document feeder (the maximum number of pages that can be loaded is 150). This function allows the original pages to be scanned in sets.

[Example] Copying 300 pages of A4 originals

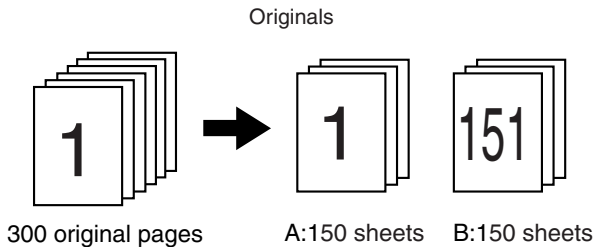

*Divide the originals into sets of 150 pages each.
Scan the originals starting from the first page of set A. Scan set B next, taking care to keep the correct page order.

To display the special modes screen...
See "General procedure for using special functions" on page 5-2.

1 Touch the [JOB BUILD] key on the special modes screen.

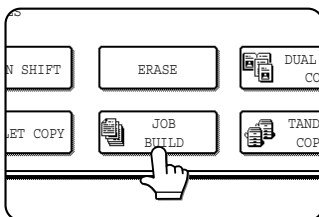

The [JOB BUILD] key will be highlighted to indicate that the function is turned on, and the job build icon (📄) will appear in the upper left of the screen.

2 Touch the [OK] key on the special modes screen.

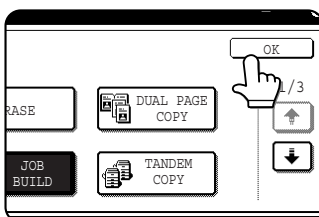

Return to the main screen of copy mode.

3 Place the first set of originals in the document feeder tray. (page 4-3)

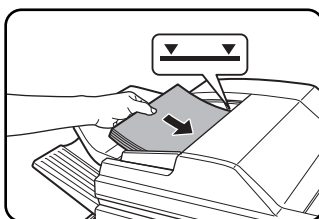

4 Make sure that the desired paper size is selected, select the number of copies or other copy settings, and press the [START] key.

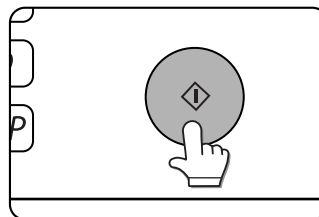

Scanning of originals will start. After scanning of the first set of originals (A in the example above) is completed, remove the scanned originals, place the next set of originals

(set B in the example) and press the [START] key. Repeat this operation until all sets of originals have been scanned.

If you wish to adjust the copy settings each time you place a set of originals, see "Changing the copy settings for each set of originals" on the next page.

5 Touch the [READ-END] key.

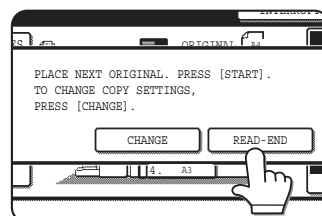

To cancel the job build function, touch the [JOB BUILD] key on the special modes screen (step 1). The highlighted display will be cancelled.

■ Changing the copy settings for each set of originals

When using job build mode, you can change the copy settings each time you place a set of originals. After performing step 4 on page 5-8, follow the steps below.

5 Touch the [CHANGE] key.

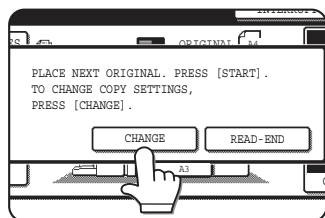

7 Touch the [READ-END] key.

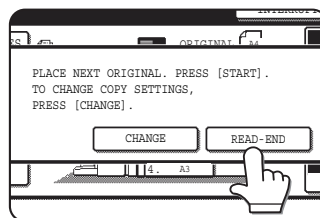

6 Select the desired copy settings in the screen that appears and press the [START] key.

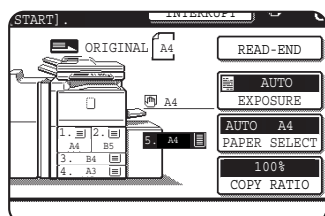

The copy settings that can be selected are "EXPOSURE", "PAPER SELECT", and "COPY RATIO".

If you touch the [READ-END] key now, copying will begin without scanning the new set of originals.

NOTES

- If the original size was set manually at the beginning of the job build procedure, it will not be possible to change the original size setting. If the automatic original detection function is operating, the original size will be detected for each set of originals placed.
- When the bypass tray is selected, it is not possible to change the paper type.
- If "XY ZOOM" was initially set for the ratio, it will not be possible to change the ratio setting.
- When job build mode is used in combination with any of the following functions, the [CHANGE] key will not appear in the screen of step 5.
Pamphlet copy, tandem copy, covers/inserts, transparency inserts, multi-shot, book copy, tab copy, staple sort, saddle stitch

Tandem copy

Two machines connected to the same network can be used to run a large copy job in parallel.

By dividing the job in half, approximately half the time is required to complete the job.

To use this function, two machines must be connected to your network as network printers. Even if more machines are connected to the network, this function can only be used to have one other machine share a job.

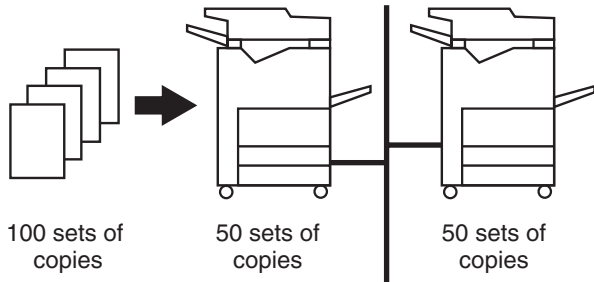

Server machine and client machine

- In the following explanations, the machine on which the copy job is initially set up and tandem copy selected is called the server machine. The other machine that is asked to share the job is called the client machine.
- To use the tandem copy function, the tandem settings must be configured in the administrator settings. (See page 14 of the "Administrator settings guide")
- When configuring the tandem settings in the server machine, the IP address of the client machine must be entered. For the port number, it is best to use the initial setting (50001). Unless you experience difficulty with this setting, do not change it. The tandem settings should be configured by your network administrator. If the server and client machines will alternate server and client roles, the IP address of the server machine must also be entered in the client machine. The same port number can be set in both machines.

To display the special modes screen...
See "General procedure for using special functions" on page 5-2.

1 Touch the [TANDEM COPY] key on the special modes screen.

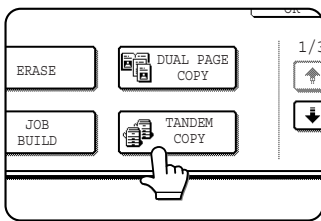

The [TANDEM COPY] key will be highlighted to indicate that the function is turned on, and the tandem copy icon (📄) will appear in the upper left of the screen.

2 Touch the [OK] key on the special modes screen.

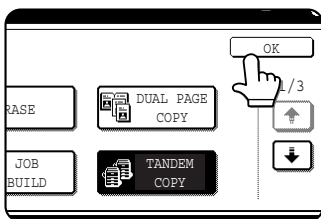

You will return to the main screen of copy mode.

3 Set the number of copies with the numeric keys.

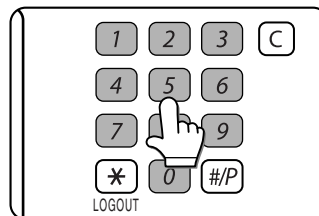

Up to 999 copies can be set. When the [START] key is pressed, the copies will automatically be divided between the server and client machines. If an odd

number of copies is set, the server machine will make the extra set.

If an incorrect number of copies is set...
Press the clear key and set the correct number of copies.

4 Place the original in the document feeder or on the document glass. (page 4-3)

5 Press the [START] key.

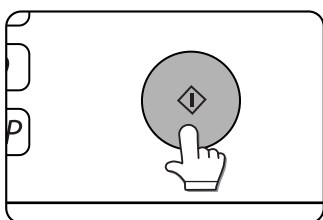

To cancel the tandem copy function, touch the [TANDEM COPY] key on the special modes screen (step 1). The highlighted display will be cancelled.

NOTES

- To perform tandem copying, the server machine and client machine must meet certain conditions. After the [START] key is pressed on the server machine, the server machine verifies that the conditions have been met. If the conditions have not been met, tandem copying does not begin and "TANDEM OUTPUT IS NOT ALLOWED. OUTPUT ALL SETS USING MASTER MACHINE?" appears in the display. To have the server machine make all the copies, touch the [OK] key. To cancel the job, touch the [CANCEL] key.
 - As an example, the following conditions must be met when a staple finisher is installed on the server machine and not on the client machine:
 - (1) If tandem copying is executed for a two-sided copy job with the number of copies set to 999 and "Non-staple" is selected, tandem copying will take place.
 - (2) If tandem copying is executed for a two-sided copy job with the number of copies set to 999 and "Staple" is selected, tandem copying will not take place because the client machine does not have a finisher.
- After the [START] key is pressed, if the client machine cannot print because it is out of paper or other reason, the server machine will print its half of the job. The other half of the job will be stored in the client machine and the job will be printed when the client machine is able to print.
- If auditing mode is enabled on both the server and client machines, the same account number must be entered on both machines.
- If auditing mode is enabled on the client machine but not on the server machine, tandem copying cannot be performed.

Covers/inserts

A different type of paper can be inserted in positions corresponding to front and back covers of a copy job when the automatic document feeding function is used. A different type of paper can also be automatically added as an insert at specified pages.

As an example, tabbed paper can be added as inserts at the beginning of chapters or at other pages to create an indexed document.

- Covers/inserts can be disabled in the administrator settings (page 11 of the administrator settings guide).

Example of adding covers

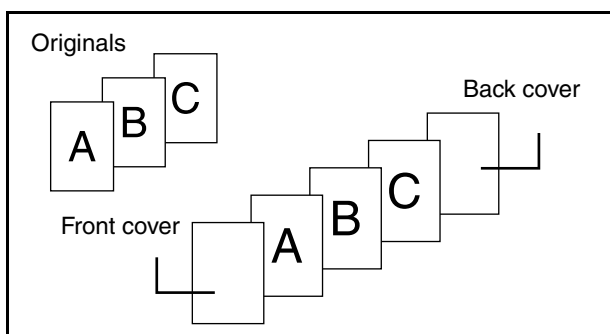

Example of adding inserts

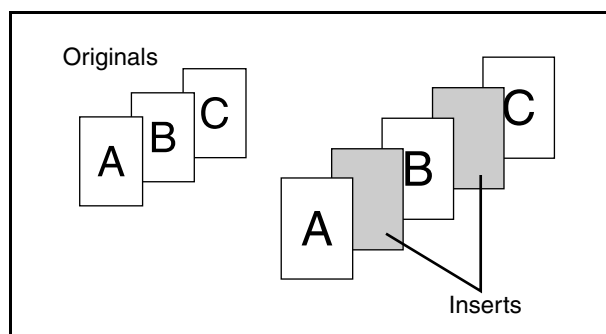

Example of adding covers and inserts

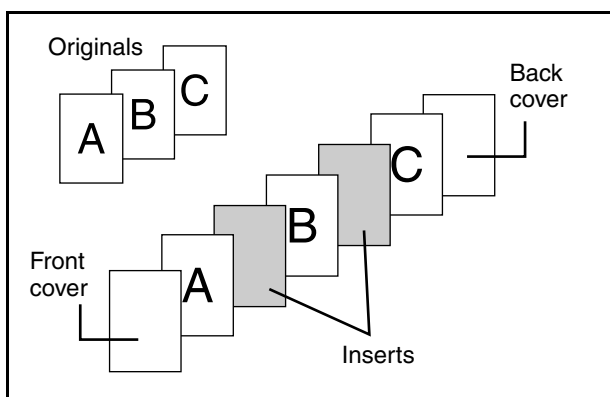

About the explanations of covers and inserts

There are various ways of using covers and inserts. To keep the explanations simple, covers and inserts are explained separately. The procedure for inserting covers is explained on page 5-13. The procedure for adding inserts is explained on page 5-14. After reading these explanations, see the examples of using covers and inserts on pages 5-17 to 5-22.

■ Preparations for using covers and inserts

- Load the cover/insert paper in the tray before using the cover/insert function.
- Use the same size of paper for the covers/inserts as for the copies. (For the procedures for loading paper, see pages 2-2 to 2-17.)
- Before selecting the cover/insert function, place the originals in the document feeder, select one-sided or two-sided copying, and select the number of copies and any other desired copy settings as explained on pages 4-7 to 4-10. When these settings have been completed, perform the procedure to select covers/inserts on the following page.
- The original must be scanned from the document feeder. The document glass cannot be used.
- Tabbed paper can be used for cover/inserts, however, two-sided copying cannot be performed on the tabbed paper. Tabbed paper can be fed from the bypass tray, tray 3, and the inserter. The other trays cannot be used.
- Up to 100 covers/inserts can be inserted. Two covers/inserts cannot be inserted between the same pages.
- Pamphlet copying cannot be used in combination with covers/inserts.
- When performing two-sided copying of two-sided originals, an insert cannot be added between the front and back sides of an original page.

■ Procedure for inserting front and back cover paper

The paper for the front cover is called the front cover paper ("FRONT COVER" in the touch panel). The paper for the back cover is called the back cover paper ("BACK COVER" in the touch panel).

● Examples of insertion methods for the front and back cover paper are given on pages 5-18 to 5-21.

To display the special modes screen...

See "General procedure for using special functions" on page 5-2.

1 Touch the [COVERS/INSERTS] key in the special modes screen (2nd screen).

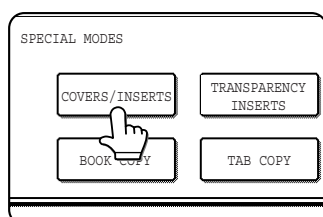

2 Touch the [PAPER TRAY SETTINGS] key.

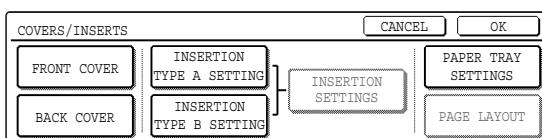

3 Select the tray used for the front cover paper.

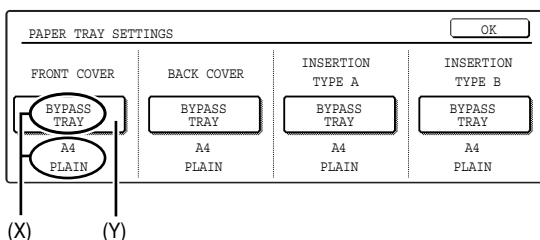

① The tray name (tray position) selected for the front cover paper and the paper size and type are shown in (X). If the tray in which you loaded paper for the front cover is shown, touch the [OK] key. You will return to the screen of step 2.

② If the correct tray for the cover sheet paper does not appear in (X), touch the (Y) key. The tray selection screen will appear. Select the tray in which you loaded paper for the front cover. You will return to the screen of above.

4 Touch the [FRONT COVER] key in the screen of step 2.

5 Set the insertion conditions for the front cover paper.

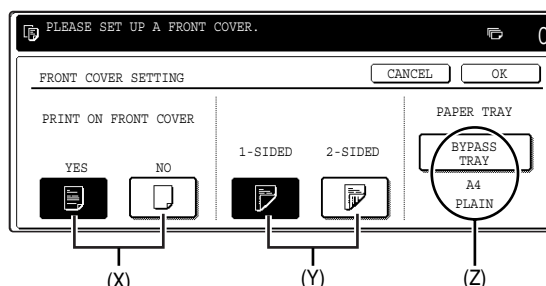

① Select whether or not the front cover paper is to be copied on with the (X) keys ([YES] or [NO]).

② Select whether one-sided copying or two-sided copying is to be performed on the front cover paper with the (Y) keys. This selection is only possible when the [YES] key of (X) has been selected. (The one-sided/two-sided selection made here only applies to the front cover paper. When the back cover paper is selected, the selection only applies to the back cover paper.)

③ The (Z) key shows the tray selected for the front cover paper in step 3 and the paper size and type.

6 Touch the [OK] key in the screen of step 5. You will return to the screen of step 2.

When you return to the screen of step 2, the [FRONT COVER] key will be highlighted.

7 To insert back cover paper, repeat steps 2 through 6, using the [BACK COVER] key instead of the [FRONT COVER] key.

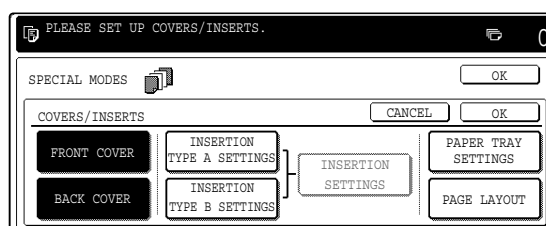

8 Touch the [PAGE LAYOUT] key in the screen of step 7 to display a list of the selected settings (page 5-16).

To edit or delete a cover/insert, follow steps 1 and 2 on page 5-16. To exit the cover/insert settings, touch the upper [OK] key in the screen of step 7.

9 Press the [START] key.

To cancel covers/inserts settings...

Touch the [CANCEL] key in the screen of step 2.

■ Procedure for adding inserts

You can have different paper automatically inserted as an insert at a specified pages. Two types of insert paper can be used. These are specified with the [INSERTION TYPE A SETTING] key and [INSERTION TYPE B SETTING] in the touch panel. Tabbed paper can be used as an insert.

● Examples of insertion methods for insert paper are given on page 5-22.

To display the special modes screen...
See "General procedure for using special functions" on page 5-2.

1 Touch the [COVERS/INSERTS] key in the special modes screen (2nd screen).

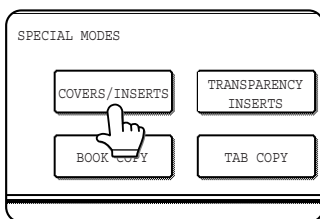

2 Touch the [PAPER TRAY SETTINGS] key.

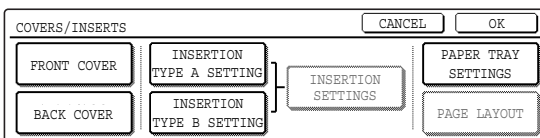

3 Select the tray used for insertion type A.

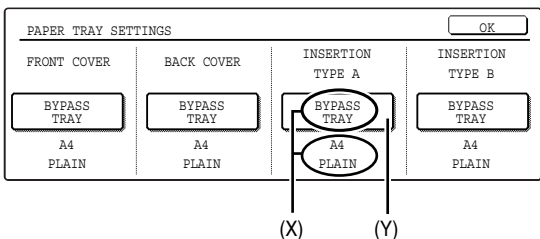

- ① The tray name (tray position) selected for insertion type A and the paper size and type are shown in (X). If the tray in which you loaded paper for insertion type A is shown, touch the [OK] key. You will return to the screen of step 2.
- ② If the correct tray for insertion type A does not appear in (X), touch the (Y) key. The tray selection screen will appear. Select the tray in which you loaded paper for insertion type A. You will return to the screen of step 2.

4 Touch the [INSERTION TYPE A SETTING] key in the screen of step 2

5 Set the insertion conditions for insertion type A .

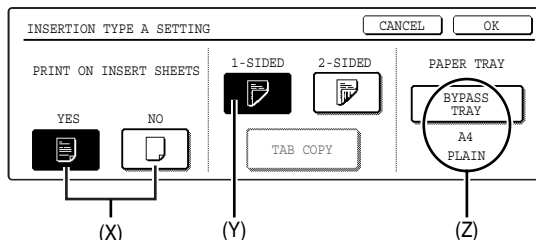

- ① Select whether or not insertion type A paper is to be copied on with the (X) keys ([YES] or [NO]).
- ② Select whether one-sided copying or two-sided copying is to be performed on insertion type A with the (Y) keys. This selection is only possible when the [YES] key of (X) has been selected. (The one-sided/two-sided selection made here only applies to insertion type A paper. When insertion type B is selected, the selection only applies to insertion type B paper.)
- ③ The (Z) key shows the tray selected for insertion type A in step 3 and the paper size and type.
- ④ If a paper tray with tabbed paper is selected in the screen of step 3, you can touch the [TAB COPY] key. This allows you to select the tab width. Two-sided copying is not possible on tabbed paper.

6 Touch the [OK] key in the screen of step 5. You will return to the screen of step 2.

When you return to the screen of step 2, the [INSERTION TYPE A SETTING] key will be highlighted.

7 If you wish to insert a different paper with the [INSERTION TYPE B SETTING] key, repeat steps 2 through 6. Use the [INSERTION TYPE B SETTING] key instead of the [INSERTION TYPE A SETTING] key, and the [INSERTION TYPE B] key instead of the [INSERTION TYPE A] key.

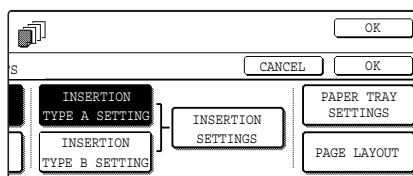

- 8** Touch the [INSERTION SETTINGS] key to specify the pages where you wish to insert the insert papers of [INSERTION TYPE A SETTING] and [INSERTION TYPE B SETTING].

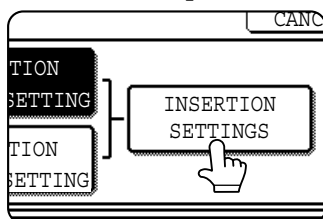

- 9** Touch the [INSERTION TYPE A] key or the [INSERTION TYPE B] key, enter the page number where you wish to insert the insert paper with the numeric keys, and then touch the [ENTER] key.

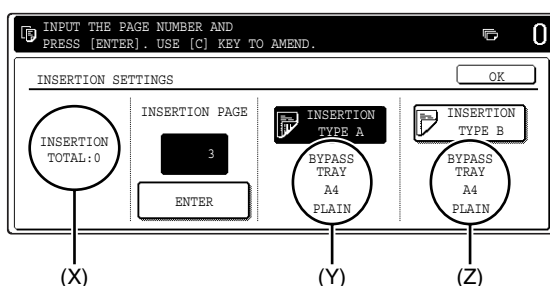

- ① (X) shows the total number of inserts. Up to 100 inserts can be added. When inserting multiple inserts, touch the [ENTER] key after each entry of an insertion page number (insertion position) with the numeric keys.
- ② (Y) shows the tray selected in step 3 for [INSERTION TYPE A SETTING] and the paper size and type.
- ③ (Z) shows the tray selected in step 3 for [INSERTION TYPE B SETTING] and the paper size and type.
- ④ When the [INSERTION TYPE A] key is highlighted, the insert settings apply to [INSERTION TYPE A SETTING]. When the [INSERTION TYPE B] key is highlighted, the insert settings apply to [INSERTION TYPE B SETTING].

- 10** Touch the [OK] key in the screen of step 9. You will return to the screen of step 2.

When you return to the screen of step 2, the [INSERTION TYPE A SETTING] key will be highlighted.

- 11** If you wish to insert a different paper with the [INSERTION TYPE B SETTING] key, repeat steps 2 through 6. Use the [INSERTION TYPE B SETTING] key instead of the [INSERTION TYPE A SETTING] key, and the [INSERTION TYPE B] key instead of the [INSERTION TYPE A] key.

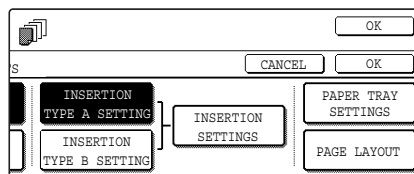

- 12** Touch the [PAGE LAYOUT] key in the screen of step 11 to display a list of the selected settings (page 5-16).

To edit or delete a cover/insert, follow steps 1 and 2 on page 5-16. To exit the cover/insert settings, touch the upper [OK] key in the screen of step 11.

- 13** Press the [START] key.

To cancel covers/inserts settings...
Touch the [CANCEL] key in the screen of step 2.

■ Checking, editing, and deleting cover/insert pages

The [PAGE LAYOUT] key appears after covers/inserts settings are configured (the settings of step 1 through step 7 on pages 5-13 and 5-14).

The [PAGE LAYOUT] key is used for the following:

- To display the status of covers/inserts pages
- To edit, delete, or add inserted pages

To display the [PAGE LAYOUT] key...

Configure the settings in step 1 through step 7 on pages 5-13 and 5-14.

1 Touch the [PAGE LAYOUT] key.

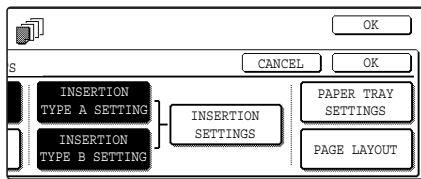

2 The set covers/inserts pages are shown.

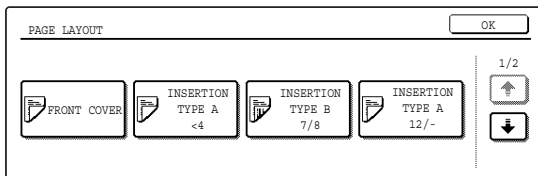

① If there are multiple screens, touch the or key to change screens.

② Displayed icons:

- : Front side copy only
- : Back side copy only
- : Two-sided copy
- : No copying

For inserts, the insertion page also appears.

"*" represents a page number.

- */- : Front side copy only at page *
- */* : Two-sided copy at page */*
- /* : Back side copy only at page *
- <* : Insert non-copied insert at page *

③ To edit or delete an inserted page, touch the key of the page you wish to edit or delete in the page layout screen. When the key is touched, the [CANCEL], [DELETE], and [AMEND] keys appear.

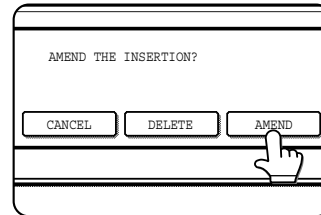

- To cancel, touch the [CANCEL] key.
- To delete an inserted page, touch the [DELETE] key.
- To edit an inserted page, touch the [AMEND] key. The screen of step 5 on page 5-13 or the screen of step 5 on page 5-14 appears. Edit the page as explained in step 5 on page 5-13 or step 5 on page 5-14.

3 When you have finished checking the pages, touch the [OK] key.

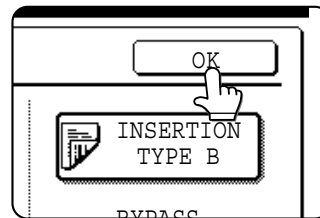

Examples of covers and inserts

The relations between the originals and finished copies when covers or inserts are inserted are shown on the following pages.

Covers

- One-sided copying of one-sided originals (page 5-18)
- One-sided copying of two-sided originals (page 5-20)

- Two-sided copying of one-sided originals (page 5-19)
- Two-sided copying of two-sided originals (page 5-21)

Inserts

- One-sided copying of one-sided originals (page 5-22)
- One-sided copying of two-sided originals (page 5-22)

- Two-sided copying of one-sided originals (page 5-22)
- Two-sided copying of two-sided originals (page 5-22)

Symbols used for covers and inserts

The following symbols are used to make the explanations easier to understand.



















The numbers that appear indicate relations between the originals and copies, and will vary depending on the settings.

Type	Symbol	Meaning	Icon appearing in display	Type	Symbol	Meaning	Icon appearing in display
Front cover		Front cover when not copied on.		Inserts		Insert when not copied on.	
		Front cover after one-sided copying.				Insert after one-sided copying.	
		Front cover after two-sided copying. (One page is not copied on.)				Insert after one-sided copying. (One page is not copied on.)	
		Front cover after two-sided copying.				Insert after two-sided copying.	
Back cover		Back cover when not copied on.		Other		One-sided original or output page of regular one-sided copying	
		Back cover after one-sided copying of one-sided original.				Two-sided original or output page of regular two-sided copying.	
		Back cover after two-sided copying. (One page is not copied on.)				One-sided original or output page of regular one-sided copying.	
		Back cover after two-sided copying.				One-sided original or output page of regular one-sided copying.	

■ **Covers (One-sided copying of one-sided originals)**

One-sided copies are made of the following one-sided originals.

1st page	2nd page	3rd page	4th page	5th page	6th page
1	2	3	4	5	6

Copying on cover		Resulting copies							
Front cover	Back cover								
No copying	No copying		1	2	3	4	5	6	
One-sided copying	No copying		2	3	4	5	6		
Two-sided copying	No copying		3	4	5	6			
No copying	One-sided copying		1	2	3	4	5		
No copying	Two-sided copying		1	2	3	4			
One-sided copying	One-sided copying		2	3	4	5			
One-sided copying	Two-sided copying		2	3	4				
Two-sided copying	One-sided copying		3	4	5				
Two-sided copying	Two-sided copying		3	4					

■ Covers (Two-sided copying of one-sided originals)



Two-sided copies are made of the following one-sided originals.

























































1st page	2nd page	3rd page	4th page	5th page	6th page
1	2	3	4	5	6

Copying on cover		Resulting copies
Front cover	Back cover	
No copying	No copying	
One-sided copying	No copying	
Two-sided copying	No copying	
No copying	One-sided copying	
No copying	Two-sided copying	
One-sided copying	One-sided copying	
One-sided copying	Two-sided copying	
Two-sided copying	One-sided copying	
Two-sided copying	Two-sided copying	

■ **Covers (One-sided copying of Two-sided originals)**



One-sided copies are made of the following two-sided originals.

































1st page 	2nd page 	3rd page 
---	---	---

Copying on cover		Resulting copies							
Front cover	Back cover								
No copying	No copying								
One-sided copying	No copying								
Two-sided copying	No copying								
No copying	One-sided copying								
No copying	Two-sided copying								
One-sided copying	One-sided copying								
One-sided copying	Two-sided copying								
Two-sided copying	One-sided copying								
Two-sided copying	Two-sided copying								

■ Covers (Two-sided copying of two-sided originals)







Two-sided copies are made of the following two-sided originals.

































1st page	2nd page	3rd page
		

Copying on cover		Resulting copies				
Front cover	Back cover					
No copying	No copying					
One-sided copying	No copying					
Two-sided copying	No copying					
No copying	One-sided copying					
No copying	Two-sided copying					
One-sided copying	One-sided copying					
One-sided copying	Two-sided copying					
Two-sided copying	One-sided copying					
Two-sided copying	Two-sided copying					

■ **Inserts (One-sided copying of one-sided originals)**



One-sided and two-sided copying is performed using the following one-sided originals. The insert is added as the third page.

































1st page	2nd page	3rd page	4th page	5th page	6th page
					

Copying on insert	Resulting copies (one-sided copying)						Resulting copies (two-sided copying)				
No copying											
One-sided copying											
Two-sided copying											

■ **Inserts (One-sided copying of two-sided originals)**

One-sided and two-sided copying is performed using the following two-sided originals.

1st page	2nd page	3rd page
		

Copying on insert	Resulting copies (one-sided copying)						Resulting copies (two-sided copying)				
No copying											
One-sided copying											
Two-sided copying											

Transparency film with insert sheets

When copying onto transparency film, blank insert sheets can be placed between transparent sheets.

Example: Inserting insert sheets between transparencies

Originals (1-sided)

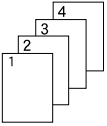

Originals (2-sided)



Two-sided originals are only supported when automatic document feeding is used.

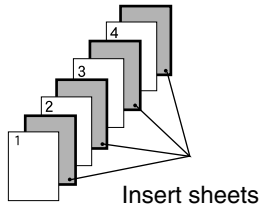

Inserts can also be copied on.

- This function only operates in "one-sided to one-sided" and "two-sided to one-sided" modes.
- Multiple copies cannot be selected in this mode.
- The inserts are inserted under each transparency as shown at left.
- Select insert paper that is the same size as the transparencies.
- When feeding insert paper from an inserter, copying on the insert paper is not possible.
- Transparencies can be fed from the bypass tray or tray 3.
- If the transparencies are loaded in tray 3, be sure to set the paper size and paper type as explained on pages 2-14 and 2-15.

If the transparencies are loaded in tray 3, steps 1 to 5 below are not necessary.

1 Load transparency film into the bypass tray.

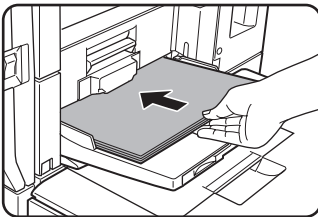

Remove any paper already in the bypass tray before loading the transparency film. (To load paper in the bypass tray, see pages 2-10 and 2-11.)

2 Touch the [PAPER SELECT] key in the main screen and select the bypass tray paper type in the paper setting screen (touch (X) below).

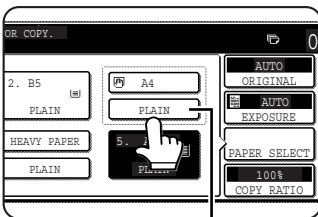

(X)

3 Touch the [TRANSPARENCY] key.

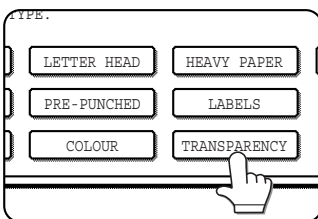

4 Touch the [OK] key.

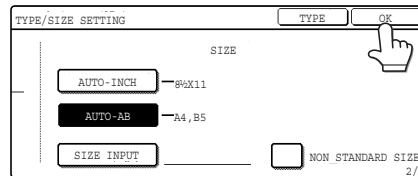

If the paper size was changed from an inch size to an AB size, or from an AB size to an inch size, be sure to set the paper type and size as explained on steps 5 to 7 on page 2-14 and steps 8 to 10 on page 2-15.

5 Select the bypass tray.

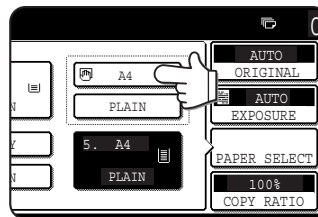

To display the special modes screen...
See "General procedure for using special functions" on page 5-2.

6 Touch the [TRANSPARENCY INSERTS] key in the special modes screen (2nd screen).

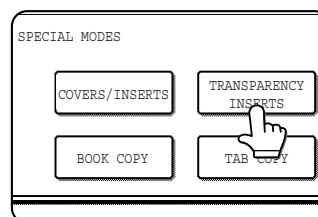

The Transparency inserts setting screen will appear. The transparency inserts icon (), etc.) will also appear in the upper left corner of the screen to indicate that the function is turned on.

7 Set the insertion conditions for the insert paper.

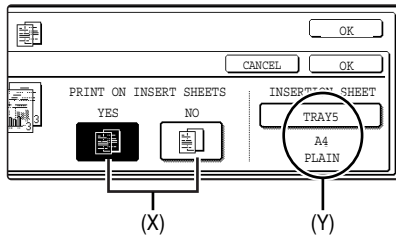

- ① Select whether or not the insert paper will be copied on with the (X) keys ([YES] or [NO]). If [YES] is selected, insert paper cannot be fed from an inserter.
- ② The (Y) key shows the tray selected for the insert paper and the paper size and type. To select a different tray, touch this key to display the tray selection screen and select the tray that has the insert paper.

8 Touch the outer [OK] key in the screen of step 7.

You will return to the main screen of copy mode.

NOTE

If insert paper is fed from an inserter, the output will be delivered to the finisher (or saddle stitch finisher).

About the steps that follow

If an automatic document feeder is being used, see pages 4-7 through 4-10. If the document glass is being used, see pages 4-11 through 4-13.

To cancel the Transparency film with insert sheets function, touch the [CANCEL] key on the Transparency film with insert sheets setting screen.

Multi shot

Multiple original pages can be copied onto one sheet of copy paper in a uniform layout. Select 2in1 to copy two original pages onto one sheet, or 4in1 to copy four original pages onto one sheet. This function is convenient when you wish to present multiple pages in a compact format, or show a view of all pages in a document.

[Example] Copying 4 original pages onto one sheet of paper

(Page number : 4in1, layout : left top : right top (see the next page))

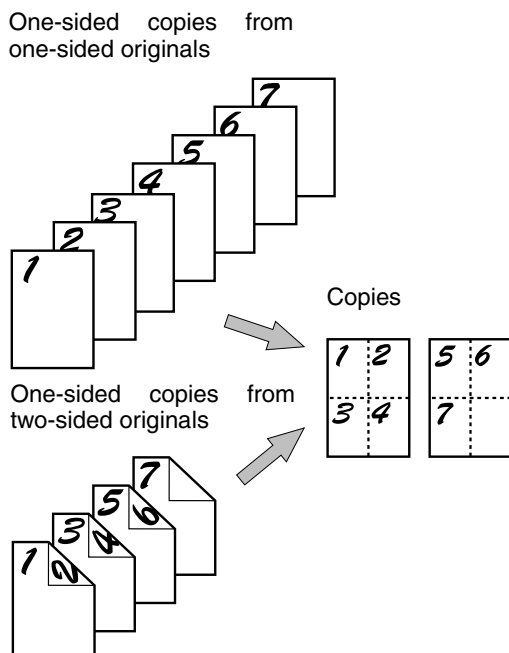

- When using the multi shot function, place the originals, select the desired paper size, and select the copying mode before selecting the multi shot function on the special modes screen.
- When using the multi shot function, the appropriate copy ratio will be automatically set based on the original size, paper size, and the number of originals to be copied onto one sheet. The minimum reduction ratio is 25%. The original size, copy paper size, and selected number of original pages may require that the ratio be less than 25%. As copying will take place at 25% in this case, part of the original images may be cut off.

To display the special modes screen...
See "General procedure for using special functions" on page 5-2.

1 Touch the [MULTI SHOT] key in the special modes screen (2nd screen).

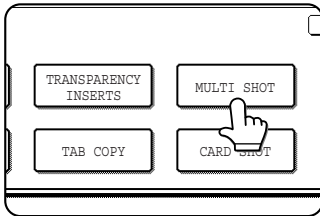

The MULTI SHOT setting screen will appear. A multi shot icon ($\begin{smallmatrix} 1 & 2 \\ 3 & 4 \end{smallmatrix}$, etc.) will also appear in the upper left of the screen to indicate that the function is turned on.

2 Select the number of images to be copied onto one sheet of copy paper.

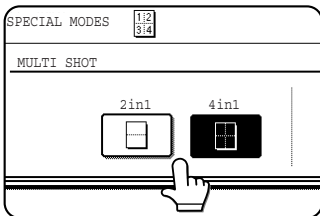

If needed, the orientation of the copy paper and the orientation of the images will be rotated.

3 Select the layout.

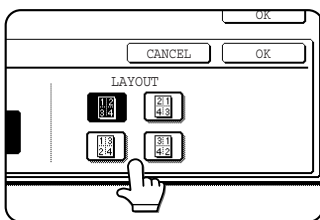

Select the order in which the originals will be arranged on the copy.

4 Touch the [OK] key (inside [OK] key) on the multi shot setting screen.

You will return to the special modes screen.

5 Touch the [OK] key in the special modes screen.

You will return to the main screen of copy mode.

About the steps that follow
If an automatic document feeder is being used, see pages 4-7 through 4-10. If the document glass is being used, see pages 4-11 through 4-13.

To cancel the multi shot function, touch the [CANCEL] key in the multi shot setting screen (the screen of step 2).

5

Shot number	Layout
2in1	
4in1	

The arrows in the above diagram indicate the directions in which the images are arranged.

Book copy

This function is convenient when you wish to compile copies of books or other bound originals into an attractive pamphlet format. The two pages of the open book are scanned as a set, and two pages each are copied onto the front and back sides of the copy paper (four pages are copied onto one sheet of copy paper). This allows the copies to be folded down the centre and made into a pamphlet.

[Example] Book copying an 8-page pamphlet

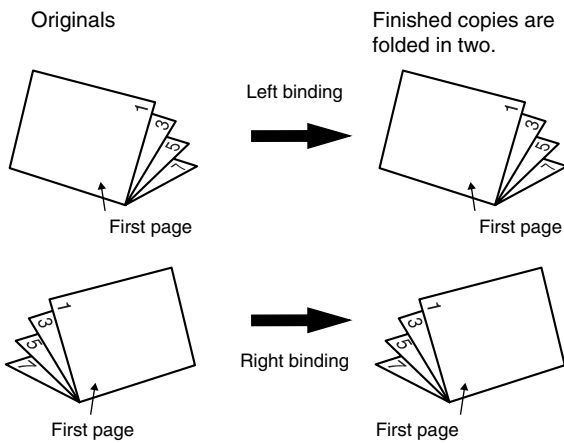

To display the special modes screen...
See "General procedure for using special functions" on page 5-2.

1 Touch the [BOOK COPY] key in the special modes screen (2nd screen).

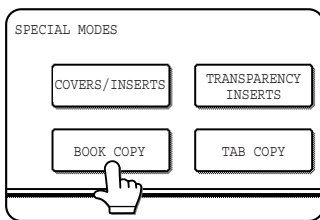

The BOOK COPY setting screen will appear. The book copy icon (📖, etc.) will also appear in the upper left corner of the screen to indicate that the function is turned on.

2 Select whether the book opens to the left or to the right, and touch the [OK] key in the book copy setting screen.

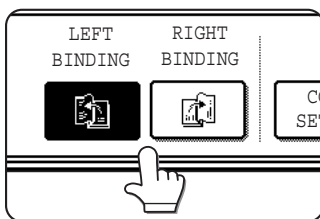

You will return to the special modes screen.

3 Select any desired cover settings.

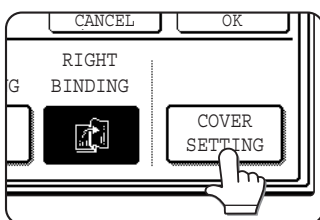

If you wish to use a different type of paper for the cover, perform steps 4 to 12 on pages 5-6 to 5-7.

If you do not wish to use a different type of paper, continue from step 4.

- Scan the originals from the first page to the last page. The order of copying will be automatically adjusted by the machine.
- Either left binding (right to left turning) or right binding (left to right turning) can be selected.
- Four originals will be copied onto one sheet. Blank pages may be automatically produced at the end depending on the number of the originals.
- If a saddle stitch finisher is installed, book copy can be used in combination with the pamphlet function to staple and fold the copies at the centreline.

4 Touch the [OK] key in the special modes screen.

You will return to the main screen of copy mode.

5 Place the originals on the document glass. (page 4-3)

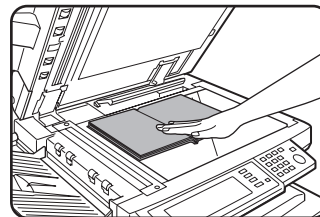

Scan the original pages in the following order:
 Opened front and back cover
 Opened inside of front cover and 1st page
 Opened 2nd and 3rd page

⋮

Opened last page and inside of back cover

6 Make sure that the desired paper size has been selected.

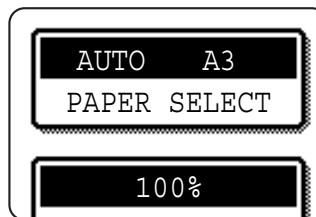

If the desired paper size is not selected, select the desired size.

7 Select the number of copies and any other desired copy settings, and then press the [START] key.

8 Place the next two pages and press the [START] key. Repeat until all pages have been scanned, and then touch the [READ-END] key.

When book copy is selected, two-sided copying is automatically selected.

To cancel the book copy function, touch the [CANCEL] key in the book copy setting screen (the screen of step 2).

Tab copy

Copying is possible on the tabs of tabbed paper. Prepare appropriate originals for the tab captions.

[Example]

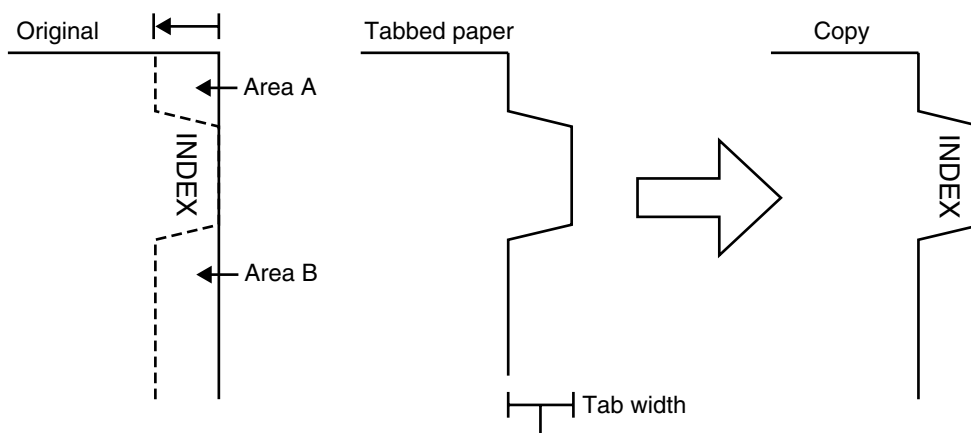

A4 : Maximum of 20 mm
 (8-1/2" x 11" : Maximum of 5/8")

- The tab caption is shifted by the amount of the tab width setting, so keep areas A and B blank.

Relations between originals and tabbed paper

		Left binding (normal top-bottom)	Right binding (Inverted top-bottom)	Right binding (Inverted top-bottom)
Originals	Prepare these originals	(Normal order A-E)	(Normal order A-E)	(Reverse order E-A)
	Originals placed face up in the document feeder	(Normal order A-E)	(Normal order A-E)	(Reverse order E-A)
	Originals placed on the document glass	(Normal order A-E)	(Normal order A-E)	(Reverse order E-A)
Tabbed paper	Load tabbed paper in the bypass tray or tray 3	Feeding direction	Feeding direction	Feeding direction
Result		(Top-bottom normal)	(Top-bottom reversed)	(Top-bottom reversed)

To display the special modes screen...

See "General procedure for using special functions" on page 5-2.

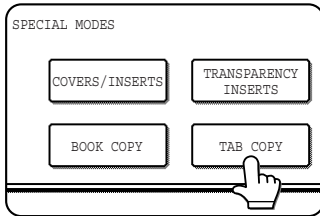

1 Touch the [TAB COPY] key in the special modes screen (2nd screen).

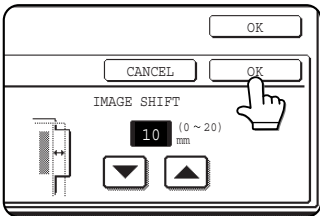

The TAB COPY setting screen will appear. A tab copy icon () will also appear in the upper left corner of the screen to indicate that the function is turned on.

2 If necessary, set the image shift width (tab) and touch the [OK] key.



Set the image shift width (tab) with the  and  keys. The width can be set from 0 to 20 mm (0 to 5/8") in increments of 1 mm (1/8").

3 Touch the [OK] key in the special modes screen.

You will return to the main screen of copy mode.

4 Load tabbed paper in the bypass tray.

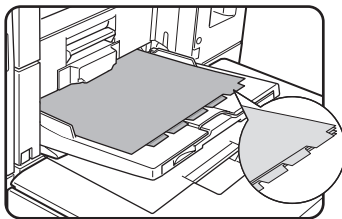

Place the tabbed paper so that the edges with the tabs are the trailing edge.

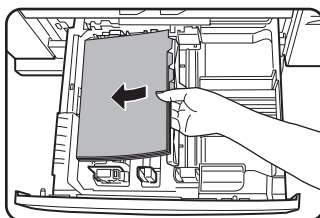

To use tab paper in tray 3, set the paper type setting of tray 3 to "TAB PAPER" in the tray settings of the system settings (page 2-14).

To load tabbed paper in tray 3, see "Loading tabbed paper" on page 2-6.

NOTE

The width of the tabbed paper can be up to A4 width (210 mm) + 20 mm (or 8-1/2" x 11" width (8-1/2") + 5/8").

5 Select "TAB PAPER" for the paper type setting.

The paper type setting is explained in "Setting the paper type and paper size" (page 2-14).

If you are using tray 3, see "Setting the paper size when a special size is loaded" (page 2-17).

About the steps that follow

If an automatic document feeder is being used, see pages 4-7 through 4-10. If the document glass is being used, see pages 4-11 through 4-13.

When performing tab copying with a right binding

If you are using left-binding tabbed paper for a right binding, either stack the sheets in reverse order or scan the originals in reverse order. (See the table on the previous page.)

To cancel the tab copy function, touch the [CANCEL] key in the tab copy setting screen (the screen of step 2).

Card shot

When copying a card, this function allows you to combine the front and back sides on a single sheet of paper.

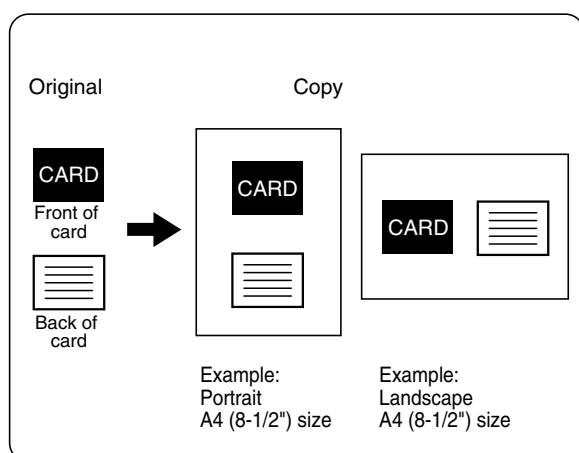

- Copying is only possible on standard size paper.
- A copy ratio cannot be selected when using this function.
- The image cannot be rotated when using this function.

1 Touch the [PAPER SELECT] key and then select the desired paper size.

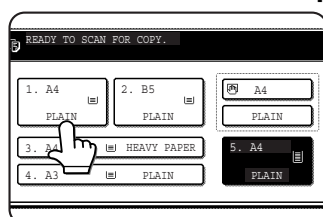

The selected paper size key is highlighted and the paper selection screen closes.

NOTE

If paper of the desired size is not loaded in any tray, load paper of the required size in a paper tray or the bypass tray. (See "Setting the paper type and paper size" on page 2-14.)

To display the special modes screen...

See "General procedure for using special functions" on page 5-2.

2 Touch the [CARD SHOT] key in the special modes screen (2nd screen).

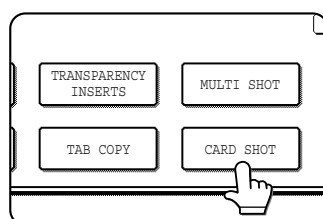

The CARD SHOT setting screen will appear. A card shot icon (, etc.) will also appear in the upper left corner of the screen to indicate that the function is turned on.

3 Enter the X dimension (width) and Y dimension (length) of the original with the keys.

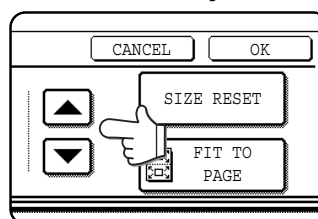

- X (width) is initially selected. Enter X and then touch the Y () key to enter Y.
- To return the X and Y values to the initial settings configured in the administrator settings, touch the [SIZE RESET] key. (See "CARD SHOT SETTINGS" on page 16 of the administrator settings guide.)
- To have the images enlarged or reduced by a suitable ratio based on the entered original size so that the front and back sides fit into the selected paper size, touch the [FIT TO PAGE] key.

4 Touch the outer [OK] key.

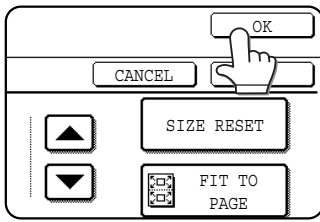

You will return to the main screen of copy mode.

5 Place the original on the document glass.

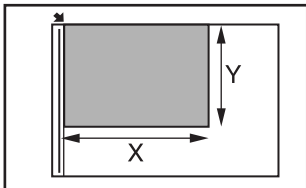

Place the front side of the original face down and close the document cover.

6 Follow steps 4 through 5 of "Copying from the document glass" (page 4-12).

7 Press the [START] key.

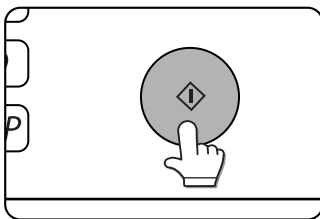

The front side of the card is scanned.

8 Place the back side of the original face down on the document glass (see step 5).

9 Press the [START] key.

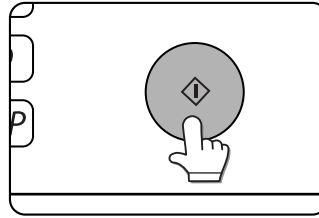

The back side of the card is scanned.

10 Touch the [READ-END] key.

NOTE

The original must be placed on the document glass. The document feeder (automatic document feeding function) cannot be used.

To cancel the card shot function, touch the [CANCEL] key in the card shot setting screen (the screen of step 4).

Mirror image

This function is used to print a mirror image of the original. The images will be inverted in the right to left direction on the copies.

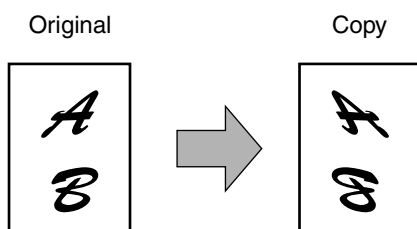

To display the special modes screen...

See "General procedure for using special functions" on page 5-2.

1 Touch the [MIRROR IMAGE] key in the special modes screen (3rd screen).

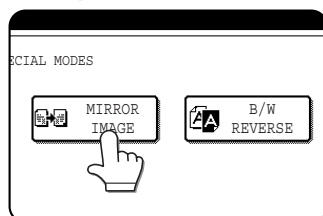

The [MIRROR IMAGE] key will be highlighted to indicate that the function is turned on, and the mirror image icon () will appear in the upper left of the screen.

2 Touch the [OK] key on the special modes screen.

You will return to the main screen of copy mode.

About the steps that follow

If an automatic document feeder is being used, see pages 4-7 through 4-10. If the document glass is being used, see pages 4-11 through 4-13.

To cancel the mirror image function, touch the [MIRROR IMAGE] key in the special modes screen (the screen of step 1).

B/W reverse

Black and white are reversed in the copy to create a negative image.

NOTES

- When this function is selected, the exposure mode setting (page 4-14) automatically changes to "Text".
- Originals with large black areas (which use a large amount of toner) can be printed with black/white reverse to reduce toner consumption.

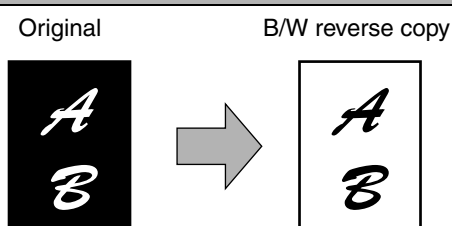

To display the special modes screen...

See "General procedure for using special functions" on page 5-2.

1 Touch the [B/W REVERSE] key in the special modes screen (3rd screen).

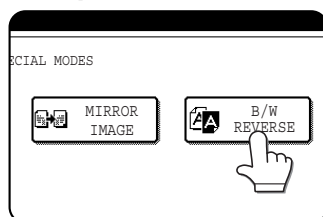

The [B/W REVERSE] key will be highlighted to indicate that the function is turned on, and the mirror image icon () will appear in the upper left of the screen.

2 Touch the [OK] key in the special modes screen.

You will return to the main screen of copy mode.

About the steps that follow

If an automatic document feeder is being used, see pages 4-7 through 4-10. If the document glass is being used, see pages 4-11 through 4-13.

To cancel the B/W reverse function, touch the [B/W REVERSE] key in the special modes screen (the screen of step 1).

Print menu

The date, a stamp, page numbers, and entered text can be printed on copies. Four selections are available for the PRINT MENU:

- **Date print (page 5-35)**

This prints the date on the paper.
 [Example] Printing 2010/APR/4 in the upper right-hand corner of the paper

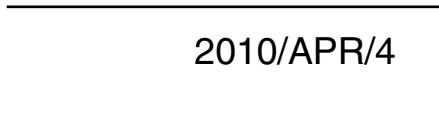

The format of the date and the character that separates the year, month, and day can be changed.

- **Page numbering (page 5-37)**

Page numbers can be printed on copies.
 [Example] Printing page numbers in the bottom right-hand corner of the paper

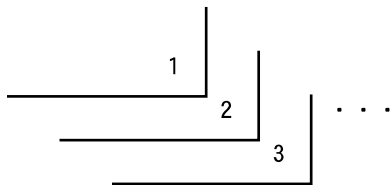

The format of the page number can be changed.

- **Stamp (page 5-36)**

Print a message such as "CONFIDENTIAL" in reverse text on the paper.
 [Example] Printing "CONFIDENTIAL" in the upper right-hand corner of the paper



One of 12 stamps can be selected.

- **Text (page 5-41)**

Entered text can be printed.
 [Example] Printing "Meeting" in the upper left-hand corner of the paper



Up to 50 characters can be printed. You can store up to 30 sequences of frequently used text.

Six printing positions are available: left, centre, or right of the top or bottom of the page. Each printing position is divided into an area for the date, page number, and text (A below), and an area for the stamp (B below).

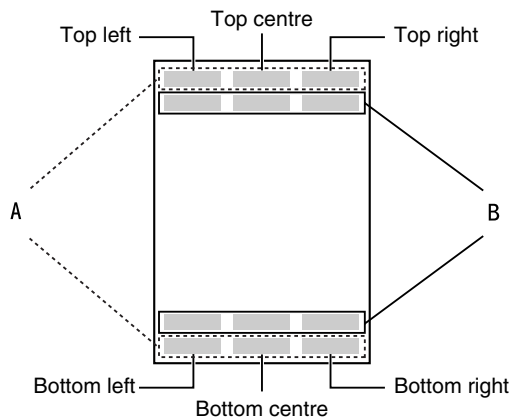

Print menu	Printing area	Maximum number of settings
DATE	A	One position only
STAMP	B	6 positions
PAGE NUMBERING	A	One position only
TEXT	A	6 positions

NOTES

- A part that overlaps the printed text will not be copied.
- If the set text content overlaps the print content of another position, the central print content will be moved to the bottom, the content on the left will be next, and the content on the right will be placed on top in that order such that only the content visible at the top is printed. Content that is hidden due to overlapping will not be printed.
- The printed text will be printed at the set size regardless of the copy ratio or paper size.
- The printed text will also be printed at the set density regardless of the copy exposure.
- Some copy paper sizes may cause the printed contents to be cut off or the print position to shift.
- If a copy job with a print menu setting is saved using the document filing function, the print menu setting will not be saved. If you wish to print a file saved in copy mode and use a print menu setting, use the special modes in the Job settings / print screen (or the document filing print screen in the Web page if the machine is connected to a network) to select the print menu setting. (A print menu setting cannot be selected when printing a file saved in a mode other than copy mode.)

Common operation procedure for using the print menu

To display the special modes screen...

See "General procedure for using special functions" on page 5-2.

1 Touch the [PRINT MENU] key in the special modes screen (3rd screen).

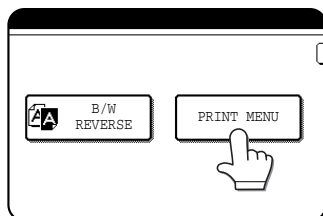

The print menu setting screen will appear. The print menu icon (🖨️) will also appear in the upper left corner of the screen to indicate that the function is turned on.

2 Select the print position.

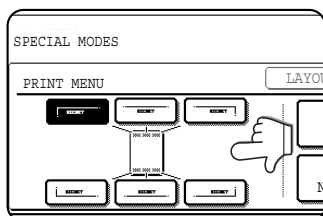

Six positions are available: left, centre, or right of the top or bottom of the page. The touched key is highlighted.

The keys indicating the print position appear as follows depending on the state of the setting:

	Not selected, print menu setting has not been selected.
	Selected during selection of the print menu setting.
	Not selected, print menu setting has already been selected.

The image displayed within each key varies depending on the key position.

3 Select the print menu.

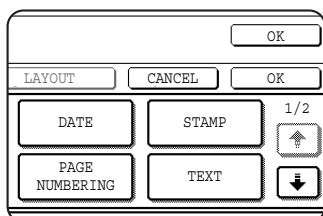

The settings screen of the print menu appears. For information on each of the print menus, see the settings of each.

- DATE (page 5-35) ● STAMP (page 5-36)
- PAGE NUMBERING (page 5-37) ● TEXT (page 5-41)

4 To select print menu settings at another print position, repeat steps 2 and 3.

NOTES

- If the [DATE], [PAGE NUMBERING], or [TEXT] key is touched when other than a "STAMP" print menu setting has been selected for the print position selected in step 2, a message will appear. To overwrite the previously set print content of the print menu that you touched, touch the [YES] key. To keep the previous settings, touch the [NO] key.
- The "DATE" and "PAGE NUMBERING" cannot be set in multiple positions. If either of these keys is touched when a date or page numbering setting has already been configured, a message will appear asking you if you wish to move the print settings to the position that you selected in step 2. To move the print settings, touch the [YES] key. Otherwise touch the [NO] key.

5 Touch the [↓] key.

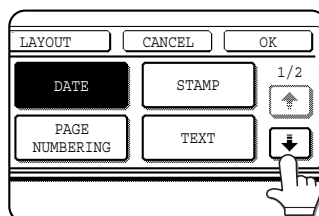

6 To specify the orientation of the original, touch the [ORIGINAL ORIENTATION] key.

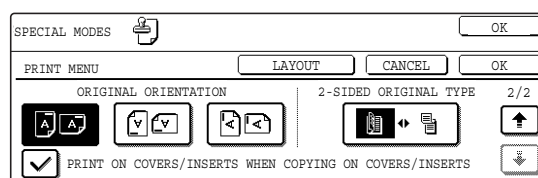

If you placed a two-sided original, touch the [📄] key to specify the binding style (book or tablet). The icon of the selected binding style is highlighted.

7 If you are adding covers or inserts, select whether or not you wish to print on the covers or inserts.

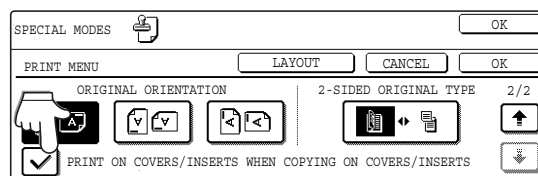

If you do not wish to print on covers or inserts, touch the checkbox to remove the checkmark.

NOTES

- If you are not copying on covers or inserts, printing will not take place on these even if a checkmark appears.
- A page number is never printed on covers or inserts, regardless of the above setting.
- If covers/inserts have been disabled in the administrator settings, the checkbox will be greyed out to prevent selection.

8 Check the print layout if needed (page 5-43).

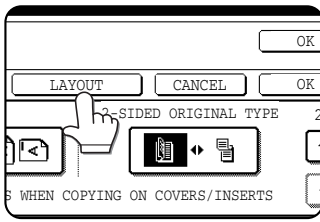

To display the layout and print content of the configured print menu, touch the [LAYOUT] key. The position can be changed and settings cancelled if needed.

NOTE
To cancel print menu...
 Touch the [CANCEL] key in the screen of step 3.

9 Touch the [OK] key on the print menu setting screen.

10 Touch the [OK] key on the special modes screen.

About the steps that follow
 If an automatic document feeder is being used, see pages 4-7 through 4-10.
 If the document glass is being used, see pages 4-11 through 4-13.

Printing in combination with other special functions

When a print menu is combined with one of the following special modes, printing will reflect the selected special mode.

Special modes	Printing operation
Margin shift	Like the copy image, the printed contents are shifted in accordance with the set margin.
Dual page copy	The print content is printed on each copy sheet.
Pamphlet copy Book copy	The print content is printed on each page of the "book".
Multi shot Card shot	The print content is printed on each copy sheet.
Covers/inserts	In the print menu settings, specify whether or not the print content is printed on covers and inserts.

NOTE
 When combined with "Erase", "Job build", "Mirror image", "B/W reverse", or "Tab copy", printing takes place normally at the set position on the paper.

■ Printing the date on copies

The date can be printed on copies. Four selections each are available for the date format and the character that separates the year, month, and day.

NOTE

The date must be previously set in the system settings. (See page 2-18.)

1 Follow steps 1 and 2 of "Common operation procedure for using the print menu" (page 5-33).

2 Touch the [DATE] key.

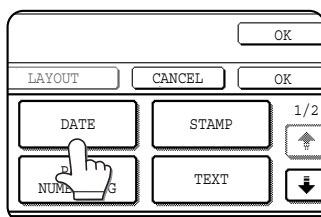

3 Select the date format.

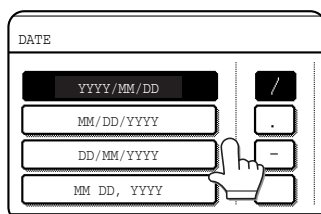

The selected date format is highlighted.

If you selected [YYYY/MM/DD], [MM/DD/YYYY], or [DD/MM/YYYY], you can select the character that separates the year,

month, and date. Select [/] (slash), [.] (period), [-] (hyphen), or [] (space).

4 Check the date and format.

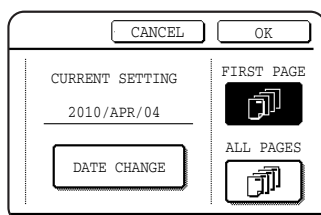

The date to be printed is displayed in "CURRENT SETTING" in the selected format.

The date that appears is the date set in the machine. If you need to

change the date, touch the [DATE CHANGE] key. The following screen appears.

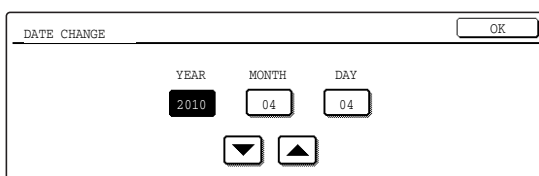

Touch the key of the number (year, month, or day) that needs to be changed, and then adjust the number with the ▼ or ▲ key. When finished, touch the [OK] key.

NOTE

If you select a non-existent date (for example, Feb. 30), the [OK] key will grey out to prevent entry of the date.

5 Select the pages to be printed on.

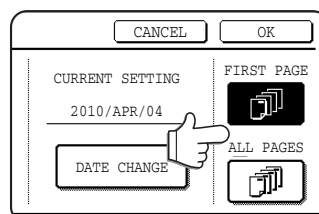

Select whether to print on only the first page, or all pages. The touched key is highlighted.

6 Touch the [OK] key.

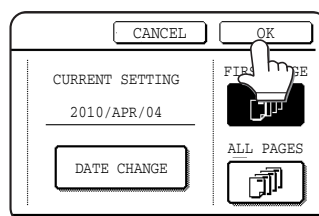

7 Continue from step 4 of "Common operation procedure for using the print menu" (page 5-33).

NOTE

To cancel a date print setting...

Touch the [CANCEL] key in the date selection screen. (The screen of step 6.)

■ Printing a stamp (reverse text) on copies

A message such as "CONFIDENTIAL" can be printed in reverse text on copies. The following 12 messages are available.

CONFIDENTIAL	PRIORITY	PRELIMINARY	FINAL
FOR YOUR INFO.	DO NOT COPY	IMPORTANT	COPY
URGENT	DRAFT	TOP SECRET	PLEASE REPLY

You can select from three density levels for the background of the stamp. Two selections are available for the size of the stamp.

NOTE

The text of the stamp cannot be edited.

1 Follow steps 1 and 2 of "Common operation procedure for using the print menu" (page 5-33).

2 Touch the [STAMP] key.

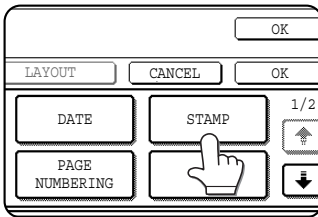

3 Select the stamp that you wish to print.

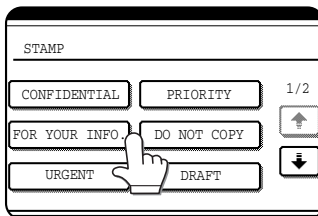

The selected stamp is highlighted. If the desired stamp does not appear, change screens with the or key.

4 Adjust the exposure as needed.

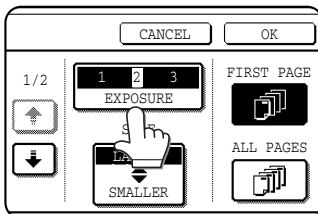

The density of the background of the stamp can be adjusted. Touch the [EXPOSURE] key to display the following screen.

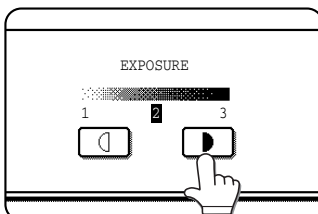

Touch the key for a darker background. Touch the key for a lighter background (3 levels). When finished, touch the [OK] key.

5 Select the desired stamp size.

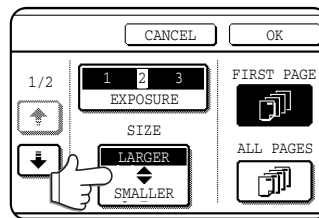

"LARGER" is initially selected. To make the stamp smaller, touch the key. "Smaller" is selected when [SMALLER] is highlighted.

6 Select the pages to be printed on.

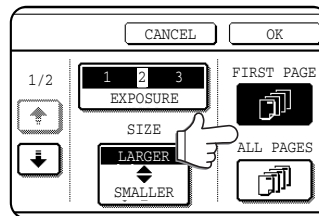

Select whether to print on only the first page, or all pages. The touched key is highlighted.

7 Touch the [OK] key.

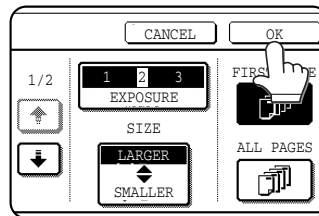

8 Continue from step 4 of "Common operation procedure for using the print menu" (page 5-33).

NOTE

To cancel a stamp setting...

Touch the [CANCEL] key in the stamp selection screen. (The screen of step 7.)

■ Printing the page number on copies

The page number can be printed on copies. One of 6 formats can be selected for the page number.

1 Follow steps 1 and 2 of "Common operation procedure for using the print menu" (page 5-33).

2 Touch the [PAGE NUMBERING] key.

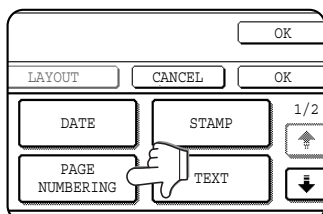

3 Select the page number format.

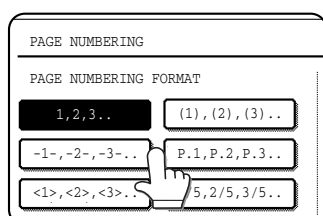

The selected format is highlighted.

If you selected "1/5, 2/5, 3/5",

"PAGE NUMBER/TOTAL PAGES" will be printed. "AUTO" is initially selected for "TOTAL PAGE", which means that the number of scanned original pages is automatically used. If you need to enter the total pages manually (for example, when a large number of originals are scanned in batches), touch the [MANUAL] key to display the total page entry screen.

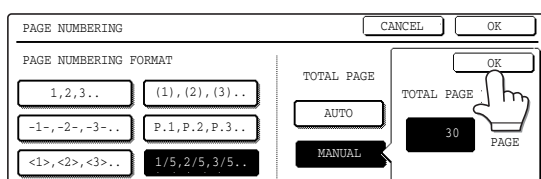

Enter the total pages (1 to 999) with the numeric keys and touch the [OK] key.

NOTES

- When two-sided copying is performed, each side of the paper is counted as a page. If the last page is blank, it will not be included in the total pages. However, if [COUNT BACK COVER] is selected, the last page will be counted. (See step 7.)
- When used in combination with "Dual page copy", "Multi shot", or "Card shot", the number of copied images is the total pages.
- When used in combination with "Pamphlet copy" or "Book copy", the number of pages in the "book" is the total pages.

4 If you need to change the starting or ending number of page numbering, the first page printed on, or the print settings for covers/inserts, touch the [PAGE NUMBER] key.

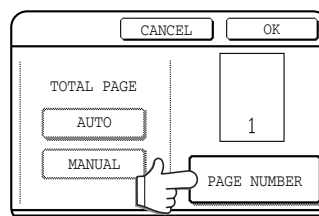

5 Touch the [MANUAL] key.

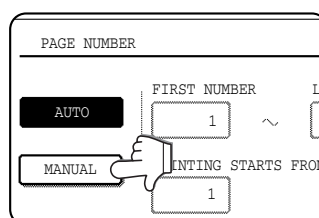

6 Enter settings for "FIRST NUMBER", "LAST NUMBER", and "PRINTING STARTS FROM SHEET".

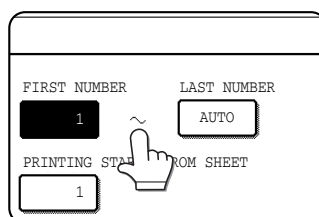

Touch each key so that it is highlighted, and then enter the number with the numeric keys (1 to 999).

To return a number to its initial value (FIRST

NUMBER: 1, LAST NUMBER: AUTO, PRINTING STARTS FROM SHEET: 1), touch the [C] (clear) key while the key of the number is highlighted. If you enter the wrong number, press the [C] (clear) key and enter the correct number.

NOTES

- A last number smaller than the "FIRST NUMBER" cannot be set.
- "LAST NUMBER" is initially set to "AUTO", which means that the page number is printed on each page through the final page in accordance with the "FIRST NUMBER" and "PRINTING STARTS FROM SHEET" settings.
- A number less than the total page number is set as the last number, the page number will not be printed on the pages that follow the set number.
- Unlike the first and last page numbers, "PRINTING STARTS FROM SHEET" specifies the sheet of paper (not the page number) from which printing of the page number begins.
For example, when "3" is selected for one-sided copying, printing of the page number will start from the 3rd sheet of copy paper (the copy of the 3rd original page). When "3" is selected for two-sided copying, printing of the page number will start from the 3rd sheet of copy paper, which is the copy of the 5th original page.

7 When covers/inserts are added and you wish to include the covers/inserts in the page number count, touch the [COVERS/INSERTS COUNTING] key.

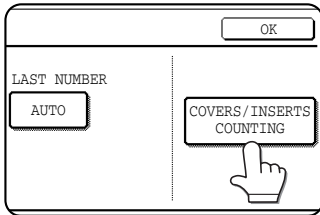

8 Select the checkboxes of the items that you wish to include in the page number count and then touch the [OK] key.

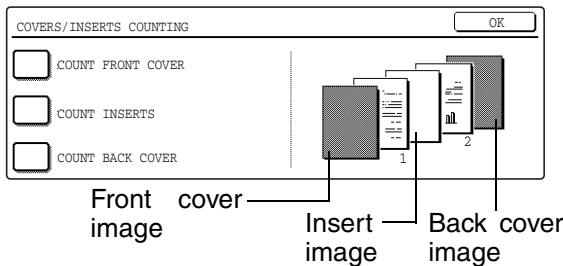

Items that are selected are reflected in the print image on the right side of the screen.

NOTES

- When an item is selected, one inserted sheet (front cover, insert, or back cover) is counted as one page during one-sided copying, and two pages during two-sided copying. However, if one-sided copying is used for the body pages and two-sided copying is used for the inserted sheets, each body page will be counted as one page and each inserted sheet will be counted as two pages.
- Printing never takes place on the front cover and back cover, regardless of whether or not these are counted.
- To print on an insert, the insert must be counted and it must be copied on.

9 Touch the [OK] key.

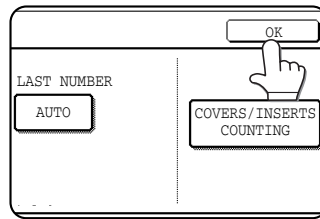

10 Touch the [OK] key.

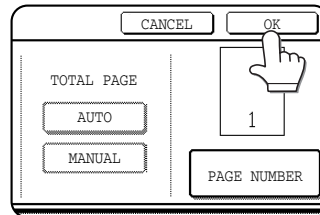

11 Continue from step 4 of "Common operation procedure for using the print menu" (page 5-33).

NOTE

To cancel a page number setting...
Touch the [CANCEL] key in the page number selection screen. (The screen of step 10.)

NOTES

- Copying in group mode is not possible when page number printing is selected. The mode will automatically switch to sort mode.
- When the page number print position is set to the left or right side and "Pamphlet copy" or "Book copy" is selected, the position of the page numbers will alternate so that they are always on the outside when the pamphlet/book is opened. If a stamp is set in an area with a page numbering setting, the position of the stamp will alternate in the same way.
If another item is set in a position that changes, that item will appear in the position that alternates with the page number position.
Print menus not related to the alternating print positions will appear in their set positions.
[Example] When the page number format "1, 2, 3.." is selected when performing pamphlet copying of 4 pages, the copies will appear as shown below.
In this example, the page number is at the bottom of the page and the date is at the top, so the position of the date does not change.

Print settings

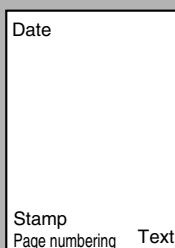

Front

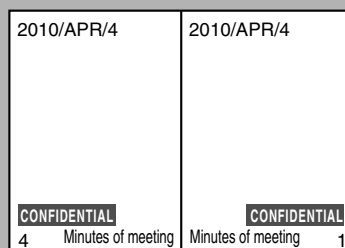

Back

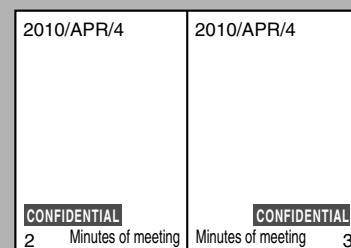

Examples of page number printing

Page number printing during one-sided copying (5 originals)

Setting	Value	1st page	2nd page	3rd page	4th page	5th page
TOTAL PAGE	AUTO	A 1/5	B 2/5	C 3/5	D 4/5	E 5/5
FIRST NUMBER	1					
LAST NUMBER	AUTO					
PRINTING STARTS FROM SHEET	1					
Printed contents when settings are changed as follows	FIRST NUMBER: 11	11/15	12/15	13/15	14/15	15/15
	FIRST NUMBER: 11 LAST NUMBER: 13	11/13	12/13	13/13	Not printed	Not printed
	TOTAL PAGE: 2	1/2	2/2	Not printed	Not printed	Not printed
	TOTAL PAGE: 15 FIRST NUMBER: 11 LAST NUMBER: 13	11/15	12/15	13/15	Not printed	Not printed
	PRINTING STARTS FROM SHEET: 3	Not printed	Not printed	1/3	2/3	3/3

Page number printing during two-sided copying (9 originals)

Setting	Value	1st page		2nd page		3rd page		4th page		5th page	
		Front	Back	Front	Back	Front	Back	Front	Back	Front	Back
TOTAL PAGE	AUTO	A 1/9	B 2/9	C 3/9	D 4/9	E 5/9	F 6/9	G 7/9	H 8/9	I 9/9	
FIRST NUMBER	1										
LAST NUMBER	AUTO										
PRINTING STARTS FROM SHEET	1										
Printed contents when settings are changed as follows	PRINTING STARTS FROM SHEET: 3	Not printed	Not printed	Not printed	Not printed	1/5	2/5	3/5	4/5	5/5	Not printed

Page number printing during one-sided copying of body pages with covers inserted (4 originals)

Setting	Value	1st page (Front cover)	2nd page	3rd page	4th page	5th page
TOTAL PAGE	AUTO	□	A 1/4	B 2/4	C 3/4	D 4/4
FIRST NUMBER	1					
LAST NUMBER	AUTO					
PRINTING STARTS FROM SHEET	1					
COUNT FRONT COVER	Not selected					
Printed contents when settings are changed as follows	PRINTING STARTS FROM SHEET: 2	Not printed	Not printed	1/3	2/3	3/3
	COUNT FRONT COVER: Selected	Not printed (count)	2/5	3/5	4/5	5/5
	COUNT FRONT COVER: Selected PRINTING STARTS FROM SHEET: 2	Not printed (count)	1/4	2/4	3/4	4/4

When a back cover is inserted, page numbers are counted and printed in the same way.

Note that page numbers are never printed on front and back covers.

Page number printing during two-sided copying of body pages with covers (one-side copying) inserted (9 originals)

Setting	Value	1st page (front cover)		2nd page		3rd page		4th page		5th page	
		Front	Back	Front	Back	Front	Back	Front	Back	Front	Back
TOTAL PAGE	AUTO										
FIRST NUMBER	1										
LAST NUMBER	AUTO										
PRINTING STARTS FROM SHEET	1	A		B 1/8	C 2/8	D 3/8	E 4/8	F 5/8	G 6/8	H 7/8	I 8/8
COUNT FRONT COVER	Not selected										
Printed contents when settings are changed as follows	PRINTING STARTS FROM SHEET: 3	Not printed	Not printed	Not printed	Not printed	Not printed	Not printed	1/4	2/4	3/4	4/4
	COUNT FRONT COVER: Selected	Not printed (count)	Not printed (count)	3/10	4/10	5/10	6/10	7/10	8/10	9/10	10/10
	COUNT FRONT COVER: Selected PRINTING STARTS FROM SHEET: 3	Not printed (count)	Not printed (count)	Not printed	Not printed	1/6	2/6	3/6	4/6	5/6	6/6

When a back cover is inserted, page numbers are counted and printed in the same way. Note that page numbers are never printed on front and back covers.

Page number printing during one-sided copying with inserts (4 originals; 5 originals when copying on inserts)

Setting	Value	1st page	2nd page	3rd page (insert)	4th page	5th page
TOTAL PAGE	AUTO					
FIRST NUMBER	1					
LAST NUMBER	AUTO					
PRINTING STARTS FROM SHEET	1	A 1/4	B 2/4	C 3/4	D 4/4	E 5/5
COUNT INSERTS	Not selected					
Printed contents when copying on inserts and settings are changed as follows	PRINTING STARTS FROM SHEET: 3	Not printed	Not printed	Not printed	1/2	2/2
	COUNT INSERTS: Selected	1/5	2/5	3/5 (count)	4/5	5/5
	COUNT INSERTS: Selected PRINTING STARTS FROM SHEET: 3	Not printed	Not printed	1/3 (count)	2/3	3/3
Printed contents when not copying on inserts and settings are changed as follows	COUNT INSERTS: Selected	1/5	2/5	Not printed (count)	4/5	5/5
	COUNT INSERTS: Selected PRINTING STARTS FROM SHEET: 3	Not printed	Not printed	Not printed (count)	2/3	3/3

When inserts are not copied on, the page number is not printed.

Page number printing during two-sided copying of body pages with inserts (one-side copying) (9 originals)

Setting	Value	1st page		2nd page		3rd page (insert)		4th page		5th page	
		Front	Back	Front	Back	Front	Back	Front	Back	Front	Back
TOTAL PAGE	AUTO										
FIRST NUMBER	1										
LAST NUMBER	AUTO										
PRINTING STARTS FROM SHEET	1	A 1/8	B 2/8	C 3/8	D 4/8	E 5/8		F 6/8	G 7/8	H 8/8	I 9/8
COUNT INSERTS	Not selected										
Printed contents when settings are changed as follows	COUNT INSERTS: Selected	1/10	2/10	3/10	4/10	5/10	Not printed (count)	7/10	8/10	9/10	10/10

■ Printing entered text on copies

Entered text can be printed on copies. Up to 50 characters can be printed.

Up to 30 sequences of frequently used text can be stored. See "Storing text sequences" (page 5-42).

NOTE

When the machine is connected to a network, the printed text sequences can be stored and deleted in the Web page. For details, see Help in the Web page.

1 Follow steps 1 and 2 of "Common operation procedure for using the print menu" (page 5-33).

2 Touch the [TEXT] key.

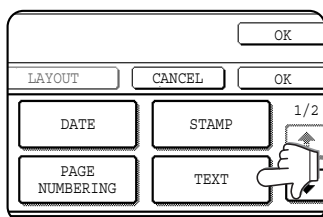

3 If you wish to use one of the preset text sequences, touch the [RECALL] key. To directly enter the text, touch the [DIRECT ENTRY] key.

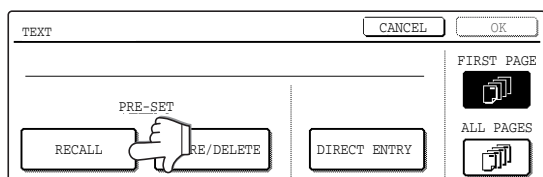

If you touch the [DIRECT ENTRY] key, a character entry screen will appear. For information on entering characters, see page 7-29. When finished, click the [OK] key to close the character entry screen. (Go to step 6.)

4 The stored text sequences will appear as keys. Touch the key of the desired text sequence.

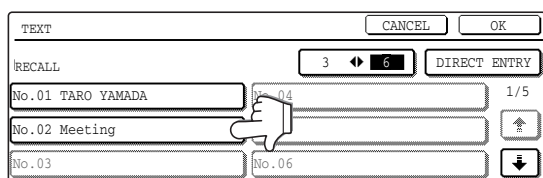

The selected text sequence key is highlighted. If the desired text sequence key does not appear, change screens with the or key. The display is initially set to show 6 keys per screen. This can be changed to 3 keys per screen by touching the [3 ◀▶ 6] key. When 3 keys are displayed, the entire text sequence will appear in each key. (When 6 keys are displayed, up to 22 characters appear in each key.)

5 Touch the [OK] key.

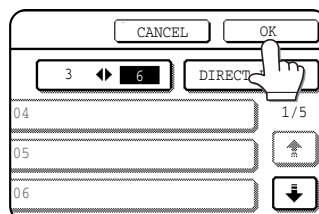

To edit the selected text sequence, touch the [DIRECT ENTRY] key to display the character entry screen. The selected text sequence is entered. For information on entering characters, see page 7-29. When finished, touch the [OK] key to close the character entry screen.

6 Select the pages to be printed on.

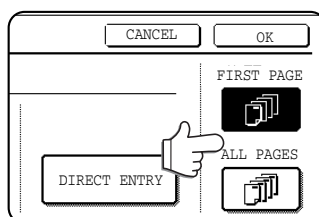

Select whether to print on only the first page, or all pages. The touched key is highlighted.

7 Touch the [OK] key.

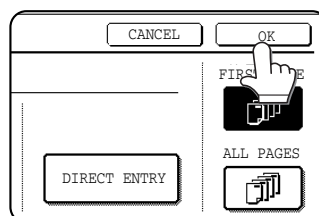

8 Continue from step 4 of "Common operation procedure for using the print menu" (page 5-33).

NOTE

To cancel a text setting...

Touch the [CANCEL] key in the text print screen. (The screen of step 7.)

Storing text sequences

- 1 Follow steps 1 and 2 of "Common operation procedure for using the print menu" (page 5-33).
- 2 Touch the [TEXT] key.

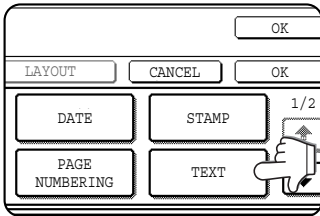

- 3 Touch the [STORE/DELETE] key.

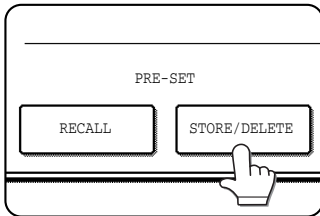

- 4 Touch a key that has not been programmed (a key in which No. xx appears).

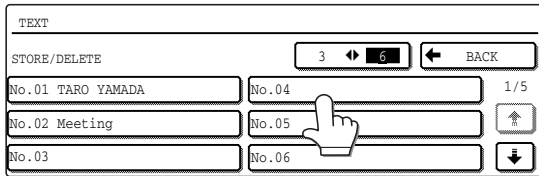

When touched, the character entry screen appears. Enter the text (max. 50 characters). For information on entering characters, see page 7-29. When finished, touch the [OK] key to close the character entry screen. If no free keys appear, change screens with the or key.

- 5 Touch the [BACK] key.

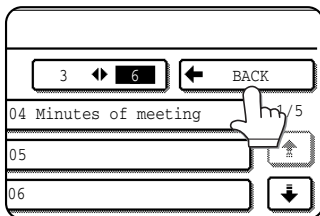

The entered text is stored.

Editing and deleting stored text

- 1 Follow steps 1 and 2 of "Common operation procedure for using the print menu" (page 5-33).
- 2 Touch the [TEXT] key.

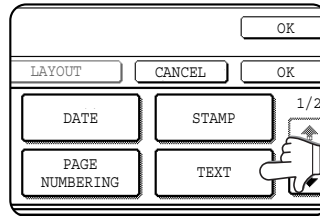

- 3 Touch the [STORE/DELETE] key.

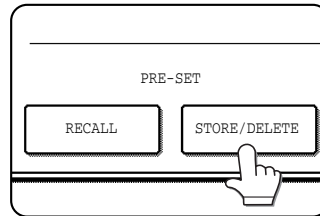

- 4 Touch the text key that you wish to edit or delete.

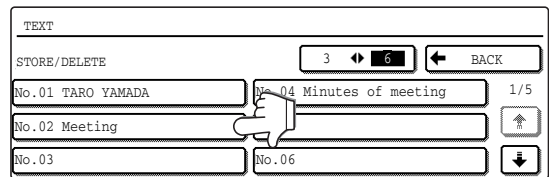

- 5 To edit the text, touch the [AMEND] key. To delete the text, touch the [DELETE] key.

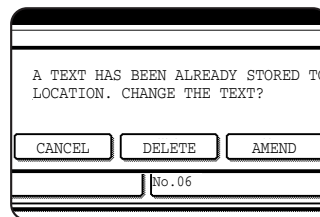

When the [AMEND] key is touched, the character entry screen appears. The selected text sequence is entered. For information on entering characters, see page 7-

29. When finished, touch the [OK] key to close the character entry screen. If you touch the [DELETE] key, the text will be deleted and you will return to the screen of step 4. To cancel editing or deletion, touch the [CANCEL] key.

- 6 Touch the [BACK] key.

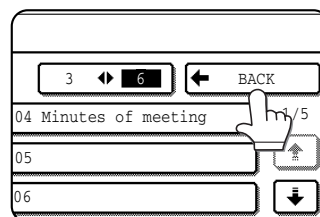

■ Checking and changing the print layout

You can check the print layout after the print items have been selected. If needed you can change the print position or delete print content.

1 Touch the [LAYOUT] key on the print menu screen.

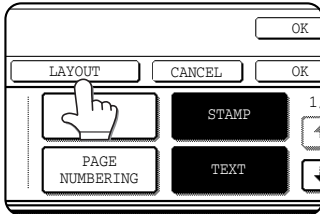

2 Touch the key in which you wish to change the print position or delete print content.

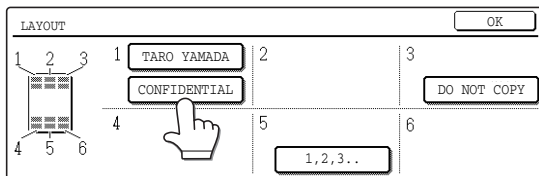

NOTE

Up to 14 characters of the print text appears in the key.

3 To change the print position, touch the [MOVE] key. To delete print content, touch the [DELETE] key.

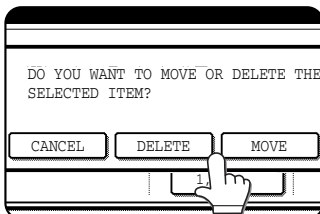

If you touched the [MOVE] key, the new position selection screen appears.

If you touched the [DELETE] key, the print content is deleted. (Go to step 6.)

4 Touch the key of the new position.

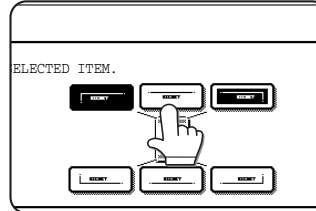

The selected key is highlighted and the print position changes to the new position.

The keys indicating the print position appear as follows depending on the state of the setting:

	Print position without any set print menus.
	Currently set print position.
	Print position with another competing print menu set. (When moving a stamp, this indicates that another stamp has been set. When moving a print menu other than a stamp, this indicates that the date, page number, or text has been set.)

NOTE

If you wish to swap the contents of two positions, temporarily move the content of one position to an unused position and then complete the swap.

5 Touch the [OK] key.

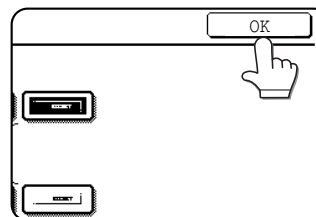

If you attempt to move print content to a position that already has print content set, a message will appear asking you if you wish to overwrite the previously set content.

To overwrite the content, touch the [YES] key. To cancel the move and return to the condition before the [OK] key was touched, touch the [NO] key.

6 Touch the [OK] key.

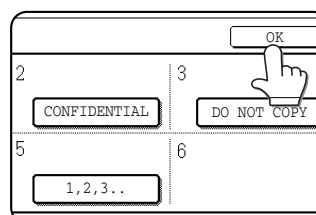

STORING, USING AND DELETING JOB PROGRAMS

The steps of up to 10 copy jobs can be stored as job programs. Job programs can be called up with ease, and are retained even when the power is turned off. By storing frequently used copy settings in a job program, you can eliminate the bother of selecting the settings each time you use them for a copy job.

- If any settings related to the steps of a job program are changed in the administrator settings after the job program is stored, the steps related to the changed settings will not be included when the job program is called up.
- To exit the job programs mode, press the [CA] (clear all) key on the operation panel or touch the [EXIT] key on the touch panel.

Storing a job program

1 Press the [#/P] key.

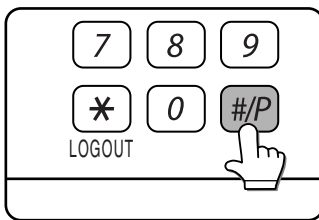

2 Touch the [STORE/DELETE] key.

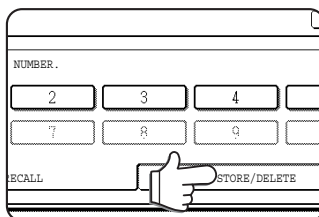

3 Touch the number key ([1] to [10]) in which you wish to stored the job program.

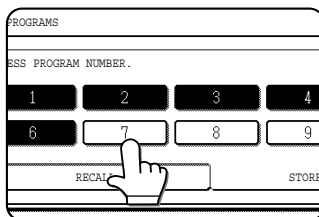

Number keys in which job programs are already stored are highlighted.

4 Select the copy settings that you wish to store in the job program.

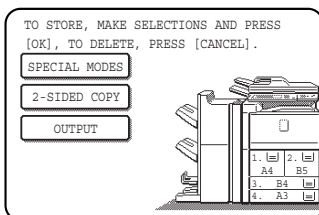

The number of copies cannot be stored.

5 Touch the [OK] key.

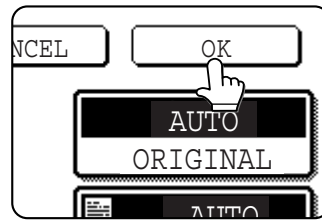

The selected settings will be stored in the number key selected in step 3.

■ If a number key is selected in step 3 that has already been programmed.

A setting confirmation screen will appear. To replace the existing program with the new program, touch the [STORE] key and continue from step 4. If you do not wish to replace the existing program, touch the [CANCEL] key to return to the screen of step 3 and select a different number key.

NOTE

If overwriting of programmed copy settings has been prohibited in the administrator settings, it will not be possible to store or delete a job program. (See page 17 of the administrator settings guide.)

Calling up a job program

1 Press the [#P] key.

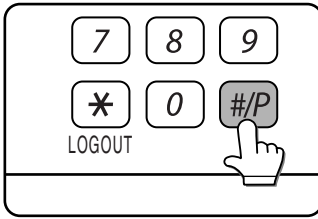

2 Touch the number key of the desired job program.

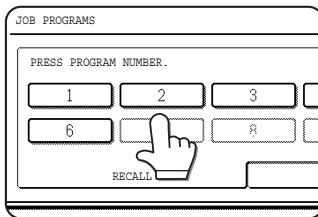

The screen automatically closes and the job program is called up. A number key that does not have a job program cannot be selected.

3 Set the number of copies if needed and then press the [START] key.

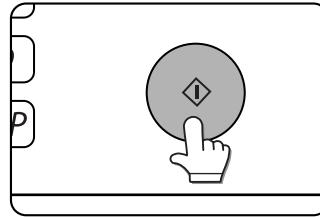

Copying will begin using the settings of the job program.

Deleting a stored job program

1 Press the [#P] key.

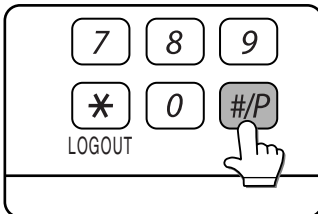

2 Touch the [STORE/DELETE] key.

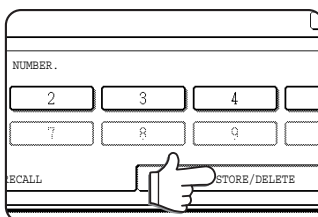

3 Select a storage register number of the program to be deleted.

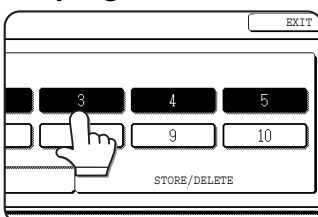

If a number key for which no job program has been stored is selected, the screen will change to the screen of step 4 on the previous page for storing a job program.

4 Touch the [DELETE] key.

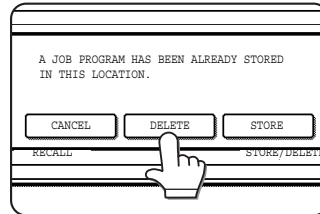

The selected program is deleted and you return to the screen of step 3. To return to the screen of step 3 without deleting the job program, touch the [CANCEL] key. In both cases, touch the

[EXIT] key on the screen displayed in the screen of step 3 to exit the job program mode.

NOTE

If overwriting of programmed copy settings has been prohibited in the administrator settings, it will not be possible to store or delete a job program. (See page 17 of the administrator settings guide.)

INTERRUPTING A COPY RUN

The copy of the original scanned in interrupt mode is output before the remainder of the interrupted copy job.

1 Touch the [INTERRUPT] key.

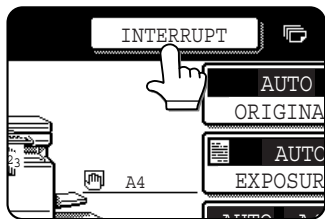

If interrupt copying is possible during a copy run, the [INTERRUPT] key will appear. (If the key does not appear, interrupt copying is not possible.)

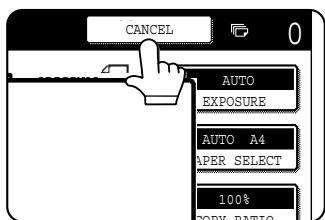

When the [INTERRUPT] key is touched in step 1, the [INTERRUPT] key will be replaced by the [CANCEL] key as shown in the illustration.

To cancel an interrupt copy job while the interrupt original is being scanned or while you are selecting copy settings, touch the [CANCEL] key.

NOTES

- If you touch the [INTERRUPT] key when auditing mode is enabled, the display will prompt you to enter your account number. Enter your account number with the numeric keys. The copies you make will be added to the count of the entered account number.
- If a copy is being printed when the [INTERRUPT] key is pressed, interrupt mode will begin after the copy is finished.
- If the copy run to be interrupted is using paper from the bypass tray, the paper size and type of the bypass tray cannot be changed for use by the interrupt job.
- If the document glass is used for an interrupt copy job, two-sided copying, sort copying, and staple sort copying cannot be selected. If any of these functions are necessary, use the document feeder.

2 Place the original for the interrupt copy job in the document feeder or on the document glass (page 4-3).

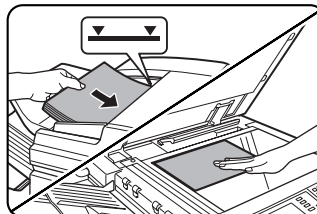

3 Select the exposure mode, paper size, number of copies, and any other copy settings as needed, and then press the [START] key.

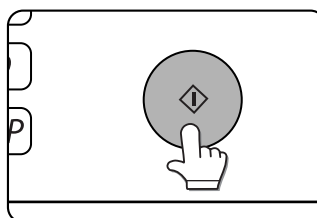

4 The previous copy job automatically resumes after the interrupt job finishes.



CHAPTER 6

MACHINE MAINTENANCE (FOR COPYING)

This chapter explains procedures for cleaning the machine, and troubleshooting.

	Page
USER MAINTENANCE	6-2
• Cleaning the document glass and the automatic document feeder	6-2
TROUBLESHOOTING	6-3

USER MAINTENANCE

To ensure good service from this product over a long period of time, it is recommended that the following maintenance procedures be performed on a regular basis.

CAUTION

Do not use flammable spray to clean the machine. If gas from the spray comes in contact with hot electrical components or the fusing unit inside the machine, fire or electrical shock may result.

NOTE

When cleaning, do not use thinner, benzene, or similar volatile cleaning agents.

Cleaning the document glass and the automatic document feeder

If the document glass, document cover or automatic document scanning unit have dirty spots, these spots will form lines in scanned images. These will show up as defects when the images are printed. Always keep these parts clean.

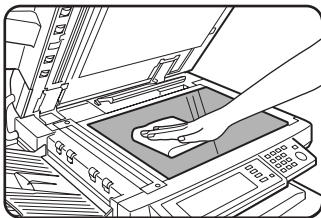

Wipe with a clean, soft cloth. If necessary, moisten the cloth with water or a small amount of neutral detergent. When finished, wipe dry with a clean cloth.

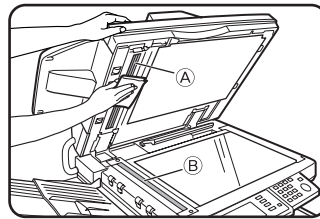
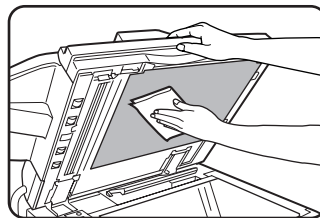

If black or white stripes appear on printed images of originals that were fed through the automatic document feeder, wipe the long narrow glasses in the scanning unit (A and B in the illustration).

scanning unit (A and B in the illustration).

Example of dirty print image

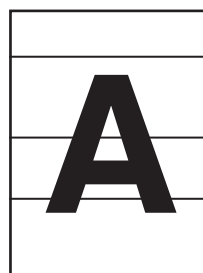

Black stripes



White stripes

TROUBLESHOOTING

Check the following troubleshooting list before requesting service as many problems can be fixed by the user. If you are unable to solve the problem by checking the list, turn off the main power switch and the power switch, and unplug the power cord.

Problems related to the copy function are described below. For problems related to general use of the machine, see page 2-32.

Problem	Check	Solution
Machine does not operate.	Is the [START] key indicator off?	This indicates that the machine is warming up (warming up lasts no more than 120 seconds after the power switch is turned on). Copying is not possible during this time. Wait until the [START] key light illuminates.
Copies are too dark or too light.	Is the original image too dark or too light?	Select an appropriate exposure mode for the original being copied and adjust the copy exposure. (See page 4-14.)
	Is the exposure mode set to "AUTO"?	The exposure level for "AUTO" can be adjusted using "Exposure adjustment" in the administrator settings. Contact your administrator. (See page 16 of the administrator settings guide.)
	An appropriate exposure mode for the original has not been selected.	Change the exposure mode to "AUTO" or manually select an appropriate resolution setting. (See page 4-14.)
Text is not clear on a copy.	An appropriate exposure mode for the original has not been selected.	Change the exposure mode to "TEXT". (See page 4-14.)
Smudges appear on copies.	Document glass or document cover dirty?	Clean regularly. (See page 6-2.)
	Black lines appear on copies when the automatic document feeding function is used.	Clean the original scanning area. (See page 6-2.)
	Original smudged or blotchy?	Use a clean original.
Image cannot be rotated.	Is the auto paper select or auto image function selected?	Rotation copy functions only if the machine is either in the auto paper select mode or in the auto image mode. (See page 4-15.)
Part of original image is not copied.	Is the original positioned correctly?	Set the original properly. (See page 4-3.)
	Is the copy ratio proper for the original and paper sizes?	Use the auto image function to select the appropriate copy ratio based on the original and copy sizes. (See page 4-15.)
Blank copies	Is the original placed correctly?	When using the document glass, place the original face down. When using the automatic document feeder, place original face up. (See page 4-3.)
Order of copies incorrect	Is the order of originals correct?	When using the document glass, place the originals from the first page one sheet at a time. When using the automatic document feeder, place the originals with the first page up.
Job cancellation needed	Is a message requesting cancellation of job displayed?	Press the [CA] key to cancel the current job.

CHAPTER 7

DOCUMENT FILING FUNCTION

	Page
OVERVIEW	7-2
• Document filing function.....	7-2
TO USE THE DOCUMENT FILING FUNCTION.....	7-4
• A look at the operation panel	7-4
• Saving files.....	7-4
• Main screen of document filing	7-5
• Document filing icons.....	7-5
SAVING A DOCUMENT IMAGE FILE	7-6
• Quick File	7-6
• Filing.....	7-7
• Print jobs	7-9
• Scan Save	7-10
CALLING UP AND USING A FILE.....	7-13
• Searching for and calling up a saved file.....	7-13
• Calling up and using a saved file.....	7-15
SYSTEM SETTINGS	7-24
• Creating, editing, and deleting user names and folders.....	7-24
ENTERING CHARACTERS	7-29
TROUBLESHOOTING	7-31

OVERVIEW

Document filing function

The document filing function allows you to save a document image in the machine's hard disk as a data file. The image can be called up and printed or transmitted as needed.

The scanned document image is saved when printing or transmitting a document in copy mode, printer mode, or image send mode ("QUICK FILE" or "FILE"). A document can also be scanned and saved without being printed, copied, or transmitted ("scan save").

To allow you to search for the file and call it up, names (user name, file name, etc.) can be assigned to the file (except when using Quick File).

■ Data flow

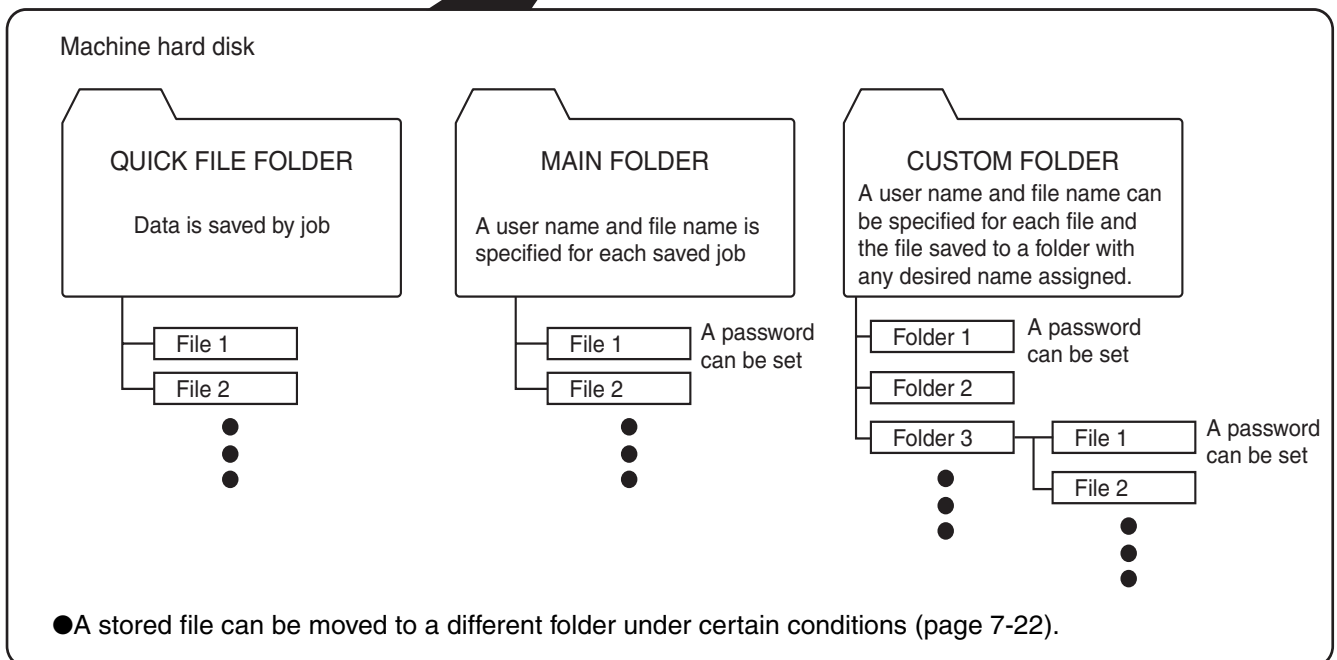
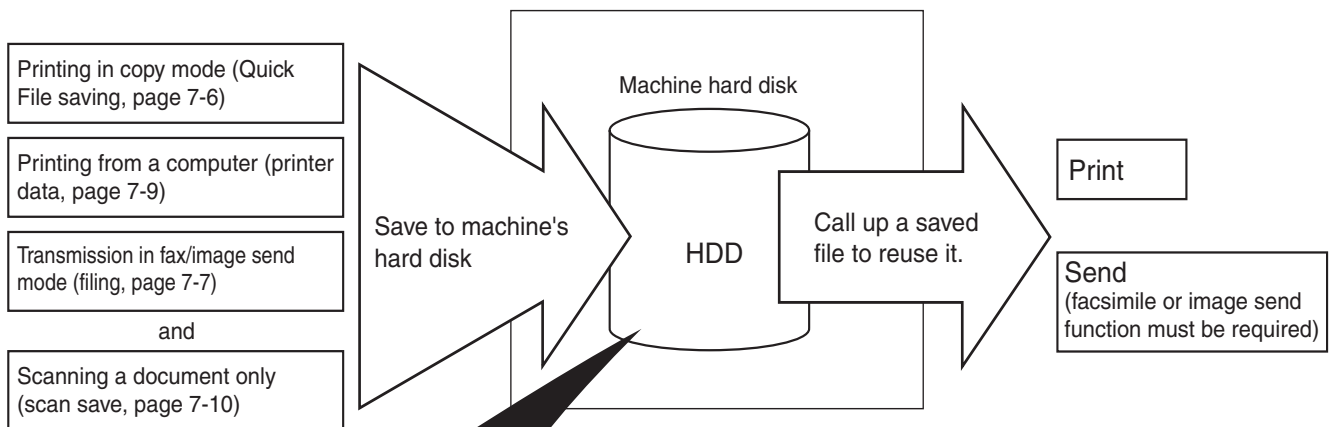

■ Quick File folder

When [QUICK FILE FOLDER] is selected in the main screen of any of the modes, the file is saved in this folder. Up to 1000 files can be saved in the Quick File folder. All files in the Quick File Folder can be deleted using the administrator settings. If you have a file that you do not want deleted, set the file attribute to [PROTECT] (up to 500 files can be protected). (See [Property change] on page 7-21)

The following user and file names are automatically assigned (the names cannot be selected):

User name : User unknown

File name (example) : COPY_04042010_113050AM (job mode and month, day, year, hour, minute, second, AM/PM of save). (In the example, the file was saved on 4/4/2010 at 11:30 and 50 sec in copy mode.)

When saved, jobs are classified by mode. A saved job can be called up from the COMPLETE job status screen.

■ Main folder

When saving a file, a previously stored user name (see [SYSTEM SETTINGS] on page 7-24) can be specified and any file name can be assigned.

A password can also be set for a saved file ([CONFIDENTIAL] save). (See [Property change] on page 7-21.)

If a user name and file name are not selected, a name in the same format as Quick File is automatically assigned.

■ Custom folder

Up to 500 folders (named as desired) can be created in this folder. When saving a file in one of these folders, a previously stored user name (see [SYSTEM SETTINGS] on page 7-24) can be specified and any file name can be assigned.

A password can be set for a file saved in one of these folders.

■ Attributes of saved files

The protect setting can be selected for files saved with the document filing function. This prevents a file from being moved or automatically or manually deleted.

Three attributes are available for saved files: [SHARING], [PROTECT], and [CONFIDENTIAL]. When saved with the [SHARING] attribute, a file is not protected. When saved with the [PROTECT] or [CONFIDENTIAL] attribute, a file is protected.

Files saved to the Quick File folder are all [SHARING]. When saving a file to the main folder or a custom folder, [SHARING] or [CONFIDENTIAL] can be selected.

- A [SHARING] file can be changed to a [PROTECT] or [CONFIDENTIAL] file using [Property change] (page 7-21).
- A password is set for a [CONFIDENTIAL] file to protect it. (The password must be entered to call up the file.)
- A password cannot be set for a [PROTECT] file, however, as long as the file is not changed to [SHARING] with [PROPERTY CHANGE], the file will be protected.

CAUTION

- Documents saved with [QUICK FILE] are shared files that can be called up by anyone and printed or transmitted. For this reason, do not use Quick File for sensitive documents or documents that you do not want to be reused by others.
- When saving a document with [FILE], set the attribute to [CONFIDENTIAL] and set a password to prevent others from reusing the document.
- Even when a file is saved with the [CONFIDENTIAL] attribute, the attribute can be changed afterward to [SHARING] using [Property change] (page 7-21). For this reason, do not save sensitive documents or documents that you do not want to be reused by others.
- Except in cases provided for by law, SHARP Corporation bears no responsibility for any damages that result from the leaking of sensitive information due to 1) manipulation by a third party of any data saved using the Quick File function or filing function, or 2) incorrect operation of the Quick File function or filing function by the operator that saves the data.

TO USE THE DOCUMENT FILING FUNCTION

A look at the operation panel

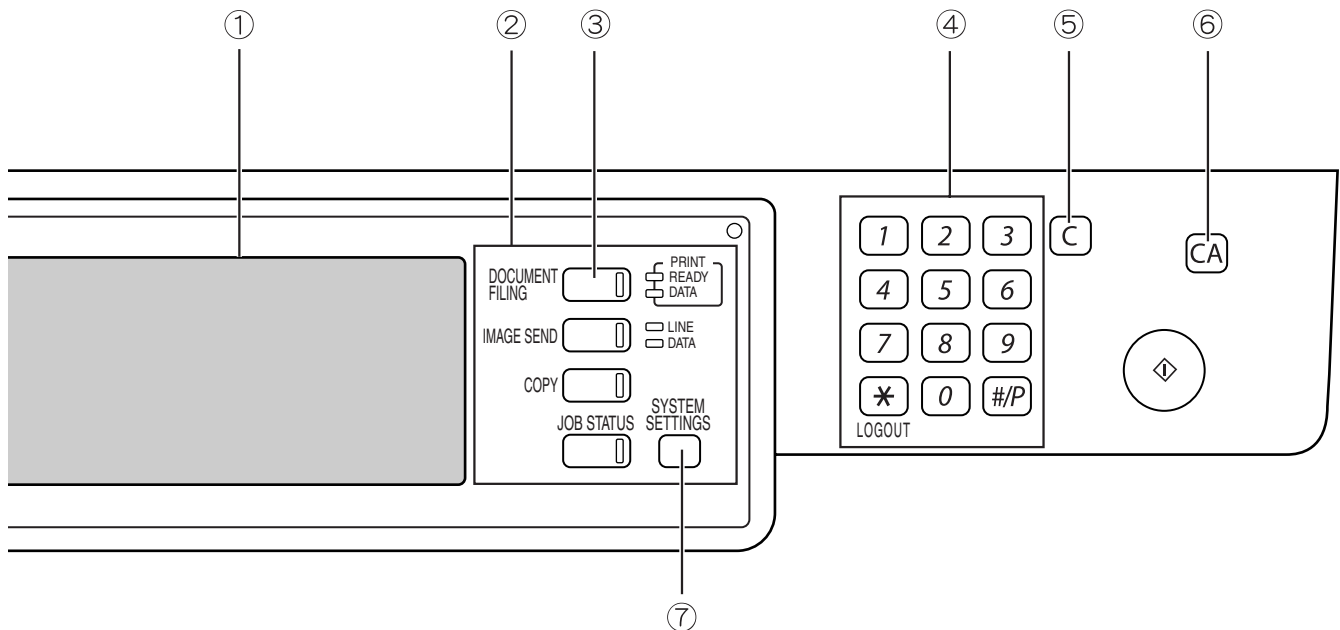

① **Touch panel (see the next page)**

This displays messages and keys. Keys can be touched to select and enter settings.

When a key is touched, a beep will sound and the key will be highlighted to indicate that it is selected. When a key cannot be selected in a screen, it will be greyed out. If touched, a warning beep will sound to alert you that it cannot be selected.

② **Mode select keys**

Use this key to select the mode.

③ **[DOCUMENT FILING] key**

Touch this key to display the main screen of document filing mode.

④ **Numeric keys**

Use these keys to enter a password or a numeric value for a setting.

⑤ **[C] key (Clear key)**

Use this key if you make a mistake when entering a password or numeric setting.

This key is also used to cancel scanning of a document.

⑥ **[CA] key (Clear all key)**

Use this key to cancel a setting procedure and return to the main screen. The key is also used to cancel a special function.

⑦ **[SYSTEM SETTINGS] key**

Use this key to store, edit or delete a user name or custom folder.

Saving files

To save files to the main folder or custom folders, a user name must be previously stored. To create a folder in the custom folder, the folder name must be stored. These settings are configured in the system settings.

Follow the procedures explained in "Programming a user name", "Editing and deleting a user name", "Creating a custom folder", and "Editing/deleting a custom folder" on pages 7-25 to 7-28.

Main screen of document filing

To display the main screen of document filing, press the [DOCUMENT FILING] key when the touch panel shows the copy mode screen, image send mode, or the job status screen.

The main screen shows messages, keys, and items that can be selected for document filing.

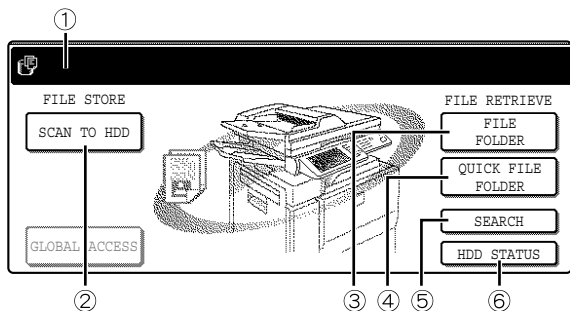

- ① **Message display**
Displays messages.
- ② **[SCAN TO HDD] key**
Touch to select scan save. Scan save is used to save the image file of a scanned document in the main folder or a custom folder without printing or transmitting the document.
- ③ **[FILE FOLDER] key**
Touch to call up a file from the main folder or the custom folder. When the key is touched, the files in the main folder or the folders in the custom folder appear.
- ④ **[QUICK FILE FOLDER] key**
Touch to call up a file from the Quick File folder. When the key is touched, the files in the Quick File folder appear.
- ⑤ **[SEARCH] key**
Touch to search for a file by user name, file name, or folder name.
- ⑥ **[HDD STATUS] key**
Touch to check the use of the machine's hard disk.

Document filing icons

Main icon	Icon of confidential file or folder	Icon of protected file	Meaning
			Folder
			Copy job file
			Print job file (including direct print jobs)
			Fax transmission job file
			PC-FAX transmission job file
			Internet fax transmission job file
			PC-Internet fax transmission job file
			Scan save file
			E-mail transmission job file
			FTP transmission job file
			Desktop transmission job file
			Network Folder transmission job file

The following icons may appear added to a main icon or alone.

Icon	Meaning
	Confidential file or folder
	Protected file

NOTE
When the file of a job that was saved using scan save is printed in job settings, the icon of the job is highlighted.

SAVING A DOCUMENT IMAGE FILE

Quick File

When printing or transmitting a document in copy mode, printer mode, or fax/image transmission mode, "QUICK FILE" can be selected to save an image of the document to the Quick File folder.

The image can be called up at a later time, allowing you to print or transmit the document without having to locate the original.

NOTE

As an example, the procedure for saving a document to the Quick File folder while copying using the automatic document feeding function is explained below.

- 1 Place the original in the document feeder and select resolution and exposure settings.**

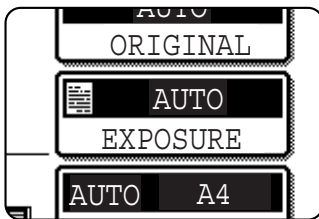

See steps 1 to 8 of "Making copies with the automatic document feeding function" on pages 4-7 to 4-8 and "ADJUSTING THE EXPOSURE" on page 4-14.

- 2 Touch the [QUICK FILE] key in the main screen.**

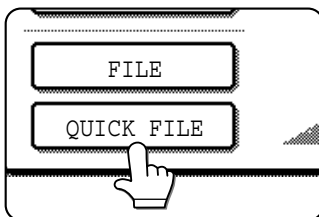

The [QUICK FILE] key will be highlighted to indicate that the function is selected.

If the [FILE] key is greyed out, only the [QUICK FILE] key can be selected.

When you touch the [QUICK FILE] key, a message asking you to confirm the save will appear. Touch the [OK] key in the message screen and go to the next step.

If you wish to cancel the save, touch the [QUICK FILE] key after touching the [OK] key so that the [QUICK FILE] key is no longer highlighted.

- 3 Press the [START] key on the operation panel.**

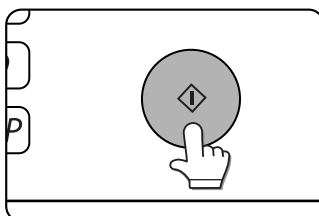

To prevent accidental saving of the document, the warning "THE SCANNED DATA IS STORED IN THE QUICK FILE FOLDER." appears for 6 seconds

after the [START] key is pressed.

When copying begins, the image is saved.

- 4 The saved image can be called up from the Quick File folder or the job status screen.**

- To call the image up from the Quick File folder, see "Calling up and using a saved file" on page 7-15.
- To call the job up from the finished job status screen, see "Calling up and manipulating a file from the job status screen" on page 7-23.

- 5 The following operations can be performed on the image that was called up in step 4.**

- Print the image (page 7-17)
- Transmit the image (page 7-20)
- Change the attribute (page 7-21)
- Move the image (page 7-22)
- Delete the image (page 7-22)
- Check details on the image (page 7-22)

Filing

When printing or transmitting a document in copy mode, printer mode, or image send mode, "FILE" can be selected to save an image of the document to the main folder or a previously created custom folder. The image can be called up at a later time, allowing you to print or transmit the document without having to locate the original.

NOTE

As an example, the procedure for using the filing function while copying using the automatic document feeding function is explained below.

1 Place the original in the document feeder and select resolution and exposure settings.

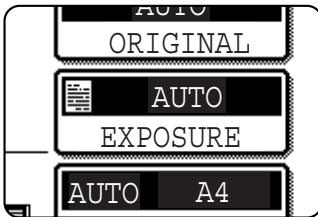

See steps 1 to 8 of "Making copies with the automatic document feeding function" on pages 4-7 to 4-8 and "ADJUSTING THE EXPOSURE" on page 4-14.

2 Touch the [FILE] key in the main screen.

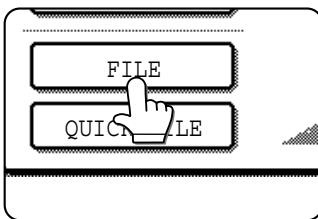

An information entry screen appears.

3 Touch the [USER NAME] key.

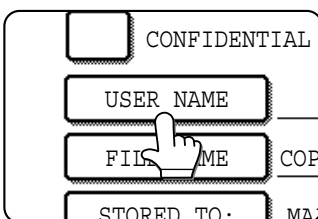

4 Touch the desired user name in the list of user names that appears.

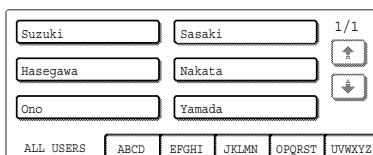

User names must be previously stored ("Programming a user name" on page 7-25).

5 Touch the [OK] key.

The touched user name is selected and you return to the screen of step 3. The selected user name appears.

NOTE

If you do not select a user name, the following name is automatically selected:

Example : User unknown

6 Touch the [FILE NAME] key.

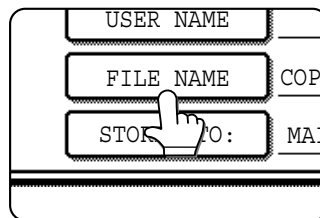

A character entry screen appears. Enter a file name (maximum of 30 characters). (See page 7-29 to enter characters.)

NOTE

If you do not enter a file name, a file name in the following format is automatically assigned:

Auto generated file name : Month, day, year, hour, minute, second, AM/PM

(Example : COPY_04042010_113050AM)

7 Touch the [STORED TO:] key.

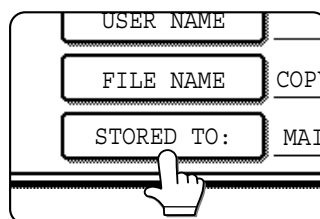

8 Touch the desired folder name in the list of folder names that appears.

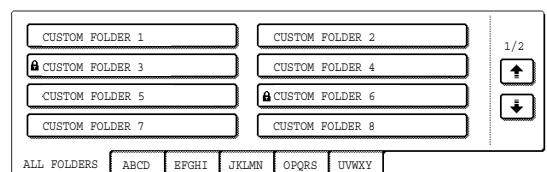

Folder names must be previously stored. ("Creating a custom folder" on page 7-27). If a password has been set for the folder, a password entry screen will appear. Enter the 5-digit password for the folder.

9 Touch the [OK] key.

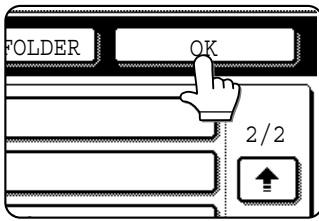

The touched folder is selected and you return to the screen of step 5. The selected folder name is displayed.

10 If needed, select the [CONFIDENTIAL] checkbox (only in copy mode).

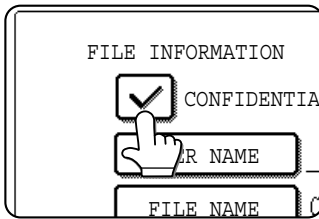

When this is selected, the file is stored with the attribute [CONFIDENTIAL]. To call up the file, the password that will be set in the following steps must be entered.

- If you selected the [CONFIDENTIAL] checkbox, touch the [PASSWORD] key and enter a password.
- If you did not select the [CONFIDENTIAL] checkbox, go to step 16. The file will be saved as a [SHARING] file.

11 Touch the [PASSWORD] key.

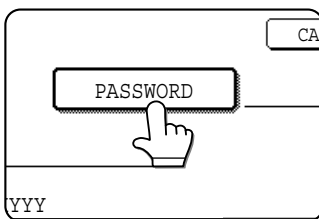

The password entry screen appears.

12 Enter a 5-digit password with the numeric keys.

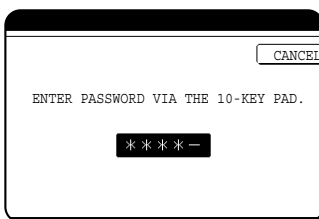

As each digit is entered, "-" changes to "*".

13 Touch the [OK] key.



14 You will return to the screen of step 4. The set password is displayed with "*".

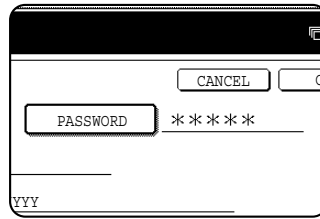

15 Touch the [OK] key.

You will return to the main screen.

16 Press the [START] key on the operation panel.

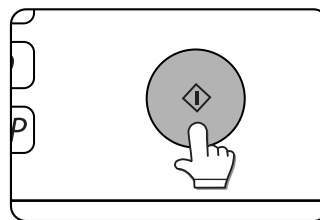

When copying begins, the image is saved.

17 The saved image can be called up using the file name, folder name, or user name, or from the filing folder.

- To call up the image by entering the file name, folder name, or user name, see "Searching for and calling up a saved file" on page 7-13.
- To call up the image from the filing folder, see "Calling up and using a saved file" on page 7-15.

18 The following operations can be performed on the image that was called up:

- Print the image (page 7-17)
- Transmit the image (page 7-20)
- Change the attribute (page 7-21)
- Move the image (page 7-22)
- Delete the image (page 7-22)
- Check details on the image (page 7-22)

Print jobs

Print jobs sent to the machine using the machine's printer driver can be saved in the main folder or a previously created custom folder when printed. The saved print data can be called up and printed or transmitted without having to open the original file on your computer.

This section gives an overview of this function and explains the procedure for printing from the operation panel of the machine.

For the procedures that are performed at your computer when initiating printing such as selecting the save location and file attribute, see the printer driver Help file.

■ Using a print job file (printing, deleting, transmitting, etc.)

1 Press the [DOCUMENT FILING] key on the operation panel.

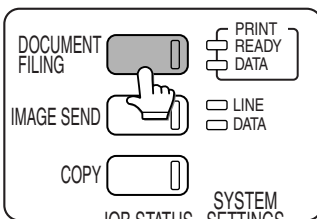

2 Touch the [FILE FOLDER] key or the [QUICK FILE FOLDER] key depending on where the file is saved.

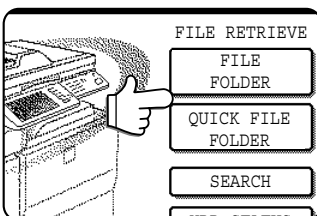

- Touch the [FILE FOLDER] key if the file is saved in the main folder or the custom folder. Touch the [QUICK FILE FOLDER] key if the file is saved in the Quick File folder.
- If you touched the [FILE FOLDER] key, the files in the main folder or the folders in the custom folder appear. If you open the wrong folder, touch the [MAIN FOLDER] key or the [CUSTOM FOLDER] key and open the correct folder.
- If the desired file is saved in the main folder, go to step 4. If the desired file is saved in a custom folder, go to step 3.
- If you touched the [QUICK FILE FOLDER] key, the files in the Quick File folder appear. Go to step 4.

3 Touch the key of the folder that contains the desired file.

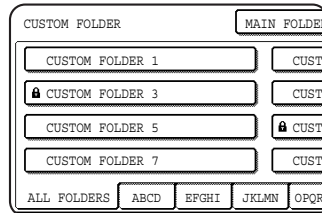

If a password is set for the selected folder, a password entry screen will appear. Enter the 5-digit password with the numeric keys.

4 Touch the printer icon () tab and then touch the key of the desired file.

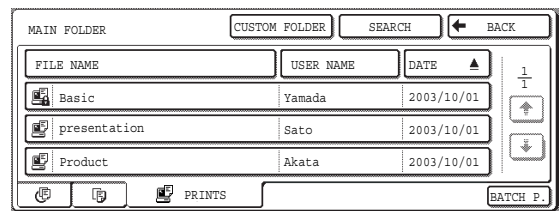

The following screen appears if the [QUICK FILE FOLDER] key is touched in step 2.

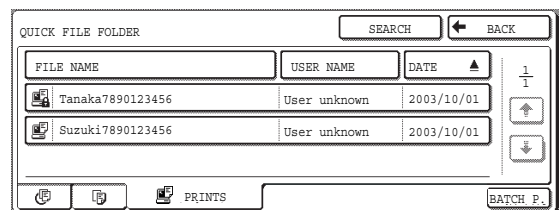

Touch the key of the file that you wish to call up. A menu screen will appear.

If a password is set for the file, a password entry screen will appear. Enter the 5-digit password with the numeric keys.

5 Touch the key of the operation that you wish to perform.

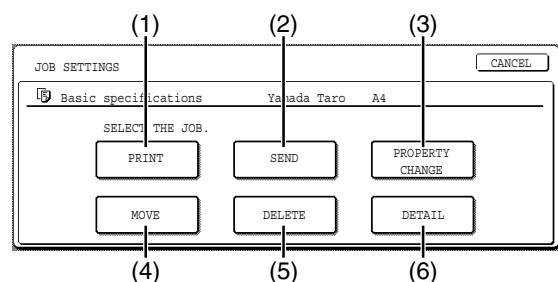

- (1) [PRINT] key (see page 7-17)
- (2) [SEND] key (see page 7-20)
- (3) [PROPERTY CHANGE] key (see page 7-21)
- (4) [MOVE] key (see page 7-22)
- (5) [DELETE] key (see page 7-22)
- (6) [DETAIL] key (see page 7-22)

The setting screen of the selected operation appears. See the indicated page.

Scan Save

Scan save is used to save a scanned document image in the main folder or the custom folder without copying or transmitting it.

1 Press the [DOCUMENT FILING] key on the operation panel.

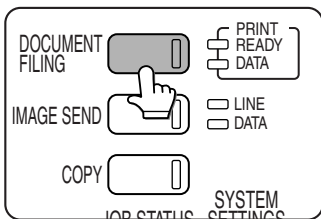

2 Touch the [SCAN TO HDD] key.



3 Touch the [SPECIAL MODES] key.

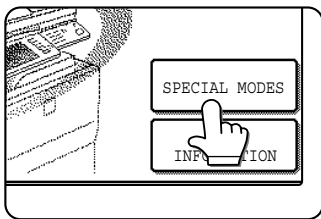

Select any special functions that you wish to use (otherwise skip this step).

When the [SPECIAL MODES] key is touched, the special modes selection screen appears. (See "Using special functions for scan save" on page 7-12.)

selection screen appears. (See "Using special functions for scan save" on page 7-12.)

NOTE

For explanations of the special functions, see page 7-12 and chapter 5.

4 Touch the [FILE INFORMATION] key.

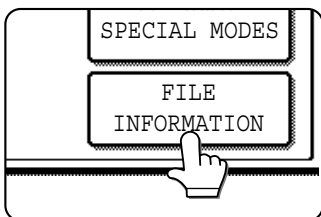

5 The screens for selecting the user name, file name, folder, and attribute appear. Configure the settings as explained in step 3 to step 15 on pages 7-7 to 7-8. When step 15 is completed, you will return to the main screen of document filing.

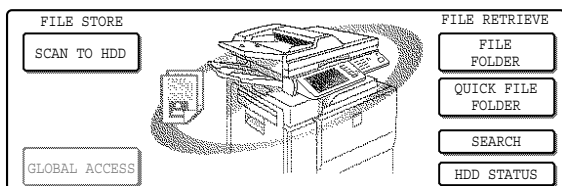

6 Perform any of the following steps 7 to 16 as needed. When finished, go to step 17 on page 7-11.

- To set the original size, perform steps 7 to 10.
- To set the resolution, perform steps 11 to 13 on page 7-11.
- To select the exposure, perform steps 14 to 16 on page 7-11.
- If you do not wish to select any of the above settings, go to step 17 on page 7-11.

7 Touch the [ORIGINAL] key.

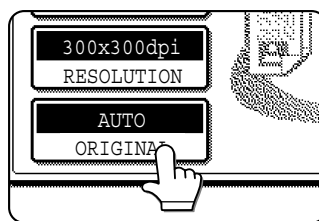

8 To set the original size, see "Manually setting the scanning size" on page 4-5.

9 If the original is two-sided, touch the [2-SIDED BOOKLET] key or the [2-SIDED TABLET] key depending on where the pages are bound.

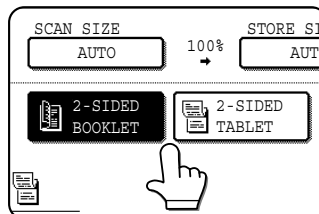

10 Touch the [OK] key.

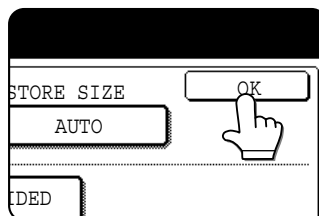

You will return to the screen of step 7.

NOTE

If the original pages are bound at the side, the document is a "booklet". If the original pages are bound at the top, the document is a "tablet".

11 Touch the [RESOLUTION] key.

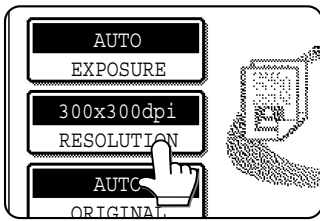

12 Touch the key of the desired resolution.

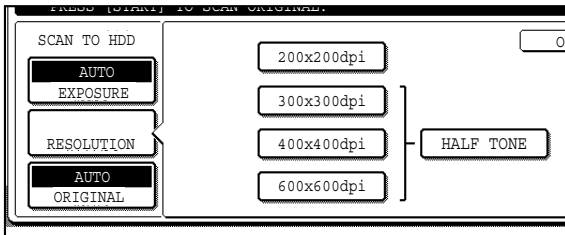

Select one of four resolution levels as appropriate for the original.
The selected resolution key is highlighted.

13 Touch the [OK] key.

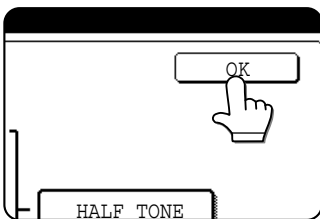

You will return to the screen of step 11.

14 Touch the [EXPOSURE] key.

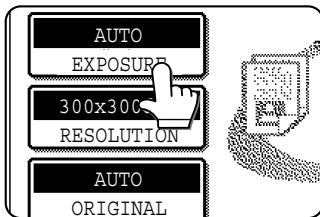

15 Select [AUTO] or [MANUAL].

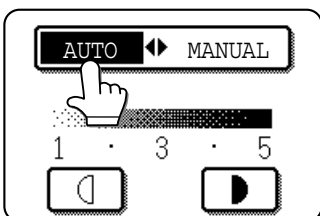

To have the exposure adjusted automatically, select [AUTO].

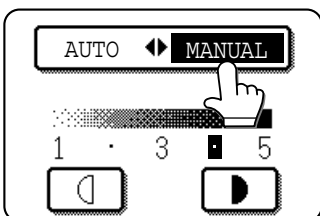

If you selected [MANUAL], touch the [] or [] key to adjust the exposure.
(For a darker image, touch the [] key. For a lighter image, touch the [] key.)

16 Touch the [OK] key.



You will return to the screen of step 14.

17 Place the original and touch the [START] key.

[Placing the original]

- For information on placing the original, see "NORMAL COPYING" in chapter 4.
- If you selected the "Card Shot" special function, the document glass must be used.
- If you selected job build mode, the automatic document feeding function must be used.

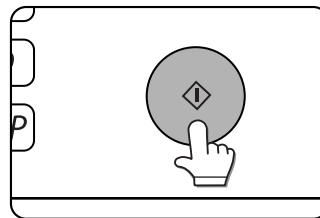

Scanning begins.
If you are using the document glass, touch the [READ-END] key after all pages have been scanned.

NOTE

This completes the scan save procedure. Follow the steps below when you wish to call up the image and print or transmit it.

18 The saved image can be called up using the file name, folder name, or user name, or from the filing folder.

- To call up the image by entering the file name, folder name, or user name, see "Searching for and calling up a saved file" on page 7-13.
- To call up the image from the filing folder, see "Calling up and using a saved file" on page 7-15.

19 The following operations can be performed on the image that was called up in step 18:

- Print the image (page 7-17)
- Transmit the image (page 7-20)
- Change the attribute ((page 7-21)
- Move the image (page 7-22)
- Delete the image (page 7-22)
- Check details on the image (page 7-22)

■ **Using special functions for scan save**

Touch the [SPECIAL MODES] key in the main scan save screen to display the special modes screen. The functions below can be selected in this screen.

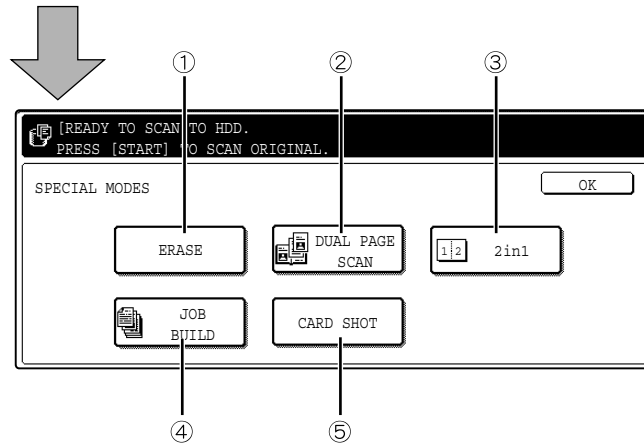
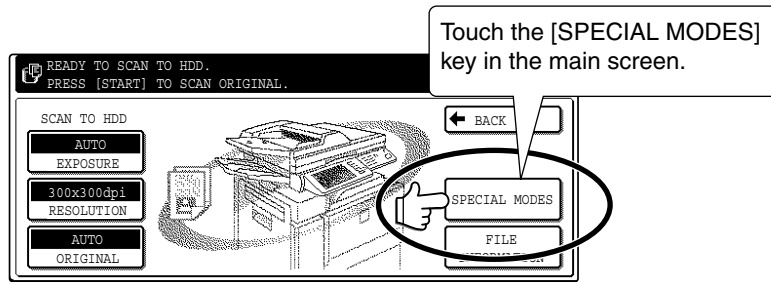

① **[ERASE] key (see page 5-4)**

Use this function to erase shadows that can appear around the edges of the image when books and other thick originals are scanned.

② **[DUAL PAGE SCAN] key (see page 5-5)**

(Equivalent to Dual page copy in copy mode)

This function is used to save the opened pages of a book in order one page at a time (left page then right page).

③ **[2in1] key (see page 5-24)**

(When the fax or image send function is installed, this corresponds to the 2in1 function explained in the fax and network scanner manuals. This also corresponds to the "Multishot" function in copy mode, however, only "2in1" is possible for scan save.)

This function reduces two original pages and arranges the images on a single page in a uniform layout.

④ **[JOB BUILD] key (see page 5-8)**

When you have more pages than can be placed in the document feeder at once, this function allows you to scan the pages in sets.

⑤ **[CARD SHOT] key (see page 5-29)**

This function allows you to save the front and back side of a card on a single page (instead of saving each side as a separate file).

CALLING UP AND USING A FILE

Searching for and calling up a saved file

When calling up a file, you can enter the file name, folder name, or user name to quickly search for the file.

To search for a file, touch the [SEARCH] key in the main screen of document filing mode or in a screen that shows folders or files in a folder. A data search screen will appear.

■ Procedure for searching for a file

- 1 Touch the [SEARCH] key in the main screen of document filing mode or in a screen that shows folders or files in a folder.

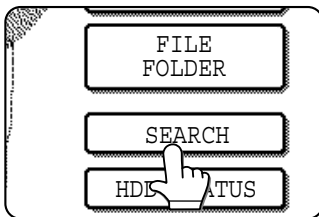

If you touch the [SEARCH] key in the screen that shows the folders in the custom folder or a screen that shows the files in a folder, the [SEARCH

WITHIN CURRENT FOLDER] checkbox will appear. Select this checkbox to search for a file only in the selected folder.

- 2 In the data search screen, select whether you will search by [USER NAME] or [FILE OR FOLDER NAME].

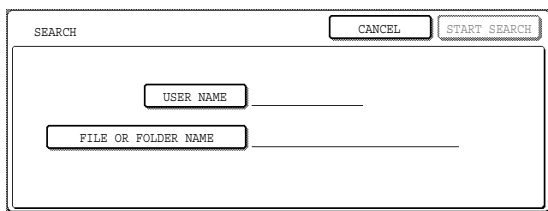

- To search by user name, follow steps 3 to 6.
- To search by file name or folder name, perform step 8.
- To stop searching, touch the [CANCEL] key.

[Searching by user name]

- 3 Touch the [USER NAME] key.

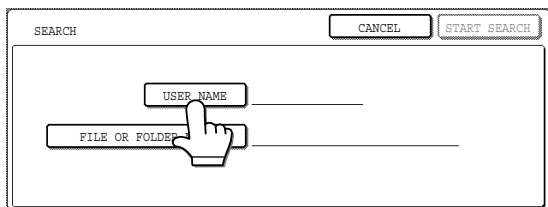

- 4 Touch the one-touch key of the user name that you wish to use to search for the file. If you wish to directly enter the user name, touch the [DIRECT ENTRY] key.

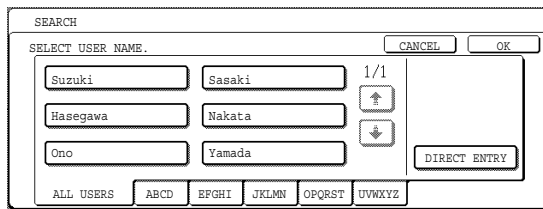

- The selected user name is highlighted.
- If you select the wrong user name, touch the key of the correct name.
- If you touch the [DIRECT ENTRY] key, a character entry screen will appear. Enter the user name. See page 7-29 for the procedure for entering characters.

- 5 Touch the [OK] key.

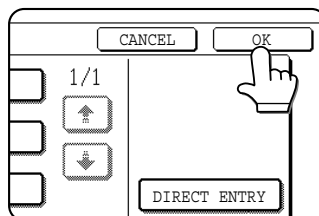

You will return to the screen of step 2 and the selected user name will appear.

- 6 Touch the [START SEARCH] key.

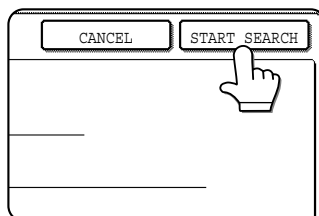

7

7 The results of the user name search appear. Touch the desired file name or folder name.

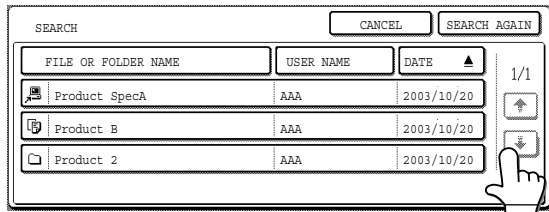

- See page 7-5 for a list of the document filing icons.
- When a file name is touched, the operation selection screen appears. **(To perform an operation using the file, go to step 5 on page 7-16.)**
- When a folder name is touched, all files in the folder are displayed. Touch the desired file. **(To perform an operation using the file, go to step 5 on page 7-16.)**
- To change the order of file display, touch the [FILE OR FOLDER NAME] key, [USER NAME] key, or [DATE] key.

If you touch a file name or folder name that has a password, a password entry screen will appear. Enter the 5-digit password with the numeric keys.

10 The results of the file or folder name search appear. Touch the desired file name or folder name.

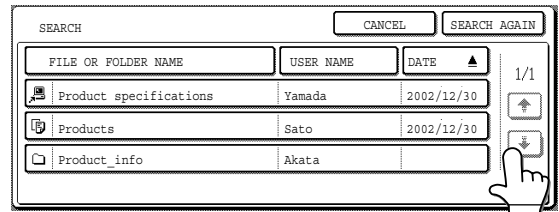

- See page 7-5 for a list of the document filing icons.
- When a file name is touched, the operation selection screen appears. **(To perform an operation using the file, go to step 5 on page 7-16.)**
- When a folder name is touched, all files in the folder are displayed. Touch the desired file. **(To perform an operation using the file, go to step 5 on page 7-16.)**
- To change the order of file display, touch the [FILE OR FOLDER NAME] key, [USER NAME] key, or [DATE] key.

If you touch a file name or folder name that has a password, a password entry screen will appear. Enter the 5-digit password with the numeric keys.

[Searching by file or folder name]

8 Touch the [FILE OR FOLDER NAME] key.

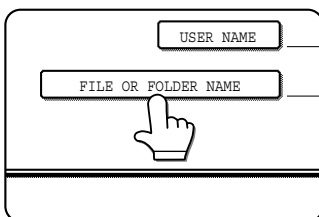

A character entry screen appears. Enter the file name or folder name to be used for the search. See page 7-29 to enter characters.

9 Touch the [START SEARCH] key.

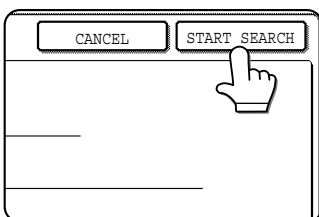

Calling up and using a saved file

A file saved with the document filing function can be called up and printed or manipulated as needed.

The following operations can be performed:

- **[Print]** : Print the file (page 7-17).
- **[Send]** : Transmit the saved file (page 7-20). The file can be transmitted by Scan to E-mail, Scan to FTP, Scan to Network Folder, fax, or Internet fax. (All of these methods require installation of the appropriate options.) (Page 1-12)
- **[Property change]** : Change the attribute of the saved file (page 7-21).
- **[Move]** : Move the file (page 7-22).
- **[Delete]** : Delete the the file (page 7-22).
- **[Detail]** : Show details on the saved file (page 7-22).

■ General procedure for using a saved file

1 Press the **[DOCUMENT FILING]** key on the operation panel.

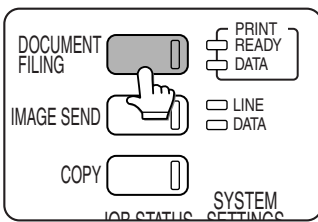

3 Touch the key of the folder that contains the desired file.

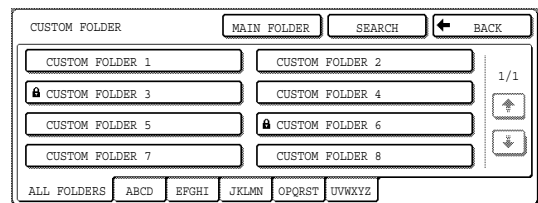

2 Touch the **[FILE FOLDER]** key or the **[QUICK FILE FOLDER]** key depending on where the file is saved.

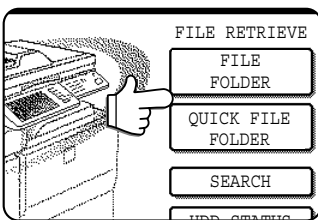

If there are more custom folder keys than can appear in one screen, touch the or keys to change screens.

If a password is set for the selected folder, a password entry screen will appear. Enter the 5-digit password with the numeric keys.

4 Touch the desired file key.

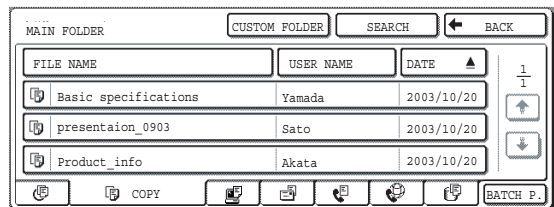

- Touch the **[FILE FOLDER]** key if the file is saved in the main folder or the custom folder. Touch the **[QUICK FILE FOLDER]** key if the file is saved in the Quick File folder.

If you touched the **[FILE FOLDER]** key, the files in the main folder or the folders in the custom folder appear. If you open the wrong folder, touch the **[MAIN FOLDER]** key or the **[CUSTOM FOLDER]** key and open the correct folder.

- If the desired file is saved in the main folder, go to step 4. If the desired file is saved in a custom folder, go to step 3.
- If you touched the **[QUICK FILE FOLDER]** key, the files in the Quick File folder appear. Go to step 4.

Touch the key of the file that you wish to use. (Parts of the screen that are framed in black are keys that can be touched.)

A menu screen will appear.

If a password is set for the file, a password entry screen will appear. Enter the 5-digit password with the numeric keys.

5 Touch the key of the operation that you wish to perform.

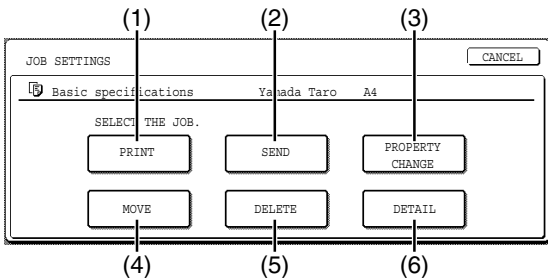

- (1) [PRINT] key (see page 7-17)
- (2) [SEND] key (see page 7-20)
- (3) [PROPERTY CHANGE] key (see page 7-21)
- (4) [MOVE] key (see page 7-22)
- (5) [DELETE] key (see page 7-22)
- (6) [DETAIL] key (see page 7-22)

The setting screen of the selected operation appears. See the indicated page.

FILE SELECTION SCREEN

The file selection screen of the Quick File folder, Main folder, and custom folders is explained below.

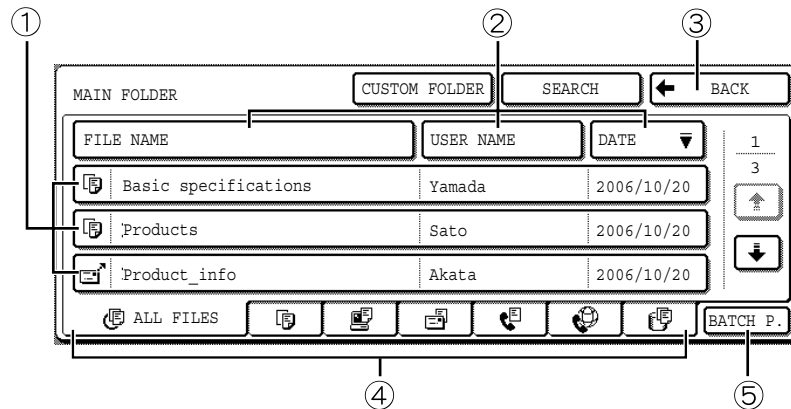

① File keys

The stored files are displayed. An icon showing which mode the file was stored from, the file name, the user name, and the date the file was stored appear in each file key. When a file is touched, the job setting screen appears.

② [File Name] key, [User Name] key, [Date] key

Use these keys to change the order of display of the file keys. When one of the keys is touched, ▲ or ▼ appears in the key.

- When ▲ appears in the [File Name] key or [User Name] key, the files appear by file name or user name in ascending order.

When ▲ appears in the [Date] key, the files appear in order from the oldest date.

- When ▼ appears in the [File Name] key or [User Name] key, the files appear by file name or user name in descending order.

When ▼ appears in the [Date] key, the files appear in order from the most recent date.

③ [Back] key

Touch this key to return to the screen one level up.

④ Select displayed files by job type.

You can select the file keys that are displayed by job type.

[ALL FILES] is initially selected.

Touch a tab to show a list of the files that were stored from that mode.

⑤ [Batch Print] key

Touch this key to print all files in a folder.

For detailed information on batch printing, see 7-18.

■ [Print]

A saved file can be printed.

The screen below appears when the [PRINT] key is selected in the operation selection screen. To begin printing, touch the [PRINT] (⑦) key. Printing settings can be selected in this screen before printing. The settings that were in effect when the file was saved appear initially. The settings can be changed as needed.

NOTES

- When print settings are changed with this procedure, only the value for the number of copies is overwritten.
- The printing speed will be slower for image files saved using certain resolution settings. (See page 7-31.)

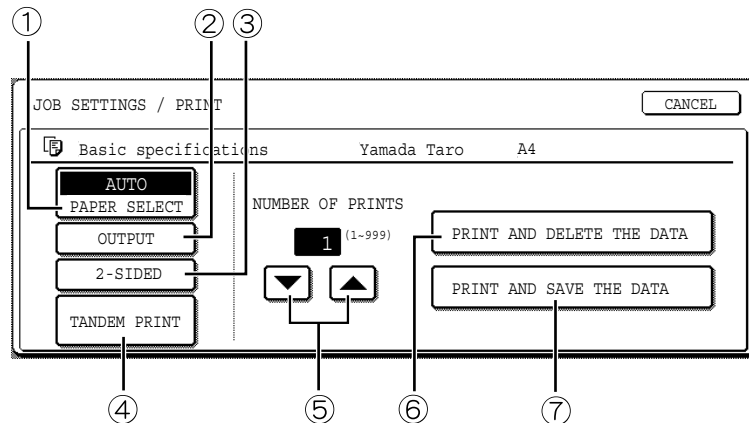

① [PAPER SELECT] key

Use this key to set the paper size.

② [OUTPUT] key

Use this key to select sort, group or staple sort functions, and to select the output tray.

③ [2-SIDED] key

When performing two-sided printing, use this key to select the orientation of the image on the back side of the paper. To have the front and back images oriented in the same direction, touch the [2-SIDED BOOKLET] key. To have the front and back images oriented opposite to each other, touch the [2-SIDED TABLET] key. Note that the size and orientation of the saved image may cause these keys to have the opposite effect. If neither key is selected, one-sided printing will take place.

④ [TANDEM PRINT] key

If the conditions for tandem printing are met (page 5-10), touch this key to enable tandem printing. See page 5-10 for more information.

⑤ [NUMBER OF PRINTS] setting key

Use this key to set the number of copies.

⑥ [PRINT AND DELETE THE DATA] key

Touch this key to print a file and then have it automatically deleted.

⑦ [PRINT AND SAVE THE DATA] key

Touch this key to print a file. The file will not be automatically deleted after printing.

■ Batch printing

All files in a folder that have the same user name and password can be printed at once.

- 1 Touch the [BATCH P.] key in the file list screen of document filing mode.**

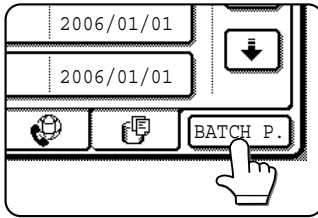

To print all files of a specific type of job, touch the desired job tab. The files shown on that tab can be printed as a batch.

- 2 Touch the [USER NAME] key.**

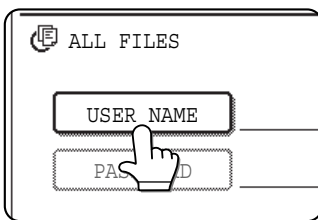

- 3 Touch the user name of the files that you wish to print by batch printing.**

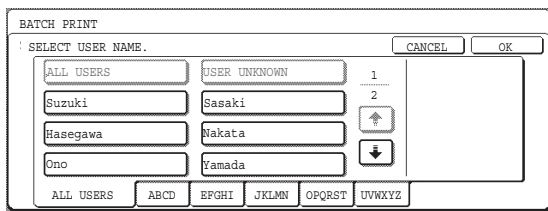

NOTE

When [SELECTION OF [ALL USERS] IS NOT ALLOWED.] checkbox and [SELECTION OF [USER UNKNOWN] IS NOT ALLOWED.] are disabled in the administrator settings, the [ALL USERS] key and [USER UNKNOWN] key can be selected. The [ALL USERS] key can be touched to select all files in the folder (the files of all users). The [USER UNKNOWN] key can be touched to select all files in the folder that do not have a user name.

- 4 If a password has been established, touch the [PASSWORD] key.**

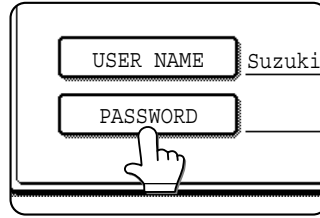

Enter the password with the numeric keys (5 to 8 digits) and touch the [OK] key. Only files that have the same password will be selected.

If you do not wish to enter a password, go to the next step.

- 5 To set the number of copies, touch the [CHANGE PRT.NO.] key.**

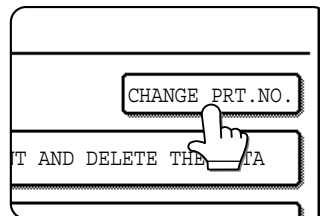

If you wish to use the number of copies stored with each file, go to step 9.

- 6 Touch the [APPLY THE NUMBER FROM STORED SETTING OF EACH JOB] checkbox to remove the checkmark.**

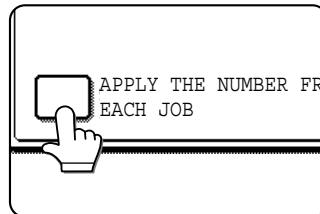

- 7 Set the number of copies with the [↓] [↑] keys.**

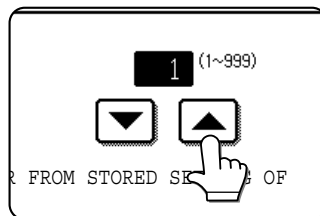

The number of copies can be also set with the numeric keys.

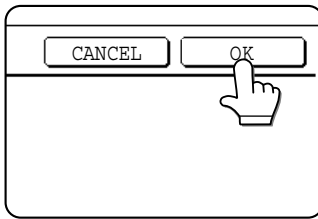
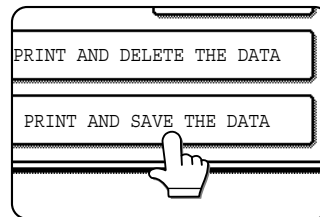
8 Touch the [OK] key.**9** Touch the [PRINT AND DELETE THE DATA] key or the [PRINT AND SAVE THE DATA] key.

If the [PRINT AND DELETE THE DATA] key is touched, the files will be automatically deleted after printing.

If the [PRINT AND SAVE THE DATA] key is

touched, the files will be saved after printing.

If there are no files that match the search conditions, you will return to the file list screen.

NOTES

- If "Auditing mode" is enabled in the administrator settings for copy mode, print mode, or document filing mode, it will not be possible to perform batch printing of [ALL FILES].
- To display the job tab of a mode for which "Auditing mode" is enabled in the administrator settings, the account number must be entered.

■ [Send]

A saved file can be transmitted by Scan to E-mail, Scan to FTP, Scan to Network Folder, fax, or Internet fax. These transmission methods require installation of the appropriate options.

The following screen appears when the [SEND] key is touched. Select the destination and other settings required for transmission and then touch the [SEND] (10) key to transmit the file. Transmission settings include the resolution and transmission functions such as a timer setting. Change or select these settings as needed.

NOTE

Jobs that use the following special functions cannot be transmitted when called up. (The [SEND] key is greyed out in the operation selection screen.)

Pamphlet copying, covers/insert, card shot, Multi shot.

Jobs that use the following functions can be transmitted with certain restrictions when called up:

Card shot: Can be transmitted if saved by scan save or image send.

Multi shot (2in1): Can be transmitted if saved as 2in1 using a portrait original.

[Example of FAX mode]

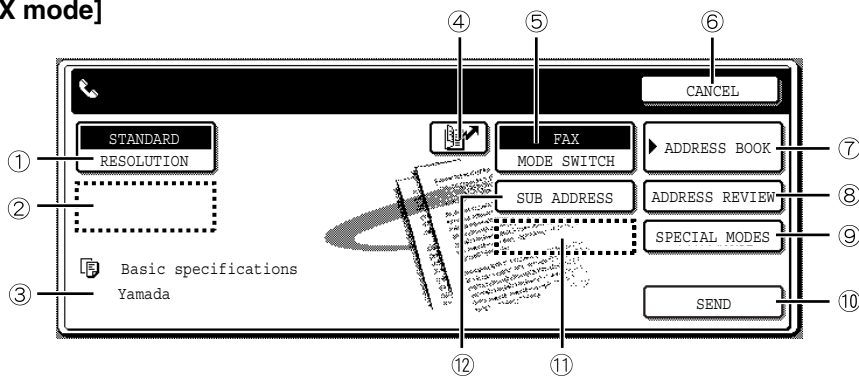

- ① **[RESOLUTION] key**
Use this key to set the resolution.
- ② **[FILE FORMAT] key**
The [FILE FORMAT] key appears in scan mode (Scan to E-mail, Scan to FTP, or Scan to Network Folder). Touch this key to set the file format of scan images that you transmit.
- ③ **[FILE NAME/USER NAME] display**
This shows the file name and user name of the file to be transmitted.
- ④ **[] key (Speed dial key)**
Use this key to specify a destination by entering the 3-digit number that is assigned to an e-mail address or fax number when it is stored in a one-touch key or group key.
- ⑤ **[MODE SWITCH] key**
Use this key to select the transmission mode (Scan to E-mail, Scan to FTP, Scan to Network Folder, fax, or Internet fax).
- ⑥ **[CANCEL] key**
Touch this key to return to the operation selection screen.
- ⑦ **[ADDRESS BOOK] key**
Touch this key to display the destinations stored in the directory.
- ⑧ **[ADDRESS REVIEW] key**
Touch this key to display the destinations.
- ⑨ **[SPECIAL MODES] key**
Touch this key to display the special function menu. The functions that can be selected vary depending on the transmission mode:
 - Scan to E-mail/FTP/Network Folder
TIMER : The transmission time can be specified.
 - FAX
TIMER : The transmission time can be specified.
FAX OWN ADDRESS SENDING: Your sender's information can be included on the fax pages printed out by the receiving machine.
 - Internet FAX
TIMER : The transmission time can be specified.
I-FAX OWN ADDRESS SEND: Your sender's information can be included on the Internet fax pages printed out by the receiving machine.
- ⑩ **[SEND] key**
Touch this key after selecting transmission settings to begin transmission. (The [START] key can also be pressed to begin transmission.)

⑪ **[SEND SETTINGS] key**

The [SEND SETTINGS] key is displayed in scanner mode and in Internet fax mode.
Touch this key to set the subject and file name. In scanner mode, the sender name can also be set.

⑫ **[SUB ADDRESS] key or [ADDRESS ENTRY] key**

- Touch this key to directly enter the destination for a Scan to E-mail, Scan to FTP, Scan to Network Folder, or Internet fax transmission.
- Touch this key to enter the sub-address and passcode for an F-code fax transmission.

NOTE

See the "Operation manual (for facsimile)" and "Operation manual (for image send)" for detailed explanations of ①, ②, ③, ④, ⑤, ⑥, ⑦, ⑧, ⑨, ⑩, ⑪, and ⑫.

■ **[Property change]**

Select this operation to change the attribute of a saved file. Three attributes are available: [SHARING], [PROTECT], and [CONFIDENTIAL].

The following screen appears when the [PROPERTY CHANGE] key is selected in the operation selection screen. Note the restrictions below on changing the attribute.

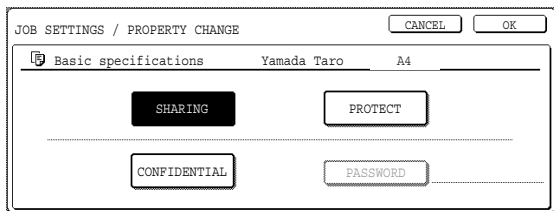

[Restrictions on changing the attribute]

- A file that is set to [SHARING] can be changed to [PROTECT] or [CONFIDENTIAL]. However, a [SHARING] file that is saved in the Quick File folder can only be changed to [PROTECT].
- A file that is set to [PROTECT] can be changed to [SHARING] or [CONFIDENTIAL]. However, a [PROTECT] file that is saved in the Quick File folder can only be changed to [SHARING].
- A file that is saved in the Quick File folder cannot be changed to [CONFIDENTIAL].

1 Touch the [PROPERTY CHANGE] key in the operation selection screen.

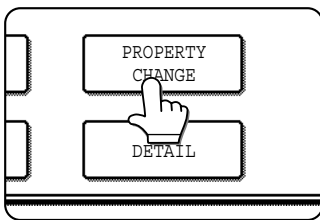

3 Touch the [OK] key.

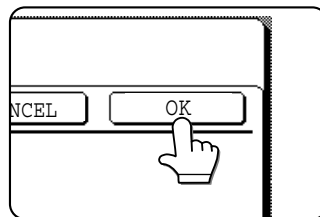

2 Touch the key of the desired attribute.

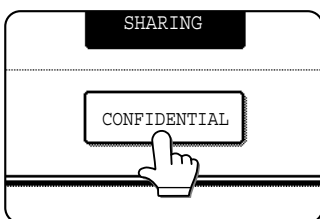

If you are changing a [SHARING] or [PROTECT] file to [CONFIDENTIAL], touch the [PASSWORD] key and enter the password.

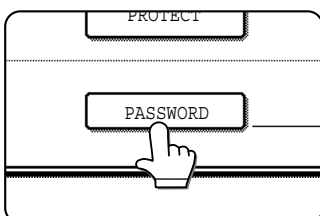

■ **[Move]**

This operation is used to move a file to a different folder.

The following screen appears when the [MOVE] key is selected.

Only [SHARING] and [CONFIDENTIAL] files can be moved. A [PROTECT] file can be moved by first using [PROPERTY CHANGE] to change the attribute to [SHARING] or [CONFIDENTIAL].

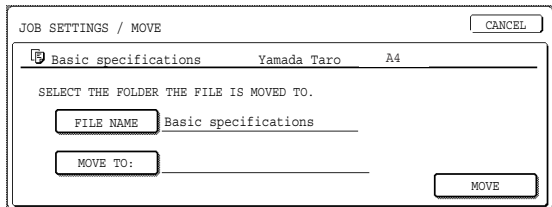

1 Touch the [MOVE TO:] key and select the folder to which you wish to move the file.

- Select the main folder or a folder in the custom folder. A file cannot be moved to the Quick File folder.
- The file name can be changed when moving a file. To change the name, touch the [FILE NAME] key and enter the desired file name. See page 7-29 for the procedure for entering characters.

2 Touch the [OK] key.

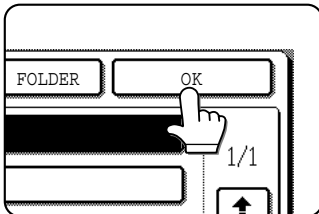

3 Touch the [MOVE] key.

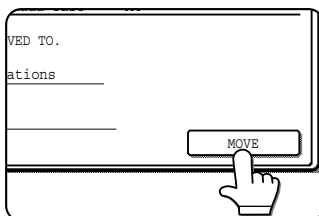

4 Touch the [CANCEL] key.

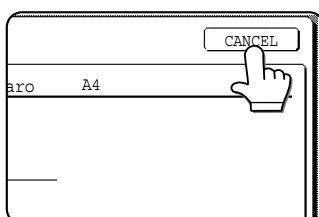

You will return to the operation selection screen.

■ **[Delete]**

This operation is used to delete the selected file. Touch the [DELETE] key in the operation select screen. A message asking you to confirm the deletion will appear. Touch the [YES] key to delete the file.

Only [SHARING] or [CONFIDENTIAL] files can be deleted. (A [PROTECT] file can be deleted by first using [PROPERTY CHANGE] to change the attribute to [SHARING].)

■ **[Detail]**

This operation is used to show detailed information on the selected file.

Touch the [DETAIL] key to display the information. The information appears on two screens. Touch the [↓] key or [↑] key to move between the two screens.

The file name can be changed in the information screen. To change the name, touch the [FILE NAME] key and enter the desired file name in the character entry screen that appears. See page 7-29 for the procedure for entering characters.

■ Calling up and manipulating a file from the job status screen

Files saved using the "FILE" and "QUICK FILE" functions appear as keys in the finished job status screen. You can view information on a file that appears in this screen and manipulate the file.

1 Press the [JOB STATUS] key.

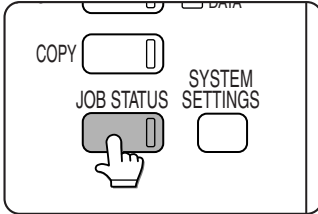

The job status screen appears.

2 Touch the [COMPLETE] key.

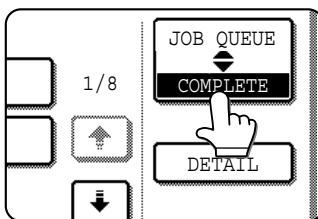

The finished job screen appears.

3 Touch the key of the desired file.

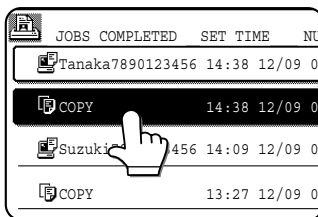

If there are more keys than can appear in one screen and the desired file does not appear, touch the key or key to change screens.

The touched key is highlighted.

4 To view information on the file, touch the [DETAIL] key.

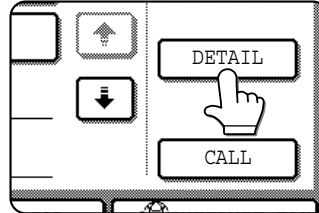

Use the keys to change screens. When you are finished, touch the [OK] key to return to the screen of step 3.

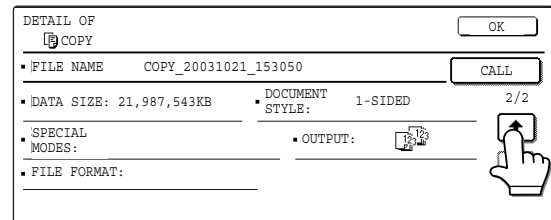
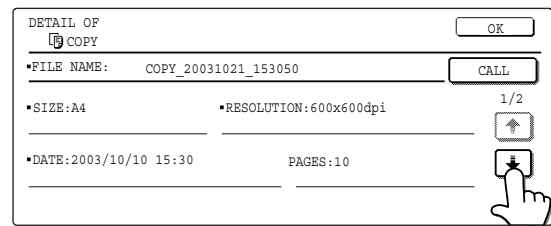

5 Touch the [CALL] key.

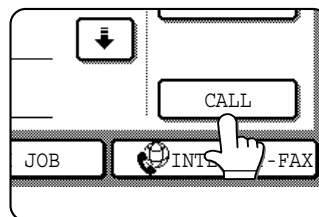

The operation selection screen appears.

Select and perform the desired operation as explained in "Calling up and using a saved file" (page 7-15).

SYSTEM SETTINGS

Creating, editing, and deleting user names and folders

This section explains how to create, edit, and delete user names and custom folders for saving files with the document filing function. User names and custom folders are created and edited at the operation panel of the machine or in the Web page.

NOTES

- A previously stored name cannot be used when creating a new user name or custom folder. However, the same password can be used more than once.
- A password cannot be omitted when creating a user name.

■ General procedure for creating, editing, and deleting user names and folders

Follow steps 1 to 3 below to create, edit, or delete a user name or custom folder. In step 3, select the key for the specific operation that you wish to perform.

1 Press the [SYSTEM SETTINGS] key.

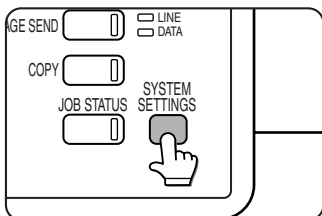

2 Touch the [DOCUMENT FILING CONTROL] key.

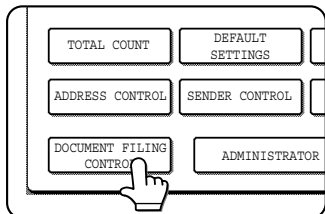

3 Touch the key of the operation that you wish to perform.

Go to the page indicated below for the selected operation.

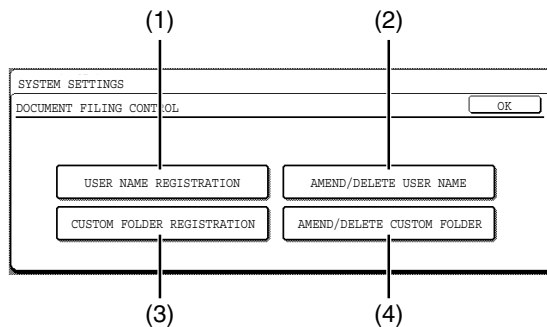

- (1) **[USER NAME REGISTRATION] key**
Program a user name. (See the next page)
- (2) **[AMEND/DELETE USER NAME] key**
Edit or delete a user name. (See page 7-26)
- (3) **[CUSTOM FOLDER REGISTRATION] key**
Create a custom folder. (See page 7-27)
- (4) **[AMEND/DELETE CUSTOM FOLDER] key**
Edit or delete a custom folder. (See page 7-28)

■ Programming a user name

To program a user name, follow steps 1 and 2 on page 7-24, touch the [USER NAME REGISTRATION] key in step 3, and then follow these steps:

1 Touch the [USER NAME] key.

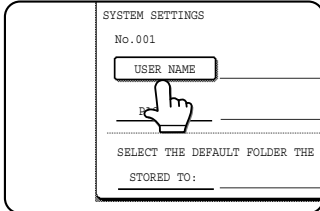

The lowest number that has not yet been programmed appears automatically in "No.". Touch the number to display a character entry screen and enter a user name (maximum of 16 characters). See page 7-29 for the procedure for entering characters.

2 Touch the [INITIAL] key.

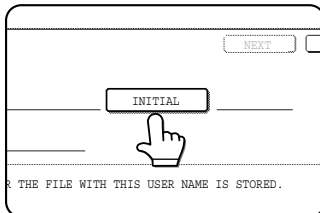

A character entry screen appears. Enter up to 10 search characters. See page 7-29 for the procedure for entering characters.

3 Touch the [PASSWORD] key.

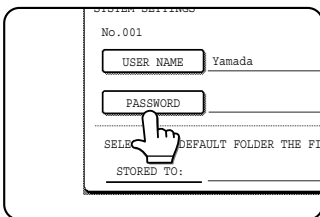

A password cannot be omitted.

4 Set a password for the user name (enter a 5-digit password with the numeric keys).



This will be the password for the user name entered in step 1. As each digit is entered, "-" changes to "*". If you make a mistake, press the [C] key and then enter the correct number.

5 Touch the [OK] key.

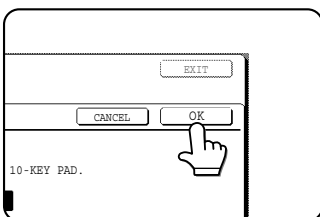

6 If you wish to specify a folder for the user name, touch the [STORED TO:] key. If you wish to use the main folder, go to step 8.

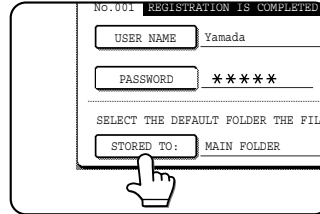

7 The folders that have been created appear. Touch the desired folder. If you wish to create a new folder, or if no folders have been created, touch the [ADD NEW] key.

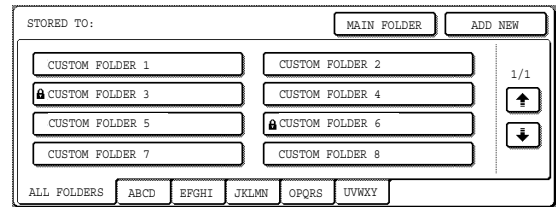

If you touched the [ADD NEW] key, program a name for the folder as explained on page 7-27. The user name programmed in step 1 is selected as the user name of the folder.

8 Touch the [EXIT] key.

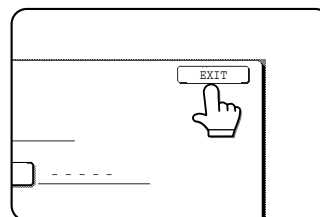

You will return to the "USER NAME REGISTRATION" screen. "REGISTRATION IS COMPLETED." will appear highlighted next to "No.".

9 To exit, touch the [EXIT] key. To program another user name, touch the [NEXT] key.

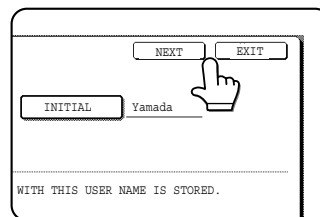

If you touched the [EXIT] key, you will return to the screen of step 3 on page 7-24. If you touched the [NEXT] key, a new user entry screen will appear. Repeat steps 1 to 9 to program a new user.

■ Editing and deleting a user name

To edit or delete a user name, follow steps 1 and 2 on page 7-24 and then follow these steps:

1 Touch the [AMEND/DELETE USER NAME] key.

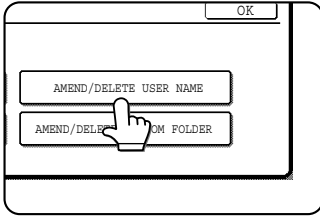

2 Touch the [USER NAME] key that you wish to edit or delete.

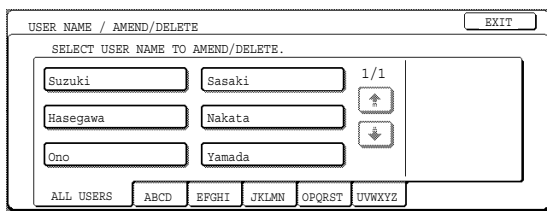

A password entry screen will appear.

3 Enter the 5-digit password with the numeric keys.

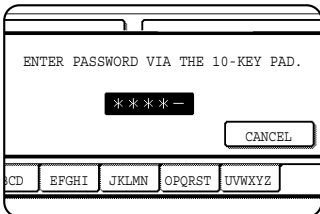

After entering the password, the following screen will appear.

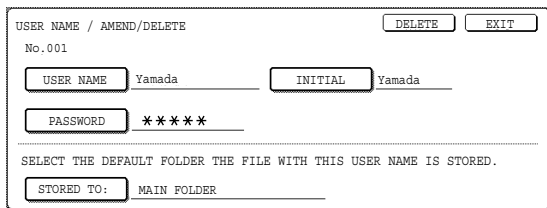

- To edit a user name, perform steps 4 and 5.
- To delete a user name, perform steps 6 and 7.

[Editing]

4 Touch the key of each item that you wish to edit (edit as explained in steps 1 to 9 in "Programming a user name" on page 7-25).

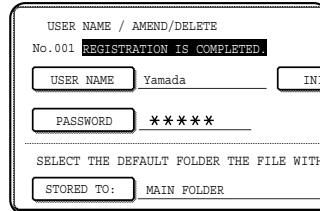

When you have finished editing the items, "REGISTRATION IS COMPLETED." will appear highlighted next to "NO."

5 When you have finished editing the desired items, touch the [EXIT] key.

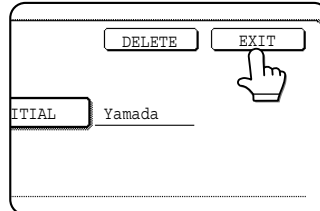

To edit another user name, repeat steps 2 to 4.

To exit, touch the [EXIT] key in the screen of step 2.

NOTE

When a user name is changed, the change is not updated to any previously saved data (files or folders).

[Deleting]

6 Touch the [DELETE] key.

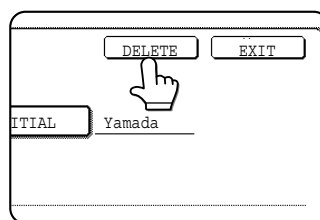

7 Touch the [YES] key.

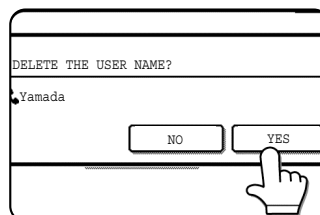

You will return to the screen of step 2. To delete another user name, repeat steps 2, 3, 5 and 6.

To exit, touch the [EXIT] key in the screen of step 2.

■ Creating a custom folder

Up to 500 custom folders can be created. When no further folders can be created, delete unneeded folders (page 7-28) and then create a new folder. A password can be omitted when creating a folder. To create a custom folder, follow steps 1 and 2 on page 7-24, touch the [CUSTOM FOLDER REGISTRATION] key in step 3, and then follow the steps below.

1 Touch the [FOLDER NAME] key.

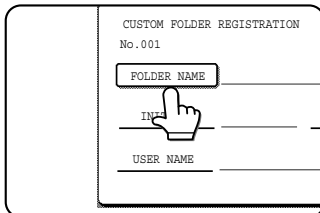

The lowest number that has not yet been programmed appears automatically in "No.". Touch the number to display a character entry screen and enter a folder name (maximum of 28 characters). See page 7-29 for the procedure for entering characters.

2 Touch the [INITIAL] key.

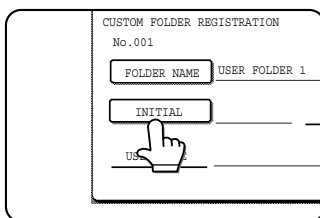

A character entry screen appears. Enter up to 10 search characters. See page 7-29 for the procedure for entering characters.

3 If you wish to set a password for the new folder, touch the [PASSWORD] key.

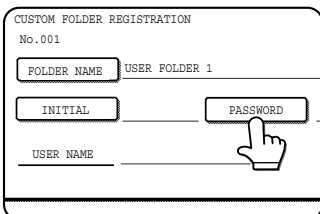

A password can be omitted. If you are omitting a password, go to step 6.

4 Set a password for the folder (enter a 5-digit password with the numeric keys).



This will be the password for the folder name entered in step 1.

5 Touch the [OK] key.

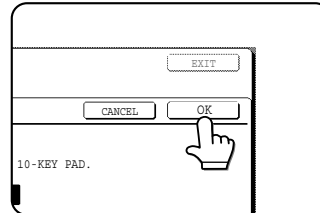

6 Touch the [USER NAME] key.

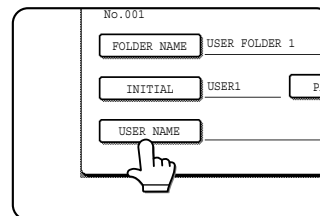

You will select a user name that will be associated with the folder name you are programming. Selection of a user name cannot be omitted.

7 The programmed user names appear. Touch the desired user name. If you do not wish to use any of the user names that appear, touch the [ADD NEW] key to program a new user name.

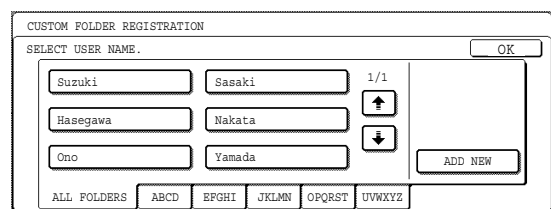

When you touch a user name, a password entry screen appears.

If you touched the [ADD NEW] key, program a user name as explained on page 7-25. The folder name programmed in step 1 will be selected as the folder for the user.

8 Enter the 5-digit password of the selected user name with the numeric keys.

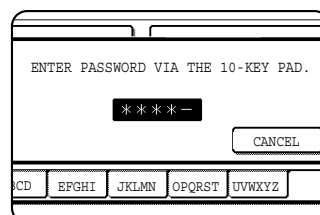

9 Touch the [OK] key.

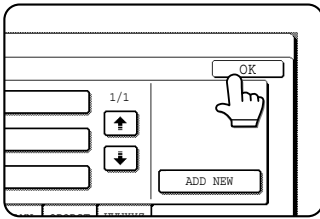

10 To exit, touch the [EXIT] key. To create another folder, touch the [NEXT] key.

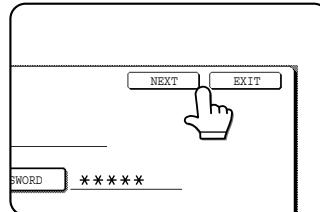

If you touched the [EXIT] key, you will return to the screen of step 3 on page 7-24. If you touched the [NEXT] key, a new folder screen will appear. Repeat steps 1 to 10 to

create a new folder.

■ Editing/deleting a custom folder

To edit a previously created folder (change the folder name, initial, password, or user name), or to delete a folder, follow steps 1 and 2 on page 7-24 and then follow the steps below.

When deleting a folder...

A folder that contains files cannot be deleted. Either move the files to a different folder or delete them before deleting the folder.
: [MOVE] (see page 7-22) : [DELETE] (see page 7-22)

1 Touch the [AMEND/DELETE CUSTOM FOLDER] key.

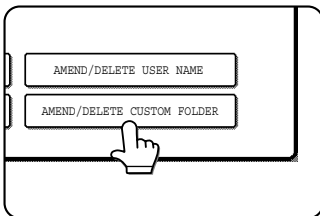

[Editing]

4 Touch the key of each item that you wish to edit (edit as explained in steps 1 to 10 of "Creating a custom folder" on page 7-27).

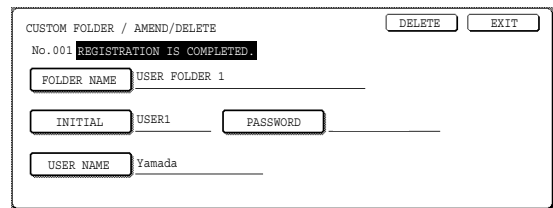

2 Touch the [FOLDER NAME] key that you wish to edit or delete.

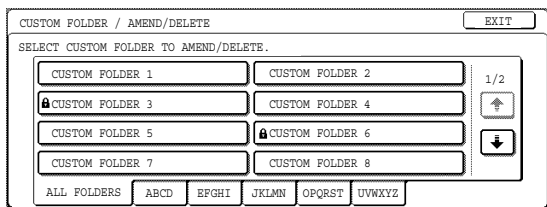

After editing the items and returning to the screen of step 3, "REGISTRATION IS COMPLETED." will be highlighted to the right of "No."

To stop using a password, touch the [PASSWORD] key and then touch the [OK] key without entering anything for the password. [-] will appear and the password will be cancelled.

If a password has been set for the folder, a password entry screen will appear. Enter the correct 5-digit password with the numeric keys.

5 When you have finished editing the items, touch the [EXIT] key.

To edit another folder, repeat steps 2 to 5.

3 Edit or delete the folder.

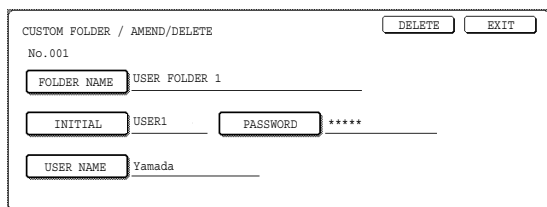

[Deleting]

6 Touch the [DELETE] key.

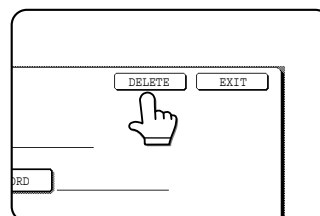

- To edit the folder, perform steps 4 and 5.
- To delete the folder, perform steps 6 and 7.
- To exit, touch the [EXIT] key.

7 Touch the [YES] key.

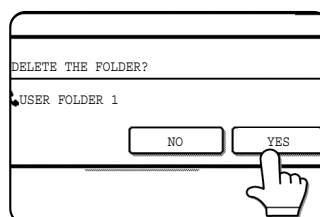

You will return to the screen of step 2.

To delete another folder, repeat steps 2, 6, and 7. To exit, touch the [EXIT] key in the screen of step 2.

ENTERING CHARACTERS

To enter or edit characters in setting screens such as auto dial key programming screens, follow the steps below. Characters that can be entered are alphabetical characters, special characters, numbers, and symbols.

■ Entering alphabetical characters

(Example: Sharp äÄ)

1 Touch the [S] key.

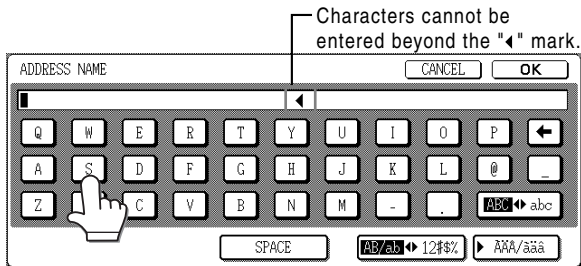

To switch between upper case and lower case, touch the [ABC \leftrightarrow abc] key. When ABC is highlighted, upper case letters are entered.

2 Touch the [ABC \leftrightarrow abc] key.

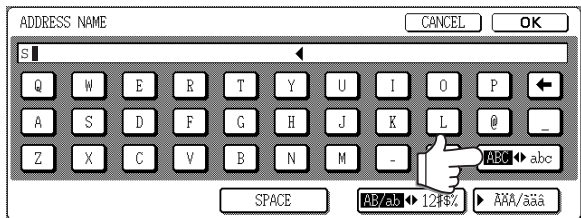

3 Touch the [h] key, [a] key, [r] key, and [p] key.

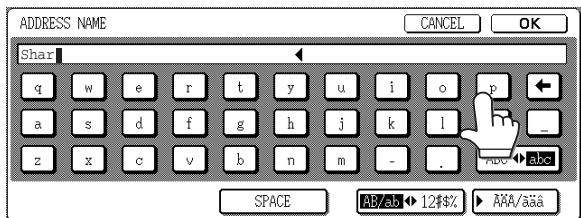

If you make a mistake, touch the \leftarrow key to move the cursor (■) back one space and then enter the correct character. You can also press the [AB/ab \leftrightarrow 12#\$%] key during entry to enter a number or symbol.

4 Touch the [SPACE] key.

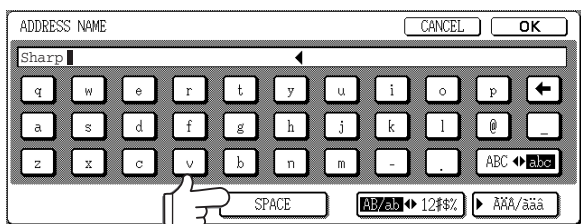

The cursor (■) moves forward and a space is entered.

5 Touch the [\rightarrow ÄÄ/äää] key.

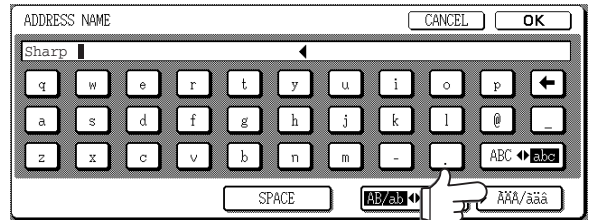

6 Touch the [ä] key.

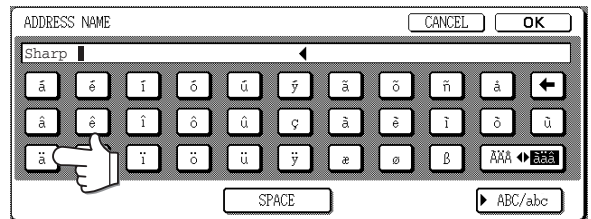

To switch between upper case and lower case, touch the [ÄÄÄ \leftrightarrow äää] key. When äää is highlighted, lower case letters are entered.

7 Touch the [ÄÄÄ \leftrightarrow äää] key.

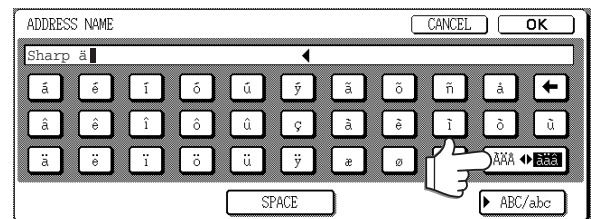

8 Touch the [Ä] key.

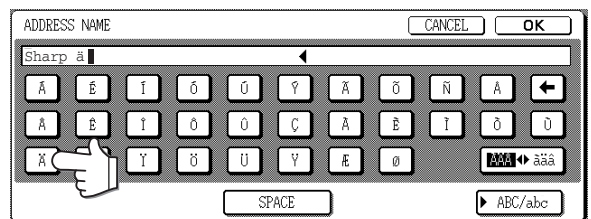

You can press the [ABC/abc] key during entry to return to alphabetical character entry. You can also enter numbers and symbols.

9 When finished, touch the [OK] key.

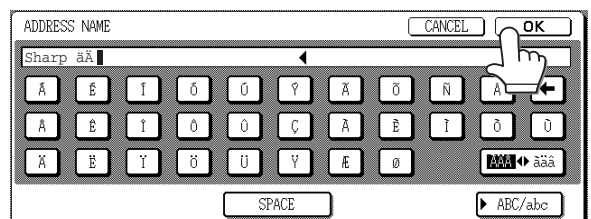

You will exit the character entry screen and return to the programming screen. If you touch the [CANCEL] key, you will return to the programming screen without storing the entered characters.

■ Entering numbers and symbols

1 Touch the [AB/ab ◀ 12#\$\$%] key.

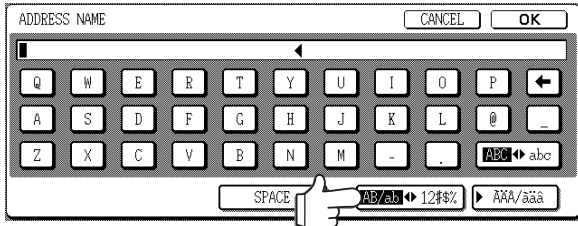

When the characters "12#\$\$%" are highlighted, number/symbol entry mode is selected.

2 Enter the desired number or symbol.

Numbers and symbols that can be entered are as follows:

Screen 1/2

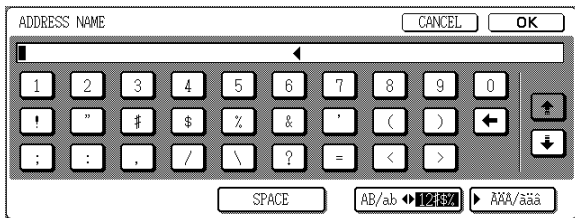

Screen 2/2

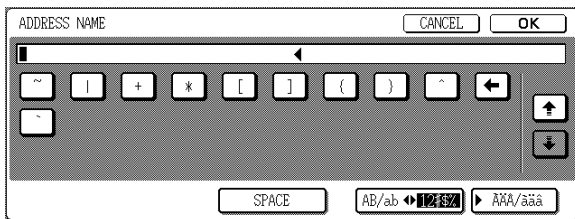

Change screens by touching the [↑] key or [↓] key displayed in the screen. If you make a mistake, touch the [←] key to move the cursor (■) back one space and then enter the correct character.

You can continue touching keys to enter characters. You can also touch another character type selection key ([▶ AAA/aaa] key or [AB/ab ◀ 12#\$\$%] key) to enter characters other than numbers and symbols.

3 When you have finished entering characters, touch the [OK] key.

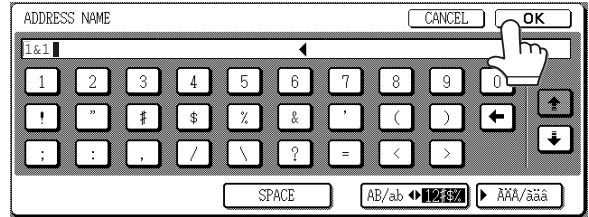

You will exit the character entry screen and return to the programming screen. If you touch the [CANCEL] key, you will return to the programming screen without storing the entered characters.

NOTE
The following symbols cannot be used when entering a file name or folder name.

\	?	/	"	;	:	,
<	>	!	*		&	#

Spaces and the following symbols may be replaced by other characters.

\$	%	'	()	+	-
.	=	@	[]	^	`
{	}	~				

TROUBLESHOOTING

This section explains problems frequently encountered when using the document filing function. If you experience any difficulty, refer to the following table. For information on general machine problems, printer problems, fax problems, and network scanner problems, please see the troubleshooting sections of the appropriate manuals.

Problem	Check	Cause and solution
A saved file has disappeared.	Was the file called up and then printed by touching the [PRINT AND DELETE THE DATA] key?	A file that is printed using the [PRINT AND DELETE THE DATA] key is automatically deleted after being printed. To print a file without deleting it, use the [PRINT AND SAVE THE DATA] key.
A file cannot be deleted.	Is the file's attribute set to [PROTECT]?	A file cannot be deleted when its attribute is set to [PROTECT]. Change the attribute to [SHARING] and then delete the file.
A file's attribute cannot be set to [CONFIDENTIAL].	Is the file in the main or custom folder?	A file in the Quick File folder cannot be set to [CONFIDENTIAL]. Move the file to a different folder or set it to [PROTECT].
A file's attribute cannot be changed to [PROTECT].	Is the file set to [CONFIDENTIAL]?	A file cannot be simultaneously set to [CONFIDENTIAL] and [PROTECT]. If set to [CONFIDENTIAL], use [PROPERTY CHANGE] (page 7-21) to change the attribute to [PROTECT].
A name in the Quick File folder is cut off.	Was the name programmed in the advanced transmission settings?	If the name was programmed in the advanced transmission settings before the file was saved in the Quick File folder, that name will be used. However, if the name is longer than the maximum name length of the Quick File folder (30 characters), the excess characters will be discarded.
Resolution settings are not possible.	Was the file saved at low resolution?	A saved file cannot be transmitted at a resolution higher than the resolution at which it was saved.
A file name cannot be stored or changed.	Have you entered prohibited characters in the file name?	Certain characters (symbols) cannot be used in file names. See "ENTERING CHARACTERS" (entering numbers and symbols) on page 7-29.
A custom folder name cannot be stored or changed.	Have you entered prohibited characters in the folder name?	Certain characters (symbols) cannot be used in folder names. See "ENTERING CHARACTERS" (entering numbers and symbols) on page 7-29.
The printing speed of a saved file is slow.	The file was saved using one of the following resolution settings: <ul style="list-style-type: none"> • 200 x 200 dpi resolution. • STANDARD (200 x 100 dpi) or FINE (200 x 200 dpi) 	When a file is saved using one of the resolutions setting at left, the printing speed will be slower than when other resolution settings are used.
Black dots appear when a file that was saved with the document filing function is printed.	Was the file saved at other than the following resolutions? <ul style="list-style-type: none"> • 600x600dpi • 600x600dpi and HALF TONE To check the resolution of the saved file, touch the [DETAIL] key in step 5 on page 7-16.	This problem can be alleviated by setting the resolution to 600x600dpi when saving a file with scan save. The problem can be further alleviated by selecting HALF TONE after setting the resolution to 600x600dpi, as light images will be printed lightly.



CHAPTER 8

SPECIFICATIONS

This chapter contains useful information about the machine.

	Page
SPECIFICATIONS.....	8-2
INDEX	8-4

SPECIFICATIONS

Type	Console
Print system	Electrophotographic system
Exposure system	OPC
Developer system	Dry-type two-component magnetic brush development
Paper feed system	4 trays and bypass tray
Fusing system	Heater roller
Resolution	Scan: 600 x 600 dpi, output: 600 x 600 dpi
Gradation	256 levels
Originals	Sheets, bound documents Maximum size: A3 or 11" x 17"
Copy paper	Plain paper and special papers
Copy sizes	Max. A3 or 11" x 17", min. A5R or 5-1/2" x 8-1/2"R, Postcard Image loss: Max 8 mm or 21/64" (leading edge and trailing edge in total), max. 8 mm or 21/64" (along all other edges in total)
Warm-up time	120 seconds or less
First-copy time	MX-M550U/MX-M620U/MX-M550N/MX-M620N 4.0 seconds or less* MX-M700U/MX-M700N 3.5 seconds or less* * When A4 (8-1/2" x 11") size paper is fed horizontally from tray1
Copy ratio	Variable: 25 to 400% in 1% increments, total 376 steps Fixed presets: 25%, 50%, 70%, 81%, 86%, 100%, 115%, 122%, 141%, 200% and 400% for AB system, 25%, 64%, 77%, 100%, 121%, 129%, 200% and 400% for inch system.
Continuous copy	999 copies
Dimensions (including automatic document feeder)	728 mm (W) x 679 mm (D) x 1192 mm (H) (28-43/64" (W) x 26-47/64" (D) x 46-15/16" (H))
Weight (main unit only)	Approx. 185 kg (Approx. 408 lbs.)
Overall dimensions (When tray is extended)	1263 mm (W) x 679 mm (D) (49-23/32" (W) x 26-47/64" (D))
Required power supply	Local voltage $\pm 10\%$ (For power supply requirements, see the name plate located on the back of the main unit.)
Power consumption	220 - 240V 8A 1.84 kW 120 - 127V 16A 1.8 kW
Operating conditions	Temperature: 10°C to 30°C (50°F to 86°F) Humidity: 20% to 85%

Automatic document feeder

Type	Two-side simultaneous scanning system
Original size	A3 to A5 (11" x 17" to 5-1/2" x 8-1/2")
Capacity	Maximum of 150 sheets (80 g/m ² (20 lbs.)) or total stack height of 19.5 mm (49/64") or less.
Original exchange speed	One-sided: 65 pages/min. Two-sided: 76 sides/min.
Power supply	Supplied from machine

Some discrepancies may exist in the illustrations and content due to improvements to the machine.

Continuous copying speed (when the offset function is not used)

	MX-M550U/MX-M550N	MX-M620U/MX-M620N	MX-M700U/MX-M700N
Copy paper size	100% / Reduced / Enlarged		
A3 (11" x 17")	30 copies/min.	34 copies/min.	39 copies/min.
B4 (8-1/2" x 14")	35 copies/min.	39 copies/min.	45 copies/min.
A4 (8-1/2" x 11")	55 copies/min.	62 copies/min.	70 copies/min.
A4R (8-1/2" x 11"R)	40 copies/min.	45 copies/min.	48 copies/min.
B5 (7-1/4" x 10-1/2")	55 copies/min.	62 copies/min.	70 copies/min.
B5R (7-1/4" x 10-1/2"R)	40 copies/min.	45 copies/min.	48 copies/min.
A5R (8-1/2" x 5-1/2"R)	40 copies/min.	45 copies/min.	48 copies/min.

Centre tray specifications

Output method	Face-down output
Maximum number of sheets (80g/m ² (20lbs.) /recommended paper)	250 sheets*
Paper type	Plain paper and special paper

* The maximum number of pages that can be held varies depending on ambient conditions in the installation location, the type of paper, and the storage conditions of the paper.

Acoustic Noise Emission (measurement according to ISO7779)

		Printing mode	Standby mode
Sound power level L _{WA}		7.3B	5.0B
Sound pressure level L _{pA} (reference)	Bystander positions	58dB(A)	34dB(A)
	Operator position	58dB(A)	35dB(A)

* Noise emission when peripheral devices are installed

Emission Concentration (measurement according to RAL-UZ62: Edition Jan. 2002)

Ozone	0.02 mg/m ³ or less
Dust	0.075 mg/m ³ or less
Styrene	0.07 mg/m ³ or less

INDEX

[✖] key..... 1-13
[#/P] key 1-13

■ Numerics

1-sided copy 4-7, 4-11
1-sided copy-Automatic document feeder 4-7
1-sided copy-Document glass 4-11
256MB expansion memory board 1-12
2in1 5-24, 7-12
2-sided copy 1-3, 4-10, 4-13

■ A

Acceptable originals 4-2
Account number 1-18
Additional fax memory 1-12
Address control 2-18
Adjusting the exposure 1-3, 4-14
Administrator settings 2-18
Alarm display 3-16
All custom setting list 2-20
Application communication module 1-12, 3-19
Application integration module 1-12
Attributes 7-3
Auditing mode 1-18
Auto image 4-15
Auto power shut-off mode 1-9
Automatic copy image rotation 4-4
Automatic document feeder 1-10, 2-31, 4-2
Automatic document feeder
-1-sided copies 4-7
-Acceptable originals 4-2
-Automatic two-sided copying 4-10
-Misfeed original 2-31
-Setting originals 4-3
-User maintenance 6-2
Automatic exposure adjustment 4-14
Automatic selection 4-15
Automatic two-sided copying
-Automatic document feeder 4-10
-Document glass 4-13
Automatic two-sided printing 2-13
Auxiliary tray 2-10

■ B

B/W reverse 1-6, 5-2, 5-31
Barcode font kit 1-12
Binding change 4-13
Book copy 1-5, 5-2, 5-26
Book original 5-5
Bypass tray 1-10, 2-28, 4-20

■ C

[C] key 1-13, 7-4
[CA] key 1-13, 7-4
Call for service 2-32
[CALL] key 1-16
Calling up and using a file 7-13

Calling up and using a saved file 7-15
-Delete 7-22
-Detail 7-22
-Move 7-22
-Print 7-17
-Property change 7-21
-Send 7-20
-Card shot 1-6, 5-2, 5-29, 7-12
Centre erase 5-4
Centre tray 1-10, 4-9
[CENTRE TRAY] key 3-6
Changing the paper size in paper tray 2-3 to 2-6
Clear all key 1-13, 7-4
Clear key 1-13, 7-4
Clock 2-18
Confidential 7-3
Contents 0-5 to 0-6
Continuous copying speed 8-3
[COPY] key 1-13
Cover of the duplex unit 1-11
Covers/inserts 1-5, 5-2, 5-12
Creating a custom folder 7-27
Custom folder 7-3, 7-24, 7-27 to 7-28

■ D

Data security kit 1-12
Default settings 2-20
[DETAIL] key 1-16
Display contrast 2-20
Display switching keys 1-16
Disposal of hole punch scrap 3-10
Document feeder tray 4-2, 4-3
Document filing control 2-18
Document filing function 1-8, 7-1
Document filing user / folder list 2-20
[DOCUMENT FILING] key 1-13, 7-4
Document glass
-1-sided copies 4-11
-Automatic two-sided copying 4-13
-Placing originals 4-3
-User maintenance 6-2
Document transfer cover 2-31, 4-3
Dual page copy 1-4, 5-2, 5-5
DUAL PAGE SCAN 7-12
Duplex unit 1-11

■ E

Editing and deleting
-Custom folder 7-28
-User names 7-26
Energy saving features 1-9
Energy Star guidelines 1-9
Enlargement 4-15
Entering characters 7-29 to 7-30
Erase 1-4, 5-2, 5-4, 7-12

- Examples of covers and inserts 5-17 to 5-22
 -Covers 5-18 to 5-21
 -Inserts 5-22
 External account module 1-12, 3-20
- F**
 Facsimile expansion kit 1-12
 Fax data receive/forward 2-18
 [FAX JOB] key 1-16
 Features 1-3
 [FILE FOLDER] key 7-5
 Finisher 1-10, 3-2
 [FINISHER TRAY] key 3-6
 Front cover 1-10, 3-2
 Fusing unit 1-11, 2-23, 2-24
- G**
 General procedure for using special functions 5-2
 Greyed out 1-14
 Group 1-3, 3-4, 4-9
 [GROUP] key 3-6
- H**
 [HDD STATUS] key 7-5
 Heavy paper 2-12, 2-13
 Highlighted 1-14
 Hole punching 1-8, 3-5
- I**
 Icon 1-14, 5-17, 7-5
 [IMAGE SEND] key 1-13
 Information 2-23
 Inserter 1-8, 1-10, 3-14
 Installation requirements 0-2
 Interior 1-11
 Internet fax expansion kit 1-12
 [INTERNET-FAX] key 1-16
 Interrupting a copy run 1-7, 5-46
- J**
 Job build 1-5, 5-2, 5-8, 7-12
 Job programs 1-6, 5-44 to 5-45
 -Calling up 5-45
 -Deleting 5-45
 -Storing 5-44
 Job status screen 1-15
 [JOB STATUS] key 1-13
- K**
 Keyboard select 2-20
- L**
 Labels 2-12
 Landscape 1-2
 Large capacity tray (AR-LC6) 1-10, 2-7, 2-29
 Large capacity tray (AR-LC7) 1-10, 2-8, 2-30
 Left cover of paper drawer 1-11
 Left side cover release 1-11
 List print 2-20
- Loading paper 2-2
 -bypass tray 2-10
 -tray 1 - tray 2 2-2
 -tray 3 2-5
 -tray 5 2-7 to 2-9
 LOGOUT 1-13
 [LOGOUT] key 1-13, 1-18
 Lower cover 3-2
- M**
 Main features 1-3 to 1-8
 Main folder 7-3
 Main power switch 1-11, 1-17
 Main screen 5-2
 Manual exposure adjustment 4-14
 Manual selection 4-16
 Margin Shift 1-4, 5-2, 5-3
 Meaning of "R" 1-2
 Mirror image 1-6, 5-2, 5-31
 Misfeed 2-23 to 2-31, 3-11 to 3-12, 3-18
 Misfeed in the paper feed area 2-26 to 2-30
 Misfeed original 2-31
 Misfeed removal 2-23
 -Tray 1 - tray 2 2-26
 -Tray 3 - tray 4 2-27
 -Automatic document feeder 2-31
 -Bypass tray 2-28
 -Finisher/saddle stitch finisher 3-11
 -Inserter 3-17
 -Transport area, fusing area, and exit area 2-24
 -Tray 5 2-29 to 2-30
 -Duplex unit 2-25
 Mode select key 1-15
 Mode select keys 1-13, 7-4
 More information on plain paper 2-13
 More information on special media 2-13
 Multi shot 1-5, 5-3, 5-24
- N**
 Network expansion kit 1-12
 Network scanner expansion kit 1-12
 Non-standard sizes 2-12, 2-14, 2-17, 4-5
 Number of pages printed 1-18
 number of pages transmitted (scanned) 1-18
 Numeric keys 1-13, 7-4
- O**
 Offset 1-7, 3-4
 [OFFSET] key 3-6
 Operation panel 1-10, 1-13
 -Document filing function 7-4
 -Inserter 3-15
 Original guides 4-3
 Original orientation 3-5, 4-4
 Original size 4-2, 4-5, 4-6
 Output 3-4, 3-6, 4-9, 4-12
 Output tray 1-10, 4-9

■ P

Pamphlet copy..... 1-4, 5-2, 5-6
 Paper curled..... 2-33
 Paper tray settings 2-14, 2-20
 Part names
 -Exterior 1-10
 -Finisher and the saddle stitch finisher..... 3-2
 -Inserter..... 3-14
 -Interior..... 1-11
 -Operation panel 1-13, 3-15, 7-4
 -Trays..... 2-2
 Password..... 7-8
 Peripheral devices..... 1-10, 1-12
 Photo..... 4-14
 Photoconductive drum 1-11
 Placing originals..... 4-3
 Plain paper 2-12 to 2-13
 Portrait..... 1-2
 Postcards 2-10 to 2-11, 4-20
 Power 1-17, 2-32
 Power switch 1-11, 1-17
 Preheat mode..... 1-9
 Preset copy ratios..... 4-16
 [PRINT JOB] key 1-16
 PRINT mode indicators 1-13
 Printer condition 2-18
 Printer test page..... 2-20
 [PRIORITY] key..... 1-16
 Proper storage 2-22
 Protect..... 7-3
 PS3 expansion kit 1-12
 Punch module 1-11, 3-2
 [PUNCH] key..... 3-6, 3-15

■ Q

Quick File folder 7-3
 [QUICK FILE FOLDER] key 7-5

■ R

[READ-END] key 4-12, 5-8 to 5-9
 Reduction 4-15
 Reduction/Enlargement..... 1-4, 4-15
 Replacing the toner cartridges 2-21
 Right side cover..... 1-11
 Rotation copying 4-4

■ S

Saddle stitch..... 1-8, 3-5
 Saddle stitch finisher 1-10, 3-2
 Saddle stitch tray..... 3-2
 [SADDLE STITCH] key 3-6
 Saving a document image file 7-6 to 7-12
 -Filing 7-7 to 7-8
 -Print jobs 7-9
 -Quick file 7-6
 -Scan save 7-10 to 7-11
 [SCAN TO] key..... 1-15
 [SCAN TO HDD] key 7-5
 [SEARCH] key..... 7-5
 Searching for a file 7-13 to 7-14

Selecting a function..... 1-14
 Selecting the exposure level..... 4-14
 Selecting the exposure mode..... 4-14
 Selecting the output tray..... 4-9
 Sender control..... 2-18
 Sender control list 2-20
 Sending address list..... 2-20
 Setting the paper size..... 2-14 to 2-17
 Setting the paper type 2-14 to 2-16
 Sharing..... 7-3
 Sharp OSA 3-19
 Sort..... 1-3, 3-4, 4-9
 [SORT] key 3-6
 Special modes (Copier operation)..... 5-2
 Special modes (Document filing function) 7-12
 Special paper 2-12 to 2-13
 Special papers 4-20
 Specifications 8-2 to 8-3
 -Finisher/saddle stitch finisher..... 3-2 to 3-3
 -Inserter..... 3-14
 -Large capacity tray (AR-LC6)..... 2-7
 -Large capacity tray (AR-LC7)..... 2-8
 -Punch module 3-3
 Specifications of paper trays 2-12
 Standard sizes..... 1-2, 2-13
 Standard sizes in both the AB and inch systems ... 1-2
 Staple cartridge 3-3
 Staple cartridge replacement 3-7 to 3-8
 Staple jam removal..... 3-9 to 3-10
 Staple sort..... 1-7, 3-4
 [STAPLE SORT] key..... 3-6
 [STAPLE] key 3-15
 Stapler compiler 3-2
 Stapling positions 3-4
 [START] key..... 1-13, 3-15
 [STOP/DELETE] key 1-16
 Storage of supplies..... 2-22
 System settings..... 2-18, 7-24
 [SYSTEM SETTINGS] key 1-13, 7-4

■ T

Tab copy 1-6, 5-2, 5-26
 Tabbed paper..... 2-6, 2-10, 2-12 to 2-13, 3-15, 4-20, 5-12, 5-27
 Tandem copy 1-5, 5-2, 5-10
 Text..... 4-14
 Text/photo..... 4-14
 The machine does not operate..... 2-32, 6-3
 Toner cartridge 1-11, 2-21
 Top cover..... 3-2
 Total count..... 2-20
 Total number of originals 4-2
 Touch panel..... 1-13, 1-14, 7-4, 7-5
 Transparency film 2-6, 2-12, 2-13, 4-20, 5-23
 Transparency inserts 1-5, 5-2, 5-23
 Tray..... 1-10, 3-2
 Tray 1..... 1-10, 2-2 to 2-4, 2-26
 Tray 2..... 1-10, 2-2 to 2-4, 2-26
 Tray 3..... 1-10, 2-5, 2-27
 Tray 4..... 1-10, 2-6, 2-27
 Tray 5..... 1-10, 2-7, 2-8, 2-29, 2-30

Troubleshooting	
-Copier operation	6-3
-Document filing function.....	7-31
-Finisher/saddle stitch finisher.....	3-13
-General information	2-32 to 2-34
-Inserter.....	3-18
Types and sizes of paper	2-12 to 2-13
Types and sizes of paper that can be used.....	2-12

■ U

Upper cover of large capacity tray.....	1-11
User maintenance	6-2
User name.....	7-24 to 7-26

■ W

Warming up.....	2-32
-----------------	------

■ X

XY Zoom	1-4, 4-18
---------------	-----------

■ Z



Zoom.....	4-16
-----------	------

Required in IEC-950 (EN 60 950) - Europe

- The equipment should be installed near an accessible socket outlet for easy disconnection.

Required in Appendix ZB of BS 7002 (En 60 950) — United Kingdom

MAINS PLUG WIRING INSTRUCTIONS

The mains lead of this equipment is already fitted with a mains plug which is either a non-rewireable (moulded) or a rewireable type. Should the fuse need to be replaced, a BSI or ASTA approved fuse to BS1362 marked  or  and of the same rating as the one removed from the plug must be used.

Always refit the fuse cover after replacing the fuse on the moulded plug. Never use the plug without the fuse cover fitted.

In the unlikely event of the socket outlet in your home not being compatible with the plug supplied either cut-off the moulded plug (if this type is fitted) or remove by undoing the screws if a rewireable plug is fitted and fit an appropriate type observing the wiring code below.

DANGER: The fuse should be removed from the cut-off plug and the plug destroyed immediately and disposed of in a safe manner. Under no circumstances should the cut-off plug be inserted elsewhere into a 13A socket outlet as a serious electric shock may occur.

To fit an appropriate plug to the mains lead, follow the instructions below:

IMPORTANT: The wires in this mains lead are coloured in accordance with the following code:

GREEN-AND-YELLOW:	Earth
BLUE:	Neutral
BROWN:	Live

As the colours of the wires in this mains lead may not correspond with coloured markings identifying the terminals in your plug, proceed as follows:

The wire which is coloured **GREEN-AND-YELLOW** must be connected to the terminal in the plug which is marked with the letter **E**, or by the safety earth symbol , or coloured green or green-and-yellow.

The wire which is coloured **BLUE** must be connected to the terminal which is marked with the letter **N** or coloured black.

The wire which is coloured **BROWN** must be connected to the terminal which is marked with the letter **L** or coloured red.

If you have any doubt, consult a qualified electrician.

WARNING: THIS APPARATUS MUST BE EARTHED.

SHARP ELECTRONICS (Europe) GmbH
SonninstraÙe 3, D-20097 Hamburg

MX-M550U/MX-M620U/MX-M700U/MX-M550N/MX-M620N/MX-M700N
OPERATION MANUAL (for general information and copier operation)

SHARP[®]
SHARP CORPORATION

PRINTED IN FRANCE
TINSE3587GHZZ

