





Notice for Users in the USA

FCC Statement

WARNING - FCC Regulations state that any unauthorized changes or modifications to this equipment not expressly approved by the manufacturer could void the user's authority to operate this equipment.

Note: This equipment has been tested and found to comply with the limits for a Class B digital device pursuant to Part 15 of the FCC Rules.

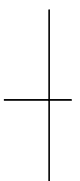
These limits are designed to provide reasonable protection against harmful interference in a residential installation. This equipment generates, uses and can radiate radio frequency energy and, if not installed and used in accordance with the instructions, may cause harmful interference to radio communications. However, there is no guarantee that interference will not occur in a particular installation. If this equipment does cause harmful interference to radio or television reception, which can be determined by turning the equipment off and on, the user is encouraged to try to correct the interference by one or more of the following measures:

- 
- 
- Reorient or relocate the receiving antenna.
 - Increase the distance between the equipment and receiver.
 - Connect the equipment into an outlet on a circuit different from that to which the receiver is connected.
 - Consult the dealer or an experienced radio/TV technician for help.

A shielded I/F cable and included ferrite core for LAN cable is required to insure compliance with FCC regulation for Class B computing equipment.

- * As an ENERGY STAR[®] Partner, SHARP has determined that this product meets the ENERGY STAR[®] guidelines for energy efficiency.

Declaration of Conformity

SHARP PERSONAL COMPUTER, PC-AV Series

This device complies with part 15 of the FCC rules. Operation is subject to the following conditions: (1) this device may not cause harmful interference, and (2) this device must accept any interference received, including interference that may cause undesired operation.

Responsible Party: SHARP ELECTRONICS CORPORATION
Sharp Plaza, Mahwah, New Jersey 07430-2135
TEL: 1-800-BE-SHARP



About the Modem

This equipment complies with Part 68 of FCC rules. On the bottom of this equipment is a label that contains, among other information, the FCC registration number and ringer equivalence number (REN) for this equipment. If requested, this information must be provided to the telephone company.

The modem jack of this equipment complies with Sub-part F of Part 68 of FCC rules.

The REN is used to determine the quantity of devices which may be connected to the telephone line. Excessive RENs on the telephone line may result in the devices not ringing in response to an incoming call. In most, but not all areas, the sum of the RENs should not exceed five (5.0). To be certain of the number of devices that may be connected to the line, as determined by the total RENs contact the telephone company to determine the maximum REN for the calling areas.

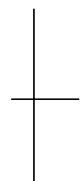
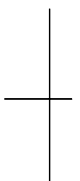



If the terminal equipment causes harm to the telephone network, the telephone company will notify you in advance that temporary discontinuance of service may be required. But if advance notice isn't practical, the telephone company will notify the customer as soon as possible. Also, you will be advised of your right to file a complaint with the FCC if you believe it necessary.

The telephone company may make changes in its facilities, equipment, operations, or procedures that could affect the operation of the equipment. If this happens, the telephone company will provide advance notice in order for you to make the necessary modifications in order to maintain uninterrupted service.

If trouble is experienced with this equipment, please contact Sharp Electronics Corp. for repair and (or) warranty information (Refer to the provided Consumer Limited Warranty). If the trouble is causing harm to the telephone network, the telephone company may request you remove the equipment from the network until the problem is resolved.

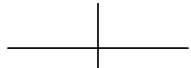
The equipment cannot be used on public coin service provided by the telephone company. Connection to Party Line Service is subject to state tariffs. (Contact the state public utility commission, public service commission or corporation commission for information.)



The Telephone Consumer Protection Act of 1991 makes it unlawful for any person to use a computer or other electronic device, including fax machines, to send any message unless such message clearly contains in a margin at the top or bottom of each transmitted page or on the first page of the transmission, the date and time it is sent and an identification of the business or other entity, or other individual sending the message and the telephone number of the sending machine or such business, other entity, or individual. (The telephone number provided may not be a 900 number or any other number for which charges exceed local or long-distance transmission charges.) To program this information, refer to the manual of the communication software.

Warning

This product utilizes tin-lead solder, and fluorescent lamp containing a small amount of mercury.
Disposal of these materials may be regulated due to environmental considerations. For disposal or recycling information, please contact your local authorities or the Electronics Industries Alliance: www.eiae.org

Copyright

It is the intent of Sharp that this product be used in full compliance with the copyright laws of the United States and that prior permission be obtained from copyright owners whenever necessary.

Product Information and Customer Assistance

For Product Information and Customer Assistance:

Call: 1-800-BE-SHARP (237-4277)

Sharp Systems of America

5901 Bolsa Avenue, Huntington Beach, CA 92647

Home Page: <http://www.sharpsystems.com>

E-mail address: ssa-support@sharpsystems.com



CAUTION:

TO PREVENT ELECTRICAL SHOCK, DISCONNECT THE AC CORD AND THE BATTERY BEFORE SERVICING.

CAUTION:

FOR A COMPLETE ELECTRICAL DISCONNECTION, PULL OUT THE MAIN PLUG AND THE BATTERY.

VORSICHT:

UM DIE STROMZUFUHR VOLLSTÄNDIG ZU UNTERBRECHEN, DEN NETZSTECKER HERAUSZIEHEN UND DIE BATTERIE ENTFERNEN.

ATTENTION:

POUR UN ARRET TOTAL DU SYSTEME, DECONNECTEZ LA PRISE DE COURANT SECTEUR ET LA BATTERIE.



WARNING:

FÖR TOTAL ELEKTRISK URKOPPLING, KOPPLA UR KONTAKTEN OCH TA UR BATTERIET.



PRECAUCION:

PARA UNA COMPLETA DESCONEXION ELECTRICA DESENCHUFE LA CLAVIJA DE LA RED Y LA BATERIA.





Safety Precautions

General

- Follow all cautions and instructions, which may be marked, on your computer.
- Except as described elsewhere in this manual, refer all servicing to qualified personnel. Immediately shut off your computer and seek servicing under the following conditions:
 - when the power cord or plug is damaged or frayed
 - when liquid has been spilled on your computer
 - when your computer has been dropped or the cabinet has been damaged

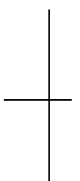
Location

- 
- 
- Do not expose your computer to direct sunlight.
 - Try to avoid dusty environments.
 - Keep your computer away from any magnetic devices and TVs.
 - Keep your computer away from excessive humidity or fluids such as rain, snow, water spray, juice, coffee, steam, etc.
 - Do not move your computer from an extremely cold place to an extremely warm place. A temperature difference of more than 10°C (18°F) will cause condensation inside the unit, which may cause damage.
 - Do not block or cover slots or openings on the cabinet. They protect your computer from overheating.
 - Do not place your computer on an unstable or uneven work surface.
 - Care should be exercised when using on heat sensitive surfaces or your lap as the base of your computer will get hot.
 - Do not use your computer on your lap or any part of your body for an extended period during operation or charging to avoid injury from heat exposure.

Usage

- Never push any kinds of objects into cabinet openings. They may touch dangerous voltage points or short parts that could result in fire or electrical shock.
- Turn off your computer before installing or removing any peripheral devices except when connecting USB devices, an IEEE1394 device, a PC card, etc.

- Check the AC power cord and power connectors periodically for damage. Change the power cord immediately if damage is found.
- Never subject your computer to sudden shocks or extreme vibration.
- Do not drop your computer nor hit it with other equipment.
- Do not scratch the surface of the LCD screen.
- Turn off your computer and disconnect the AC power cord before cleaning.

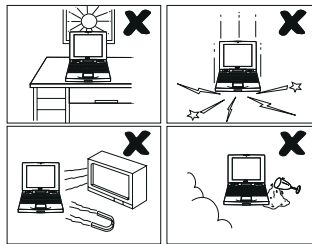

Battery Pack Precautions

CAUTION

DANGER OF EXPLOSION IF BATTERY IS INCORRECTLY REPLACED. REPLACE ONLY WITH THE SAME OR EQUIVALENT TYPE RECOMMENDED BY THE MANUFACTURER. DISCARD USED BATTERIES ACCORDING TO THE MANUFACTURER'S INSTRUCTIONS.

Handling

- Never put the battery pack in a fire, as it could explode and cause injury.
- Do not attempt to open or alter the battery pack.
- Do not place the battery where it might get hotter than 60°C (140°F).
- The battery pack must be kept from metal objects such as jewelry and liquids. They might trigger a short circuit and consequently cause the battery pack to heat up and explode.
- Do not allow liquids to come in contact with the battery pack.
- Care must be taken not to drop the pack. A violent shock damages the pack.
- Do not solder anything to the battery terminals.



Charging

- Charge the battery pack only with the AC adapter and AC power cord included with your computer.



Discharging

- Do not use the battery pack for any purpose other than powering your computer.

Storage

- Store the battery pack in a cool and dry place. Do not store it at temperatures above 60°C (140°F).
- Recharge the stored battery pack, before using it.

Modem Precautions

- 
- 
- Do not use this product near water, for example, near a bath tub, wash bowl, kitchen sink or laundry tub, in a wet basement or near a swimming pool.
 - Avoid using a telephone (other than a cordless type) during an electrical storm. There may be a remote risk of electric shock from lightning.
 - Do not use the telephone to report a gas leak in the vicinity of the leak.
 - Never install telephone wiring during a lightning storm.
 - Never install telephone jacks in wet locations unless the jack is specifically designed for wet locations.
 - Never touch uninsulated telephone wires or terminals unless the telephone line has been disconnected at the network interface.
 - Use caution when installing or modifying telephone lines.

Wireless LAN Precautions

- Do not communicate with wireless LAN in specific environment where radio-susceptible equipment are nearby such as on airplanes, in hospital, etc.
- Do not touch the antennas while communicating.



About This Manual

Notice

Information in this manual is subject to change without notice and does not represent a commitment on the part of SHARP Corporation and its sales subsidiaries.

SHARP Corporation and its sales subsidiaries shall not be liable for technical or editorial errors or omissions contained herein; nor for incidental or consequential damages resulting from the furnishing, performance, or use of this material.

SHARP strongly recommends that separate permanent written records be kept of all important data. Data may be lost or altered in virtually any electronic memory product under certain circumstances. Therefore, SHARP assumes no responsibility for data lost or otherwise rendered unusable whether as a result of improper use, repairs, defects, battery replacement, use after the specified battery life has expired, or any other causes.

SHARP assumes no responsibility directly or indirectly, for financial losses or claims from third persons resulting from the use of this product and any of its functions, such as stolen credit card numbers, the loss of or alteration of stored data, etc.

Edition

1st Edition, July 2003.



Copyright



© 2003 SHARP Corporation

This document contains or refers to proprietary information which is protected by copyright. All rights are reserved. Copying or other reproduction of this document is prohibited without the prior written permission of SHARP Corporation.

Trademarks

AMD, the AMD logo, AMD Athlon, and AMD PowerNow! are trademarks of Advanced Micro Devices, Inc.

IBM is a trademark of International Business Machines Corporation.

Microsoft and Windows are registered trademarks of Microsoft Corporation in the United States and other countries. Windows Media is a trademark of Microsoft Corporation in the United States and other countries.

WinDVD is a registered trademark of InterVideo, Inc.

Dolby and the double-D symbol are registered trademarks of Dolby Laboratories Licensing Corporation.

Power Quest is a registered trademark and EasyRestore is a trademark of PowerQuest Corporation.

BAPCo is a registered trademark of the Business Applications Performance Corporation.

MobileMark is a trademark of the Business Applications Performance Corporation.

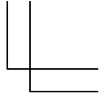
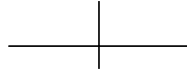
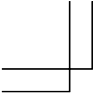

All other brand and product names are trademarks or registered trademarks of their respective holders.

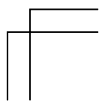
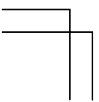
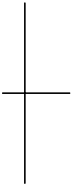
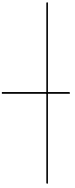

Recording Important Information

For future reference, please record the following information in the spaces provided below.

Model Number:

Serial Number:

Date of purchase:

Dealer's Name:

Place of purchase:

Password:

The serial number is printed on a sticker located on the bottom of your computer.

Manual Conventions

This manual uses a set of style conventions described below.

Notes and Cautions are italicized with icons:



A note icon informs you of a special technique or information that may help you perform a task or better understand a process.



A caution icon alerts you to something that may cause problems or damage to hardware, software or data.

Key Labels on the Keyboard, when referred to in the instructions, are shown in boldface:

Press **Enter** to continue.

When two or more keys are pressed simultaneously, the key labels are separated by a plus (+) sign:

Restart your computer by pressing **Ctrl+Alt+Delete**.

Sample Entries are shown in lower cases of different typeface.

`c:\windows\system`

Words/Texts on Screen, such as window titles or possible parameters, are italicized:

Double-click this icon to display the *Power Options Properties* window.

Set the item to *Enabled*.

Screens reproduced in this manual may differ slightly from the screens you see on your computer.

Section Titles in other parts of this manual are italicized:

Refer to *Installing Battery Pack* section of Chapter 1.

Table of Contents

Notice for Users in the USA	i
Safety Precautions	v
About This Manual	viii
Recording Important Information	x
Manual Conventions	xi
Table of Contents	xii
Overview of Computer	xiv

Quick Setup

Installing Battery Pack	1-1
Connecting to AC Power Source	1-2
Setting Up Windows	1-4
Turning Off Your Computer	1-6

Basic Operations

Choosing Power Source	2-1
Resetting System	2-3
Using Glide Pad	2-4
Using Keyboard	2-6
Using Optical Drive	2-7
Writing Data to CD-R/RW Disk	2-10
Watching DVD Video	2-11
Controlling Volume	2-15
Adjusting Display	2-16
Sharing Your Computer	2-19

Battery and Power Management

Battery Pack	3-1
Optional Add-on Battery Pack	3-6
Power Management	3-10

Peripherals

Using Peripherals.....	4-1
Optional External Floppy Disk Drive Unit.....	4-3
External Display	4-5
Audio System	4-7
USB Device	4-11
PC Card.....	4-12
Printer	4-14
IEEE 1394 Device	4-15

Communication Functions

Built-in Modem	5-1
LAN Unit.....	5-4
Wireless LAN.....	5-7
Network Setup Utility.....	5-11

Setup Utility

Running the Setup Utility	6-1
Main Menu	6-3
Advanced Menu.....	6-4
Security Menu.....	6-4
Boot Menu	6-6
Exit Menu	6-6

Appendixes

Memory Module	A-1
Installing Weight Saver	A-4
Maintenance and Care	A-6
Re-installation Instructions	A-11

Troubleshooting

Index

Overview of Computer

Each number after an arrow indicates the page referring to the part. Actual appearance of your computer may be slightly different depending on the model.

Front

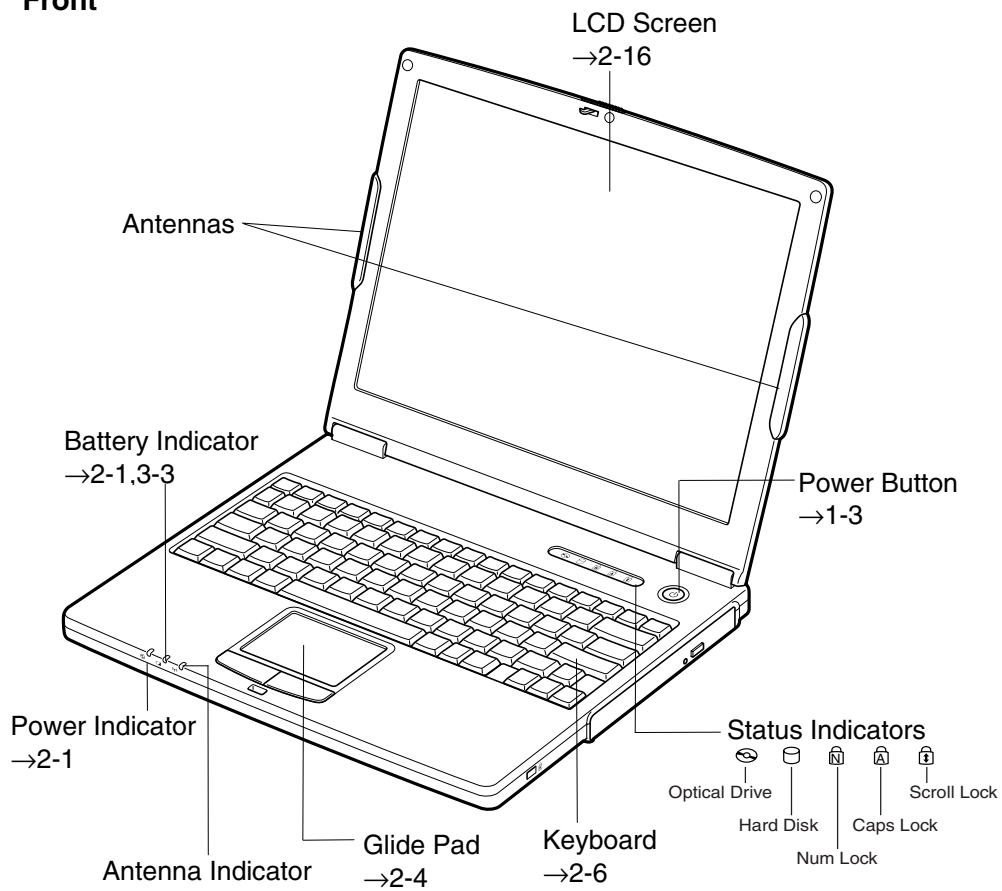

Right

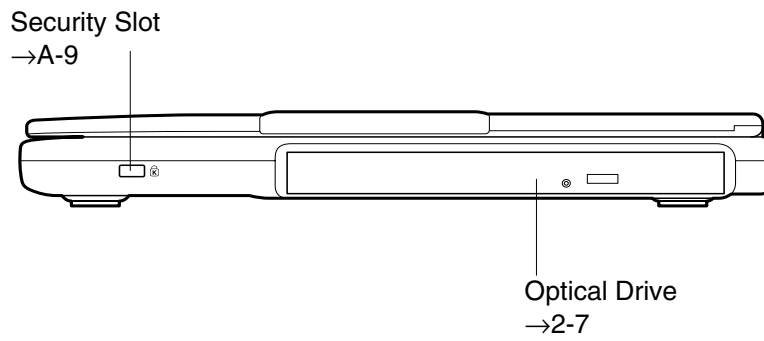

Left

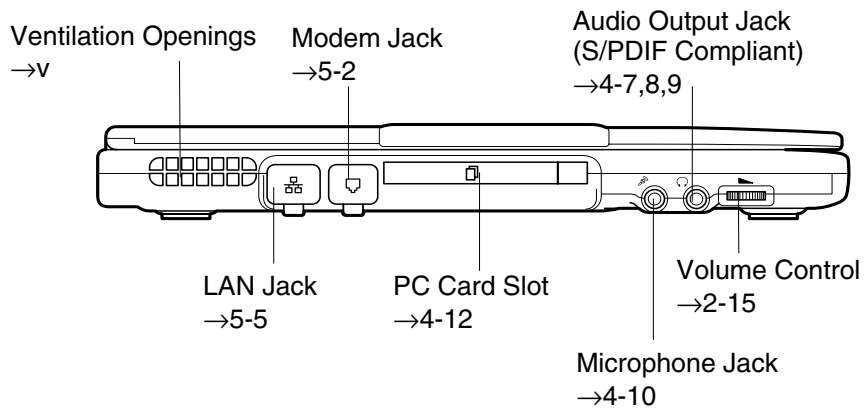

Rear

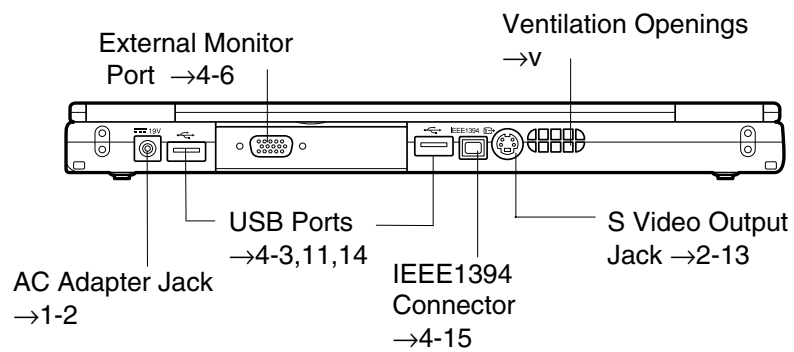

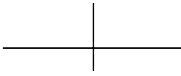

Bottom

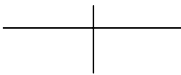
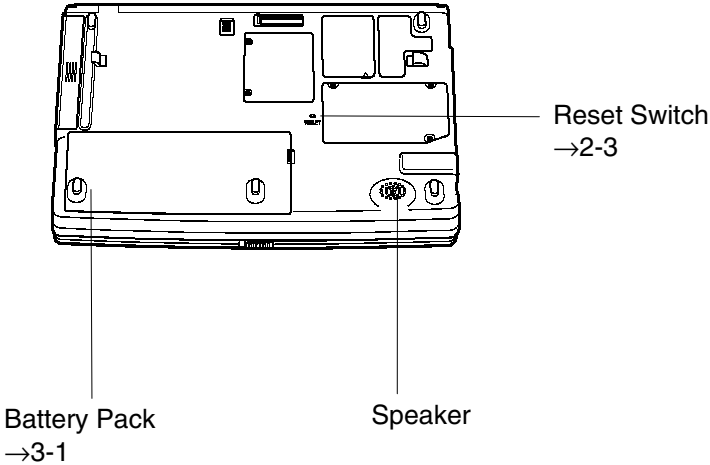

CHAPTER 1

Quick Setup

1

Your computer is designed and pre-configured for easy setup and use. This chapter describes the steps to set up and run your computer as quickly as possible. Read this chapter first.

Installing Battery Pack

Your computer is powered with either the rechargeable battery pack or AC power source. See the next chapter for more information on the power sources. Before starting to use your computer for the first time, follow these instructions.

1. Place your computer with the bottom up on a stable work surface.
2. Insert the battery pack into your computer by matching the projected parts of the battery pack to the notched parts on your computer.

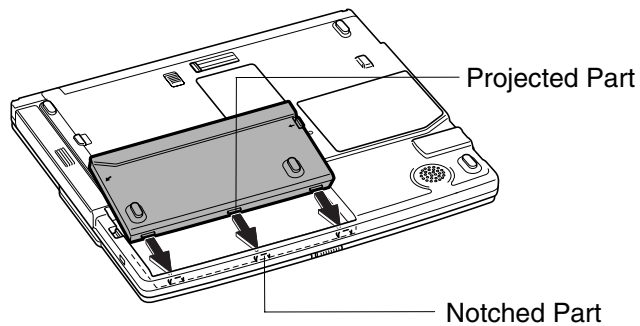

3. Push the battery pack until you hear the clicking sound.

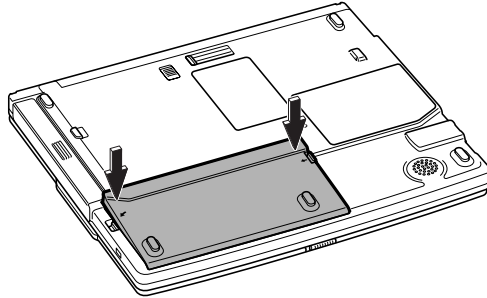

4. Turn your computer over and go to the next section.

Connecting to AC Power Source



- *Always use the AC adapter and AC power cord included with your computer or the optional one (may not be available in some countries). Using others may damage your computer.*
- *Always hold the AC power cord by the plug when removing it from the wall outlet. Never pull on the cord.*
- *Never plug in and out the AC power cord with your wet hands.*
- *When using your computer for the first time, be sure to operate it on AC power. On battery power instead, you may not be able to complete the Windows setup if the battery does not have enough power.*

1. Plug the AC adapter cable to the AC adapter jack on the rear side of your computer.
2. Plug the AC power cord into the AC adapter.
3. Plug the AC power cord into a wall outlet.

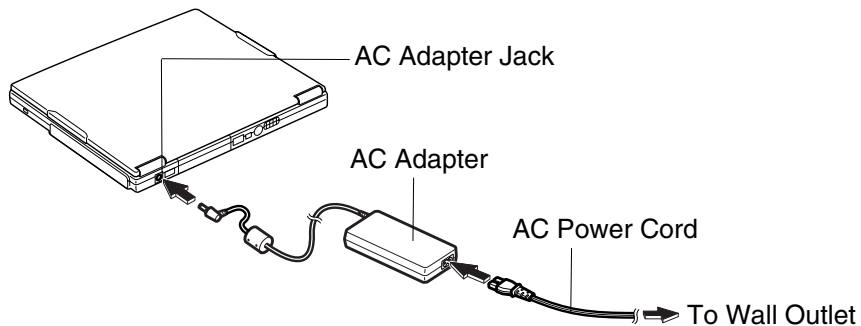

4. Slide the display cover lock lever to the right until the display cover releases, and raise the cover.

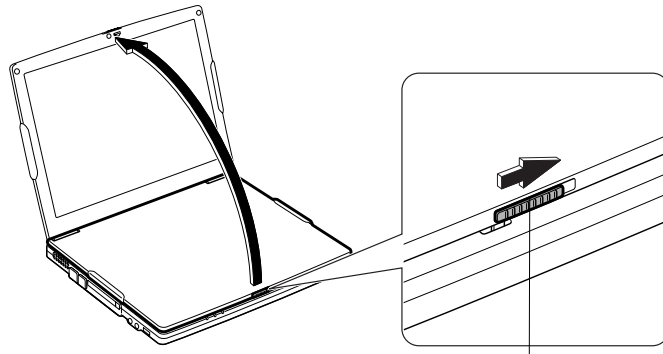

Display Cover Lock Lever

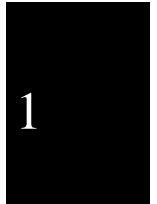

5. Press the power button to turn on your computer.

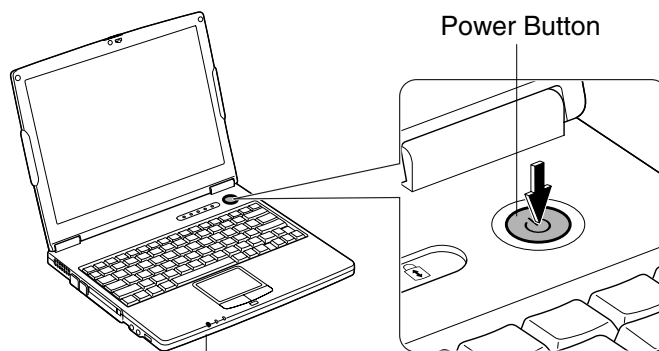

Power Button

Power Indicator

When you turn on your computer, the power indicator (Ⓢ) turns green, your computer goes through a self-test to detect any problems, and Windows setup process starts. See the next page.

Setting Up Windows

To setup Windows, follow the instructions on the screen. See also the Windows quick start guide. It takes approximately 5-10 minutes to complete the entire setup process. The steps in the setup process are as follows:

1

- Configuring your location, language and keyboard type
- Configuring your time zone
- Accepting license agreement
- Naming your computer
- Creating an account
- Completing configuration



- *Do not turn off your computer until completing Windows setup. If you turn it off, you may not be able to set up Windows later.*
- *Be sure to connect your computer to AC power source. An undercharged battery may not be able to complete the Windows setup.*
- *Do not connect any peripheral devices to your computer until the Windows setup is completed. Otherwise your computer may malfunction.*



- *If the display turns off, some power management may function. In this case, press any key to resume your computer from the power management. . (Refer to Power Management section of Chapter 3.)*
- *If you cannot operate the keyboard or the glide pad, press the power button for more than four seconds to turn off your computer. Be sure that the power indicator turns off; then, after more than 10 seconds, press the power button to turn on your computer again.*

After completing the Windows XP setup:

- Confirm *Time Zone* is correctly selected and set the date and time by double-clicking the time appearing on the right of the taskbar to open *Date and Time Properties* dialog box.

Press **Fn+F1** () keys to activate the integrated antennas for Wireless LAN communication.



Properties Dialog Box on Windows

In this manual, you will often see the expression “XXX Properties dialog box.” The dialog box is a window containing text boxes, check boxes, buttons, etc., with which you can send commands to Windows or other applications. To open the properties dialog boxes, click *start - Control Panel*. The *Control Panel* has two types of views: *Category View* and *Classic View*. The *Category View* allows you to choose the category that may be related to what you want to do, then, choose your task by clicking it. The *Classic View* gives you the icons representing their components or features. Double-click one of the icons to open its dialog box or window. Some of the dialog boxes you will use often are:

- Display
- Phone and Modem Options
- Mouse
- Power Options
- System



Clicking Switch to XXX View string appearing at the upper left of the Control Panel window allows you to toggle between the two views.

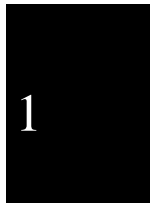
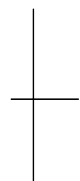
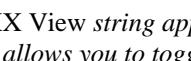
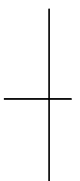

Turning Off Your Computer

When you've finished using your computer, turn it off with one of the following steps:

1

- From the *start* menu
 1. Click start – Turn Off Computer.
 2. In the Turn off computer dialog box, click Turn Off.
- With the power button

Before using this step, confirm that the power button is enabled to shut down your computer. Follow these instructions.

 1. Open *Power Options Properties* dialog box. Select *Advanced* tab.
 2. Confirm that *Shut down* is selected in the pull-down menu of *When I press the power button on my computer*.

Close the display cover to keep the screen and keyboard clean and protected.



If you have not saved the data, a dialog box will appear asking whether you want to save it.



- *Do not turn off or reset your computer while the hard disk indicator, optical drive indicator, or the indicator on the optional external floppy disk drive is lit. Doing so may damage or even wipe out the data.*
 - *After turning off your computer you need to wait at least ten seconds before turning it back on. Turning the power off and on in rapid succession can damage your computer's electrical circuitry.*
-

CHAPTER 2

Basic Operations

2

This chapter describes the basic operations of your computer.



Choosing Power Source

You can use your computer with one of the following power sources:

- AC power from a wall outlet
Use AC power whenever possible; rely on the battery only when AC power is not available.
- Rechargeable battery
A standard battery pack is supplied with your computer. You can also use an optional add-on battery. See Chapter 3 for the battery information.

About Power Indicators

The following indicators show the power status of your computer.

Indicator	Light	Meaning	
Power 	On (green)	Operating	
	Blinking (green)	In System Standby	
	Off	Powered off or in System Hibernate	
Battery 	Connected to AC Power Source	On (green)	Fully charged
		On (orange)	Being charged
		Blinking (orange)	In abnormal state (Remove the battery pack and install it again.)
	Powered by Battery	Off	Has power
		Blinking (red)	Almost completely discharged (The warning beep sounds.)

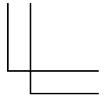
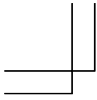

The battery indicator is always off when your computer is turned off and not connected to AC power source.



- *When the battery is hot, the battery indicator may turn off and stay off until the battery becomes cool.*
- *For more information on System standby/hibernate, see Chapter 3.*



Using AC Adapter

When connected to a wall outlet, the AC adapter provides power for operation and charges the battery pack. The AC input voltage can range from 100 to 240 volts so that you can use your computer with the appropriate plug adapter.



The AC power cord included with your computer is appropriate for the voltage used in the area in which you purchased your computer. If you attempt to connect your computer to a wall outlet in other areas, check the voltage of the outlet and use an AC power cord appropriate for the outlet. Consult local service staff if you are not sure.

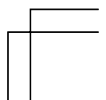
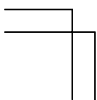
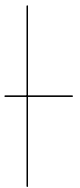
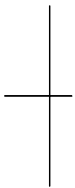

Resetting System

You may need to restart the system if your computer becomes inoperable or after adding new hardware or software. When the message appears after the installation, click *OK*, *Yes*, etc. to restart Windows.

You can also restart Windows by clicking *start – Turn Off Computer*; then, *Restart*.



Resetting may cause data loss. Use the resetting process only if the normal Windows XP Shut Down does not work because of software malfunction. Although resetting will not damage the system, you may lose the data you are processing.

2

Warm Boot (Software Reset)

If the system is locked up because of a software problem, you can reset or reboot the system by pressing the **Ctrl+Alt+Del** keys simultaneously and select *Applications* tab of *Windows Task Manager* dialog box. Click the name of the program hanging up, then, *End Task*. If this does not work, select *Users* tab and click *Disconnect* or *Logoff*, then, *Yes*.

Power Switch

You can turn off your computer by pressing the power button if you encounter hardware or software problems locking up the system. In this case, press the power button for more than four seconds.

Reset Switch

If you cannot turn off your computer with the power button, you can use the reset switch on the bottom of your computer. To reset the system, insert a narrow object into the small hole to press the switch.

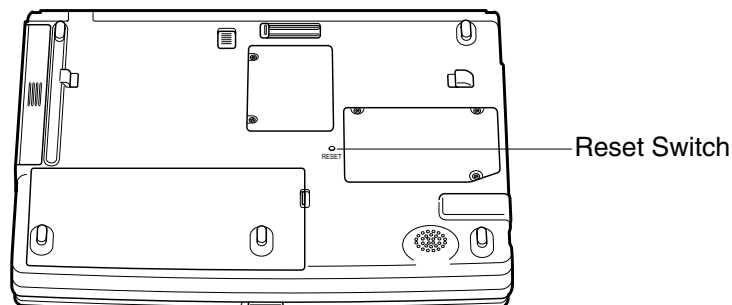

Using Glide Pad

Your computer is equipped with an integrated pointing device called glide pad. Using the glide pad, you can move the pointer, select an item from a menu and perform other tasks in the same way you would with a mouse.

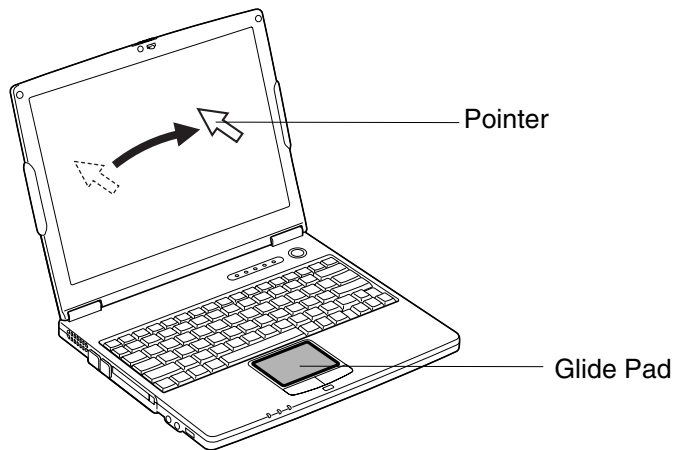

- *Do not hit or scratch the surface of the glide pad with pointed objects (such as a ballpoint pen).*
- *Do not operate the glide pad with a moist finger. This may cause the glide pad to operate incorrectly.*

Using Glide Pad

Take a moment to become familiar with how the glide pad works.

Place Your Fingertip

Place your left or right hand next to the glide pad, resting your wrist naturally in a relaxed manner. Place your thumb or a finger(s) on the glide pad.

Move Your Fingertip

The rectangular surface of the glide pad acts like a miniature duplicate of the display. As you slide your fingertip across the pad, the pointer on the screen moves in the same direction across the screen. The glide pad is very sensitive, so you do not have to exert much pressure on the pad. The glide pad will respond to a light touch from your fingertip.



Click, Double-click, and Right-click

To click or double-click, you can use the left button just like that of a mouse. Instead of clicking the left button, you can also just tap gently anywhere on the rectangular pad. For right-clicking, you must use the right button.

Drag and Drop

You can move icons or windows by using “drag and drop” below:

1. Position the pointer over the object.
2. Press the left button; do not release it.
3. Holding down the button, move the pointer. The object moves together with the pointer.
4. Release the button when the object reaches its destination.

Or you can tap the pad twice instead of pressing the left button in the step 2.

Scroll



You can scroll through information in a list or in a document by using the glide pad. To view information vertically, place your finger on the most right part of the glide pad and slide your finger up and down. To view horizontally, place your finger on the bottom part of the glide pad and slide your finger to the left or the right. This procedure works only in limited applications.

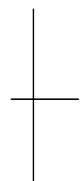

Changing Configuration

In the *Mouse Properties* dialog box, you can change the configuration of the glide pad, such as swapping left and right buttons, changing the pointer size, etc. Double-click *Touch Pad* icon () on the taskbar to open the *Mouse Properties* dialog box.

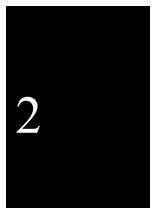

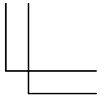

Using Keyboard

Your computer, equipped with the Windows Enhanced Keyboard, provides all the functionality of a full-sized desktop keyboard.

Special Keys



Windows Key

Opens the Windows start menu.



Application Key

Opens an application-specific short-cut menu.
Equivalent to right-clicking.

System Function Keys

When pressed together with the **Fn** key, function keys set specific system parameters. This combination is sometimes referred to as “hot keys”.

Fn + F1 ()

Turns the wireless LAN antenna on and off.
(for built-in wireless LAN model only)

Fn + F5 ()

Rotates display mode between the LCD only, an external monitor only, and both.
(when connecting an external monitor)

Fn + F6 ()

Decreases the LCD screen brightness.

Fn + F7 ()

Increases the LCD screen brightness.

Fn + F11 ()

Turns on and off the LCD screen.

Fn + F12 ()

Forces your computer into System standby/System hibernate/Shut down. (See *Power Management* of Chapter 3 for more information.)



*Do not use the function keys **Fn+F5** during watching DVD videos or animation, or playing a video game.*

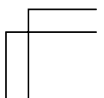

Using Optical Drive

Your computer is equipped with an optical drive allowing you to read from DVD and CD and write onto CD-R/RW.



CAUTION FOR LASER

Use of controls or adjustments or performance of procedures other than those specified herein may result in hazardous radiation exposure. Maximum output and wavelength of the laser:

*108mW, 784nm(CD-R/RW)
6mW, 662nm(DVD-ROM)*



2

Handling Disk

- Do not write on either side of the disk, particularly the non-label side. Data is read/written from/onto the non-label side. Do not mark this surface.
- Keep your disks away from direct sunlight, heat and excessive moisture.
- Always hold the disks by the edges. Fingerprints, dirt or water on the disks can cause noise or mistracking. If a disk is dirty or does not play properly, clean it with a soft, dry cloth, wiping straight out from the center, along the radius.



Inserting Disk

- 1. Make sure the optical drive indicator is not lit on; then, press the eject button. The drive tray will pop out.

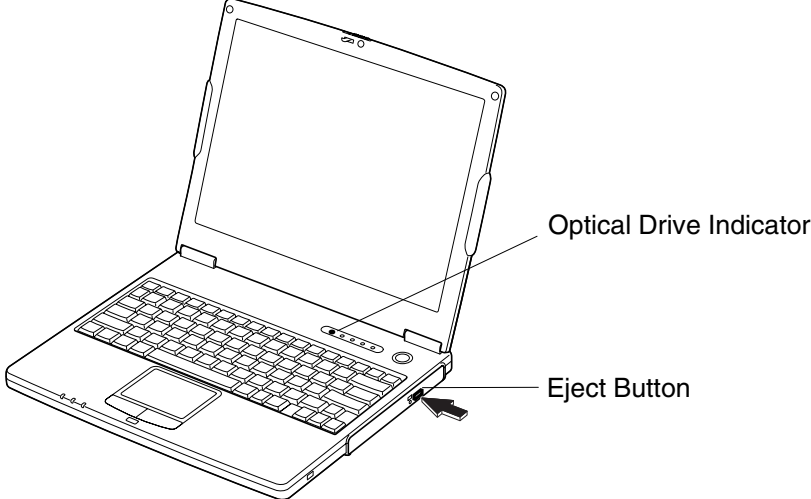

- 2. Gently pull out the tray.

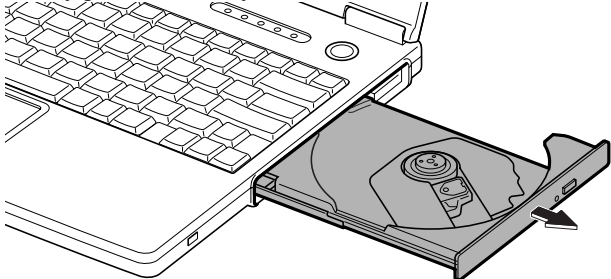

- 3. Place your disk, label side up, onto the tray and slightly press the center of the disk until it is locked into the place.

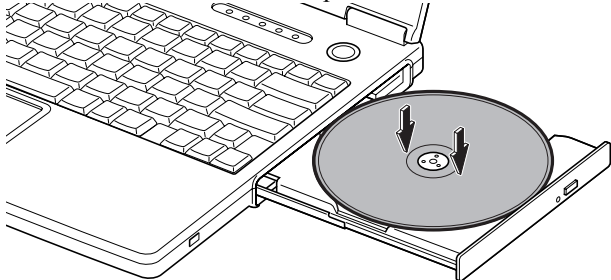

4. Gently push the tray back into your computer.

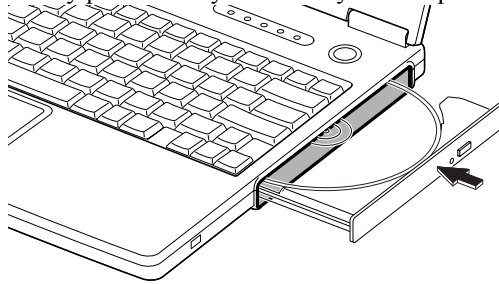

- Do not leave the tray pulled out. Also, avoid touching the lens in the tray. If the lens becomes dirty, the disk may malfunction.
- Do not wipe the lens with materials with rough surface (such as paper towels). Instead, use a cotton swab to gently wipe the lens.

2

Removing Disk

1. Make sure the optical drive indicator is not lit and press the eject button. The optical drive tray will pop out.



Make sure the optical drive indicator is not lit or blinking before pressing the eject button.

2. Gently pull out the tray.
3. Remove the disk from the tray by holding its edge.

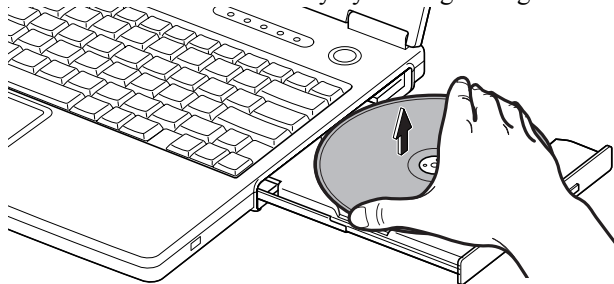

4. Gently push the tray back into your computer.

Writing Data to CD-R/RW Disk

You can use CD-R or CD-RW discs to write data on. CD-RW is an erasable disc onto which you can write data and from which you can erase data. CD-R is non-erasable disc onto which you can write data only once. If free space remains, you can add data until the disc is full.

2

To write data, run the application called *Drag'n Drop CD+ DVD* installed on your computer. See the online help of *Drag'n Drop CD+ DVD* for the details. To run the application, click *start – All Programs - Drag'n Drop CD+ DVD - Drag'n Drop CD+ DVD*.



- *Before writing to CD-R/RW, follow the instructions below:*
 - *Connect the AC adapter. If the battery is discharged, writing process will stop and fail.*
 - *Disable the power management. See Power Management of Chapter 3.*
 - *Close all of the unnecessary or the automatic start-up applications.*
 - *Disable the screen saver. (Refer to Changing Wallpaper and Setting Screen Saver section later in this chapter.)*
- *You cannot add data onto music CDs even if they are not full.*

Watching DVD Video

You can enjoy watching a DVD video on your computer using the application called *WinDVD*. See online help of *WinDVD* for more details. To run the application, click *start – All Programs – InterVideo WinDVD4 - InterVideo WinDVD4*.



- *Before watching DVD videos, follow the instructions below:*
 - *Connect the AC adapter. If the battery is discharged, the operation will stop.*
 - *Disable the power management. See Power Management of Chapter 3.*
 - *Close all of the unnecessary or the automatic start-up applications.*
 - *Disable the screen saver. (Refer to Changing Wallpaper and Setting Screen Saver section later in this chapter.)*
- *When playing a DVD video, you may experience a picture with an irregular motion, or frame dropouts, depending on videos.*
- *Set the display mode to LCD only or external monitor only. When set to simultaneous display, the DVD video will not be displayed properly.*
- *This product incorporates copyright protection technology that is protected by method claims of certain U.S. patents and other intellectual property rights owned by Macrovision Corporation and other rights owners. Use of this copyright protection technology must be authorized by Macrovision Corporation, and is intended for home and other limited viewing uses only unless otherwise authorized by Macrovision Corporation. Reverse engineering or disassembly is prohibited.*
(Apparatus Claims of U.S. Patent Nos. 4,631,603; 4,577,216;, 4,819,098 and 4,907,093 licensed for limited viewing uses only.)



Make sure to remove the DVD video from the drive when you finish watching it. If you turn off your computer with the disc left in the drive, the drive may not be recognized when your computer is turned on again.

Changing Region Code

A DVD video has a region code which prevents playback of the disc in certain regions. The region code appears on the top of the disc.

When shipped from the factory, your optical drive is set to a region code applicable to your area.

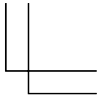

Your DVD drive region code can be changed. Code change is limited. Once the limit is reached, it cannot be changed any more. To confirm the limit, click Region tab of Setup dialog box and check bottom line in the window. (Refer to Using Parental Control section on the next page to open the Setup dialog box.)



Make sure to log on your computer as a member of the Computer administrators group. Otherwise you cannot change the region code.

Available region codes are:

Region Code	Area
1	U.S.A, Canada
2	West Europe, Japan, South Africa
3	South East Asia (including Hong Kong)
4	Australia, Spanish America
5	Former Soviet Union, Indian Subcontinent, Africa
6	China



To change the region code:

1. Insert a DVD video into the drive.
If the region code of the DVD video is different from that of your drive, *Confirm Region* dialog box appears.
2. The region code currently selected is checked in the left box. Region code of your DVD video is checked in the right box. If you want to change the drive code and play the DVD video, click *OK*.



On some DVD videos, plural region codes are selectable in the right box of Confirm Region dialog box. Carefully choose an appropriate one.



When Confirm Region dialog box does not appear:

1. Click start - My Computer – View system information.
2. In System Properties dialog box, select Hardware tab and click Device Manager button.
3. In Device Manager dialog box, double-click DVD/CD-ROM drives string and MATSHITA xxxxxx.(xxxxxx is your optical drive name.)
4. Select DVD Region tab, choose the listed distribution area of the DVD video, then, confirm the region code shown in the New Region field is correct and click *OK*.
5. Read the message on the screen, then, click *OK*.

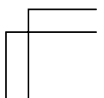
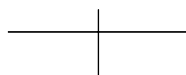

Using Parental Control

If you want to set the parental control to prevent your children from watching an inappropriate movie, follow the steps below:

1. Run the *InterVideo WinDVD4*.
2. Right-click somewhere in the *InterVideo WinDVD4* window and click *Setup...* *Setup* dialog box will appear.
3. In *Preferences* tab, click *Set Password* button in *Parental Playback Control* section.
4. Type your password. See online help of *WinDVD* for more details.

2

Displaying Video on TV Set

You can connect a television set with S-Video input to your computer and enjoy DVD video on a big display.



- Before connecting the television set, disconnect the external monitor.
- Connect the television set to your computer directly. Otherwise, the screen may be distorted.

Connecting TV Set

1. Turn off your computer and the television set.
2. Connect the television set to your computer.

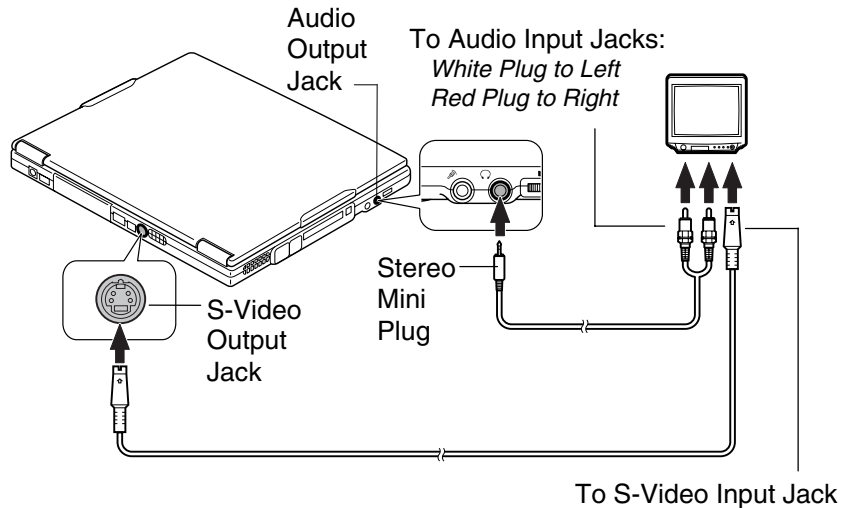

3. Turn on the television set, then, your computer.

4. Click *start – Control Panel – Appearance and Themes* in Category view.
5. Click *Change the screen resolution* string.
6. Set the *Screen resolution* to *800 by 600 pixels* and set the *Color quality* back to *Medium (16 bit)*.



Make sure to set the Screen resolution to 800 by 600 pixels and the Color quality to Medium (16 bit) when you display the image on TV. Otherwise, the image cannot be displayed properly.



7. Click *Advanced* button and select *S3Display* tab.
8. Check the box of *TV* and click *OK* twice.
9. If you can see the screen image on the television set, click *Yes*.
10. Click *OK* and close the *Display Properties* dialog box.

Disconnecting TV Set

1. Turn off your computer and the television set.
2. Disconnect the television set from your computer.

- *Before disconnecting the television set, be sure to turn off your*



computer and the television set.

- *After disconnecting the television set, set back the display property. (Refer to Adjusting Display later in this chapter.)*

Enjoying Dolby Digital Audio

Your computer is Dolby Digital compliant. With Dolby Digital compliant audio equipment or headphones, you will have an audio output similar to a big theater. Follow the steps below. (Refer to *Audio System* of Chapter 4 for connection.)

1. In *Setup* dialog box, click *Audio* tab. (Refer to the steps in *Using Parental Control* section to open the *Setup* dialog box.)
2. Select *Digital (S/PDIF) out to External Processor*, then, click *OK*.



WinDVD allows you to enjoy virtual surround sound through your speakers or headphones. To enable this function, follow the steps on the next page.

When you listen to the movie through speakers:

1. *Connect your speakers to your computer and click the subpanel*

button (⏮) and Audio Mode.



2. Select Speakers from the Listen on pull-down menu.
3. Click OFF button to enable this function. It turns ON.

When you use headphones:

1. Connect your headphones to your computer and click the subpanel button (⏮) and Audio Mode.
2. Select Headphones from the Listen on pull-down menu.
3. Click OFF button to enable this function. It turns ON.

Refer to the online help of WinDVD for more information.

2

Controlling Volume

You can adjust the output volume of your computer with one of the following volume controls that interact with each other.

With Volume Control

Turn the volume control on the left side of your computer backward you to increase the volume. Turn it toward you to decrease the volume.

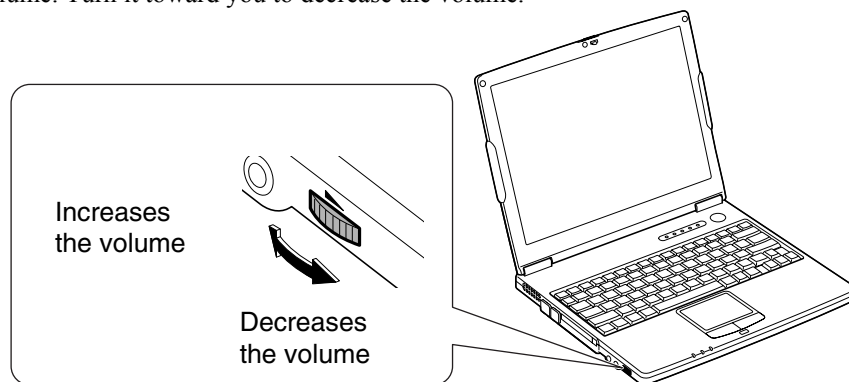

On Windows

1. Click *start – Control Panel*.
2. Click *Sounds, Speech, and Audio Devices*; then, *Sounds and Audio Devices*. If Classic view is selected, double-click *Sounds and Audio Devices* icon.
3. In *Sounds and Audio Devices Properties* dialog box, slide the lever to adjust the output volume.
4. Click *OK* and close the dialog box, then the *Control Panel* window.



You can also easily adjust the volume in the window that will open when clicking the speaker symbol on the taskbar. When the symbol is not on the taskbar, check the box of Place volume icon in the taskbar in the step 3.

If you want to control the output volume of each source individually:

1. Click *start – Control Panel*.
2. Click *Sounds, Speech, and Audio Devices*, then, *Sounds and Audio Devices*. If Classic view is selected, double-click *Sounds and Audio Devices* icon.
3. In *Sounds and Audio Devices Properties* dialog box, click *Advanced of Device volume* field.
4. Slide the lever of the source that you want to adjust.
5. Close the dialog box, then; click *OK* and close the *Control Panel* window.

If you control:

- | | | |
|-----------------|---|---|
| Wave | → | Controlling the volume of CD/DVD or WAVE file |
| SW Synth | → | Controlling the volume of MIDI file |

Adjusting Display

You can adjust the brightness, resolution, and number of colors of the internal LCD display for more comfortable viewing.

Changing Brightness of Display

Press and hold **F_n** key and then press **F6** () key to decrease the brightness of the internal LCD display.

Press and hold **F_n** key and then press **F7** () key to increase the brightness of the internal LCD display.

Changing Resolution and Number of Colors

When shipped, your computer is set to the default resolution and color. The default resolution is 1024 x 768 at 64K colors. To change the resolution and the number of colors, follow the instructions below:

1. Right-click anywhere on the Windows desktop except icons or folders.
2. Select *Properties* from the pop-up menu.
3. In the *Display Properties* dialog box, select *Settings* tab.
4. Select the number of the colors in the *Color quality*, and select the resolution in *Screen resolution*. Refer to the table below for possible resolutions and colors.
5. Click *OK*; then, *Yes*.

2

Available Resolutions and Colors

Resolution	Number of Colors
800 x 600	64K, 16M ^(*2)
1024 x 768	64K, 16M ^(*2)
1280 x 1024 ^(*1)	64K, 16M
1600 x 1200 ^(*1)	64K, 16M

(*1) Can be chosen for an external monitor only when it is capable of the listed resolution modes. Cannot be set when displaying on the LCD monitor only or on both of the LCD and the external monitor simultaneously.

(*2) On the internal LCD screen, the number of colors in this mode is made using a dithering algorithm.



- You cannot switch to a display resolution and number of colors that are not available.
- In the Color Quality, Medium (16 bit) means 65,536 (64K) colors and Highest (32 bit) means about 16,770,000 (16M) colors.
- If you select Highest:
 - Drawing speed may be delayed.
 - When playing animation, the screen may be distorted.

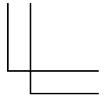
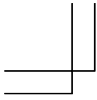

Changing Wallpaper and Setting Screen Saver

You can enjoy various desktop patterns or screen savers.

Changing Wallpaper

1. In the *Display Properties* dialog box, select *Desktop* tab.
2. Select appropriate wallpaper listed in *Background* field.
3. Click *OK*.



Setting Screen Saver

1. In the *Display Properties* dialog box, select *Screen Saver* tab.
2. Select an appropriate screen saver from the pull-down menu in *Screen saver* field and set time when screen saver starts.
3. Click *OK*.



To disable the screen saver, select [None] from the Screen saver pull-down menu.

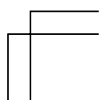
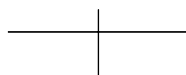
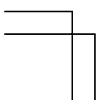
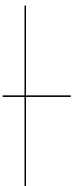
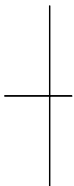

Sharing Your Computer

If you are sharing your computer with your colleagues or family members, set a user account for each person. Every user can choose his/her favorite desktop setting, web site lists, or make his/her own *My Documents* folder etc., and save them to his/her user account. When you turn on your computer, select your user account.

Set New User Account

1. Click *start – Control Panel*.
2. Click *User Accounts*. If Classic view is selected, double-click *User Accounts* icon.
3. Click *Create a new account* string.
4. Type a name for the new account and click *Next*.
5. Select the account type; then, click *Create Account*. If you have selected a *Limited account*, then that user account has limits for using your computer. See *Help and Support Center* in *start* menu for more details.
6. Close the *User Accounts* dialog box; then, the *Control Panel* window.

If more than one user accounts are set to your computer, you must select which user account you will log in when you turn on your computer.

Log off Your Computer

“Log off” is useful because you do not have to turn off your computer when you finish your task and pass your computer to another person. There are two ways to log off your computer, *Switch User* and *Log Off*.

If you select *Switch User*, you can pass your computer to another person without closing your current applications. For example, if you are viewing a Web site, and your colleague needs to open a program on your computer, use *Switch User*. You can then view the same Web site by just switching users after your colleague finishes with your computer.

If you select *Log Off*, the system will close all your session and you need to save your files before logging off your computer.

1. Click *start – Log Off*.
2. Select *Switch User* or *Log Off*. If you select *Log Off*, the dialog box that asks you to save your data may appear.
3. Select another account to start Windows again.



If you cannot see Switch User in Log Off Windows dialog box, click Change the way users log on or off string in User Accounts dialog box, and check Use Fast User Switching and click Apply Options.

2

Set Password to User Account

You can set a password to each user account to avoid unauthorized use of your computer. Once you set the password, you need to enter it when you log on to its account. If the entered password is not correct, you cannot start your computer with that user account, so unnecessary password setting can cause trouble in starting the system.

Setting Password

1. Click *start – Control Panel*.
2. Click *User Accounts*. If Classic view is selected, double-click *User Accounts* icon.
3. Select the account you want to set a password to. You will only have this option if you log onto your computer as a member of the Computer administrators group. If you log on your computer with a limited user account, go to the next step. (You cannot set a password to another user account.)
4. Select *Create a password* string.



- *If the password has been already set, Create a password will not appear.*
- *Only the members of the Computer administrators group can set a password to another user account.*

5. Type a new password.
6. Type the new password again to confirm it.
7. If necessary, type a password hints word to remember the password you set.
8. Click *Create Password*.
9. If you are asked whether you want to make your files and folders private, click *Yes, Make Private* or *No*. If not, go to the next step.
10. Close the *User Accounts* dialog box; then, the *Control Panel* window.

Changing Password

1. Follow the steps 1-2 on *Setting Password* section.
2. Select the account you want to change, if you log on to your computer as a member of the Computer administrators group. If you log on your computer with a limited account, go to the next step. (You cannot change the password of another user account.)
3. Select *Change the password* string or *Change my password* string.



- *If the password has not been set yet, Change the password or Change my password will not appear.*
- *Only the members of the Computer administrators group can change the password of another user account.*

4. Type the current password. If you are changing another user's password, skip this step.
5. Type a new password.
6. Type the new password again to confirm it.
7. If necessary, type a password hints word to remember the password you set.
8. Click *Change Password*.
9. If you are asked whether you want to make your files and folders private, click *Yes*,
10. Close the *User Accounts* dialog box; then, the *Control Panel* window.

Deleting Password

1. Follow the steps 1-2 on *Setting Password* section.
2. Select the account you want to delete its password, if you log on to your computer as the members of the Computer administrators group. If you log on your computer with a limited account, go to the next step. (You cannot delete the password of another user account.)
3. Select *Remove the password* string or *Remove my password* string.



- *If the password has not been set yet, Remove the password or Remove my password will not appear.*
- *Only a member of the Computer administrators group can delete the password of another user account.*



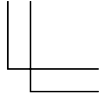
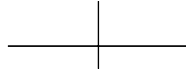
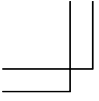

4. Type your password and click *Remove Password*. If you log on to your computer as a member of the Computer administrators group and want to delete the password of another user account, just click *Remove Password*.
5. Close the *User Accounts* dialog box; then, the *Control Panel* window.

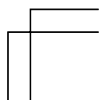
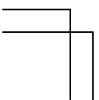
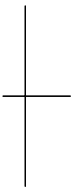
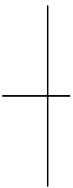

CHAPTER 3

Battery and Power Management

This chapter explains how to manage your computer's power effectively and use the battery pack.



In this section, you often see the expression “Power Options Properties dialog box”. To open the dialog box:

1. Click start – Control Panel.
2. Click Performance and Maintenance – Power Options *in Category view or double-click Power Options icon in Classic view.*

3

Battery Pack

When not connected to an external power source, your computer operates with the rechargeable battery pack. The duration of the battery life may be longer if your computer's power management is active. See the next section for power management.

To keep the battery life long:

- Condition the battery pack if the actual remaining power in your battery is less than what Windows *Power Meter* indicates. (See *Conditioning Battery Pack* section in this chapter.)
- Turn off your computer when you are not using it.



- *The duration of the battery will depend on your computer usage. Using applications, which heavily use the optical drive or external peripherals, will result in shorter battery life.*
- *When using your computer for several hours with battery packs, enable power management and set System hibernate. Refer to the Power Management section in this chapter.*
- *When the battery has not been charged, your computer may not operate properly. Connect your computer to the AC power source for the battery changing.*

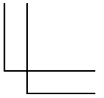

Charging Battery Pack

1. Connect the AC adapter to your computer. While the battery is being charged, the battery indicator lights orange.
2. When the battery is fully charged, the battery indicator turns green. Charging time may vary according to the status of your computer.



- *The battery indicator may turn off even while the battery pack is being charged. This is because the battery pack is hot, and the charging stops temporarily. When the battery becomes cool, the charging will start and the battery indicator will turn on again.*
- *The battery pack may not be installed correctly if the battery indicator blinks orange. In this case, turn off your computer, remove the AC adapter and the battery pack; then, install the battery pack and connect the AC adapter again. If the battery indicator still blinks orange, ask your local dealer for assistance.*
- *When the battery pack is hot (for example, after a long usage), it may take longer to be fully charged.*

3

Checking Battery Level

You can check the battery level by placing the pointer on the battery icon (🔋: powered on battery) or AC plug icon (🔌: powered on AC power and charging the battery pack) on the taskbar, or double-clicking one of these icons (🔋, 🔌 or 🔌: powered on AC power) to open the *Power Meter* dialog box. If the battery is fully charged, remaining capacity level will not appear even if you point to the icon.

If you cannot see the battery or AC plug icon, follow these instructions:

1. In the *Power Options Properties* dialog box, select *Advanced* tab.
2. Check *Always show icon on the taskbar* and click *OK*.
3. Close the *Control Panel* window.



- *The remaining operating time depends on the power you are consuming. If you are using the audio system, PC card slot, hard disk drive, media cards, peripherals or optical drive, your computer may consume more battery life.*
- *If the actual remaining power in your battery is less than what Power Meter indicates, you should condition the battery pack as per the procedure on Conditioning Battery Pack section in this chapter.*

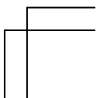

Low Battery Indication

When the battery power becomes significantly low, the battery indicator (🔋) blinks red and the warning beep sounds. Save your data and turn off your computer, or connect your computer to AC power source immediately. Otherwise, your computer will be shut down and the unsaved data may be lost.

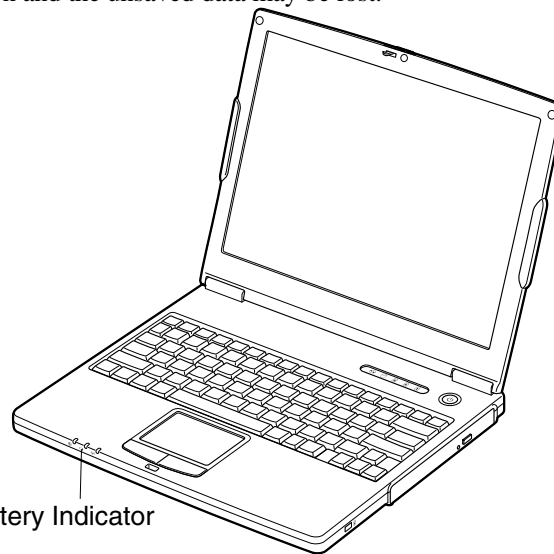

Battery Indicator

On Windows, a beep sound or an on-screen message will tell you when the battery drops to the specified level and your computer will go on *System standby/System hibernate* or shut down automatically.

To set Windows battery alarm:

1. In the *Power Options Properties* dialog box, select *Alarms* tab.
2. Set the battery level at which the alarms are activated. We recommend you set *Critical battery alarm* to 5 % or more and *Low battery alarm* to more than the value of *Critical battery alarm*.
3. Set the *Alarm Action...* to the appropriate settings.
4. Click *OK* twice.
5. Close the *Control Panel* window.





Conditioning Battery Pack

When the actual remaining power in your battery is less than what Windows Power Meter indicates, you need to condition the battery pack or buy a new one.

1. Make sure your computer is powered off. Connect your computer to AC power and fully charge the battery. The battery indicator turns orange first; then, green when the battery pack is fully charged.



When the battery is fully charged, the battery indicator turns green.

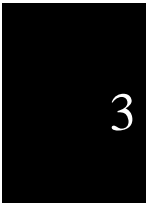

2. Turn on your computer.
3. When the message *Press <F2> to enter SETUP* appears, press **F2** to open the Setup Utility.
4. Disconnect the AC adapter, and leave your computer on until the battery is completely discharged and the system shuts down automatically.
5. Connect your computer to AC power and let the battery fully charged again.



-
- *Do not turn on your computer while charging the battery pack.*
 - *Do not connect your computer to a wall outlet while discharging the battery. The conditioning will be cancelled.*



Repeated charging and discharging or long-term storage of the battery pack cause battery deterioration. In this case, replace the battery pack with a new one.

Changing Battery Pack

When repeatedly charged and discharged the battery pack or stored for a long term, it will deteriorate (the deterioration rate depends on the operating environment). The battery deterioration will result in declining its capacity and power. If the battery life becomes extremely short even after the conditioning, you should buy a new battery pack. Ask your local dealer for a new battery pack.

When you replace the battery pack with a new one:

1. Turn off your computer and disconnect the AC adapter from your computer.
2. Close the display cover and turn your computer over on a stable surface.



3. Unlock the battery stopper of your computer to the left and hold it; then, unlock the battery release lever of the battery pack to the left and hold it; then, pull out the battery pack.

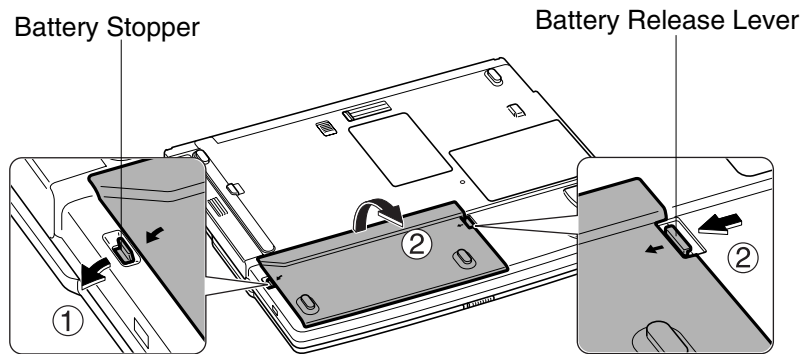

3

4. Insert a new battery pack into your computer by matching the projected parts of the battery with the notched parts on your computer.

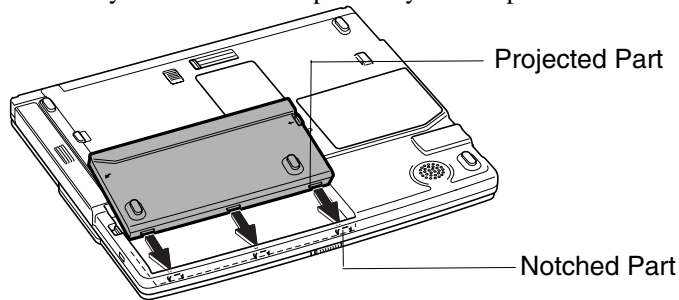

5. Press down the battery pack until you hear the clicking sound.

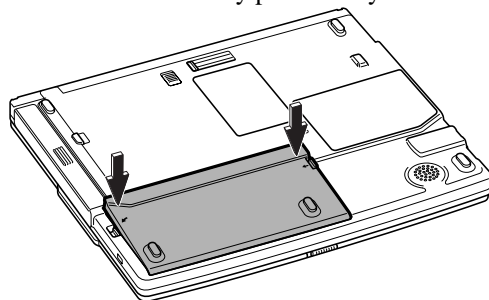

6. Turn your computer over.

Optional Add-on Battery Pack

The optional add-on battery pack (CE-BL30) allows you to operate your computer for extended period.

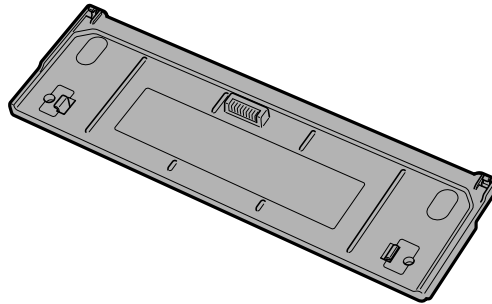

3



Never attach any add-on batteries but the optional ones (CE-BL30).

Attaching Add-on Battery Pack

Follow the steps below:

1. Turn off your computer and disconnect the AC adapter from your computer.
2. Close the display cover and turn over your computer on a flat place.
3. Open the cover of the add-on battery pack socket on the bottom of your computer.

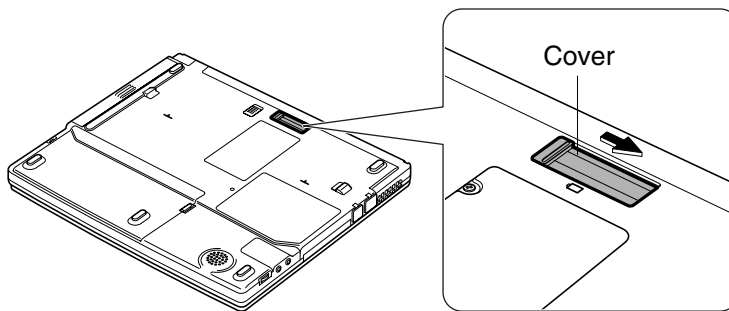

4. Hook the projected parts of the battery pack up to the notched parts of your computer.

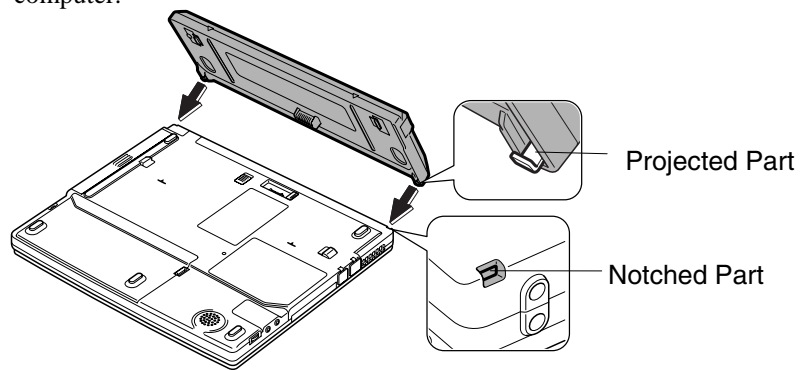

5. Softly press down the battery pack.

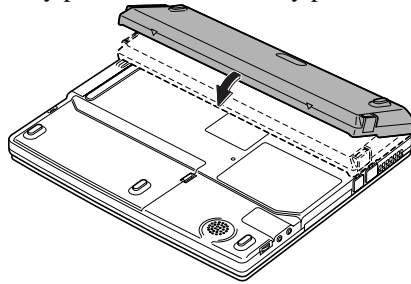

6. Slightly press the two levers of the battery pack inwards and hold them; then, press down the battery pack and release the levers.

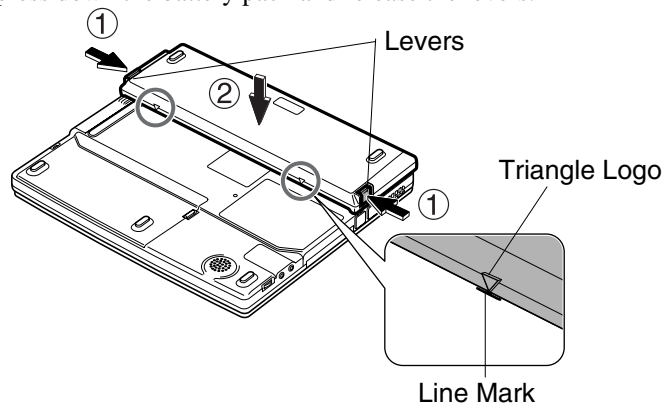

Make sure the triangle logos on the battery pack go with the line marks of your computer.

3

Removing Add-on Battery Pack

Follow the steps below:

1. Turn off your computer and disconnect the AC adapter from your computer.
2. Close the display cover and turn over your computer on a stable surface.
3. Slightly press the two levers of the battery pack inwards and hold them.

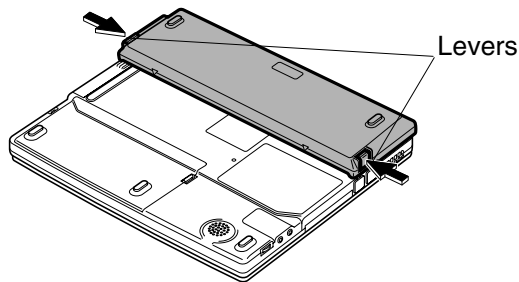

3

4. Slightly lift up the front of the battery pack and release the levers.

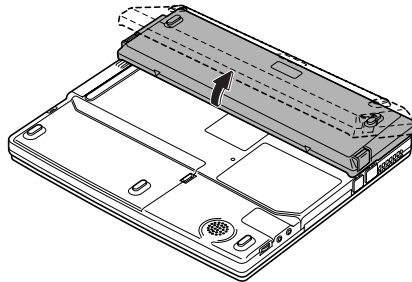

Make sure to lift up the battery pack softly and slightly. Lifting it up with excessive force may damage the projections of the battery.

5. Push out the battery backward and remove it.

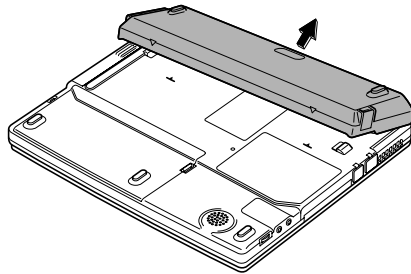

6. Close the cover on the bottom of your computer.

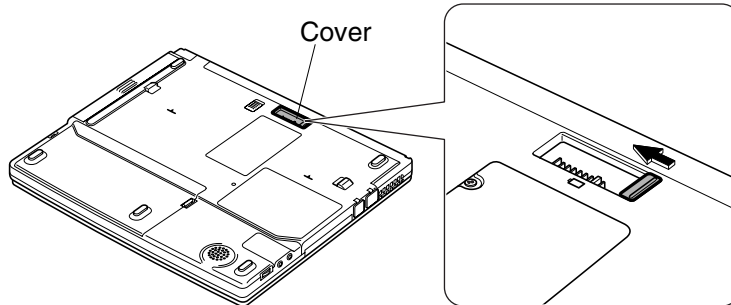

Be sure to close the cover when the add-on battery pack is not attached. Otherwise some objects may damage inside your computer.

3

Checking Battery Level of Add-on Battery

You can check the add-on battery level with one of the following ways.

On Windows

Refer to *Checking Battery Level* section in this chapter.

With battery level lamp

When you press the battery level button, the battery level lamps light up.

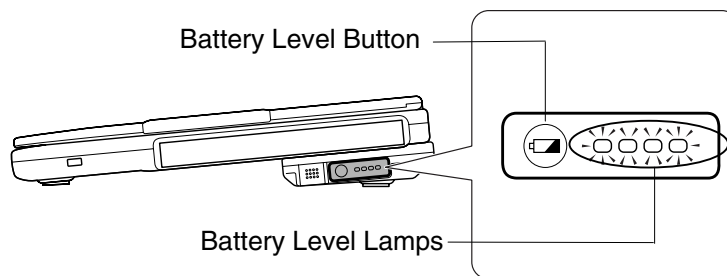

Conditioning Add-on Battery Pack

1. Connect the add-on battery pack.
2. Refer to *Conditioning Battery Pack* in this chapter.

Power Management

Power management saves electricity and extends battery life by controlling power supply to built-in devices. You can set the following power management properties on Windows.

- Stopping power supply to the hard disk
- Stopping power supply to the display
- Controlling CPU speed
- Using System standby/hibernate

To open *Power Options Properties* dialog box, click *start – Control Panel*, and click *Performance and Maintenance*; then, *Power Options*. If Classic view is selected, double-click *Power Options* icon.



Note that the power management may not seem to function when you are using an application program that accesses the hard disk periodically.

3

Stopping Power Supply to Hard Disk

1. In *Power Options Properties* dialog box, select *Power Schemes* tab.
2. Set *Turn off hard disks* to an appropriate value, and click *OK*.
3. Close the *Control Panel* window.

Stopping Power Supply to Display



This procedure is also effective for an attached external monitor complying with power management.

1. In *Power Options* dialog box, select *Power Schemes* tab.
2. Set *Turn off monitor* to an appropriate value, and click *OK*.
3. Close the *Control Panel* window.

Controlling CPU Speed

Windows XP controls the processor performance to reduce power consumption.



Do not control the processor performance, or connect/disconnect the AC adapter while communicating, or reading/writing data. Otherwise your computer may malfunction.

1. In the *Power Options Properties* dialog box, select *Power Schemes* tab.
2. Select an appropriate power scheme from the pull-down menu in *Power schemes* field according to the table below, and click *OK*.
3. Close the *Power Options Properties* dialog box, then the *Control Panel* window.

Power Scheme	Processor Performance	
Home/Office Desk	Using AC Power	Always runs at highest performance state
	Using Battery	Performance state will be chosen based on CPU demand
Portable/Laptop	Using AC Power	Performance state will be chosen based on CPU demand
	Using Battery	Performance state will be chosen based on CPU demand
Presentation	Using AC Power	Performance state will be chosen based on CPU demand
	Using Battery	Always runs at the lowest performance state
Always On	Using AC Power	Always runs at highest performance state
	Using Battery	Always runs at highest performance state
Minimal Power Management	Using AC Power	Performance state will be chosen based on CPU demand
	Using Battery	Performance state will be chosen based on CPU demand
Max Battery	Using AC Power	Performance state will be chosen based on CPU demand
	Using Battery	Always runs at the lowest performance state

3



- *Note that Power schemes includes other power management settings (such as a timer for System standby, etc.) appearing on Power Schemes tab. Confirm those settings are set to an appropriate value when you select the processor performance using power schemes facility.*
- *You can set your own Power scheme. Set all power management settings to your suitable ones, and click Save as...; then, type an appropriate name and click OK.*
- *Once the preinstalled Power scheme settings listed on the previous page are deleted, there is no way but re-installation to resume them.*

3

Using System Standby/Hibernate

System standby/hibernate is a very useful power management tool. For example, you can restart your computer from stand by mode more quickly than shut down mode. When your computer resumes from *System standby/hibernate*, the system restores the exact last state of your computer. On Windows, you can set the conditions under which the system enters *System standby* or *System hibernate*.

- *System standby* stores the current condition of your computer in RAM and stops power supply to all but a few essential components. Your system enters and resumes from *System standby* per the conditions mentioned later. In *System standby*, the power indicator blinks green. To resume from *System standby*, operate your computer again.
- *System hibernate* saves the current condition of your computer in part of the hard disk and turns off your computer. Your system enters and resumes from *System hibernate* per the conditions mentioned later. In *System hibernate*, the power indicator turns off. To resume from a *System hibernate*, press the power button.



When entering/resuming from System standby/System hibernate, follow the instructions below:

- *Finish communications, printing, and playing music or video before entering System standby/System hibernate.*
- *Do not operate your computer or peripheral devices, or connect/disconnect peripheral devices, while entering/resuming from System standby/System hibernate.*
- *While operating on battery power that does not have enough power, your computer may not resume from System standby/hibernate. In this case, connect the AC adapter to your computer.*
- *Save the data before your computer enters System standby. If the power supply to your computer is stopped, the RAM contents will be lost.*
- *Select your user account if Windows requires when your computer has resumed from System standby/hibernate.*

Supporting System Hibernate



If your battery becomes completely discharged during System standby, you will lose unsaved data and will need to reboot your computer. Therefore, if you are planning to leave your computer powered by battery for long periods of time, we recommend System hibernate.

Confirm that *System hibernate* is supported with the following steps.

1. In the *Power Options Properties* dialog box, select *Hibernate* tab.
2. Confirm *Enable hibernation* is checked in *Hibernate* field.
3. Click *OK*, then, close the *Control Panel* window.

Set Timer to Enter System Standby/Hibernate Automatically

Your computer will enter *System standby/hibernate* automatically when the specified time has passed without any operation. To set the time:

1. In the *Power Options Properties* dialog box, select *Power Schemes* tab.
2. From the pull-down menus in *System standby* or/and *System hibernate*, select the elapsed time before your computer automatically enters System standby/hibernate.
3. Click *OK*, then, close the *Control Panel* window.

Entering System Standby/Hibernate

Your computer enters *System standby/hibernate* in each of the following cases:

- You select Stand By or Hibernate (which replaces *Stand By* when you press **Shift** key) in *Turn off computer* dialog box. To open the dialog box, click *start – Turn Off Computer*.
- The specified time in *System standby* or *System hibernate* in *Power Schemes* tab of *Power Options Properties* dialog box has passed without any operation (See the previous section).
- The screen cover is closed.

The above functions if you perform the following:

1. In the *Power Options Properties* dialog box, select *Advanced* tab.
2. Select *Stand by* or *Hibernate* in *When I close the lid of my portable computer*.
3. Click *OK*, then, close the *Control Panel* window.



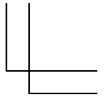
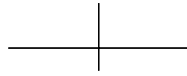
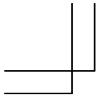

- You press the power button.

The above functions if you perform the following:

1. In the *Power Options Properties* dialog box, select *Advanced* tab.
2. Select *Hibernate* or *Stand by* in *When I press the power button on my computer*.
3. Click *OK*, then, close the *Control Panel* window.

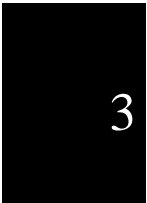



- You press **Fn + F12** () .

The above functions if you perform the following:

1. In the *Power Options Properties* dialog box, select *Advanced* tab.
2. Select *Hibernate* or *Stand by* in *When I press the sleep button on my computer*.
3. Click *OK*, then, close the *Control Panel* window.



*If Ask me what to do is selected in the step 2 of You press the power button or You press **Fn+F12** () , the Turn off computer dialog box will appear when you press the power button or **Fn+F12** () key combination. You can select System standby or System hibernate at that timing.*

- The battery level is low.

The above functions if you set the alarm in Windows. See *Low Battery Indication* earlier in this chapter.

Disabling Power Management

1. In the *Power Options Properties* dialog box, select *Power Schemes* tab.
2. Set *Turn off monitor*, *Turn off hard disks*, *System stand by*, and *System hibernate* to *Never*, and click *OK*.
3. Close the *Control Panel* window.

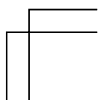
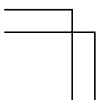

CHAPTER 4

Peripherals

This chapter describes how to use peripheral devices with your computer. You can connect a floppy disk drive unit, a printer, an external monitor, an IEEE1394 device, or other devices to your computer. To ensure proper use, be sure to read the instructions for each peripheral device before connecting it to your computer.

4

Using Peripherals

You can use the peripheral devices shown on the next page. For the details, refer to the section explaining each device, or contact your dealer.



- *Be sure to turn off your computer and the peripheral devices before connecting them (except when connecting/inserting USB devices, an IEEE1394 device, a PC card, etc.).*
- *Confirm the peripheral device you will connect is Windows XP compatible.*
- *When you connect some of the devices, you may have to turn on your computer before powering on the devices.*
- *Some devices require that you install their drivers before use. (You may need to connect an optional external floppy disk drive unit to install the drivers.)*

Peripheral Connection Overview

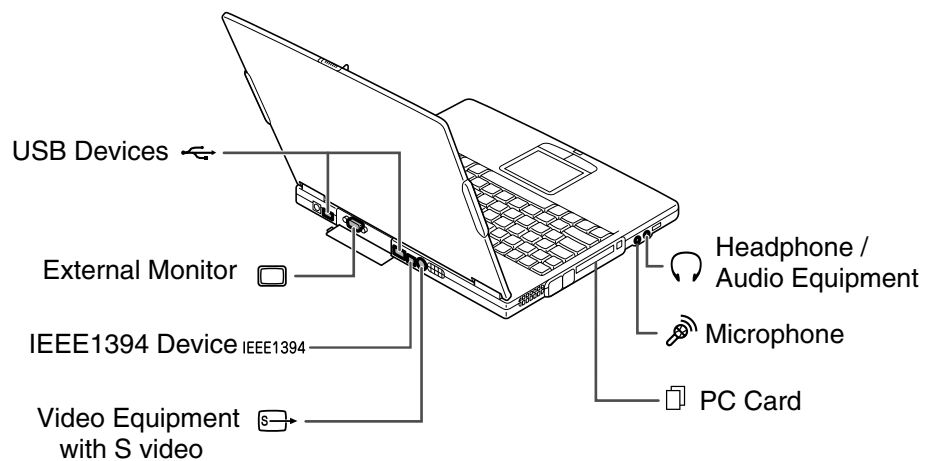

Optional External Floppy Disk Drive Unit

You can use double-density (2DD) 720KB or high-density (2HD) 1.44MB floppy disks with the provided external floppy disk drive unit (CE-FD05).

Connecting Optional External Floppy Disk Drive Unit



- Do not place the floppy disk drive unit on its side or upside down.
- Do not press on the floppy disk drive unit. It may damage the drive or cause malfunction.
- Do not place the AC adapter on the floppy disk drive unit. It may cause the drive to malfunction.

Connect the floppy disk drive unit cable to either of the USB ports on your computer. Be sure to let the USB mark side up when connecting the cable to your computer.

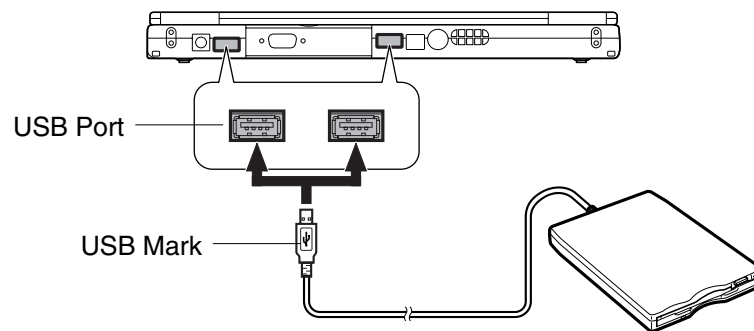

4

Handling Floppy Disk

- Do not open the shutter and touch the disk inside; otherwise, you will not be able to read or write data from/to the disk.
- Do not place floppy disks near magnets or heat source, in direct sunlight or in a dusty place, etc.
- Never subject a disk to sudden shocks or extreme vibration. Do not drop, bend, or place heavy objects on a disk.
- Do not spill liquid onto a disk.

Inserting a Floppy Disk

Hold the floppy disk with the arrow facing up and towards the drive. Slide the disk into the drive until it is locked into place.

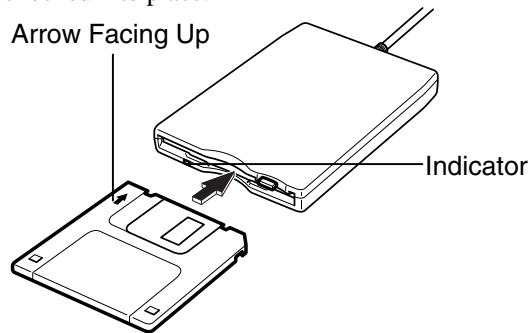

4



- Always insert a floppy disk straight into the floppy disk drive.
- When inserting the disk, make sure it is not upside down.
- Do not use excessive force when inserting the floppy disk. If you have difficulty inserting or removing disks, seek the assistance of an authorized service technician.
- Do not touch the disk while reading/writing data. It may cause malfunction of your computer and the drive.

Ejecting Floppy Disk



Before ejecting the floppy disk, make sure the indicator of the floppy disk drive unit is not lit.

Press the eject button firmly. The disk will pop out slightly. Remove it and store it properly.

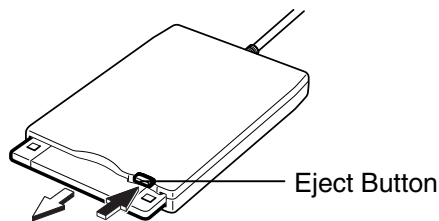

Formatting Floppy Disk



1. Make sure the floppy disk is not write-protected, and insert it into the floppy disk drive.
2. Click *start – My Computer*.
3. Right-click *3 1/2 Floppy (A:)* icon; then, click *Format...* from the pop-up menu.
4. Select the appropriate formatting options.
5. Click *Start* to start formatting.



- *When you format a floppy disk, all data previously stored on the disk is lost.*
 - *You cannot format a double-density (2DD) 720KB floppy.*
-

Removing External Floppy Disk Drive Unit

To remove the unit, you need to perform the following steps before you remove it:

1. Click *Safely Remove Hardware* icon () on the taskbar. If you cannot find the icon, click  to show all kinds of icons.
2. Click on *Safely Remove Mitsumi USB Floppy – Drive (A:)* string. *Safe To Remove Hardware* dialog appears.
3. Remove the unit from your computer.

4

External Display

You can use an external monitor with your computer. To display the same images on both displays simultaneously, use the 1024x768 resolution.



- *Some monitors, which are not compatible with your computer, may not display properly.*
- *In this section, you often see the expression “Display Properties dialog box.” To open the dialog box, right-click somewhere on the Windows desktop and select Properties from the pop-up menu.*
- *To display the image on an external monitor, you may need to install its driver. Before using the external monitor, refer to the manual included with it.*

Connecting External Monitor

1. Turn off your computer and the external monitor.
2. Open the cover on the rear side of your computer.

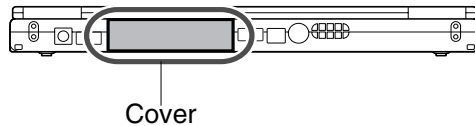

3. Connect one end of your external monitor cable to the external monitor port of the rear side of your computer and the other end to your external monitor.

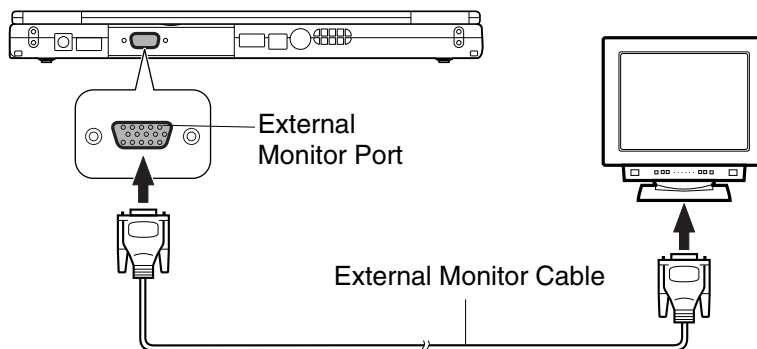

*Make sure to tighten the screw *S* of the cable if it has.*

4. Turn on the external monitor; then, your computer.

Disconnecting External Monitor

1. Turn off your computer and the external monitor.
2. Loosen the screws of the monitor cable if it has, and remove the cable from your computer and the monitor.

Displaying on External Monitor

To display the image on an external monitor, you may need to install the driver for the external monitor. Before using the external monitor, refer to the manual included with it.

Switching Display

1. In the *Display Properties* dialog box, select *Settings* tab; then, click *Advanced*.
2. Select *S3Display*.
3. Select the output display and click *OK* twice.
4. Click *Yes*, then, *OK*. Close the *Control Panel* window.



- You can also switch the display with **Fn+F5** ()
- While playing video or animation, you may not be able to switch the display.
- The external display should be capable of 1024x768 resolution or more when displaying simultaneously. Otherwise, it cannot display properly.

Audio System

You can output sound to speakers, audio equipment or a headphone and also input sound through a microphone.

4

Connecting Speakers

You can connect stereo speakers with an amplifier to the audio output jack on your computer.

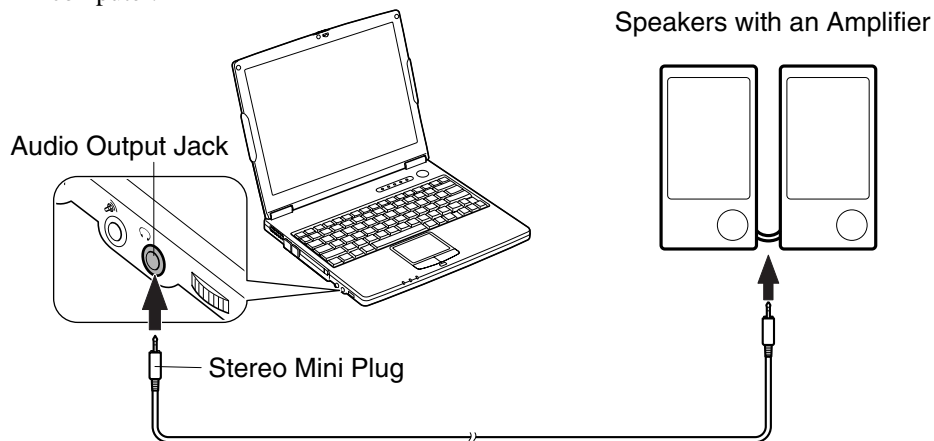

Connecting Digital Audio Equipment

The audio output jack of your computer is compliant to S/PDIF (Sony/Philips Digital Interface). You can connect S/PDIF compliant audio equipment to your computer and output/record sound.

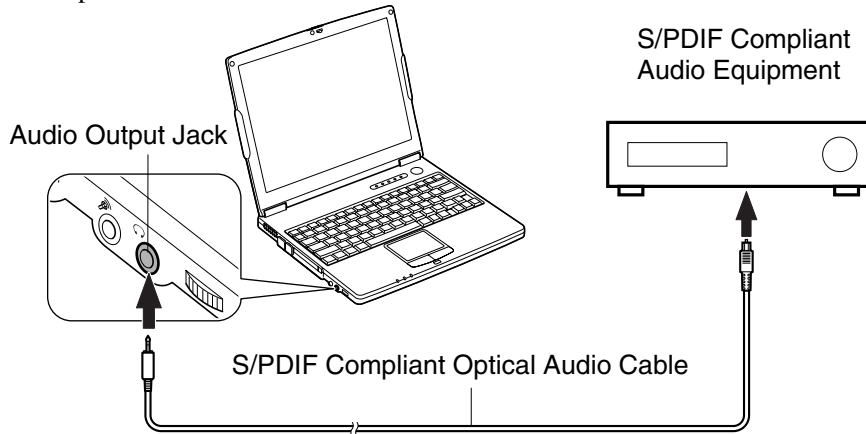

4



When recording sound with an audio equipment:

- *Use AC adapter for your computer and the digital audio equipment.*
- *Exit other application programs.*
- *Disable Windows power management.*
- *Do not enter System standby/ hibernate.*
- *Do not operate your computer.*
- *Use the digital audio equipment compliant with sampling rate of 48kHz.*
- *Sound may not be recorded correctly if you use the synchronized recording system of the digital audio equipment.*

Connecting Analog Audio Equipment

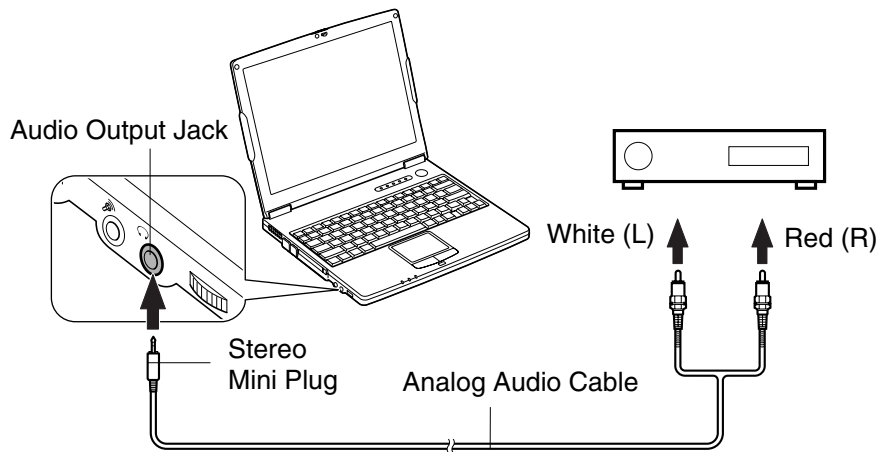

You can adjust the output volume on Windows by sliding the volume lever appearing when clicking the speaker icon on the taskbar.

4

Connecting Headphone

Use the headphone with an impedance of 8Ω or more. (32Ω is recommended).

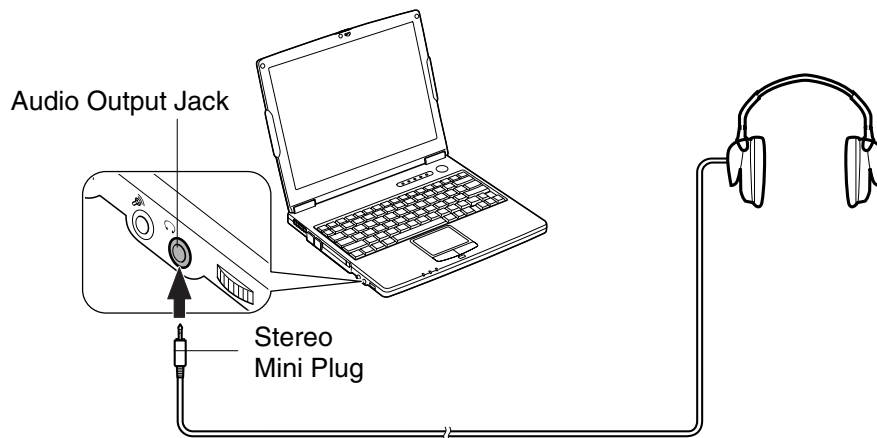

Connecting Microphone

You can input sound using an external microphone connected to the microphone jack. Use an electret condenser microphone with an impedance of $2.2k\Omega$ and an allowable voltage of 2V.

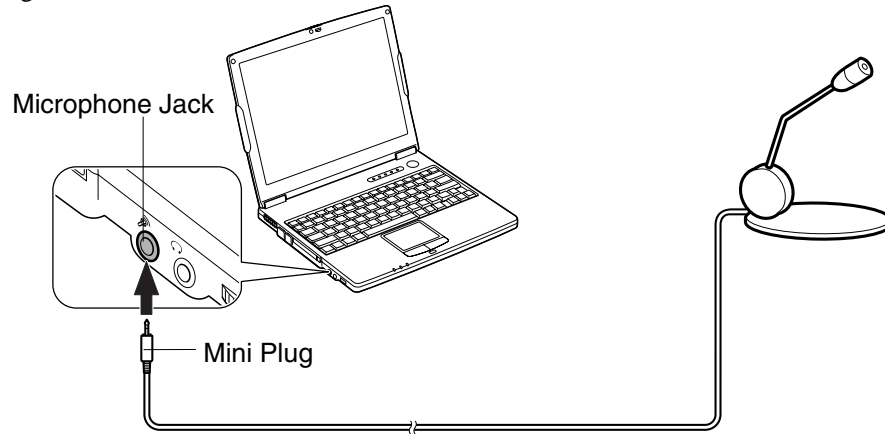

4

To record sound:

1. Click *start*; then, point *All Programs – Accessories – Entertainment*.
2. Click *Sound Recorder*.
3. See *Help for Sound Recorder* for more information.

USB Device

Your computer has an interface called Universal Serial Bus (USB) and its two USB ports support USB 1.1 and USB 2.0. With a USB connection, you can connect/disconnect peripherals to/from the ports without turning off your computer. Generally, when a device is connected to your computer, the necessary driver will be installed automatically. See also the manuals of peripheral devices supporting USB.



When a new device is correctly connected to your computer, the appropriate driver is automatically installed. If the driver is not installed correctly, a message will appear in the lower right of the screen. In this case, install the driver by following the instructions on the screen.

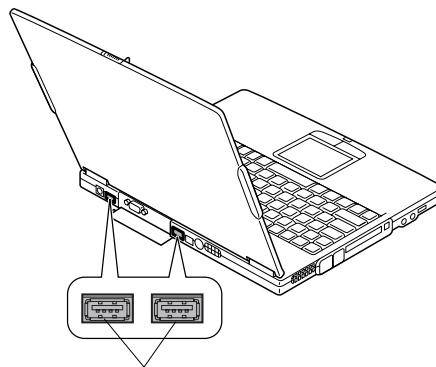

USB Ports

To remove USB devices, you may need to perform the following instructions before you remove them:

1. Click *Safely Remove Hardware* icon (🗑️) on the taskbar. If you cannot find the icon, click ⚙️ to show all kinds of icons. If the icon does not appear, go to Step 3.
2. Click on *Safely remove xxxxx* string (xxxxx is the name of your USB device). *Safe To Remove Hardware* dialog appears.
3. Remove the device from your computer.

PC Card

Your computer is equipped with a PC card slot, which can accommodate a Type II card or a CardBus compliant card. You can insert/eject a PC card without turning off your computer.

Inserting PC Card



When you insert a protruding PC card such as wireless networking card:

- Do not give force to the card.
- Do not store or carry your computer with the card inserted.



When a new card is correctly inserted, the appropriate driver is automatically installed. If not installed correctly, a message will appear on the lower right of the screen. In this case, install the PC card driver by following the instructions on the screen.

4

1. Confirm the PC card eject button is inside your computer cabinet. If not, push it back into the cabinet.

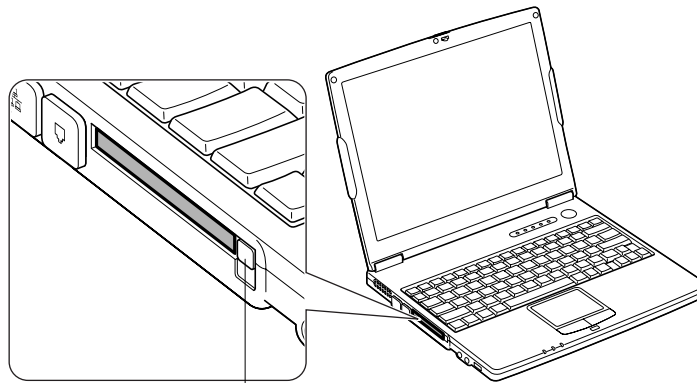

Eject Button

2. Insert a PC card into the slot with the label face up until it is locked into place.

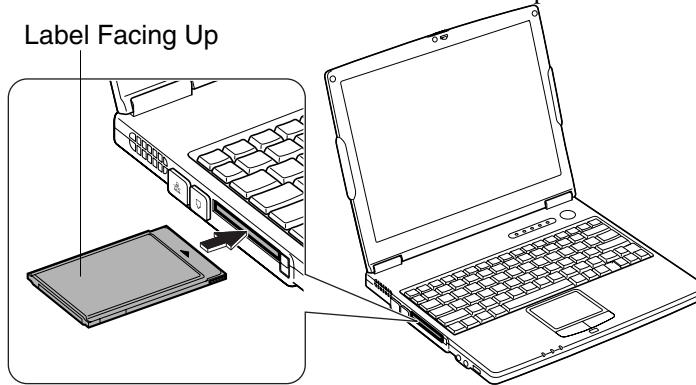



If the dialog box asking you *What do you want Windows to do?* appears, select the task you want.

4

Ejecting PC Card



- *Some PC cards may become hot after long use.*
- *Be sure to follow these instructions when ejecting a PC card. Otherwise, the system may not work properly.*

1. Click the *Safely Remove Hardware* icon () on the taskbar. If you cannot find the icon, click  to show all kinds of icons.
2. Click on *Safely remove xxxxx* string (xxxx is the name of your PC card.); then, *Safe To Remove Hardware* dialog appears.
3. Push the PC card eject button so that it will pop out from the side of your computer.

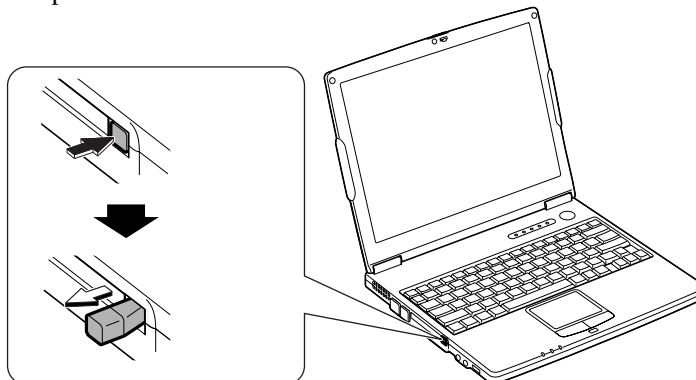

4. Push the eject button until the inserted PC card pops out, then, remove the card.

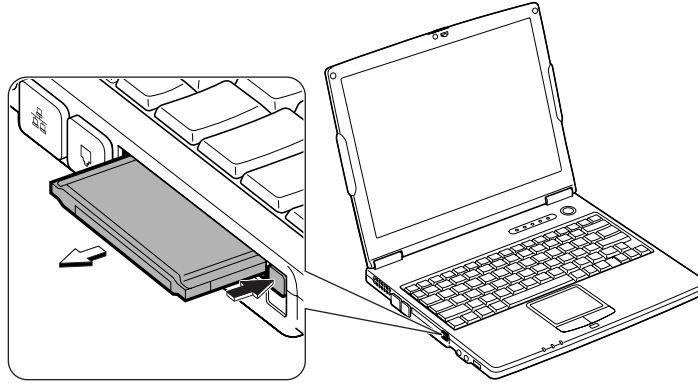

5. Confirm the eject button inside the cabinet. If not, push it back for safekeeping.

4

Printer

You can connect a USB printer to either of the USB ports.



- Before using a USB printer, read the printer manual and install the printer driver.
- Note that some printers may not use Found New Hardware Wizard to install the printer driver.
- You can connect the USB printer to your computer without turning off your computer.

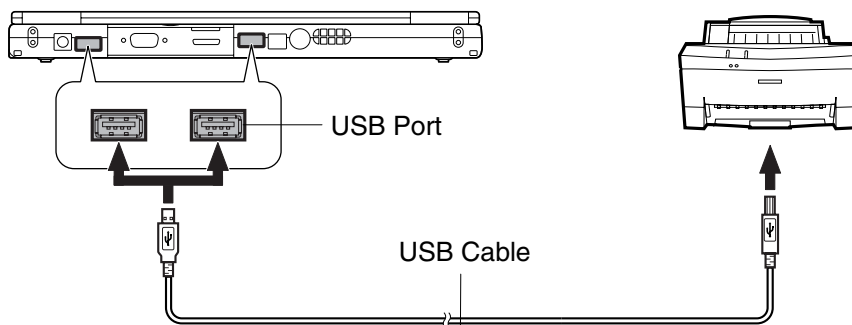

IEEE1394 Device

You can connect the IEEE1394 devices to the IEEE1394 port on the rear side of your computer. The IEEE1394 is digital interface for handling digital video, digital audio and other data in two directions between devices, and for controlling other equipment.

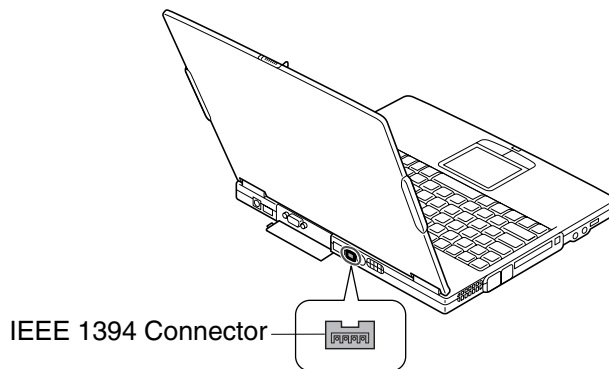

When two or more IEEE1394 compatible devices are connected to your computer in a daisy chain, operations and data transactions are possible with not only the equipment that is directly connected, but also with other devices via the directly connected device.



- *Confirm the IEEE1394 device you will connect is Windows XP compatible.*
- *Use AC power for your computer and the IEEE1394 device especially when reading/writing the data.*
- *Some IEEE1394 devices require that you install drivers before use.*

Connecting IEEE1394 Device



- *You need not turn off your computer before connecting the device.*
- *Be sure to read the manuals of the IEEE1394 device before connecting it to your computer.*

1. Connect one end of the DV cable with the IEEE1394 connector of your computer.

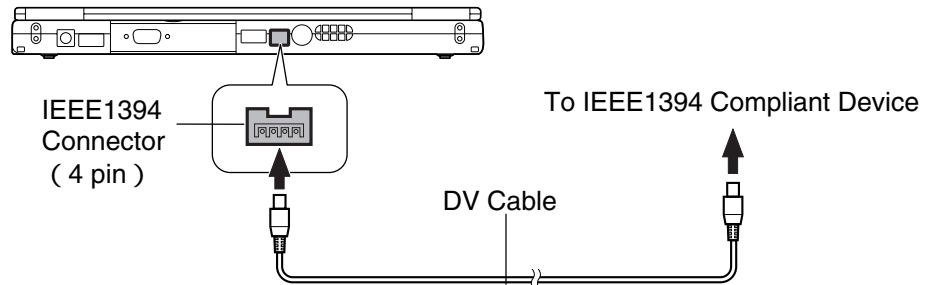

2. Connect the other end of the DV cable with the DV connector of the IEEE1394 device.



3. Install the driver according to the instructions on the screen. Generally when you connect the device to your computer, the necessary driver will be installed automatically.
4. Start the appropriate application for handling your data.

4

Disconnecting IEEE1394 Device

1. Click the *Safely Remove Hardware* icon () on the taskbar. If you cannot find the icon, click  to show all kinds of icon. If the icon does not appear, go to Step 3.
2. If the name of your device appears, click on *Safely remove xxxxx* string. (xxxxx is the name of your IEEE1394 device.); then, *Safe To Remove Hardware* dialog appears. If your IEEE1394 device name does not appear, skip this step.
3. Remove the DV cable from your computer.

CHAPTER 5

Communication Functions

This chapter explains how to use the built-in modem and the LAN unit.



- *When you use communications software:*
 - *Connect your computer to the AC power source.*
 - *Disable power management. (Refer to Disabling Power Management section of Chapter 3.)*
 - *See also the manual or online help of the software you are using.*
- *The communication speed may vary depending on the traffic, local telecommunications infrastructure, and ISP (Internet Service Provider) infrastructure.*

5

Built-in Modem

You can use the built-in modem for data transfer and fax communication.



- *The built-in modem on your computer is designed only for regular analog telephone lines. The modem may be damaged when connected to a digital ISDN terminal or a digital PBX.*
- *Use TA (terminal adapter) to connect the built-in modem to a digital telephone line.*
- *If an unusual device is attached to the line you are connecting to, the modem may not function properly. Remove the device or contact the dealer of the device.*
- *Before connecting to a PBX, consult the PBX maintenance staff or its service company. If the electric characteristics of your PBX are different from those of a regular analog line, the modem will not function properly. If you connect the modem to a digital PBX, both the modem and the PBX may be damaged.*



- *Within the communications software you are using, set the COM port of the built-in modem to COM 3 if required.*
 - *Before commencing with fax communication, it is recommended that you exit other application programs.*
-

Connecting Modem to Telephone Line

1. Turn off your computer.
2. Open the cover of the modem jack on the left side of your computer.

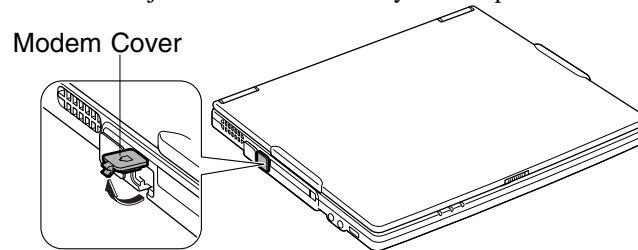

To avoid damaging the modem, close the modem cover after you finish using the built-in modem.

3. Connect one end of the included modem cable to the modem jack and the other to the telephone line.

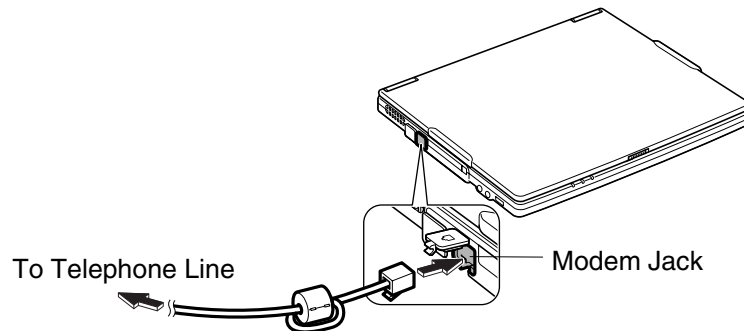

Be sure not to insert the modem cable into the LAN jack. It may damage the LAN jack and the modem cable.

4. Turn on your computer.



Connect the modem to the telephone line directly. Do not use a distributor or allotter.



Configuring Modem

You may have already configured your modem during Windows setup process. Otherwise, make the necessary adjustments as shown below.

Modem Configuration

When you use the modem first time, you must type your location's information.

1. Click *start – Control Panel – Printers and Other Hardware*; then, *Phone and Modem Options*. If Classic view is selected, double-click *Phone and Modem Options* icon.
2. In *Location Information* dialog box, select your country, type your area code, etc. and select your dial type; then, click *OK*.

After the configuration, click or double-click *Phone and Modem Options* (icon) to open *Phone and Modem Options* dialog box and double-click the location name in *Locations* field of *Dialing Rules* tab for the information you set above. Clicking *Edit...* or *New....allows you to* make a new location or change the settings.



Internet Connection

Windows XP has a special Internet connection wizard to help you to connect to the Internet with ease.

1. Click *start – Control Panel - Network and Internet Connections*; then, *Network Connections*. If Classic view is selected, double-click *Network Connections* icon.
2. In *Network Connections* dialog box, click *Create a new connection* of *Network Tasks* section. The *New Connection Wizard* dialog box appears.
3. Follow the instructions on the screen.

If you plan to connect into the Internet and dial an Internet Service Provider (ISP) through the modem, have your account information and dial-up number ready before you begin the wizard. Once you set your connection, you can see or edit the connection status by double-clicking the icon appearing on *Dial-up of Network Connections* dialog box.

LAN Unit

You can connect to a LAN (Local Area Network) with the 100 Base-TX/10 Base-T LAN unit on your computer. To activate the LAN unit, perform the following steps.



Never insert any cables, but a LAN cable, which have different electric characteristics from those of the LAN cable. Otherwise, the LAN unit and the cables may be damaged.



Use a category 3 or a category 5 LAN cable when connecting to 10 BASE-T LAN, and the category 5 when connecting to 100 BASE-TX LAN.

Connect Your Computer to LAN

1. Turn off your computer.
2. Attach the provided core to one end of your LAN cable. Insert the cable into the core and close the core until it clicks.

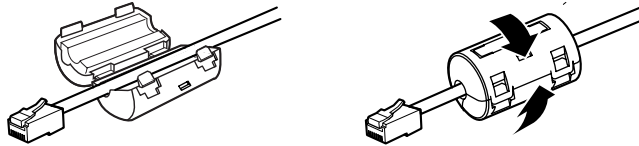

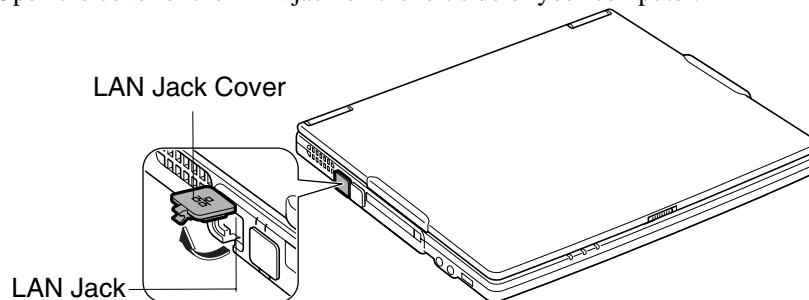

3. Open the cover of the LAN jack on the left side of your computer.

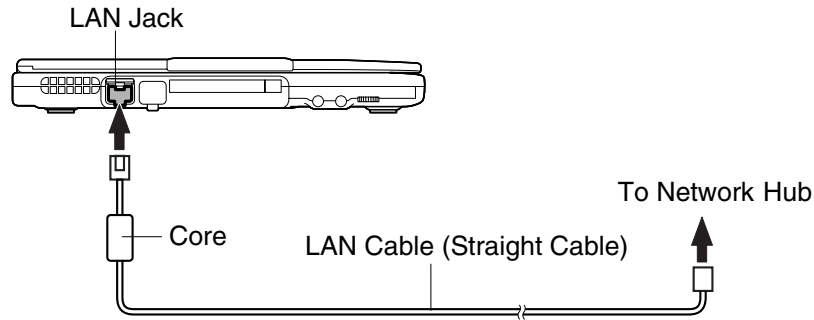

To avoid damaging the LAN unit, close the LAN jack cover after you finish using the LAN unit.

4. Connect the core end of the LAN cable to the LAN jack and the other end of the LAN cable to the network hub.



Do not insert into the modem jack (with  mark). It will damage the LAN cable and the modem jack.



You can also directly communicate with another computer using a cross LAN cable.

5. Turn on your computer.

Configuring LAN Unit

1. Click *start – Control Panel*.
2. Click *Network and Internet Connections*; then, *Network Connections*. If Classic view is selected, double-click *Network Connections* icon.
3. Right-click *Local Area Connection*.
4. From the pop-up menu, select *Properties*.
5. In the *Local Area Connection Properties* dialog box, set the network setting according to the instruction of your network administrator.



- *Attach the provided core to your LAN cable to insure compliance with requirements of EMC regulations for computing equipment.*
- *Make sure to log on your computer as a member of your Computer administrators group. Otherwise, you cannot set or change some settings for the LAN unit.*

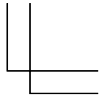
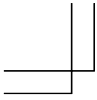

If you cannot access the network,

1. Click *start – Control Panel*.
2. Click *Performance and Maintenance*; then, *System*. If Classic view is selected, double-click *System* icon.
3. Click *Hardware* tab; then, *Device Manager* button.
4. Double-click on *Network Adapters* string, then, *Realtek RTL8139 xxxxx* string.
5. Click *Advanced* tab, and select *Link Speed/Duplex Mode* in *Property* list and select an appropriate value in *Value* pull-down menu.
6. Click *OK* and close the *Device Manager* window.
7. Click *OK* and close the *Control Panel* window.

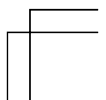
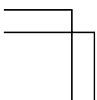
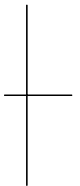

Wireless LAN

Your computer has an integrated wireless LAN function compliant with IEEE 802.11b standard. You can access the network by the wireless LAN.

There are two kinds of wireless networks: a network using an access point and a peer-to-peer wireless network. You can connect your computer to a wired LAN or the Internet through an access point that is also compliant with IEEE 802.11b standard. Peer-to-peer wireless network consists of a number of computers each equipped with wireless networking interface. Each computer can communicate directly with other wireless enabled computers.



The range to give reliable performance and the quality of connection vary depending on the environment where you perform.

To communicate through the wireless LAN, activate the integrated antennas with the following steps.

Activate Antennas

You can enable/disable the antennas by pressing **Fn +F1** key combination. When the antenna indicator (⌘) lights green, the antennas are enabled. When the indicator light is off, they are disabled.

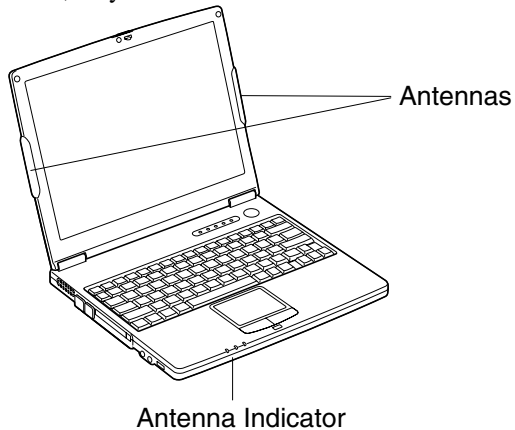

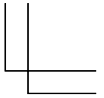

Connecting to the Internet via an Access Point

You can connect your computer to the Internet or a wired network via an access point supporting IEEE 802.11b. Refer to the manual of the access point or consult your network administrator if you are not sure.

Communicating with Other Computers



- *Confirm each computer is enabled for wireless LAN first.*
- *Make sure to log on the computer as a member of the Computer administrators group. Otherwise, you cannot set or change some settings for wireless LAN.*

1. Click *start – Control Panel*.
2. Click *Network and Internet Connections – Network Connections*. If Classic view is selected, double-click *Network Connections*.
3. Select *Wireless Network Connection*; then, click *Change settings of this connection* of *Network Tasks*.
4. Double-click on *Internet Protocol (TCP/IP)* string in *This connection uses the following items*.
5. In *Internet Protocol (TCP/IP) Properties* dialog box, select *Use the following IP address* and set a unique *IP address* to 192.168.1.2 through 192.168.1.254 and the *Subnet mask* to 255.255.255.0; then, click *OK*.



- *The IP address of each computer should be unique.*
- *The Default gateway can be blank.*

6. Click *Wireless Networks* tab; then, *Advanced* button in the lower right of the dialog box. *Advanced* dialog box appears.
7. Select *Computer-to-computer (ad hoc) networks only*; then, click *Close* button.
8. Click *Add...* button in *Preferred networks* section of *Wireless Network Connection Properties* dialog box.
9. Type a name of the network in *Network name (SSID)* field of *Wireless Network Properties* dialog box.



- *Confirm your computer and other computers are connecting to the same network.*

10. Click *OK* twice; then, close the *Control Panel* window.

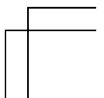
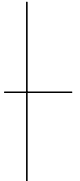



11. Configure the network by setting the name of your computer and workgroup.



To communicate with other wireless enabled computers, set the computer name and the workgroup name. The computer name should be unique and the workgroup name should be same as others.

Confirming the Status of the Wireless Connection

Before performing the following instructions, confirm the devices that you want to communicate with are enabled for wireless LAN.

1. Click *Wireless Network Connection* icon ( or ) on the taskbar. If you cannot find the icon click  to show all kinds of icon. *Connect to Wireless Network* dialog box appears. If *Wireless Network Connection Status* dialog box appears, go to Step 4.
2. Select a network you want to access in *Available networks* in *Connect to Wireless Network* dialog box; then, click *Connect* button.



*When the network name you want to access does not appear, click *Advanced tab*; then, *Refresh button* of *Available networks* in *Wireless Network Connection Properties dialog box*; then, click *OK*.*

3. Click *Wireless Network Connection* icon () on the taskbar.
4. In *Wireless Network Connection Status* dialog box, confirm your connection status.



- *The number of green signals () shows the connection. The more signals light on, the better quality is given to the computer.*
- *When the quality of connection is poor, adjust the distance between the computer and other devices or the access point you are communicating with and/or the facing direction of the computer.*

Connecting the WEP configured network

Wireless communication has security issues. Some networks are configured with WEP (Wired Equivalent Privacy) keys or encryption keys to protect the transmitted data. To connect into the network configured with WEP keys, follow the steps below.

1. Right-click *Wireless Network Connection* icon () on the taskbar and click *View Available Wireless Networks*.

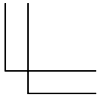

2. Select the network you want to connect from *Available networks* of *Connect to Wireless Network* dialog box.
3. Type the encryption key set to the network in *Network key* and click *Connect*.



- When you select a network that is not configured for encryption settings in the step 2, the *Network key* field is grayed and you do not have to enter the key characters.
- When the key index set to your computer is different from that of the network, you cannot access the network. Set the same key index with the following steps. Note that some access points have the key index options 0 through 3. Refer to the table below for matching.

1. Open the *Wireless Network Connection Properties* dialog box. (Refer to the steps in *Communicating with Other Computer* section.)
2. Select the network you want to access in *Preferred networks* section and click *Properties* button.
3. Confirm the box of *Data encryption (WEP enabled)* is checked, uncheck the box of *The key is provided for me automatically* and set the key index.



Key index compatibility table

Access Point 1	Access Point 2	Your Computer
1	0	1
2	1	2
3	2	3
4	3	4

(ex. When your access point type is "Access Point 2" and its key index is set to 0, set 1 to the key index of your computer.)

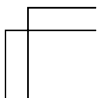
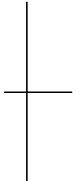

Network Setup Utility

With the Network Setup Utility, you can set up your specific network settings adjusted for your environments such as work, home, etc. and select the appropriate one to the environment. You can also change the network settings.



- *Not every setting item can be stored.*
- *The Network Setup Utility may not be compliant with all network environments.*

Loading Network Settings

To set your specific network settings, confirm that your computer is connected into the network and has the proper settings for your current environment and follow the instructions below.

1. Click *start – All Programs – SHARP Network Setup Utility – SHARP Network Setup Utility*.
2. Click *OK*.
3. Click *Set*, select *SHARP icon* or *Windows icon*, and then, click *Select icon* button.
4. Select an icon and click *OK*. Type a network name, then, click *OK*. The selected icon appears in the *Network Setup Utility* window.



It takes a moment to load the network settings.

Switching Network

To switch the network set above, confirm your computer is ready to connect into the network and follow the instructions below.

1. Click *start – All Programs – SHARP Network Setup Utility – SHARP Network Setup Utility*.
2. Click *OK*.
3. Select the appropriate network icon in the *Network Setup Utility* window.
4. Click *OK*.





- *Make sure your computer is connected to the proper environment.*
- *If your hardware or software configuration has been changed, you may not be able to switch to the network properly. In this case, you may need to reconfigure the settings.*

Changing Network Settings

To change the loaded network settings, right-click on the icon you want to change the settings in the *Network Setup Utility* window and click *Edit settings* in the pop-up menu. Then, edit the settings.

Deleting Network

To delete the loaded network settings, right-click on the icon you want to delete in the *Network Setup Utility* window and click *Delete setting* in the pop-up menu. Then, click *OK*.

A black square icon containing the white number 5, used as a section separator.

5

CHAPTER 6

Setup Utility

This chapter describes how to run the Setup Utility to change settings on your computer.

Running Setup Utility

With the Setup Utility, you can customize the system configuration information, such as time and date, port assignments, or passwords. The information you have specified is saved in a special area called CMOS RAM, which the system reads every time you turn on your computer. Your computer is shipped from the factory with the appropriate setting of the Setup Utility. Leave it as default in normal use.

Contents of Setup Utility

The Setup Utility consists of five menu pages, as follows:

- **Main:** Configures basic setting
- **Advanced:** Configures device interface
- **Security:** Sets passwords
- **Boot:** Defines where the system boots from
- **Exit:** Exits the Setup Utility or returns to the default values

Entering and Exiting the Setup Utility

1. Turn on your computer.
2. When the message *Press <F2> to enter SETUP* appears, press **F2**.
3. Change to the desired settings. Refer to the next section.
4. In *Exit* menu select one of the exit methods, and press **Enter**.
5. Confirm the message and press **Enter** again. The system restarts.



When the Setup Utility is opened, power management does not work. Do not close the display cover.

Changing the Setting of the Setup Utility

To change the settings:

1. Use → or ← key to select the menu; then, press Enter.
2. Use ↑ or ↓ key to select the item.

On item with ► mark, press Enter to open its sub menu. Press Esc to close the sub menu and return to the previous menu.

Most of the items without ► mark can be changed their values or status by pressing Enter when selected.

For date and time, press Enter on the item to select the value you want to change, then, use minus key or space bar to change the value.

3. Close the Setup Utility by following the steps above.



Main Menu

System Time defines the system time, using the format *hour:minute:second* (24-hour format). Use **Tab** key to move the cursor, and minus key or space bar to change numerals.

System Date defines the system date, using the format *month/day/year*. Use **Tab** key to move the cursor, and minus key or space bar to change numerals.

Hard Disk Type shows the type of the hard disk of your computer. Press **Enter** to show the details.

Internal NumLock defines whether the numlock keys of the built-in keyboard are always disabled or not. (Num lock indicator will turn on when **Fn+NumLk** are pressed regardless of this setting. An external keyboard will be numlocked if connected.)

USB Emulation defines whether USB devices (a keyboard, a mouse or an external floppy disk drive) can be used in DOS mode. (When it is set to *Disabled*, you cannot boot your computer from a floppy disk.)

Quick Boot defines whether the system skips the check of the internal memory while booting, to shorten the boot time.

Quiet Boot defines whether the SHARP logo appears on the screen while booting.

Video RAM Size shows the minimum size of the video memory.

CPU Information shows the information on the CPU.

System Memory shows the volume of the conventional memory used in DOS mode. Always set to 640KB.

Extended Memory shows the volume of the extended memory more than 1MB.

BIOS Version shows the BIOS version of the system.

EC/KBC Version shows the EC or keyboard controller version of the system.

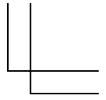
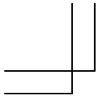

Advanced Menu

Internal Pointing Device enables or disables the built-in glide pad.

Resolution Expansion defines whether the Setup Utility screen is expanded when the resolution is 640x480 or 800x600. *Enabled* means that the screen is expanded.

Plug&Play O/S enables or disables plug & play function. Normally this option has to be set as default.

PCI Configuration normally has to be as default.

Security Menu

Set Supervisor Password defines the supervisor password (up to eight characters). See the next section about the supervisor password.

Set User Password defines the user password (up to eight characters). See the next section about the user password.



If you lose your password, you will be unable to access your computer or change the configuration. Make sure to select a password you will never forget, or write it down and protect it in a secure place. Otherwise, you will have to contact your dealer for assistance.

Password on boot defines whether you have to type the password for booting your computer.

Hard Disk boot Sector defines whether the boot sector of the hard disk is write-protected. When formatting the hard disk or reinstalling software, set to *Normal*.



Supervisor and User Password

Setting a password will protect your computer against unauthorized access. Once a password is set, the system requires the password when entering to the Setup Utility. And if *Password on boot* is enabled, the system will require a password when your computer is turned on.

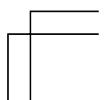
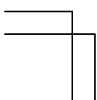

If you enter a wrong password three times, the message System Disabled appears. Press the power button to shut down your computer, and after 10 seconds, press the power button to turn it on again.





Your computer supports two different levels of password security: Supervisor password and User password. You cannot set a user password unless you have set a supervisor password. If you share your computer with others, we recommend that you set both the supervisor and the user password, and let others know the user password only.

With the user password, you can set *System Time* and *System Date* of the *Main* menu, *Resolution Expansion* of the *Advanced* menu, and *Set User Password* of the *Security* menu only.

Setting Password



1. In the *Security* menu of the Setup Utility, select *Set Supervisor Password* or *Set User Password* and press **Enter**.
2. Type your password (up to eight characters), and press **Enter**.
3. Type the same password again, and press **Enter** twice.
4. Select *Exit* menu and confirm *Exit Saving Changes* is highlighted; then press **Enter**.
5. Confirm *Yes* is highlighted and press **Enter**. The system restarts.

Changing Password

1. In the *Security* menu of the Setup Utility, select *Set Supervisor Password* or *Set User Password* and press **Enter**.
2. Type your current password, and press **Enter**.
3. Type your new password, and press **Enter**.
4. Type your new password again, and press **Enter** twice.
5. Select *Exit* menu and confirm *Exit Saving Changes* is highlighted; then press **Enter**.
6. Confirm *Yes* is highlighted and press **Enter**. The system restarts.

Deleting Password

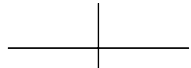
1. In the *Security* menu of the Setup Utility, select *Set Supervisor Password* or *Set User Password* and press **Enter**.
2. Type your current password, and press **Enter**.
3. Without typing any characters, press **Enter**.

- 
- 
- 
4. Press **Enter** twice.
 5. Select *Exit* menu and confirm *Exit Saving Changes* is highlighted; then press **Enter**
 6. Confirm *Yes* is highlighted and press **Enter**. The system restarts.

Boot Menu

Boot Sequence specifies the order in which your computer is to make a check for a device to boot the system. Press **Enter** to open the sub menu. The system boots from the drive at the top of the list. If the system cannot find the drive, it will boot from the second one; then, third one. Use arrow keys to select the drive you want to move; then, use minus key or space bar to move it up and down.

LAN Boot defines whether the system boots from other server via the LAN unit of your computer.

Wake On LAN defines whether the system boots up or resumes from System Hibernate when the LAN unit of your computer becomes active. This setting functions only when your computer is connected to AC power.



6

Exit Menu

Exit Saving Changes saves the settings you have changed and exits the Setup Utility.

Exit Discarding Changes exits the Setup Utility without saving the settings you have changed.

Load Setup Defaults returns the values of all items to the default. To exit, select one of the above items.

Discard Changes returns the values of all items to the values you last saved. To exit, select one of the above two items.

Save Changes saves the settings you have changed. To exit, select one of the above two items.

Appendixes

The appendixes contain additional information on the use and care of your computer.

Memory Module

You can upgrade the memory size of your computer up to 768MB by installing a memory module. For available memory modules, contact your local dealer.

Installing Memory Module



- *Do not handle the memory module in the location where static electricity is easily generated such as on the carpet.*
- *Before installing the memory module, carefully discharge static electricity from your body by touching an unpainted metal area.*
- *Avoid touching the integrated circuits on a memory module. Handle all components by the edges.*
- *Keep the memory module in the anti-static wrapping until you are ready to install it.*

1. Turn off your computer, and disconnect the AC adapter and remove the battery pack and peripheral devices. See Chapter 3 for removing the battery.



- *Make sure to turn off your computer and remove the AC adapter. Otherwise you may get an electrical shock.*
- *After a long usage of your computer, the temperature inside your computer may be hot. Wait until it becomes cool.*

2. Close the display cover and turn over your computer on a stable surface.

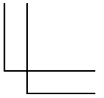

3. Loosen two screws and remove the memory slot cover.

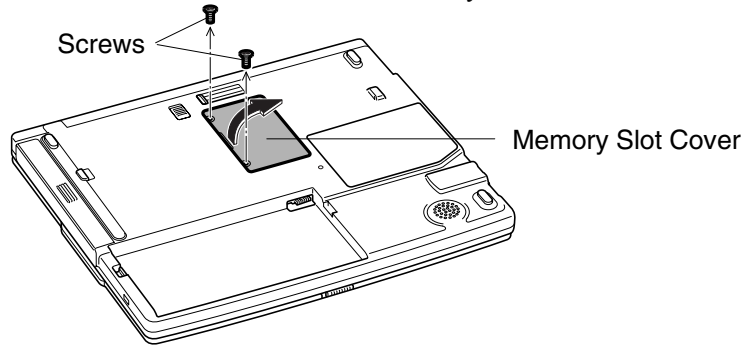

4. Turn over the sheet and align the memory module as shown below, matching the notched part of the module with the projected part of the memory socket of your computer.

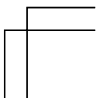
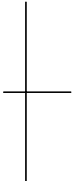
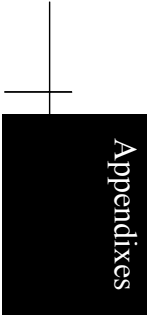
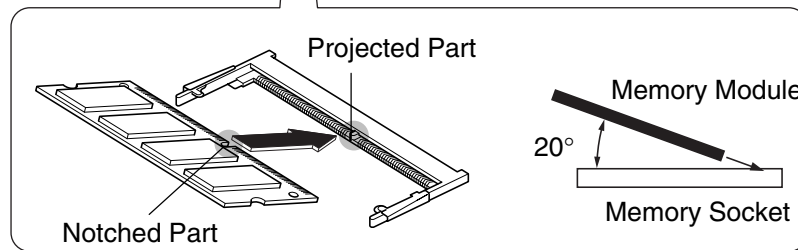
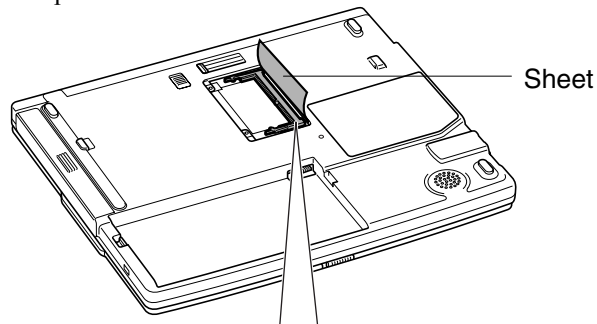

5. Press the memory module slowly to place it into the memory socket, matching the notched parts of the module with the projected parts of the socket, until you hear the clicking sound.

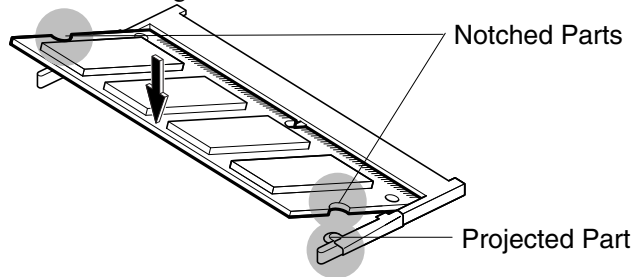

6. Replace the sheet and memory slot cover, matching the projected parts of the cover with the notched parts of your computer.

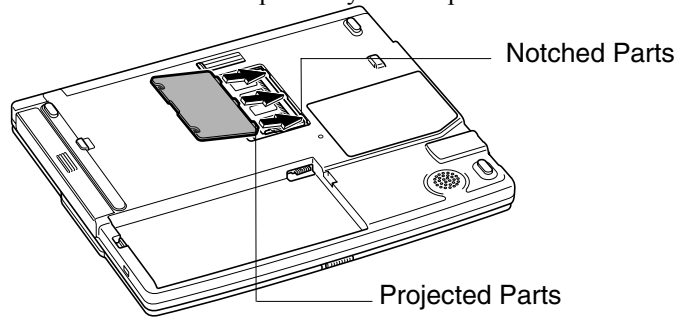

7. Tighten the screws.

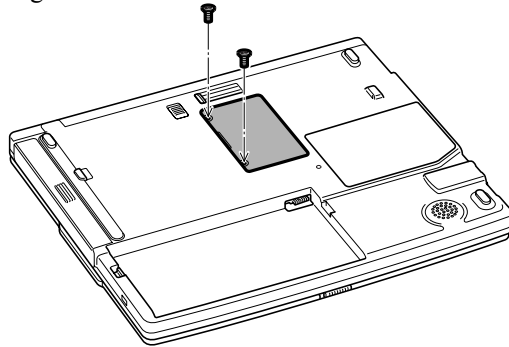

8. Replace the battery pack, turn over your computer and connect the AC adapter.



See Chapter 3 for replacing the battery pack.

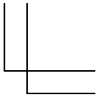

9. Open the display cover; turn on your computer and check the memory size; by clicking *start – My Computer – View system information* of *System Tasks*. Your memory size appears at the bottom of the sentence in *General* tab. Share video memory size will not be included with the value.

Uninstalling Memory Module

1. Follow steps 1-3 of *Installing Memory Module*.
2. Turn over the sheet and slightly bend both latches outwards until the memory module is released.

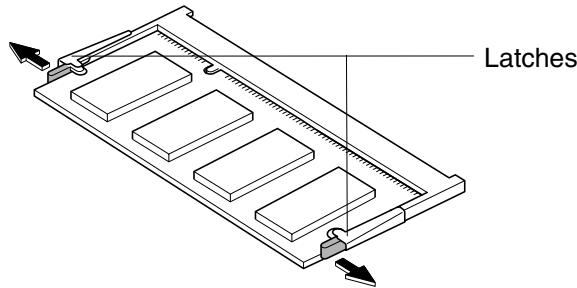

3. Remove the memory module and follow steps 6-9 of *Installing Memory Module*.

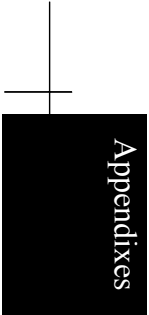

Installing Weight Saver

You can change the optical drive unit for the weight saver to make your computer lighter. With the weight saver installed instead of the optical drive unit you can get the better portability.



Always keep either of the optical drive unit or the weight saver installed into the optical bay. Leaving the optical drive bay empty may damage your computer.

Installing Weight Saver

1. Turn off your computer and disconnect the AC adapter from your computer.



Make sure to turn off your computer and remove the AC adapter. Otherwise your computer may be damaged.

2. Close the display cover and turn over your computer on a stable surface.

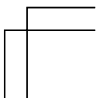

- Slide the optical drive stopper backward you and pull out the optical drive unit from your computer.

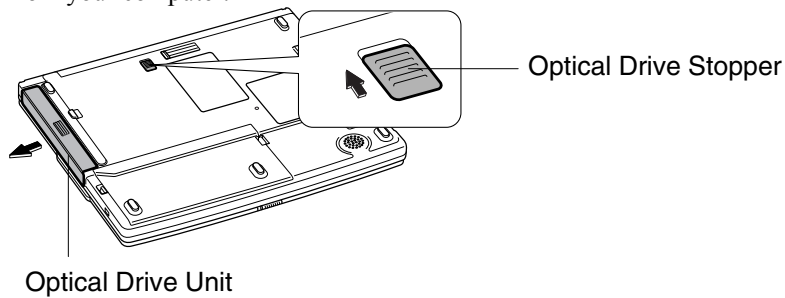

Keep the optical drive unit wrapped and in a safe place to avoid any damage.

- Install the weight saver into the bay until it clicks.

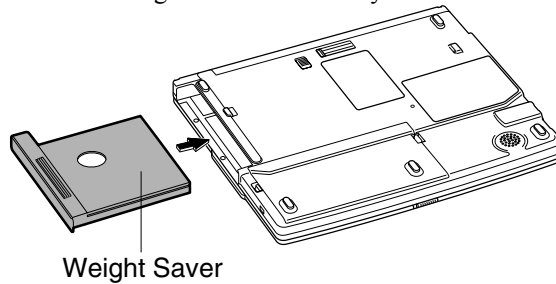

Re-installing Optical Drive Unit

- Turn off your computer and disconnect the AC adapter from your computer.



Make sure to turn off your computer and remove the AC adapter. Otherwise your computer may be damaged.

- Close the display cover and turn over your computer on a stable surface.
- Slide the optical drive stopper backward you and pull out the weight saver from your computer.

4. Install the optical drive unit into the bay until it clicks.

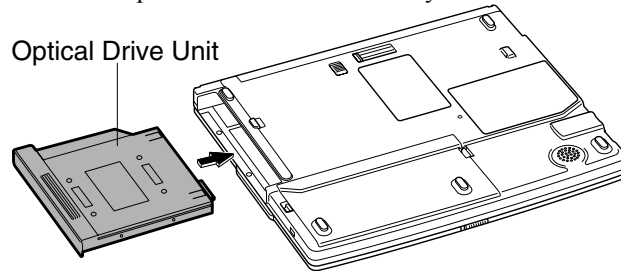

Maintenance and Care

This appendix provides you with information on how to maintain your computer in excellent working condition.

Replacing Backup Battery

Your computer is equipped a backup battery for keeping the information of the Setup Utility, etc. If you see the message *Press <F1> to resume, <F2> to Setup*, replace it with a Lithium CR2032 Battery on the market.

1. Turn off your computer, disconnect the AC adapter, and remove the battery pack from your computer.



Make sure to turn off your computer and remove the AC adapter and the battery pack from your computer. Otherwise your computer may malfunction.

2. Loosen the screws and remove the cover of the backup battery box.

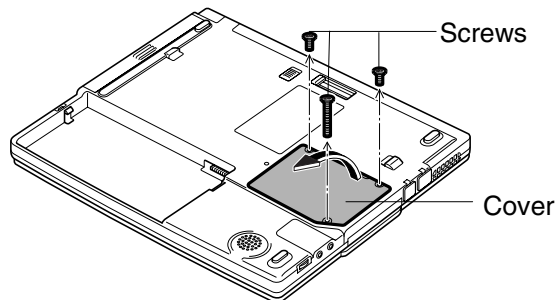

3. Remove the backup battery with a pointed staff.

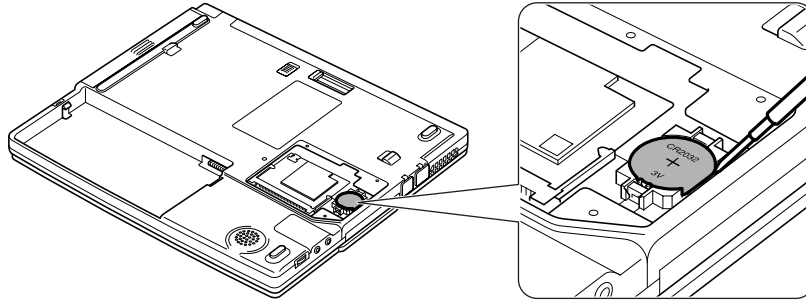

Never use a metallic material. If the material touches to the circuit, your computer may malfunction.

4. Insert a new backup battery with the plus side (printed a part number) up. Press two hooks of the box with the edge of the battery and hold it; then, press down the battery.

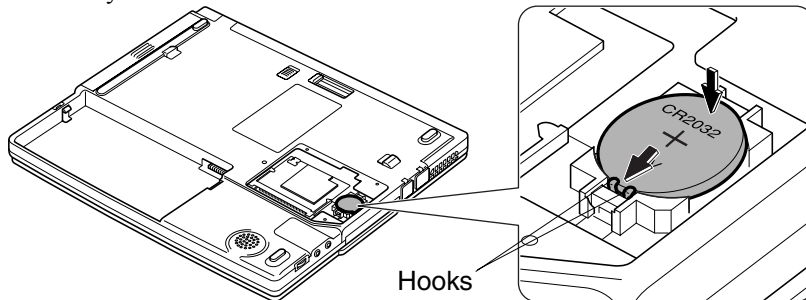

5. Replace the cover on your computer matching the projected parts of the cover with the notched parts of your computer.

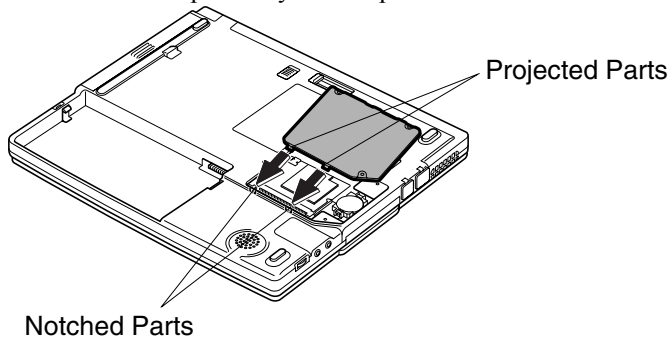

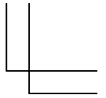

6. Tighten the screws.

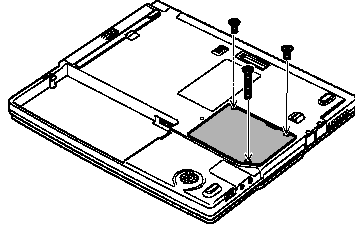

7. Insert the battery pack.
8. Turn your computer over and connect the AC adapter.
9. Turn on your computer.
10. If you see the message Press <F2> to enter Setup, press F2.
11. In the Exit menu, select Load Setup Defaults; then, press Enter.
12. When the message Load default configuration now? appears, select Yes; then, press Enter.
13. In the Exit menu, select Exit Saving Changes; then, press Enter.
14. When the message Save configuration changed and exit now? appears, select Yes; then, press Enter.
15. Click start – Control Panel.
16. Click Date, Time, Language, and Regional Options in Category view; then, click on Change the date and time string.
17. Set date and time; then, click OK.
18. Close the *Control Panel* window.

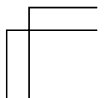

Using Security Cable

You can connect a security cable to the security slot on the right side of your computer to prevent theft.

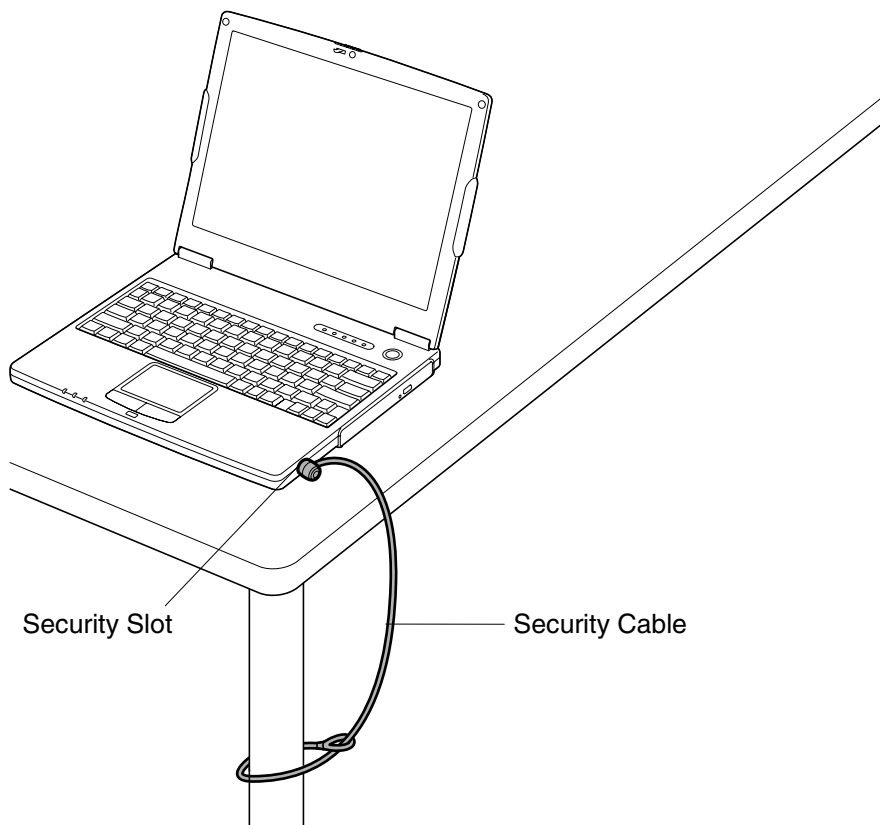

Appendixes

Cleaning Computer

Cabinet

Apply a small amount of mild cleaning solution to a dry, lint-free cloth and wipe the cabinet with the cloth.



- *Never clean your computer while it is powered on.*
 - *Do not use alcohol, benzene, thinner or other strong chemical agents that may damage the cabinet.*
-



Screen

The surface of the screen may become smeared and accumulate dust during use. Avoid touching the screen with your fingers when using the system. Gently wipe the surface of the screen with a soft cloth that has been dipped in a mild detergent solution and squeezed dry.

Glide Pad

Wipe the glide pad with a soft, dry cloth.

Ventilation Openings

Dust on the ventilation openings may cause overheating of your computer. Wipe the ventilation openings with a soft, dry cloth.

Traveling with Your Computer

This computer is designed for portability. For safety and convenience when traveling, please follow these guidelines.

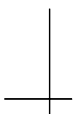
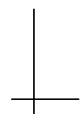
- 
- 
- Before traveling, back up your data onto floppy disks, optical disks or other external media.
 - Do not travel with any peripherals such as an external floppy disk drive unit connected.
 - Do not carry your computer powered on. This may result in loss of data and/or damage to the hard disk drive.
 - Make sure the display cover is properly closed before traveling. Otherwise the cover may be opened unawares, and the display or the keyboard will be damaged.
 - If you carry your computer in a bag, try to avoid unnecessary pressure, caused by the stuff of the bag, to your computer.
 - Disconnect the AC adapter from your computer.
 - Fully charge the battery pack, and bring the AC adapter and the AC power cord.
 - Avoid sudden shocks or extreme vibration.

Re-installation Instructions

To recover your hard disk, you will use PowerQuest®EasyRestore™. Before starting re-installation, read the following End User License Agreement first.

PowerQuest(R) EasyRestore (TM) End User License Agreement

IMPORTANT: Read this before using your copy of PowerQuest software.

This document is a legal agreement between you, the "end user," and PowerQuest Corporation. Use of the software indicates your acceptance of these terms. As used in this License Agreement, the term "Software" means the EasyRestore software included on the CD provided with this License Agreement.

- 1. PROPRIETARY RIGHTS.** The Software is a proprietary product of PowerQuest Corporation ("PowerQuest") or its licensors and is protected under U.S. copyright laws and international treaty provisions. Ownership of the Software and all copies, modifications, and merged portions thereof shall at all times remain with PowerQuest or its licensors.
- 2. GRANT OF LICENSE.** The Software is being licensed to you, which means you have the right to use the Software only in accordance with this License Agreement. The Software contains pre-installed software for disaster recovery purposes. The Software is only authorized for distribution together with a specific computer. This License authorizes you to use the Software for disaster recovery purposes only, to restore the hard disk image contained on the CD to the computer with which the CD and Software were originally shipped.
- 3. NONPERMITTED USES.** Without the express permission of PowerQuest, you may not (a) use, copy, modify, alter, or transfer, electronically or otherwise, the Software or documentation except as expressly permitted in this License Agreement, or (b) translate, reverse program, disassemble, decompile, or otherwise reverse engineer the Software.
- 4. TECHNICAL SUPPORT.** PowerQuest is NOT responsible to provide technical support. Any and all technical support questions, regarding the Software, should be referred to the place of purchase.
- 5. U.S. GOVERNMENT RESTRICTED RIGHTS.** If you are acquiring the Software on behalf of any unit or agency of the United States Government, the following provision applies: It is acknowledged that the Software and the documentation were developed at private expense and that no part is in the public domain and that the Software and documentation are provided with RESTRICTED RIGHTS. Use, duplication, or disclosure by the Government is subject to restrictions as set forth in subparagraph (c)(1)(ii) of the Rights in

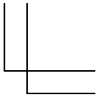

Technical Data and Computer Software clause at DFARS 252.227-7013 or subparagraphs (c)(1) and (2) of the Commercial Computer Software-Restricted Rights at 48 CFR 52.227-19, as applicable.
Contractor/manufacture is PowerQuest Corporation/P.O. Box 1911/Orem, UT 84059.

6. NO WARRANTY. The Software is being provided to you AS IS. PowerQuest does not warrant the Software to end users. If the Software fails to perform substantially in accordance with the documentation provided to your hardware supplier, PowerQuest will repair or replace the copy of the Software provided to your hardware supplier and will authorize your hardware supplier to provide such repaired or replaced Software to you without charge.

7. LIMITATION OF LIABILITY. NEITHER POWERQUEST NOR ITS SUPPLIERS SHALL IN ANY EVENT BE LIABLE FOR ANY DAMAGES WHATSOEVER ARISING OUT OF OR RELATED TO THE USE OF OR INABILITY TO USE THE SOFTWARE, INCLUDING BUT NOT LIMITED TO DIRECT, INDIRECT, SPECIAL, INCIDENTAL, OR CONSEQUENTIAL DAMAGES, AND DAMAGES FOR LOSS OF BUSINESS PROFITS, BUSINESS INTERRUPTION, LOSS OF BUSINESS INFORMATION, OR OTHER PECUNIARY LOSS, EVEN IF POWERQUEST CORPORATION HAS BEEN ADVISED OF THE POSSIBILITY OF SUCH DAMAGES, WHETHER SUCH LIABILITY IS BASED ON CONTRACT, TORT, WARRANTY, OR ANY OTHER LEGAL OR EQUITABLE GROUNDS. BECAUSE SOME STATES DO NOT ALLOW THE EXCLUSION OR LIMITATION OF LIABILITY FOR CONSEQUENTIAL OR INCIDENTAL DAMAGES, THE ABOVE LIMITATION MAY NOT APPLY TO YOU.

8. NO WAIVER. Any failure by either party to this agreement to enforce a specific part of the agreement in a specific situation is not a waiver of rights under the agreement. The party may still enforce the rest of the agreement in that situation and may still enforce some or all of the agreement in other situations.

9. This License Agreement constitutes the entire agreement between you and PowerQuest pertaining to its subject matter. This License Agreement is governed by the laws of the State of Utah. Any litigation arising from this license will be pursued only in the state or federal courts located in the State of Utah.

Copyright 1994-2003, PowerQuest Corporation. All rights reserved. U.S. Patents 5,675,769; 5,706,472; and 5,930,831; other patents pending in the U.S.A. and elsewhere. PowerQuest is a registered trademark and EasyRestore is a trademark of PowerQuest Corporation.

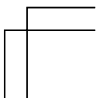
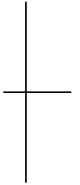
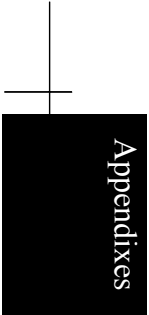

Preparation for Re-installation

You can format the hard disk and re-install the preinstalled software with the recovery CD-ROM, and set the status of your computer to the same configuration as shipped from the factory. The following items are necessary for re-installation:

- Product Recovery CD-ROMs
- Operation Manual



- *It will take about 15 minutes to complete the re-installation.*
- *Use the Product Recovery CD-ROMs only for your computer.*
- *The Product Recovery CD-ROMs are not for sale. Keep them in a secure place.*
- *Unless otherwise specified, the instructions in this booklet assume that you are installing Windows XP into the C:\WINDOWS directory.*

Backing up the data

Before formatting the hard disk, you should back up your data. For details on how to back up your data, see the Windows Online Help.

Selecting the way to recover your system

Your computer has two drives(C: and D:) in its hard disk when it was shipped from the factory. You can select the way to recover your system.

- *Recovers C: drive only. (Recommended)*
This process will format C: drive only and recover C: drive to the same status as shipped from the factory. Nothing will be done to D: drive. The volume of the drives will not be changed and current ones will be kept.
- *Recovers both C: and D: drive.*
This process will format both C: and D: drives, and contents of the hard disk are restored to its original state in C: drive. The volume of the drives will be back to the same as shipped from the factory.
- *Formats hard disk and creates new partition.*
This process will format the whole hard disk drive and creates a new partition. You can select the volume of C: and D: drives. The contents of the hard disk are restored to its original state in C: drive.

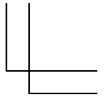
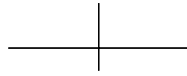
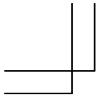

Formatting the drives and re-installing Windows XP

1. Make sure your computer is turned off.
2. If any peripheral devices are connected to your computer, disconnect them.
3. If the weight saver is installed in your computer remove it and install the optical drive.
4. Connect the AC adapter; then, turn on your computer.



Be sure to connect the AC adapter. If the battery power becomes significantly low, the installation process will be canceled.



5. When the message *Press <F2> to enter SETUP* appears, press **F2**. The Setup Utility opens.
6. Insert the Product Recovery CD-ROM disk 1 into the optical drive.
7. In the *Exit* menu, select *Load Setup Defaults*; then, press **Enter** twice.
8. In *Boot Sequence* of the *Boot* menu, set *CD-ROM Drive* to the top of the list; then, press **Esc**.
9. In the *Exit* menu, confirm *Exit Saving Changes* is highlighted and press **Enter** twice. The system restarts.
10. Read the message on the screen, and select the way to recover your system; then, press **Enter**. If you selected *Formats hard disk and creates new partition*, go to the next step. Otherwise, go to Step 12.
11. Select the volume of C: drive and press **Enter**.
12. Read the message and select *Continue*; then, press **Enter**.

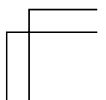
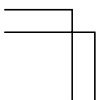

Although the pointer may be shown on the screen, never touch the keyboard or the glide pad during recovery except when the message prompts you to. If you touch them, the re-installation will be canceled.

13. If you see the message asking you to replace the CD-ROM, remove the Product Recovery CD-ROM disk 1 and insert the Product Recovery CD-ROM disk 2, then, click *OK*.
14. If you see the message asking you to replace the CD-ROM, remove the Product Recovery CD-ROM disk 2 and insert the Product Recovery CD-ROM disk 3, then, click *OK*.



- 
- 
- 
15. When the message *Press <F2> to enter SETUP* appears, press **F2**. The Setup Utility opens.
 16. In the *Exit* menu, select *Load Setup Defaults*; then, press **Enter** twice.
 17. In the *Exit* menu, confirm *Exit Saving Changes* is highlighted and press **Enter** twice. The system will restart again.
 18. Set up Windows XP by following the instructions on the screen. When you finish the setup, the recovery is completed. Make sure to set date and time.

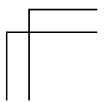
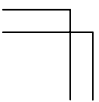
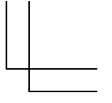
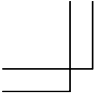



Troubleshooting

This chapter describes how to troubleshoot computer problems.

Common Problems

Problems with your computer can be caused by something as minor as an unplugged power cord or as major as a damaged hard disk drive. The information in this troubleshooting section is designed to help you find and solve minor problems. If you still have a problem after trying all the suggested remedies in this chapter, contact your dealer.

The problems that you might encounter can be divided into two basic categories: hardware and software. Hardware problems can be further divided into being of an electrical or a mechanical nature. You will know you have a hardware problem if, for example, the screen is blank, or your computer cannot recognize the disk drives.

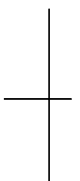

Software problems can occur at several levels. Both your operating system and your software application programs are capable of generating errors and error messages. If you encounter a software error, try to determine if the error message is from your operating system or from an application program, and refer to the appropriate manual for possible remedies.

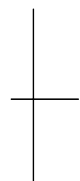

You can also refer to the Windows manual or Windows help program to solve the problem. To access the help program, click *start – Help and Support*. It also gives you troubleshooting tips and an index.

Successful troubleshooting is the result of careful observation, deductive reasoning, and an organized approach to solving the problem. If you encounter a problem, begin by performing a careful visual inspection. Check the exterior of your computer first. If no lights are displayed, check the battery charge or power outlet, the plug and power cord, and any power switches that may affect your computer. If your computer has been connected to any peripheral devices, look for loose or disconnected cables. You may also need to check the fuses and breakers in your electric box. A few common problems and suggested solutions are presented in the examples that follow.

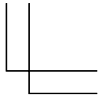
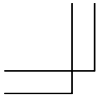

Trouble when Starting

Question: Why doesn't the power indicator or the battery indicator turn on?

- Make sure the AC adapter is correctly connected to the AC adapter jack of your computer.
- Make sure the AC power cable is correctly connected to a live wall outlet. Connect another electric equipment to the wall outlet and check whether it is live or not.
- Make sure the battery pack is correctly installed and charged.
- If the battery pack is discharged, connect the AC adapter.
- If all the steps above failed, follow the instructions on *Why doesn't the keyboard or the glide pad function?*

Question: Why do I get the message *Invalid system disk*?

- You may have inserted a non-bootable disk in the external floppy disk drive unit (either a defective disk or one without an installed operating system). Remove the disk.

Question: Why can't I boot from the floppy disk?

- Make sure that the external floppy disk drive unit is correctly connected to your computer.
- Check whether the floppy disk set to the external floppy disk drive unit contains a system disk.
- Check whether *USB Emulation* in *Main* menu of the Setup Utility is enabled. (Refer to *Main Menu* in Chapter 6.)
- Check whether *Floppy Disk Drive* in *Boot Sequence* in *Boot* menu of the Setup Utility is set to the top of the list. (Refer to *Boot Menu* in Chapter 6.)

Question: Why do I get the message *Press <F1> to resume, Press <F2> to setup?*

- The setting of the Setup Utility is deleted. Run the Setup Utility and get default value of the Setup Utility. Be sure to set the date and time correctly.

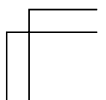
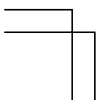

- If you often see the message, the backup battery has no capacity left. Replace the backup battery with the steps in *Replacing Backup Battery* of Appendixes.

Question: Why do I get the message *Operating system not found*?

- Run the Setup Utility and get default value of the Setup Utility. Be sure to set the date and time correctly.

Trouble with Display

See also the *Display* section in Chapter 2 and 4.

Question: Why is the screen blank?

- Press any key to see if any power management feature has turned off the screen to save power.
- See the power indicator to check whether your computer is turned on.
- If you are using a battery pack, make sure it is correctly installed and has a charge remaining.
- Make sure the LCD screen is selected as the display by pressing **Fn+F5** (⏏).
- Check whether the display is on by pressing **Fn+F11** (⏏).
- If you still have the problem after trying the above, follow the steps in *Why doesn't the keyboard or the glide pad function?*

Question: Why does the external monitor display nothing or the image on it distorted?

- Confirm the monitor is turned on.
- Confirm the monitor is connected correctly.
- Make sure an external monitor is selected as the display by pressing **Fn+F5** (⏏).
- If you use **Fn+F5** (⏏) to change the display, the image may be distorted. Press **Fn+F5** (⏏) again to return the previous display and use *Display Properties* dialog box to change it again.
- Make sure the value of *Screen resolution* in *Settings* tab of *Display Properties* is same as or lower than the resolution of the external monitor.

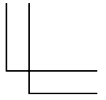
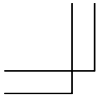

- Make sure the external monitor is not near any electric devices having strong magnetic fields such as a TV set or radio.
- Do not share an outlet with a TV set or radio.

Question: Why does the TV set display nothing or the image on it distorted?

- Confirm the TV is turned on.
- Confirm the TV set is connected correctly.
- If an external monitor is connected to your computer, disconnect it.
- Make sure *TV* is selected as the output display by using *Display Properties* dialog box. (Refer to *Displaying Video on Your TV Set* section in Chapter 2.)
- Confirm the *Screen resolution* is set to 800 by 600 pixels and *Color quality* to *Medium* (16bit).

Question: Why can't I change the display with Fn+F5 keys?

- When playing the animation or game, **Fn+F5** (⏏) key combination may not work. Close the currently running application.
- When running DOS in the full screen mode, **Fn+F5** (⏏) key combination may not work.
- Use *Display Properties* dialog box to change it.
- When connecting to a TV set, **Fn+F5** (⏏) key combination does not work.

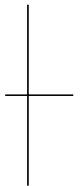
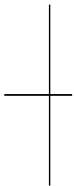



Trouble with Keyboard/Glide Pad

Question: Why doesn't the keyboard or the glide pad function?

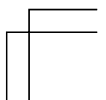
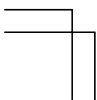
- Try the following in this order:
 1. Press **Ctrl+Alt+Delete** and select *Users* tab of *Windows Task Manager* dialog box. Click *Disconnect* or *Log Off*; then, *Yes*.
 2. If the step1 fails to work, press the power switch for more than four seconds to turn off the system. Ten seconds later, turn your computer on.



- 
- 
- 
3. If you still cannot turn off the system with the power switch, press the reset switch on the bottom of your computer to turn off the system (refer to *Resetting System* section of Chapter 2). Ten seconds later, turn on your computer by pressing the power switch.

Question: Why does the glide pad malfunction?

- The surface of the glide pad or your palm may be moist or dirty and grease. Wipe the glide pad with a soft, dry cloth.

Trouble with Floppy Disks

Question: Why can't I use a floppy disk?

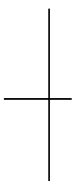
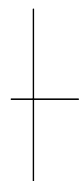
- 
- 
- Confirm the external floppy disk drive unit is correctly connected.
 - Confirm the floppy disk is inserted correctly.
 - Confirm the drive or file name is correct.
 - The floppy disk may not be formatted or could be corrupted. Format the disk or use another disk.
 - If you cannot write to a floppy disk, the disk may be write-protected. Eject the disk and ensure that the write-protect tab covers the detection hole.
 - If you cannot write to a floppy disk, the disk may be full. Use another disk.

Trouble with the Hard Disk

Question: Why can't I read or write data to/from the hard disk?

- Confirm the drive and file names are correct.
- Confirm the hard disk has sufficient free space.

Trouble with the Optical Drive

Question: Why can't I read data from a compact disc or play files?

- Confirm the CD is inserted correctly.
- Confirm the drive and file names are correct.
- Confirm the CD is not stained or scratched.
- Confirm the CD or files are supported.
- Confirm the optical drive unit is correctly installed to your computer.

Question: Why the drive does not open?

- Confirm the optical drive unit is correctly installed to your computer.
- Confirm your computer is turned on.
- When your computer is turned off, insert a fine rod into the drive tray ejection hole.

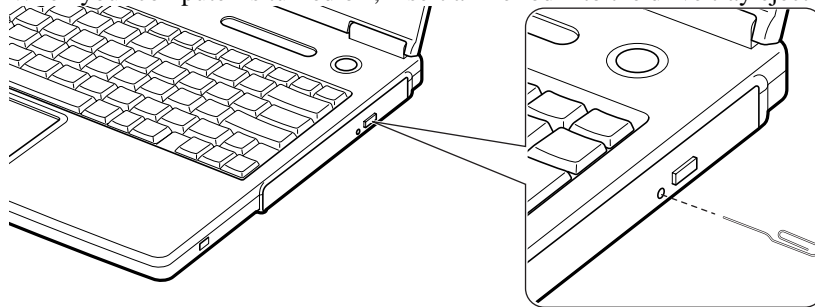

Question: Why can't I read data from a disk or play files?

- Confirm your computer is turned on.
- Confirm the disk is inserted correctly.
- Confirm the drive and file names are correct.
- Confirm the disk is not stained or scratched.
- Confirm the disk or files are supported.

Question: Why doesn't the DVD video play smoothly?

- Ensure to use AC power.
- Set back the screen resolution, color quality, and screen refresh rate to the default value. See the specifications on the supplement for the default values of your computer.
- Power management may be working. Disable it.

Question: Why isn't the optical drive recognized?

- If your computer is turned on with some kinds of DVD disks inserted in the drive, the drive may not be recognized. In this case, turn off your computer and open the disk tray by the way on *Question: Why does not the drive open?* on the previous page. Remove the disk from the drive; then turn on your computer again.

Trouble with Communication

Question: Why can't I communicate through the built-in modem?

- If your computer is turned on with some kinds of DVD disks inserted in the drive, the drive may not be recognized. In this case, turn off your computer and open the disk tray by the way on *Question: Why does not the drive open?* on the previous page. Remove the disk from the drive; then turn on your computer again.
- Confirm the telephone line is properly connected to the modem jack.
- Confirm the dial setting (pulse or tone) of Windows XP and/or communication software is matched with the telephone line.
- If you set your connection status using *New Connection Wizard*, check *Use dialing rules* in the *Properties* dialog box of that connection status. Refer to *Internet Connection* section of Chapter 5.
- Confirm the country/region setting is appropriate.
- Confirm the network configuration is appropriate.
- Confirm the user name or password is correct.
- Confirm the COM port in the communication software is set appropriately.
- Turn off the power management in the Windows.
- If an unusual device is attached to the line you are connecting to, the modem may not function properly. Remove the device or contact the dealer of the device.
- If your computer is connected to a PBX, consult the PBX maintenance staff or its service company. If the electric characteristics of your PBX are different from those of a regular analog line, the modem will not function properly. If you connect the modem to a digital PBX, both the modem and the PBX may be damaged.

Question: Why is the access speed so slow?

- Close the applications currently opened.
- Try to connect another ISP (Internet Service Provider), or try to connect in some other time.

Question: Why can't I access the LAN?

- Confirm the cable is properly connected to the LAN jack and the network hub.
- Confirm the network configuration is appropriate.
- Confirm the user name or the password is correct.

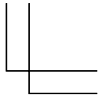
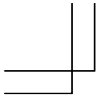

Question: How can I detect the MAC address?

- Follow the instructions below:
 1. Click *start – All Programs – Accessories – Command Prompt*.
 2. Type `ipconfig/all`; then, press **Enter**. The IP information appears.
 3. See the numbers of *Physical Address* in *Ethernet adapter Network Adapters* section.
 4. Type `exit`; then, press **Enter**.

Question: Why can't I detect the access point on my computer? (for wireless LAN model only)

- Confirm the access point is powered on.
- Restart your computer.
- Confirm your computer is enabled for the wireless LAN.

- Detect the access point by following the steps below

1. Click *start – My Computer*.
2. Select *My Network Places* in *Other Places*; then, *View network connections* in *Network Tasks*. *Network Connections* dialog box appears.
3. Right-click *Wireless Network Connection*; then, click *Disable*.
4. Right-click *Wireless Network Connection*; then, click *Enable*.

- When you have more than one available access points, your computer may be connected to other than right one you want to access:

1. Right-click (🖱️) icon on the taskbar; then, click *View Available Wireless Networks*.
2. Select the desired network in the *Available networks* list; then, click *Connect* button.

Question: Why can't I connect to the network via an access point? (for wireless LAN model only)

- Confirm *Any available network (access point preferred)* is selected in *Networks to access* of *Advanced* dialog box.

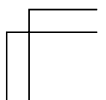
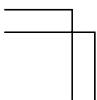
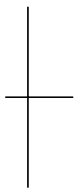
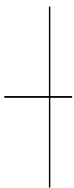

- Confirm the ESSID of your computer matches the ESSID of the access point you want communicate with.
- Confirm the WEP key is correctly entered if the WEP security of the access point is enabled.



Question: Why can't I communicate with other computers through a wireless LAN (for wireless LAN model only)?

- Confirm each computer is enabled for wireless LAN.
- Confirm *Computer-to-computer (ad hoc) networks only* is selected in *Networks to Access of Advanced* dialog box of each computer. (To open *Advanced* dialog box, refer to *Communicating with Other Computers* section of Chapter 5.)
- Adjust the distance between the computers by bringing your computer closer to others and remove any obstructions that may impede the communication; then, try to connect again. (The distance between computers or access points should be less than approximately 60m (190 feet), in direct line of sight.)
- Confirm the IP address, the subnet mask and the default gateway of each computer are set correctly.
- Confirm the WEP key is correctly entered if the WEP security of other devices, which you want to communicate with, is enabled.

Trouble with Peripherals

Question: Why don't peripheral devices function?

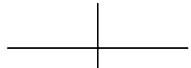
- Confirm they are correctly connected to your computer.
- Confirm they are Windows XP compliant.
- Confirm drivers necessary for the devices are installed.



Question: Why can't I print?

- Make sure the printer is turned on.
- Check whether your computer and the printer are connected correctly.
- Check whether the printer is ready to print.
- Check whether the printer has enough paper.
- Check whether the printer driver is installed.
- Click *start - Control Pane - Printers and Other Hardware – Printers and Faxes*. If Classic view is selected, double-click *Printers and Faxes* icon. Confirm your printer is installed. If not, click *Add a printer of Printer Tasks* to install it.
- See also the Windows help program by clicking *start - Help and Support*.

Question: Why don't peripheral devices function correctly?

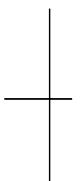
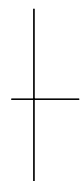
- 
- 
- Set *System standby/hibernate* to *Never* in *Power Options Properties* dialog box. If this does not work, set *Turn off hard disks* to *Never*.
 - Confirm they are Windows XP compliant.
 - Confirm drivers necessary for the devices are installed.

Other Troubles

Question: Why is the battery pack discharged so quickly?

- Initialize the battery pack.

Question: Why is the date and/or time incorrect?

- Correct the date and time in Windows. Double-click the time appearing on the taskbar and set them in *Date and Time Properties* dialog box.

Question: Why can't I use a hardware device?

- Make sure the hardware device is not crossed out with an X mark using the following procedure.
 1. Click *start – Control Panel*. Click *Performance and Maintenance*; then, *System*. If Classic view is selected, double-click *System* icon.
 2. Click *Hardware* tab; then, *Device Manager*.
 3. Double-click the device you cannot use and confirm *Use this device (enable)* appears in *Device usage*.

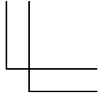
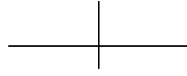
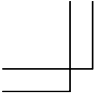

Question: Why can't I produce sound?

- Turn the volume control on the left side of your computer backward to increase the output volume.
- Click or double-click the speaker symbol on the taskbar and check the Windows volume.

Question: Why can't I turn off my computer?

- Follow the instructions on *Why doesn't the keyboard or the glide pad function?*

Question: Why my computer is so hot?

- When charging the battery pack, its surrounding area or the front of the keyboard may become hot, but this is not a problem.

Question: Why can't I record the sound from the microphone?

- Follow the instructions below:
 1. Double-click the speaker symbol on the taskbar.
 2. Click *Options* and select *Properties*.
 3. Select *Recording* in *Adjust volume* and confirm *Microphone* is checked in *Show the following volume controls*, then click *OK*.
 4. Confirm *Select* is checked in *Microphone* of *Recording Control* dialog box.
 5. Close the *Recording Control* dialog box.

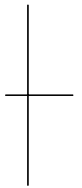
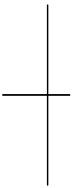

Question: Why can't find the drivers and applications?

- You may accidentally remove them. They are stored on the last recovery disk. (i.e. when two recovery CDs are provided, they are stored on the "Disk 2".) When you are not sure how to install them or the CD does not have the drivers or applications, consult local service staff.

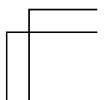
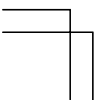

Index

A

- AC adapter
 - connecting, 1-2
 - using, 2-2
- Account
 - creating, 2-19
 - switching, 2-19
- Audio
 - connecting audio equipment, 4-8, 4-9
 - connecting headphone, 4-9
 - connecting microphone, 4-10
 - connecting speakers, 4-7
 - controlling output volume, 2-15

B

- Backup battery, A-6
- Battery pack
 - Add-on battery pack, 3-6
 - changing, 3-4
 - charging, 3-2
 - checking level, 3-2, 3-9
 - conditioning, 3-4
 - indicator, 2-1 3-3
 - installing, 1-1
 - low battery indication, 3-3

C

- Cleaning
 - computer, A-9
- CD
 - handling, 2-7
 - inserting, 2-8
 - removing, 2-9
 - troubleshooting, T-5
- CD-R/RW, 2-10

D

- Display
 - changing brightness, 2-16
 - changing resolution, 2-17
 - changing number of colors, 2-17
 - switching the display, 2-6, 4-7
 - troubleshooting, T-3
 - turning off, 2-6
- DVD-ROM
 - parental control, 2-12
 - playing, 2-13
 - region code, 2-11
 - troubleshooting, T-6

E

- External monitor
 - connecting, 4-6
 - disconnecting, 4-6
 - displaying, 4-6
 - switching the display, 2-6, 4-7

F

- Floppy disk
 - ejecting, 4-4
 - formatting, 4-5
 - handling, 4-3
 - inserting, 4-4
 - troubleshooting, T-5
- Floppy disk drive
 - connecting, 4-3
 - disconnecting, 4-5
 - troubleshooting, T-5

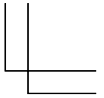

G

- Glide pad
 - changing configuration, 2-5
 - clicking and double-clicking, 2-5
 - drag and drop, 2-5
 - scroll, 2-5
 - troubleshooting, T-4

H

- Hard disk drive
 - troubleshooting, T-5

I

- IEEE 1394 device
 - connecting, 4-15
 - disconnecting, 4-16
- Indicators
 - battery, 2-1
 - power, 2-1
 - status, xiv

K

- Keyboard
 - function keys, 2-6
 - special keys, 2-6
 - troubleshooting, T-4
 - windows key, 2-6

L

- LAN
 - configuring, 5-5
 - connecting to network, 5-4
 - troubleshooting, T-8

M

- Memory module
 - installing, A-1
 - uninstalling, A-4
- Modem
 - configuring, 5-3
 - connecting to telephone line, 5-2
 - troubleshooting, T-7

Index-2

N

- Network setup utility
 - changing, 5-12
 - deleting, 5-12
 - loading, 5-11
 - switching, 5-11

O

- Optical drive
 - troubleshooting, T-5

P

- Passwords
 - changing, 2-21, 6-5
 - deleting, 2-21, 6-5
 - setting, 2-20, 6-5
- PC cards
 - ejecting, 4-13
 - inserting, 4-12
- Peripherals
 - audio equipment, 4-8
 - connecting guidelines, 4-1
 - external floppy disk drive, 4-3
 - external monitor, 4-5
 - headphones, 4-9
 - IEEE 1394 device, 4-15
 - microphone, 4-10
 - PC cards, 4-12
 - printer, 4-14
 - speakers, 4-7
 - television set, 2-13
 - troubleshooting, T-9
 - USB device, 4-11
- Power
 - choosing AC or battery, 2-1
 - indicator, 2-1
- Power management
 - controlling CPU speed, 3-11
 - disabling, 3-14
 - stopping power supply to display, 3-10
 - stopping power supply to hard disk, 3-10
 - system hibernate, 3-12
 - system standby, 3-12
- Printer, 4-14

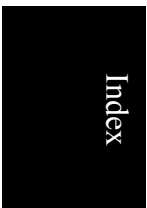
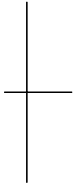
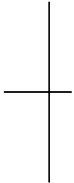

Index

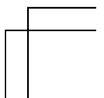

R

- Resetting
 - power switch, 2-3
 - reset switch, 2-3

S

- Screen Saver, 2-18
- Setup utility
 - advanced menu, 6-4
 - boot menu, 6-6
 - entering and exiting, 6-2
 - exit menu, 6-6
 - main menu, 6-3
 - running, 6-1
 - security menu, 6-4
- Security cable, A-9
- S/PDIF compliant digital audio, 4-8
- Status indicators, xiv
- System hibernate
 - about, 3-12
 - generating conditions, 3-13
 - resuming from, 3-12
 - supporting, 3-13
- System standby
 - about, 3-12
 - generating conditions, 3-13
 - resuming from, 3-12

T

- Television set, 2-13

Troubleshooting

- common problems, T-1
- communications, T-7
- display, T-3
- external floppy disk drive, T-5
- hard disk drive, T-5
- keyboard or glide pad, T-4
- LAN, T-7
- optical drive, T-5
- peripherals, T-9

U

- USB device, 4-11

W

- Wallpaper, 2-18
- Weight saver, A-4
- WEP key, 5-9
- Windows XP
 - first-time setup, 1-4
 - properties dialog boxes, 1-5
- Wireless LAN
 - activating, 5-7
 - communicating, 5-8
 - conflicting the status, 5-9
 - connecting to Access points, 5-8

FCC RF Exposure Requirements:

This device complies with the FCC RF exposure requirements.